



Кондиционирование воздуха

Технических данных

Тепловой насос VRV IV



EEDRU13-200

RXYQ-T

СОДЕРЖАНИЕ

RXYQ-T

1	Характеристики	2
2	Технические характеристики	5
	Технические параметры	5
	Электрические параметры	6
	Технические параметры	7
	Технические параметры	8
	Электрические параметры	9
	Электрические параметры	10
3	Опции	12
	Опции	12
4	Таблица сочетания	13
	Таблица сочетания	13
5	Таблицы производительности	15
	Таблицы холодопроизводительности	15
	Таблицы теплопроизводительностей	63
	Поправочный коэффициент для общей теплопроизводительности	
	111	
	Поправочный коэффициент для производительности	112
6	Размерные чертежи	124
	Размерные чертежи	124
7	Центр тяжести	125
	Центр тяжести	125
8	Схемы трубопроводов	126
	Схемы трубопроводов	126
9	Монтажные схемы	128
	Монтажные схемы - Три фазы	128
10	Схемы внешних соединений	132
	Схемы внешних соединений	132
11	Данные об уровне шума	134
	Спектр звуковой мощности	134
	Спектр звукового давления	136
12	Установка	138
	Способ монтажа	138
	Крепление и фундаменты блоков	139
	Выбор труб с хладагентом	140
13	Рабочий диапазон	146
	Рабочий диапазон	146

1 Характеристики

- Настройте систему VRV для достижения более высокой эффективности и обеспечения сезонного комфорта, используя переменную температуру хладагента
- Программное обеспечение «Конфигуратор VRV» позволяет быстро и точно определить требуемую конфигурацию оборудования, выполнить необходимые настройки и осуществить ввод в эксплуатацию
- Точное управление температурой, подача свежего воздуха, воздушные завесы Biddle и ГВС в одной системе, для которой требуется только одна точка контакта
- Широкий модельный ряд внутренних блоков: возможность сочетания блоков VRV со стильными внутренними блоками (Daikin Emura, Nexura...)
- Использование переменной температуры хладагента позволяет повысить сезонную эффективность не менее чем на 25% по сравнению с предыдущей серией

1

1 Характеристики



1 Характеристики



1

2 Технические характеристики

2-1 Технические параметры				RXYQ8T	RXYQ10T	RXYQ12T	RXYQ14T	RXYQ16T	RXYQ18T	RXYQ20T	
Диапазон производительностей		л.с.		8	10	12	14	16	18	20	
Холодопроизводительность	Ном.	кВт		22,4 (1)	28,0 (1)	33,5 (1)	40,0 (1)	45,0 (1)	50,0 (1)	56,0 (1)	
Теплопроизводительность	Ном.	кВт		25,0 (2)	31,5 (2)	37,5 (2)	45,0 (2)	50,0 (2)	56,0 (2)	63,0 (2)	
Регулирование производительности	Способ		С инверторным управлением								
Входная мощность - 50 Гц	Охлаждение	Ном.	кВт	5,21 (1)	7,29 (1)	8,98 (1)	11,0 (1)	13,0 (1)	14,7 (1)	18,5 (1)	
	Нагрев	Ном.	кВт	5,5 (2)	7,38 (2)	9,10 (2)	11,2 (2)	12,8 (2)	14,4 (2)	17,0 (2)	
EER				4,30 (1)	3,84 (1)	3,73 (1)	3,64 (1)	3,46 (1)	3,40 (1)	3,03 (1)	
ESEER				6,37 (24) / 7,53 (25)	5,67 (24) / 7,20 (25)	5,50 (24) / 6,96 (25)	5,31 (24) / 6,83 (25)	5,05 (24) / 6,50 (25)	4,97 (24) / 6,38 (25)	4,42 (24) / 5,67 (25)	
COP				4,54 (2)	4,27 (2)	4,12 (2)	4,02 (2)	3,91 (2)	3,89 (2)	3,71 (2)	
Максимальное количество подсоединяемых внутренних блоков				64 (3)							
Индекс производительности подсоединяемых внутренних блоков	Мин.			100	125	150	175	200	225	250	
	Ном.			200	250	300	350	400	450	500	
	Макс.			260	325	390	455	520	585	650	
Корпус	Цвет		Белый Daikin								
	Материал		Окрашенная оцинкованная стальная пластина								
Размеры	Блок	Высота	мм	1.685							
		Ширина	мм	930			1.240				
		Глубина	мм	765							
	Упакованный блок	Высота	мм	1.820							
		Ширина	мм	1.000			1.310				
		Глубина	мм	835							
Вес	Блок	кг	-								
Упаковка	Материал		Картон_								
	Вес	кг	2,00								
Упаковка 2	Материал		Дерево								
	Вес	кг	15,50			16,50					
Упаковка 3	Материал		Пластик								
	Вес	кг	0,50								
Теплообменник	Тип		Теплообменник с поперечным соединением оребрения								
	Ребро	Обработка	Антикоррозионная обработка								
Вентилятор	Тип		Осевой вентилятор								
	Количество		1				2				
	Расход воздуха	Охлаждение	Ном.	м³/мин	162	175	185	223	260	251	261
	Внешнее статическое давление	Макс.		Па	78						
	Направление подачи		Вертикальн.								
Двигатель вентилятора	Количество		1				2				
	Модель		Бесщеточный двигатель постоянного тока								
	Выход		W		750						
Уровень акустической мощности	Охлаждение	Ном.	дБА	78	79	81		86		88	
	Уровень звукового давления	Ном.	дБА	58			61		64	65	66
Компрессор	Количество_		1				2				
	Модель		Инвертор								
	Тип		Герметичный спиральный компрессор								
	Картерный нагреватель		W		33						
Рабочий диапазон	Охлаждение	Мин.-Макс.	°CDB	-5~43							
	Нагрев	Мин.-Макс.	°CWB	-20~15,5							
Хладагент	Тип		R-410A								
	Заправка		кг	5,9	6	6,3	10,3	10,4	11,7	11,8	

2 Технические характеристики

2-1 Технические параметры				RXYQ8T	RXYQ10T	RXYQ12T	RXYQ14T	RXYQ16T	RXYQ18T	RXYQ20T	
Масло хладагента	Тип			Синтетическое (эфирное) масло							
	Объем заправки			л	1,0	1,2	1,4	2,4	3,3		
Piping connections	Жидкость	Тип		Соединение пайкой							
		НД	мм	9,52			12,7		15,9		
	Газ	Тип		Соединение пайкой							
		НД	мм	19,1	22,2	28,6					
	Heat insulation			Трубопроводы для жидкости и газа							
	Длина трубы	Макс.	НБ - ВБ	м	165 (7)						
		Макс.	После отвления	м	90 (7)						
	Общая длина трубопроводов	Система	Фактическая	м	1.000 (7)						
	перепад уровня	НБ - ВБ	Наружный блок в наивысшем положении	м	90 (7)						
				Внутренний блок в наивысшем положении	м	90 (7)					
IU - IU		Макс.	м	30 (7)							
Способ разморозки				Реверсивный цикл							
Защитные устройства	Оборудование	01	Реле высокого давления								
		02	Устройство защиты от перегрузки привода вентилятора								
		03	Защита от перегрузки инвертора								
		04	Плавкий предохранитель платы								
PED	Категория			Категория II							

Стандартные аксессуары : Соединительные трубопроводы;

Стандартные аксессуары : Руководство по установке и эксплуатации;

2-2 Электрические параметры				RXYQ8T	RXYQ10T	RXYQ12T	RXYQ14T	RXYQ16T	RXYQ18T	RXYQ20T
Электропитание	Наименование			Y1						
	Фаза			3N~						
	Частота		Гц	50						
	Напряжение		V	380-415						
Voltage range	Min.		%	-10						
	Max.		%	10						
Ток	Номинальный рабочий ток - 50 Гц	Охлаждение	A	7,2 (9)	10,2 (9)	12,7 (9)	15,4 (9)	18,0 (9)	20,8 (9)	26,9 (9)
Ток - 50 Гц	Минимальное значение Ssc		кВА	1.216	1.021	482	2.600	2.470	582	594
	Мин. ток цепи (MCA)		A	16,1	22,0	24,0	27,0	31,0	35,0	39,0
	Макс. ток предохранителя (MFA)		A	20	25	32	40	50		
	Полный максимальный ток (TOCA)		A	17,3	24,6		35,4		42,7	
Соединительная проводка - 50 Гц	Для электропитания		Quantity	5G						
	Для подсоединения с внутр. бл.		Количество	2						
			Примечание	F1,F2						
Подключение электропитания				Внутренний и наружный блок						

2 Технические характеристики

Примечания

- (1) Охлаждение: темп. в помещении: 27°CDB, 19°CWB; темп. наружного воздуха 35°CDB; эквивалентная длина трубопроводов: 5 м (горизонт.), перепад уровня: 0 м
- (2) Нагрев: темп. в помещении: 20°CDB; темп. наружного воздуха 7°CDB, 6°CWB; эквивалентная длина труб с хладагентом: 5м; перепад уровня: 0 м
- (3) Фактическое количество подключаемых внутренних блоков зависит от типа внутреннего блока (внутренний VRV, Hydrobox (гидроблок), внутренний RA и т.д.) и ограничения по отношению подключений для системы (50% \leq CR \leq 130%)
- (4) Для более подробных данных о рабочем диапазоне см. чертёж TW
- (5) Диапазон напряжения: блоки могут использоваться с электрическими системами, где напряжение, подаваемое на клемму блока, находится в пределах указанного диапазона.
- (6) Максимально допустимое изменение диапазона напряжений между фазами составляет 2%.
- (7) См. раздел выбора трубопровода хладагента или руководство по установке
- (8) Более подробная информация о стандартных принадлежностях приведена в руководстве по монтажу/эксплуатации
- (9) RLA основан на следующих условиях: темп. в помещении: 27°CDB, 19°CWB; темп. наружного воздуха 35°CDB
- (10) MSC означает максимальный ток при пуске компрессора. VRV IV используется только инверторные компрессоры. Пусковой ток всегда \leq макс. рабочий ток.
- (11) Сечение проводника следует выбирать по значению MCA. MCA можно рассматривать как максимальный рабочий ток.
- (12) MFA используется для выбора автоматического выключателя и выключатель цепи при замыкании на землю (автоматический выключатель утечек на землю)
- (13) TOCA означает полное значение каждой группы ОС.
- (14) FLA означает номинальный рабочий ток вентилятора
- (15) В соответствии со стандартом EN/IEC 61000-3-11 и соответственно EN/IEC 61000-3-12, может понадобиться консультация у оператора распределительной сети, чтобы убедиться, что оборудование подсоединено только к блоку питания со значением $Z_{sys} \leq Z_{max}$, соответственно $S_{sc} \geq$ минимальное значение S_{sc} .
- (16) Европейский/международный технический стандарт задает ограничения на скачкообразное изменение напряжения, колебания и пульсацию напряжения в общедоступной сети низкого напряжения оборудования с номинальным током $\leq 75A$.
- (17) Европейский/международный технический стандарт, задающий пределы гармонического тока, производимого оборудованием, подсоединенным к общедоступной сети низкого напряжения с потребляемым током $> 16A$ и $\leq 75A$ на фазу
- (18) мощность короткого замыкания
- (19) Сопротивление системы
- (20) Данные сочетаний мультиблоков (22 ~ 54 HP) соответствуют стандартным сочетаниям мультиблоков, как указано в 3D079534
- (21) Уровень звуковой мощности является абсолютной величиной, производимой источником звука.
- (22) Это относительная величина, которая зависит от указанного расстояния и акустики среды. Более подробно см. чертежи с описанием уровней шума.
- (23) Величина уровня звука измеряется в безэховом помещении.
- (24) Стандартное значение ESEER соответствует нормальной работе теплового насоса VRV4, без учета расширенных функций экономии энергии
- (25) Автоматическое значение SEER соответствует нормальной работе теплового насоса VRV4, с учетом расширенных функций экономии энергии (управление переменной температурой хладагента)
- (26) Охлаждение: темп. в помещении: 27°CDB, 19,0°CWB; темп. наружного воздуха 35°CDB; эквивалентная длина трубопроводов: 5м; перепад уровня: 0 м

2-3 Технические параметры			RXYQ22 Т	RXYQ24 Т	RXYQ26 Т	RXYQ28 Т	RXYQ30 Т	RXYQ32 Т	RXYQ34 Т	RXYQ36 Т	RXYQ38 Т	RXYQ40 Т	
Система	Outdoor unit module 1		RXYQ1 0T7Y1B	RXYQ8 T7Y1B	RXYQ12T7Y1B			RXYQ16T7Y1B			RXYQ8 T7Y1B	RXYQ1 0T7Y1B	
	Outdoor unit module 2		RXYQ1 2T7Y1B	RXYQ1 6T7Y1B	RXYQ1 4T7Y1B	RXYQ1 6T7Y1B	RXYQ1 8T7Y1B	RXYQ1 6T7Y1B	RXYQ1 8T7Y1B	RXYQ2 0T7Y1B	RXYQ1 0T7Y1B	RXYQ1 2T7Y1B	
	Outdoor unit module 3											RXYQ2 0T7Y1B	RXYQ1 8T7Y1B
Диапазон производительностей			л.с.	22	24	26	28	30	32	34	36	38	40
Холодопроизводительность	Ном.	кВт	61,5 (1)	67,4 (1)	73,5 (1)	78,5 (1)	83,5 (1)	90,0 (1)	95,0 (1)	101,0 (1)	106,0 (1)	112,0 (1)	
Теплопроизводительность	Ном.	кВт	69,0 (2)	75,0 (2)	82,5 (2)	87,5 (2)	93,5 (2)	100,0 (2)	106,0 (2)	113,0 (2)	120,0 (2)	125,0 (2)	
Входная мощность - 50 Гц	Охлаждение	Ном.	кВт	16,3 (1)	18,2 (1)	20,0 (1)	22,0 (1)	23,7 (1)	26,0 (1)	27,7 (1)	31,5 (1)	31,0 (1)	
	Нагрев	Ном.	кВт	16,5 (2)	18,3 (2)	20,3 (2)	21,9 (2)	23,5 (2)	25,6 (2)	27,2 (2)	29,8 (2)	29,9 (2)	30,9 (2)
EER				3,77 (1)	3,70 (1)	3,68 (1)	3,57 (1)	3,52 (1)	3,46 (1)	3,43 (1)	3,21 (1)	3,42 (1)	3,61 (1)
ESEER				5,58 (17) / 7,07 (18)	5,42 (17) / 6,81 (18)	5,39 (17) / 6,89 (18)	5,23 (17) / 6,69 (18)	5,17 (17) / 6,60 (18)	5,05 (17) / 6,50 (18)	5,01 (17) / 6,44 (18)	4,68 (17) / 6,02 (18)	5,03 (17) / 6,36 (18)	5,29 (17) / 6,74 (18)
COP				4,18 (2)	4,10 (2)	4,06 (2)	4,00 (2)	3,98 (2)	3,91 (2)	3,90 (2)	3,79 (2)	4,01 (2)	4,05 (2)
Максимальное количество подсоединяемых внутренних блоков			64 (3)										
Индекс производительности подсоединяемых внутренних блоков	Мин.		275	300	325	350	375	400	425	450	475	500	
	Ном.		550	600	650	700	750	800	850	900	950	1.000	
	Макс.		715	780	845	910	975	1.040	1.105	1.170	1.235	1.300	

2 Технические характеристики

2

2-3 Технические параметры				RXYQ22 Т	RXYQ24 Т	RXYQ26 Т	RXYQ28 Т	RXYQ30 Т	RXYQ32 Т	RXYQ34 Т	RXYQ36 Т	RXYQ38 Т	RXYQ40 Т
Piping connections	Жидкость	НД		мм		15,9		19,1					
	Газ	НД		мм		28,6		34,9				41,3	
	Длина трубы	Макс.	НБ - ВБ		м		165 (10)						
		Макс.	После отвления		м		90 (10)						
	Общая длина трубопроводов	Система	Фактическая		м		1.000 (10)						
	перепад уровня	НБ - ВБ	Наружный блок в наивысшем положении		м		90 (10)						
			Внутренний блок в наивысшем положении		м		90 (10)						
IU - IU		Макс.		м		30 (10)							
PED	Категория			Категория II									

Стандартные аксессуары : Соединительные трубопроводы;

Стандартные аксессуары : Руководство по установке и эксплуатации;

2-4 Технические параметры				RXYQ42T	RXYQ44T	RXYQ46T	RXYQ48T	RXYQ50T	RXYQ52T	RXYQ54T	
Система	Outdoor unit module 1			RXYQ10T7 Y1B	RXYQ12T7 Y1B	RXYQ14T7 Y1B	RXYQ16T7Y1B			RXYQ18T7 Y1B	
	Outdoor unit module 2			RXYQ16T7Y1B				RXYQ18T7Y1B			
	Outdoor unit module 3			RXYQ16T7Y1B				RXYQ18T7Y1B			
Диапазон производительностей				л.с.	42	44	46	48	50	52	54
Холодопроизводительность	Ном.	кВт		118,0 (1)	124,0 (1)	130,0 (1)	135,0 (1)	140,0 (1)	145,0 (1)	150,0 (1)	
Теплопроизводительность	Ном.	кВт		132,0 (2)	138,0 (2)	145,0 (2)	150,0 (2)	156,0 (2)	162,0 (2)	168,0 (2)	
Входная мощность - 50 Гц	Охлаждение	Ном.	кВт	33,3 (1)	35,0 (1)	37,0 (1)	39,0 (1)	40,7 (1)	42,4 (1)	44,1 (1)	
	Нагрев	Ном.	кВт	33,0 (2)	34,7 (2)	36,8 (2)	38,4 (2)	40,0 (2)	41,6 (2)	43,2 (2)	
EER				3,54 (1)		3,51 (1)	3,46 (1)	3,44 (1)	3,42 (1)	3,40 (1)	
ESEER				5,19 (17) / 6,65 (18)	5,17 (17) / 6,62 (18)	5,13 (17) / 6,60 (18)	5,05 (17) / 6,50 (18)	5,02 (17) / 6,46 (18)	4,99 (17) / 6,42 (18)	4,97 (17) / 6,38 (18)	
COP				4,00 (2)	3,98 (2)	3,94 (2)	3,91 (2)	3,90 (2)	3,89 (2)		
Максимальное количество подсоединяемых внутренних блоков				64 (3)							
Индекс производительности подсоединяемых внутренних блоков	Мин.			525	550	575	600	625	650	675	
	Ном.			1.050	1.100	1.150	1.200	1.250	1.300	1.350	
	Макс.			1.365	1.430	1.495	1.560	1.625	1.690	1.755	

2 Технические характеристики

2-4 Технические параметры				RXYQ42T	RXYQ44T	RXYQ46T	RXYQ48T	RXYQ50T	RXYQ52T	RXYQ54T	
Piping connections	Жидкость	НД						19,1			
	Газ	НД						41,3			
	Длина трубы	Макс.	НБ - ВБ		м				165 (10)		
		Макс.	После ответвления		м				90 (10)		
	Общая длина трубопроводов	Система	Фактическая		м				1.000 (10)		
	перепад уровня	НБ - ВБ	Наружный блок в наивысшем положении		м				90 (10)		
Внутренний блок в наивысшем положении			м				90 (10)				
IU - IU		Макс.		м				30 (10)			
PED	Категория			Категория II							

Стандартные аксессуары: Соединительные трубопроводы;

Стандартные аксессуары: Руководство по установке и эксплуатации;

2-5 Электрические параметры				RXYQ22T	RXYQ24T	RXYQ26T	RXYQ28T	RXYQ30T	RXYQ32T	RXYQ34T	RXYQ36T	RXYQ38T	RXYQ40T
Ток	Номинальный рабочий ток - 50 Гц	Охлаждение	A	22,9 (4)	25,2 (4)	28,1 (4)	30,7 (4)	33,5 (4)	36,0 (4)	38,8 (4)	44,9 (4)	44,3 (4)	43,7 (4)
Ток - 50 Гц	Минимальное значение Ssc		кВА	1.503	3.686	3.082	2.952	1.064	4.940	3.052	3.064	2.831	2.085
	Мин. ток цепи (MCA)		A	46,0		51,0	55,0	59,0	62,0	66,0	70,0	76,0	81,0
	Макс. ток предохранителя (MFA)		A	63				80				100	
Соединительная проводка - 50 Гц	Для электропитания	Quantity		5G									
	Для подсоединения с внутр. бл.	Количество		2									
		Примечание		F1,F2									
Подключение электропитания				Внутренний и наружный блок									

Примечания

- (1) Охлаждение: темп. в помещении: 27°CDB, 19°CWB; темп. наружного воздуха 35°CDB; эквивалентная длина трубопроводов: 5 м (горизонт.), перепад уровня: 0 м
- (2) Нагрев: темп. в помещении: 20°CDB; темп. наружного воздуха 7°CDB, 6°CWB; эквивалентная длина труб с хладагентом: 5м; перепад уровня: 0 м
- (3) Фактическое количество подключаемых внутренних блоков зависит от типа внутреннего блока (внутренний VRV, Hydrobox (гидроблок), внутренний RA и т.д.) и ограничения по отношению подключений для системы (50% ≤ CR ≤ 130%)
- (4) Для более подробных данных о рабочем диапазоне см. чертеж TW
- (5) Диапазон напряжения: блоки могут использоваться с электрическими системами, где напряжение, подаваемое на клемму блока, находится в пределах указанного диапазона.
- (6) Максимально допустимое изменение диапазона напряжений между фазами составляет 2%.
- (7) См. раздел выбора трубопровода хладагента или руководство по установке
- (8) Более подробная информация о стандартных принадлежностях приведена в руководстве по монтажу/эксплуатации
- (9) RLA основан на следующих условиях: темп. в помещении: 27°CDB, 19°CWB; темп. наружного воздуха 35°CDB
- (10) MSC означает максимальный ток при пуске компрессора. VRV IV используется только инверторные компрессоры. Пусковой ток всегда ≤ макс. рабочий ток.
- (11) Сечение проводника следует выбирать по значению MCA. MCA можно рассматривать как максимальный рабочий ток.
- (12) MFA используется для выбора автоматического выключателя и выключатель цепи при замыкании на землю (автоматический выключатель утечек на землю)
- (13) TOCA означает полное значение каждой группы ОС.
- (14) FLA означает номинальный рабочий ток вентилятора
- (15) В соответствии со стандартом EN/IEC 61000-3-11 и соответственно EN/IEC 61000-3-12, может понадобиться консультация у оператора распределительной сети, чтобы убедиться, что оборудование подсоединено только к блоку питания со значением Zsys ≤ Zmax, соответственно Ssc ≥ минимальное значение Ssc.
- (16) Европейский/международный технический стандарт задает ограничения на скачкообразное изменение напряжения, колебания и пульсацию напряжения в

2 Технические характеристики

общедоступной сети низкого напряжения оборудования с номинальным током ≤ 75А.

(17) Европейский/международный технический стандарт, задающий пределы гармонического тока, производимого оборудованием, подсоединенным к общедоступной сети низкого напряжения с потребляемым током > 16А и ≤ 75А на фазу

(18) мощность короткого замыкания

(19) Сопротивление системы

(20) Данные сочетаний мультиблоков (22 ~ 54 HP) соответствуют стандартным сочетаниям мультиблоков, как указано в 3D079534

(21) Уровень звуковой мощности является абсолютной величиной, производимой источником звука.

(22) Это относительная величина, которая зависит от указанного расстояния и акустики среды. Более подробно см. чертежи с описанием уровней шума.

(23) Величина уровня звука измеряется в беззвонном помещении.

(24) Стандартное значение ESEER соответствует нормальной работе теплового насоса VRV4, без учета расширенных функций экономии энергии

(25) Автоматическое значение SEER соответствует нормальной работе теплового насоса VRV4, с учетом расширенных функций экономии энергии (управление переменной температурой хладагента)

(26) Охлаждение: темп. в помещении: 27°CDB, 19,0°CWB; темп. наружного воздуха 35°CDB; эквивалентная длина трубопроводов: 5м; перепад уровня: 0 м

2-6 Электрические параметры			RXYQ42T	RXYQ44T	RXYQ46T	RXYQ48T	RXYQ50T	RXYQ52T	RXYQ54T	
Ток	Номинальный рабочий ток - 50 Гц	Охлаждение	A	46,2 (4)	48,7 (4)	51,4 (4)	54,0 (4)	56,8 (4)	59,6 (4)	62,4 (4)
Ток - 50 Гц	Минимальное значение Ssc		кВА	5,961	5,422	7,540	7,410	5,522	3,634	1,746
	Мин. ток цепи (MCA)		A	84,0	86,0	89,0	93,0	97,0	101,0	105,0
	Макс. ток предохранителя (MFA)		A	100			125			
Соединительная проводка - 50 Гц	Для электропитания	Quantity	5G							
	Для подсоединения с внутр. бл.	Количество	2							
		Примечание	F1,F2							
Подключение электропитания			Внутренний и наружный блок							

Примечания

(1) Охлаждение: темп. в помещении: 27°CDB, 19°CWB; темп. наружного воздуха 35°CDB; эквивалентная длина трубопроводов: 5 м (горизонт.), перепад уровня: 0 м

(2) Нагрев: темп. в помещении: 20°CDB; темп. наружного воздуха 7°CDB, 6°CWB; эквивалентная длина труб с хладагентом: 5м; перепад уровня: 0 м

(3) Фактическое количество подключаемых внутренних блоков зависит от типа внутреннего блока (внутренний VRV, Hydrobox (гидроблок), внутренний RA и т.д.) и ограничения по отношению подключений для системы (50% <= CR <= 130%)

(4) Для более подробных данных о рабочем диапазоне см. чертеж TW

(5) Диапазон напряжения: блоки могут использоваться с электрическими системами, где напряжение, подаваемое на клемму блока, находится в пределах указанного диапазона.

(6) Максимально допустимое изменение диапазона напряжений между фазами составляет 2%.

(7) См. раздел выбора трубопровода хладагента или руководство по установке

(8) Более подробная информация о стандартных принадлежностях приведена в руководстве по монтажу/эксплуатации

(9) RLA основан на следующих условиях: темп. в помещении: 27°CDB, 19°CWB; темп. наружного воздуха 35°CDB

(10) MSC означает максимальный ток при пуске компрессора. VRV IV используется только инверторные компрессоры. Пусковой ток всегда ≤ макс. рабочий ток.

(11) Сечение проводника следует выбирать по значению MCA. MCA можно рассматривать как максимальный рабочий ток.

(12) MFA используется для выбора автоматического выключателя и выключатель цепи при замыкании на землю (автоматический выключатель утечек на землю)

(13) TOCA означает полное значение каждой группы ОС.

(14) FLA означает номинальный рабочий ток вентилятора

(15) В соответствии со стандартом EN/IEC 61000-3-11 и соответственно EN/IEC 61000-3-12, может потребоваться консультация оператора распределительной сети, чтобы убедиться, что оборудование подсоединено только к блоку питания со значением Zsys ≤ Zmax, соответственно Ssc ≥ минимальное значение Ssc.

(16) Европейский/международный технический стандарт задает ограничения на скачкообразное изменение напряжения, колебания и пульсацию напряжения в общедоступной сети низкого напряжения оборудования с номинальным током ≤ 75А.

(17) Европейский/международный технический стандарт, задающий пределы гармонического тока, производимого оборудованием, подсоединенным к общедоступной сети низкого напряжения с потребляемым током > 16А и ≤ 75А на фазу

(18) мощность короткого замыкания

(19) Сопротивление системы

(20) Данные сочетаний мультиблоков (22 ~ 54 HP) соответствуют стандартным сочетаниям мультиблоков, как указано в 3D079534

(21) Уровень звуковой мощности является абсолютной величиной, производимой источником звука.

(22) Это относительная величина, которая зависит от указанного расстояния и акустики среды. Более подробно см. чертежи с описанием уровней шума.

(23) Величина уровня звука измеряется в беззвонном помещении.

(24) Стандартное значение ESEER соответствует нормальной работе теплового насоса VRV4, без учета расширенных функций экономии энергии

2 Технические характеристики

(25) Автоматическое значение SEER соответствует нормальной работе теплового насоса VRV4, с учетом расширенных функций экономии энергии (управление переменной температурой хладагента)

(26) Охлаждение: темп. в помещении: 27°CDB, 19,0°CWB; темп. наружного воздуха 35°CDB; эквивалентная длина трубопроводов: 5м; перепад уровня: 0 м

3 Опции

3 - 1 Опции

3

RXYQ-T					
№	Поз.	RXYQ8T	RXYQ10-12T	RXYQ14-18T	RXYQ20-54T
1a	Переключатель охлаждение/отопление (переключатель)	KRC19-26A			
1b	Переключатель охлаждение/отопление (PCB)	BRP2A81			
2	Фиксирующий ящик	KIB111A			
3	Подогреватель Refnet	KHRQ22M29H			
		---	KHRQ22M64H		---
		---	---	---	KHRQ22M75H
4	Разветвитель Refnet стык	KHRQ22M20T			
		KHRQ22M29T9			
		KHRQ22M64T			
		---	---	---	KHRQ22M75T
5	Комплект для мультиподключения наружных блоков (см. примечание 3)	---	---	---	BHFQ22P1007
6	Комплект для мультиподключения наружных блоков (см. примечание 3)	---	---	---	BHFQ22P1517
7	Конфигуратор VRV	ЕКРССАВ1			
8	Комплект цифрового манометра	BHGP26A1 (см. примечание 2)			

ПРИМЕЧАНИЯ

1. Все опции в наборах инструментов.
2. В случае мультиустановки наружных блоков требуется лишь 1 опция на установку.
3. Только для мультиблоков
4. 1a и 1b необходимы для работы переключателя охлаждения/отопления в системе теплового насоса VRV4

3D079531B

4 Таблица сочетания

4 - 1 Таблица сочетания

RXYQ-T		См. Примечания относительно типа базовой модели						
		8 л.с.	10 л.с.	12НР	14НР	16НР	18НР	20НР
Тепловой насос	RXYQ8*	1						
	RXYQ10*		1					
	RXYQ12*			1				
	RXYQ14*				1			
	RXYQ16*					1		
	RXYQ18*						1	
	RXYQ20*							1
Мультикомбинированное с 2 наружными блоками	RXYQ22*		1	1				
	RXYQ24*	1				1		
	RXYQ26*			1	1			
	RXYQ28*			1		1		
	RXYQ30*			1			1	
	RXYQ32*					2		
	RXYQ34*					1	1	
	RXYQ36*					1		1
Мультикомбинированное с 3 наружными блоками	RXYQ38*	1	1					1
	RXYQ40*		1	1			1	
	RXYQ42*		1			2		
	RXYQ44*			1		2		
	RXYQ46*				1	2		
	RXYQ48*					3		
	RXYQ50*					2	1	
	RXYQ52*					1	2	
	RXYQ54*						3	

ПРИМЕЧАНИЯ

RXYQ8-20* = модель для отдельной установки и не непрерывным отоплением

RXYQ22-54* = модель для мультиустановки и не непрерывным отоплением

1. Можно выбрать отдельный блок. Модель RYYQ* (непрерывное отопление) и модель RXYQ* (не непрерывное отопление)
2. Мультикомбинированное для не непрерывного отопления состоят из модулей RXYQ8-20. Пример: RXYQ36* = RXYQ16* + RXYQ20*
3. Мультикомбинированное для непрерывного отопления состоят из модулей RYMQ8-20. Пример: RYYQ36* = RYMQ16* + RYMQ20*
→ мультимодели RYMQ* не могут использоваться в качестве самостоятельных единиц (RYMQ8-20НР)
4. Мультикомбинированное не должны включать модели RYYQ8-20
5. Мультикомбинированное для непрерывного отопления RYYQ* не должны содержать модели RXYQ*
6. Мультикомбинированное для не непрерывного отопления RXYQ* не должны содержать модели RYMQ*

3D079534A

RXYQ-T

Сочетание внутренних блоков	Внутренний VRV*	Внутренний RA	Hydrobox (Гидроблок)	AHU (включая Biddle)
Внутренний VRV*	0	0	0	0
Внутренний RA	0	0	x	x
Hydrobox (Гидроблок)	0	x	0 ₁	x
AHU (включая Biddle)	0	x	x	0 ₂

0: Разрешено
x: Запрещено

ПРИМЕЧАНИЯ

1) Внутренний VRV*

- Внутренний блок VRV может сочетаться только с одним из допустимых внутренних блоков.

пример

Разрешено: (VRV + Hydro) **ИЛИ** (VRV + RA) **ИЛИ** (VRV + AHU)

Не разрешено: [VRV + (RA и (Hydro или AHU))] **ИЛИ** [VRV + (Hydro и (RA или AHU))]

2) 0₁

- Подключение только гидроблоков без внутреннего блока VRV к тепловому насосу VRV IV не допускается

- См. также ограничения по отношению подключений (CR) (3D079540)

- Подключение только гидроблока: см. предлагаемые Daikin Altherma решения

- Совместимыми являются лишь гидроблоки серии HXY*

- Использование гидроблока HXHD* Hydrobox не допускается

3) 0₂: Возможно только Z-управление

4) Не допускается сочетание AHU с гидроблоком

5) В случае подключения только 1 AHU. Доступна функциональность ERQ (X-, Y- и Z-управление)

3D079543A_1

4 Таблица сочетания

4 - 1 Таблица сочетания

4

RXYQ-T

Сочетание внутреннего/наружного	RXYQ* (один п-CH)	RXYQ* (мульти п-CH)
Внутренний VRV*	0	0
Внутренний RA	x	x
Гидроблок (HXY*)	x	x
AHU (включая Biddle)	x	x

0: Разрешено

x: Запрещено

ПРИМЕЧАНИЯ

1) 0₁

По запросу с использованием процедуры SPN

3D079543A_2

5 Таблицы производительности

5 - 1 Таблицы холодопроизводительности

RXYQ8T															
Indoor air temp. °CWB															
Combination(%) (Capacity index)	Outdoor air temp. (°CDB)	14.0		16.0		18.0		19.0		20.0		22.0		24.0	
		TC	PI	TC	PI	TC	PI	TC	PI	TC	PI	TC	PI	TC	PI
		KW		KW		KW		KW		KW		KW		KW	
130% 29.12 kW	10	17.9	2.22	22.4	2.82	26.9	3.45	28.2	3.57	28.6	3.48	29.5	3.31	30.3	3.13
	12	17.9	2.26	22.4	2.87	26.9	3.51	27.8	3.55	28.3	3.46	29.1	3.28	29.9	3.29
	14	17.9	2.30	22.4	2.92	26.9	3.58	27.5	3.53	27.9	3.44	28.7	3.44	29.6	3.47
	16	17.9	2.34	22.4	2.98	26.7	3.60	27.1	3.56	27.5	3.58	28.4	3.62	29.2	3.66
	18	17.9	2.38	22.4	3.03	26.3	3.72	26.8	3.74	27.2	3.76	28.0	3.81	28.9	3.85
	20	17.9	2.42	22.4	3.18	26.0	3.90	26.4	3.92	26.8	3.95	27.6	3.99	28.5	4.04
	21	17.9	2.45	22.4	3.29	25.8	3.99	26.2	4.02	26.6	4.04	27.5	4.09	28.3	4.13
	23	17.9	2.60	22.4	3.53	25.4	4.17	25.8	4.20	26.3	4.22	27.1	4.27	27.9	4.33
	25	17.9	2.78	22.4	3.77	25.1	4.36	25.5	4.38	25.9	4.41	26.7	4.46	27.6	4.52
	27	17.9	2.96	22.4	4.03	24.7	4.54	25.1	4.57	25.5	4.60	26.4	4.65	27.2	4.71
	29	17.9	3.15	22.4	4.30	24.3	4.72	24.8	4.75	25.2	4.78	26.0	4.84	26.8	4.90
	31	17.9	3.36	22.4	4.59	24.0	4.91	24.4	4.94	24.8	4.97	25.6	5.04	26.5	5.10
	33	17.9	3.57	22.4	4.89	23.6	5.09	24.0	5.13	24.4	5.16	25.3	5.23	26.1	5.30
	35	17.9	3.80	22.4	5.21	23.2	5.28	23.7	5.32	24.1	5.35	24.9	5.42	25.8	5.49
	37	17.9	4.04	22.0	5.39	22.9	5.47	23.3	5.51	23.7	5.54	24.6	5.62	25.4	5.69
	39	17.9	4.29	21.7	5.58	22.5	5.66	22.9	5.70	23.3	5.74	24.2	5.81	25.0	5.89
120% 26.88 kW	10	16.5	2.04	20.7	2.58	24.8	3.16	26.9	3.45	28.2	3.57	29.0	3.41	29.7	3.25
	12	16.5	2.08	20.7	2.63	24.8	3.21	26.9	3.51	27.8	3.55	28.6	3.39	29.4	3.26
	14	16.5	2.11	20.7	2.68	24.8	3.27	26.9	3.58	27.5	3.54	28.2	3.41	29.0	3.45
	16	16.5	2.15	20.7	2.73	24.8	3.33	26.7	3.60	27.1	3.56	27.9	3.60	28.6	3.63
	18	16.5	2.19	20.7	2.78	24.8	3.43	26.3	3.72	26.7	3.74	27.5	3.78	28.3	3.82
	20	16.5	2.23	20.7	2.85	24.8	3.68	26.0	3.90	26.4	3.92	27.1	3.97	27.9	4.01
	21	16.5	2.25	20.7	2.95	24.8	3.81	25.8	3.99	26.2	4.01	26.9	4.06	27.7	4.10
	23	16.5	2.35	20.7	3.15	24.8	4.09	25.4	4.17	25.8	4.20	26.6	4.24	27.4	4.29
	25	16.5	2.50	20.7	3.37	24.7	4.33	25.1	4.36	25.4	4.38	26.2	4.43	27.0	4.48
	27	16.5	2.67	20.7	3.60	24.3	4.51	24.7	4.54	25.1	4.57	25.9	4.62	26.6	4.67
	29	16.5	2.84	20.7	3.84	23.9	4.70	24.3	4.72	24.7	4.75	25.5	4.81	26.3	4.86
	31	16.5	3.02	20.7	4.09	23.6	4.88	24.0	4.91	24.4	4.94	25.1	5.00	25.9	5.06
	33	16.5	3.21	20.7	4.36	23.2	5.06	23.6	5.09	24.0	5.13	24.8	5.19	25.5	5.25
	35	16.5	3.41	20.7	4.64	22.9	5.25	23.2	5.28	23.6	5.31	24.4	5.38	25.2	5.44
	37	16.5	3.62	20.7	4.94	22.5	5.43	22.9	5.47	23.3	5.50	24.0	5.57	24.8	5.64
	39	16.5	3.84	20.7	5.25	22.1	5.62	22.5	5.66	22.9	5.69	23.7	5.77	24.4	5.84
110% 24.64 kW	10	15.2	1.87	19.0	2.35	22.7	2.87	24.6	3.13	26.5	3.40	28.4	3.52	29.1	3.37
	12	15.2	1.90	19.0	2.39	22.7	2.92	24.6	3.19	26.5	3.46	28.1	3.50	28.8	3.35
	14	15.2	1.93	19.0	2.44	22.7	2.97	24.6	3.25	26.5	3.52	27.7	3.48	28.4	3.42
	16	15.2	1.96	19.0	2.48	22.7	3.03	24.6	3.31	26.5	3.59	27.3	3.57	28.1	3.61
	18	15.2	2.00	19.0	2.53	22.7	3.08	24.6	3.39	26.3	3.72	27.0	3.75	27.7	3.79
	20	15.2	2.03	19.0	2.57	22.7	3.25	24.6	3.65	25.9	3.90	26.6	3.94	27.3	3.98
	21	15.2	2.05	19.0	2.62	22.7	3.37	24.6	3.78	25.7	3.99	26.4	4.03	27.1	4.07
	23	15.2	2.11	19.0	2.80	22.7	3.60	24.6	4.05	25.4	4.17	26.1	4.21	26.8	4.26
	25	15.2	2.24	19.0	2.99	22.7	3.86	24.6	4.33	25.0	4.35	25.7	4.40	26.4	4.44
	27	15.2	2.39	19.0	3.19	22.7	4.12	24.3	4.51	24.6	4.54	25.3	4.58	26.1	4.63
	29	15.2	2.54	19.0	3.40	22.7	4.40	23.9	4.69	24.3	4.72	25.0	4.77	25.7	4.82
	31	15.2	2.70	19.0	3.62	22.7	4.69	23.5	4.88	23.9	4.90	24.6	4.96	25.3	5.01
	33	15.2	2.87	19.0	3.86	22.7	5.00	23.2	5.06	23.5	5.09	24.2	5.15	25.0	5.20
	35	15.2	3.04	19.0	4.10	22.5	5.22	22.8	5.25	23.2	5.28	23.9	5.34	24.6	5.40
	37	15.2	3.23	19.0	4.36	22.1	5.40	22.5	5.43	22.8	5.46	23.5	5.53	24.2	5.59
	39	15.2	3.43	19.0	4.64	21.7	5.58	22.1	5.62	22.4	5.65	23.2	5.72	23.9	5.78
100% 22.40 kW	10	13.8	1.70	17.2	2.13	20.7	2.58	22.4	2.82	24.1	3.06	27.6	3.55	28.6	3.49
	12	13.8	1.73	17.2	2.17	20.7	2.63	22.4	2.87	24.1	3.11	27.6	3.61	28.2	3.47
	14	13.8	1.76	17.2	2.20	20.7	2.68	22.4	2.92	24.1	3.17	27.2	3.59	27.8	3.45
	16	13.8	1.79	17.2	2.24	20.7	2.73	22.4	2.98	24.1	3.23	26.8	3.57	27.5	3.58
	18	13.8	1.82	17.2	2.28	20.7	2.78	22.4	3.03	24.1	3.29	26.5	3.73	27.1	3.76
	20	13.8	1.85	17.2	2.32	20.7	2.85	22.4	3.18	24.1	3.54	26.1	3.91	26.7	3.94
	21	13.8	1.86	17.2	2.35	20.7	2.95	22.4	3.29	24.1	3.66	25.9	4.00	26.6	4.04
	23	13.8	1.90	17.2	2.47	20.7	3.15	22.4	3.53	24.1	3.92	25.6	4.18	26.2	4.22
	25	13.8	2.00	17.2	2.64	20.7	3.37	22.4	3.77	24.1	4.20	25.2	4.36	25.8	4.41
	27	13.8	2.13	17.2	2.81	20.7	3.60	22.4	4.03	24.1	4.49	24.8	4.55	25.5	4.59
	29	13.8	2.26	17.2	2.99	20.7	3.84	22.4	4.30	23.8	4.69	24.5	4.73	25.1	4.78
	31	13.8	2.40	17.2	3.19	20.7	4.09	22.4	4.59	23.5	4.87	24.1	4.92	24.7	4.97
	33	13.8	2.55	17.2	3.39	20.7	4.36	22.4	4.89	23.1	5.05	23.7	5.10	24.4	5.16
	35	13.8	2.70	17.2	3.60	20.7	4.64	22.4	5.21	22.7	5.24	23.4	5.29	24.0	5.35
	37	13.8	2.86	17.2	3.83	20.7	4.94	22.0	5.39	22.4	5.42	23.0	5.48	23.6	5.54
	39	13.8	3.03	17.2	4.06	20.7	5.25	21.7	5.58	22.0	5.61	22.6	5.67	23.3	5.73

NOTES - ANMERKUNGEN - Σημειώσεις - NOTAS - REMARQUES - NOTE - OPMERKINGEN - примечания - NOTLAR

- The above table shows the average value of conditions which may occur.
Die obige Tabelle zeigt den Durchschnittswert der Bedingungen, die auftreten können.
 Στον παραπάνω πίνακα αναγράφεται η μέση τιμή για συνθήκες που μπορεί να προκύψουν.
La tabla de arriba muestra el valor medio de condiciones que pueden ocurrir.
 Le tableau ci-dessus donne la valeur moyenne pour des conditions qui peuvent survenir.
La tabella in alto mostra il valore delle condizioni medie che si possono riscontrare.
 De tabel hierboven geeft de gemiddelde waarde aan van situaties die kunnen voorvallen.
 Таблица расположенная выше показывает среднее значение условий, которые могут наступить.
 Yukarıdaki tablo meydana gelebilecek koşulların ortalama değerini göstermektedir.

3D079549

5 Таблицы производительности

5 - 1 Таблицы холодопроизводительности

5

RXYQ8T															
Indoor air temp. °CWB															
Combination(%) (Capacity index)	Outdoor air temp. (°CDB)	14.0		16.0		18.0		19.0		20.0		22.0		24.0	
		TC	PI	TC	PI	TC	PI	TC	PI	TC	PI	TC	PI	TC	PI
		KW	KW	KW	KW	KW	KW	KW	KW	KW	KW	KW	KW	KW	KW
90% 20.16 kW	10	12.4	1.54	15.5	1.91	18.6	2.31	20.2	2.51	21.7	2.72	24.8	3.16	27.9	3.60
	12	12.4	1.57	15.5	1.94	18.6	2.35	20.2	2.56	21.7	2.77	24.8	3.21	27.6	3.59
	14	12.4	1.59	15.5	1.98	18.6	2.39	20.2	2.60	21.7	2.82	24.8	3.27	27.3	3.58
	16	12.4	1.62	15.5	2.01	18.6	2.43	20.2	2.65	21.7	2.88	24.8	3.33	26.9	3.56
	18	12.4	1.64	15.5	2.05	18.6	2.48	20.2	2.70	21.7	2.93	24.8	3.43	26.5	3.73
	20	12.4	1.67	15.5	2.08	18.6	2.52	20.2	2.75	21.7	3.05	24.8	3.68	26.2	3.91
	21	12.4	1.68	15.5	2.10	18.6	2.56	20.2	2.85	21.7	3.15	24.8	3.81	26.0	4.00
	23	12.4	1.71	15.5	2.16	18.6	2.73	20.2	3.05	21.7	3.38	24.8	4.09	25.6	4.19
	25	12.4	1.77	15.5	2.31	18.6	2.92	20.2	3.25	21.7	3.61	24.7	4.33	25.3	4.37
	27	12.4	1.88	15.5	2.46	18.6	3.11	20.2	3.47	21.7	3.85	24.3	4.51	24.9	4.55
	29	12.4	2.00	15.5	2.61	18.6	3.32	20.2	3.70	21.7	4.11	23.9	4.70	24.5	4.74
	31	12.4	2.12	15.5	2.78	18.6	3.53	20.2	3.95	21.7	4.39	23.6	4.88	24.2	4.92
	33	12.4	2.25	15.5	2.95	18.6	3.76	20.2	4.20	21.7	4.67	23.2	5.06	23.8	5.11
	35	12.4	2.38	15.5	3.13	18.6	4.00	20.2	4.47	21.7	4.98	22.9	5.25	23.4	5.30
37	12.4	2.52	15.5	3.33	18.6	4.25	20.2	4.76	21.7	5.30	22.5	5.43	23.1	5.49	
39	12.4	2.67	15.5	3.53	18.6	4.52	20.2	5.06	21.5	5.57	22.1	5.62	22.7	5.67	
80% 17.92 kW	10	11.0	1.39	13.8	1.70	16.5	2.04	17.9	2.22	19.3	2.40	22.1	2.77	24.8	3.16
	12	11.0	1.41	13.8	1.73	16.5	2.08	17.9	2.26	19.3	2.44	22.1	2.82	24.8	3.21
	14	11.0	1.43	13.8	1.76	16.5	2.11	17.9	2.30	19.3	2.48	22.1	2.87	24.8	3.27
	16	11.0	1.45	13.8	1.79	16.5	2.15	17.9	2.34	19.3	2.53	22.1	2.93	24.8	3.33
	18	11.0	1.47	13.8	1.82	16.5	2.19	17.9	2.38	19.3	2.58	22.1	2.98	24.8	3.43
	20	11.0	1.50	13.8	1.85	16.5	2.23	17.9	2.42	19.3	2.63	22.1	3.11	24.8	3.68
	21	11.0	1.51	13.8	1.86	16.5	2.25	17.9	2.45	19.3	2.68	22.1	3.22	24.8	3.81
	23	11.0	1.53	13.8	1.90	16.5	2.35	17.9	2.60	19.3	2.87	22.1	3.45	24.8	4.09
	25	11.0	1.56	13.8	2.00	16.5	2.50	17.9	2.78	19.3	3.07	22.1	3.69	24.7	4.33
	27	11.0	1.65	13.8	2.13	16.5	2.67	17.9	2.96	19.3	3.27	22.1	3.94	24.3	4.51
	29	11.0	1.75	13.8	2.26	16.5	2.84	17.9	3.15	19.3	3.49	22.1	4.21	23.9	4.70
	31	11.0	1.86	13.8	2.40	16.5	3.02	17.9	3.36	19.3	3.71	22.1	4.49	23.6	4.88
	33	11.0	1.97	13.8	2.55	16.5	3.21	17.9	3.57	19.3	3.95	22.1	4.78	23.2	5.06
	35	11.0	2.08	13.8	2.70	16.5	3.41	17.9	3.80	19.3	4.21	22.1	5.09	22.9	5.25
37	11.0	2.20	13.8	2.86	16.5	3.62	17.9	4.04	19.3	4.47	22.0	5.39	22.5	5.43	
39	11.0	2.32	13.8	3.03	16.5	3.84	17.9	4.29	19.3	4.76	21.6	5.57	22.1	5.62	
70% 15.68 kW	10	9.6	1.24	12.1	1.50	14.5	1.79	15.7	1.93	16.9	2.09	19.3	2.40	21.7	2.72
	12	9.6	1.26	12.1	1.53	14.5	1.81	15.7	1.97	16.9	2.12	19.3	2.44	21.7	2.77
	14	9.6	1.28	12.1	1.55	14.5	1.84	15.7	2.00	16.9	2.16	19.3	2.48	21.7	2.82
	16	9.6	1.29	12.1	1.57	14.5	1.88	15.7	2.03	16.9	2.20	19.3	2.53	21.7	2.88
	18	9.6	1.31	12.1	1.60	14.5	1.91	15.7	2.07	16.9	2.23	19.3	2.58	21.7	2.93
	20	9.6	1.33	12.1	1.62	14.5	1.94	15.7	2.11	16.9	2.28	19.3	2.63	21.7	3.05
	21	9.6	1.34	12.1	1.64	14.5	1.96	15.7	2.13	16.9	2.30	19.3	2.68	21.7	3.15
	23	9.6	1.36	12.1	1.67	14.5	1.99	15.7	2.19	16.9	2.41	19.3	2.87	21.7	3.38
	25	9.6	1.38	12.1	1.72	14.5	2.12	15.7	2.34	16.9	2.57	19.3	3.07	21.7	3.61
	27	9.6	1.44	12.1	1.82	14.5	2.26	15.7	2.49	16.9	2.74	19.3	3.27	21.7	3.85
	29	9.6	1.53	12.1	1.94	14.5	2.40	15.7	2.65	16.9	2.92	19.3	3.49	21.7	4.11
	31	9.6	1.61	12.1	2.05	14.5	2.55	15.7	2.82	16.9	3.10	19.3	3.71	21.7	4.39
	33	9.6	1.71	12.1	2.17	14.5	2.70	15.7	2.99	16.9	3.30	19.3	3.95	21.7	4.67
	35	9.6	1.80	12.1	2.30	14.5	2.87	15.7	3.18	16.9	3.50	19.3	4.21	21.7	4.98
37	9.6	1.90	12.1	2.44	14.5	3.04	15.7	3.37	16.9	3.72	19.3	4.47	21.7	5.30	
39	9.6	2.01	12.1	2.58	14.5	3.23	15.7	3.58	16.9	3.95	19.3	4.76	21.5	5.57	
60% 13.44 kW	10	8.3	1.10	10.3	1.31	12.4	1.54	13.4	1.66	14.5	1.79	16.5	2.04	18.6	2.31
	12	8.3	1.12	10.3	1.33	12.4	1.57	13.4	1.69	14.5	1.81	16.5	2.08	18.6	2.35
	14	8.3	1.13	10.3	1.35	12.4	1.59	13.4	1.72	14.5	1.84	16.5	2.11	18.6	2.39
	16	8.3	1.14	10.3	1.37	12.4	1.62	13.4	1.74	14.5	1.88	16.5	2.15	18.6	2.43
	18	8.3	1.16	10.3	1.39	12.4	1.64	13.4	1.77	14.5	1.91	16.5	2.19	18.6	2.48
	20	8.3	1.17	10.3	1.41	12.4	1.67	13.4	1.80	14.5	1.94	16.5	2.23	18.6	2.52
	21	8.3	1.18	10.3	1.42	12.4	1.68	13.4	1.82	14.5	1.96	16.5	2.25	18.6	2.56
	23	8.3	1.20	10.3	1.45	12.4	1.71	13.4	1.85	14.5	1.99	16.5	2.35	18.6	2.73
	25	8.3	1.22	10.3	1.47	12.4	1.77	13.4	1.94	14.5	2.12	16.5	2.50	18.6	2.92
	27	8.3	1.25	10.3	1.55	12.4	1.88	13.4	2.06	14.5	2.26	16.5	2.67	18.6	3.11
	29	8.3	1.32	10.3	1.64	12.4	2.00	13.4	2.19	14.5	2.40	16.5	2.84	18.6	3.32
	31	8.3	1.39	10.3	1.73	12.4	2.12	13.4	2.33	14.5	2.55	16.5	3.02	18.6	3.53
	33	8.3	1.47	10.3	1.83	12.4	2.25	13.4	2.47	14.5	2.70	16.5	3.21	18.6	3.76
	35	8.3	1.55	10.3	1.94	12.4	2.38	13.4	2.62	14.5	2.87	16.5	3.41	18.6	4.00
37	8.3	1.63	10.3	2.05	12.4	2.52	13.4	2.77	14.5	3.04	16.5	3.62	18.6	4.25	
39	8.3	1.72	10.3	2.16	12.4	2.67	13.4	2.94	14.5	3.23	16.5	3.84	18.6	4.52	
50% 11.2 kW	10	6.89	0.97	8.6	1.14	10.3	1.31	11.2	1.41	12.1	1.50	13.8	1.70	15.5	1.91
	12	6.89	0.98	8.6	1.15	10.3	1.33	11.2	1.43	12.1	1.53	13.8	1.73	15.5	1.94
	14	6.89	0.99	8.6	1.17	10.3	1.35	11.2	1.45	12.1	1.55	13.8	1.76	15.5	1.98
	16	6.89	1.00	8.6	1.18	10.3	1.37	11.2	1.47	12.1	1.57	13.8	1.79	15.5	2.01
	18	6.89	1.01	8.6	1.20	10.3	1.39	11.2	1.49	12.1	1.60	13.8	1.82	15.5	2.05
	20	6.89	1.03	8.6	1.21	10.3	1.41	11.2	1.52	12.1	1.62	13.8	1.85	15.5	2.08
	21	6.89	1.03	8.6	1.22	10.3	1.42	11.2	1.53	12.1	1.64	13.8	1.86	15.5	2.10
	23	6.89	1.05	8.6	1.24	10.3	1.45	11.2	1.55	12.1	1.67	13.8	1.90	15.5	2.16
	25	6.89	1.06	8.6	1.26	10.3	1.47	11.2	1.58	12.1	1.72	13.8	2.00	15.5	2.31
	27	6.89	1.07	8.6	1.29	10.3	1.55	11.2	1.68	12.1	1.82	13.8	2.13	15.5	2.46
	29	6.89	1.12	8.6	1.37	10.3	1.64	11.2	1.78	12.1	1.94	13.8	2.26	15.5	2.61
	31	6.89	1.18	8.6	1.44	10.3	1.73	11.2	1.89	12.1	2.05	13.8	2.40	15.5	2.78
	33	6.89	1.25	8.6	1.52	10.3	1.83	11.2	2.00	12.1	2.17	13.8	2.55	15.5	2.95
	35	6.89	1.31	8.6	1.61	10.3	1.94	11.2	2.12	12.1	2.30	13.8	2.70	15.5	3.13
37	6.89	1.38	8.6	1.70	10.3	2.05	11.2	2.24	12.1	2.44	13.8	2.86	15.5	3.33	
39	6.89	1.45	8.6	1.79	10.3	2.16	11.2	2.37	12.1	2.58	13.8	3.03	15.5	3.53	

3D079549

5 Таблицы производительности

5 - 1 Таблицы холодопроизводительности

RXYQ10T															
Indoor air temp. °CWB															
Combination(%) (Capacity index)	Outdoor air temp. (°CDB)	14.0		16.0		18.0		19.0		20.0		22.0		24.0	
		TC	PI	TC	PI	TC	PI	TC	PI	TC	PI	TC	PI	TC	PI
		KW	KW	KW	KW	KW	KW	KW	KW	KW	KW	KW	KW	KW	KW
130% 36.40 kW	10	22.4	3.11	28.0	3.95	33.6	4.83	35.3	4.99	35.8	4.87	36.8	4.63	37.9	4.38
	12	22.4	3.16	28.0	4.02	33.6	4.92	34.8	4.97	35.3	4.85	36.4	4.60	37.4	4.60
	14	22.4	3.22	28.0	4.09	33.6	5.01	34.4	4.94	34.9	4.82	35.9	4.81	37.0	4.86
	16	22.4	3.27	28.0	4.17	33.4	5.04	33.9	4.99	34.4	5.01	35.5	5.07	36.5	5.13
	18	22.4	3.33	28.0	4.25	32.9	5.21	33.4	5.24	34.0	5.27	35.0	5.33	36.1	5.39
	20	22.4	3.40	28.0	4.46	32.5	5.46	33.0	5.50	33.5	5.53	34.6	5.59	35.6	5.66
	21	22.4	3.43	28.0	4.61	32.2	5.59	32.8	5.62	33.3	5.66	34.3	5.72	35.4	5.79
	23	22.4	3.65	28.0	4.94	31.8	5.85	32.3	5.88	32.8	5.92	33.9	5.99	34.9	6.06
	25	22.4	3.89	28.0	5.28	31.3	6.10	31.8	6.14	32.4	6.18	33.4	6.25	34.5	6.33
	27	22.4	4.15	28.0	5.64	30.9	6.36	31.4	6.40	31.9	6.44	33.0	6.52	34.0	6.60
	29	22.4	4.42	28.0	6.02	30.4	6.62	30.9	6.66	31.5	6.70	32.5	6.78	33.6	6.87
	31	22.4	4.70	28.0	6.43	30.0	6.88	30.5	6.92	31.0	6.96	32.1	7.05	33.1	7.14
	33	22.4	5.00	28.0	6.85	29.5	7.14	30.0	7.18	30.6	7.23	31.6	7.32	32.6	7.42
	35	22.4	5.32	28.0	7.30	29.0	7.40	29.6	7.45	30.1	7.50	31.1	7.59	32.2	7.69
	37	22.4	5.65	27.5	7.55	28.6	7.66	29.1	7.71	29.6	7.76	30.7	7.87	31.7	7.97
	39	22.4	6.01	27.1	7.81	28.1	7.92	28.7	7.98	29.2	8.03	30.2	8.14	31.3	8.25
120% 33.60 kW	10	20.7	2.86	25.8	3.62	31.0	4.42	33.6	4.83	35.2	5.00	36.2	4.78	37.2	4.55
	12	20.7	2.91	25.8	3.68	31.0	4.50	33.6	4.92	34.8	4.98	35.7	4.75	36.7	4.57
	14	20.7	2.96	25.8	3.75	31.0	4.58	33.6	5.01	34.3	4.95	35.3	4.78	36.2	4.83
	16	20.7	3.01	25.8	3.82	31.0	4.67	33.4	5.04	33.9	4.98	34.8	5.04	35.8	5.09
	18	20.7	3.06	25.8	3.89	31.0	4.80	32.9	5.21	33.4	5.24	34.4	5.29	35.3	5.35
	20	20.7	3.12	25.8	3.99	31.0	5.16	32.5	5.46	32.9	5.49	33.9	5.55	34.9	5.61
	21	20.7	3.15	25.8	4.13	31.0	5.34	32.2	5.59	32.7	5.62	33.7	5.68	34.7	5.74
	23	20.7	3.29	25.8	4.42	31.0	5.72	31.8	5.85	32.3	5.88	33.2	5.94	34.2	6.01
	25	20.7	3.51	25.8	4.72	30.8	6.07	31.3	6.10	31.8	6.14	32.8	6.21	33.7	6.27
	27	20.7	3.74	25.8	5.04	30.4	6.32	30.9	6.36	31.4	6.40	32.3	6.47	33.3	6.54
	29	20.7	3.98	25.8	5.38	29.9	6.58	30.4	6.62	30.9	6.66	31.9	6.73	32.8	6.81
	31	20.7	4.23	25.8	5.73	29.5	6.83	30.0	6.88	30.4	6.92	31.4	7.00	32.4	7.08
	33	20.7	4.50	25.8	6.10	29.0	7.09	29.5	7.14	30.0	7.18	31.0	7.27	31.9	7.35
	35	20.7	4.78	25.8	6.50	28.6	7.35	29.0	7.40	29.5	7.44	30.5	7.53	31.5	7.63
	37	20.7	5.07	25.8	6.92	28.1	7.61	28.6	7.66	29.1	7.71	30.0	7.80	31.0	7.90
	39	20.7	5.39	25.8	7.36	27.7	7.87	28.1	7.92	28.6	7.97	29.6	8.08	30.6	8.18
110% 30.80 kW	10	19.0	2.62	23.7	3.30	28.4	4.02	30.8	4.39	33.2	4.76	35.5	4.93	36.4	4.72
	12	19.0	2.66	23.7	3.36	28.4	4.09	30.8	4.47	33.2	4.85	35.1	4.90	36.0	4.69
	14	19.0	2.71	23.7	3.41	28.4	4.16	30.8	4.55	33.2	4.94	34.6	4.88	35.5	4.79
	16	19.0	2.75	23.7	3.48	28.4	4.24	30.8	4.63	33.2	5.03	34.2	5.00	35.1	5.05
	18	19.0	2.80	23.7	3.54	28.4	4.32	30.8	4.76	32.8	5.21	33.7	5.26	34.6	5.31
	20	19.0	2.85	23.7	3.61	28.4	4.55	30.8	5.11	32.4	5.46	33.3	5.51	34.2	5.57
	21	19.0	2.88	23.7	3.67	28.4	4.72	30.8	5.29	32.2	5.59	33.0	5.64	33.9	5.70
	23	19.0	2.95	23.7	3.93	28.4	5.05	30.8	5.67	31.7	5.84	32.6	5.90	33.5	5.96
	25	19.0	3.14	23.7	4.19	28.4	5.40	30.8	6.06	31.2	6.10	32.1	6.16	33.0	6.22
	27	19.0	3.35	23.7	4.47	28.4	5.77	30.3	6.32	30.8	6.35	31.7	6.42	32.6	6.49
	29	19.0	3.56	23.7	4.77	28.4	6.16	29.9	6.57	30.3	6.61	31.2	6.68	32.1	6.75
	31	19.0	3.78	23.7	5.08	28.4	6.57	29.4	6.83	29.9	6.87	30.8	6.94	31.7	7.02
	33	19.0	4.02	23.7	5.40	28.4	7.00	29.0	7.09	29.4	7.13	30.3	7.21	31.2	7.29
	35	19.0	4.27	23.7	5.75	28.1	7.30	28.5	7.35	29.0	7.39	29.9	7.47	30.7	7.56
	37	19.0	4.53	23.7	6.11	27.6	7.56	28.1	7.61	28.5	7.65	29.4	7.74	30.3	7.83
	39	19.0	4.80	23.7	6.50	27.2	7.82	27.6	7.87	28.1	7.91	28.9	8.01	29.8	8.10
100% 28.00 kW	10	17.2	2.39	21.5	2.98	25.8	3.62	28.0	3.95	30.2	4.29	34.5	4.97	35.7	4.89
	12	17.2	2.43	21.5	3.03	25.8	3.68	28.0	4.02	30.2	4.36	34.4	5.05	35.3	4.87
	14	17.2	2.46	21.5	3.09	25.8	3.75	28.0	4.09	30.2	4.44	34.0	5.03	34.8	4.84
	16	17.2	2.50	21.5	3.14	25.8	3.82	28.0	4.17	30.2	4.52	33.5	5.00	34.3	5.01
	18	17.2	2.55	21.5	3.20	25.8	3.89	28.0	4.25	30.2	4.61	33.1	5.22	33.9	5.27
	20	17.2	2.59	21.5	3.26	25.8	3.99	28.0	4.46	30.2	4.95	32.6	5.47	33.4	5.52
	21	17.2	2.61	21.5	3.29	25.8	4.13	28.0	4.61	30.2	5.13	32.4	5.60	33.2	5.65
	23	17.2	2.66	21.5	3.46	25.8	4.42	28.0	4.94	30.2	5.49	31.9	5.86	32.7	5.91
	25	17.2	2.80	21.5	3.70	25.8	4.72	28.0	5.28	30.2	5.88	31.5	6.11	32.3	6.17
	27	17.2	2.98	21.5	3.94	25.8	5.04	28.0	5.64	30.2	6.28	31.0	6.37	31.8	6.43
	29	17.2	3.17	21.5	4.20	25.8	5.38	28.0	6.02	29.8	6.56	30.6	6.63	31.4	6.69
	31	17.2	3.36	21.5	4.46	25.8	5.73	28.0	6.43	29.3	6.82	30.1	6.89	30.9	6.96
	33	17.2	3.57	21.5	4.75	25.8	6.10	28.0	6.85	28.9	7.08	29.7	7.15	30.5	7.22
	35	17.2	3.78	21.5	5.04	25.8	6.50	28.0	7.30	28.4	7.34	29.2	7.41	30.0	7.49
	37	17.2	4.01	21.5	5.36	25.8	6.92	27.5	7.55	27.9	7.59	28.8	7.67	29.6	7.76
	39	17.2	4.25	21.5	5.69	25.8	7.36	27.1	7.81	27.5	7.85	28.3	7.94	29.1	8.02

NOTES - ANMERKUNGEN - Σημειώσεις - NOTAS - REMARQUES - NOTE - OPMERKINGEN - примечания - NOTLAR

- The above table shows the average value of conditions which may occur.
Die obige Tabelle zeigt den Durchschnittswert der Bedingungen, die auftreten können.
 Στον παραπάνω πίνακα αναγράφεται η μέση τιμή για συνθήκες που μπορεί να προκύψουν.
La tabla de arriba muestra el valor medio de condiciones que pueden ocurrir.
 Le tableau ci-dessus donne la valeur moyenne pour des conditions qui peuvent survenir.
La tabella in alto mostra il valore delle condizioni medie che si possono riscontrare.
 De tabel hierboven geeft de gemiddelde waarde aan van situaties die kunnen voorvallen.
Таблица расположенная выше показывает среднее значение условий, которые могут наступить.
 Yukarıdaki tablo meydana gelebilecek koşulların ortalama değerini göstermektedir.

3D079549

5 Таблицы производительности

5 - 1 Таблицы холодопроизводительности

5

RXYQ10T															
Indoor air temp. °CWB															
Combination(%) (Capacity index)	Outdoor air temp. (°CDB)	14.0		16.0		18.0		19.0		20.0		22.0		24.0	
		TC	PI	TC	PI	TC	PI	TC	PI	TC	PI	TC	PI	TC	PI
		KW	KW	KW	KW	KW	KW	KW	KW	KW	KW	KW	KW	KW	KW
90% 25.20 kW	10	15.5	2.16	19.4	2.68	23.3	3.23	25.2	3.52	27.1	3.82	31.0	4.42	34.9	5.04
	12	15.5	2.20	19.4	2.72	23.3	3.29	25.2	3.58	27.1	3.89	31.0	4.50	34.5	5.03
	14	15.5	2.23	19.4	2.77	23.3	3.35	25.2	3.65	27.1	3.96	31.0	4.58	34.1	5.01
	16	15.5	2.26	19.4	2.82	23.3	3.41	25.2	3.72	27.1	4.03	31.0	4.67	33.6	4.98
	18	15.5	2.30	19.4	2.87	23.3	3.47	25.2	3.78	27.1	4.10	31.0	4.80	33.2	5.22
	20	15.5	2.34	19.4	2.92	23.3	3.54	25.2	3.86	27.1	4.27	31.0	5.16	32.7	5.48
	21	15.5	2.36	19.4	2.94	23.3	3.58	25.2	3.99	27.1	4.42	31.0	5.34	32.5	5.61
	23	15.5	2.40	19.4	3.03	23.3	3.83	25.2	4.27	27.1	4.73	31.0	5.72	32.0	5.86
	25	15.5	2.48	19.4	3.23	23.3	4.09	25.2	4.56	27.1	5.05	30.8	6.07	31.6	6.12
	27	15.5	2.64	19.4	3.44	23.3	4.36	25.2	4.87	27.1	5.40	30.4	6.32	31.1	6.38
	29	15.5	2.80	19.4	3.66	23.3	4.65	25.2	5.19	27.1	5.76	29.9	6.58	30.7	6.64
	31	15.5	2.97	19.4	3.89	23.3	4.95	25.2	5.53	27.1	6.14	29.5	6.83	30.2	6.90
	33	15.5	3.15	19.4	4.14	23.3	5.27	25.2	5.89	27.1	6.55	29.0	7.09	29.7	7.16
	35	15.5	3.33	19.4	4.39	23.3	5.60	25.2	6.27	27.1	6.97	28.6	7.35	29.3	7.42
	37	15.5	3.53	19.4	4.66	23.3	5.96	25.2	6.67	27.1	7.42	28.1	7.61	28.8	7.68
	39	15.5	3.74	19.4	4.94	23.3	6.33	25.2	7.09	26.9	7.80	27.7	7.87	28.4	7.95
80% 22.40 kW	10	13.8	1.95	17.2	2.39	20.7	2.86	22.4	3.11	24.1	3.36	27.6	3.88	31.0	4.42
	12	13.8	1.98	17.2	2.43	20.7	2.91	22.4	3.16	24.1	3.42	27.6	3.95	31.0	4.50
	14	13.8	2.00	17.2	2.46	20.7	2.96	22.4	3.22	24.1	3.48	27.6	4.02	31.0	4.58
	16	13.8	2.03	17.2	2.50	20.7	3.01	22.4	3.27	24.1	3.54	27.6	4.10	31.0	4.67
	18	13.8	2.06	17.2	2.55	20.7	3.06	22.4	3.33	24.1	3.61	27.6	4.18	31.0	4.80
	20	13.8	2.10	17.2	2.59	20.7	3.12	22.4	3.40	24.1	3.68	27.6	4.36	31.0	5.16
	21	13.8	2.11	17.2	2.61	20.7	3.15	22.4	3.43	24.1	3.76	27.6	4.52	31.0	5.34
	23	13.8	2.15	17.2	2.66	20.7	3.29	22.4	3.65	24.1	4.02	27.6	4.83	31.0	5.72
	25	13.8	2.18	17.2	2.80	20.7	3.51	22.4	3.89	24.1	4.30	27.6	5.17	30.8	6.07
	27	13.8	2.32	17.2	2.98	20.7	3.74	22.4	4.15	24.1	4.58	27.6	5.52	30.4	6.32
	29	13.8	2.46	17.2	3.17	20.7	3.98	22.4	4.42	24.1	4.89	27.6	5.89	29.9	6.58
	31	13.8	2.60	17.2	3.36	20.7	4.23	22.4	4.70	24.1	5.20	27.6	6.28	29.5	6.83
	33	13.8	2.76	17.2	3.57	20.7	4.50	22.4	5.00	24.1	5.54	27.6	6.70	29.0	7.09
	35	13.8	2.91	17.2	3.78	20.7	4.78	22.4	5.32	24.1	5.89	27.6	7.13	28.6	7.35
	37	13.8	3.08	17.2	4.01	20.7	5.07	22.4	5.65	24.1	6.27	27.5	7.55	28.1	7.61
	39	13.8	3.26	17.2	4.25	20.7	5.39	22.4	6.01	24.1	6.66	27.0	7.80	27.7	7.87
70% 19.60 kW	10	12.1	1.74	15.1	2.11	18.1	2.50	19.6	2.71	21.1	2.92	24.1	3.36	27.1	3.82
	12	12.1	1.76	15.1	2.14	18.1	2.54	19.6	2.75	21.1	2.97	24.1	3.42	27.1	3.89
	14	12.1	1.79	15.1	2.17	18.1	2.59	19.6	2.80	21.1	3.02	24.1	3.48	27.1	3.96
	16	12.1	1.81	15.1	2.21	18.1	2.63	19.6	2.85	21.1	3.08	24.1	3.54	27.1	4.03
	18	12.1	1.84	15.1	2.24	18.1	2.67	19.6	2.90	21.1	3.13	24.1	3.61	27.1	4.10
	20	12.1	1.87	15.1	2.28	18.1	2.72	19.6	2.95	21.1	3.19	24.1	3.68	27.1	4.27
	21	12.1	1.88	15.1	2.30	18.1	2.74	19.6	2.98	21.1	3.22	24.1	3.76	27.1	4.42
	23	12.1	1.91	15.1	2.34	18.1	2.79	19.6	3.08	21.1	3.38	24.1	4.02	27.1	4.73
	25	12.1	1.94	15.1	2.41	18.1	2.97	19.6	3.28	21.1	3.60	24.1	4.30	27.1	5.05
	27	12.1	2.02	15.1	2.56	18.1	3.16	19.6	3.49	21.1	3.84	24.1	4.58	27.1	5.40
	29	12.1	2.14	15.1	2.71	18.1	3.36	19.6	3.71	21.1	4.09	24.1	4.89	27.1	5.76
	31	12.1	2.26	15.1	2.88	18.1	3.57	19.6	3.95	21.1	4.35	24.1	5.20	27.1	6.14
	33	12.1	2.39	15.1	3.05	18.1	3.79	19.6	4.19	21.1	4.62	24.1	5.54	27.1	6.55
	35	12.1	2.53	15.1	3.23	18.1	4.02	19.6	4.45	21.1	4.91	24.1	5.89	27.1	6.97
	37	12.1	2.67	15.1	3.41	18.1	4.26	19.6	4.73	21.1	5.22	24.1	6.27	27.1	7.42
	39	12.1	2.81	15.1	3.61	18.1	4.52	19.6	5.02	21.1	5.54	24.1	6.66	26.9	7.80
60% 16.80 kW	10	10.3	1.55	12.9	1.84	15.5	2.16	16.8	2.33	18.1	2.50	20.7	2.86	23.3	3.23
	12	10.3	1.56	12.9	1.87	15.5	2.20	16.8	2.37	18.1	2.54	20.7	2.91	23.3	3.29
	14	10.3	1.58	12.9	1.90	15.5	2.23	16.8	2.40	18.1	2.59	20.7	2.96	23.3	3.35
	16	10.3	1.60	12.9	1.92	15.5	2.26	16.8	2.44	18.1	2.63	20.7	3.01	23.3	3.41
	18	10.3	1.63	12.9	1.95	15.5	2.30	16.8	2.48	18.1	2.67	20.7	3.06	23.3	3.47
	20	10.3	1.65	12.9	1.98	15.5	2.34	16.8	2.53	18.1	2.72	20.7	3.12	23.3	3.54
	21	10.3	1.66	12.9	2.00	15.5	2.36	16.8	2.55	18.1	2.74	20.7	3.15	23.3	3.58
	23	10.3	1.68	12.9	2.03	15.5	2.40	16.8	2.59	18.1	2.79	20.7	3.29	23.3	3.83
	25	10.3	1.71	12.9	2.06	15.5	2.48	16.8	2.72	18.1	2.97	20.7	3.51	23.3	4.09
	27	10.3	1.75	12.9	2.17	15.5	2.64	16.8	2.89	18.1	3.16	20.7	3.74	23.3	4.36
	29	10.3	1.85	12.9	2.30	15.5	2.80	16.8	3.07	18.1	3.36	20.7	3.98	23.3	4.65
	31	10.3	1.95	12.9	2.43	15.5	2.97	16.8	3.26	18.1	3.57	20.7	4.23	23.3	4.95
	33	10.3	2.06	12.9	2.57	15.5	3.15	16.8	3.46	18.1	3.79	20.7	4.50	23.3	5.27
	35	10.3	2.17	12.9	2.72	15.5	3.33	16.8	3.67	18.1	4.02	20.7	4.78	23.3	5.60
	37	10.3	2.29	12.9	2.87	15.5	3.53	16.8	3.89	18.1	4.26	20.7	5.07	23.3	5.96
	39	10.3	2.41	12.9	3.03	15.5	3.74	16.8	4.12	18.1	4.52	20.7	5.39	23.3	6.33
50% 14.00 kW	10	8.62	1.36	10.8	1.59	12.9	1.84	14.0	1.97	15.1	2.11	17.2	2.39	19.4	2.68
	12	8.62	1.38	10.8	1.61	12.9	1.87	14.0	2.00	15.1	2.14	17.2	2.43	19.4	2.72
	14	8.62	1.39	10.8	1.63	12.9	1.90	14.0	2.03	15.1	2.17	17.2	2.46	19.4	2.77
	16	8.62	1.41	10.8	1.66	12.9	1.92	14.0	2.06	15.1	2.21	17.2	2.50	19.4	2.82
	18	8.62	1.42	10.8	1.68	12.9	1.95	14.0	2.09	15.1	2.24	17.2	2.55	19.4	2.87
	20	8.62	1.44	10.8	1.70	12.9	1.98	14.0	2.13	15.1	2.28	17.2	2.59	19.4	2.92
	21	8.62	1.45	10.8	1.71	12.9	2.00	14.0	2.14	15.1	2.30	17.2	2.61	19.4	2.94
	23	8.62	1.47	10.8	1.74	12.9	2.03	14.0	2.18	15.1	2.34	17.2	2.66	19.4	3.03
	25	8.62	1.49	10.8	1.76	12.9	2.06	14.0	2.22	15.1	2.41	17.2	2.80	19.4	3.23
	27	8.62	1.51	10.8	1.81	12.9	2.17	14.0	2.36	15.1	2.56	17.2	2.98	19.4	3.44
	29	8.62	1.58	10.8	1.92	12.9	2.30	14.0	2.50	15.1	2.71	17.2	3.17	19.4	3.66
	31	8.62	1.66	10.8	2.02	12.9	2.43	14.0	2.65	15.1	2.88	17.2	3.36	19.4	3.89
	33	8.62	1.75	10.8	2.14	12.9	2.57	14.0	2.80	15.1	3.05	17.2	3.57	19.4	4.14
	35	8.62	1.84	10.8	2.25	12.9	2.72	14.0	2.97	15.1	3.23	17.2	3.78	19.4	4.39
	37	8.62	1.94	10.8	2.38	12.9	2.87	14.0	3.14	15.1	3.41	17.2	4.01	19.4	4.66
	39	8.62	2.04	10.8	2.51	12.9	3.03	14.0	3.31	15.1	3.61	17.2	4.25	19.4	4.94

3D079549

5 Таблицы производительности

5 - 1 Таблицы холодопроизводительности

RXYQ12T															
Indoor air temp. °CWB															
Combination(%) (Capacity index)	Outdoor air temp. (°CDB)	14.0		16.0		18.0		19.0		20.0		22.0		24.0	
		TC	PI	TC	PI	TC	PI	TC	PI	TC	PI	TC	PI	TC	PI
		KW		KW		KW		KW		KW		KW		KW	
130% 43.55 kW	10	26.8	3.83	33.5	4.87	40.2	5.95	42.2	6.15	42.8	6.00	44.1	5.70	45.3	5.39
	12	26.8	3.89	33.5	4.95	40.2	6.06	41.6	6.12	42.3	5.97	43.5	5.66	44.8	5.67
	14	26.8	3.96	33.5	5.04	40.2	6.17	41.1	6.09	41.7	5.94	43.0	5.93	44.2	5.99
	16	26.8	4.03	33.5	5.14	39.9	6.21	40.6	6.14	41.2	6.18	42.4	6.25	43.7	6.32
	18	26.8	4.11	33.5	5.23	39.4	6.42	40.0	6.46	40.6	6.49	41.9	6.57	43.1	6.64
	20	26.8	4.18	33.5	5.49	38.8	6.73	39.5	6.77	40.1	6.81	41.3	6.89	42.6	6.97
	21	26.8	4.22	33.5	5.68	38.6	6.89	39.2	6.93	39.8	6.97	41.1	7.05	42.3	7.13
	23	26.8	4.49	33.5	6.09	38.0	7.20	38.7	7.25	39.3	7.29	40.5	7.38	41.8	7.46
	25	26.8	4.79	33.5	6.51	37.5	7.52	38.1	7.56	38.7	7.61	40.0	7.70	41.2	7.79
	27	26.8	5.11	33.5	6.95	36.9	7.83	37.6	7.88	38.2	7.93	39.4	8.03	40.7	8.13
	29	26.8	5.44	33.5	7.42	36.4	8.15	37.0	8.20	37.6	8.25	38.9	8.36	40.1	8.46
	31	26.8	5.79	33.5	7.92	35.8	8.47	36.5	8.52	37.1	8.58	38.4	8.69	39.6	8.80
	33	26.8	6.16	33.5	8.44	35.3	8.79	35.9	8.85	36.6	8.90	37.8	9.02	39.1	9.14
	35	26.8	6.55	33.5	8.99	34.8	9.11	35.4	9.17	36.0	9.23	37.3	9.36	38.5	9.48
37	26.8	6.96	33.0	9.31	34.2	9.43	34.8	9.50	35.5	9.56	36.7	9.7	38.0	9.8	
39	26.8	7.40	32.4	9.6	33.7	9.8	34.3	9.8	34.9	9.9	36.2	10.0	37.4	10.2	
120% 40.20 kW	10	24.7	3.53	30.9	4.46	37.1	5.45	40.2	5.95	42.1	6.16	43.3	5.89	44.5	5.61
	12	24.7	3.58	30.9	4.54	37.1	5.54	40.2	6.06	41.6	6.13	42.8	5.85	43.9	5.63
	14	24.7	3.64	30.9	4.62	37.1	5.65	40.2	6.17	41.1	6.10	42.2	5.89	43.4	5.95
	16	24.7	3.71	30.9	4.70	37.1	5.75	39.9	6.21	40.5	6.14	41.7	6.20	42.8	6.27
	18	24.7	3.77	30.9	4.79	37.1	5.92	39.4	6.42	40.0	6.45	41.1	6.52	42.3	6.59
	20	24.7	3.84	30.9	4.91	37.1	6.35	38.8	6.73	39.4	6.77	40.6	6.84	41.7	6.91
	21	24.7	3.88	30.9	5.09	37.1	6.58	38.6	6.89	39.1	6.93	40.3	7.00	41.5	7.08
	23	24.7	4.05	30.9	5.44	37.1	7.05	38.0	7.20	38.6	7.24	39.8	7.32	40.9	7.40
	25	24.7	4.32	30.9	5.82	36.9	7.47	37.5	7.52	38.1	7.56	39.2	7.64	40.4	7.73
	27	24.7	4.60	30.9	6.21	36.4	7.79	36.9	7.83	37.5	7.88	38.7	7.97	39.8	8.06
	29	24.7	4.90	30.9	6.62	35.8	8.10	36.4	8.15	37.0	8.20	38.1	8.29	39.3	8.39
	31	24.7	5.21	30.9	7.06	35.3	8.42	35.8	8.47	36.4	8.52	37.6	8.62	38.7	8.72
	33	24.7	5.54	30.9	7.52	34.7	8.74	35.3	8.79	35.9	8.84	37.0	8.95	38.2	9.06
	35	24.7	5.88	30.9	8.00	34.2	9.05	34.8	9.11	35.3	9.17	36.5	9.28	37.6	9.39
37	24.7	6.25	30.9	8.52	33.6	9.37	34.2	9.43	34.8	9.49	35.9	9.61	37.1	9.7	
39	24.7	6.63	30.9	9.06	33.1	9.7	33.7	9.8	34.2	9.8	35.4	9.9	36.6	10.1	
110% 36.85 kW	10	22.7	3.23	28.3	4.06	34.0	4.95	36.9	5.40	39.7	5.87	42.5	6.07	43.6	5.82
	12	22.7	3.28	28.3	4.13	34.0	5.04	36.9	5.50	39.7	5.97	42.0	6.04	43.0	5.78
	14	22.7	3.34	28.3	4.21	34.0	5.13	36.9	5.60	39.7	6.08	41.4	6.01	42.5	5.90
	16	22.7	3.39	28.3	4.28	34.0	5.22	36.9	5.71	39.7	6.19	40.9	6.16	42.0	6.22
	18	22.7	3.45	28.3	4.36	34.0	5.32	36.9	5.86	39.3	6.41	40.4	6.48	41.4	6.54
	20	22.7	3.51	28.3	4.44	34.0	5.61	36.9	6.29	38.7	6.73	39.8	6.79	40.9	6.86
	21	22.7	3.54	28.3	4.52	34.0	5.81	36.9	6.51	38.5	6.88	39.5	6.95	40.6	7.02
	23	22.7	3.64	28.3	4.84	34.0	6.22	36.9	6.98	37.9	7.20	39.0	7.27	40.0	7.34
	25	22.7	3.87	28.3	5.16	34.0	6.65	36.9	7.47	37.4	7.51	38.4	7.59	39.5	7.67
	27	22.7	4.12	28.3	5.51	34.0	7.11	36.3	7.78	36.8	7.83	37.9	7.91	39.0	7.99
	29	22.7	4.39	28.3	5.87	34.0	7.59	35.8	8.10	36.3	8.14	37.4	8.23	38.4	8.32
	31	22.7	4.66	28.3	6.25	34.0	8.09	35.2	8.41	35.7	8.46	36.8	8.55	37.9	8.65
	33	22.7	4.95	28.3	6.66	34.0	8.63	34.7	8.73	35.2	8.78	36.3	8.88	37.3	8.98
	35	22.7	5.25	28.3	7.08	33.6	9.00	34.1	9.05	34.7	9.10	35.7	9.20	36.8	9.31
37	22.7	5.57	28.3	7.53	33.1	9.32	33.6	9.37	34.1	9.42	35.2	9.53	36.2	9.64	
39	22.7	5.91	28.3	8.00	32.5	9.6	33.0	9.7	33.6	9.7	34.6	9.9	35.7	10.0	
100% 33.50 kW	10	20.6	2.94	25.8	3.68	30.9	4.46	33.5	4.87	36.1	5.28	41.2	6.12	42.7	6.03
	12	20.6	2.99	25.8	3.74	30.9	4.54	33.5	4.95	36.1	5.37	41.2	6.22	42.2	5.99
	14	20.6	3.04	25.8	3.80	30.9	4.62	33.5	5.04	36.1	5.47	40.7	6.19	41.6	5.96
	16	20.6	3.09	25.8	3.87	30.9	4.70	33.5	5.14	36.1	5.57	40.1	6.16	41.1	6.17
	18	20.6	3.14	25.8	3.94	30.9	4.79	33.5	5.23	36.1	5.68	39.6	6.43	40.5	6.49
	20	20.6	3.19	25.8	4.01	30.9	4.91	33.5	5.49	36.1	6.10	39.0	6.74	40.0	6.80
	21	20.6	3.22	25.8	4.05	30.9	5.09	33.5	5.68	36.1	6.32	38.8	6.90	39.7	6.96
	23	20.6	3.28	25.8	4.27	30.9	5.44	33.5	6.09	36.1	6.77	38.2	7.22	39.2	7.28
	25	20.6	3.45	25.8	4.55	30.9	5.82	33.5	6.51	36.1	7.24	37.7	7.53	38.6	7.60
	27	20.6	3.67	25.8	4.85	30.9	6.21	33.5	6.95	36.1	7.74	37.1	7.85	38.1	7.92
	29	20.6	3.90	25.8	5.17	30.9	6.62	33.5	7.42	35.6	8.09	36.6	8.17	37.5	8.25
	31	20.6	4.14	25.8	5.50	30.9	7.06	33.5	7.92	35.1	8.40	36.0	8.49	37.0	8.57
	33	20.6	4.40	25.8	5.85	30.9	7.52	33.5	8.44	34.5	8.72	35.5	8.81	36.5	8.90
	35	20.6	4.66	25.8	6.21	30.9	8.00	33.5	8.99	34.0	9.04	34.9	9.13	35.9	9.22
37	20.6	4.94	25.8	6.60	30.9	8.52	33.0	9.31	33.4	9.36	34.4	9.45	35.4	9.55	
39	20.6	5.24	25.8	7.01	30.9	9.06	32.4	9.62	32.9	9.7	33.9	9.8	34.8	9.9	

NOTES - ANMERKUNGEN - Σημειώσεις - NOTAS - REMARQUES - NOTE - OPMERKINGEN - примечания - NOTLAR

- The above table shows the average value of conditions which may occur.
Die obige Tabelle zeigt den Durchschnittswert der Bedingungen, die auftreten können.
 Στον παραπάνω πίνακα αναγράφεται η μέση τιμή για συνθήκες που μπορεί να προκύψουν.
La tabla de arriba muestra el valor medio de condiciones que pueden ocurrir.
 Le tableau ci-dessus donne la valeur moyenne pour des conditions qui peuvent survenir.
La tabella in alto mostra il valore delle condizioni medie che si possono riscontrare.
 De tabel hierboven geeft de gemiddelde waarde aan van situaties die kunnen voorvallen.
Таблица расположенная выше показывает среднее значение условий, которые могут наступить.
 Yukarıdaki tablo meydana gelebilecek koşulların ortalama değerini göstermektedir.

5 Таблицы производительности

5 - 1 Таблицы холодопроизводительности

5

RXYQ12T															
Indoor air temp. °CWB															
Combination(%) (Capacity index)	Outdoor air temp. (°CDB)	14.0		16.0		18.0		19.0		20.0		22.0		24.0	
		TC	PI	TC	PI	TC	PI	TC	PI	TC	PI	TC	PI	TC	PI
		KW	KW	KW	KW	KW	KW	KW	KW	KW	KW	KW	KW	KW	KW
90% 30.15 kW	10	18.6	2.67	23.2	3.30	27.8	3.98	30.2	4.34	32.5	4.70	37.1	5.45	41.7	6.20
	12	18.6	2.71	23.2	3.36	27.8	4.05	30.2	4.42	32.5	4.79	37.1	5.54	41.3	6.20
	14	18.6	2.75	23.2	3.41	27.8	4.12	30.2	4.49	32.5	4.87	37.1	5.65	40.8	6.17
	16	18.6	2.79	23.2	3.47	27.8	4.20	30.2	4.58	32.5	4.96	37.1	5.75	40.2	6.14
	18	18.6	2.83	23.2	3.53	27.8	4.28	30.2	4.66	32.5	5.06	37.1	5.92	39.7	6.44
	20	18.6	2.88	23.2	3.59	27.8	4.36	30.2	4.75	32.5	5.26	37.1	6.35	39.1	6.75
	21	18.6	2.91	23.2	3.63	27.8	4.41	30.2	4.91	32.5	5.44	37.1	6.58	38.9	6.91
	23	18.6	2.95	23.2	3.74	27.8	4.72	30.2	5.26	32.5	5.82	37.1	7.05	38.3	7.22
	25	18.6	3.06	23.2	3.98	27.8	5.04	30.2	5.62	32.5	6.23	36.9	7.47	37.8	7.54
	27	18.6	3.25	23.2	4.24	27.8	5.37	30.2	5.99	32.5	6.65	36.4	7.79	37.2	7.86
	29	18.6	3.45	23.2	4.51	27.8	5.73	30.2	6.39	32.5	7.10	35.8	8.10	36.7	8.17
	31	18.6	3.66	23.2	4.80	27.8	6.10	30.2	6.81	32.5	7.57	35.3	8.42	36.1	8.49
	33	18.6	3.88	23.2	5.09	27.8	6.49	30.2	7.25	32.5	8.06	34.7	8.74	35.6	8.82
	35	18.6	4.11	23.2	5.41	27.8	6.90	30.2	7.72	32.5	8.59	34.2	9.05	35.0	9.14
37	18.6	4.35	23.2	5.74	27.8	7.34	30.2	8.21	32.5	9.14	33.6	9.37	34.5	9.46	
39	18.6	4.60	23.2	6.09	27.8	7.80	30.2	8.74	32.2	9.60	33.1	9.7	34.0	9.8	
80% 26.80 kW	10	16.5	2.40	20.6	2.94	24.7	3.53	26.8	3.83	28.9	4.14	33.0	4.78	37.1	5.45
	12	16.5	2.43	20.6	2.99	24.7	3.58	26.8	3.89	28.9	4.21	33.0	4.87	37.1	5.54
	14	16.5	2.47	20.6	3.04	24.7	3.64	26.8	3.96	28.9	4.29	33.0	4.96	37.1	5.65
	16	16.5	2.51	20.6	3.09	24.7	3.71	26.8	4.03	28.9	4.37	33.0	5.05	37.1	5.75
	18	16.5	2.54	20.6	3.14	24.7	3.77	26.8	4.11	28.9	4.45	33.0	5.14	37.1	5.92
	20	16.5	2.58	20.6	3.19	24.7	3.84	26.8	4.18	28.9	4.53	33.0	5.37	37.1	6.35
	21	16.5	2.60	20.6	3.22	24.7	3.88	26.8	4.22	28.9	4.63	33.0	5.56	37.1	6.58
	23	16.5	2.65	20.6	3.28	24.7	4.05	26.8	4.49	28.9	4.95	33.0	5.95	37.1	7.05
	25	16.5	2.69	20.6	3.45	24.7	4.32	26.8	4.79	28.9	5.29	33.0	6.37	36.9	7.47
	27	16.5	2.86	20.6	3.67	24.7	4.60	26.8	5.11	28.9	5.65	33.0	6.80	36.4	7.79
	29	16.5	3.03	20.6	3.90	24.7	4.90	26.8	5.44	28.9	6.02	33.0	7.26	35.8	8.10
	31	16.5	3.21	20.6	4.14	24.7	5.21	26.8	5.79	28.9	6.41	33.0	7.74	35.3	8.42
	33	16.5	3.39	20.6	4.40	24.7	5.54	26.8	6.16	28.9	6.82	33.0	8.25	34.7	8.74
	35	16.5	3.59	20.6	4.66	24.7	5.88	26.8	6.55	28.9	7.26	33.0	8.79	34.2	9.05
37	16.5	3.80	20.6	4.94	24.7	6.25	26.8	6.96	28.9	7.72	32.9	9.30	33.6	9.37	
39	16.5	4.01	20.6	5.24	24.7	6.63	26.8	7.40	28.9	8.21	32.3	9.61	33.1	9.7	
70% 23.45 kW	10	14.4	2.15	18.0	2.60	21.6	3.08	23.5	3.34	25.3	3.60	28.9	4.14	32.5	4.70
	12	14.4	2.17	18.0	2.64	21.6	3.13	23.5	3.39	25.3	3.66	28.9	4.21	32.5	4.79
	14	14.4	2.20	18.0	2.68	21.6	3.18	23.5	3.45	25.3	3.72	28.9	4.29	32.5	4.87
	16	14.4	2.23	18.0	2.72	21.6	3.24	23.5	3.51	25.3	3.79	28.9	4.37	32.5	4.96
	18	14.4	2.27	18.0	2.76	21.6	3.29	23.5	3.57	25.3	3.86	28.9	4.45	32.5	5.06
	20	14.4	2.30	18.0	2.81	21.6	3.35	23.5	3.64	25.3	3.93	28.9	4.53	32.5	5.26
	21	14.4	2.32	18.0	2.83	21.6	3.38	23.5	3.67	25.3	3.96	28.9	4.63	32.5	5.44
	23	14.4	2.35	18.0	2.88	21.6	3.44	23.5	3.79	25.3	4.16	28.9	4.95	32.5	5.82
	25	14.4	2.39	18.0	2.96	21.6	3.66	23.5	4.04	25.3	4.44	28.9	5.29	32.5	6.23
	27	14.4	2.49	18.0	3.15	21.6	3.89	23.5	4.30	25.3	4.73	28.9	5.65	32.5	6.65
	29	14.4	2.64	18.0	3.34	21.6	4.14	23.5	4.57	25.3	5.03	28.9	6.02	32.5	7.10
	31	14.4	2.79	18.0	3.54	21.6	4.40	23.5	4.86	25.3	5.35	28.9	6.41	32.5	7.57
	33	14.4	2.95	18.0	3.75	21.6	4.67	23.5	5.17	25.3	5.69	28.9	6.82	32.5	8.06
	35	14.4	3.11	18.0	3.97	21.6	4.95	23.5	5.49	25.3	6.05	28.9	7.26	32.5	8.59
37	14.4	3.28	18.0	4.21	21.6	5.25	23.5	5.82	25.3	6.42	28.9	7.72	32.5	9.14	
39	14.4	3.47	18.0	4.45	21.6	5.57	23.5	6.18	25.3	6.82	28.9	8.21	32.2	9.60	
60% 20.10 kW	10	12.4	1.90	15.5	2.27	18.6	2.67	20.1	2.87	21.6	3.08	24.7	3.53	27.8	3.98
	12	12.4	1.93	15.5	2.30	18.6	2.71	20.1	2.92	21.6	3.13	24.7	3.58	27.8	4.05
	14	12.4	1.95	15.5	2.33	18.6	2.75	20.1	2.96	21.6	3.18	24.7	3.64	27.8	4.12
	16	12.4	1.98	15.5	2.37	18.6	2.79	20.1	3.01	21.6	3.24	24.7	3.71	27.8	4.20
	18	12.4	2.00	15.5	2.40	18.6	2.83	20.1	3.06	21.6	3.29	24.7	3.77	27.8	4.28
	20	12.4	2.03	15.5	2.44	18.6	2.88	20.1	3.11	21.6	3.35	24.7	3.84	27.8	4.36
	21	12.4	2.04	15.5	2.46	18.6	2.91	20.1	3.14	21.6	3.38	24.7	3.88	27.8	4.41
	23	12.4	2.07	15.5	2.50	18.6	2.95	20.1	3.19	21.6	3.44	24.7	4.05	27.8	4.72
	25	12.4	2.10	15.5	2.54	18.6	3.06	20.1	3.35	21.6	3.66	24.7	4.32	27.8	5.04
	27	12.4	2.15	15.5	2.67	18.6	3.25	20.1	3.56	21.6	3.89	24.7	4.60	27.8	5.37
	29	12.4	2.27	15.5	2.83	18.6	3.45	20.1	3.79	21.6	4.14	24.7	4.90	27.8	5.73
	31	12.4	2.40	15.5	2.99	18.6	3.66	20.1	4.02	21.6	4.40	24.7	5.21	27.8	6.10
	33	12.4	2.53	15.5	3.17	18.6	3.88	20.1	4.26	21.6	4.67	24.7	5.54	27.8	6.49
	35	12.4	2.67	15.5	3.35	18.6	4.11	20.1	4.52	21.6	4.95	24.7	5.88	27.8	6.90
37	12.4	2.81	15.5	3.54	18.6	4.35	20.1	4.79	21.6	5.25	24.7	6.25	27.8	7.34	
39	12.4	2.97	15.5	3.73	18.6	4.60	20.1	5.07	21.6	5.57	24.7	6.63	27.8	7.80	
50% 16.75 kW	10	10.3	1.68	12.9	1.96	15.5	2.27	16.8	2.43	18.0	2.60	20.6	2.94	23.2	3.30
	12	10.3	1.70	12.9	1.99	15.5	2.30	16.8	2.47	18.0	2.64	20.6	2.99	23.2	3.36
	14	10.3	1.71	12.9	2.01	15.5	2.33	16.8	2.50	18.0	2.68	20.6	3.04	23.2	3.41
	16	10.3	1.73	12.9	2.04	15.5	2.37	16.8	2.54	18.0	2.72	20.6	3.09	23.2	3.47
	18	10.3	1.75	12.9	2.07	15.5	2.40	16.8	2.58	18.0	2.76	20.6	3.14	23.2	3.53
	20	10.3	1.77	12.9	2.09	15.5	2.44	16.8	2.62	18.0	2.81	20.6	3.19	23.2	3.59
	21	10.3	1.79	12.9	2.11	15.5	2.46	16.8	2.64	18.0	2.83	20.6	3.22	23.2	3.63
	23	10.3	1.81	12.9	2.14	15.5	2.50	16.8	2.68	18.0	2.88	20.6	3.28	23.2	3.74
	25	10.3	1.83	12.9	2.17	15.5	2.54	16.8	2.74	18.0	2.96	20.6	3.45	23.2	3.98
	27	10.3	1.86	12.9	2.23	15.5	2.67	16.8	2.90	18.0	3.15	20.6	3.67	23.2	4.24
	29	10.3	1.94	12.9	2.36	15.5	2.83	16.8	3.08	18.0	3.34	20.6	3.90	23.2	4.51
	31	10.3	2.05	12.9	2.49	15.5	2.99	16.8	3.26	18.0	3.54	20.6	4.14	23.2	4.80
	33	10.3	2.16	12.9	2.63	15.5	3.17	16.8	3.45	18.0	3.75	20.6	4.40	23.2	5.09
	35	10.3	2.27	12.9	2.78	15.5	3.35	16.8	3.65	18.0	3.97	20.6	4.66	23.2	5.41
37	10.3	2.39	12.9	2.93	15.5	3.54	16.8	3.86	18.0	4.21	20.6	4.94	23.2	5.74	
39	10.3	2.51	12.9	3.09	15.5	3.73	16.8	4.08	18.0	4.45	20.6	5.24	23.2	6.09	

3D079549

5 Таблицы производительности

5 - 1 Таблицы холодопроизводительности

RYYQ14T

TC : Total capacity (kW); PI : Power Input (kW) (Comp. + Outdoor fan motor)

Indoor air temp. °CWB															
Combination(%) (Capacity index)	Outdoor air temp. (°CDB)	14.0		16.0		18.0		19.0		20.0		22.0		24.0	
		TC	PI	TC	PI	TC	PI	TC	PI	TC	PI	TC	PI	TC	PI
		KW	KW	KW	KW	KW	KW	KW	KW	KW	KW	KW	KW	KW	KW
130% 52.00 kW	10	32.0	4.72	40.0	5.98	48.0	7.29	50.4	7.53	51.1	7.35	52.6	6.98	54.1	6.60
	12	32.0	4.80	40.0	6.08	48.0	7.42	49.7	7.49	50.5	7.31	52.0	6.93	53.5	6.94
	14	32.0	4.89	40.0	6.19	48.0	7.55	49.1	7.45	49.8	7.26	51.3	7.25	52.8	7.33
	16	32.0	4.97	40.0	6.30	47.7	7.60	48.4	7.52	49.2	7.56	50.7	7.64	52.2	7.73
	18	32.0	5.06	40.0	6.42	47.0	7.86	47.8	7.90	48.5	7.95	50.0	8.04	51.5	8.13
	20	32.0	5.15	40.0	6.73	46.4	8.2	47.1	8.3	47.9	8.3	49.4	8.4	50.9	8.5
	21	32.0	5.20	40.0	6.97	46.1	8.4	46.8	8.5	47.5	8.5	49.0	8.6	50.5	8.7
	23	32.0	5.53	40.0	7.46	45.4	8.8	46.1	8.9	46.9	8.9	48.4	9.0	49.9	9.1
	25	32.0	5.90	40.0	8.0	44.8	9.2	45.5	9.3	46.2	9.3	47.7	9.4	49.2	9.5
	27	32.0	6.29	40.0	8.5	44.1	9.6	44.8	9.6	45.6	9.7	47.1	9.8	48.6	9.9
	29	32.0	6.69	40.0	9.1	43.4	10.0	44.2	10.0	44.9	10.1	46.4	10.2	47.9	10.4
	31	32.0	7.12	40.0	9.7	42.8	10.4	43.5	10.4	44.3	10.5	45.8	10.6	47.3	10.8
	33	32.0	7.6	40.0	10.3	42.1	10.8	42.9	10.8	43.6	10.9	45.1	11.0	46.6	11.2
	35	32.0	8.0	40.0	11.0	41.5	11.1	42.2	11.2	43.0	11.3	44.5	11.4	46.0	11.6
	37	32.0	8.6	39.3	11.4	40.8	11.5	41.6	11.6	42.3	11.7	43.8	11.9	45.3	12.0
	39	32.0	9.1	38.7	11.8	40.2	11.9	40.9	12.0	41.7	12.1	43.2	12.3	44.7	12.4
120% 48.00 kW	10	29.5	4.36	36.9	5.49	44.3	6.68	48.0	7.29	50.3	7.54	51.7	7.21	53.1	6.86
	12	29.5	4.43	36.9	5.58	44.3	6.80	48.0	7.42	49.7	7.51	51.1	7.16	52.4	6.89
	14	29.5	4.50	36.9	5.68	44.3	6.92	48.0	7.55	49.0	7.47	50.4	7.20	51.8	7.28
	16	29.5	4.58	36.9	5.78	44.3	7.04	47.7	7.60	48.4	7.51	49.8	7.59	51.1	7.67
	18	29.5	4.66	36.9	5.89	44.3	7.25	47.0	7.86	47.7	7.90	49.1	7.98	50.5	8.07
	20	29.5	4.74	36.9	6.04	44.3	7.78	46.4	8.2	47.1	8.3	48.4	8.4	49.8	8.5
	21	29.5	4.78	36.9	6.25	44.3	8.06	46.1	8.4	46.7	8.5	48.1	8.6	49.5	8.7
	23	29.5	4.99	36.9	6.68	44.3	8.6	45.4	8.8	46.1	8.9	47.5	9.0	48.9	9.1
	25	29.5	5.32	36.9	7.14	44.1	9.1	44.8	9.2	45.4	9.3	46.8	9.4	48.2	9.5
	27	29.5	5.67	36.9	7.62	43.4	9.5	44.1	9.6	44.8	9.6	46.2	9.8	47.6	9.9
	29	29.5	6.03	36.9	8.1	42.8	9.9	43.4	10.0	44.1	10.0	45.5	10.1	46.9	10.3
	31	29.5	6.41	36.9	8.7	42.1	10.3	42.8	10.4	43.5	10.4	44.9	10.5	46.3	10.7
	33	29.5	6.82	36.9	9.2	41.5	10.7	42.1	10.8	42.8	10.8	44.2	11.0	45.6	11.1
	35	29.5	7.24	36.9	9.8	40.8	11.1	41.5	11.1	42.2	11.2	43.6	11.4	45.0	11.5
	37	29.5	7.7	36.9	10.4	40.2	11.5	40.8	11.5	41.5	11.6	42.9	11.8	44.3	11.9
	39	29.5	8.2	36.9	11.1	39.5	11.9	40.2	11.9	40.9	12.0	42.3	12.2	43.7	12.3
110% 44.00 kW	10	27.1	4.00	33.8	5.01	40.6	6.08	44.0	6.63	47.4	7.18	50.8	7.43	52.0	7.12
	12	27.1	4.06	33.8	5.09	40.6	6.18	44.0	6.74	47.4	7.31	50.1	7.39	51.4	7.08
	14	27.1	4.13	33.8	5.18	40.6	6.29	44.0	6.87	47.4	7.44	49.5	7.35	50.7	7.22
	16	27.1	4.20	33.8	5.27	40.6	6.41	44.0	6.99	47.4	7.58	48.8	7.54	50.1	7.61
	18	27.1	4.27	33.8	5.37	40.6	6.53	44.0	7.18	46.9	7.85	48.2	7.93	49.4	8.00
	20	27.1	4.34	33.8	5.47	40.6	6.88	44.0	7.70	46.3	8.2	47.5	8.3	48.8	8.4
	21	27.1	4.38	33.8	5.56	40.6	7.12	44.0	7.98	45.9	8.4	47.2	8.5	48.5	8.6
	23	27.1	4.49	33.8	5.95	40.6	7.62	44.0	8.5	45.3	8.8	46.6	8.9	47.8	9.0
	25	27.1	4.78	33.8	6.35	40.6	8.2	44.0	9.1	44.6	9.2	45.9	9.3	47.2	9.4
	27	27.1	5.09	33.8	6.77	40.6	8.7	43.4	9.5	44.0	9.6	45.3	9.7	46.5	9.8
	29	27.1	5.41	33.8	7.21	40.6	9.3	42.7	9.9	43.3	10.0	44.6	10.1	45.9	10.2
	31	27.1	5.75	33.8	7.68	40.6	9.9	42.0	10.3	42.7	10.4	43.9	10.5	45.2	10.6
	33	27.1	6.10	33.8	8.2	40.6	10.6	41.4	10.7	42.0	10.7	43.3	10.9	44.6	11.0
	35	27.1	6.47	33.8	8.7	40.1	11.0	40.7	11.1	41.4	11.1	42.6	11.3	43.9	11.4
	37	27.1	6.87	33.8	9.2	39.5	11.4	40.1	11.5	40.7	11.5	42.0	11.7	43.3	11.8
	39	27.1	7.28	33.8	9.8	38.8	11.8	39.4	11.9	40.1	11.9	41.3	12.1	42.6	12.2
100% 40.00 kW	10	24.6	3.65	30.8	4.54	36.9	5.49	40.0	5.98	43.1	6.48	49.2	7.49	51.0	7.38
	12	24.6	3.71	30.8	4.61	36.9	5.58	40.0	6.08	43.1	6.59	49.2	7.62	50.4	7.34
	14	24.6	3.76	30.8	4.69	36.9	5.68	40.0	6.19	43.1	6.71	48.6	7.58	49.7	7.29
	16	24.6	3.82	30.8	4.77	36.9	5.78	40.0	6.30	43.1	6.83	47.9	7.54	49.1	7.55
	18	24.6	3.89	30.8	4.86	36.9	5.89	40.0	6.42	43.1	6.96	47.3	7.87	48.4	7.94
	20	24.6	3.95	30.8	4.94	36.9	6.04	40.0	6.73	43.1	7.47	46.6	8.3	47.8	8.3
	21	24.6	3.99	30.8	4.99	36.9	6.25	40.0	6.97	43.1	7.74	46.3	8.4	47.4	8.5
	23	24.6	4.05	30.8	5.26	36.9	6.68	40.0	7.46	43.1	8.29	45.6	8.8	46.8	8.9
	25	24.6	4.27	30.8	5.61	36.9	7.14	40.0	7.98	43.1	8.9	45.0	9.2	46.1	9.3
	27	24.6	4.54	30.8	5.97	36.9	7.62	40.0	8.5	43.1	9.5	44.3	9.6	45.5	9.7
	29	24.6	4.82	30.8	6.36	36.9	8.12	40.0	9.1	42.5	9.9	43.7	10.0	44.8	10.1
	31	24.6	5.12	30.8	6.76	36.9	8.7	40.0	9.7	41.9	10.3	43.0	10.4	44.2	10.5
	33	24.6	5.43	30.8	7.19	36.9	9.2	40.0	10.3	41.2	10.7	42.4	10.8	43.5	10.9
	35	24.6	5.75	30.8	7.64	36.9	9.8	40.0	11.0	40.6	11.1	41.7	11.2	42.9	11.3
	37	24.6	6.10	30.8	8.1	36.9	10.4	39.3	11.4	39.9	11.4	41.1	11.6	42.2	11.7
	39	24.6	6.46	30.8	8.6	36.9	11.1	38.7	11.8	39.3	11.8	40.4	12.0	41.6	12.1

NOTES - ANMERKUNGEN - Σημειώσεις - NOTAS - REMARQUES - NOTE - OPMERKINGEN - примечания - NOTLAR

- The above table shows the average value of conditions which may occur.
Die obige Tabelle zeigt den Durchschnittswert der Bedingungen, die auftreten können.
 Στον παραπάνω πίνακα αναγράφεται η μέση τιμή για συνθήκες που μπορεί να προκύψουν.
La tabla de arriba muestra el valor medio de condiciones que pueden ocurrir.
 Le tableau ci-dessus donne la valeur moyenne pour des conditions qui peuvent survenir.
La tabella in alto mostra il valore delle condizioni medie che si possono riscontrare.
 De tabel hierboven geeft de gemiddelde waarde aan van situaties die kunnen voorvallen.
Таблица расположенная выше показывает среднее значение условий, которые могут наступить.
 Yukarıdaki tablo meydana gelebilecek koşulların ortalama değerini göstermektedir.

3D079549

5 Таблицы производительности

5 - 1 Таблицы холодопроизводительности

5

RYYQ14T															
Indoor air temp. °CWB															
Combination(%) (Capacity index)	Outdoor air temp. (°CDB)	14.0		16.0		18.0		19.0		20.0		22.0		24.0	
		TC	PI	TC	PI	TC	PI	TC	PI	TC	PI	TC	PI	TC	PI
		KW	KW	KW	KW	KW	KW	KW	KW	KW	KW	KW	KW	KW	KW
90% 36.00 kW	10	22.2	3.32	27.7	4.09	33.2	4.91	36.0	5.34	38.8	5.78	44.3	6.68	49.8	7.59
	12	22.2	3.36	27.7	4.15	33.2	4.99	36.0	5.43	38.8	5.88	44.3	6.80	49.3	7.59
	14	22.2	3.41	27.7	4.22	33.2	5.08	36.0	5.53	38.8	5.98	44.3	6.92	48.7	7.55
	16	22.2	3.47	27.7	4.29	33.2	5.17	36.0	5.63	38.8	6.09	44.3	7.04	48.0	7.51
	18	22.2	3.52	27.7	4.36	33.2	5.26	36.0	5.73	38.8	6.21	44.3	7.25	47.4	7.88
	20	22.2	3.58	27.7	4.44	33.2	5.36	36.0	5.84	38.8	6.45	44.3	7.78	46.7	8.3
	21	22.2	3.61	27.7	4.48	33.2	5.43	36.0	6.04	38.8	6.68	44.3	8.06	46.4	8.5
	23	22.2	3.67	27.7	4.61	33.2	5.80	36.0	6.46	38.8	7.14	44.3	8.6	45.7	8.8
	25	22.2	3.79	27.7	4.91	33.2	6.20	36.0	6.90	38.8	7.64	44.1	9.1	45.1	9.2
	27	22.2	4.03	27.7	5.23	33.2	6.61	36.0	7.36	38.8	8.15	43.4	9.5	44.4	9.6
	29	22.2	4.27	27.7	5.56	33.2	7.04	36.0	7.84	38.8	8.7	42.8	9.9	43.8	10.0
	31	22.2	4.53	27.7	5.91	33.2	7.49	36.0	8.4	38.8	9.3	42.1	10.3	43.1	10.4
33	22.2	4.80	27.7	6.28	33.2	7.97	36.0	8.9	38.8	9.9	41.5	10.7	42.5	10.8	
35	22.2	5.08	27.7	6.66	33.2	8.5	36.0	9.5	38.8	10.5	40.8	11.1	41.8	11.2	
37	22.2	5.38	27.7	7.07	33.2	9.0	36.0	10.1	38.8	11.2	40.2	11.5	41.2	11.6	
39	22.2	5.69	27.7	7.49	33.2	9.6	36.0	10.7	38.5	11.8	39.5	11.9	40.5	12.0	
80% 32.00 kW	10	19.7	2.99	24.6	3.65	29.5	4.36	32.0	4.72	34.5	5.10	39.4	5.88	44.3	6.68
	12	19.7	3.03	24.6	3.71	29.5	4.43	32.0	4.80	34.5	5.19	39.4	5.98	44.3	6.80
	14	19.7	3.08	24.6	3.76	29.5	4.50	32.0	4.89	34.5	5.28	39.4	6.09	44.3	6.92
	16	19.7	3.12	24.6	3.82	29.5	4.58	32.0	4.97	34.5	5.37	39.4	6.20	44.3	7.04
	18	19.7	3.17	24.6	3.89	29.5	4.66	32.0	5.06	34.5	5.47	39.4	6.31	44.3	7.25
	20	19.7	3.22	24.6	3.95	29.5	4.74	32.0	5.15	34.5	5.57	39.4	6.59	44.3	7.78
	21	19.7	3.24	24.6	3.99	29.5	4.78	32.0	5.20	34.5	5.70	39.4	6.82	44.3	8.06
	23	19.7	3.29	24.6	4.05	29.5	4.99	32.0	5.53	34.5	6.09	39.4	7.30	44.3	8.63
	25	19.7	3.35	24.6	4.27	29.5	5.32	32.0	5.90	34.5	6.50	39.4	7.81	44.1	9.1
	27	19.7	3.55	24.6	4.54	29.5	5.67	32.0	6.29	34.5	6.93	39.4	8.33	43.4	9.5
	29	19.7	3.76	24.6	4.82	29.5	6.03	32.0	6.69	34.5	7.39	39.4	8.9	42.8	9.9
	31	19.7	3.98	24.6	5.12	29.5	6.41	32.0	7.12	34.5	7.87	39.4	9.5	42.1	10.3
33	19.7	4.21	24.6	5.43	29.5	6.82	32.0	7.57	34.5	8.37	39.4	10.1	41.5	10.7	
35	19.7	4.45	24.6	5.75	29.5	7.24	32.0	8.05	34.5	8.9	39.4	10.8	40.8	11.1	
37	19.7	4.71	24.6	6.10	29.5	7.68	32.0	8.55	34.5	9.5	39.2	11.4	40.2	11.5	
39	19.7	4.97	24.6	6.46	29.5	8.15	32.0	9.08	34.5	10.1	38.6	11.8	39.5	11.9	
70% 28.00 kW	10	17.2	2.69	21.5	3.23	25.8	3.82	28.0	4.13	30.2	4.45	34.5	5.10	38.8	5.78
	12	17.2	2.72	21.5	3.28	25.8	3.88	28.0	4.20	30.2	4.52	34.5	5.19	38.8	5.88
	14	17.2	2.76	21.5	3.33	25.8	3.94	28.0	4.27	30.2	4.60	34.5	5.28	38.8	5.98
	16	17.2	2.79	21.5	3.38	25.8	4.01	28.0	4.34	30.2	4.67	34.5	5.37	38.8	6.09
	18	17.2	2.83	21.5	3.43	25.8	4.07	28.0	4.41	30.2	4.76	34.5	5.47	38.8	6.21
	20	17.2	2.87	21.5	3.48	25.8	4.14	28.0	4.49	30.2	4.84	34.5	5.57	38.8	6.45
	21	17.2	2.89	21.5	3.51	25.8	4.18	28.0	4.53	30.2	4.89	34.5	5.70	38.8	6.68
	23	17.2	2.93	21.5	3.57	25.8	4.25	28.0	4.68	30.2	5.12	34.5	6.09	38.8	7.14
	25	17.2	2.98	21.5	3.68	25.8	4.52	28.0	4.98	30.2	5.46	34.5	6.50	38.8	7.64
	27	17.2	3.10	21.5	3.91	25.8	4.81	28.0	5.30	30.2	5.82	34.5	6.93	38.8	8.15
	29	17.2	3.28	21.5	4.14	25.8	5.11	28.0	5.64	30.2	6.19	34.5	7.39	38.8	8.70
	31	17.2	3.47	21.5	4.39	25.8	5.43	28.0	5.99	30.2	6.59	34.5	7.87	38.8	9.3
33	17.2	3.67	21.5	4.65	25.8	5.76	28.0	6.36	30.2	7.00	34.5	8.37	38.8	9.9	
35	17.2	3.87	21.5	4.92	25.8	6.11	28.0	6.76	30.2	7.44	34.5	8.9	38.8	10.5	
37	17.2	4.09	21.5	5.21	25.8	6.48	28.0	7.17	30.2	7.90	34.5	9.5	38.8	11.2	
39	17.2	4.31	21.5	5.51	25.8	6.86	28.0	7.60	30.2	8.38	34.5	10.1	38.5	11.8	
60% 24.00 kW	10	14.8	2.39	18.5	2.84	22.2	3.32	24.0	3.57	25.8	3.82	29.5	4.36	33.2	4.91
	12	14.8	2.42	18.5	2.88	22.2	3.36	24.0	3.62	25.8	3.88	29.5	4.43	33.2	4.99
	14	14.8	2.45	18.5	2.91	22.2	3.41	24.0	3.68	25.8	3.94	29.5	4.50	33.2	5.08
	16	14.8	2.48	18.5	2.96	22.2	3.47	24.0	3.73	25.8	4.01	29.5	4.58	33.2	5.17
	18	14.8	2.51	18.5	3.00	22.2	3.52	24.0	3.79	25.8	4.07	29.5	4.66	33.2	5.26
	20	14.8	2.54	18.5	3.04	22.2	3.58	24.0	3.86	25.8	4.14	29.5	4.74	33.2	5.36
	21	14.8	2.56	18.5	3.06	22.2	3.61	24.0	3.89	25.8	4.18	29.5	4.78	33.2	5.43
	23	14.8	2.60	18.5	3.11	22.2	3.67	24.0	3.96	25.8	4.25	29.5	4.99	33.2	5.80
	25	14.8	2.63	18.5	3.16	22.2	3.79	24.0	4.15	25.8	4.52	29.5	5.32	33.2	6.20
	27	14.8	2.69	18.5	3.32	22.2	4.03	24.0	4.41	25.8	4.81	29.5	5.67	33.2	6.61
	29	14.8	2.84	18.5	3.52	22.2	4.27	24.0	4.68	25.8	5.11	29.5	6.03	33.2	7.04
	31	14.8	3.00	18.5	3.72	22.2	4.53	24.0	4.97	25.8	5.43	29.5	6.41	33.2	7.49
33	14.8	3.17	18.5	3.94	22.2	4.80	24.0	5.27	25.8	5.76	29.5	6.82	33.2	7.97	
35	14.8	3.34	18.5	4.16	22.2	5.08	24.0	5.58	25.8	6.11	29.5	7.24	33.2	8.47	
37	14.8	3.52	18.5	4.39	22.2	5.38	24.0	5.91	25.8	6.48	29.5	7.68	33.2	9.0	
39	14.8	3.70	18.5	4.64	22.2	5.69	24.0	6.26	25.8	6.86	29.5	8.15	33.2	9.6	
50% 20.00 kW	10	12.3	2.12	15.4	2.46	18.5	2.84	20.0	3.03	21.5	3.23	24.6	3.65	27.7	4.09
	12	12.3	2.14	15.4	2.49	18.5	2.88	20.0	3.07	21.5	3.28	24.6	3.71	27.7	4.15
	14	12.3	2.16	15.4	2.52	18.5	2.91	20.0	3.12	21.5	3.33	24.6	3.76	27.7	4.22
	16	12.3	2.19	15.4	2.56	18.5	2.96	20.0	3.16	21.5	3.38	24.6	3.82	27.7	4.29
	18	12.3	2.21	15.4	2.59	18.5	3.00	20.0	3.21	21.5	3.43	24.6	3.89	27.7	4.36
	20	12.3	2.24	15.4	2.62	18.5	3.04	20.0	3.26	21.5	3.48	24.6	3.95	27.7	4.44
	21	12.3	2.25	15.4	2.64	18.5	3.06	20.0	3.29	21.5	3.51	24.6	3.99	27.7	4.48
	23	12.3	2.28	15.4	2.68	18.5	3.11	20.0	3.34	21.5	3.57	24.6	4.05	27.7	4.61
	25	12.3	2.30	15.4	2.72	18.5	3.16	20.0	3.40	21.5	3.68	24.6	4.27	27.7	4.91
	27	12.3	2.33	15.4	2.79	18.5	3.32	20.0	3.61	21.5	3.91	24.6	4.54	27.7	5.23
	29	12.3	2.44	15.4	2.95	18.5	3.52	20.0	3.82	21.5	4.14	24.6	4.82	27.7	5.56
	31	12.3	2.57	15.4	3.12	18.5	3.72	20.0	4.05	21.5	4.39	24.6	5.12	27.7	5.91
33	12.3	2.71	15.4	3.29	18.5	3.94	20.0	4.28	21.5	4.65	24.6	5.43	27.7	6.28	
35	12.3	2.85	15.4	3.47	18.5	4.16	20.0	4.53	21.5	4.92	24.6	5.75	27.7	6.66	
37	12.3	2.99	15.4	3.65	18.5	4.39	20.0	4.79	21.5	5.21	24.6	6.10	27.7	7.07	
39	12.3	3.14	15.4	3.85	18.5	4.64	20.0	5.06	21.5	5.51	24.6	6.46	27.7	7.49	

3D079549

5 Таблицы производительности

5 - 1 Таблицы холодопроизводительности

RXYQ16T															
Indoor air temp. °CWB															
Combination(%) (Capacity index)	Outdoor air temp. (°CDB)	14.0		16.0		18.0		19.0		20.0		22.0		24.0	
		TC	PI	TC	PI	TC	PI	TC	PI	TC	PI	TC	PI	TC	PI
		KW	KW	KW	KW	KW	KW	KW	KW	KW	KW	KW	KW	KW	KW
130% 58.50 kW	10	36.0	5.58	45.0	7.06	54.0	8.6	56.7	8.9	57.5	8.7	59.2	8.2	60.9	7.80
	12	36.0	5.68	45.0	7.19	54.0	8.8	55.9	8.9	56.8	8.6	58.5	8.2	60.2	8.2
	14	36.0	5.77	45.0	7.32	54.0	8.9	55.2	8.8	56.1	8.6	57.7	8.6	59.4	8.7
	16	36.0	5.87	45.0	7.45	53.6	9.0	54.5	8.9	55.3	8.9	57.0	9.0	58.7	9.1
	18	36.0	5.98	45.0	7.59	52.9	9.3	53.7	9.3	54.6	9.4	56.3	9.5	58.0	9.6
	20	36.0	6.09	45.0	8.0	52.2	9.7	53.0	9.8	53.9	9.8	55.5	10.0	57.2	10.1
	21	36.0	6.14	45.0	8.2	51.8	10.0	52.7	10.0	53.5	10.1	55.2	10.2	56.9	10.3
	23	36.0	6.53	45.0	8.8	51.1	10.4	51.9	10.5	52.8	10.5	54.4	10.7	56.1	10.8
	25	36.0	6.97	45.0	9.4	50.3	10.9	51.2	10.9	52.0	11.0	53.7	11.1	55.4	11.3
	27	36.0	7.4	45.0	10.1	49.6	11.3	50.5	11.4	51.3	11.5	53.0	11.6	54.7	11.8
	29	36.0	7.9	45.0	10.7	48.9	11.8	49.7	11.9	50.6	11.9	52.2	12.1	53.9	12.2
	31	36.0	8.4	45.0	11.5	48.1	12.2	49.0	12.3	49.8	12.4	51.5	12.6	53.2	12.7
	33	36.0	9.0	45.0	12.2	47.4	12.7	48.3	12.8	49.1	12.9	50.8	13.0	52.5	13.2
	35	36.0	9.5	45.0	13.0	46.7	13.2	47.5	13.3	48.4	13.4	50.1	13.5	51.7	13.7
	37	36.0	10.1	44.3	13.5	46.0	13.6	46.8	13.7	47.6	13.8	49.3	14.0	51.0	14.2
	39	36.0	10.7	43.5	13.9	45.2	14.1	46.1	14.2	46.9	14.3	48.6	14.5	50.3	14.7
120% 54.00 kW	10	33.2	5.15	41.5	6.48	49.8	7.89	54.0	8.6	56.6	8.9	58.2	8.5	59.7	8.1
	12	33.2	5.23	41.5	6.60	49.8	8.03	54.0	8.8	55.9	8.9	57.4	8.5	59.0	8.1
	14	33.2	5.32	41.5	6.71	49.8	8.2	54.0	8.9	55.1	8.8	56.7	8.5	58.3	8.6
	16	33.2	5.41	41.5	6.83	49.8	8.3	53.6	9.0	54.4	8.9	56.0	9.0	57.5	9.1
	18	33.2	5.50	41.5	6.96	49.8	8.6	52.9	9.3	53.7	9.3	55.2	9.4	56.8	9.5
	20	33.2	5.60	41.5	7.13	49.8	9.2	52.2	9.7	53.0	9.8	54.5	9.9	56.1	10.0
	21	33.2	5.65	41.5	7.38	49.8	9.5	51.8	10.0	52.6	10.0	54.1	10.1	55.7	10.2
	23	33.2	5.90	41.5	7.9	49.8	10.2	51.1	10.4	51.9	10.5	53.4	10.6	55.0	10.7
	25	33.2	6.29	41.5	8.4	49.6	10.8	50.3	10.9	51.1	10.9	52.7	11.1	54.2	11.2
	27	33.2	6.70	41.5	9.0	48.8	11.3	49.6	11.3	50.4	11.4	51.9	11.5	53.5	11.7
	29	33.2	7.13	41.5	9.6	48.1	11.7	48.9	11.8	49.7	11.9	51.2	12.0	52.8	12.1
	31	33.2	7.6	41.5	10.2	47.4	12.2	48.1	12.2	48.9	12.3	50.5	12.5	52.0	12.6
	33	33.2	8.1	41.5	10.9	46.6	12.6	47.4	12.7	48.2	12.8	49.7	12.9	51.3	13.1
	35	33.2	8.6	41.5	11.6	45.9	13.1	46.7	13.2	47.5	13.3	49.0	13.4	50.6	13.6
	37	33.2	9.1	41.5	12.3	45.2	13.6	46.0	13.6	46.7	13.7	48.3	13.9	49.8	14.1
	39	33.2	9.6	41.5	13.1	44.4	14.0	45.2	14.1	46.0	14.2	47.6	14.4	49.1	14.6
110% 49.50 kW	10	30.5	4.72	38.1	5.92	45.7	7.18	49.5	7.83	53.3	8.5	57.1	8.8	58.6	8.4
	12	30.5	4.80	38.1	6.02	45.7	7.31	49.5	7.97	53.3	8.6	56.4	8.7	57.8	8.4
	14	30.5	4.88	38.1	6.12	45.7	7.44	49.5	8.11	53.3	8.8	55.7	8.7	57.1	8.5
	16	30.5	4.96	38.1	6.23	45.7	7.57	49.5	8.3	53.3	9.0	54.9	8.9	56.4	9.0
	18	30.5	5.04	38.1	6.34	45.7	7.71	49.5	8.5	52.8	9.3	54.2	9.4	55.6	9.5
	20	30.5	5.13	38.1	6.46	45.7	8.1	49.5	9.1	52.0	9.7	53.5	9.8	54.9	9.9
	21	30.5	5.17	38.1	6.57	45.7	8.4	49.5	9.4	51.7	10.0	53.1	10.1	54.5	10.2
	23	30.5	5.31	38.1	7.03	45.7	9.0	49.5	10.1	50.9	10.4	52.4	10.5	53.8	10.6
	25	30.5	5.65	38.1	7.50	45.7	9.6	49.5	10.8	50.2	10.9	51.6	11.0	53.1	11.1
	27	30.5	6.01	38.1	8.0	45.7	10.3	48.8	11.3	49.5	11.3	50.9	11.4	52.3	11.6
	29	30.5	6.39	38.1	8.5	45.7	11.0	48.0	11.7	48.8	11.8	50.2	11.9	51.6	12.0
	31	30.5	6.79	38.1	9.1	45.7	11.7	47.3	12.2	48.0	12.2	49.4	12.4	50.9	12.5
	33	30.5	7.21	38.1	9.7	45.7	12.5	46.6	12.6	47.3	12.7	48.7	12.8	50.1	13.0
	35	30.5	7.7	38.1	10.3	45.1	13.0	45.8	13.1	46.6	13.2	48.0	13.3	49.4	13.5
	37	30.5	8.1	38.1	10.9	44.4	13.5	45.1	13.6	45.8	13.6	47.2	13.8	48.7	13.9
	39	30.5	8.6	38.1	11.6	43.7	13.9	44.4	14.0	45.1	14.1	46.5	14.3	47.9	14.4
100% 45.00 kW	10	27.7	4.31	34.6	5.36	41.5	6.48	45.0	7.06	48.5	7.65	55.4	8.9	57.4	8.7
	12	27.7	4.38	34.6	5.45	41.5	6.60	45.0	7.19	48.5	7.79	55.4	9.0	56.7	8.7
	14	27.7	4.45	34.6	5.54	41.5	6.71	45.0	7.32	48.5	7.93	54.6	9.0	55.9	8.6
	16	27.7	4.52	34.6	5.64	41.5	6.83	45.0	7.45	48.5	8.07	53.9	8.9	55.2	8.9
	18	27.7	4.59	34.6	5.74	41.5	6.96	45.0	7.59	48.5	8.23	53.2	9.3	54.5	9.4
	20	27.7	4.67	34.6	5.84	41.5	7.13	45.0	7.96	48.5	8.8	52.4	9.8	53.7	9.8
	21	27.7	4.71	34.6	5.90	41.5	7.38	45.0	8.2	48.5	9.1	52.1	10.0	53.4	10.1
	23	27.7	4.79	34.6	6.21	41.5	7.90	45.0	8.8	48.5	9.8	51.3	10.4	52.6	10.5
	25	27.7	5.05	34.6	6.63	41.5	8.4	45.0	9.4	48.5	10.5	50.6	10.9	51.9	11.0
	27	27.7	5.37	34.6	7.06	41.5	9.0	45.0	10.1	48.5	11.2	49.9	11.3	51.2	11.5
	29	27.7	5.70	34.6	7.51	41.5	9.6	45.0	10.7	47.8	11.7	49.1	11.8	50.4	11.9
	31	27.7	6.05	34.6	8.0	41.5	10.2	45.0	11.5	47.1	12.2	48.4	12.3	49.7	12.4
	33	27.7	6.42	34.6	8.5	41.5	10.9	45.0	12.2	46.4	12.6	47.7	12.7	49.0	12.9
	35	27.7	6.80	34.6	9.0	41.5	11.6	45.0	13.0	45.6	13.1	46.9	13.2	48.2	13.3
	37	27.7	7.21	34.6	9.6	41.5	12.3	44.3	13.5	44.9	13.5	46.2	13.7	47.5	13.8
	39	27.7	7.6	34.6	10.2	41.5	13.1	43.5	13.9	44.2	14.0	45.5	14.1	46.8	14.3

TC : Total capacity (kW); PI : Power Input (kW) (Comp. + Outdoor fan motor)

Indoor air temp. °CWB

NOTES - ANMERKUNGEN - Σημειώσεις - NOTAS - REMARQUES - NOTE - OPMERKINGEN - примечания - NOTLAR

- The above table shows the average value of conditions which may occur.
Die obige Tabelle zeigt den Durchschnittswert der Bedingungen, die auftreten können.
 Στον παραπάνω πίνακα αναγράφεται η μέση τιμή για συνθήκες που μπορεί να προκύψουν.
La tabla de arriba muestra el valor medio de condiciones que pueden ocurrir.
 Le tableau ci-dessus donne la valeur moyenne pour des conditions qui peuvent survenir.
La tabella in alto mostra il valore delle condizioni medie che si possono riscontrare.
 De tabel hierboven geeft de gemiddelde waarde aan van situaties die kunnen voorvallen.
Таблица расположенная выше показывает среднее значение условий, которые могут наступить.
 Yukarıdaki tablo meydana gelebilecek koşulların ortalama değerini göstermektedir.

5 Таблицы производительности

5 - 1 Таблицы холодопроизводительности

5

RXYQ16T															
Indoor air temp. °CWB															
Combination(%) (Capacity index)	Outdoor air temp. (°CDB)	14.0		16.0		18.0		19.0		20.0		22.0		24.0	
		TC	PI	TC	PI	TC	PI	TC	PI	TC	PI	TC	PI	TC	PI
		KW	KW	KW	KW	KW	KW	KW	KW	KW	KW	KW	KW	KW	KW
90% 40.50 kW	10	24.9	3.92	31.2	4.83	37.4	5.80	40.5	6.31	43.6	6.83	49.8	7.89	56.1	9.0
	12	24.9	3.97	31.2	4.91	37.4	5.90	40.5	6.42	43.6	6.95	49.8	8.03	55.5	9.0
	14	24.9	4.03	31.2	4.99	37.4	6.00	40.5	6.53	43.6	7.07	49.8	8.18	54.8	8.9
	16	24.9	4.10	31.2	5.07	37.4	6.11	40.5	6.65	43.6	7.20	49.8	8.33	54.0	8.9
	18	24.9	4.16	31.2	5.16	37.4	6.22	40.5	6.77	43.6	7.33	49.8	8.6	53.3	9.3
	20	24.9	4.23	31.2	5.25	37.4	6.33	40.5	6.90	43.6	7.62	49.8	9.2	52.6	9.8
	21	24.9	4.26	31.2	5.29	37.4	6.42	40.5	7.13	43.6	7.89	49.8	9.5	52.2	10.0
	23	24.9	4.33	31.2	5.45	37.4	6.86	40.5	7.63	43.6	8.4	49.8	10.2	51.5	10.4
	25	24.9	4.48	31.2	5.81	37.4	7.32	40.5	8.15	43.6	9.0	49.6	10.8	50.7	10.9
	27	24.9	4.76	31.2	6.18	37.4	7.81	40.5	8.7	43.6	9.6	48.8	11.3	50.0	11.4
	29	24.9	5.05	31.2	6.57	37.4	8.3	40.5	9.3	43.6	10.3	48.1	11.7	49.3	11.8
	31	24.9	5.35	31.2	6.99	37.4	8.9	40.5	9.9	43.6	11.0	47.4	12.2	48.5	12.3
	33	24.9	5.67	31.2	7.42	37.4	9.4	40.5	10.5	43.6	11.7	46.6	12.6	47.8	12.8
	35	24.9	6.01	31.2	7.9	37.4	10.0	40.5	11.2	43.6	12.4	45.9	13.1	47.1	13.2
37	24.9	6.36	31.2	8.4	37.4	10.6	40.5	11.9	43.6	13.2	45.2	13.6	46.3	13.7	
39	24.9	6.72	31.2	8.9	37.4	11.3	40.5	12.6	43.3	13.9	44.4	14.0	45.6	14.2	
80% 36.00 kW	10	22.2	3.54	27.7	4.31	33.2	5.15	36.0	5.58	38.8	6.03	44.3	6.95	49.8	7.89
	12	22.2	3.59	27.7	4.38	33.2	5.23	36.0	5.68	38.8	6.13	44.3	7.07	49.8	8.03
	14	22.2	3.64	27.7	4.45	33.2	5.32	36.0	5.77	38.8	6.24	44.3	7.19	49.8	8.18
	16	22.2	3.69	27.7	4.52	33.2	5.41	36.0	5.87	38.8	6.35	44.3	7.32	49.8	8.33
	18	22.2	3.74	27.7	4.59	33.2	5.50	36.0	5.98	38.8	6.46	44.3	7.46	49.8	8.56
	20	22.2	3.80	27.7	4.67	33.2	5.60	36.0	6.09	38.8	6.58	44.3	7.79	49.8	9.2
	21	22.2	3.83	27.7	4.71	33.2	5.65	36.0	6.14	38.8	6.73	44.3	8.06	49.8	9.5
	23	22.2	3.89	27.7	4.79	33.2	5.90	36.0	6.53	38.8	7.20	44.3	8.6	49.8	10.2
	25	22.2	3.96	27.7	5.05	33.2	6.29	36.0	6.97	38.8	7.68	44.3	9.2	49.6	10.8
	27	22.2	4.19	27.7	5.37	33.2	6.70	36.0	7.43	38.8	8.20	44.3	9.8	48.8	11.3
	29	22.2	4.45	27.7	5.70	33.2	7.13	36.0	7.91	38.8	8.7	44.3	10.5	48.1	11.7
	31	22.2	4.71	27.7	6.05	33.2	7.58	36.0	8.4	38.8	9.3	44.3	11.2	47.4	12.2
	33	22.2	4.98	27.7	6.42	33.2	8.06	36.0	9.0	38.8	9.9	44.3	11.9	46.6	12.6
	35	22.2	5.26	27.7	6.80	33.2	8.6	36.0	9.5	38.8	10.5	44.3	12.7	45.9	13.1
37	22.2	5.56	27.7	7.21	33.2	9.1	36.0	10.1	38.8	11.2	44.1	13.4	45.2	13.6	
39	22.2	5.88	27.7	7.63	33.2	9.6	36.0	10.7	38.8	11.9	43.4	13.9	44.4	14.0	
70% 31.50 kW	10	19.4	3.17	24.2	3.82	29.1	4.52	31.5	4.88	33.9	5.26	38.8	6.03	43.6	6.83
	12	19.4	3.21	24.2	3.88	29.1	4.59	31.5	4.96	33.9	5.34	38.8	6.13	43.6	6.95
	14	19.4	3.26	24.2	3.93	29.1	4.66	31.5	5.04	33.9	5.43	38.8	6.24	43.6	7.07
	16	19.4	3.30	24.2	3.99	29.1	4.74	31.5	5.13	33.9	5.52	38.8	6.35	43.6	7.20
	18	19.4	3.35	24.2	4.05	29.1	4.82	31.5	5.21	33.9	5.62	38.8	6.46	43.6	7.33
	20	19.4	3.39	24.2	4.12	29.1	4.90	31.5	5.31	33.9	5.72	38.8	6.58	43.6	7.56
	21	19.4	3.42	24.2	4.15	29.1	4.94	31.5	5.35	33.9	5.77	38.8	6.73	43.6	7.89
	23	19.4	3.47	24.2	4.22	29.1	5.03	31.5	5.53	33.9	6.06	38.8	7.20	43.6	8.44
	25	19.4	3.52	24.2	4.35	29.1	5.35	31.5	5.89	33.9	6.46	38.8	7.68	43.6	9.0
	27	19.4	3.67	24.2	4.62	29.1	5.69	31.5	6.27	33.9	6.88	38.8	8.20	43.6	9.6
	29	19.4	3.88	24.2	4.90	29.1	6.04	31.5	6.67	33.9	7.32	38.8	8.7	43.6	10.3
	31	19.4	4.10	24.2	5.19	29.1	6.42	31.5	7.08	33.9	7.79	38.8	9.3	43.6	11.0
	33	19.4	4.34	24.2	5.49	29.1	6.81	31.5	7.52	33.9	8.27	38.8	9.9	43.6	11.7
	35	19.4	4.58	24.2	5.82	29.1	7.22	31.5	7.98	33.9	8.8	38.8	10.5	43.6	12.4
37	19.4	4.83	24.2	6.15	29.1	7.65	31.5	8.5	33.9	9.3	38.8	11.2	43.6	13.2	
39	19.4	5.09	24.2	6.51	29.1	8.11	31.5	9.0	33.9	9.9	38.8	11.9	43.3	13.9	
60% 27.00 kW	10	16.6	2.83	20.8	3.35	24.9	3.92	27.0	4.21	29.1	4.52	33.2	5.15	37.4	5.80
	12	16.6	2.86	20.8	3.40	24.9	3.97	27.0	4.28	29.1	4.59	33.2	5.23	37.4	5.90
	14	16.6	2.90	20.8	3.44	24.9	4.03	27.0	4.34	29.1	4.66	33.2	5.32	37.4	6.00
	16	16.6	2.93	20.8	3.49	24.9	4.10	27.0	4.41	29.1	4.74	33.2	5.41	37.4	6.11
	18	16.6	2.97	20.8	3.54	24.9	4.16	27.0	4.48	29.1	4.82	33.2	5.50	37.4	6.22
	20	16.6	3.01	20.8	3.59	24.9	4.23	27.0	4.56	29.1	4.90	33.2	5.60	37.4	6.33
	21	16.6	3.03	20.8	3.62	24.9	4.26	27.0	4.60	29.1	4.94	33.2	5.65	37.4	6.42
	23	16.6	3.07	20.8	3.68	24.9	4.33	27.0	4.68	29.1	5.03	33.2	5.90	37.4	6.86
	25	16.6	3.11	20.8	3.73	24.9	4.48	27.0	4.90	29.1	5.35	33.2	6.29	37.4	7.32
	27	16.6	3.18	20.8	3.93	24.9	4.76	27.0	5.21	29.1	5.69	33.2	6.70	37.4	7.81
	29	16.6	3.36	20.8	4.16	24.9	5.05	27.0	5.53	29.1	6.04	33.2	7.13	37.4	8.32
	31	16.6	3.55	20.8	4.40	24.9	5.35	27.0	5.87	29.1	6.42	33.2	7.58	37.4	8.9
	33	16.6	3.74	20.8	4.65	24.9	5.67	27.0	6.23	29.1	6.81	33.2	8.06	37.4	9.4
	35	16.6	3.94	20.8	4.91	24.9	6.01	27.0	6.60	29.1	7.22	33.2	8.55	37.4	10.0
37	16.6	4.15	20.8	5.19	24.9	6.36	27.0	6.99	29.1	7.65	33.2	9.1	37.4	10.6	
39	16.6	4.37	20.8	5.48	24.9	6.72	27.0	7.40	29.1	8.11	33.2	9.6	37.4	11.3	
50% 22.50 kW	10	13.8	2.50	17.3	2.91	20.8	3.35	22.5	3.58	24.2	3.82	27.7	4.31	31.2	4.83
	12	13.8	2.53	17.3	2.95	20.8	3.40	22.5	3.63	24.2	3.88	27.7	4.38	31.2	4.91
	14	13.8	2.56	17.3	2.98	20.8	3.44	22.5	3.69	24.2	3.93	27.7	4.45	31.2	4.99
	16	13.8	2.58	17.3	3.02	20.8	3.49	22.5	3.74	24.2	3.99	27.7	4.52	31.2	5.07
	18	13.8	2.61	17.3	3.06	20.8	3.54	22.5	3.79	24.2	4.05	27.7	4.59	31.2	5.16
	20	13.8	2.64	17.3	3.10	20.8	3.59	22.5	3.85	24.2	4.12	27.7	4.67	31.2	5.25
	21	13.8	2.66	17.3	3.12	20.8	3.62	22.5	3.88	24.2	4.15	27.7	4.71	31.2	5.29
	23	13.8	2.69	17.3	3.17	20.8	3.68	22.5	3.94	24.2	4.22	27.7	4.79	31.2	5.45
	25	13.8	2.72	17.3	3.21	20.8	3.73	22.5	4.02	24.2	4.35	27.7	5.05	31.2	5.81
	27	13.8	2.76	17.3	3.30	20.8	3.93	22.5	4.26	24.2	4.62	27.7	5.37	31.2	6.18
	29	13.8	2.89	17.3	3.49	20.8	4.16	22.5	4.52	24.2	4.90	27.7	5.70	31.2	6.57
	31	13.8	3.04	17.3	3.68	20.8	4.40	22.5	4.78	24.2	5.19	27.7	6.05	31.2	6.99
	33	13.8	3.20	17.3	3.89	20.8	4.65	22.5	5.06	24.2	5.49	27.7	6.42	31.2	7.42
	35	13.8	3.37	17.3	4.10	20.8	4.91	22.5	5.35	24.2	5.82	27.7	6.80	31.2	7.87
37	13.8	3.54	17.3	4.32	20.8	5.19	22.5	5.66	24.2	6.15	27.7	7.21	31.2	8.35	
39	13.8	3.72	17.3	4.55	20.8	5.48	22.5	5.98	24.2	6.51	27.7	7.63	31.2	8.9	

3D079549

5 Таблицы производительности

5 - 1 Таблицы холодопроизводительности

RXYQ18T															
Indoor air temp. °CWB															
Combination(%) (Capacity index)	Outdoor air temp. (°CDB)	14.0		16.0		18.0		19.0		20.0		22.0		24.0	
		TC	PI	TC	PI	TC	PI	TC	PI	TC	PI	TC	PI	TC	PI
		KW	KW	KW	KW	KW	KW	KW	KW	KW	KW	KW	KW	KW	KW
130% 65.00 kW	10	40.0	6.31	50.0	7.99	60.0	9.7	63.0	10.1	63.9	9.8	65.8	9.33	67.7	8.82
	12	40.0	6.42	50.0	8.13	60.0	9.9	62.2	10.0	63.1	9.8	65.0	9.26	66.8	9.27
	14	40.0	6.53	50.0	8.27	60.0	10.1	61.3	10.0	62.3	9.7	64.2	9.7	66.0	9.8
	16	40.0	6.64	50.0	8.42	59.6	10.2	60.5	10.0	61.5	10.1	63.3	10.2	65.2	10.3
	18	40.0	6.76	50.0	8.58	58.8	10.5	59.7	10.6	60.7	10.6	62.5	10.7	64.4	10.9
	20	40.0	6.88	50.0	9.00	58.0	11.0	58.9	11.1	59.8	11.1	61.7	11.3	63.6	11.4
	21	40.0	6.95	50.0	9.3	57.6	11.3	58.5	11.3	59.4	11.4	61.3	11.5	63.2	11.7
	23	40.0	7.39	50.0	10.0	56.8	11.8	57.7	11.8	58.6	11.9	60.5	12.1	62.4	12.2
	25	40.0	7.88	50.0	10.7	55.9	12.3	56.9	12.4	57.8	12.4	59.7	12.6	61.6	12.7
	27	40.0	8.40	50.0	11.4	55.1	12.8	56.1	12.9	57.0	13.0	58.9	13.1	60.7	13.3
	29	40.0	8.9	50.0	12.1	54.3	13.3	55.2	13.4	56.2	13.5	58.1	13.7	59.9	13.8
	31	40.0	9.5	50.0	13.0	53.5	13.9	54.4	13.9	55.4	14.0	57.2	14.2	59.1	14.4
	33	40.0	10.1	50.0	13.8	52.7	14.4	53.6	14.5	54.6	14.6	56.4	14.8	58.3	14.9
	35	40.0	10.8	50.0	14.7	51.9	14.9	52.8	15.0	53.7	15.1	55.6	15.3	57.5	15.5
	37	40.0	11.4	49.2	15.2	51.1	15.4	52.0	15.5	52.9	15.6	54.8	15.8	56.7	16.1
	39	40.0	12.1	48.4	15.7	50.2	16.0	51.2	16.1	52.1	16.2	54.0	16.4	55.9	16.6
120% 60.00 kW	10	36.9	5.82	46.2	7.33	55.4	8.92	60.0	9.7	62.9	10.1	64.6	9.6	66.4	9.17
	12	36.9	5.92	46.2	7.46	55.4	9.08	60.0	9.9	62.1	10.0	63.8	9.6	65.5	9.20
	14	36.9	6.01	46.2	7.59	55.4	9.24	60.0	10.1	61.3	10.0	63.0	9.6	64.7	9.7
	16	36.9	6.12	46.2	7.73	55.4	9.41	59.6	10.2	60.5	10.0	62.2	10.1	63.9	10.3
	18	36.9	6.22	46.2	7.87	55.4	9.7	58.8	10.5	59.6	10.6	61.4	10.7	63.1	10.8
	20	36.9	6.34	46.2	8.07	55.4	10.4	58.0	11.0	58.8	11.1	60.6	11.2	62.3	11.3
	21	36.9	6.39	46.2	8.35	55.4	10.8	57.6	11.3	58.4	11.3	60.2	11.4	61.9	11.6
	23	36.9	6.67	46.2	8.93	55.4	11.5	56.8	11.8	57.6	11.8	59.3	12.0	61.1	12.1
	25	36.9	7.11	46.2	9.5	55.1	12.2	55.9	12.3	56.8	12.4	58.5	12.5	60.3	12.6
	27	36.9	7.58	46.2	10.2	54.3	12.7	55.1	12.8	56.0	12.9	57.7	13.0	59.4	13.2
	29	36.9	8.06	46.2	10.9	53.4	13.3	54.3	13.3	55.2	13.4	56.9	13.6	58.6	13.7
	31	36.9	8.57	46.2	11.6	52.6	13.8	53.5	13.9	54.4	13.9	56.1	14.1	57.8	14.3
	33	36.9	9.1	46.2	12.3	51.8	14.3	52.7	14.4	53.5	14.5	55.3	14.6	57.0	14.8
	35	36.9	9.7	46.2	13.1	51.0	14.8	51.9	14.9	52.7	15.0	54.5	15.2	56.2	15.4
	37	36.9	10.3	46.2	13.9	50.2	15.3	51.1	15.4	51.9	15.5	53.6	15.7	55.4	15.9
	39	36.9	10.9	46.2	14.8	49.4	15.9	50.2	16.0	51.1	16.1	52.8	16.3	54.6	16.5
110% 55.00 kW	10	33.8	5.34	42.3	6.69	50.8	8.12	55.0	8.86	59.2	9.60	63.5	9.9	65.1	9.5
	12	33.8	5.43	42.3	6.80	50.8	8.26	55.0	9.01	59.2	9.8	62.7	9.9	64.2	9.5
	14	33.8	5.51	42.3	6.92	50.8	8.41	55.0	9.17	59.2	9.9	61.9	9.8	63.4	9.7
	16	33.8	5.61	42.3	7.04	50.8	8.56	55.0	9.34	59.2	10.1	61.0	10.1	62.6	10.2
	18	33.8	5.70	42.3	7.17	50.8	8.72	55.0	9.59	58.6	10.5	60.2	10.6	61.8	10.7
	20	33.8	5.80	42.3	7.30	50.8	9.19	55.0	10.3	57.8	11.0	59.4	11.1	61.0	11.2
	21	33.8	5.85	42.3	7.43	50.8	9.5	55.0	10.7	57.4	11.3	59.0	11.4	60.6	11.5
	23	33.8	6.00	42.3	7.95	50.8	10.2	55.0	11.4	56.6	11.8	58.2	11.9	59.8	12.0
	25	33.8	6.39	42.3	8.48	50.8	10.9	55.0	12.2	55.8	12.3	57.4	12.4	59.0	12.5
	27	33.8	6.80	42.3	9.05	50.8	11.6	54.2	12.7	55.0	12.8	56.6	12.9	58.1	13.1
	29	33.8	7.23	42.3	9.6	50.8	12.4	53.4	13.2	54.2	13.3	55.8	13.5	57.3	13.6
	31	33.8	7.68	42.3	10.3	50.8	13.2	52.6	13.8	53.4	13.8	54.9	14.0	56.5	14.1
	33	33.8	8.15	42.3	10.9	50.8	14.1	51.7	14.3	52.5	14.4	54.1	14.5	55.7	14.7
	35	33.8	8.65	42.3	11.6	50.1	14.7	50.9	14.8	51.7	14.9	53.3	15.1	54.9	15.2
	37	33.8	9.2	42.3	12.3	49.3	15.2	50.1	15.3	50.9	15.4	52.5	15.6	54.1	15.8
	39	33.8	9.7	42.3	13.1	48.5	15.8	49.3	15.8	50.1	15.9	51.7	16.1	53.3	16.3
100% 50.00 kW	10	30.8	4.88	38.5	6.07	46.2	7.33	50.0	7.99	53.8	8.65	61.5	10.0	63.8	9.9
	12	30.8	4.95	38.5	6.17	46.2	7.46	50.0	8.13	53.8	8.81	61.5	10.2	63.0	9.8
	14	30.8	5.03	38.5	6.27	46.2	7.59	50.0	8.27	53.8	8.97	60.7	10.1	62.1	9.7
	16	30.8	5.11	38.5	6.38	46.2	7.73	50.0	8.42	53.8	9.13	59.9	10.1	61.3	10.1
	18	30.8	5.19	38.5	6.49	46.2	7.87	50.0	8.58	53.8	9.30	59.1	10.5	60.5	10.6
	20	30.8	5.28	38.5	6.61	46.2	8.07	50.0	9.00	53.8	10.0	58.3	11.0	59.7	11.1
	21	30.8	5.33	38.5	6.67	46.2	8.35	50.0	9.32	53.8	10.3	57.9	11.3	59.3	11.4
	23	30.8	5.42	38.5	7.02	46.2	8.93	50.0	10.0	53.8	11.1	57.0	11.8	58.5	11.9
	25	30.8	5.71	38.5	7.49	46.2	9.54	50.0	10.7	53.8	11.8	56.2	12.3	57.7	12.4
	27	30.8	6.07	38.5	7.98	46.2	10.2	50.0	11.4	53.8	12.7	55.4	12.8	56.9	13.0
	29	30.8	6.45	38.5	8.50	46.2	10.9	50.0	12.1	53.2	13.2	54.6	13.4	56.0	13.5
	31	30.8	6.84	38.5	9.04	46.2	11.6	50.0	13.0	52.3	13.7	53.8	13.9	55.2	14.0
	33	30.8	7.26	38.5	9.6	46.2	12.3	50.0	13.8	51.5	14.3	53.0	14.4	54.4	14.5
	35	30.8	7.69	38.5	10.2	46.2	13.1	50.0	14.7	50.7	14.8	52.2	14.9	53.6	15.1
	37	30.8	8.15	38.5	10.8	46.2	13.9	49.2	15.2	49.9	15.3	51.3	15.5	52.8	15.6
	39	30.8	8.63	38.5	11.5	46.2	14.8	48.4	15.7	49.1	15.8	50.5	16.0	52.0	16.2

NOTES - ANMERKUNGEN - Σημειώσεις - NOTAS - REMARQUES - NOTE - OPMERKINGEN - примечания - NOTLAR

- The above table shows the average value of conditions which may occur.
Die obige Tabelle zeigt den Durchschnittswert der Bedingungen, die auftreten können.
 Στον παραπάνω πίνακα αναγράφεται η μέση τιμή για συνθήκες που μπορεί να προκύψουν.
La tabla de arriba muestra el valor medio de condiciones que pueden ocurrir.
 Le tableau ci-dessus donne la valeur moyenne pour des conditions qui peuvent survenir.
La tabella in alto mostra il valore delle condizioni medie che si possono riscontrare.
 De tabel hierboven geeft de gemiddelde waarde aan van situaties die kunnen voorvallen.
Таблица расположенная выше показывает среднее значение условий, которые могут наступить.
 Yukarıdaki tablo meydana gelebilecek koşulların ortalama değerini göstermektedir.

3D079549

5 Таблицы производительности

5 - 1 Таблицы холодопроизводительности

5

RXYQ18T															
Indoor air temp. °CWB															
Combination(%) (Capacity index)	Outdoor air temp. (°CDB)	14.0		16.0		18.0		19.0		20.0		22.0		24.0	
		TC	PI	TC	PI	TC	PI	TC	PI	TC	PI	TC	PI	TC	PI
		KW	KW	KW	KW	KW	KW	KW	KW	KW	KW	KW	KW	KW	KW
90% 45.00 kW	10	27.7	4.43	34.6	5.46	41.5	6.56	45.0	7.14	48.5	7.72	55.4	8.92	62.3	10.1
	12	27.7	4.49	34.6	5.55	41.5	6.67	45.0	7.26	48.5	7.86	55.4	9.08	61.7	10.1
	14	27.7	4.56	34.6	5.64	41.5	6.79	45.0	7.39	48.5	8.00	55.4	9.24	60.8	10.1
	16	27.7	4.63	34.6	5.73	41.5	6.91	45.0	7.52	48.5	8.14	55.4	9.41	60.0	10.0
	18	27.7	4.70	34.6	5.83	41.5	7.03	45.0	7.66	48.5	8.29	55.4	9.68	59.2	10.5
	20	27.7	4.78	34.6	5.93	41.5	7.16	45.0	7.80	48.5	8.62	55.4	10.4	58.4	11.0
	21	27.7	4.82	34.6	5.98	41.5	7.26	45.0	8.07	48.5	8.92	55.4	10.8	58.0	11.3
	23	27.7	4.90	34.6	6.16	41.5	7.76	45.0	8.63	48.5	9.55	55.4	11.5	57.2	11.8
	25	27.7	5.07	34.6	6.57	41.5	8.28	45.0	9.21	48.5	10.2	55.1	12.2	56.4	12.3
	27	27.7	5.38	34.6	6.99	41.5	8.83	45.0	9.8	48.5	10.9	54.3	12.7	55.6	12.8
	29	27.7	5.71	34.6	7.43	41.5	9.40	45.0	10.5	48.5	11.6	53.4	13.3	54.7	13.4
	31	27.7	6.06	34.6	7.90	41.5	10.0	45.0	11.2	48.5	12.4	52.6	13.8	53.9	13.9
	33	27.7	6.41	34.6	8.39	41.5	10.6	45.0	11.9	48.5	13.2	51.8	14.3	53.1	14.4
	35	27.7	6.79	34.6	8.90	41.5	11.3	45.0	12.6	48.5	14.1	51.0	14.8	52.3	14.9
	37	27.7	7.19	34.6	9.4	41.5	12.0	45.0	13.5	48.5	15.0	50.2	15.3	51.5	15.5
	39	27.7	7.60	34.6	10.0	41.5	12.8	45.0	14.3	48.1	15.7	49.4	15.9	50.7	16.0
80% 40.00 kW	10	24.6	4.00	30.8	4.88	36.9	5.82	40.0	6.31	43.1	6.82	49.2	7.85	55.4	8.92
	12	24.6	4.06	30.8	4.95	36.9	5.92	40.0	6.42	43.1	6.93	49.2	7.99	55.4	9.08
	14	24.6	4.11	30.8	5.03	36.9	6.01	40.0	6.53	43.1	7.05	49.2	8.13	55.4	9.24
	16	24.6	4.17	30.8	5.11	36.9	6.12	40.0	6.64	43.1	7.18	49.2	8.28	55.4	9.41
	18	24.6	4.23	30.8	5.19	36.9	6.22	40.0	6.76	43.1	7.31	49.2	8.44	55.4	9.68
	20	24.6	4.30	30.8	5.28	36.9	6.34	40.0	6.88	43.1	7.44	49.2	8.61	55.4	10.4
	21	24.6	4.33	30.8	5.33	36.9	6.39	40.0	6.95	43.1	7.61	49.2	9.12	55.4	10.8
	23	24.6	4.40	30.8	5.42	36.9	6.67	40.0	7.39	43.1	8.14	49.2	9.76	55.4	11.5
	25	24.6	4.47	30.8	5.71	36.9	7.11	40.0	7.88	43.1	8.69	49.2	10.4	55.1	12.2
	27	24.6	4.74	30.8	6.07	36.9	7.58	40.0	8.40	43.1	9.27	49.2	11.1	54.3	12.7
	29	24.6	5.03	30.8	6.45	36.9	8.06	40.0	8.94	43.1	9.87	49.2	11.9	53.4	13.3
	31	24.6	5.32	30.8	6.84	36.9	8.57	40.0	9.52	43.1	10.5	49.2	12.7	52.6	13.8
	33	24.6	5.63	30.8	7.26	36.9	9.11	40.0	10.1	43.1	11.2	49.2	13.5	51.8	14.3
	35	24.6	5.95	30.8	7.69	36.9	9.7	40.0	10.8	43.1	11.9	49.2	14.4	51.0	14.8
	37	24.6	6.29	30.8	8.15	36.9	10.3	40.0	11.4	43.1	12.7	49.0	15.2	50.2	15.3
	39	24.6	6.65	30.8	8.63	36.9	10.9	40.0	12.1	43.1	13.4	48.2	15.7	49.4	15.9
70% 35.00 kW	10	21.5	3.59	26.9	4.32	32.3	5.11	35.0	5.52	37.7	5.94	43.1	6.82	48.5	7.72
	12	21.5	3.63	26.9	4.38	32.3	5.19	35.0	5.61	37.7	6.04	43.1	6.93	48.5	7.86
	14	21.5	3.68	26.9	4.45	32.3	5.27	35.0	5.70	37.7	6.14	43.1	7.05	48.5	8.00
	16	21.5	3.73	26.9	4.51	32.3	5.36	35.0	5.80	37.7	6.25	43.1	7.18	48.5	8.14
	18	21.5	3.78	26.9	4.58	32.3	5.45	35.0	5.90	37.7	6.36	43.1	7.31	48.5	8.29
	20	21.5	3.84	26.9	4.66	32.3	5.54	35.0	6.00	37.7	6.47	43.1	7.44	48.5	8.62
	21	21.5	3.86	26.9	4.69	32.3	5.59	35.0	6.05	37.7	6.53	43.1	7.61	48.5	8.92
	23	21.5	3.92	26.9	4.77	32.3	5.69	35.0	6.25	37.7	6.85	43.1	8.14	48.5	9.55
	25	21.5	3.98	26.9	4.92	32.3	6.05	35.0	6.66	37.7	7.30	43.1	8.69	48.5	10.20
	27	21.5	4.15	26.9	5.22	32.3	6.43	35.0	7.09	37.7	7.78	43.1	9.27	48.5	10.9
	29	21.5	4.39	26.9	5.54	32.3	6.83	35.0	7.54	37.7	8.28	43.1	9.87	48.5	11.6
	31	21.5	4.64	26.9	5.87	32.3	7.25	35.0	8.01	37.7	8.80	43.1	10.5	48.5	12.4
	33	21.5	4.90	26.9	6.21	32.3	7.70	35.0	8.51	37.7	9.36	43.1	11.2	48.5	13.2
	35	21.5	5.18	26.9	6.58	32.3	8.16	35.0	9.03	37.7	9.94	43.1	11.9	48.5	14.1
	37	21.5	5.46	26.9	6.96	32.3	8.65	35.0	9.58	37.7	10.6	43.1	12.7	48.5	15.0
	39	21.5	5.76	26.9	7.36	32.3	9.17	35.0	10.2	37.7	11.2	43.1	13.4	48.1	15.7
60% 30.00 kW	10	18.5	3.20	23.1	3.79	27.7	4.43	30.0	4.76	32.3	5.11	36.9	5.82	41.5	6.56
	12	18.5	3.24	23.1	3.84	27.7	4.49	30.0	4.84	32.3	5.19	36.9	5.92	41.5	6.67
	14	18.5	3.27	23.1	3.89	27.7	4.56	30.0	4.91	32.3	5.27	36.9	6.01	41.5	6.79
	16	18.5	3.31	23.1	3.95	27.7	4.63	30.0	4.99	32.3	5.36	36.9	6.12	41.5	6.91
	18	18.5	3.36	23.1	4.01	27.7	4.70	30.0	5.07	32.3	5.45	36.9	6.22	41.5	7.03
	20	18.5	3.40	23.1	4.06	27.7	4.78	30.0	5.15	32.3	5.54	36.9	6.34	41.5	7.16
	21	18.5	3.42	23.1	4.09	27.7	4.82	30.0	5.20	32.3	5.59	36.9	6.39	41.5	7.26
	23	18.5	3.47	23.1	4.16	27.7	4.90	30.0	5.29	32.3	5.69	36.9	6.67	41.5	7.76
	25	18.5	3.52	23.1	4.22	27.7	5.07	30.0	5.55	32.3	6.05	36.9	7.11	41.5	8.28
	27	18.5	3.60	23.1	4.44	27.7	5.38	30.0	5.89	32.3	6.43	36.9	7.58	41.5	8.83
	29	18.5	3.80	23.1	4.70	27.7	5.71	30.0	6.26	32.3	6.83	36.9	8.06	41.5	9.40
	31	18.5	4.01	23.1	4.97	27.7	6.06	30.0	6.64	32.3	7.25	36.9	8.57	41.5	10.01
	33	18.5	4.23	23.1	5.26	27.7	6.41	30.0	7.04	32.3	7.70	36.9	9.11	41.5	10.6
	35	18.5	4.46	23.1	5.56	27.7	6.79	30.0	7.46	32.3	8.16	36.9	9.67	41.5	11.3
	37	18.5	4.70	23.1	5.87	27.7	7.19	30.0	7.90	32.3	8.65	36.9	10.3	41.5	12.0
	39	18.5	4.95	23.1	6.19	27.7	7.60	30.0	8.37	32.3	9.17	36.9	10.9	41.5	12.8
50% 25.00 kW	10	15.4	2.83	19.2	3.29	23.1	3.79	25.0	4.05	26.9	4.32	30.8	4.88	34.6	5.46
	12	15.4	2.86	19.2	3.33	23.1	3.84	25.0	4.11	26.9	4.38	30.8	4.95	34.6	5.55
	14	15.4	2.89	19.2	3.37	23.1	3.89	25.0	4.17	26.9	4.45	30.8	5.03	34.6	5.64
	16	15.4	2.92	19.2	3.42	23.1	3.95	25.0	4.23	26.9	4.51	30.8	5.11	34.6	5.73
	18	15.4	2.95	19.2	3.46	23.1	4.01	25.0	4.29	26.9	4.58	30.8	5.19	34.6	5.83
	20	15.4	2.99	19.2	3.51	23.1	4.06	25.0	4.36	26.9	4.66	30.8	5.28	34.6	5.93
	21	15.4	3.00	19.2	3.53	23.1	4.09	25.0	4.39	26.9	4.69	30.8	5.33	34.6	5.98
	23	15.4	3.04	19.2	3.58	23.1	4.16	25.0	4.46	26.9	4.77	30.8	5.42	34.6	6.16
	25	15.4	3.08	19.2	3.63	23.1	4.22	25.0	4.54	26.9	4.92	30.8	5.71	34.6	6.57
	27	15.4	3.12	19.2	3.73	23.1	4.44	25.0	4.82	26.9	5.22	30.8	6.07	34.6	6.99
	29	15.4	3.26	19.2	3.94	23.1	4.70	25.0	5.11	26.9	5.54	30.8	6.45	34.6	7.43
	31	15.4	3.44	19.2	4.16	23.1	4.97	25.0	5.41	26.9	5.87	30.8	6.84	34.6	7.90
	33	15.4	3.62	19.2	4.39	23.1	5.26	25.0	5.72	26.9	6.21	30.8	7.26	34.6	8.39
	35	15.4	3.81	19.2	4.63	23.1	5.56	25.0	6.05	26.9	6.58	30.8	7.69	34.6	8.90
	37	15.4	4.00	19.2	4.88	23.1	5.87	25.0	6.40	26.9	6.96	30.8	8.15	34.6	9.44
	39	15.4	4.20	19.2	5.14	23.1	6.19	25.0	6.76	26.9	7.36	30.8	8.63	34.6	10.01

3D079549

5 Таблицы производительности

5 - 1 Таблицы холодопроизводительности

RXYQ20T															
Indoor air temp. °CWB															
Combination(%) (Capacity index)	Outdoor air temp. (°CDB)	14.0		16.0		18.0		19.0		20.0		22.0		24.0	
		TC	PI	TC	PI	TC	PI	TC	PI	TC	PI	TC	PI	TC	PI
		KW	KW	KW	KW	KW	KW	KW	KW	KW	KW	KW	KW	KW	KW
130% 72.80 kW	10	44.8	7.95	56.0	10.05	67.2	12.3	70.5	12.7	71.6	12.4	73.7	11.7	75.8	11.10
	12	44.8	8.08	56.0	10.23	67.2	12.5	69.6	12.6	70.7	12.3	72.8	11.7	74.9	11.7
	14	44.8	8.22	56.0	10.41	67.2	12.7	68.7	12.5	69.8	12.2	71.9	12.2	73.9	12.3
	16	44.8	8.36	56.0	10.60	66.7	12.8	67.8	12.6	68.8	12.7	70.9	12.9	73.0	13.0
	18	44.8	8.51	56.0	10.80	65.8	13.2	66.9	13.3	67.9	13.4	70.0	13.5	72.1	13.7
	20	44.8	8.66	56.0	11.3	64.9	13.9	66.0	13.9	67.0	14.0	69.1	14.2	71.2	14.3
	21	44.8	8.74	56.0	11.7	64.5	14.2	65.5	14.3	66.6	14.3	68.7	14.5	70.8	14.7
	23	44.8	9.30	56.0	12.5	63.6	14.8	64.6	14.9	65.7	15.0	67.8	15.2	69.8	15.4
	25	44.8	9.92	56.0	13.4	62.7	15.5	63.7	15.6	64.7	15.7	66.8	15.9	68.9	16.0
	27	44.8	10.6	56.0	14.3	61.7	16.1	62.8	16.2	63.8	16.3	65.9	16.5	68.0	16.7
	29	44.8	11.3	56.0	15.3	60.8	16.8	61.9	16.9	62.9	17.0	65.0	17.2	67.1	17.4
	31	44.8	12.0	56.0	16.3	59.9	17.4	61.0	17.5	62.0	17.7	64.1	17.9	66.2	18.1
	33	44.8	12.7	56.0	17.4	59.0	18.1	60.1	18.2	61.1	18.3	63.2	18.6	65.3	18.8
	35	44.8	13.5	56.0	18.5	58.1	18.8	59.1	18.9	60.2	19.0	62.3	19.3	64.4	19.5
	37	44.8	14.4	55.1	19.2	57.2	19.4	58.2	19.5	59.3	19.7	61.4	19.9	63.5	20.2
	39	44.8	15.3	54.2	19.8	56.3	20.1	57.3	20.2	58.4	20.4	60.5	20.6	62.6	20.9
120% 67.20 kW	10	41.4	7.33	51.7	9.23	62.0	11.23	67.2	12.3	70.4	12.7	72.4	12.1	74.3	11.5
	12	41.4	7.45	51.7	9.39	62.0	11.43	67.2	12.5	69.5	12.6	71.5	12.0	73.4	11.6
	14	41.4	7.57	51.7	9.55	62.0	11.6	67.2	12.7	68.6	12.6	70.6	12.1	72.5	12.2
	16	41.4	7.70	51.7	9.72	62.0	11.8	66.7	12.8	67.7	12.6	69.7	12.8	71.6	12.9
	18	41.4	7.83	51.7	9.90	62.0	12.2	65.8	13.2	66.8	13.3	68.7	13.4	70.7	13.6
	20	41.4	7.97	51.7	10.15	62.0	13.1	64.9	13.9	65.9	13.9	67.8	14.1	69.8	14.2
	21	41.4	8.04	51.7	10.50	62.0	13.5	64.5	14.2	65.4	14.3	67.4	14.4	69.3	14.6
	23	41.4	8.40	51.7	11.2	62.0	14.5	63.6	14.8	64.5	14.9	66.5	15.1	68.4	15.2
	25	41.4	8.95	51.7	12.0	61.7	15.4	62.7	15.5	63.6	15.6	65.6	15.7	67.5	15.9
	27	41.4	9.54	51.7	12.8	60.8	16.0	61.7	16.1	62.7	16.2	64.6	16.4	66.6	16.6
	29	41.4	10.15	51.7	13.7	59.9	16.7	60.8	16.8	61.8	16.9	63.7	17.1	65.7	17.3
	31	41.4	10.8	51.7	14.6	59.0	17.3	59.9	17.4	60.9	17.5	62.8	17.7	64.8	18.0
	33	41.4	11.5	51.7	15.5	58.0	18.0	59.0	18.1	60.0	18.2	61.9	18.4	63.8	18.6
	35	41.4	12.2	51.7	16.5	57.1	18.6	58.1	18.8	59.1	18.9	61.0	19.1	62.9	19.3
	37	41.4	12.9	51.7	17.5	56.2	19.3	57.2	19.4	58.2	19.5	60.1	19.8	62.0	20.0
	39	41.4	13.7	51.7	18.7	55.3	20.0	56.3	20.1	57.2	20.2	59.2	20.5	61.1	20.7
110% 61.60 kW	10	37.9	6.72	47.4	8.42	56.9	10.22	61.6	11.14	66.3	12.1	71.1	12.5	72.9	12.0
	12	37.9	6.83	47.4	8.56	56.9	10.40	61.6	11.34	66.3	12.3	70.2	12.4	72.0	11.9
	14	37.9	6.94	47.4	8.71	56.9	10.58	61.6	11.55	66.3	12.5	69.3	12.4	71.0	12.1
	16	37.9	7.06	47.4	8.86	56.9	10.78	61.6	11.8	66.3	12.7	68.4	12.7	70.1	12.8
	18	37.9	7.17	47.4	9.03	56.9	10.98	61.6	12.1	65.7	13.2	67.5	13.3	69.2	13.5
	20	37.9	7.30	47.4	9.19	56.9	11.6	61.6	13.0	64.8	13.8	66.5	14.0	68.3	14.1
	21	37.9	7.36	47.4	9.36	56.9	12.0	61.6	13.4	64.3	14.2	66.1	14.3	67.9	14.4
	23	37.9	7.55	47.4	10.00	56.9	12.8	61.6	14.4	63.4	14.8	65.2	15.0	66.9	15.1
	25	37.9	8.04	47.4	10.68	56.9	13.7	61.6	15.4	62.5	15.5	64.3	15.6	66.0	15.8
	27	37.9	8.56	47.4	11.4	56.9	14.6	60.7	16.0	61.6	16.1	63.4	16.3	65.1	16.4
	29	37.9	9.10	47.4	12.1	56.9	15.6	59.8	16.7	60.7	16.8	62.4	16.9	64.2	17.1
	31	37.9	9.67	47.4	12.9	56.9	16.7	58.9	17.3	59.8	17.4	61.5	17.6	63.3	17.8
	33	37.9	10.26	47.4	13.7	56.9	17.8	58.0	18.0	58.8	18.1	60.6	18.3	62.4	18.5
	35	37.9	10.9	47.4	14.6	56.2	18.5	57.0	18.6	57.9	18.7	59.7	18.9	61.5	19.2
	37	37.9	11.5	47.4	15.5	55.3	19.2	56.1	19.3	57.0	19.4	58.8	19.6	60.6	19.8
	39	37.9	12.2	47.4	16.5	54.3	19.8	55.2	19.9	56.1	20.1	57.9	20.3	59.7	20.5
100% 56.00 kW	10	34.5	6.14	43.1	7.63	51.7	9.23	56.0	10.05	60.3	10.89	68.9	12.6	71.4	12.4
	12	34.5	6.23	43.1	7.76	51.7	9.39	56.0	10.23	60.3	11.08	68.9	12.8	70.5	12.3
	14	34.5	6.33	43.1	7.89	51.7	9.55	56.0	10.41	60.3	11.28	68.0	12.7	69.6	12.3
	16	34.5	6.43	43.1	8.03	51.7	9.72	56.0	10.60	60.3	11.49	67.1	12.7	68.7	12.7
	18	34.5	6.54	43.1	8.17	51.7	9.90	56.0	10.80	60.3	11.71	66.2	13.2	67.8	13.4
	20	34.5	6.65	43.1	8.32	51.7	10.15	56.0	11.33	60.3	12.6	65.3	13.9	66.9	14.0
	21	34.5	6.70	43.1	8.39	51.7	10.50	56.0	11.7	60.3	13.0	64.8	14.2	66.4	14.3
	23	34.5	6.82	43.1	8.84	51.7	11.24	56.0	12.5	60.3	13.9	63.9	14.8	65.5	15.0
	25	34.5	7.19	43.1	9.43	51.7	12.0	56.0	13.4	60.3	14.9	63.0	15.5	64.6	15.6
	27	34.5	7.64	43.1	10.05	51.7	12.8	56.0	14.3	60.3	15.9	62.1	16.2	63.7	16.3
	29	34.5	8.11	43.1	10.69	51.7	13.7	56.0	15.3	59.5	16.6	61.2	16.8	62.8	17.0
	31	34.5	8.61	43.1	11.4	51.7	14.6	56.0	16.3	58.6	17.3	60.2	17.5	61.9	17.6
	33	34.5	9.13	43.1	12.1	51.7	15.5	56.0	17.4	57.7	17.9	59.3	18.1	60.9	18.3
	35	34.5	9.68	43.1	12.8	51.7	16.5	56.0	18.5	56.8	18.6	58.4	18.8	60.0	19.0
	37	34.5	10.25	43.1	13.6	51.7	17.5	55.1	19.2	55.9	19.3	57.5	19.5	59.1	19.7
	39	34.5	10.9	43.1	14.5	51.7	18.7	54.2	19.8	55.0	19.9	56.6	20.1	58.2	20.3

NOTES - ANMERKUNGEN - Σημειώσεις - NOTAS - REMARQUES - NOTE - OPMERKINGEN - примечания - NOTLAR

- The above table shows the average value of conditions which may occur.
Die obige Tabelle zeigt den Durchschnittswert der Bedingungen, die auftreten können.
 Στον παραπάνω πίνακα αναγράφεται η μέση τιμή για συνθήκες που μπορεί να προκύψουν.
La tabla de arriba muestra el valor medio de condiciones que pueden ocurrir.
 Le tableau ci-dessus donne la valeur moyenne pour des conditions qui peuvent survenir.
La tabella in alto mostra il valore delle condizioni medie che si possono riscontrare.
 De tabel hierboven geeft de gemiddelde waarde aan van situaties die kunnen voorvallen.
 Таблица расположенная выше показывает среднее значение условий, которые могут наступить.
 Yukarıdaki tablo meydana gelebilecek koşulların ortalama değerini göstermektedir.

3D079549

5 Таблицы производительности

5 - 1 Таблицы холодопроизводительности

5

RXYQ20T															
Indoor air temp. °CWB															
Combination(%) (Capacity index)	Outdoor air temp. (°CDB)	14.0		16.0		18.0		19.0		20.0		22.0		24.0	
		TC	PI	TC	PI	TC	PI	TC	PI	TC	PI	TC	PI	TC	PI
		KW	KW	KW	KW	KW	KW	KW	KW	KW	KW	KW	KW	KW	KW
90% 50.40 kW	10	31.0	5.58	38.8	6.87	46.5	8.26	50.4	8.98	54.3	9.72	62.0	11.23	69.8	12.8
	12	31.0	5.66	38.8	6.98	46.5	8.40	50.4	9.14	54.3	9.89	62.0	11.43	69.1	12.8
	14	31.0	5.74	38.8	7.10	46.5	8.55	50.4	9.30	54.3	10.07	62.0	11.63	68.1	12.7
	16	31.0	5.83	38.8	7.21	46.5	8.70	50.4	9.46	54.3	10.25	62.0	11.85	67.2	12.6
	18	31.0	5.92	38.8	7.34	46.5	8.85	50.4	9.64	54.3	10.44	62.0	12.2	66.3	13.2
	20	31.0	6.02	38.8	7.47	46.5	9.01	50.4	9.82	54.3	10.85	62.0	13.1	65.4	13.9
	21	31.0	6.06	38.8	7.53	46.5	9.14	50.4	10.15	54.3	11.23	62.0	13.5	65.0	14.2
	23	31.0	6.17	38.8	7.76	46.5	9.76	50.4	10.86	54.3	12.0	62.0	14.5	64.0	14.9
	25	31.0	6.38	38.8	8.27	46.5	10.42	50.4	11.60	54.3	12.8	61.7	15.4	63.1	15.5
	27	31.0	6.78	38.8	8.80	46.5	11.11	50.4	12.4	54.3	13.7	60.8	16.0	62.2	16.2
	29	31.0	7.19	38.8	9.36	46.5	11.8	50.4	13.2	54.3	14.6	59.9	16.7	61.3	16.8
	31	31.0	7.62	38.8	9.94	46.5	12.6	50.4	14.1	54.3	15.6	59.0	17.3	60.4	17.5
	33	31.0	8.07	38.8	10.56	46.5	13.4	50.4	15.0	54.3	16.6	58.0	18.0	59.5	18.1
	35	31.0	8.55	38.8	11.2	46.5	14.2	50.4	15.9	54.3	17.7	57.1	18.6	58.6	18.8
	37	31.0	9.04	38.8	11.9	46.5	15.1	50.4	16.9	54.3	18.8	56.2	19.3	57.7	19.5
	39	31.0	9.57	38.8	12.6	46.5	16.1	50.4	18.0	53.9	19.8	55.3	20.0	56.8	20.2
80% 44.80 kW	10	27.6	5.03	34.5	6.14	41.4	7.33	44.8	7.95	48.2	8.58	55.1	9.89	62.0	11.23
	12	27.6	5.10	34.5	6.23	41.4	7.45	44.8	8.08	48.2	8.73	55.1	10.06	62.0	11.43
	14	27.6	5.18	34.5	6.33	41.4	7.57	44.8	8.22	48.2	8.88	55.1	10.24	62.0	11.63
	16	27.6	5.25	34.5	6.43	41.4	7.70	44.8	8.36	48.2	9.04	55.1	10.42	62.0	11.85
	18	27.6	5.33	34.5	6.54	41.4	7.83	44.8	8.51	48.2	9.20	55.1	10.62	62.0	12.19
	20	27.6	5.41	34.5	6.65	41.4	7.97	44.8	8.66	48.2	9.37	55.1	11.09	62.0	13.1
	21	27.6	5.45	34.5	6.70	41.4	8.04	44.8	8.74	48.2	9.58	55.1	11.47	62.0	13.5
	23	27.6	5.54	34.5	6.82	41.4	8.40	44.8	9.30	48.2	10.24	55.1	12.3	62.0	14.5
	25	27.6	5.63	34.5	7.19	41.4	8.95	44.8	9.92	48.2	10.93	55.1	13.1	61.7	15.4
	27	27.6	5.97	34.5	7.64	41.4	9.54	44.8	10.57	48.2	11.66	55.1	14.0	60.8	16.0
	29	27.6	6.33	34.5	8.11	41.4	10.15	44.8	11.26	48.2	12.4	55.1	15.0	59.9	16.7
	31	27.6	6.70	34.5	8.61	41.4	10.79	44.8	12.0	48.2	13.2	55.1	15.9	59.0	17.3
	33	27.6	7.09	34.5	9.13	41.4	11.46	44.8	12.7	48.2	14.1	55.1	17.0	58.0	18.0
	35	27.6	7.49	34.5	9.68	41.4	12.2	44.8	13.5	48.2	15.0	55.1	18.1	57.1	18.6
	37	27.6	7.92	34.5	10.25	41.4	12.9	44.8	14.4	48.2	15.9	54.9	19.1	56.2	19.3
	39	27.6	8.36	34.5	10.86	41.4	13.7	44.8	15.3	48.2	16.9	54.0	19.8	55.3	20.0
70% 39.20 kW	10	24.1	4.52	30.2	5.44	36.2	6.43	39.2	6.95	42.2	7.48	48.2	8.58	54.3	9.72
	12	24.1	4.57	30.2	5.52	36.2	6.53	39.2	7.06	42.2	7.60	48.2	8.73	54.3	9.89
	14	24.1	4.63	30.2	5.60	36.2	6.63	39.2	7.17	42.2	7.73	48.2	8.88	54.3	10.07
	16	24.1	4.70	30.2	5.68	36.2	6.74	39.2	7.29	42.2	7.86	48.2	9.04	54.3	10.25
	18	24.1	4.76	30.2	5.77	36.2	6.85	39.2	7.42	42.2	8.00	48.2	9.20	54.3	10.44
	20	24.1	4.83	30.2	5.86	36.2	6.97	39.2	7.55	42.2	8.14	48.2	9.37	54.3	10.85
	21	24.1	4.86	30.2	5.91	36.2	7.03	39.2	7.62	42.2	8.22	48.2	9.58	54.3	11.23
	23	24.1	4.94	30.2	6.01	36.2	7.15	39.2	7.86	42.2	8.62	48.2	10.24	54.3	12.01
	25	24.1	5.01	30.2	6.19	36.2	7.61	39.2	8.38	42.2	9.19	48.2	10.93	54.3	12.8
	27	24.1	5.22	30.2	6.57	36.2	8.09	39.2	8.92	42.2	9.79	48.2	11.66	54.3	13.7
	29	24.1	5.52	30.2	6.97	36.2	8.60	39.2	9.48	42.2	10.42	48.2	12.4	54.3	14.6
	31	24.1	5.84	30.2	7.38	36.2	9.13	39.2	10.08	42.2	11.08	48.2	13.2	54.3	15.6
	33	24.1	6.17	30.2	7.82	36.2	9.69	39.2	10.70	42.2	11.78	48.2	14.1	54.3	16.6
	35	24.1	6.51	30.2	8.28	36.2	10.27	39.2	11.36	42.2	12.5	48.2	15.0	54.3	17.7
	37	24.1	6.87	30.2	8.75	36.2	10.89	39.2	12.1	42.2	13.3	48.2	15.9	54.3	18.8
	39	24.1	7.25	30.2	9.26	36.2	11.54	39.2	12.8	42.2	14.1	48.2	16.9	53.9	19.8
60% 33.60 kW	10	20.7	4.03	25.8	4.77	31.0	5.58	33.6	6.00	36.2	6.43	41.4	7.33	46.5	8.26
	12	20.7	4.07	25.8	4.84	31.0	5.66	33.6	6.09	36.2	6.53	41.4	7.45	46.5	8.40
	14	20.7	4.12	25.8	4.90	31.0	5.74	33.6	6.18	36.2	6.63	41.4	7.57	46.5	8.55
	16	20.7	4.17	25.8	4.97	31.0	5.83	33.6	6.28	36.2	6.74	41.4	7.70	46.5	8.70
	18	20.7	4.22	25.8	5.04	31.0	5.92	33.6	6.38	36.2	6.85	41.4	7.83	46.5	8.85
	20	20.7	4.28	25.8	5.12	31.0	6.02	33.6	6.49	36.2	6.97	41.4	7.97	46.5	9.01
	21	20.7	4.31	25.8	5.15	31.0	6.06	33.6	6.54	36.2	7.03	41.4	8.04	46.5	9.14
	23	20.7	4.36	25.8	5.23	31.0	6.17	33.6	6.65	36.2	7.15	41.4	8.40	46.5	9.76
	25	20.7	4.43	25.8	5.31	31.0	6.38	33.6	6.98	36.2	7.61	41.4	8.95	46.5	10.42
	27	20.7	4.53	25.8	5.59	31.0	6.78	33.6	7.42	36.2	8.09	41.4	9.54	46.5	11.11
	29	20.7	4.78	25.8	5.92	31.0	7.19	33.6	7.88	36.2	8.60	41.4	10.15	46.5	11.83
	31	20.7	5.05	25.8	6.26	31.0	7.62	33.6	8.36	36.2	9.13	41.4	10.79	46.5	12.6
	33	20.7	5.33	25.8	6.62	31.0	8.07	33.6	8.86	36.2	9.69	41.4	11.46	46.5	13.4
	35	20.7	5.61	25.8	6.99	31.0	8.55	33.6	9.39	36.2	10.27	41.4	12.17	46.5	14.2
	37	20.7	5.91	25.8	7.38	31.0	9.04	33.6	9.94	36.2	10.89	41.4	12.9	46.5	15.1
	39	20.7	6.22	25.8	7.80	31.0	9.57	33.6	10.53	36.2	11.54	41.4	13.7	46.5	16.1
50% 28.00 kW	10	17.2	3.56	21.5	4.15	25.8	4.77	28.0	5.10	30.2	5.44	34.5	6.14	38.8	6.87
	12	17.2	3.60	21.5	4.20	25.8	4.84	28.0	5.17	30.2	5.52	34.5	6.23	38.8	6.98
	14	17.2	3.64	21.5	4.25	25.8	4.90	28.0	5.24	30.2	5.60	34.5	6.33	38.8	7.10
	16	17.2	3.68	21.5	4.30	25.8	4.97	28.0	5.32	30.2	5.68	34.5	6.43	38.8	7.21
	18	17.2	3.72	21.5	4.36	25.8	5.04	28.0	5.40	30.2	5.77	34.5	6.54	38.8	7.34
	20	17.2	3.76	21.5	4.41	25.8	5.12	28.0	5.48	30.2	5.86	34.5	6.65	38.8	7.47
	21	17.2	3.78	21.5	4.44	25.8	5.15	28.0	5.53	30.2	5.91	34.5	6.70	38.8	7.53
	23	17.2	3.83	21.5	4.50	25.8	5.23	28.0	5.61	30.2	6.01	34.5	6.82	38.8	7.76
	25	17.2	3.87	21.5	4.57	25.8	5.31	28.0	5.72	30.2	6.19	34.5	7.19	38.8	8.27
	27	17.2	3.92	21.5	4.70	25.8	5.59	28.0	6.07	30.2	6.57	34.5	7.64	38.8	8.80
	29	17.2	4.11	21.5	4.96	25.8	5.92	28.0	6.43	30.2	6.97	34.5	8.11	38.8	9.36
	31	17.2	4.33	21.5	5.24	25.8	6.26	28.0	6.81	30.2	7.38	34.5	8.61	38.8	9.94
	33	17.2	4.55	21.5	5.53	25.8	6.62	28.0	7.20	30.2	7.82	34.5	9.13	38.8	10.56
	35	17.2	4.79	21.5	5.83	25.8	6.99	28.0	7.62	30.2	8.28	34.5	9.68	38.8	11.20
	37	17.2	5.03	21.5	6.14	25.8	7.38	28.0	8.05	30.2	8.75	34.5	10.25	38.8	11.88
	39	17.2	5.29	21.5	6.47	25.8	7.80	28.0	8.51	30.2	9.26	34.5	10.86	38.8	12.6

3D079549

5 Таблицы производительности

5 - 1 Таблицы холодопроизводительности

RXYQ22T															
TC : Total capacity (kW); PI : Power Input (kW) (Comp. + Outdoor fan motor)															
Indoor air temp. °CWB															
Combination(%) (Capacity index)	Outdoor air temp. (°CDB)	14.0		16.0		18.0		19.0		20.0		22.0		24.0	
		TC	PI	TC	PI	TC	PI	TC	PI	TC	PI	TC	PI	TC	PI
		KW	KW	KW	KW	KW	KW	KW	KW	KW	KW	KW	KW	KW	KW
130% 79.95 kW	10	49.2	6.94	61.5	8.82	73.8	10.8	77.5	11.1	78.6	10.9	80.9	10.3	83.2	9.8
	12	49.2	7.06	61.5	8.97	73.8	11.0	76.5	11.1	77.6	10.8	79.9	10.3	82.2	10.3
	14	49.2	7.18	61.5	9.1	73.8	11.2	75.5	11.0	76.6	10.8	78.9	10.7	81.2	10.9
	16	49.2	7.31	61.5	9.3	73.3	11.3	74.5	11.1	75.6	11.2	77.9	11.3	80.2	11.4
	18	49.2	7.44	61.5	9.5	72.3	11.6	73.5	11.7	74.6	11.8	76.9	11.9	79.2	12.0
	20	49.2	7.58	61.5	9.9	71.3	12.2	72.5	12.3	73.6	12.3	75.9	12.5	78.2	12.6
	21	49.2	7.65	61.5	10.3	70.8	12.5	72.0	12.6	73.1	12.6	75.4	12.8	77.7	12.9
	23	49.2	8.14	61.5	11.0	69.8	13.0	71.0	13.1	72.1	13.2	74.4	13.4	76.7	13.5
	25	49.2	8.7	61.5	11.8	68.8	13.6	70.0	13.7	71.1	13.8	73.4	14.0	75.7	14.1
	27	49.2	9.3	61.5	12.6	67.8	14.2	69.0	14.3	70.1	14.4	72.4	14.5	74.7	14.7
	29	49.2	9.9	61.5	13.4	66.8	14.8	68.0	14.9	69.1	15.0	71.4	15.1	73.7	15.3
	31	49.2	10.5	61.5	14.3	65.8	15.3	67.0	15.4	68.1	15.5	70.4	15.7	72.7	15.9
	33	49.2	11.2	61.5	15.3	64.8	15.9	66.0	16.0	67.1	16.1	69.4	16.3	71.7	16.6
	35	49.2	11.9	61.5	16.3	63.8	16.5	65.0	16.6	66.1	16.7	68.4	16.9	70.7	17.2
	37	49.2	12.6	60.5	16.9	62.8	17.1	64.0	17.2	65.1	17.3	67.4	17.6	69.7	17.8
	39	49.2	13.4	59.5	17.4	61.8	17.7	63.0	17.8	64.1	17.9	66.4	18.2	68.7	18.4
120% 73.80 kW	10	45.4	6.39	56.8	8.08	68.1	9.9	73.8	10.8	77.4	11.2	79.5	10.7	81.6	10.2
	12	45.4	6.49	56.8	8.22	68.1	10.0	73.8	11.0	76.4	11.1	78.5	10.6	80.6	10.2
	14	45.4	6.60	56.8	8.37	68.1	10.2	73.8	11.2	75.4	11.1	77.5	10.7	79.6	10.8
	16	45.4	6.72	56.8	8.52	68.1	10.4	73.3	11.3	74.4	11.1	76.5	11.2	78.6	11.4
	18	45.4	6.84	56.8	8.68	68.1	10.7	72.3	11.6	73.4	11.7	75.5	11.8	77.6	11.9
	20	45.4	6.96	56.8	8.90	68.1	11.5	71.3	12.2	72.4	12.3	74.5	12.4	76.6	12.5
	21	45.4	7.03	56.8	9.2	68.1	11.9	70.8	12.5	71.9	12.5	74.0	12.7	76.1	12.8
	23	45.4	7.34	56.8	9.9	68.1	12.8	69.8	13.0	70.9	13.1	73.0	13.3	75.1	13.4
	25	45.4	7.83	56.8	10.5	67.7	13.5	68.8	13.6	69.9	13.7	72.0	13.9	74.1	14.0
	27	45.4	8.34	56.8	11.2	66.7	14.1	67.8	14.2	68.9	14.3	71.0	14.4	73.1	14.6
	29	45.4	8.9	56.8	12.0	65.7	14.7	66.8	14.8	67.9	14.9	70.0	15.0	72.1	15.2
	31	45.4	9.4	56.8	12.8	64.7	15.3	65.8	15.3	66.9	15.4	69.0	15.6	71.1	15.8
	33	45.4	10.0	56.8	13.6	63.7	15.8	64.8	15.9	65.9	16.0	68.0	16.2	70.1	16.4
	35	45.4	10.7	56.8	14.5	62.7	16.4	63.8	16.5	64.9	16.6	67.0	16.8	69.1	17.0
	37	45.4	11.3	56.8	15.4	61.7	17.0	62.8	17.1	63.9	17.2	66.0	17.4	68.1	17.6
	39	45.4	12.0	56.8	16.4	60.7	17.6	61.8	17.7	62.9	17.8	65.0	18.0	67.1	18.2
110% 67.65 kW	10	41.6	5.85	52.0	7.36	62.4	8.96	67.7	9.8	72.9	10.6	78.1	11.0	80.0	10.5
	12	41.6	5.94	52.0	7.49	62.4	9.12	67.7	10.0	72.9	10.8	77.1	10.9	79.0	10.5
	14	41.6	6.04	52.0	7.62	62.4	9.29	67.7	10.1	72.9	11.0	76.1	10.9	78.0	10.7
	16	41.6	6.15	52.0	7.76	62.4	9.5	67.7	10.3	72.9	11.2	75.1	11.2	77.0	11.3
	18	41.6	6.25	52.0	7.90	62.4	9.6	67.7	10.6	72.1	11.6	74.1	11.7	76.0	11.8
	20	41.6	6.36	52.0	8.05	62.4	10.2	67.7	11.4	71.1	12.2	73.1	12.3	75.0	12.4
	21	41.6	6.42	52.0	8.20	62.4	10.5	67.7	11.8	70.6	12.5	72.6	12.6	74.5	12.7
	23	41.6	6.59	52.0	8.76	62.4	11.3	67.7	12.6	69.6	13.0	71.6	13.2	73.5	13.3
	25	41.6	7.02	52.0	9.4	62.4	12.1	67.7	13.5	68.6	13.6	70.6	13.7	72.5	13.9
	27	41.6	7.47	52.0	10.0	62.4	12.9	66.7	14.1	67.6	14.2	69.6	14.3	71.5	14.5
	29	41.6	7.95	52.0	10.6	62.4	13.7	65.7	14.7	66.6	14.8	68.6	14.9	70.5	15.1
	31	41.6	8.44	52.0	11.3	62.4	14.7	64.7	15.2	65.6	15.3	67.6	15.5	69.5	15.7
	33	41.6	9.0	52.0	12.1	62.4	15.6	63.7	15.8	64.6	15.9	66.6	16.1	68.5	16.3
	35	41.6	9.5	52.0	12.8	61.7	16.3	62.7	16.4	63.6	16.5	65.6	16.7	67.5	16.9
	37	41.6	10.1	52.0	13.6	60.7	16.9	61.7	17.0	62.6	17.1	64.6	17.3	66.5	17.5
	39	41.6	10.7	52.0	14.5	59.7	17.5	60.6	17.6	61.6	17.7	63.6	17.9	65.5	18.1
100% 61.50 kW	10	37.8	5.33	47.3	6.66	56.8	8.08	61.5	8.82	66.2	9.56	75.7	11.1	78.4	10.9
	12	37.8	5.41	47.3	6.77	56.8	8.22	61.5	8.97	66.2	9.7	75.7	11.3	77.4	10.9
	14	37.8	5.50	47.3	6.89	56.8	8.37	61.5	9.14	66.2	9.9	74.7	11.2	76.4	10.8
	16	37.8	5.59	47.3	7.01	56.8	8.52	61.5	9.31	66.2	10.1	73.7	11.2	75.4	11.2
	18	37.8	5.68	47.3	7.14	56.8	8.68	61.5	9.48	66.2	10.3	72.7	11.7	74.4	11.8
	20	37.8	5.78	47.3	7.27	56.8	8.90	61.5	9.9	66.2	11.1	71.7	12.2	73.4	12.3
	21	37.8	5.83	47.3	7.34	56.8	9.22	61.5	10.3	66.2	11.4	71.2	12.5	72.9	12.6
	23	37.8	5.94	47.3	7.73	56.8	9.9	61.5	11.0	66.2	12.3	70.2	13.1	71.9	13.2
	25	37.8	6.26	47.3	8.25	56.8	10.5	61.5	11.8	66.2	13.1	69.2	13.6	70.9	13.8
	27	37.8	6.65	47.3	8.79	56.8	11.2	61.5	12.6	66.2	14.0	68.2	14.2	69.9	14.4
	29	37.8	7.07	47.3	9.4	56.8	12.0	61.5	13.4	65.4	14.7	67.2	14.8	68.9	14.9
	31	37.8	7.51	47.3	10.0	56.8	12.8	61.5	14.3	64.4	15.2	66.2	15.4	67.9	15.5
	33	37.8	7.96	47.3	10.6	56.8	13.6	61.5	15.3	63.4	15.8	65.2	16.0	66.9	16.1
	35	37.8	8.45	47.3	11.3	56.8	14.5	61.5	16.3	62.4	16.4	64.2	16.5	65.9	16.7
	37	37.8	9.0	47.3	12.0	56.8	15.4	60.5	16.9	61.4	16.9	63.2	17.1	64.9	17.3
	39	37.8	9.5	47.3	12.7	56.8	16.4	59.5	17.4	60.4	17.5	62.2	17.7	63.9	17.9

NOTES - ANMERKUNGEN - Σημειώσεις - NOTAS - REMARQUES - NOTE - OPMERKINGEN - примечания - NOTLAR

- The above table shows the average value of conditions which may occur.
Die obige Tabelle zeigt den Durchschnittswert der Bedingungen, die auftreten können.
 Στον παραπάνω πίνακα αναγράφεται η μέση τιμή για συνθήκες που μπορεί να προκύψουν.
La tabla de arriba muestra el valor medio de condiciones que pueden ocurrir.
 Le tableau ci-dessus donne la valeur moyenne pour des conditions qui peuvent survenir.
La tabella in alto mostra il valore delle condizioni medie che si possono riscontrare.
 De tabel hierboven geeft de gemiddelde waarde aan van situaties die kunnen voorvallen.
 Таблица расположенная выше показывает среднее значение условий, которые могут наступить.
 Yukarıdaki tablo meydana gelebilecek koşulların ortalama değerini göstermektedir.

3D079549

5 Таблицы производительности

5 - 1 Таблицы холодопроизводительности

5

RXYQ22T															
Indoor air temp. °CWB															
Combination(%) (Capacity index)	Outdoor air temp. (°CDB)	14.0		16.0		18.0		19.0		20.0		22.0		24.0	
		TC	PI	TC	PI	TC	PI	TC	PI	TC	PI	TC	PI	TC	PI
		KW	KW	KW	KW	KW	KW	KW	KW	KW	KW	KW	KW	KW	KW
90% 55.35 kW	10	34.1	4.83	42.6	5.98	51.1	7.22	55.4	7.86	59.6	8.52	68.1	9.9	76.6	11.2
	12	34.1	4.90	42.6	6.08	51.1	7.34	55.4	8.00	59.6	8.67	68.1	10.0	75.8	11.2
	14	34.1	4.98	42.6	6.18	51.1	7.47	55.4	8.14	59.6	8.83	68.1	10.2	74.8	11.2
	16	34.1	5.05	42.6	6.29	51.1	7.61	55.4	8.29	59.6	8.99	68.1	10.4	73.8	11.1
	18	34.1	5.14	42.6	6.40	51.1	7.75	55.4	8.45	59.6	9.16	68.1	10.7	72.8	11.7
	20	34.1	5.22	42.6	6.51	51.1	7.89	55.4	8.61	59.6	9.52	68.1	11.5	71.8	12.2
	21	34.1	5.26	42.6	6.57	51.1	8.00	55.4	8.90	59.6	9.9	68.1	11.9	71.3	12.5
	23	34.1	5.35	42.6	6.77	51.1	8.55	55.4	9.52	59.6	10.6	68.1	12.8	70.3	13.1
	25	34.1	5.54	42.6	7.22	51.1	9.13	55.4	10.2	59.6	11.3	67.7	13.5	69.3	13.7
	27	34.1	5.89	42.6	7.68	51.1	9.7	55.4	10.9	59.6	12.0	66.7	14.1	68.3	14.2
	29	34.1	6.25	42.6	8.17	51.1	10.4	55.4	11.6	59.6	12.9	65.7	14.7	67.3	14.8
	31	34.1	6.63	42.6	8.69	51.1	11.0	55.4	12.3	59.6	13.7	64.7	15.3	66.3	15.4
	33	34.1	7.02	42.6	9.2	51.1	11.8	55.4	13.1	59.6	14.6	63.7	15.8	65.3	16.0
	35	34.1	7.44	42.6	9.8	51.1	12.5	55.4	14.0	59.6	15.6	62.7	16.4	64.3	16.6
	37	34.1	7.88	42.6	10.4	51.1	13.3	55.4	14.9	59.6	16.6	61.7	17.0	63.3	17.1
	39	34.1	8.34	42.6	11.0	51.1	14.1	55.4	15.8	59.1	17.4	60.7	17.6	62.3	17.7
80% 49.20 kW	10	30.3	4.35	37.8	5.33	45.4	6.39	49.2	6.94	53.0	7.50	60.6	8.67	68.1	9.87
	12	30.3	4.41	37.8	5.41	45.4	6.49	49.2	7.06	53.0	7.63	60.6	8.82	68.1	10.0
	14	30.3	4.47	37.8	5.50	45.4	6.60	49.2	7.18	53.0	7.77	60.6	8.98	68.1	10.2
	16	30.3	4.54	37.8	5.59	45.4	6.72	49.2	7.31	53.0	7.91	60.6	9.15	68.1	10.4
	18	30.3	4.61	37.8	5.68	45.4	6.84	49.2	7.44	53.0	8.06	60.6	9.32	68.1	10.7
	20	30.3	4.68	37.8	5.78	45.4	6.96	49.2	7.58	53.0	8.21	60.6	9.73	68.1	11.5
	21	30.3	4.72	37.8	5.83	45.4	7.03	49.2	7.65	53.0	8.39	60.6	10.1	68.1	11.9
	23	30.3	4.79	37.8	5.94	45.4	7.34	49.2	8.14	53.0	8.98	60.6	10.8	68.1	12.8
	25	30.3	4.88	37.8	6.26	45.4	7.83	49.2	8.68	53.0	9.59	60.6	11.5	67.7	13.5
	27	30.3	5.17	37.8	6.65	45.4	8.34	49.2	9.26	53.0	10.2	60.6	12.3	66.7	14.1
	29	30.3	5.48	37.8	7.07	45.4	8.88	49.2	9.9	53.0	10.9	60.6	13.2	65.7	14.7
	31	30.3	5.81	37.8	7.51	45.4	9.44	49.2	10.5	53.0	11.6	60.6	14.0	64.7	15.3
	33	30.3	6.15	37.8	7.96	45.4	10.0	49.2	11.2	53.0	12.4	60.6	14.9	63.7	15.8
	35	30.3	6.50	37.8	8.45	45.4	10.7	49.2	11.9	53.0	13.2	60.6	15.9	62.7	16.4
	37	30.3	6.88	37.8	8.95	45.4	11.3	49.2	12.6	53.0	14.0	60.3	16.8	61.7	17.0
	39	30.3	7.27	37.8	9.5	45.4	12.0	49.2	13.4	53.0	14.9	59.3	17.4	60.7	17.6
70% 43.05 kW	10	26.5	3.89	33.1	4.71	39.7	5.59	43.1	6.05	46.4	6.52	53.0	7.50	59.6	8.52
	12	26.5	3.94	33.1	4.78	39.7	5.68	43.1	6.15	46.4	6.63	53.0	7.63	59.6	8.67
	14	26.5	3.99	33.1	4.85	39.7	5.77	43.1	6.25	46.4	6.75	53.0	7.77	59.6	8.83
	16	26.5	4.05	33.1	4.92	39.7	5.87	43.1	6.36	46.4	6.86	53.0	7.91	59.6	8.99
	18	26.5	4.10	33.1	5.00	39.7	5.97	43.1	6.47	46.4	6.99	53.0	8.06	59.6	9.16
	20	26.5	4.16	33.1	5.08	39.7	6.07	43.1	6.59	46.4	7.12	53.0	8.21	59.6	9.52
	21	26.5	4.20	33.1	5.12	39.7	6.12	43.1	6.65	46.4	7.18	53.0	8.39	59.6	9.86
	23	26.5	4.26	33.1	5.21	39.7	6.23	43.1	6.86	46.4	7.53	53.0	8.98	59.6	10.6
	25	26.5	4.33	33.1	5.37	39.7	6.63	43.1	7.32	46.4	8.04	53.0	9.59	59.6	11.3
	27	26.5	4.51	33.1	5.71	39.7	7.06	43.1	7.79	46.4	8.56	53.0	10.2	59.6	12.0
	29	26.5	4.77	33.1	6.05	39.7	7.50	43.1	8.29	46.4	9.12	53.0	10.9	59.6	12.9
	31	26.5	5.05	33.1	6.42	39.7	7.97	43.1	8.81	46.4	9.70	53.0	11.6	59.6	13.7
	33	26.5	5.34	33.1	6.80	39.7	8.46	43.1	9.36	46.4	10.3	53.0	12.4	59.6	14.6
	35	26.5	5.64	33.1	7.20	39.7	8.97	43.1	9.9	46.4	11.0	53.0	13.2	59.6	15.6
	37	26.5	5.95	33.1	7.62	39.7	9.52	43.1	10.5	46.4	11.6	53.0	14.0	59.6	16.6
	39	26.5	6.28	33.1	8.06	39.7	10.1	43.1	11.2	46.4	12.4	53.0	14.9	59.1	17.4
60% 36.90 kW	10	22.7	3.45	28.4	4.11	34.1	4.83	36.9	5.20	39.7	5.59	45.4	6.39	51.1	7.22
	12	22.7	3.49	28.4	4.17	34.1	4.90	36.9	5.28	39.7	5.68	45.4	6.49	51.1	7.34
	14	22.7	3.54	28.4	4.23	34.1	4.98	36.9	5.37	39.7	5.77	45.4	6.60	51.1	7.47
	16	22.7	3.58	28.4	4.29	34.1	5.05	36.9	5.45	39.7	5.87	45.4	6.72	51.1	7.61
	18	22.7	3.63	28.4	4.35	34.1	5.14	36.9	5.54	39.7	5.97	45.4	6.84	51.1	7.75
	20	22.7	3.68	28.4	4.42	34.1	5.22	36.9	5.64	39.7	6.07	45.4	6.96	51.1	7.89
	21	22.7	3.70	28.4	4.45	34.1	5.26	36.9	5.69	39.7	6.12	45.4	7.03	51.1	8.00
	23	22.7	3.75	28.4	4.52	34.1	5.35	36.9	5.79	39.7	6.23	45.4	7.34	51.1	8.55
	25	22.7	3.81	28.4	4.60	34.1	5.54	36.9	6.07	39.7	6.63	45.4	7.83	51.1	9.13
	27	22.7	3.90	28.4	4.84	34.1	5.89	36.9	6.46	39.7	7.06	45.4	8.34	51.1	9.74
	29	22.7	4.12	28.4	5.12	34.1	6.25	36.9	6.86	39.7	7.50	45.4	8.88	51.1	10.4
	31	22.7	4.35	28.4	5.42	34.1	6.63	36.9	7.28	39.7	7.97	45.4	9.44	51.1	11.0
	33	22.7	4.59	28.4	5.74	34.1	7.02	36.9	7.72	39.7	8.46	45.4	10.0	51.1	11.8
	35	22.7	4.84	28.4	6.06	34.1	7.44	36.9	8.19	39.7	8.97	45.4	10.7	51.1	12.5
	37	22.7	5.10	28.4	6.41	34.1	7.88	36.9	8.68	39.7	9.52	45.4	11.3	51.1	13.3
	39	22.7	5.37	28.4	6.77	34.1	8.34	36.9	9.19	39.7	10.1	45.4	12.0	51.1	14.1
50% 30.75 kW	10	18.9	3.04	23.7	3.56	28.4	4.11	30.8	4.41	33.1	4.71	37.8	5.33	42.6	5.98
	12	18.9	3.07	23.7	3.60	28.4	4.17	30.8	4.47	33.1	4.78	37.8	5.41	42.6	6.08
	14	18.9	3.11	23.7	3.65	28.4	4.23	30.8	4.53	33.1	4.85	37.8	5.50	42.6	6.18
	16	18.9	3.14	23.7	3.69	28.4	4.29	30.8	4.60	33.1	4.92	37.8	5.59	42.6	6.29
	18	18.9	3.18	23.7	3.74	28.4	4.35	30.8	4.67	33.1	5.00	37.8	5.68	42.6	6.40
	20	18.9	3.22	23.7	3.80	28.4	4.42	30.8	4.75	33.1	5.08	37.8	5.78	42.6	6.51
	21	18.9	3.23	23.7	3.82	28.4	4.45	30.8	4.78	33.1	5.12	37.8	5.83	42.6	6.57
	23	18.9	3.28	23.7	3.88	28.4	4.52	30.8	4.86	33.1	5.21	37.8	5.94	42.6	6.77
	25	18.9	3.32	23.7	3.93	28.4	4.60	30.8	4.96	33.1	5.37	37.8	6.26	42.6	7.22
	27	18.9	3.36	23.7	4.05	28.4	4.84	30.8	5.26	33.1	5.71	37.8	6.65	42.6	7.68
	29	18.9	3.52	23.7	4.28	28.4	5.12	30.8	5.58	33.1	6.05	37.8	7.07	42.6	8.17
	31	18.9	3.71	23.7	4.52	28.4	5.42	30.8	5.91	33.1	6.42	37.8	7.51	42.6	8.69
	33	18.9	3.91	23.7	4.77	28.4	5.74	30.8	6.25	33.1	6.80	37.8	7.96	42.6	9.23
	35	18.9	4.11	23.7	5.03	28.4	6.06	30.8	6.62	33.1	7.20	37.8	8.45	42.6	9.80
	37	18.9	4.32	23.7	5.31	28.4	6.41	30.8	7.00	33.1	7.62	37.8	8.95	42.6	10.4
	39	18.9	4.54	23.7	5.59	28.4	6.77	30.8	7.40	33.1	8.06	37.8	9.48	42.6	11.0

3D079549

5 Таблицы производительности

5 - 1 Таблицы холодопроизводительности

RXYQ24T															
Indoor air temp. °CWB															
Combination(%) (Capacity index)	Outdoor air temp. (°CDB)	14.0		16.0		18.0		19.0		20.0		22.0		24.0	
		TC	PI	TC	PI	TC	PI	TC	PI	TC	PI	TC	PI	TC	PI
		KW		KW		KW		KW		KW		KW		KW	
130% 87.62 kW	10	53.9	7.80	67.4	9.9	80.9	12.1	84.9	12.5	86.1	12.2	88.7	11.6	91.2	10.9
	12	53.9	7.9	67.4	10.1	80.9	12.3	83.8	12.4	85.1	12.1	87.6	11.5	90.1	11.5
	14	53.9	8.1	67.4	10.2	80.9	12.5	82.7	12.3	84.0	12.0	86.5	12.0	89.0	12.1
	16	53.9	8.2	67.4	10.4	80.3	12.6	81.6	12.4	82.9	12.5	85.4	12.7	87.9	12.8
	18	53.9	8.4	67.4	10.6	79.2	13.0	80.5	13.1	81.8	13.2	84.3	13.3	86.8	13.5
	20	53.9	8.5	67.4	11.1	78.1	13.6	79.4	13.7	80.7	13.8	83.2	14.0	85.7	14.1
	21	53.9	8.6	67.4	11.5	77.6	14.0	78.9	14.0	80.1	14.1	82.6	14.3	85.2	14.5
	23	53.9	9.1	67.4	12.3	76.5	14.6	77.8	14.7	79.0	14.8	81.5	14.9	84.1	15.1
	25	53.9	9.7	67.4	13.2	75.4	15.2	76.7	15.3	77.9	15.4	80.4	15.6	83.0	15.8
	27	53.9	10.4	67.4	14.1	74.3	15.9	75.6	16.0	76.8	16.1	79.4	16.3	81.9	16.5
	29	53.9	11.1	67.4	15.0	73.2	16.5	74.5	16.6	75.7	16.7	78.3	16.9	80.8	17.1
	31	53.9	11.8	67.4	16.0	72.1	17.2	73.4	17.3	74.6	17.4	77.2	17.6	79.7	17.8
	33	53.9	12.5	67.4	17.1	71.0	17.8	72.3	17.9	73.5	18.0	76.1	18.3	78.6	18.5
	35	53.9	13.3	67.4	18.2	69.9	18.5	71.2	18.6	72.4	18.7	75.0	19.0	77.5	19.2
	37	53.9	14.1	66.3	18.9	68.8	19.1	70.1	19.2	71.3	19.4	73.9	19.6	76.4	19.9
	39	53.9	15.0	65.2	19.5	67.7	19.8	69.0	19.9	70.3	20.0	72.8	20.3	75.3	20.6
120% 80.88 kW	10	49.8	7.19	62.2	9.1	74.7	11.0	80.9	12.1	84.8	12.5	87.1	11.9	89.4	11.4
	12	49.8	7.30	62.2	9.2	74.7	11.2	80.9	12.3	83.7	12.4	86.0	11.9	88.4	11.4
	14	49.8	7.43	62.2	9.4	74.7	11.4	80.9	12.5	82.6	12.4	84.9	11.9	87.3	12.0
	16	49.8	7.56	62.2	9.6	74.7	11.7	80.3	12.6	81.5	12.4	83.8	12.6	86.2	12.7
	18	49.8	7.69	62.2	9.7	74.7	12.0	79.2	13.0	80.4	13.1	82.7	13.2	85.1	13.4
	20	49.8	7.83	62.2	10.0	74.7	12.9	78.1	13.6	79.3	13.7	81.6	13.9	84.0	14.0
	21	49.8	7.90	62.2	10.3	74.7	13.3	77.6	14.0	78.8	14.0	81.1	14.2	83.4	14.3
	23	49.8	8.2	62.2	11.0	74.7	14.3	76.5	14.6	77.7	14.7	80.0	14.8	82.3	15.0
	25	49.8	8.8	62.2	11.8	74.2	15.1	75.4	15.2	76.6	15.3	78.9	15.5	81.2	15.7
	27	49.8	9.4	62.2	12.6	73.1	15.8	74.3	15.9	75.5	16.0	77.8	16.1	80.1	16.3
	29	49.8	10.0	62.2	13.4	72.0	16.4	73.2	16.5	74.4	16.6	76.7	16.8	79.0	17.0
	31	49.8	10.6	62.2	14.3	71.0	17.1	72.1	17.2	73.3	17.3	75.6	17.5	77.9	17.7
	33	49.8	11.3	62.2	15.2	69.9	17.7	71.0	17.8	72.2	17.9	74.5	18.1	76.8	18.3
	35	49.8	12.0	62.2	16.2	68.8	18.3	69.9	18.5	71.1	18.6	73.4	18.8	75.7	19.0
	37	49.8	12.7	62.2	17.3	67.7	19.0	68.8	19.1	70.0	19.2	72.3	19.5	74.6	19.7
	39	49.8	13.5	62.2	18.4	66.6	19.6	67.7	19.8	68.9	19.9	71.2	20.2	73.6	20.4
110% 74.14 kW	10	45.6	6.59	57.0	8.27	68.4	10.0	74.1	11.0	79.8	11.9	85.6	12.3	87.7	11.8
	12	45.6	6.70	57.0	8.4	68.4	10.2	74.1	11.2	79.8	12.1	84.5	12.2	86.6	11.7
	14	45.6	6.81	57.0	8.6	68.4	10.4	74.1	11.4	79.8	12.3	83.4	12.2	85.5	12.0
	16	45.6	6.92	57.0	8.7	68.4	10.6	74.1	11.6	79.8	12.5	82.3	12.5	84.4	12.6
	18	45.6	7.04	57.0	8.9	68.4	10.8	74.1	11.9	79.0	13.0	81.2	13.1	83.3	13.2
	20	45.6	7.16	57.0	9.0	68.4	11.4	74.1	12.7	78.0	13.6	80.1	13.8	82.2	13.9
	21	45.6	7.22	57.0	9.2	68.4	11.8	74.1	13.2	77.4	13.9	79.5	14.1	81.7	14.2
	23	45.6	7.41	57.0	9.8	68.4	12.6	74.1	14.1	76.3	14.6	78.4	14.7	80.6	14.9
	25	45.6	7.9	57.0	10.5	68.4	13.5	74.1	15.1	75.2	15.2	77.3	15.4	79.5	15.5
	27	45.6	8.4	57.0	11.2	68.4	14.4	73.0	15.8	74.1	15.9	76.2	16.0	78.4	16.2
	29	45.6	8.9	57.0	11.9	68.4	15.4	72.0	16.4	73.0	16.5	75.2	16.7	77.3	16.9
	31	45.6	9.5	57.0	12.7	68.4	16.4	70.9	17.0	71.9	17.1	74.1	17.3	76.2	17.5
	33	45.6	10.1	57.0	13.5	68.4	17.5	69.8	17.7	70.8	17.8	73.0	18.0	75.1	18.2
	35	45.6	10.7	57.0	14.4	67.6	18.2	68.7	18.3	69.7	18.4	71.9	18.6	74.0	18.9
	37	45.6	11.3	57.0	15.3	66.5	18.9	67.6	19.0	68.6	19.1	70.8	19.3	72.9	19.5
	39	45.6	12.0	57.0	16.2	65.4	19.5	66.5	19.6	67.5	19.7	69.7	20.0	71.8	20.2
100% 67.40 kW	10	41.5	6.01	51.8	7.49	62.2	9.1	67.4	9.9	72.6	10.7	83.0	12.4	86.0	12.2
	12	41.5	6.11	51.8	7.62	62.2	9.2	67.4	10.1	72.6	10.9	82.9	12.6	84.9	12.1
	14	41.5	6.20	51.8	7.75	62.2	9.4	67.4	10.2	72.6	11.1	81.8	12.5	83.8	12.1
	16	41.5	6.30	51.8	7.88	62.2	9.6	67.4	10.4	72.6	11.3	80.7	12.5	82.7	12.5
	18	41.5	6.41	51.8	8.02	62.2	9.7	67.4	10.6	72.6	11.5	79.6	13.0	81.6	13.1
	20	41.5	6.51	51.8	8.17	62.2	10.0	67.4	11.1	72.6	12.4	78.5	13.7	80.5	13.8
	21	41.5	6.57	51.8	8.24	62.2	10.3	67.4	11.5	72.6	12.8	78.0	14.0	79.9	14.1
	23	41.5	6.69	51.8	8.7	62.2	11.0	67.4	12.3	72.6	13.7	76.9	14.6	78.8	14.8
	25	41.5	7.05	51.8	9.3	62.2	11.8	67.4	13.2	72.6	14.7	75.8	15.3	77.7	15.4
	27	41.5	7.49	51.8	9.9	62.2	12.6	67.4	14.1	72.6	15.7	74.7	15.9	76.6	16.1
	29	41.5	8.0	51.8	10.5	62.2	13.4	67.4	15.0	71.7	16.4	73.6	16.5	75.5	16.7
	31	41.5	8.4	51.8	11.2	62.2	14.3	67.4	16.0	70.6	17.0	72.5	17.2	74.4	17.4
	33	41.5	9.0	51.8	11.9	62.2	15.2	67.4	17.1	69.5	17.7	71.4	17.8	73.3	18.0
	35	41.5	9.5	51.8	12.6	62.2	16.2	67.4	18.2	68.4	18.3	70.3	18.5	72.3	18.7
	37	41.5	10.1	51.8	13.4	62.2	17.3	66.3	18.9	67.3	19.0	69.2	19.2	71.2	19.4
	39	41.5	10.7	51.8	14.2	62.2	18.4	65.2	19.5	66.2	19.6	68.1	19.8	70.1	20.0

NOTES - ANMERKUNGEN - Σημειώσεις - NOTAS - REMARQUES - NOTE - OPMERKINGEN - примечания - NOTLAR

- The above table shows the average value of conditions which may occur.
Die obige Tabelle zeigt den Durchschnittswert der Bedingungen, die auftreten können.
 Στον παραπάνω πίνακα αναγράφεται η μέση τιμή για συνθήκες που μπορεί να προκύψουν.
La tabla de arriba muestra el valor medio de condiciones que pueden ocurrir.
 Le tableau ci-dessus donne la valeur moyenne pour des conditions qui peuvent survenir.
La tabella in alto mostra il valore delle condizioni medie che si possono riscontrare.
 De tabel hierboven geeft de gemiddelde waarde aan van situaties die kunnen voorvallen.
 Таблица расположенная выше показывает среднее значение условий, которые могут наступить.
 Yukarıdaki tablo meydana gelebilecek koşulların ortalama değerini göstermektedir.

3D079549

5 Таблицы производительности

5 - 1 Таблицы холодопроизводительности

5

RXYQ24T															
Indoor air temp. °CWB															
Combination(%) (Capacity index)	Outdoor air temp. (°CDB)	14.0		16.0		18.0		19.0		20.0		22.0		24.0	
		TC	PI	TC	PI	TC	PI	TC	PI	TC	PI	TC	PI	TC	PI
		KW	KW	KW	KW	KW	KW	KW	KW	KW	KW	KW	KW	KW	KW
90% 60.66 kW	10	37.3	5.46	46.7	6.74	56.0	8.11	60.7	8.8	65.3	9.6	74.7	11.0	84.0	12.6
	12	37.3	5.54	46.7	6.85	56.0	8.25	60.7	9.0	65.3	9.7	74.7	11.2	83.1	12.6
	14	37.3	5.62	46.7	6.96	56.0	8.39	60.7	9.1	65.3	9.9	74.7	11.4	82.0	12.5
	16	37.3	5.71	46.7	7.08	56.0	8.54	60.7	9.3	65.3	10.1	74.7	11.7	80.9	12.4
	18	37.3	5.80	46.7	7.20	56.0	8.7	60.7	9.5	65.3	10.3	74.7	12.0	79.8	13.0
	20	37.3	5.89	46.7	7.33	56.0	8.9	60.7	9.6	65.3	10.7	74.7	12.9	78.7	13.7
	21	37.3	5.94	46.7	7.39	56.0	9.0	60.7	10.0	65.3	11.0	74.7	13.3	78.2	14.0
	23	37.3	6.04	46.7	7.61	56.0	9.6	60.7	10.7	65.3	11.8	74.7	14.3	77.1	14.6
	25	37.3	6.25	46.7	8.11	56.0	10.2	60.7	11.4	65.3	12.6	74.2	15.1	76.0	15.3
	27	37.3	6.64	46.7	8.6	56.0	10.9	60.7	12.2	65.3	13.5	73.1	15.8	74.9	15.9
	29	37.3	7.05	46.7	9.2	56.0	11.6	60.7	13.0	65.3	14.4	72.0	16.4	73.8	16.6
	31	37.3	7.47	46.7	9.8	56.0	12.4	60.7	13.8	65.3	15.3	71.0	17.1	72.7	17.2
	33	37.3	7.91	46.7	10.4	56.0	13.2	60.7	14.7	65.3	16.3	69.9	17.7	71.6	17.9
	35	37.3	8.4	46.7	11.0	56.0	14.0	60.7	15.7	65.3	17.4	68.8	18.3	70.5	18.5
	37	37.3	8.9	46.7	11.7	56.0	14.9	60.7	16.7	65.3	18.5	67.7	19.0	69.4	19.2
	39	37.3	9.4	46.7	12.4	56.0	15.8	60.7	17.7	64.8	19.5	66.6	19.6	68.3	19.8
80% 53.92 kW	10	33.2	4.92	41.5	6.01	49.8	7.19	53.9	7.80	58.1	8.43	66.4	9.7	74.7	11.0
	12	33.2	4.99	41.5	6.11	49.8	7.30	53.9	7.93	58.1	8.57	66.4	9.9	74.7	11.2
	14	33.2	5.06	41.5	6.20	49.8	7.43	53.9	8.07	58.1	8.72	66.4	10.1	74.7	11.4
	16	33.2	5.14	41.5	6.30	49.8	7.56	53.9	8.21	58.1	8.9	66.4	10.2	74.7	11.7
	18	33.2	5.21	41.5	6.41	49.8	7.69	53.9	8.36	58.1	9.0	66.4	10.4	74.7	12.0
	20	33.2	5.29	41.5	6.51	49.8	7.83	53.9	8.51	58.1	9.2	66.4	10.9	74.7	12.9
	21	33.2	5.33	41.5	6.57	49.8	7.90	53.9	8.59	58.1	9.4	66.4	11.3	74.7	13.3
	23	33.2	5.42	41.5	6.69	49.8	8.25	53.9	9.1	58.1	10.1	66.4	12.1	74.7	14.3
	25	33.2	5.51	41.5	7.05	49.8	8.8	53.9	9.7	58.1	10.7	66.4	12.9	74.2	15.1
	27	33.2	5.84	41.5	7.49	49.8	9.4	53.9	10.4	58.1	11.5	66.4	13.8	73.1	15.8
	29	33.2	6.19	41.5	7.96	49.8	10.0	53.9	11.1	58.1	12.2	66.4	14.7	72.0	16.4
	31	33.2	6.56	41.5	8.4	49.8	10.6	53.9	11.8	58.1	13.0	66.4	15.7	71.0	17.1
	33	33.2	6.94	41.5	9.0	49.8	11.3	53.9	12.5	58.1	13.8	66.4	16.7	69.9	17.7
	35	33.2	7.34	41.5	9.5	49.8	12.0	53.9	13.3	58.1	14.7	66.4	17.8	68.8	18.3
	37	33.2	7.76	41.5	10.1	49.8	12.7	53.9	14.1	58.1	15.7	66.1	18.8	67.7	19.0
	39	33.2	8.2	41.5	10.7	49.8	13.5	53.9	15.0	58.1	16.6	65.0	19.5	66.6	19.6
70% 47.18 kW	10	29.0	4.41	36.3	5.32	43.6	6.30	47.2	6.81	50.8	7.34	58.1	8.43	65.3	9.6
	12	29.0	4.47	36.3	5.40	43.6	6.40	47.2	6.92	50.8	7.46	58.1	8.57	65.3	9.7
	14	29.0	4.53	36.3	5.48	43.6	6.50	47.2	7.04	50.8	7.59	58.1	8.72	65.3	9.9
	16	29.0	4.59	36.3	5.56	43.6	6.61	47.2	7.16	50.8	7.72	58.1	8.88	65.3	10.1
	18	29.0	4.65	36.3	5.65	43.6	6.72	47.2	7.28	50.8	7.85	58.1	9.0	65.3	10.3
	20	29.0	4.72	36.3	5.74	43.6	6.84	47.2	7.41	50.8	8.00	58.1	9.2	65.3	10.7
	21	29.0	4.75	36.3	5.79	43.6	6.89	47.2	7.47	50.8	8.07	58.1	9.4	65.3	11.0
	23	29.0	4.82	36.3	5.88	43.6	7.02	47.2	7.72	50.8	8.46	58.1	10.1	65.3	11.8
	25	29.0	4.90	36.3	6.06	43.6	7.46	47.2	8.22	50.8	9.0	58.1	10.7	65.3	12.6
	27	29.0	5.11	36.3	6.44	43.6	7.94	47.2	8.76	50.8	9.6	58.1	11.5	65.3	13.5
	29	29.0	5.40	36.3	6.83	43.6	8.44	47.2	9.3	50.8	10.2	58.1	12.2	65.3	14.4
	31	29.0	5.71	36.3	7.24	43.6	9.0	47.2	9.9	50.8	10.9	58.1	13.0	65.3	15.3
	33	29.0	6.04	36.3	7.66	43.6	9.5	47.2	10.5	50.8	11.6	58.1	13.8	65.3	16.3
	35	29.0	6.37	36.3	8.11	43.6	10.1	47.2	11.2	50.8	12.3	58.1	14.7	65.3	17.4
	37	29.0	6.73	36.3	8.6	43.6	10.7	47.2	11.8	50.8	13.1	58.1	15.7	65.3	18.5
	39	29.0	7.10	36.3	9.1	43.6	11.3	47.2	12.6	50.8	13.9	58.1	16.6	64.8	19.5
60% 40.44 kW	10	24.9	3.93	31.1	4.66	37.3	5.46	40.4	5.87	43.6	6.30	49.8	7.19	56.0	8.11
	12	24.9	3.97	31.1	4.73	37.3	5.54	40.4	5.96	43.6	6.40	49.8	7.30	56.0	8.25
	14	24.9	4.02	31.1	4.79	37.3	5.62	40.4	6.05	43.6	6.50	49.8	7.43	56.0	8.39
	16	24.9	4.07	31.1	4.86	37.3	5.71	40.4	6.15	43.6	6.61	49.8	7.56	56.0	8.54
	18	24.9	4.12	31.1	4.93	37.3	5.80	40.4	6.25	43.6	6.72	49.8	7.69	56.0	8.70
	20	24.9	4.18	31.1	5.00	37.3	5.89	40.4	6.36	43.6	6.84	49.8	7.83	56.0	8.86
	21	24.9	4.20	31.1	5.04	37.3	5.94	40.4	6.41	43.6	6.89	49.8	7.90	56.0	8.98
	23	24.9	4.26	31.1	5.12	37.3	6.04	40.4	6.52	43.6	7.02	49.8	8.25	56.0	9.6
	25	24.9	4.32	31.1	5.20	37.3	6.25	40.4	6.84	43.6	7.46	49.8	8.79	56.0	10.2
	27	24.9	4.42	31.1	5.47	37.3	6.64	40.4	7.27	43.6	7.94	49.8	9.4	56.0	10.9
	29	24.9	4.67	31.1	5.79	37.3	7.05	40.4	7.72	43.6	8.44	49.8	10.0	56.0	11.6
	31	24.9	4.93	31.1	6.13	37.3	7.47	40.4	8.20	43.6	9.0	49.8	10.6	56.0	12.4
	33	24.9	5.20	31.1	6.48	37.3	7.91	40.4	8.69	43.6	9.5	49.8	11.3	56.0	13.2
	35	24.9	5.48	31.1	6.85	37.3	8.38	40.4	9.2	43.6	10.1	49.8	12.0	56.0	14.0
	37	24.9	5.78	31.1	7.23	37.3	8.9	40.4	9.8	43.6	10.7	49.8	12.7	56.0	14.9
	39	24.9	6.09	31.1	7.64	37.3	9.4	40.4	10.3	43.6	11.3	49.8	13.5	56.0	15.8
50% 33.70 kW	10	20.7	3.47	25.9	4.04	31.1	4.66	33.7	4.99	36.3	5.32	41.5	6.01	46.7	6.74
	12	20.7	3.50	25.9	4.09	31.1	4.73	33.7	5.06	36.3	5.40	41.5	6.11	46.7	6.85
	14	20.7	3.54	25.9	4.14	31.1	4.79	33.7	5.13	36.3	5.48	41.5	6.20	46.7	6.96
	16	20.7	3.58	25.9	4.20	31.1	4.86	33.7	5.21	36.3	5.56	41.5	6.30	46.7	7.08
	18	20.7	3.62	25.9	4.25	31.1	4.93	33.7	5.28	36.3	5.65	41.5	6.41	46.7	7.20
	20	20.7	3.66	25.9	4.31	31.1	5.00	33.7	5.37	36.3	5.74	41.5	6.51	46.7	7.33
	21	20.7	3.69	25.9	4.34	31.1	5.04	33.7	5.41	36.3	5.79	41.5	6.57	46.7	7.39
	23	20.7	3.73	25.9	4.40	31.1	5.12	33.7	5.49	36.3	5.88	41.5	6.69	46.7	7.61
	25	20.7	3.78	25.9	4.46	31.1	5.20	33.7	5.60	36.3	6.06	41.5	7.05	46.7	8.11
	27	20.7	3.83	25.9	4.59	31.1	5.47	33.7	5.94	36.3	6.44	41.5	7.49	46.7	8.64
	29	20.7	4.00	25.9	4.85	31.1	5.79	33.7	6.30	36.3	6.83	41.5	7.96	46.7	9.18
	31	20.7	4.22	25.9	5.12	31.1	6.13	33.7	6.67	36.3	7.24	41.5	8.45	46.7	9.8
	33	20.7	4.44	25.9	5.40	31.1	6.48	33.7	7.06	36.3	7.66	41.5	8.96	46.7	10.4
	35	20.7	4.67	25.9	5.70	31.1	6.85	33.7	7.46	36.3	8.11	41.5	9.5	46.7	11.0
	37	20.7	4.91	25.9	6.01	31.1	7.23	33.7	7.89	36.3	8.58	41.5	10.1	46.7	11.7
	39	20.7	5.16	25.9	6.33	31.1	7.64	33.7	8.34	36.3	9.1	41.5	10.7	46.7	12.4

3D079549

5 Таблицы производительности

5 - 1 Таблицы холодопроизводительности

RXYQ26T

TC : Total capacity (kW); PI: Power Input (kW) (Comp. + Outdoor fan motor)

Indoor air temp. °CWB															
Combination(%) (Capacity index)	Outdoor air temp. (°CDB)	14.0		16.0		18.0		19.0		20.0		22.0		24.0	
		TC	PI	TC	PI	TC	PI	TC	PI	TC	PI	TC	PI	TC	PI
		KW	KW	KW	KW	KW	KW	KW	KW	KW	KW	KW	KW	KW	KW
130% 95.55 kW	10	58.8	8.6	73.5	10.8	88.2	13.2	95.6	14.5	102.9	15.7	117.6	18.1	132.3	20.4
	12	58.8	8.7	73.5	11.0	88.2	13.5	95.6	14.7	102.9	15.9	117.6	18.4	132.3	21.9
	14	58.8	8.8	73.5	11.2	88.2	13.7	95.6	15.0	102.9	16.2	117.6	19.7	132.3	23.8
	16	58.8	9.0	73.5	11.4	88.2	14.0	95.6	15.5	102.9	17.3	117.6	21.3	132.3	25.7
	18	58.8	9.2	73.5	11.7	88.2	14.8	95.6	16.7	102.9	18.6	117.6	22.9	132.3	27.7
	20	58.8	9.3	73.5	12.2	88.2	15.9	95.6	17.9	102.9	20.0	117.6	24.7	132.3	29.9
	21	58.8	9.4	73.5	12.7	88.2	16.5	95.6	18.6	102.9	20.8	117.6	25.6	132.3	31.0
	23	58.8	10.0	73.5	13.5	88.2	17.6	95.6	19.9	102.9	22.3	117.6	27.5	132.3	33.3
	25	58.8	10.7	73.5	14.5	88.2	18.9	95.6	21.3	102.9	23.9	117.6	29.5	132.3	35.8
	27	58.8	11.4	73.5	15.5	88.2	20.2	95.6	22.8	102.9	25.6	117.6	31.6	132.3	38.3
	29	58.8	12.1	73.5	16.5	88.2	21.6	95.6	24.4	102.9	27.4	117.6	33.9	132.3	41.1
	31	58.8	12.9	73.5	17.6	88.2	23.1	95.6	26.1	102.9	29.3	117.6	36.3	132.3	44.0
	33	58.8	13.7	73.5	18.8	88.2	24.6	95.6	27.9	102.9	31.3	117.6	38.8	132.3	47.1
	35	58.8	14.6	73.5	20.0	88.2	26.3	95.6	29.7	102.9	33.4	117.6	41.5	132.3	50.4
37	58.8	15.5	73.5	21.3	88.2	28.0	95.6	31.7	102.9	35.7	117.6	44.3	132.3	53.9	
39	58.8	16.5	73.5	22.7	88.2	29.9	95.6	33.8	102.9	38.1	117.6	47.3	132.3	57.6	
120% 88.20 kW	10	54.3	7.9	67.8	9.9	81.4	12.1	88.2	13.2	95.0	14.4	108.6	16.6	122.1	18.8
	12	54.3	8.0	67.8	10.1	81.4	12.3	88.2	13.5	95.0	14.6	108.6	16.9	122.1	19.3
	14	54.3	8.1	67.8	10.3	81.4	12.6	88.2	13.7	95.0	14.9	108.6	17.4	122.1	20.9
	16	54.3	8.3	67.8	10.5	81.4	12.8	88.2	14.0	95.0	15.3	108.6	18.8	122.1	22.6
	18	54.3	8.4	67.8	10.7	81.4	13.2	88.2	14.8	95.0	16.5	108.6	20.2	122.1	24.4
	20	54.3	8.6	67.8	11.0	81.4	14.1	88.2	15.9	95.0	17.7	108.6	21.8	122.1	26.2
	21	54.3	8.7	67.8	11.3	81.4	14.6	88.2	16.5	95.0	18.4	108.6	22.6	122.1	27.2
	23	54.3	9.0	67.8	12.1	81.4	15.7	88.2	17.6	95.0	19.7	108.6	24.2	122.1	29.2
	25	54.3	9.6	67.8	13.0	81.4	16.8	88.2	18.9	95.0	21.1	108.6	26.0	122.1	31.4
	27	54.3	10.3	67.8	13.8	81.4	17.9	88.2	20.2	95.0	22.6	108.6	27.8	122.1	33.6
	29	54.3	10.9	67.8	14.7	81.4	19.2	88.2	21.6	95.0	24.2	108.6	29.8	122.1	36.0
	31	54.3	11.6	67.8	15.7	81.4	20.5	88.2	23.1	95.0	25.8	108.6	31.9	122.1	38.6
	33	54.3	12.4	67.8	16.7	81.4	21.8	88.2	24.6	95.0	27.6	108.6	34.1	122.1	41.3
	35	54.3	13.1	67.8	17.8	81.4	23.3	88.2	26.3	95.0	29.5	108.6	36.4	122.1	44.1
37	54.3	13.9	67.8	19.0	81.4	24.8	88.2	28.0	95.0	31.4	108.6	38.9	122.1	47.2	
39	54.3	14.8	67.8	20.2	81.4	26.4	88.2	29.9	95.0	33.5	108.6	41.5	122.1	50.4	
110% 80.85 kW	10	49.8	7.23	62.2	9.1	74.6	11.0	80.9	12.0	87.1	13.0	99.5	15.1	111.9	17.1
	12	49.8	7.34	62.2	9.2	74.6	11.2	80.9	12.2	87.1	13.3	99.5	15.4	111.9	17.4
	14	49.8	7.46	62.2	9.4	74.6	11.4	80.9	12.5	87.1	13.5	99.5	15.6	111.9	18.2
	16	49.8	7.59	62.2	9.6	74.6	11.6	80.9	12.7	87.1	13.8	99.5	16.4	111.9	19.7
	18	49.8	7.72	62.2	9.7	74.6	11.8	80.9	13.0	87.1	14.5	99.5	17.7	111.9	21.2
	20	49.8	7.9	62.2	9.9	74.6	12.5	80.9	14.0	87.1	15.6	99.5	19.0	111.9	22.9
	21	49.8	7.9	62.2	10.1	74.6	12.9	80.9	14.5	87.1	16.1	99.5	19.7	111.9	23.7
	23	49.8	8.1	62.2	10.8	74.6	13.8	80.9	15.5	87.1	17.3	99.5	21.2	111.9	25.4
	25	49.8	8.7	62.2	11.5	74.6	14.8	80.9	16.6	87.1	18.5	99.5	22.7	111.9	27.3
	27	49.8	9.2	62.2	12.3	74.6	15.8	80.9	17.8	87.1	19.8	99.5	24.3	111.9	29.2
	29	49.8	9.8	62.2	13.1	74.6	16.9	80.9	19.0	87.1	21.2	99.5	26.0	111.9	31.3
	31	49.8	10.4	62.2	13.9	74.6	18.0	80.9	20.2	87.1	22.6	99.5	27.8	111.9	33.5
	33	49.8	11.1	62.2	14.8	74.6	19.2	80.9	21.6	87.1	24.1	99.5	29.7	111.9	35.8
	35	49.8	11.7	62.2	15.8	74.6	20.4	80.9	23.0	87.1	25.7	99.5	31.7	111.9	38.3
37	49.8	12.4	62.2	16.8	74.6	21.8	80.9	24.5	87.1	27.5	99.5	33.8	111.9	40.9	
39	49.8	13.2	62.2	17.8	74.6	23.2	80.9	26.1	87.1	29.3	99.5	36.1	111.9	43.7	
100% 73.50 kW	10	45.2	6.59	56.5	8.2	67.8	9.9	73.5	10.8	79.2	11.8	90.5	13.6	101.8	15.5
	12	45.2	6.69	56.5	8.4	67.8	10.1	73.5	11.0	79.2	12.0	90.5	13.9	101.8	15.8
	14	45.2	6.80	56.5	8.5	67.8	10.3	73.5	11.2	79.2	12.2	90.5	14.1	101.8	16.0
	16	45.2	6.91	56.5	8.6	67.8	10.5	73.5	11.4	79.2	12.4	90.5	14.4	101.8	17.0
	18	45.2	7.02	56.5	8.8	67.8	10.7	73.5	11.7	79.2	12.6	90.5	15.3	101.8	18.3
	20	45.2	7.14	56.5	9.0	67.8	11.0	73.5	12.2	79.2	13.6	90.5	16.5	101.8	19.7
	21	45.2	7.20	56.5	9.0	67.8	11.3	73.5	12.7	79.2	14.1	90.5	17.1	101.8	20.4
	23	45.2	7.33	56.5	9.5	67.8	12.1	73.5	13.5	79.2	15.1	90.5	18.3	101.8	21.9
	25	45.2	7.7	56.5	10.2	67.8	13.0	73.5	14.5	79.2	16.1	90.5	19.6	101.8	23.5
	27	45.2	8.2	56.5	10.8	67.8	13.8	73.5	15.5	79.2	17.2	90.5	21.0	101.8	25.2
	29	45.2	8.7	56.5	11.5	67.8	14.7	73.5	16.5	79.2	18.4	90.5	22.4	101.8	26.9
	31	45.2	9.3	56.5	12.3	67.8	15.7	73.5	17.6	79.2	19.6	90.5	24.0	101.8	28.8
	33	45.2	9.8	56.5	13.0	67.8	16.7	73.5	18.8	79.2	20.9	90.5	25.6	101.8	30.7
	35	45.2	10.4	56.5	13.9	67.8	17.8	73.5	20.0	79.2	22.3	90.5	27.3	101.8	32.8
37	45.2	11.0	56.5	14.7	67.8	19.0	73.5	21.3	79.2	23.8	90.5	29.1	101.8	35.1	
39	45.2	11.7	56.5	15.6	67.8	20.2	73.5	22.7	79.2	25.3	90.5	31.1	101.8	37.4	

NOTES - ANMERKUNGEN - Σημειώσεις - NOTAS - REMARQUES - NOTE - OPMERKINGEN - примечания - NOTLAR

- The above table shows the average value of conditions which may occur.
Die obige Tabelle zeigt den Durchschnittswert der Bedingungen, die auftreten können.
 Στον παραπάνω πίνακα αναγράφεται η μέση τιμή για συνθήκες που μπορεί να προκύψουν.
La tabla de arriba muestra el valor medio de condiciones que pueden ocurrir.
 Le tableau ci-dessus donne la valeur moyenne pour des conditions qui peuvent survenir.
La tabella in alto mostra il valore delle condizioni medie che si possono riscontrare.
 De tabel hierboven geeft de gemiddelde waarde aan van situaties die kunnen voorvallen.
Таблица расположенная выше показывает среднее значение условий, которые могут наступить.
 Yukarıdaki tablo meydana gelebilecek koşulların ortalama değerini göstermektedir.

3D079549

5 Таблицы производительности

5 - 1 Таблицы холодопроизводительности

5

RXYQ26T															
Indoor air temp. °CWB															
Combination(%) (Capacity index)	Outdoor air temp. (°CDB)	14.0		16.0		18.0		19.0		20.0		22.0		24.0	
		TC	PI	TC	PI	TC	PI	TC	PI	TC	PI	TC	PI	TC	PI
		KW	KW	KW	KW	KW	KW	KW	KW	KW	KW	KW	KW	KW	KW
90% 66,15 kW	10	40.7	5.98	50.9	7.39	61.1	8.9	66.2	9.7	71.2	10.5	81.4	12.1	91.6	13.8
	12	40.7	6.07	50.9	7.51	61.1	9.0	66.2	9.8	71.2	10.7	81.4	12.3	91.6	14.0
	14	40.7	6.16	50.9	7.63	61.1	9.2	66.2	10.0	71.2	10.9	81.4	12.6	91.6	14.3
	16	40.7	6.25	50.9	7.76	61.1	9.4	66.2	10.2	71.2	11.1	81.4	12.8	91.6	14.6
	18	40.7	6.35	50.9	7.89	61.1	9.5	66.2	10.4	71.2	11.3	81.4	13.2	91.6	15.6
	20	40.7	6.46	50.9	8.03	61.1	9.7	66.2	10.6	71.2	11.7	81.4	14.1	91.6	16.8
	21	40.7	6.51	50.9	8.10	61.1	9.8	66.2	11.0	71.2	12.1	81.4	14.6	91.6	17.4
	23	40.7	6.62	50.9	8.3	61.1	10.5	66.2	11.7	71.2	13.0	81.4	15.7	91.6	18.7
	25	40.7	6.85	50.9	8.9	61.1	11.2	66.2	12.5	71.2	13.9	81.4	16.8	91.6	20.0
	27	40.7	7.28	50.9	9.5	61.1	12.0	66.2	13.4	71.2	14.8	81.4	17.9	91.6	21.4
	29	40.7	7.72	50.9	10.1	61.1	12.8	66.2	14.2	71.2	15.8	81.4	19.2	91.6	22.9
	31	40.7	8.2	50.9	10.7	61.1	13.6	66.2	15.2	71.2	16.8	81.4	20.5	91.6	24.4
	33	40.7	8.7	50.9	11.4	61.1	14.5	66.2	16.1	71.2	17.9	81.4	21.8	91.6	26.1
	35	40.7	9.2	50.9	12.1	61.1	15.4	66.2	17.2	71.2	19.1	81.4	23.3	91.6	27.8
37	40.7	9.7	50.9	12.8	61.1	16.3	66.2	18.3	71.2	20.3	81.4	24.8	91.6	29.7	
39	40.7	10.3	50.9	13.6	61.1	17.4	66.2	19.4	71.2	21.6	81.4	26.4	91.6	31.7	
80% 58,80 kW	10	36.2	5.39	45.2	6.59	54.3	7.88	58.8	8.55	63.3	9.2	72.4	10.7	81.4	12.1
	12	36.2	5.47	45.2	6.69	54.3	8.01	58.8	8.7	63.3	9.4	72.4	10.8	81.4	12.3
	14	36.2	5.55	45.2	6.80	54.3	8.15	58.8	8.8	63.3	9.6	72.4	11.0	81.4	12.6
	16	36.2	5.63	45.2	6.91	54.3	8.29	58.8	9.0	63.3	9.7	72.4	11.2	81.4	12.8
	18	36.2	5.71	45.2	7.02	54.3	8.43	58.8	9.2	63.3	9.9	72.4	11.5	81.4	13.2
	20	36.2	5.80	45.2	7.14	54.3	8.6	58.8	9.3	63.3	10.1	72.4	12.0	81.4	14.1
	21	36.2	5.84	45.2	7.20	54.3	8.7	58.8	9.4	63.3	10.3	72.4	12.4	81.4	14.6
	23	36.2	5.94	45.2	7.33	54.3	9.0	58.8	10.0	63.3	11.0	72.4	13.3	81.4	15.7
	25	36.2	6.04	45.2	7.73	54.3	9.6	58.8	10.7	63.3	11.8	72.4	14.2	81.4	16.8
	27	36.2	6.40	45.2	8.2	54.3	10.3	58.8	11.4	63.3	12.6	72.4	15.1	81.4	17.9
	29	36.2	6.79	45.2	8.7	54.3	10.9	58.8	12.1	63.3	13.4	72.4	16.1	81.4	19.2
	31	36.2	7.19	45.2	9.3	54.3	11.6	58.8	12.9	63.3	14.3	72.4	17.2	81.4	20.5
	33	36.2	7.61	45.2	9.8	54.3	12.4	58.8	13.7	63.3	15.2	72.4	18.3	81.4	21.8
	35	36.2	8.0	45.2	10.4	54.3	13.1	58.8	14.6	63.3	16.2	72.4	19.5	81.4	23.3
37	36.2	8.5	45.2	11.0	54.3	13.9	58.8	15.5	63.3	17.2	72.4	20.8	81.4	24.8	
39	36.2	9.0	45.2	11.7	54.3	14.8	58.8	16.5	63.3	18.3	72.4	22.1	81.4	26.4	
70% 51,45 kW	10	31.7	4.83	39.6	5.83	47.5	6.91	51.5	7.47	55.4	8.05	63.3	9.2	71.2	10.5
	12	31.7	4.89	39.6	5.92	47.5	7.01	51.5	7.59	55.4	8.18	63.3	9.4	71.2	10.7
	14	31.7	4.96	39.6	6.00	47.5	7.13	51.5	7.72	55.4	8.32	63.3	9.6	71.2	10.9
	16	31.7	5.03	39.6	6.10	47.5	7.25	51.5	7.85	55.4	8.46	63.3	9.7	71.2	11.1
	18	31.7	5.10	39.6	6.19	47.5	7.37	51.5	7.98	55.4	8.61	63.3	9.9	71.2	11.3
	20	31.7	5.17	39.6	6.29	47.5	7.49	51.5	8.12	55.4	8.8	63.3	10.1	71.2	11.7
	21	31.7	5.21	39.6	6.34	47.5	7.56	51.5	8.20	55.4	8.8	63.3	10.3	71.2	12.1
	23	31.7	5.29	39.6	6.45	47.5	7.69	51.5	8.46	55.4	9.3	63.3	11.0	71.2	13.0
	25	31.7	5.37	39.6	6.64	47.5	8.18	51.5	9.0	55.4	9.9	63.3	11.8	71.2	13.9
	27	31.7	5.59	39.6	7.05	47.5	8.7	51.5	9.6	55.4	10.5	63.3	12.6	71.2	14.8
	29	31.7	5.92	39.6	7.48	47.5	9.3	51.5	10.2	55.4	11.2	63.3	13.4	71.2	15.8
	31	31.7	6.26	39.6	7.93	47.5	9.8	51.5	10.9	55.4	11.9	63.3	14.3	71.2	16.8
	33	31.7	6.61	39.6	8.4	47.5	10.4	51.5	11.5	55.4	12.7	63.3	15.2	71.2	17.9
	35	31.7	6.98	39.6	8.9	47.5	11.1	51.5	12.2	55.4	13.5	63.3	16.2	71.2	19.1
37	31.7	7.37	39.6	9.4	47.5	11.7	51.5	13.0	55.4	14.3	63.3	17.2	71.2	20.3	
39	31.7	7.78	39.6	10.0	47.5	12.4	51.5	13.8	55.4	15.2	63.3	18.3	71.2	21.6	
60% 44,10 kW	10	27.1	4.30	33.9	5.11	40.7	5.98	44.1	6.44	47.5	6.91	54.3	7.88	61.1	8.90
	12	27.1	4.35	33.9	5.18	40.7	6.07	44.1	6.53	47.5	7.01	54.3	8.01	61.1	9.0
	14	27.1	4.40	33.9	5.25	40.7	6.16	44.1	6.64	47.5	7.13	54.3	8.15	61.1	9.2
	16	27.1	4.46	33.9	5.32	40.7	6.25	44.1	6.74	47.5	7.25	54.3	8.29	61.1	9.4
	18	27.1	4.51	33.9	5.40	40.7	6.35	44.1	6.85	47.5	7.37	54.3	8.43	61.1	9.5
	20	27.1	4.57	33.9	5.48	40.7	6.46	44.1	6.97	47.5	7.49	54.3	8.58	61.1	9.7
	21	27.1	4.60	33.9	5.52	40.7	6.51	44.1	7.03	47.5	7.56	54.3	8.66	61.1	9.8
	23	27.1	4.67	33.9	5.61	40.7	6.62	44.1	7.15	47.5	7.69	54.3	9.0	61.1	10.5
	25	27.1	4.73	33.9	5.70	40.7	6.85	44.1	7.50	47.5	8.18	54.3	9.6	61.1	11.2
	27	27.1	4.84	33.9	5.99	40.7	7.28	44.1	7.97	47.5	8.71	54.3	10.3	61.1	12.0
	29	27.1	5.12	33.9	6.35	40.7	7.72	44.1	8.47	47.5	9.3	54.3	10.9	61.1	12.8
	31	27.1	5.40	33.9	6.71	40.7	8.19	44.1	9.0	47.5	9.8	54.3	11.6	61.1	13.6
	33	27.1	5.70	33.9	7.10	40.7	8.7	44.1	9.5	47.5	10.4	54.3	12.4	61.1	14.5
	35	27.1	6.01	33.9	7.50	40.7	9.2	44.1	10.1	47.5	11.1	54.3	13.1	61.1	15.4
37	27.1	6.33	33.9	7.93	40.7	9.7	44.1	10.7	47.5	11.7	54.3	13.9	61.1	16.3	
39	27.1	6.67	33.9	8.4	40.7	10.3	44.1	11.3	47.5	12.4	54.3	14.8	61.1	17.4	
50% 36,75 kW	10	22.6	3.79	28.3	4.43	33.9	5.11	36.8	5.46	39.6	5.83	45.2	6.59	50.9	7.39
	12	22.6	3.83	28.3	4.48	33.9	5.18	36.8	5.54	39.6	5.92	45.2	6.69	50.9	7.51
	14	22.6	3.88	28.3	4.54	33.9	5.25	36.8	5.62	39.6	6.00	45.2	6.80	50.9	7.63
	16	22.6	3.92	28.3	4.60	33.9	5.32	36.8	5.70	39.6	6.10	45.2	6.91	50.9	7.76
	18	22.6	3.96	28.3	4.66	33.9	5.40	36.8	5.79	39.6	6.19	45.2	7.02	50.9	7.89
	20	22.6	4.01	28.3	4.72	33.9	5.48	36.8	5.88	39.6	6.29	45.2	7.14	50.9	8.03
	21	22.6	4.03	28.3	4.75	33.9	5.52	36.8	5.93	39.6	6.34	45.2	7.20	50.9	8.10
	23	22.6	4.08	28.3	4.82	33.9	5.61	36.8	6.02	39.6	6.45	45.2	7.33	50.9	8.35
	25	22.6	4.13	28.3	4.89	33.9	5.70	36.8	6.14	39.6	6.64	45.2	7.73	50.9	8.90
	27	22.6	4.19	28.3	5.03	33.9	5.99	36.8	6.51	39.6	7.05	45.2	8.21	50.9	9.5
	29	22.6	4.38	28.3	5.31	33.9	6.35	36.8	6.90	39.6	7.48	45.2	8.73	50.9	10.1
	31	22.6	4.62	28.3	5.61	33.9	6.71	36.8	7.31	39.6	7.93	45.2	9.3	50.9	10.7
	33	22.6	4.86	28.3	5.92	33.9	7.10	36.8	7.74	39.6	8.40	45.2	9.8	50.9	11.4
	35	22.6	5.12	28.3	6.24	33.9	7.50	36.8	8.18	39.6	8.9	45.2	10.4	50.9	12.1
37	22.6	5.38	28.3	6.58	33.9	7.93	36.8	8.65	39.6	9.4	45.2	11.0	50.9	12.8	
39	22.6	5.65	28.3	6.93	33.9	8.37	36.8	9.1	39.6	10.0	45.2	11.7	50.9	13.6	

3D079549

5 Таблицы производительности

5 - 1 Таблицы холодопроизводительности

RXYQ28T															
Indoor air temp. °CWB															
Combination(%) (Capacity index)	Outdoor air temp. (°CDB)	14.0		16.0		18.0		19.0		20.0		22.0		24.0	
		TC	PI	TC	PI	TC	PI	TC	PI	TC	PI	TC	PI	TC	PI
		KW	KW	KW	KW	KW	KW	KW	KW	KW	KW	KW	KW	KW	KW
130% 102.05 kW	10	62.8	9.4	78.5	11.9	94.2	14.6	98.9	15.1	100	14.7	103	14.0	106	13.2
	12	62.8	9.6	78.5	12.1	94.2	14.8	97.6	15.0	99.1	14.6	102	13.9	105	13.9
	14	62.8	9.7	78.5	12.4	94.2	15.1	96.3	14.9	97.8	14.5	101	14.5	104	14.7
	16	62.8	9.9	78.5	12.6	93.6	15.2	95.0	15.0	96.5	15.1	99.4	15.3	102	15.5
	18	62.8	10.1	78.5	12.8	92.3	15.7	93.8	15.8	95.2	15.9	98.2	16.1	101	16.2
	20	62.8	10.3	78.5	13.4	91.0	16.5	92.5	16.6	94.0	16.7	96.9	16.9	99.8	17.0
	21	62.8	10.4	78.5	13.9	90.4	16.8	91.8	16.9	93.3	17.0	96.3	17.2	99.2	17.4
	23	62.8	11.0	78.5	14.9	89.1	17.6	90.6	17.7	92.0	17.8	95.0	18.0	97.9	18.3
	25	62.8	11.8	78.5	15.9	87.8	18.4	89.3	18.5	90.8	18.6	93.7	18.8	96.6	19.1
	27	62.8	12.5	78.5	17.0	86.5	19.2	88.0	19.3	89.5	19.4	92.4	19.6	95.4	19.9
	29	62.8	13.4	78.5	18.2	85.3	19.9	86.7	20.1	88.2	20.2	91.1	20.4	94.1	20.7
	31	62.8	14.2	78.5	19.4	84.0	20.7	85.5	20.9	86.9	21.0	89.9	21.3	92.8	21.5
	33	62.8	15.1	78.5	20.6	82.7	21.5	84.2	21.6	85.7	21.8	88.6	22.1	91.5	22.4
	35	62.8	16.1	78.5	22.0	81.4	22.3	82.9	22.4	84.4	22.6	87.3	22.9	90.3	23.2
	37	62.8	17.1	77.2	22.8	80.2	23.1	81.6	23.2	83.1	23.4	86.0	23.7	89.0	24.0
	39	62.8	18.1	75.9	23.5	78.9	23.9	80.4	24.0	81.8	24.2	84.8	24.5	87.7	24.9
120% 94.20 kW	10	58.0	8.7	72.5	10.9	87.0	13.3	94.2	14.6	98.8	15.1	101	14.4	104	13.7
	12	58.0	8.8	72.5	11.1	87.0	13.6	94.2	14.8	97.5	15.0	100.2	14.3	103	13.8
	14	58.0	9.0	72.5	11.3	87.0	13.8	94.2	15.1	96.2	14.9	98.9	14.4	102	14.5
	16	58.0	9.1	72.5	11.5	87.0	14.1	93.6	15.2	94.9	15.0	97.6	15.2	100.3	15.3
	18	58.0	9.3	72.5	11.8	87.0	14.5	92.3	15.7	93.6	15.8	96.4	16.0	99.1	16.1
	20	58.0	9.4	72.5	12.0	87.0	15.5	91.0	16.5	92.4	16.6	95.1	16.7	97.8	16.9
	21	58.0	9.5	72.5	12.5	87.0	16.1	90.4	16.8	91.7	16.9	94.4	17.1	97.2	17.3
	23	58.0	10.0	72.5	13.3	87.0	17.3	89.1	17.6	90.5	17.7	93.2	17.9	95.9	18.1
	25	58.0	10.6	72.5	14.3	86.5	18.3	87.8	18.4	89.2	18.5	91.9	18.7	94.6	18.9
	27	58.0	11.3	72.5	15.2	85.2	19.1	86.5	19.2	87.9	19.3	90.6	19.5	93.3	19.7
	29	58.0	12.0	72.5	16.2	83.9	19.8	85.3	19.9	86.6	20.1	89.3	20.3	92.0	20.5
	31	58.0	12.8	72.5	17.3	82.6	20.6	84.0	20.7	85.3	20.8	88.1	21.1	90.8	21.3
	33	58.0	13.6	72.5	18.4	81.4	21.4	82.7	21.5	84.1	21.6	86.8	21.9	89.5	22.2
	35	58.0	14.4	72.5	19.6	80.1	22.2	81.4	22.3	82.8	22.4	85.5	22.7	88.2	23.0
	37	58.0	15.3	72.5	20.9	78.8	22.9	80.2	23.1	81.5	23.2	84.2	23.5	86.9	23.8
	39	58.0	16.3	72.5	22.2	77.5	23.7	78.9	23.9	80.2	24.0	83.0	24.3	85.7	24.6
110% 86.35 kW	10	53.1	7.95	66.4	10.0	79.7	12.1	86.4	13.2	93.0	14.4	99.7	14.9	102	14.2
	12	53.1	8.08	66.4	10.1	79.7	12.3	86.4	13.5	93.0	14.6	98.4	14.8	100.9	14.1
	14	53.1	8.2	66.4	10.3	79.7	12.6	86.4	13.7	93.0	14.9	97.1	14.7	99.6	14.4
	16	53.1	8.3	66.4	10.5	79.7	12.8	86.4	14.0	93.0	15.2	95.8	15.1	98.3	15.2
	18	53.1	8.5	66.4	10.7	79.7	13.0	86.4	14.3	92.1	15.7	94.6	15.8	97.0	16.0
	20	53.1	8.6	66.4	10.9	79.7	13.7	86.4	15.4	90.8	16.5	93.3	16.6	95.8	16.8
	21	53.1	8.7	66.4	11.1	79.7	14.2	86.4	15.9	90.2	16.8	92.6	17.0	95.1	17.2
	23	53.1	8.9	66.4	11.9	79.7	15.2	86.4	17.1	88.9	17.6	91.4	17.8	93.8	18.0
	25	53.1	9.5	66.4	12.7	79.7	16.3	86.4	18.3	87.6	18.4	90.1	18.6	92.6	18.8
	27	53.1	10.1	66.4	13.5	79.7	17.4	85.1	19.0	86.3	19.1	88.8	19.3	91.3	19.5
	29	53.1	10.8	66.4	14.4	79.7	18.6	83.8	19.8	85.0	19.9	87.5	20.1	90.0	20.3
	31	53.1	11.5	66.4	15.3	79.7	19.8	82.5	20.6	83.8	20.7	86.3	20.9	88.7	21.2
	33	53.1	12.2	66.4	16.3	79.7	21.1	81.2	21.4	82.5	21.5	85.0	21.7	87.5	22.0
	35	53.1	12.9	66.4	17.3	78.7	22.0	80.0	22.1	81.2	22.3	83.7	22.5	86.2	22.8
	37	53.1	13.7	66.4	18.4	77.4	22.8	78.7	22.9	79.9	23.1	82.4	23.3	84.9	23.6
	39	53.1	14.5	66.4	19.6	76.2	23.6	77.4	23.7	78.7	23.8	81.1	24.1	83.6	24.4
100% 78.50 kW	10	48.3	7.25	60.4	9.0	72.5	10.9	78.5	11.9	84.5	12.9	96.6	15.0	100.1	14.7
	12	48.3	7.37	60.4	9.2	72.5	11.1	78.5	12.1	84.5	13.2	96.6	15.2	98.8	14.7
	14	48.3	7.48	60.4	9.3	72.5	11.3	78.5	12.4	84.5	13.4	95.3	15.2	97.6	14.6
	16	48.3	7.60	60.4	9.5	72.5	11.5	78.5	12.6	84.5	13.6	94.0	15.1	96.3	15.1
	18	48.3	7.73	60.4	9.7	72.5	11.8	78.5	12.8	84.5	13.9	92.7	15.7	95.0	15.9
	20	48.3	7.86	60.4	9.9	72.5	12.0	78.5	13.4	84.5	14.9	91.5	16.5	93.7	16.6
	21	48.3	7.93	60.4	9.9	72.5	12.5	78.5	13.9	84.5	15.5	90.8	16.9	93.1	17.0
	23	48.3	8.07	60.4	10.5	72.5	13.3	78.5	14.9	84.5	16.6	89.6	17.7	91.8	17.8
	25	48.3	8.5	60.4	11.2	72.5	14.3	78.5	15.9	84.5	17.7	88.3	18.4	90.5	18.6
	27	48.3	9.0	60.4	11.9	72.5	15.2	78.5	17.0	84.5	18.9	87.0	19.2	89.3	19.4
	29	48.3	9.6	60.4	12.7	72.5	16.2	78.5	18.2	83.5	19.8	85.7	20.0	88.0	20.2
	31	48.3	10.2	60.4	13.5	72.5	17.3	78.5	19.4	82.2	20.6	84.4	20.8	86.7	21.0
	33	48.3	10.8	60.4	14.3	72.5	18.4	78.5	20.6	80.9	21.3	83.2	21.5	85.4	21.8
	35	48.3	11.5	60.4	15.2	72.5	19.6	78.5	21.9	79.6	22.1	81.9	22.3	84.1	22.6
	37	48.3	12.1	60.4	16.2	72.5	20.9	77.2	22.8	78.4	22.9	80.6	23.1	82.9	23.4
	39	48.3	12.9	60.4	17.2	72.5	22.2	75.9	23.5	77.1	23.7	79.3	23.9	81.6	24.2

NOTES - ANMERKUNGEN - Σημειώσεις - NOTAS - REMARQUES - NOTE - OPMERKINGEN - примечания - NOTLAR

- The above table shows the average value of conditions which may occur.
Die obige Tabelle zeigt den Durchschnittswert der Bedingungen, die auftreten können.
 Στον παραπάνω πίνακα αναγράφεται η μέση τιμή για συνθήκες που μπορεί να προκύψουν.
La tabla de arriba muestra el valor medio de condiciones que pueden ocurrir.
 Le tableau ci-dessus donne la valeur moyenne pour des conditions qui peuvent survenir.
La tabella in alto mostra il valore delle condizioni medie che si possono riscontrare.
 De tabel hierboven geeft de gemiddelde waarde aan van situaties die kunnen voorvallen.
Таблица расположенная выше показывает среднее значение условий, которые могут наступить.
 Yukarıdaki tablo meydana gelebilecek koşulların ortalama değerini göstermektedir.

3D079549

5 Таблицы производительности

5 - 1 Таблицы холодопроизводительности

5

RXYQ28T															
Indoor air temp. °CWB															
Combination(%) (Capacity index)	Outdoor air temp. (°CDB)	14.0		16.0		18.0		19.0		20.0		22.0		24.0	
		TC	PI	TC	PI	TC	PI	TC	PI	TC	PI	TC	PI	TC	PI
		KW	KW	KW	KW	KW	KW	KW	KW	KW	KW	KW	KW	KW	KW
90% 70.65 kW	10	43.5	6.58	54.3	8.13	65.2	9.8	70.7	10.7	76.1	11.5	87.0	13.3	97.8	15.2
	12	43.5	6.68	54.3	8.26	65.2	10.0	70.7	10.8	76.1	11.7	87.0	13.6	96.8	15.2
	14	43.5	6.78	54.3	8.40	65.2	10.1	70.7	11.0	76.1	11.9	87.0	13.8	95.5	15.1
	16	43.5	6.88	54.3	8.54	65.2	10.3	70.7	11.2	76.1	12.2	87.0	14.1	94.2	15.0
	18	43.5	6.99	54.3	8.7	65.2	10.5	70.7	11.4	76.1	12.4	87.0	14.5	93.0	15.7
	20	43.5	7.11	54.3	8.8	65.2	10.7	70.7	11.6	76.1	12.9	87.0	15.5	91.7	16.5
	21	43.5	7.16	54.3	8.9	65.2	10.8	70.7	12.0	76.1	13.3	87.0	16.1	91.1	16.9
	23	43.5	7.29	54.3	9.2	65.2	11.6	70.7	12.9	76.1	14.3	87.0	17.3	89.8	17.7
	25	43.5	7.54	54.3	9.8	65.2	12.4	70.7	13.8	76.1	15.2	86.5	18.3	88.5	18.4
	27	43.5	8.01	54.3	10.4	65.2	13.2	70.7	14.7	76.1	16.3	85.2	19.1	87.2	19.2
	29	43.5	8.5	54.3	11.1	65.2	14.0	70.7	15.7	76.1	17.4	83.9	19.8	85.9	20.0
	31	43.5	9.0	54.3	11.8	65.2	14.9	70.7	16.7	76.1	18.5	82.6	20.6	84.7	20.8
	33	43.5	9.5	54.3	12.5	65.2	15.9	70.7	17.8	76.1	19.7	81.4	21.4	83.4	21.6
	35	43.5	10.1	54.3	13.3	65.2	16.9	70.7	18.9	76.1	21.0	80.1	22.2	82.1	22.4
37	43.5	10.7	54.3	14.1	65.2	18.0	70.7	20.1	76.1	22.4	78.8	22.9	80.8	23.2	
39	43.5	11.3	54.3	14.9	65.2	19.1	70.7	21.4	75.5	23.5	77.5	23.7	79.6	24.0	
80% 62.80 kW	10	38.6	5.94	48.3	7.25	58.0	8.67	62.8	9.4	67.6	10.2	77.3	11.7	87.0	13.3
	12	38.6	6.02	48.3	7.37	58.0	8.81	62.8	9.6	67.6	10.3	77.3	11.9	87.0	13.6
	14	38.6	6.10	48.3	7.48	58.0	9.0	62.8	9.7	67.6	10.5	77.3	12.2	87.0	13.8
	16	38.6	6.19	48.3	7.60	58.0	9.1	62.8	9.9	67.6	10.7	77.3	12.4	87.0	14.1
	18	38.6	6.29	48.3	7.73	58.0	9.3	62.8	10.1	67.6	10.9	77.3	12.6	87.0	14.5
	20	38.6	6.38	48.3	7.86	58.0	9.4	62.8	10.3	67.6	11.1	77.3	13.2	87.0	15.5
	21	38.6	6.43	48.3	7.93	58.0	9.5	62.8	10.4	67.6	11.4	77.3	13.6	87.0	16.1
	23	38.6	6.53	48.3	8.07	58.0	10.0	62.8	11.0	67.6	12.2	77.3	14.6	87.0	17.3
	25	38.6	6.64	48.3	8.50	58.0	10.6	62.8	11.8	67.6	13.0	77.3	15.6	86.5	18.3
	27	38.6	7.05	48.3	9.0	58.0	11.3	62.8	12.5	67.6	13.8	77.3	16.7	85.2	19.1
	29	38.6	7.47	48.3	9.6	58.0	12.0	62.8	13.4	67.6	14.8	77.3	17.8	83.9	19.8
	31	38.6	7.91	48.3	10.2	58.0	12.8	62.8	14.2	67.6	15.7	77.3	18.9	82.6	20.6
	33	38.6	8.4	48.3	10.8	58.0	13.6	62.8	15.1	67.6	16.7	77.3	20.2	81.4	21.4
	35	38.6	8.9	48.3	11.5	58.0	14.4	62.8	16.1	67.6	17.8	77.3	21.5	80.1	22.2
37	38.6	9.4	48.3	12.1	58.0	15.3	62.8	17.1	67.6	18.9	77.0	22.7	78.8	22.9	
39	38.6	9.9	48.3	12.9	58.0	16.3	62.8	18.1	67.6	20.1	75.7	23.5	77.5	23.7	
70% 54.95 kW	10	33.8	5.32	42.3	6.42	50.7	7.60	55.0	8.22	59.2	8.85	67.6	10.2	76.1	11.5
	12	33.8	5.39	42.3	6.51	50.7	7.72	55.0	8.35	59.2	9.00	67.6	10.3	76.1	11.7
	14	33.8	5.46	42.3	6.61	50.7	7.84	55.0	8.49	59.2	9.2	67.6	10.5	76.1	11.9
	16	33.8	5.53	42.3	6.71	50.7	7.97	55.0	8.63	59.2	9.3	67.6	10.7	76.1	12.2
	18	33.8	5.61	42.3	6.81	50.7	8.11	55.0	8.78	59.2	9.5	67.6	10.9	76.1	12.4
	20	33.8	5.69	42.3	6.92	50.7	8.25	55.0	8.94	59.2	9.6	67.6	11.1	76.1	12.9
	21	33.8	5.73	42.3	6.98	50.7	8.32	55.0	9.0	59.2	9.7	67.6	11.4	76.1	13.3
	23	33.8	5.82	42.3	7.09	50.7	8.47	55.0	9.3	59.2	10.2	67.6	12.2	76.1	14.3
	25	33.8	5.91	42.3	7.31	50.7	9.0	55.0	9.9	59.2	10.9	67.6	13.0	76.1	15.2
	27	33.8	6.16	42.3	7.76	50.7	9.6	55.0	10.6	59.2	11.6	67.6	13.8	76.1	16.3
	29	33.8	6.52	42.3	8.24	50.7	10.2	55.0	11.2	59.2	12.4	67.6	14.8	76.1	17.4
	31	33.8	6.89	42.3	8.7	50.7	10.8	55.0	11.9	59.2	13.1	67.6	15.7	76.1	18.5
	33	33.8	7.28	42.3	9.2	50.7	11.5	55.0	12.7	59.2	14.0	67.6	16.7	76.1	19.7
	35	33.8	7.69	42.3	9.8	50.7	12.2	55.0	13.5	59.2	14.8	67.6	17.8	76.1	21.0
37	33.8	8.11	42.3	10.4	50.7	12.9	55.0	14.3	59.2	15.8	67.6	18.9	76.1	22.4	
39	33.8	8.6	42.3	11.0	50.7	13.7	55.0	15.2	59.2	16.7	67.6	20.1	75.5	23.5	
60% 47.10 kW	10	29.0	4.73	36.2	5.62	43.5	6.58	47.1	7.08	50.7	7.60	58.0	8.67	65.2	9.8
	12	29.0	4.79	36.2	5.70	43.5	6.68	47.1	7.19	50.7	7.72	58.0	8.81	65.2	10.0
	14	29.0	4.84	36.2	5.78	43.5	6.78	47.1	7.30	50.7	7.84	58.0	8.96	65.2	10.1
	16	29.0	4.91	36.2	5.86	43.5	6.88	47.1	7.42	50.7	7.97	58.0	9.12	65.2	10.3
	18	29.0	4.97	36.2	5.94	43.5	6.99	47.1	7.54	50.7	8.11	58.0	9.3	65.2	10.5
	20	29.0	5.03	36.2	6.03	43.5	7.11	47.1	7.67	50.7	8.25	58.0	9.4	65.2	10.7
	21	29.0	5.07	36.2	6.08	43.5	7.16	47.1	7.73	50.7	8.32	58.0	9.5	65.2	10.8
	23	29.0	5.14	36.2	6.17	43.5	7.29	47.1	7.87	50.7	8.47	58.0	10.0	65.2	11.6
	25	29.0	5.21	36.2	6.27	43.5	7.54	47.1	8.26	50.7	9.00	58.0	10.6	65.2	12.4
	27	29.0	5.33	36.2	6.59	43.5	8.01	47.1	8.78	50.7	9.6	58.0	11.3	65.2	13.2
	29	29.0	5.63	36.2	6.98	43.5	8.50	47.1	9.3	50.7	10.2	58.0	12.0	65.2	14.0
	31	29.0	5.95	36.2	7.39	43.5	9.0	47.1	9.9	50.7	10.8	58.0	12.8	65.2	14.9
	33	29.0	6.27	36.2	7.81	43.5	9.5	47.1	10.5	50.7	11.5	58.0	13.6	65.2	15.9
	35	29.0	6.61	36.2	8.26	43.5	10.1	47.1	11.1	50.7	12.2	58.0	14.4	65.2	16.9
37	29.0	6.97	36.2	8.7	43.5	10.7	47.1	11.8	50.7	12.9	58.0	15.3	65.2	18.0	
39	29.0	7.34	36.2	9.2	43.5	11.3	47.1	12.5	50.7	13.7	58.0	16.3	65.2	19.1	
50% 39.25 kW	10	24.2	4.18	30.2	4.87	36.2	5.62	39.3	6.01	42.3	6.42	48.3	7.25	54.3	8.13
	12	24.2	4.22	30.2	4.93	36.2	5.70	39.3	6.10	42.3	6.51	48.3	7.37	54.3	8.26
	14	24.2	4.27	30.2	4.99	36.2	5.78	39.3	6.19	42.3	6.61	48.3	7.48	54.3	8.40
	16	24.2	4.31	30.2	5.06	36.2	5.86	39.3	6.28	42.3	6.71	48.3	7.60	54.3	8.54
	18	24.2	4.36	30.2	5.12	36.2	5.94	39.3	6.37	42.3	6.81	48.3	7.73	54.3	8.69
	20	24.2	4.41	30.2	5.19	36.2	6.03	39.3	6.47	42.3	6.92	48.3	7.86	54.3	8.84
	21	24.2	4.44	30.2	5.23	36.2	6.08	39.3	6.52	42.3	6.98	48.3	7.93	54.3	8.92
	23	24.2	4.49	30.2	5.30	36.2	6.17	39.3	6.63	42.3	7.09	48.3	8.07	54.3	9.19
	25	24.2	4.55	30.2	5.38	36.2	6.27	39.3	6.75	42.3	7.31	48.3	8.50	54.3	9.8
	27	24.2	4.61	30.2	5.53	36.2	6.59	39.3	7.17	42.3	7.76	48.3	9.04	54.3	10.4
	29	24.2	4.83	30.2	5.85	36.2	6.98	39.3	7.59	42.3	8.24	48.3	9.6	54.3	11.1
	31	24.2	5.08	30.2	6.18	36.2	7.39	39.3	8.04	42.3	8.73	48.3	10.2	54.3	11.8
	33	24.2	5.35	30.2	6.52	36.2	7.81	39.3	8.51	42.3	9.2	48.3	10.8	54.3	12.5
	35	24.2	5.63	30.2	6.87	36.2	8.26	39.3	9.00	42.3	9.8	48.3	11.5	54.3	13.3
37	24.2	5.92	30.2	7.24	36.2	8.72	39.3	9.5	42.3	10.4	48.3	12.1	54.3	14.1	
39	24.2	6.22	30.2	7.63	36.2	9.2	39.3	10.1	42.3	11.0	48.3	12.9	54.3	14.9	

3D079549

5 Таблицы производительности

5 - 1 Таблицы холодопроизводительности

RXYQ30T															
Indoor air temp. °CWB															
Combination(%) (Capacity index)	Outdoor air temp. (°CDB)	14.0		16.0		18.0		19.0		20.0		22.0		24.0	
		TC	PI	TC	PI	TC	PI	TC	PI	TC	PI	TC	PI	TC	PI
		KW		KW		KW		KW		KW		KW		KW	
130% 108.55 kW	10	66.8	10.1	83.5	12.9	100	15.7	105	16.2	107	15.8	110	15.0	113	14.2
	12	66.8	10.3	83.5	13.1	100	16.0	104	16.1	105	15.7	108	14.9	112	14.9
	14	66.8	10.5	83.5	13.3	100	16.3	102	16.0	104	15.6	107	15.6	110	15.8
	16	66.8	10.7	83.5	13.6	100	16.4	101	16.2	103	16.3	106	16.5	109	16.6
	18	66.8	10.9	83.5	13.8	98	16.9	100	17.0	101	17.1	104	17.3	108	17.5
	20	66.8	11.1	83.5	14.5	96.8	17.7	98	17.8	100	17.9	103	18.2	106	18.4
	21	66.8	11.2	83.5	15.0	96.1	18.2	97.7	18.3	99	18.4	102	18.6	106	18.8
	23	66.8	11.9	83.5	16.1	94.8	19.0	96.3	19.1	97.9	19.2	101	19.4	104	19.7
	25	66.8	12.7	83.5	17.2	93.4	19.8	95.0	19.9	96.5	20.1	100	20.3	103	20.5
	27	66.8	13.5	83.5	18.3	92.1	20.6	93.6	20.8	95.2	20.9	98.3	21.2	101	21.4
	29	66.8	14.4	83.5	19.6	90.7	21.5	92.3	21.6	93.8	21.8	96.9	22.0	100	22.3
	31	66.8	15.3	83.5	20.9	89.3	22.3	90.9	22.5	92.5	22.6	95.6	22.9	98.7	23.2
	33	66.8	16.3	83.5	22.2	88.0	23.2	89.5	23.3	91.1	23.5	94.2	23.8	97.4	24.1
	35	66.8	17.3	83.5	23.7	86.6	24.0	88.2	24.2	89.7	24.3	92.9	24.7	96.0	25.0
	37	66.8	18.4	82.1	24.5	85.3	24.9	86.8	25.0	88.4	25.2	91.5	25.5	94.6	25.9
	39	66.8	19.5	80.8	25.4	83.9	25.7	85.5	25.9	87.0	26.1	90.2	26.4	93.3	26.8
120% 100.20 kW	10	61.7	9.3	77.1	11.8	92.5	14.4	100	15.7	105	16.2	108	15.5	111	14.8
	12	61.7	9.5	77.1	12.0	92.5	14.6	100	16.0	104	16.2	107	15.4	109	14.8
	14	61.7	9.7	77.1	12.2	92.5	14.9	100	16.3	102	16.1	105	15.5	108	15.7
	16	61.7	9.8	77.1	12.4	92.5	15.2	100	16.4	101	16.2	104	16.4	107	16.5
	18	61.7	10.0	77.1	12.7	92.5	15.6	98.2	16.9	100	17.0	102	17.2	105	17.4
	20	61.7	10.2	77.1	13.0	92.5	16.8	96.8	17.7	98.3	17.8	101	18.0	104	18.2
	21	61.7	10.3	77.1	13.4	92.5	17.3	96.1	18.2	97.6	18.3	100	18.5	103	18.6
	23	61.7	10.7	77.1	14.4	92.5	18.6	94.8	19.0	96.2	19.1	99	19.3	102	19.5
	25	61.7	11.4	77.1	15.4	92.0	19.7	93.4	19.8	94.9	19.9	97.7	20.1	101	20.4
	27	61.7	12.2	77.1	16.4	90.6	20.5	92.1	20.6	93.5	20.8	96.4	21.0	99.3	21.2
	29	61.7	13.0	77.1	17.5	89.3	21.4	90.7	21.5	92.1	21.6	95.0	21.9	97.9	22.1
	31	61.7	13.8	77.1	18.6	87.9	22.2	89.3	22.3	90.8	22.5	93.7	22.7	96.6	23.0
	33	61.7	14.6	77.1	19.8	86.5	23.0	88.0	23.2	89.4	23.3	92.3	23.6	95.2	23.9
	35	61.7	15.6	77.1	21.1	85.2	23.9	86.6	24.0	88.1	24.2	91.0	24.5	93.8	24.8
	37	61.7	16.5	77.1	22.5	83.8	24.7	85.3	24.9	86.7	25.0	89.6	25.3	92.5	25.6
	39	61.7	17.5	77.1	23.9	82.5	25.6	83.9	25.7	85.4	25.9	88.2	26.2	91.1	26.5
110% 91.85 kW	10	56.5	8.6	70.7	10.8	84.8	13.1	91.9	14.3	98.9	15.5	106	16.0	109	15.3
	12	56.5	8.7	70.7	10.9	84.8	13.3	91.9	14.5	98.9	15.7	105	15.9	107	15.2
	14	56.5	8.8	70.7	11.1	84.8	13.5	91.9	14.8	98.9	16.0	103	15.8	106	15.6
	16	56.5	9.0	70.7	11.3	84.8	13.8	91.9	15.0	98.9	16.3	102	16.2	105	16.6
	18	56.5	9.2	70.7	11.5	84.8	14.0	91.9	15.4	97.9	16.9	101	17.1	103	17.2
	20	56.5	9.3	70.7	11.7	84.8	14.8	91.9	16.6	96.6	17.7	99	17.9	102	18.1
	21	56.5	9.4	70.7	12.0	84.8	15.3	91.9	17.2	95.9	18.1	98.5	18.3	101	18.5
	23	56.5	9.6	70.7	12.8	84.8	16.4	91.9	18.4	94.5	19.0	97.2	19.2	100	19.3
	25	56.5	10.3	70.7	13.6	84.8	17.5	91.9	19.7	93.2	19.8	95.8	20.0	98.5	20.2
	27	56.5	10.9	70.7	14.6	84.8	18.7	90.5	20.5	91.8	20.6	94.5	20.8	97.1	21.1
	29	56.5	11.6	70.7	15.5	84.8	20.0	89.1	21.3	90.5	21.5	93.1	21.7	95.7	21.9
	31	56.5	12.3	70.7	16.5	84.8	21.3	87.8	22.2	89.1	22.3	91.7	22.5	94.4	22.8
	33	56.5	13.1	70.7	17.6	84.8	22.7	86.4	23.0	87.7	23.1	90.4	23.4	93.0	23.7
	35	56.5	13.9	70.7	18.7	83.7	23.7	85.1	23.9	86.4	24.0	89.0	24.3	91.7	24.5
	37	56.5	14.7	70.7	19.9	82.4	24.5	83.7	24.7	85.0	24.8	87.7	25.1	90.3	25.4
	39	56.5	15.6	70.7	21.1	81.0	25.4	82.3	25.5	83.7	25.7	86.3	26.0	89.0	26.3
100% 83.50 kW	10	51.4	7.8	64.2	9.7	77.1	11.8	83.5	12.9	89.9	13.9	103	16.1	106	15.9
	12	51.4	7.9	64.2	9.9	77.1	12.0	83.5	13.1	89.9	14.2	103	16.4	105	15.8
	14	51.4	8.1	64.2	10.1	77.1	12.2	83.5	13.3	89.9	14.4	101	16.3	104	15.7
	16	51.4	8.2	64.2	10.2	77.1	12.4	83.5	13.6	89.9	14.7	100	16.2	102	16.3
	18	51.4	8.3	64.2	10.4	77.1	12.7	83.5	13.8	89.9	15.0	98.7	16.9	101	17.1
	20	51.4	8.5	64.2	10.6	77.1	13.0	83.5	14.5	89.9	16.1	97.3	17.8	100	17.9
	21	51.4	8.5	64.2	10.7	77.1	13.4	83.5	15.0	89.9	16.7	96.6	18.2	99.0	18.4
	23	51.4	8.7	64.2	11.3	77.1	14.4	83.5	16.1	89.9	17.8	95.3	19.0	97.7	19.2
	25	51.4	9.2	64.2	12.0	77.1	15.4	83.5	17.2	89.9	19.1	93.9	19.8	96.3	20.0
	27	51.4	9.7	64.2	12.8	77.1	16.4	83.5	18.3	89.9	20.4	92.5	20.7	94.9	20.9
	29	51.4	10.3	64.2	13.7	77.1	17.5	83.5	19.6	88.8	21.3	91.2	21.5	93.6	21.7
	31	51.4	11.0	64.2	14.5	77.1	18.6	83.5	20.9	87.4	22.1	89.8	22.4	92.2	22.6
	33	51.4	11.6	64.2	15.5	77.1	19.8	83.5	22.2	86.1	23.0	88.5	23.2	90.9	23.4
	35	51.4	12.3	64.2	16.4	77.1	21.1	83.5	23.7	84.7	23.8	87.1	24.1	89.5	24.3
	37	51.4	13.1	64.2	17.4	77.1	22.5	82.1	24.5	83.3	24.7	85.7	24.9	88.2	25.2
	39	51.4	13.9	64.2	18.5	77.1	23.9	80.8	25.4	82.0	25.5	84.4	25.8	86.8	26.1

NOTES - ANMERKUNGEN - Σημειώσεις - NOTAS - REMARQUES - NOTE - OPMERKINGEN - примечания - NOTLAR

- The above table shows the average value of conditions which may occur.
Die obige Tabelle zeigt den Durchschnittswert der Bedingungen, die auftreten können.
 Στον παραπάνω πίνακα αναγράφεται η μέση τιμή για συνθήκες που μπορεί να προκύψουν.
La tabla de arriba muestra el valor medio de condiciones que pueden ocurrir.
 Le tableau ci-dessus donne la valeur moyenne pour des conditions qui peuvent survenir.
La tabella in alto mostra il valore delle condizioni medie che si possono riscontrare.
 De tabel hierboven geeft de gemiddelde waarde aan van situaties die kunnen voorvallen.
 Таблица расположенная выше показывает среднее значение условий, которые могут наступить.
 Yukarıdaki tablo meydana gelebilecek koşulların ortalama değerini göstermektedir.

3D079549

5 Таблицы производительности

5 - 1 Таблицы холодопроизводительности

5

RXYQ30T															
Indoor air temp. °CWB															
Combination(%) (Capacity index)	Outdoor air temp. (°CDB)	14.0		16.0		18.0		19.0		20.0		22.0		24.0	
		TC	PI	TC	PI	TC	PI	TC	PI	TC	PI	TC	PI	TC	PI
		KW	KW	KW	KW	KW	KW	KW	KW	KW	KW	KW	KW	KW	KW
90% 75.15 kW	10	46.2	7.09	57.8	8.8	69.4	10.5	75.2	11.5	80.9	12.4	92.5	14.4	104	16.3
	12	46.2	7.20	57.8	8.9	69.4	10.7	75.2	11.7	80.9	12.6	92.5	14.6	103	16.3
	14	46.2	7.31	57.8	9.0	69.4	10.9	75.2	11.9	80.9	12.9	92.5	14.9	102	16.3
	16	46.2	7.42	57.8	9.2	69.4	11.1	75.2	12.1	80.9	13.1	92.5	15.2	100	16.2
	18	46.2	7.54	57.8	9.4	69.4	11.3	75.2	12.3	80.9	13.3	92.5	15.6	98.9	17.0
	20	46.2	7.66	57.8	9.5	69.4	11.5	75.2	12.6	80.9	13.9	92.5	16.8	97.5	17.8
	21	46.2	7.72	57.8	9.6	69.4	11.7	75.2	13.0	80.9	14.4	92.5	17.3	96.9	18.2
	23	46.2	7.9	57.8	9.9	69.4	12.5	75.2	13.9	80.9	15.4	92.5	18.6	95.5	19.0
	25	46.2	8.1	57.8	10.5	69.4	13.3	75.2	14.8	80.9	16.4	92.0	19.7	94.1	19.9
	27	46.2	8.6	57.8	11.2	69.4	14.2	75.2	15.8	80.9	17.5	90.6	20.5	92.8	20.7
	29	46.2	9.2	57.8	11.9	69.4	15.1	75.2	16.9	80.9	18.7	89.3	21.4	91.4	21.5
	31	46.2	9.7	57.8	12.7	69.4	16.1	75.2	18.0	80.9	20.0	87.9	22.2	90.1	22.4
	33	46.2	10.3	57.8	13.5	69.4	17.1	75.2	19.1	80.9	21.3	86.5	23.0	88.7	23.2
	35	46.2	10.9	57.8	14.3	69.4	18.2	75.2	20.4	80.9	22.6	85.2	23.9	87.3	24.1
37	46.2	11.5	57.8	15.2	69.4	19.4	75.2	21.7	80.9	24.1	83.8	24.7	86.0	24.9	
39	46.2	12.2	57.8	16.1	69.4	20.6	75.2	23.0	80.3	25.3	82.5	25.6	84.6	25.8	
80% 66.80 kW	10	41.1	6.40	51.4	7.82	61.7	9.3	66.8	10.1	71.9	11.0	82.2	12.6	92.5	14.4
	12	41.1	6.49	51.4	7.94	61.7	9.5	66.8	10.3	71.9	11.1	82.2	12.9	92.5	14.6
	14	41.1	6.58	51.4	8.06	61.7	9.7	66.8	10.5	71.9	11.3	82.2	13.1	92.5	14.9
	16	41.1	6.67	51.4	8.2	61.7	9.8	66.8	10.7	71.9	11.5	82.2	13.3	92.5	15.2
	18	41.1	6.77	51.4	8.3	61.7	10.0	66.8	10.9	71.9	11.8	82.2	13.6	92.5	15.6
	20	41.1	6.88	51.4	8.5	61.7	10.2	66.8	11.1	71.9	12.0	82.2	14.2	92.5	16.8
	21	41.1	6.93	51.4	8.5	61.7	10.3	66.8	11.2	71.9	12.2	82.2	14.7	92.5	17.3
	23	41.1	7.04	51.4	8.7	61.7	10.7	66.8	11.9	71.9	13.1	82.2	15.7	92.5	18.6
	25	41.1	7.16	51.4	9.2	61.7	11.4	66.8	12.7	71.9	14.0	82.2	16.8	92.0	19.7
	27	41.1	7.60	51.4	9.7	61.7	12.2	66.8	13.5	71.9	14.9	82.2	17.9	90.6	20.5
	29	41.1	8.1	51.4	10.3	61.7	13.0	66.8	14.4	71.9	15.9	82.2	19.1	89.3	21.4
	31	41.1	8.5	51.4	11.0	61.7	13.8	66.8	15.3	71.9	16.9	82.2	20.4	87.9	22.2
	33	41.1	9.0	51.4	11.6	61.7	14.6	66.8	16.3	71.9	18.0	82.2	21.7	86.5	23.0
	35	41.1	9.5	51.4	12.3	61.7	15.6	66.8	17.3	71.9	19.2	82.2	23.2	85.2	23.9
37	41.1	10.1	51.4	13.1	61.7	16.5	66.8	18.4	71.9	20.4	81.9	24.5	83.8	24.7	
39	41.1	10.7	51.4	13.9	61.7	17.5	66.8	19.5	71.9	21.7	80.5	25.3	82.5	25.6	
70% 58.45 kW	10	36.0	5.73	45.0	6.92	54.0	8.19	58.5	8.9	62.9	9.5	71.9	11.0	80.9	12.4
	12	36.0	5.81	45.0	7.02	54.0	8.32	58.5	9.0	62.9	9.7	71.9	11.1	80.9	12.6
	14	36.0	5.88	45.0	7.12	54.0	8.5	58.5	9.1	62.9	9.9	71.9	11.3	80.9	12.9
	16	36.0	5.96	45.0	7.23	54.0	8.6	58.5	9.3	62.9	10.0	71.9	11.5	80.9	13.1
	18	36.0	6.05	45.0	7.34	54.0	8.7	58.5	9.5	62.9	10.2	71.9	11.8	80.9	13.3
	20	36.0	6.13	45.0	7.46	54.0	8.9	58.5	9.6	62.9	10.4	71.9	12.0	80.9	13.9
	21	36.0	6.18	45.0	7.52	54.0	9.0	58.5	9.7	62.9	10.5	71.9	12.2	80.9	14.4
	23	36.0	6.27	45.0	7.65	54.0	9.1	58.5	10.0	62.9	11.0	71.9	13.1	80.9	15.4
	25	36.0	6.37	45.0	7.88	54.0	9.7	58.5	10.7	62.9	11.7	71.9	14.0	80.9	16.4
	27	36.0	6.64	45.0	8.4	54.0	10.3	58.5	11.4	62.9	12.5	71.9	14.9	80.9	17.5
	29	36.0	7.02	45.0	8.9	54.0	11.0	58.5	12.1	62.9	13.3	71.9	15.9	80.9	18.7
	31	36.0	7.43	45.0	9.4	54.0	11.7	58.5	12.9	62.9	14.2	71.9	16.9	80.9	20.0
	33	36.0	7.8	45.0	10.0	54.0	12.4	58.5	13.7	62.9	15.0	71.9	18.0	80.9	21.3
	35	36.0	8.3	45.0	10.5	54.0	13.1	58.5	14.5	62.9	16.0	71.9	19.2	80.9	22.6
37	36.0	8.7	45.0	11.2	54.0	13.9	58.5	15.4	62.9	17.0	71.9	20.4	80.9	24.1	
39	36.0	9.2	45.0	11.8	54.0	14.7	58.5	16.3	62.9	18.0	71.9	21.7	80.3	25.3	
60% 50.10 kW	10	30.8	5.10	38.5	6.06	46.2	7.09	50.1	7.63	54.0	8.19	61.7	9.3	69.4	10.5
	12	30.8	5.16	38.5	6.14	46.2	7.20	50.1	7.75	54.0	8.32	61.7	9.5	69.4	10.7
	14	30.8	5.22	38.5	6.23	46.2	7.31	50.1	7.87	54.0	8.45	61.7	9.7	69.4	10.9
	16	30.8	5.29	38.5	6.31	46.2	7.42	50.1	8.00	54.0	8.6	61.7	9.8	69.4	11.1
	18	30.8	5.36	38.5	6.41	46.2	7.54	50.1	8.13	54.0	8.7	61.7	10.0	69.4	11.3
	20	30.8	5.43	38.5	6.50	46.2	7.66	50.1	8.26	54.0	8.9	61.7	10.2	69.4	11.5
	21	30.8	5.46	38.5	6.55	46.2	7.72	50.1	8.33	54.0	9.0	61.7	10.3	69.4	11.7
	23	30.8	5.54	38.5	6.65	46.2	7.85	50.1	8.5	54.0	9.1	61.7	10.7	69.4	12.5
	25	30.8	5.61	38.5	6.76	46.2	8.13	50.1	8.9	54.0	9.7	61.7	11.4	69.4	13.3
	27	30.8	5.75	38.5	7.11	46.2	8.6	50.1	9.5	54.0	10.3	61.7	12.2	69.4	14.2
	29	30.8	6.07	38.5	7.53	46.2	9.2	50.1	10.0	54.0	11.0	61.7	13.0	69.4	15.1
	31	30.8	6.41	38.5	7.96	46.2	9.7	50.1	10.7	54.0	11.7	61.7	13.8	69.4	16.1
	33	30.8	6.76	38.5	8.4	46.2	10.3	50.1	11.3	54.0	12.4	61.7	14.6	69.4	17.1
	35	30.8	7.13	38.5	8.9	46.2	10.9	50.1	12.0	54.0	13.1	61.7	15.6	69.4	18.2
37	30.8	7.51	38.5	9.4	46.2	11.5	50.1	12.7	54.0	13.9	61.7	16.5	69.4	19.4	
39	30.8	7.9	38.5	9.9	46.2	12.2	50.1	13.4	54.0	14.7	61.7	17.5	69.4	20.6	
50% 41.75 kW	10	25.7	4.50	32.1	5.25	38.5	6.06	41.8	6.48	45.0	6.92	51.4	7.82	57.8	8.76
	12	25.7	4.55	32.1	5.32	38.5	6.14	41.8	6.57	45.0	7.02	51.4	7.94	57.8	8.9
	14	25.7	4.60	32.1	5.38	38.5	6.23	41.8	6.67	45.0	7.12	51.4	8.06	57.8	9.0
	16	25.7	4.65	32.1	5.45	38.5	6.31	41.8	6.77	45.0	7.23	51.4	8.19	57.8	9.2
	18	25.7	4.70	32.1	5.52	38.5	6.41	41.8	6.87	45.0	7.34	51.4	8.33	57.8	9.4
	20	25.7	4.76	32.1	5.60	38.5	6.50	41.8	6.97	45.0	7.46	51.4	8.47	57.8	9.5
	21	25.7	4.79	32.1	5.64	38.5	6.55	41.8	7.03	45.0	7.52	51.4	8.54	57.8	9.6
	23	25.7	4.85	32.1	5.72	38.5	6.65	41.8	7.14	45.0	7.65	51.4	8.7	57.8	9.9
	25	25.7	4.91	32.1	5.80	38.5	6.76	41.8	7.28	45.0	7.88	51.4	9.2	57.8	10.5
	27	25.7	4.97	32.1	5.96	38.5	7.11	41.8	7.72	45.0	8.37	51.4	9.7	57.8	11.2
	29	25.7	5.20	32.1	6.30	38.5	7.53	41.8	8.19	45.0	8.9	51.4	10.3	57.8	11.9
	31	25.7	5.48	32.1	6.66	38.5	7.96	41.8	8.7	45.0	9.4	51.4	11.0	57.8	12.7
	33	25.7	5.77	32.1	7.02	38.5	8.42	41.8	9.2	45.0	10.0	51.4	11.6	57.8	13.5
	35	25.7	6.07	32.1	7.41	38.5	8.9	41.8	9.7	45.0	10.5	51.4	12.3	57.8	14.3
37	25.7	6.38	32.1	7.81	38.5	9.4	41.8	10.3	45.0	11.2	51.4	13.1	57.8	15.2	
39	25.7	6.71	32.1	8.23	38.5	9.9	41.8	10.8	45.0	11.8	51.4	13.9	57.8	16.1	

3D079549

5 Таблицы производительности

5 - 1 Таблицы холодопроизводительности

RXYQ32T															
Indoor air temp. °CWB															
Combination(%) (Capacity index)	Outdoor air temp. (°CDB)	14.0		16.0		18.0		19.0		20.0		22.0		24.0	
		TC	PI	TC	PI	TC	PI	TC	PI	TC	PI	TC	PI	TC	PI
		KW		KW		KW		KW		KW		KW		KW	
130% 117.00 kW	10	72.0	11.2	90.0	14.1	108	17.2	113	17.8	115	17.4	118	16.5	122	15.6
	12	72.0	11.4	90.0	14.4	108	17.5	112	17.7	114	17.3	117	16.4	120	16.4
	14	72.0	11.5	90.0	14.6	108	17.8	110	17.6	112	17.2	115	17.1	119	17.3
	16	72.0	11.7	90.0	14.9	107	18.0	109	17.8	111	17.9	114	18.1	117	18.3
	18	72.0	12.0	90.0	15.2	106	18.6	107	18.7	109	18.8	113	19.0	116	19.2
	20	72.0	12.2	90.0	15.9	104	19.5	106	19.6	108	19.7	111	19.9	114	20.2
	21	72.0	12.3	90.0	16.5	104	19.9	105	20.0	107	20.2	110	20.4	114	20.6
	23	72.0	13.1	90.0	17.6	102	20.8	104	21.0	106	21.1	109	21.3	112	21.6
	25	72.0	13.9	90.0	18.9	101	21.7	102	21.9	104	22.0	107	22.3	111	22.5
	27	72.0	14.9	90.0	20.1	99.2	22.7	101	22.8	103	22.9	106	23.2	109	23.5
	29	72.0	15.8	90.0	21.5	97.8	23.6	99.4	23.7	101	23.9	104	24.2	108	24.5
	31	72.0	16.8	90.0	22.9	96.3	24.5	98.0	24.7	99.7	24.8	103	25.1	106	25.4
	33	72.0	17.9	90.0	24.4	94.8	25.4	96.5	25.6	98.2	25.8	102	26.1	105	26.4
	35	72.0	19.0	90.0	26.0	93.4	26.4	95.1	26.5	96.7	26.7	100.1	27.1	103	27.4
	37	72.0	20.2	88.5	26.9	91.9	27.3	93.6	27.5	95.3	27.7	98.6	28.0	102	28.4
	39	72.0	21.5	87.1	27.8	90.4	28.2	92.1	28.4	93.8	28.6	97.2	29.0	100.5	29.4
120% 108.00 kW	10	66.5	10.3	83.1	13.0	100	15.8	108	17.2	113	17.8	116	17.0	119	16.2
	12	66.5	10.5	83.1	13.2	100	16.1	108	17.5	112	17.7	115	16.9	118	16.3
	14	66.5	10.6	83.1	13.4	100	16.4	108	17.8	110	17.6	113	17.0	117	17.2
	16	66.5	10.8	83.1	13.7	100	16.7	107	18.0	109	17.8	112	17.9	115	18.1
	18	66.5	11.0	83.1	13.9	100	17.1	106	18.6	107	18.7	110	18.9	114	19.1
	20	66.5	11.2	83.1	14.3	100	18.4	104	19.5	106	19.6	109	19.8	112	20.0
	21	66.5	11.3	83.1	14.8	100	19.0	104	19.9	105	20.0	108	20.3	111	20.5
	23	66.5	11.8	83.1	15.8	100	20.4	102	20.8	104	20.9	107	21.2	110	21.4
	25	66.5	12.6	83.1	16.9	99.1	21.6	101	21.7	102	21.9	105	22.1	108	22.4
	27	66.5	13.4	83.1	18.0	97.7	22.5	99.2	22.7	101	22.8	104	23.0	107	23.3
	29	66.5	14.3	83.1	19.2	96.2	23.4	97.8	23.6	99.3	23.7	102	23.0	106	24.3
	31	66.5	15.2	83.1	20.5	94.7	24.4	96.3	24.5	97.9	24.6	101	24.9	104	25.2
	33	66.5	16.1	83.1	21.8	93.3	25.3	94.8	25.4	96.4	25.6	99.5	25.9	103	26.2
	35	66.5	17.1	83.1	23.2	91.8	26.2	93.4	26.4	94.9	26.5	98.0	26.8	101.1	27.2
	37	66.5	18.2	83.1	24.7	90.3	27.1	91.9	27.3	93.5	27.5	96.6	27.8	99.7	28.1
	39	66.5	19.3	83.1	26.2	88.9	28.0	90.4	28.2	92.0	28.4	95.1	28.8	98.2	29.1
110% 99.00 kW	10	60.9	9.4	76.2	11.8	91.4	14.4	99.0	15.7	107	17.0	114	17.6	117	16.8
	12	60.9	9.6	76.2	12.0	91.4	14.6	99.0	15.9	107	17.3	113	17.5	116	16.7
	14	60.9	9.8	76.2	12.2	91.4	14.9	99.0	16.2	107	17.6	111	17.4	114	17.1
	16	60.9	9.9	76.2	12.5	91.4	15.1	99.0	16.5	107	17.9	110	17.8	113	18.0
	18	60.9	10.1	76.2	12.7	91.4	15.4	99.0	17.0	106	18.5	108	18.7	111	18.9
	20	60.9	10.3	76.2	12.9	91.4	16.3	99.0	18.2	104	19.5	107	19.6	110	19.8
	21	60.9	10.3	76.2	13.1	91.4	16.8	99.0	18.9	103	19.9	106	20.1	109	20.3
	23	60.9	10.6	76.2	14.1	91.4	18.0	99.0	20.2	102	20.8	105	21.0	108	21.2
	25	60.9	11.3	76.2	15.0	91.4	19.3	99.0	21.6	100	21.7	103	21.9	106	22.2
	27	60.9	12.0	76.2	16.0	91.4	20.6	97.5	22.5	99.0	22.6	102	22.9	105	23.1
	29	60.9	12.8	76.2	17.0	91.4	22.0	96.1	23.4	97.5	23.6	100.4	23.8	103	24.1
	31	60.9	13.6	76.2	18.1	91.4	23.4	94.6	24.3	96.0	24.5	98.9	24.7	102	25.0
	33	60.9	14.4	76.2	19.3	91.4	25.0	93.1	25.3	94.6	25.4	97.4	25.7	100.3	26.0
	35	60.9	15.3	76.2	20.5	90.3	26.0	91.7	26.2	93.1	26.3	96.0	26.6	98.8	26.9
	37	60.9	16.2	76.2	21.8	88.8	26.9	90.2	27.1	91.6	27.3	94.5	27.6	97.3	27.9
	39	60.9	17.2	76.2	23.2	87.3	27.9	88.8	28.0	90.2	28.2	93.0	28.5	95.9	28.9
100% 90.00 kW	10	55.4	8.6	69.2	10.7	83.1	13.0	90.0	14.1	96.9	15.3	111	17.7	115	17.4
	12	55.4	8.8	69.2	10.9	83.1	13.2	90.0	14.4	96.9	15.6	111	18.0	113	17.3
	14	55.4	8.9	69.2	11.1	83.1	13.4	90.0	14.6	96.9	15.9	109	17.9	112	17.2
	16	55.4	9.0	69.2	11.3	83.1	13.7	90.0	14.9	96.9	16.1	108	17.8	110	17.9
	18	55.4	9.2	69.2	11.5	83.1	13.9	90.0	15.2	96.9	16.5	106	18.6	109	18.8
	20	55.4	9.3	69.2	11.7	83.1	14.3	90.0	15.9	96.9	17.7	105	19.5	107	19.7
	21	55.4	9.4	69.2	11.8	83.1	14.8	90.0	16.5	96.9	18.3	104	20.0	107	20.1
	23	55.4	9.6	69.2	12.4	83.1	15.8	90.0	17.6	96.9	19.6	103	20.9	105	21.1
	25	55.4	10.1	69.2	13.3	83.1	16.9	90.0	18.9	96.9	21.0	101	21.8	104	22.0
	27	55.4	10.7	69.2	14.1	83.1	18.0	90.0	20.1	96.9	22.4	99.7	22.7	102	22.9
	29	55.4	11.4	69.2	15.0	83.1	19.2	90.0	21.5	95.7	23.4	98.3	23.6	100.9	23.9
	31	55.4	12.1	69.2	16.0	83.1	20.5	90.0	22.9	94.2	24.3	96.8	24.5	99.4	24.8
	33	55.4	12.8	69.2	17.0	83.1	21.8	90.0	24.4	92.8	25.2	95.4	25.5	97.9	25.7
	35	55.4	13.6	69.2	18.1	83.1	23.2	90.0	26.0	91.3	26.1	93.9	26.4	96.5	26.7
	37	55.4	14.4	69.2	19.2	83.1	24.7	88.5	26.9	89.8	27.1	92.4	27.3	95.0	27.6
	39	55.4	15.3	69.2	20.4	83.1	26.2	87.1	27.8	88.4	28.0	91.0	28.3	93.5	28.6

NOTES - ANMERKUNGEN - Σημειώσεις - NOTAS - REMARQUES - NOTE - OPMERKINGEN - примечания - NOTLAR

- The above table shows the average value of conditions which may occur.
Die obige Tabelle zeigt den Durchschnittswert der Bedingungen, die auftreten können.
 Στον παραπάνω πίνακα αναγράφεται η μέση τιμή για συνθήκες που μπορεί να προκύψουν.
La tabla de arriba muestra el valor medio de condiciones que pueden ocurrir.
 Le tableau ci-dessus donne la valeur moyenne pour des conditions qui peuvent survenir.
La tabella in alto mostra il valore delle condizioni medie che si possono riscontrare.
 De tabel hierboven geeft de gemiddelde waarde aan van situaties die kunnen voorvallen.
Таблица расположенная выше показывает среднее значение условий, которые могут наступить.
 Yukarıdaki tablo meydana gelebilecek koşulların ortalama değerini göstermektedir.

3D079549

5 Таблицы производительности

5 - 1 Таблицы холодопроизводительности

5

RXYQ32T															
Indoor air temp. °CWB															
Combination(%) (Capacity index)	Outdoor air temp. (°CDB)	14.0		16.0		18.0		19.0		20.0		22.0		24.0	
		TC	PI	TC	PI	TC	PI	TC	PI	TC	PI	TC	PI	TC	PI
		KW	KW	KW	KW	KW	KW	KW	KW	KW	KW	KW	KW	KW	KW
90% 81.00 kW	10	49.8	7.84	62.3	9.7	74.8	11.6	81.0	12.6	87.2	13.7	99.7	15.8	112	17.9
	12	49.8	7.9	62.3	9.8	74.8	11.8	81.0	12.8	87.2	13.9	99.7	16.1	111	17.9
	14	49.8	8.1	62.3	10.0	74.8	12.0	81.0	13.1	87.2	14.1	99.7	16.4	110	17.8
	16	49.8	8.2	62.3	10.1	74.8	12.2	81.0	13.3	87.2	14.4	99.7	16.7	108	17.8
	18	49.8	8.3	62.3	10.3	74.8	12.4	81.0	13.5	87.2	14.7	99.7	17.1	107	18.6
	20	49.8	8.5	62.3	10.5	74.8	12.7	81.0	13.8	87.2	15.2	99.7	18.4	105	19.5
	21	49.8	8.5	62.3	10.6	74.8	12.8	81.0	14.3	87.2	15.8	99.7	19.0	104	20.0
	23	49.8	8.7	62.3	10.9	74.8	13.7	81.0	15.3	87.2	16.9	99.7	20.4	103	20.9
	25	49.8	9.0	62.3	11.6	74.8	14.6	81.0	16.3	87.2	18.0	99.1	21.6	101	21.8
	27	49.8	9.5	62.3	12.4	74.8	15.6	81.0	17.4	87.2	19.3	97.7	22.5	100.0	22.7
	29	49.8	10.1	62.3	13.1	74.8	16.6	81.0	18.5	87.2	20.6	96.2	23.4	98.5	23.6
	31	49.8	10.7	62.3	14.0	74.8	17.7	81.0	19.7	87.2	21.9	94.7	24.4	97.1	24.6
	33	49.8	11.3	62.3	14.8	74.8	18.8	81.0	21.0	87.2	23.3	93.3	25.3	95.6	25.5
	35	49.8	12.0	62.3	15.7	74.8	20.0	81.0	22.4	87.2	24.9	91.8	26.2	94.1	26.4
	37	49.8	12.7	62.3	16.7	74.8	21.3	81.0	23.8	87.2	26.5	90.3	27.1	92.7	27.4
	39	49.8	13.4	62.3	17.7	74.8	22.6	81.0	25.3	86.6	27.8	88.9	28.0	91.2	28.3
80% 72.00 kW	10	44.3	7.07	55.4	8.6	66.5	10.3	72.0	11.2	77.5	12.1	88.6	13.9	99.7	15.8
	12	44.3	7.17	55.4	8.8	66.5	10.5	72.0	11.4	77.5	12.3	88.6	14.1	99.7	16.1
	14	44.3	7.27	55.4	8.9	66.5	10.6	72.0	11.5	77.5	12.5	88.6	14.4	99.7	16.4
	16	44.3	7.38	55.4	9.0	66.5	10.8	72.0	11.7	77.5	12.7	88.6	14.6	99.7	16.7
	18	44.3	7.49	55.4	9.2	66.5	11.0	72.0	12.0	77.5	12.9	88.6	14.9	99.7	17.1
	20	44.3	7.60	55.4	9.3	66.5	11.2	72.0	12.2	77.5	13.2	88.6	15.6	99.7	18.4
	21	44.3	7.66	55.4	9.4	66.5	11.3	72.0	12.3	77.5	13.5	88.6	16.1	99.7	19.0
	23	44.3	7.78	55.4	9.6	66.5	11.8	72.0	13.1	77.5	14.4	88.6	17.3	99.7	20.4
	25	44.3	7.9	55.4	10.1	66.5	12.6	72.0	13.9	77.5	15.4	88.6	18.4	99.1	21.6
	27	44.3	8.4	55.4	10.7	66.5	13.4	72.0	14.9	77.5	16.4	88.6	19.7	97.7	22.5
	29	44.3	8.9	55.4	11.4	66.5	14.3	72.0	15.8	77.5	17.5	88.6	21.0	96.2	23.4
	31	44.3	9.4	55.4	12.1	66.5	15.2	72.0	16.8	77.5	18.6	88.6	22.4	94.7	24.4
	33	44.3	10.0	55.4	12.8	66.5	16.1	72.0	17.9	77.5	19.8	88.6	23.9	93.3	25.3
	35	44.3	10.5	55.4	13.6	66.5	17.1	72.0	19.0	77.5	21.0	88.6	25.4	91.8	26.2
	37	44.3	11.1	55.4	14.4	66.5	18.2	72.0	20.2	77.5	22.4	88.3	26.9	90.3	27.1
	39	44.3	11.8	55.4	15.3	66.5	19.3	72.0	21.5	77.5	23.8	86.8	27.8	88.9	28.0
70% 63.00 kW	10	38.8	6.35	48.5	7.64	58.2	9.0	63.0	9.8	67.8	10.5	77.5	12.1	87.2	13.7
	12	38.8	6.43	48.5	7.75	58.2	9.2	63.0	9.9	67.8	10.7	77.5	12.3	87.2	13.9
	14	38.8	6.51	48.5	7.87	58.2	9.3	63.0	10.1	67.8	10.9	77.5	12.5	87.2	14.1
	16	38.8	6.60	48.5	7.99	58.2	9.5	63.0	10.3	67.8	11.0	77.5	12.7	87.2	14.4
	18	38.8	6.69	48.5	8.11	58.2	9.6	63.0	10.4	67.8	11.2	77.5	12.9	87.2	14.7
	20	38.8	6.79	48.5	8.2	58.2	9.8	63.0	10.6	67.8	11.4	77.5	13.2	87.2	15.2
	21	38.8	6.84	48.5	8.3	58.2	9.9	63.0	10.7	67.8	11.5	77.5	13.5	87.2	15.8
	23	38.8	6.94	48.5	8.4	58.2	10.1	63.0	11.1	67.8	12.1	77.5	14.4	87.2	16.9
	25	38.8	7.04	48.5	8.7	58.2	10.7	63.0	11.8	67.8	12.9	77.5	15.4	87.2	18.0
	27	38.8	7.34	48.5	9.2	58.2	11.4	63.0	12.5	67.8	13.8	77.5	16.4	87.2	19.3
	29	38.8	7.76	48.5	9.8	58.2	12.1	63.0	13.3	67.8	14.6	77.5	17.5	87.2	20.6
	31	38.8	8.2	48.5	10.4	58.2	12.8	63.0	14.2	67.8	15.6	77.5	18.6	87.2	21.9
	33	38.8	8.7	48.5	11.0	58.2	13.6	63.0	15.0	67.8	16.5	77.5	19.8	87.2	23.3
	35	38.8	9.2	48.5	11.6	58.2	14.4	63.0	16.0	67.8	17.6	77.5	21.0	87.2	24.9
	37	38.8	9.7	48.5	12.3	58.2	15.3	63.0	16.9	67.8	18.7	77.5	22.4	87.2	26.5
	39	38.8	10.2	48.5	13.0	58.2	16.2	63.0	18.0	67.8	19.8	77.5	23.8	86.6	27.8
60% 54.00 kW	10	33.2	5.66	41.5	6.71	49.8	7.84	54.0	8.43	58.2	9.0	66.5	10.3	74.8	11.6
	12	33.2	5.72	41.5	6.80	49.8	7.95	54.0	8.55	58.2	9.2	66.5	10.5	74.8	11.8
	14	33.2	5.79	41.5	6.89	49.8	8.07	54.0	8.7	58.2	9.3	66.5	10.6	74.8	12.0
	16	33.2	5.86	41.5	6.98	49.8	8.19	54.0	8.8	58.2	9.5	66.5	10.8	74.8	12.2
	18	33.2	5.94	41.5	7.08	49.8	8.32	54.0	9.0	58.2	9.6	66.5	11.0	74.8	12.4
	20	33.2	6.01	41.5	7.19	49.8	8.45	54.0	9.1	58.2	9.8	66.5	11.2	74.8	12.7
	21	33.2	6.05	41.5	7.24	49.8	8.5	54.0	9.2	58.2	9.9	66.5	11.3	74.8	12.8
	23	33.2	6.13	41.5	7.35	49.8	8.7	54.0	9.4	58.2	10.1	66.5	11.8	74.8	13.7
	25	33.2	6.22	41.5	7.47	49.8	9.0	54.0	9.8	58.2	10.7	66.5	12.6	74.8	14.6
	27	33.2	6.37	41.5	7.85	49.8	9.5	54.0	10.4	58.2	11.4	66.5	13.4	74.8	15.6
	29	33.2	6.72	41.5	8.3	49.8	10.1	54.0	11.1	58.2	12.1	66.5	14.3	74.8	16.6
	31	33.2	7.10	41.5	8.8	49.8	10.7	54.0	11.7	58.2	12.8	66.5	15.2	74.8	17.7
	33	33.2	7.48	41.5	9.3	49.8	11.3	54.0	12.5	58.2	13.6	66.5	16.1	74.8	18.8
	35	33.2	7.89	41.5	9.8	49.8	12.0	54.0	13.2	58.2	14.4	66.5	17.1	74.8	20.0
	37	33.2	8.3	41.5	10.4	49.8	12.7	54.0	14.0	58.2	15.3	66.5	18.2	74.8	21.3
	39	33.2	8.7	41.5	11.0	49.8	13.4	54.0	14.8	58.2	16.2	66.5	19.3	74.8	22.6
50% 45.00 kW	10	27.7	5.01	34.6	5.83	41.5	6.71	45.0	7.17	48.5	7.64	55.4	8.63	62.3	9.7
	12	27.7	5.06	34.6	5.90	41.5	6.80	45.0	7.27	48.5	7.75	55.4	8.76	62.3	9.8
	14	27.7	5.11	34.6	5.97	41.5	6.89	45.0	7.37	48.5	7.87	55.4	8.9	62.3	10.0
	16	27.7	5.17	34.6	6.04	41.5	6.98	45.0	7.48	48.5	7.99	55.4	9.0	62.3	10.1
	18	27.7	5.22	34.6	6.12	41.5	7.08	45.0	7.59	48.5	8.11	55.4	9.2	62.3	10.3
	20	27.7	5.28	34.6	6.20	41.5	7.19	45.0	7.71	48.5	8.24	55.4	9.3	62.3	10.5
	21	27.7	5.31	34.6	6.24	41.5	7.24	45.0	7.77	48.5	8.30	55.4	9.4	62.3	10.6
	23	27.7	5.38	34.6	6.33	41.5	7.35	45.0	7.89	48.5	8.44	55.4	9.6	62.3	10.9
	25	27.7	5.45	34.6	6.42	41.5	7.47	45.0	8.04	48.5	8.70	55.4	10.1	62.3	11.6
	27	27.7	5.52	34.6	6.60	41.5	7.85	45.0	8.53	48.5	9.2	55.4	10.7	62.3	12.4
	29	27.7	5.77	34.6	6.98	41.5	8.32	45.0	9.0	48.5	9.8	55.4	11.4	62.3	13.1
	31	27.7	6.08	34.6	7.37	41.5	8.8	45.0	9.6	48.5	10.4	55.4	12.1	62.3	14.0
	33	27.7	6.40	34.6	7.77	41.5	9.3	45.0	10.1	48.5	11.0	55.4	12.8	62.3	14.8
	35	27.7	6.73	34.6	8.19	41.5	9.8	45.0	10.7	48.5	11.6	55.4	13.6	62.3	15.7
	37	27.7	7.07	34.6	8.6	41.5	10.4	45.0	11.3	48.5	12.3	55.4	14.4	62.3	16.7
	39	27.7	7.43	34.6	9.1	41.5	11.0	45.0	12.0	48.5	13.0	55.4	15.3	62.3	17.7

3D079549

5 Таблицы производительности

5 - 1 Таблицы холодопроизводительности

RXYQ34T															
Indoor air temp. °CWB															
Combination(%) (Capacity index)	Outdoor air temp. (°CDB)	14.0		16.0		18.0		19.0		20.0		22.0		24.0	
		TC	PI	TC	PI	TC	PI	TC	PI	TC	PI	TC	PI	TC	PI
		KW	KW	KW	KW	KW	KW	KW	KW	KW	KW	KW	KW	KW	KW
130% 123.5 kW	10	76.0	11.9	95	15.1	114	18.3	120	19.0	121	18.5	125	17.6	129	16.6
	12	76.0	12.1	95	15.3	114	18.7	118	18.9	120	18.4	123	17.5	127	17.5
	14	76.0	12.3	95	15.6	114	19.0	117	18.8	118	18.3	122	18.3	125	18.5
	16	76.0	12.5	95	15.9	113	19.1	115	18.9	117	19.0	120	19.3	124	19.5
	18	76.0	12.7	95	16.2	112	19.8	113	19.9	115	20.0	119	20.2	122	20.5
	20	76.0	13.0	95	17.0	110	20.7	112	20.9	114	21.0	117	21.2	121	21.5
	21	76.0	13.1	95	17.6	109	21.2	111	21.4	113	21.5	116	21.7	120	22.0
	23	76.0	13.9	95	18.8	108	22.2	110	22.3	111	22.5	115	22.7	118	23.0
	25	76.0	14.9	95	20.1	106	23.2	108	23.3	110	23.4	113	23.7	117	24.0
	27	76.0	15.8	95	21.5	105	24.1	107	24.3	108	24.4	112	24.7	115	25.0
	29	76.0	16.9	95	22.9	103	25.1	105	25.3	107	25.4	110	25.8	114	26.1
	31	76.0	17.9	95	24.4	102	26.1	103	26.3	105	26.4	109	26.8	112	27.1
	33	76.0	19.1	95.0	26.0	100	27.1	102	27.3	104	27.4	107	27.8	111	28.2
	35	76.0	20.3	95.0	27.7	98.6	28.1	100	28.3	102	28.5	106	28.8	109	29.2
	37	76.0	21.5	93.5	28.7	97.0	29.1	98.8	29.3	101	29.5	104	29.9	108	30.3
	39	76.0	22.9	91.9	29.7	95.5	30.1	97.2	30.3	99.0	30.5	103	30.9	106	31.3
120% 114 kW	10	70.2	11.0	87.7	13.8	105	16.8	114	18.3	120	19.0	123	18.1	126	17.3
	12	70.2	11.1	87.7	14.1	105	17.1	114	18.7	118	18.9	121	18.0	125	17.3
	14	70.2	11.3	87.7	14.3	105	17.4	114	19.0	116	18.8	120	18.1	123	18.3
	16	70.2	11.5	87.7	14.6	105	17.7	113	19.1	115	18.9	118	19.1	121	19.3
	18	70.2	11.7	87.7	14.8	105	18.2	112	19.8	113	19.9	117	20.1	120	20.3
	20	70.2	11.9	87.7	15.2	105	19.6	110	20.7	112	20.9	115	21.1	118	21.3
	21	70.2	12.0	87.7	15.7	105	20.3	109	21.2	111	21.3	114	21.6	118	21.8
	23	70.2	12.6	87.7	16.8	105	21.7	108	22.2	109	22.3	113	22.6	116	22.8
	25	70.2	13.4	87.7	18.0	105	23.0	106	23.2	108	23.3	111	23.6	114	23.8
	27	70.2	14.3	87.7	19.2	103	24.0	105	24.1	106	24.3	110	24.6	113	24.8
	29	70.2	15.2	87.7	20.5	102	25.0	103	25.1	105	25.3	108	25.6	111	25.9
	31	70.2	16.2	87.7	21.8	100	25.9	102	26.1	103	26.3	107	26.6	110	26.9
	33	70.2	17.2	87.7	23.2	98.5	26.9	100	27.1	102	27.2	105	27.6	108	27.9
	35	70.2	18.2	87.7	24.7	96.9	27.9	98.6	28.1	100	28.3	103	28.6	107	28.9
	37	70.2	19.3	87.7	26.3	95.4	28.9	97.0	29.1	98.7	29.3	102	29.6	105	30.0
	39	70.2	20.5	87.7	27.9	93.8	29.9	95.5	30.1	97.1	30.3	100	30.7	104	31.0
110% 104.5 kW	10	64.3	10.1	80.4	12.6	96.5	15.3	105	16.7	113	18.1	121	18.7	124	17.9
	12	64.3	10.2	80.4	12.8	96.5	15.6	105	17.0	113	18.4	119	18.6	122	17.8
	14	64.3	10.4	80.4	13.0	96.5	15.8	105	17.3	113	18.7	118	18.5	121	18.2
	16	64.3	10.6	80.4	13.3	96.5	16.1	105	17.6	113	19.1	116	19.0	119	19.2
	18	64.3	10.7	80.4	13.5	96.5	16.4	105	18.1	111	19.8	114	20.0	117	20.2
	20	64.3	10.9	80.4	13.8	96.5	17.3	105	19.4	110	20.7	113	20.9	116	21.1
	21	64.3	11.0	80.4	14.0	96.5	17.9	105	20.1	109	21.2	112	21.4	115	21.6
	23	64.3	11.3	80.4	15.0	96.5	19.2	105	21.5	108	22.2	111	22.4	114	22.6
	25	64.3	12.0	80.4	16.0	96.5	20.5	105	23.0	106	23.1	109	23.4	112	23.6
	27	64.3	12.8	80.4	17.0	96.5	21.9	103	24.0	104	24.1	107	24.4	110	24.6
	29	64.3	13.6	80.4	18.2	96.5	23.4	101	25.0	103	25.1	106	25.4	109	25.6
	31	64.3	14.5	80.4	19.3	96.5	24.9	100	25.9	101	26.1	104	26.4	107	26.6
	33	64.3	15.4	80.4	20.6	96.5	26.6	98.3	26.9	100	27.1	103	27.4	106	27.7
	35	64.3	16.3	80.4	21.9	95.3	27.7	96.8	27.9	98.3	28.0	101	28.4	104	28.7
	37	64.3	17.3	80.4	23.3	93.7	28.7	95.2	28.9	96.7	29.0	100	29.4	103	29.7
	39	64.3	18.3	80.4	24.7	92.2	29.7	93.7	29.9	95.2	30.0	98.2	30.4	101	30.8
100% 95.00 kW	10	58.5	9.2	73.1	11.4	87.7	13.8	95.0	15.1	102	16.3	117	18.9	121	18.6
	12	58.5	9.3	73.1	11.6	87.7	14.1	95.0	15.3	102	16.6	117	19.2	120	18.5
	14	58.5	9.5	73.1	11.8	87.7	14.3	95.0	15.6	102	16.9	115	19.1	118	18.4
	16	58.5	9.6	73.1	12.0	87.7	14.6	95.0	15.9	102	17.2	114	19.0	117	19.0
	18	58.5	9.8	73.1	12.2	87.7	14.8	95.0	16.2	102	17.5	112	19.8	115	20.0
	20	58.5	10.0	73.1	12.5	87.7	15.2	95.0	17.0	102	18.8	111	20.8	113	21.0
	21	58.5	10.0	73.1	12.6	87.7	15.7	95.0	17.6	102	19.5	110	21.3	113	21.5
	23	58.5	10.2	73.1	13.2	87.7	16.8	95.0	18.8	102	20.9	108	22.2	111	22.4
	25	58.5	10.8	73.1	14.1	87.7	18.0	95.0	20.1	102	22.3	107	23.2	110	23.4
	27	58.5	11.4	73.1	15.0	87.7	19.2	95.0	21.5	102	23.9	105	24.2	108	24.4
	29	58.5	12.1	73.1	16.0	87.7	20.5	95.0	22.9	101	24.9	104	25.2	106	25.4
	31	58.5	12.9	73.1	17.0	87.7	21.8	95.0	24.4	99	25.9	102	26.2	105	26.4
	33	58.5	13.7	73.1	18.1	87.7	23.2	95.0	26.0	97.9	26.9	101	27.1	103	27.4
	35	58.5	14.5	73.1	19.2	87.7	24.7	95.0	27.7	96.4	27.8	99.1	28.1	102	28.4
	37	58.5	15.4	73.1	20.4	87.7	26.3	93.5	28.7	94.8	28.8	97.6	29.1	100	29.4
	39	58.5	16.3	73.1	21.7	87.7	27.9	91.9	29.7	93.3	29.8	96.0	30.1	98.7	30.5

NOTES - ANMERKUNGEN - Σημειώσεις - NOTAS - REMARQUES - NOTE - OPMERKINGEN - примечания - NOTLAR

- The above table shows the average value of conditions which may occur.
Die obige Tabelle zeigt den Durchschnittswert der Bedingungen, die auftreten können.
 Στον παραπάνω πίνακα αναγράφεται η μέση τιμή για συνθήκες που μπορεί να προκύψουν.
La tabla de arriba muestra el valor medio de condiciones que pueden ocurrir.
 Le tableau ci-dessus donne la valeur moyenne pour des conditions qui peuvent survenir.
La tabella in alto mostra il valore delle condizioni medie che si possono riscontrare.
 De tabel hierboven geeft de gemiddelde waarde aan van situaties die kunnen voorvallen.
Таблица расположенная выше показывает среднее значение условий, которые могут наступить.
 Yukarıdaki tablo meydana gelebilecek koşulların ortalama değerini göstermektedir.

3D079549

5 Таблицы производительности

5 - 1 Таблицы холодопроизводительности

5

RXYQ34T															
Indoor air temp. °CWB															
Combination(%) (Capacity index)	Outdoor air temp. (°CDB)	14.0		16.0		18.0		19.0		20.0		22.0		24.0	
		TC	PI	TC	PI	TC	PI	TC	PI	TC	PI	TC	PI	TC	PI
		KW	KW	KW	KW	KW	KW	KW	KW	KW	KW	KW	KW	KW	KW
90% 85.50 kW	10	52.6	8.35	65.8	10.3	78.9	12.4	85.5	13.4	92.1	14.6	105	16.8	118	19.1
	12	52.6	8.47	65.8	10.5	78.9	12.6	85.5	13.7	92.1	14.8	105	17.1	117	19.1
	14	52.6	8.60	65.8	10.6	78.9	12.8	85.5	13.9	92.1	15.1	105	17.4	116	19.0
	16	52.6	8.73	65.8	10.8	78.9	13.0	85.5	14.2	92.1	15.3	105	17.7	114	18.9
	18	52.6	8.86	65.8	11.0	78.9	13.3	85.5	14.4	92.1	15.6	105	18.2	113	19.8
	20	52.6	9.01	65.8	11.2	78.9	13.5	85.5	14.7	92.1	16.2	105	19.6	111	20.8
	21	52.6	9.08	65.8	11.3	78.9	13.7	85.5	15.2	92.1	16.8	105	20.3	110	21.3
	23	52.6	9.2	65.8	11.6	78.9	14.6	85.5	16.3	92.1	18.0	105	21.7	109	22.3
	25	52.6	9.6	65.8	12.4	78.9	15.6	85.5	17.4	92.1	19.2	105	23.0	107	23.2
	27	52.6	10.1	65.8	13.2	78.9	16.6	85.5	18.5	92.1	20.5	103	24.0	106	24.2
	29	52.6	10.8	65.8	14.0	78.9	17.7	85.5	19.8	92.1	21.9	102	25.0	104	25.2
	31	52.6	11.4	65.8	14.9	78.9	18.9	85.5	21.0	92.1	23.3	100	25.9	102	26.2
	33	52.6	12.1	65.8	15.8	78.9	20.1	85.5	22.4	92.1	24.9	98.5	26.9	101	27.2
	35	52.6	12.8	65.8	16.8	78.9	21.3	85.5	23.8	92.1	26.5	96.9	27.9	99.4	28.2
	37	52.6	13.5	65.8	17.8	78.9	22.7	85.5	25.3	92.1	28.2	95.4	28.9	97.8	29.2
	39	52.6	14.3	65.8	18.9	78.9	24.1	85.5	27.0	91.4	29.6	93.8	29.9	96.3	30.2
80% 76.00 kW	10	46.8	7.54	58.5	9.19	70.2	11.0	76.0	11.9	81.8	12.8	93.5	14.8	105	16.8
	12	46.8	7.64	58.5	9.33	70.2	11.1	76.0	12.1	81.8	13.1	93.5	15.1	105	17.1
	14	46.8	7.75	58.5	9.48	70.2	11.3	76.0	12.3	81.8	13.3	93.5	15.3	105	17.4
	16	46.8	7.86	58.5	9.6	70.2	11.5	76.0	12.5	81.8	13.5	93.5	15.6	105	17.7
	18	46.8	7.98	58.5	9.8	70.2	11.7	76.0	12.7	81.8	13.8	93.5	15.9	105	18.2
	20	46.8	8.10	58.5	10.0	70.2	11.9	76.0	13.0	81.8	14.0	93.5	16.6	105	19.6
	21	46.8	8.16	58.5	10.0	70.2	12.0	76.0	13.1	81.8	14.3	93.5	17.2	105	20.3
	23	46.8	8.29	58.5	10.2	70.2	12.6	76.0	13.9	81.8	15.3	93.5	18.4	105	21.7
	25	46.8	8.43	58.5	10.8	70.2	13.4	76.0	14.9	81.8	16.4	93.5	19.7	105	23.0
	27	46.8	8.94	58.5	11.4	70.2	14.3	76.0	15.8	81.8	17.5	93.5	21.0	103	24.0
	29	46.8	9.5	58.5	12.1	70.2	15.2	76.0	16.9	81.8	18.6	93.5	22.4	102	25.0
	31	46.8	10.0	58.5	12.9	70.2	16.2	76.0	17.9	81.8	19.8	93.5	23.9	100	25.9
	33	46.8	10.6	58.5	13.7	70.2	17.2	76.0	19.1	81.8	21.1	93.5	25.4	98.5	26.9
	35	46.8	11.2	58.5	14.5	70.2	18.2	76.0	20.3	81.8	22.4	93.5	27.1	96.9	27.9
	37	46.8	11.9	58.5	15.4	70.2	19.3	76.0	21.5	81.8	23.8	93.2	28.6	95.4	28.9
	39	46.8	12.5	58.5	16.3	70.2	20.5	76.0	22.9	81.8	25.3	91.6	29.6	93.8	29.9
70% 66.50 kW	10	40.9	6.76	51.2	8.14	61.4	9.63	66.5	10.4	71.6	11.2	81.8	12.8	92.1	14.6
	12	40.9	6.85	51.2	8.26	61.4	9.78	66.5	10.6	71.6	11.4	81.8	13.1	92.1	14.8
	14	40.9	6.94	51.2	8.38	61.4	9.9	66.5	10.7	71.6	11.6	81.8	13.3	92.1	15.1
	16	40.9	7.03	51.2	8.51	61.4	10.1	66.5	10.9	71.6	11.8	81.8	13.5	92.1	15.3
	18	40.9	7.13	51.2	8.64	61.4	10.3	66.5	11.1	71.6	12.0	81.8	13.8	92.1	15.6
	20	40.9	7.23	51.2	8.78	61.4	10.4	66.5	11.3	71.6	12.2	81.8	14.0	92.1	16.2
	21	40.9	7.28	51.2	8.85	61.4	10.5	66.5	11.4	71.6	12.3	81.8	14.3	92.1	16.8
	23	40.9	7.39	51.2	8.99	61.4	10.7	66.5	11.8	71.6	12.9	81.8	15.3	92.1	18.0
	25	40.9	7.50	51.2	9.26	61.4	11.4	66.5	12.5	71.6	13.8	81.8	16.4	92.1	19.2
	27	40.9	7.82	51.2	9.8	61.4	12.1	66.5	13.4	71.6	14.7	81.8	17.5	92.1	20.5
	29	40.9	8.27	51.2	10.4	61.4	12.9	66.5	14.2	71.6	15.6	81.8	18.6	92.1	21.9
	31	40.9	8.74	51.2	11.1	61.4	13.7	66.5	15.1	71.6	16.6	81.8	19.8	92.1	23.3
	33	40.9	9.2	51.2	11.7	61.4	14.5	66.5	16.0	71.6	17.6	81.8	21.1	92.1	24.9
	35	40.9	9.8	51.2	12.4	61.4	15.4	66.5	17.0	71.6	18.7	81.8	22.4	92.1	26.5
	37	40.9	10.3	51.2	13.1	61.4	16.3	66.5	18.0	71.6	19.9	81.8	23.8	92.1	28.2
	39	40.9	10.9	51.2	13.9	61.4	17.3	66.5	19.1	71.6	21.1	81.8	25.3	91.4	29.6
60% 57.00 kW	10	35.1	6.03	43.8	7.15	52.6	8.35	57.0	8.98	61.4	9.63	70.2	11.0	78.9	12.4
	12	35.1	6.10	43.8	7.24	52.6	8.47	57.0	9.11	61.4	9.78	70.2	11.1	78.9	12.6
	14	35.1	6.17	43.8	7.34	52.6	8.60	57.0	9.25	61.4	9.93	70.2	11.3	78.9	12.8
	16	35.1	6.25	43.8	7.44	52.6	8.73	57.0	9.40	61.4	10.1	70.2	11.5	78.9	13.0
	18	35.1	6.32	43.8	7.55	52.6	8.86	57.0	9.55	61.4	10.3	70.2	11.7	78.9	13.3
	20	35.1	6.41	43.8	7.66	52.6	9.01	57.0	9.71	61.4	10.4	70.2	11.9	78.9	13.5
	21	35.1	6.45	43.8	7.72	52.6	9.08	57.0	9.79	61.4	10.5	70.2	12.0	78.9	13.7
	23	35.1	6.54	43.8	7.83	52.6	9.23	57.0	10.0	61.4	10.7	70.2	12.6	78.9	14.6
	25	35.1	6.63	43.8	7.96	52.6	9.55	57.0	10.4	61.4	11.4	70.2	13.4	78.9	15.6
	27	35.1	6.78	43.8	8.37	52.6	10.1	57.0	11.1	61.4	12.1	70.2	14.3	78.9	16.6
	29	35.1	7.16	43.8	8.86	52.6	10.8	57.0	11.8	61.4	12.9	70.2	15.2	78.9	17.7
	31	35.1	7.56	43.8	9.37	52.6	11.4	57.0	12.5	61.4	13.7	70.2	16.2	78.9	18.9
	33	35.1	7.97	43.8	9.9	52.6	12.1	57.0	13.3	61.4	14.5	70.2	17.2	78.9	20.1
	35	35.1	8.40	43.8	10.5	52.6	12.8	57.0	14.1	61.4	15.4	70.2	18.2	78.9	21.3
	37	35.1	8.85	43.8	11.1	52.6	13.5	57.0	14.9	61.4	16.3	70.2	19.3	78.9	22.7
	39	35.1	9.3	43.8	11.7	52.6	14.3	57.0	15.8	61.4	17.3	70.2	20.5	78.9	24.1
50% 47.50 kW	10	29.2	5.33	36.5	6.21	43.8	7.15	47.5	7.64	51.2	8.14	58.5	9.19	65.8	10.29
	12	29.2	5.39	36.5	6.28	43.8	7.24	47.5	7.74	51.2	8.26	58.5	9.33	65.8	10.5
	14	29.2	5.44	36.5	6.36	43.8	7.34	47.5	7.85	51.2	8.38	58.5	9.48	65.8	10.6
	16	29.2	5.50	36.5	6.44	43.8	7.44	47.5	7.97	51.2	8.51	58.5	9.63	65.8	10.8
	18	29.2	5.57	36.5	6.52	43.8	7.55	47.5	8.09	51.2	8.64	58.5	9.79	65.8	11.0
	20	29.2	5.63	36.5	6.61	43.8	7.66	47.5	8.21	51.2	8.78	58.5	9.95	65.8	11.2
	21	29.2	5.66	36.5	6.65	43.8	7.72	47.5	8.27	51.2	8.85	58.5	10.04	65.8	11.3
	23	29.2	5.73	36.5	6.74	43.8	7.83	47.5	8.41	51.2	8.99	58.5	10.2	65.8	11.6
	25	29.2	5.80	36.5	6.84	43.8	7.96	47.5	8.56	51.2	9.26	58.5	10.8	65.8	12.4
	27	29.2	5.88	36.5	7.03	43.8	8.37	47.5	9.08	51.2	9.84	58.5	11.4	65.8	13.2
	29	29.2	6.15	36.5	7.43	43.8	8.86	47.5	9.63	51.2	10.4	58.5	12.1	65.8	14.0
	31	29.2	6.48	36.5	7.85	43.8	9.37	47.5	10.2	51.2	11.1	58.5	12.9	65.8	14.9
	33	29.2	6.82	36.5	8.28	43.8	9.91	47.5	10.8	51.2	11.7	58.5	13.7	65.8	15.8
	35	29.2	7.17	36.5	8.73	43.8	10.5	47.5	11.4	51.2	12.4	58.5	14.5	65.8	16.8
	37	29.2	7.54	36.5	9.20	43.8	11.1	47.5	12.1	51.2	13.1	58.5	15.4	65.8	17.8
	39	29.2	7.92	36.5	9.69	43.8	11.7	47.5	12.7	51.2	13.9	58.5	16.3	65.8	18.9

3D079549

5 Таблицы производительности

5 - 1 Таблицы холодопроизводительности

RXYQ36T															
Indoor air temp. °CWB															
Combination(%) (Capacity index)	Outdoor air temp. (°CDB)	14.0		16.0		18.0		19.0		20.0		22.0		24.0	
		TC	PI	TC	PI	TC	PI	TC	PI	TC	PI	TC	PI	TC	PI
		KW		KW		KW		KW		KW		KW		KW	
130% 131.30 kW	10	80.8	13.5	101	17.1	121	20.9	127	21.6	129	21.0	133	20.0	137	18.9
	12	80.8	13.8	101	17.4	121	21.2	126	21.5	127	20.9	131	19.8	135	19.9
	14	80.8	14.0	101	17.7	121	21.6	124	21.3	126	20.8	130	20.8	133	21.0
	16	80.8	14.2	101	18.0	120	21.8	122	21.5	124	21.6	128	21.9	132	22.1
	18	80.8	14.5	101	18.4	119	22.5	121	22.6	123	22.8	126	23.0	130	23.3
	20	80.8	14.8	101	19.3	117	23.6	119	23.7	121	23.9	125	24.1	128	24.4
	21	80.8	14.9	101	20.0	116	24.1	118	24.3	120	24.4	124	24.7	128	25.0
	23	80.8	15.8	101	21.4	115	25.2	117	25.4	118	25.5	122	25.8	126	26.2
	25	80.8	16.9	101	22.8	113	26.3	115	26.5	117	26.7	121	27.0	124	27.3
	27	80.8	18.0	101	24.4	111	27.4	113	27.6	115	27.8	119	28.1	123	28.5
	29	80.8	19.2	101	26.0	110	28.6	112	28.7	113	28.9	117	29.3	121	29.7
	31	80.8	20.4	101	27.8	108	29.7	110	29.9	112	30.1	116	30.4	119	30.8
	33	80.8	21.7	101	29.6	106	30.8	108	31.0	110	31.2	114	31.6	118	32.0
	35	80.8	23.0	101	31.5	105	31.9	107	32.1	109	32.4	112	32.8	116	33.2
	37	80.8	24.5	99	32.6	103	33.1	105	33.3	107	33.5	111	34.0	114	34.4
	39	80.8	26.0	97.7	33.7	101	34.2	103	34.4	105	34.7	109	35.2	113	35.6
120% 121.20 kW	10	74.6	12.5	93.2	15.7	112	19.1	121	20.9	127	21.6	131	20.6	134	19.7
	12	74.6	12.7	93.2	16.0	112	19.5	121	21.2	125	21.5	129	20.5	132	19.7
	14	74.6	12.9	93.2	16.3	112	19.8	121	21.6	124	21.4	127	20.6	131	20.8
	16	74.6	13.1	93.2	16.6	112	20.2	120	21.8	122	21.5	126	21.7	129	22.0
	18	74.6	13.3	93.2	16.9	112	20.8	119	22.5	120	22.6	124	22.9	127	23.1
	20	74.6	13.6	93.2	17.3	112	22.3	117	23.6	119	23.7	122	24.0	126	24.2
	21	74.6	13.7	93.2	17.9	112	23.1	116	24.1	118	24.3	122	24.5	125	24.8
	23	74.6	14.3	93.2	19.1	112	24.7	115	25.2	116	25.4	120	25.7	123	25.9
	25	74.6	15.2	93.2	20.4	111	26.2	113	26.3	115	26.5	118	26.8	122	27.1
	27	74.6	16.2	93.2	21.8	110	27.3	111	27.4	113	27.6	117	27.9	120	28.2
	29	74.6	17.3	93.2	23.3	108	28.4	110	28.6	111	28.7	115	29.1	118	29.4
	31	74.6	18.4	93.2	24.8	106	29.5	108	29.7	110	29.9	113	30.2	117	30.6
	33	74.6	19.5	93.2	26.4	105	30.6	106	30.8	108	31.0	112	31.4	115	31.7
	35	74.6	20.7	93.2	28.1	103	31.7	105	31.9	107	32.1	110	32.5	114	32.9
	37	74.6	22.0	93.2	29.9	101	32.9	103	33.1	105	33.3	108	33.7	112	34.1
	39	74.6	23.4	93.2	31.8	100	34.0	101	34.2	103	34.4	107	34.9	110	35.3
110% 111.10 kW	10	68.4	11.4	85.5	14.3	103	17.4	111	19.0	120	20.6	128	21.3	131	20.4
	12	68.4	11.6	85.5	14.6	103	17.7	111	19.3	120	20.9	127	21.2	130	20.3
	14	68.4	11.8	85.5	14.8	103	18.0	111	19.7	120	21.3	125	21.0	128	20.7
	16	68.4	12.0	85.5	15.1	103	18.4	111	20.0	120	21.7	123	21.6	126	21.8
	18	68.4	12.2	85.5	15.4	103	18.7	111	20.5	118	22.5	122	22.7	125	22.9
	20	68.4	12.4	85.5	15.7	103	19.7	111	22.1	117	23.6	120	23.8	123	24.0
	21	68.4	12.5	85.5	15.9	103	20.4	111	22.8	116	24.1	119	24.4	122	24.6
	23	68.4	12.9	85.5	17.0	103	21.8	111	24.5	114	25.2	118	25.5	121	25.7
	25	68.4	13.7	85.5	18.2	103	23.3	111	26.2	113	26.3	116	26.6	119	26.9
	27	68.4	14.6	85.5	19.4	103	24.9	109	27.3	111	27.4	114	27.7	117	28.0
	29	68.4	15.5	85.5	20.7	103	26.6	108	28.4	109	28.5	113	28.8	116	29.1
	31	68.4	16.5	85.5	22.0	103	28.4	106	29.5	108	29.6	111	30.0	114	30.3
	33	68.4	17.5	85.5	23.4	103	30.2	105	30.6	106	30.8	109	31.1	113	31.5
	35	68.4	18.5	85.5	24.9	101	31.5	103	31.7	104	31.9	108	32.3	111	32.6
	37	68.4	19.7	85.5	26.4	99.6	32.6	101	32.8	103	33.0	106	33.4	109	33.8
	39	68.4	20.8	85.5	28.1	98.0	33.8	99.6	34.0	101	34.2	104	34.6	108	35.0
100% 101 kW	10	62.2	10.5	77.7	13.0	93.2	15.7	101	17.1	109	18.5	124	21.4	129	21.1
	12	62.2	10.6	77.7	13.2	93.2	16.0	101	17.4	109	18.9	124	21.8	127	21.0
	14	62.2	10.8	77.7	13.4	93.2	16.3	101	17.7	109	19.2	123	21.7	126	20.9
	16	62.2	11.0	77.7	13.7	93.2	16.6	101	18.0	109	19.6	121	21.6	124	21.6
	18	62.2	11.1	77.7	13.9	93.2	16.9	101	18.4	109	19.9	119	22.5	122	22.7
	20	62.2	11.3	77.7	14.2	93.2	17.3	101	19.3	109	21.4	118	23.6	121	23.8
	21	62.2	11.4	77.7	14.3	93.2	17.9	101	20.0	109	22.2	117	24.2	120	24.4
	23	62.2	11.6	77.7	15.1	93.2	19.1	101	21.4	109	23.7	115	25.3	118	25.5
	25	62.2	12.2	77.7	16.1	93.2	20.4	101	22.8	109	25.4	114	26.4	116	26.6
	27	62.2	13.0	77.7	17.1	93.2	21.8	101	24.4	109	27.1	112	27.5	115	27.8
	29	62.2	13.8	77.7	18.2	93.2	23.3	101	26.0	107	28.3	110	28.6	113	28.9
	31	62.2	14.7	77.7	19.4	93.2	24.8	101	27.8	106	29.4	109	29.7	112	30.0
	33	62.2	15.5	77.7	20.6	93.2	26.4	101	29.6	104	30.6	107	30.9	110	31.2
	35	62.2	16.5	77.7	21.9	93.2	28.1	101	31.5	102	31.7	105	32.0	108	32.3
	37	62.2	17.5	77.7	23.2	93.2	29.9	99.4	32.6	101	32.8	104	33.1	107	33.5
	39	62.2	18.5	77.7	24.7	93.2	31.8	97.7	33.7	99.2	33.9	102	34.3	105	34.6

NOTES - ANMERKUNGEN - Σημειώσεις - NOTAS - REMARQUES - NOTE - OPMERKINGEN - примечания - NOTLAR

- The above table shows the average value of conditions which may occur.
Die obige Tabelle zeigt den Durchschnittswert der Bedingungen, die auftreten können.
 Στον παραπάνω πίνακα αναγράφεται η μέση τιμή για συνθήκες που μπορεί να προκύψουν.
La tabla de arriba muestra el valor medio de condiciones que pueden ocurrir.
 Le tableau ci-dessus donne la valeur moyenne pour des conditions qui peuvent survenir.
La tabella in alto mostra il valore delle condizioni medie che si possono riscontrare.
 De tabel hierboven geeft de gemiddelde waarde aan van situaties die kunnen voorvallen.
Таблица расположенная выше показывает среднее значение условий, которые могут наступить.
 Yukarıdaki tablo meydana gelebilecek koşulların ortalama değerini göstermektedir.

3D079549

5 Таблицы производительности

5 - 1 Таблицы холодопроизводительности

5

RXYQ36T															
Indoor air temp. °CWB															
Combination(%) (Capacity index)	Outdoor air temp. (°CDB)	14.0		16.0		18.0		19.0		20.0		22.0		24.0	
		TC	PI	TC	PI	TC	PI	TC	PI	TC	PI	TC	PI	TC	PI
		KW	KW	KW	KW	KW	KW	KW	KW	KW	KW	KW	KW	KW	KW
90% 90.90 kW	10	55.9	9.49	69.9	11.7	83.9	14.1	90.9	15.3	97.9	16.5	112	19.1	126	21.7
	12	55.9	9.6	69.9	11.9	83.9	14.3	90.9	15.6	97.9	16.8	112	19.5	125	21.7
	14	55.9	9.8	69.9	12.1	83.9	14.5	90.9	15.8	97.9	17.1	112	19.8	123	21.6
	16	55.9	9.9	69.9	12.3	83.9	14.8	90.9	16.1	97.9	17.4	112	20.2	121	21.5
	18	55.9	10.1	69.9	12.5	83.9	15.1	90.9	16.4	97.9	17.8	112	20.8	120	22.6
	20	55.9	10.2	69.9	12.7	83.9	15.3	90.9	16.7	97.9	18.5	112	22.3	118	23.7
	21	55.9	10.3	69.9	12.8	83.9	15.6	90.9	17.3	97.9	19.1	112	23.1	117	24.2
	23	55.9	10.5	69.9	13.2	83.9	16.6	90.9	18.5	97.9	20.5	112	24.7	116	25.3
	25	55.9	10.9	69.9	14.1	83.9	17.7	90.9	19.7	97.9	21.9	111	26.2	114	26.4
	27	55.9	11.5	69.9	15.0	83.9	18.9	90.9	21.1	97.9	23.3	110	27.3	112	27.5
	29	55.9	12.2	69.9	15.9	83.9	20.2	90.9	22.5	97.9	24.9	108	28.4	111	28.6
	31	55.9	13.0	69.9	16.9	83.9	21.4	90.9	23.9	97.9	26.5	106	29.5	109	29.8
	33	55.9	13.7	69.9	18.0	83.9	22.8	90.9	25.5	97.9	28.3	105	30.6	107	30.9
	35	55.9	14.6	69.9	19.1	83.9	24.3	90.9	27.1	97.9	30.1	103	31.7	106	32.0
	37	55.9	15.4	69.9	20.2	83.9	25.8	90.9	28.8	97.9	32.0	101	32.9	104	33.2
	39	55.9	16.3	69.9	21.5	83.9	27.4	90.9	30.7	97.1	33.7	99.7	34.0	102	34.3
80% 80.80 kW	10	49.7	8.57	62.2	10.5	74.6	12.5	80.8	13.5	87.0	14.6	99.4	16.8	112	19.1
	12	49.7	8.69	62.2	10.6	74.6	12.7	80.8	13.8	87.0	14.9	99.4	17.1	112	19.5
	14	49.7	8.81	62.2	10.8	74.6	12.9	80.8	14.0	87.0	15.1	99.4	17.4	112	19.8
	16	49.7	8.94	62.2	11.0	74.6	13.1	80.8	14.2	87.0	15.4	99.4	17.7	112	20.2
	18	49.7	9.07	62.2	11.1	74.6	13.3	80.8	14.5	87.0	15.7	99.4	18.1	112	20.8
	20	49.7	9.21	62.2	11.3	74.6	13.6	80.8	14.8	87.0	16.0	99.4	18.9	112	22.3
	21	49.7	9.28	62.2	11.4	74.6	13.7	80.8	14.9	87.0	16.3	99.4	19.5	112	23.1
	23	49.7	9.43	62.2	11.6	74.6	14.3	80.8	15.8	87.0	17.4	99.4	20.9	112	24.7
	25	49.7	9.6	62.2	12.2	74.6	15.2	80.8	16.9	87.0	18.6	99.4	22.4	111	26.2
	27	49.7	10.2	62.2	13.0	74.6	16.2	80.8	18.0	87.0	19.9	99.4	23.9	110	27.3
	29	49.7	10.8	62.2	13.8	74.6	17.3	80.8	19.2	87.0	21.2	99.4	25.5	108	28.4
	31	49.7	11.4	62.2	14.7	74.6	18.4	80.8	20.4	87.0	22.5	99.4	27.1	106	29.5
	33	49.7	12.1	62.2	15.5	74.6	19.5	80.8	21.7	87.0	24.0	99.4	28.9	105	30.6
	35	49.7	12.8	62.2	16.5	74.6	20.7	80.8	23.0	87.0	25.5	99.4	30.8	103	31.7
	37	49.7	13.5	62.2	17.5	74.6	22.0	80.8	24.5	87.0	27.1	99.1	32.6	101	32.9
	39	49.7	14.2	62.2	18.5	74.6	23.4	80.8	26.0	87.0	28.8	97.4	33.7	99.7	34.0
70% 70.70 kW	10	43.5	7.69	54.4	9.26	65.3	10.9	70.7	11.8	76.1	12.7	87.0	14.6	97.9	16.5
	12	43.5	7.79	54.4	9.39	65.3	11.1	70.7	12.0	76.1	12.9	87.0	14.9	97.9	16.8
	14	43.5	7.89	54.4	9.53	65.3	11.3	70.7	12.2	76.1	13.2	87.0	15.1	97.9	17.1
	16	43.5	8.00	54.4	9.67	65.3	11.5	70.7	12.4	76.1	13.4	87.0	15.4	97.9	17.4
	18	43.5	8.11	54.4	9.82	65.3	11.7	70.7	12.6	76.1	13.6	87.0	15.7	97.9	17.8
	20	43.5	8.22	54.4	9.98	65.3	11.9	70.7	12.9	76.1	13.9	87.0	16.0	97.9	18.5
	21	43.5	8.28	54.4	10.1	65.3	12.0	70.7	13.0	76.1	14.0	87.0	16.3	97.9	19.1
	23	43.5	8.40	54.4	10.2	65.3	12.2	70.7	13.4	76.1	14.7	87.0	17.4	97.9	20.5
	25	43.5	8.53	54.4	10.5	65.3	13.0	70.7	14.3	76.1	15.6	87.0	18.6	97.9	21.9
	27	43.5	8.89	54.4	11.2	65.3	13.8	70.7	15.2	76.1	16.7	87.0	19.9	97.9	23.3
	29	43.5	9.41	54.4	11.9	65.3	14.6	70.7	16.2	76.1	17.7	87.0	21.2	97.9	24.9
	31	43.5	9.9	54.4	12.6	65.3	15.5	70.7	17.2	76.1	18.9	87.0	22.5	97.9	26.5
	33	43.5	10.5	54.4	13.3	65.3	16.5	70.7	18.2	76.1	20.0	87.0	24.0	97.9	28.3
	35	43.5	11.1	54.4	14.1	65.3	17.5	70.7	19.3	76.1	21.3	87.0	25.5	97.9	30.1
	37	43.5	11.7	54.4	14.9	65.3	18.5	70.7	20.5	76.1	22.6	87.0	27.1	97.9	32.0
	39	43.5	12.3	54.4	15.8	65.3	19.7	70.7	21.8	76.1	24.0	87.0	28.8	97.1	33.7
60% 60.60 kW	10	37.3	6.85	46.6	8.13	55.9	9.49	60.6	10.21	65.3	10.9	74.6	12.5	83.9	14.1
	12	37.3	6.93	46.6	8.23	55.9	9.63	60.6	10.36	65.3	11.1	74.6	12.7	83.9	14.3
	14	37.3	7.02	46.6	8.35	55.9	9.78	60.6	10.5	65.3	11.3	74.6	12.9	83.9	14.5
	16	37.3	7.10	46.6	8.46	55.9	9.92	60.6	10.7	65.3	11.5	74.6	13.1	83.9	14.8
	18	37.3	7.19	46.6	8.58	55.9	10.08	60.6	10.9	65.3	11.7	74.6	13.3	83.9	15.1
	20	37.3	7.28	46.6	8.71	55.9	10.24	60.6	11.0	65.3	11.9	74.6	13.6	83.9	15.3
	21	37.3	7.33	46.6	8.77	55.9	10.3	60.6	11.1	65.3	12.0	74.6	13.7	83.9	15.6
	23	37.3	7.43	46.6	8.91	55.9	10.5	60.6	11.3	65.3	12.2	74.6	14.3	83.9	16.6
	25	37.3	7.54	46.6	9.05	55.9	10.9	60.6	11.9	65.3	13.0	74.6	15.2	83.9	17.7
	27	37.3	7.71	46.6	9.52	55.9	11.5	60.6	12.6	65.3	13.8	74.6	16.2	83.9	18.9
	29	37.3	8.15	46.6	10.1	55.9	12.2	60.6	13.4	65.3	14.6	74.6	17.3	83.9	20.2
	31	37.3	8.60	46.6	10.7	55.9	13.0	60.6	14.2	65.3	15.5	74.6	18.4	83.9	21.4
	33	37.3	9.07	46.6	11.3	55.9	13.7	60.6	15.1	65.3	16.5	74.6	19.5	83.9	22.8
	35	37.3	9.56	46.6	11.9	55.9	14.6	60.6	16.0	65.3	17.5	74.6	20.7	83.9	24.3
	37	37.3	10.1	46.6	12.6	55.9	15.4	60.6	16.9	65.3	18.5	74.6	22.0	83.9	25.8
	39	37.3	10.6	46.6	13.3	55.9	16.3	60.6	17.9	65.3	19.7	74.6	23.4	83.9	27.4
50% 50.50 kW	10	31.1	6.06	38.8	7.06	46.6	8.13	50.5	8.68	54.4	9.26	62.2	10.45	69.9	11.7
	12	31.1	6.13	38.8	7.14	46.6	8.23	50.5	8.80	54.4	9.39	62.2	10.61	69.9	11.9
	14	31.1	6.19	38.8	7.23	46.6	8.35	50.5	8.93	54.4	9.53	62.2	10.8	69.9	12.1
	16	31.1	6.26	38.8	7.32	46.6	8.46	50.5	9.06	54.4	9.67	62.2	11.0	69.9	12.3
	18	31.1	6.33	38.8	7.42	46.6	8.58	50.5	9.19	54.4	9.82	62.2	11.1	69.9	12.5
	20	31.1	6.40	38.8	7.51	46.6	8.71	50.5	9.34	54.4	9.98	62.2	11.3	69.9	12.7
	21	31.1	6.44	38.8	7.57	46.6	8.77	50.5	9.41	54.4	10.06	62.2	11.4	69.9	12.8
	23	31.1	6.52	38.8	7.67	46.6	8.91	50.5	9.56	54.4	10.23	62.2	11.6	69.9	13.2
	25	31.1	6.60	38.8	7.78	46.6	9.05	50.5	9.74	54.4	10.54	62.2	12.2	69.9	14.1
	27	31.1	6.68	38.8	8.00	46.6	9.52	50.5	10.33	54.4	11.2	62.2	13.0	69.9	15.0
	29	31.1	6.99	38.8	8.45	46.6	10.08	50.5	10.9	54.4	11.9	62.2	13.8	69.9	15.9
	31	31.1	7.37	38.8	8.92	46.6	10.7	50.5	11.6	54.4	12.6	62.2	14.7	69.9	16.9
	33	31.1	7.75	38.8	9.42	46.6	11.3	50.5	12.3	54.4	13.3	62.2	15.5	69.9	18.0
	35	31.1	8.15	38.8	9.93	46.6	11.9	50.5	13.0	54.4	14.1	62.2	16.5	69.9	19.1
	37	31.1	8.57	38.8	10.5	46.6	12.6	50.5	13.7	54.4	14.9	62.2	17.5	69.9	20.2
	39	31.1	9.01	38.8	11.0	46.6	13.3	50.5	14.5	54.4	15.8	62.2	18.5	69.9	21.5

3D079549

5 Таблицы производительности

5 - 1 Таблицы холодопроизводительности

RXYQ38T															
Indoor air temp. °CWB															
Combination(%) (Capacity index)	Outdoor air temp. (°CDB)	14.0		16.0		18.0		19.0		20.0		22.0		24.0	
		TC	PI	TC	PI	TC	PI	TC	PI	TC	PI	TC	PI	TC	PI
		KW		KW		KW		KW		KW		KW		KW	
130% 138.32 kW	10	85.1	13.3	106	16.8	128	20.5	134	21.2	136	20.7	140	19.7	144	18.6
	12	85.1	13.5	106	17.1	128	20.9	132	21.1	134	20.6	138	19.5	142	19.6
	14	85.1	13.7	106	17.4	128	21.3	131	21.0	133	20.5	137	20.4	141	20.7
	16	85.1	14.0	106	17.7	127	21.4	129	21.2	131	21.3	135	21.5	139	21.8
	18	85.1	14.2	106	18.1	125	22.1	127	22.3	129	22.4	133	22.7	137	22.9
	20	85.1	14.5	106	19.0	123	23.2	125	23.4	127	23.5	131	23.8	135	24.0
	21	85.1	14.6	106	19.6	122	23.8	124	23.9	126	24.0	130	24.3	134	24.6
	23	85.1	15.5	106	21.0	121	24.8	123	25.0	125	25.1	129	25.4	133	25.7
	25	85.1	16.6	106	22.5	119	25.9	121	26.1	123	26.2	127	26.6	131	26.9
	27	85.1	17.7	106	24.0	117	27.0	119	27.2	121	27.4	125	27.7	129	28.0
	29	85.1	18.8	106	25.6	116	28.1	118	28.3	120	28.5	124	28.8	128	29.2
	31	85.1	20.0	106	27.3	114	29.2	116	29.4	118	29.6	122	30.0	126	30.3
	33	85.1	21.3	106	29.1	112	30.3	114	30.5	116	30.7	120	31.1	124	31.5
	35	85.1	22.6	106	31.0	110	31.4	112	31.6	114	31.9	118	32.3	122	32.7
37	85.1	24.1	105	32.1	109	32.5	111	32.8	113	33.0	117	33.4	121	33.9	
39	85.1	25.6	103	33.2	107	33.7	109	33.9	111	34.1	115	34.6	119	35.1	
120% 127.68 kW	10	78.6	12.2	98	15.4	118	18.8	128	20.5	134	21.3	138	20.3	141	19.3
	12	78.6	12.4	98	15.7	118	19.1	128	20.9	132	21.2	136	20.2	139	19.4
	14	78.6	12.6	98	16.0	118	19.5	128	21.3	130	21.0	134	20.3	138	20.5
	16	78.6	12.8	98	16.3	118	19.8	127	21.4	129	21.2	132	21.4	136	21.6
	18	78.6	13.1	98	16.6	118	20.4	125	22.1	127	22.3	131	22.5	134	22.7
	20	78.6	13.3	98	17.0	118	21.9	123	23.2	125	23.3	129	23.6	133	23.9
	21	78.6	13.4	98	17.6	118	22.7	122	23.8	124	23.9	128	24.2	132	24.4
	23	78.6	14.0	98	18.8	118	24.3	121	24.8	123	25.0	126	25.3	130	25.5
	25	78.6	15.0	98	20.1	117	25.8	119	25.9	121	26.1	125	26.4	128	26.7
	27	78.6	15.9	98	21.4	115	26.9	117	27.0	119	27.2	123	27.5	126	27.8
	29	78.6	17.0	98	22.9	114	28.0	116	28.1	117	28.3	121	28.6	125	28.9
	31	78.6	18.0	98	24.4	112	29.0	114	29.2	116	29.4	119	29.7	123	30.1
	33	78.6	19.2	98	26.0	110	30.1	112	30.3	114	30.5	118	30.9	121	31.2
	35	78.6	20.4	98	27.6	109	31.2	110	31.4	112	31.6	116	32.0	120	32.4
37	78.6	21.6	98	29.4	107	32.3	109	32.5	110	32.7	114	33.2	118	33.6	
39	78.6	22.9	98	31.3	105	33.4	107	33.7	109	33.9	112	34.3	116	34.7	
110% 117.04 kW	10	72.0	11.2	90.0	14.1	108	17.1	117	18.7	126	20.2	135	21.0	138	20.1
	12	72.0	11.4	90.0	14.3	108	17.4	117	19.0	126	20.6	133	20.8	137	19.9
	14	72.0	11.6	90.0	14.6	108	17.7	117	19.3	126	21.0	132	20.7	135	20.4
	16	72.0	11.8	90.0	14.8	108	18.0	117	19.7	126	21.4	130	21.3	133	21.5
	18	72.0	12.0	90.0	15.1	108	18.4	117	20.2	125	22.1	128	22.3	132	22.6
	20	72.0	12.2	90.0	15.4	108	19.4	117	21.7	123	23.2	126	23.4	130	23.7
	21	72.0	12.3	90.0	15.6	108	20.1	117	22.5	122	23.7	126	24.0	129	24.2
	23	72.0	12.6	90.0	16.7	108	21.5	117	24.1	120	24.8	124	25.1	127	25.3
	25	72.0	13.4	90.0	17.9	108	23.0	117	25.8	119	25.9	122	26.2	125	26.4
	27	72.0	14.3	90.0	19.0	108	24.5	115	26.9	117	27.0	120	27.3	124	27.6
	29	72.0	15.2	90.0	20.3	108	26.2	114	27.9	115	28.1	119	28.4	122	28.7
	31	72.0	16.1	90.0	21.6	108	27.9	112	29.0	114	29.2	117	29.5	120	29.8
	33	72.0	17.1	90.0	23.0	108	29.8	110	30.1	112	30.3	115	30.6	119	31.0
	35	72.0	18.2	90.0	24.5	107	31.0	108	31.2	110	31.4	113	31.8	117	32.1
37	72.0	19.3	90.0	26.0	105	32.1	107	32.3	108	32.5	112	32.9	115	33.3	
39	72.0	20.5	90.0	27.6	103	33.2	105	33.4	107	33.6	110	34.0	113	34.4	
100% 106.4 kW	10	65.5	10.2	81.8	12.7	98	15.4	106	16.8	115	18.2	131	21.1	136	20.8
	12	65.5	10.4	81.8	13.0	98	15.7	106	17.1	115	18.6	131	21.5	134	20.7
	14	65.5	10.5	81.8	13.2	98	16.0	106	17.4	115	18.9	129	21.4	132	20.6
	16	65.5	10.7	81.8	13.4	98	16.3	106	17.7	115	19.2	127	21.3	131	21.3
	18	65.5	10.9	81.8	13.6	98	16.6	106	18.1	115	19.6	126	22.2	129	22.4
	20	65.5	11.1	81.8	13.9	98	17.0	106	19.0	115	21.1	124	23.3	127	23.5
	21	65.5	11.2	81.8	14.0	98	17.6	106	19.6	115	21.8	123	23.8	126	24.0
	23	65.5	11.4	81.8	14.8	98	18.8	106	21.0	115	23.4	121	24.9	124	25.1
	25	65.5	12.0	81.8	15.8	98	20.1	106	22.5	115	25.0	120	26.0	123	26.2
	27	65.5	12.7	81.8	16.8	98	21.4	106	24.0	115	26.7	118	27.1	121	27.3
	29	65.5	13.5	81.8	17.9	98	22.9	106	25.6	113	27.9	116	28.2	119	28.4
	31	65.5	14.4	81.8	19.0	98	24.4	106	27.3	111	29.0	114	29.3	118	29.6
	33	65.5	15.2	81.8	20.2	98	26.0	106	29.1	110	30.1	113	30.4	116	30.7
	35	65.5	16.2	81.8	21.5	98	27.6	106	31.0	108	31.2	111	31.5	114	31.8
37	65.5	17.1	81.8	22.8	98	29.4	106	32.1	106	32.3	109	32.6	112	33.0	
39	65.5	18.1	81.8	24.2	98	31.3	103	33.2	104	33.4	108	33.7	111	34.1	

NOTES - ANMERKUNGEN - Σημειώσεις - NOTAS - REMARQUES - NOTE - OPMERKINGEN - примечания - NOTLAR

- The above table shows the average value of conditions which may occur.
Die obige Tabelle zeigt den Durchschnittswert der Bedingungen, die auftreten können.
 Στον παραπάνω πίνακα αναγράφεται η μέση τιμή για συνθήκες που μπορεί να προκύψουν.
La tabla de arriba muestra el valor medio de condiciones que pueden ocurrir.
 Le tableau ci-dessus donne la valeur moyenne pour des conditions qui peuvent survenir.
La tabella in alto mostra il valore delle condizioni medie che si possono riscontrare.
 De tabel hierboven geeft de gemiddelde waarde aan van situaties die kunnen voorvallen.
Таблица расположенная выше показывает среднее значение условий, которые могут наступить.
 Yukarıdaki tablo meydana gelebilecek koşulların ortalama değerini göstermektedir.

3D079549

5 Таблицы производительности

5 - 1 Таблицы холодопроизводительности

RXYQ38T

Indoor air temp. °CWB

Combination(%) (Capacity index)	Outdoor air temp. (°CDB)	14.0		16.0		18.0		19.0		20.0		22.0		24.0	
		TC	PI	TC	PI	TC	PI	TC	PI	TC	PI	TC	PI	TC	PI
		KW	KW	KW	KW	KW	KW	KW	KW	KW	KW	KW	KW	KW	KW
90% 95.76 kW	10	58.9	9.3	73.7	11.5	88.4	13.8	95.8	15.0	103	16.3	118	18.8	133	21.4
	12	58.9	9.4	73.7	11.6	88.4	14.0	95.8	15.3	103	16.5	118	19.1	131	21.4
	14	58.9	9.6	73.7	11.8	88.4	14.3	95.8	15.5	103	16.8	118	19.5	129	21.3
	16	58.9	9.7	73.7	12.0	88.4	14.5	95.8	15.8	103	17.1	118	19.8	128	21.2
	18	58.9	9.9	73.7	12.2	88.4	14.8	95.8	16.1	103	17.5	118	20.4	126	22.2
	20	58.9	10.0	73.7	12.5	88.4	15.1	95.8	16.4	103	18.2	118	21.9	124	23.3
	21	58.9	10.1	73.7	12.6	88.4	15.3	95.8	17.0	103	18.8	118	22.7	123	23.8
	23	58.9	10.3	73.7	12.9	88.4	16.3	95.8	18.2	103	20.1	118	24.3	122	24.9
	25	58.9	10.6	73.7	13.8	88.4	17.4	95.8	19.4	103	21.5	117	25.8	120	26.0
	27	58.9	11.3	73.7	14.7	88.4	18.6	95.8	20.7	103	23.0	115	26.9	118	27.1
	29	58.9	12.0	73.7	15.6	88.4	19.8	95.8	22.1	103	24.5	114	28.0	116	28.2
	31	58.9	12.7	73.7	16.6	88.4	21.1	95.8	23.5	103	26.1	112	29.0	115	29.3
	33	58.9	13.5	73.7	17.6	88.4	22.4	95.8	25.0	103	27.8	110	30.1	113	30.4
	35	58.9	14.2	73.7	18.7	88.4	23.8	95.8	26.7	103	29.6	109	31.2	111	31.5
37	58.9	15.1	73.7	19.9	88.4	25.3	95.8	28.4	103	31.5	107	32.3	110	32.6	
39	58.9	16.0	73.7	21.1	88.4	26.9	95.8	30.2	102	33.1	105	33.4	108	33.8	
80% 85.12 kW	10	52.4	8.36	65.5	10.2	78.6	12.2	85.1	13.3	91.7	14.3	105	16.5	118	18.8
	12	52.4	8.48	65.5	10.4	78.6	12.4	85.1	13.5	91.7	14.6	105	16.8	118	19.1
	14	52.4	8.60	65.5	10.5	78.6	12.6	85.1	13.7	91.7	14.8	105	17.1	118	19.5
	16	52.4	8.72	65.5	10.7	78.6	12.8	85.1	14.0	91.7	15.1	105	17.4	118	19.8
	18	52.4	8.85	65.5	10.9	78.6	13.1	85.1	14.2	91.7	15.4	105	17.8	118	20.4
	20	52.4	8.99	65.5	11.1	78.6	13.3	85.1	14.5	91.7	15.7	105	18.6	118	21.9
	21	52.4	9.06	65.5	11.2	78.6	13.4	85.1	14.6	91.7	16.0	105	19.2	118	22.7
	23	52.4	9.2	65.5	11.4	78.6	14.0	85.1	15.5	91.7	17.1	105	20.6	118	24.3
	25	52.4	9.4	65.5	12.0	78.6	15.0	85.1	16.6	91.7	18.3	105	22.0	117	25.8
	27	52.4	9.9	65.5	12.7	78.6	15.9	85.1	17.7	91.7	19.5	105	23.5	115	26.9
	29	52.4	10.5	65.5	13.5	78.6	17.0	85.1	18.8	91.7	20.8	105	25.1	114	28.0
	31	52.4	11.1	65.5	14.4	78.6	18.0	85.1	20.0	91.7	22.1	105	26.7	112	29.0
	33	52.4	11.8	65.5	15.2	78.6	19.2	85.1	21.3	91.7	23.6	105	28.5	110	30.1
	35	52.4	12.5	65.5	16.2	78.6	20.4	85.1	22.6	91.7	25.1	105	30.3	109	31.2
37	52.4	13.2	65.5	17.1	78.6	21.6	85.1	24.1	91.7	26.7	104	32.1	107	32.3	
39	52.4	13.9	65.5	18.1	78.6	22.9	85.1	25.6	91.7	28.3	103	33.2	105	33.4	
70% 74.48 kW	10	45.8	7.49	57.3	9.04	68.8	10.7	74.5	11.6	80.2	12.5	91.7	14.3	103.1	16.3
	12	45.8	7.59	57.3	9.17	68.8	10.9	74.5	11.8	80.2	12.7	91.7	14.6	103.1	16.5
	14	45.8	7.69	57.3	9.31	68.8	11.1	74.5	12.0	80.2	12.9	91.7	14.8	103.1	16.8
	16	45.8	7.79	57.3	9.45	68.8	11.2	74.5	12.2	80.2	13.1	91.7	15.1	103.1	17.1
	18	45.8	7.90	57.3	9.6	68.8	11.4	74.5	12.4	80.2	13.4	91.7	15.4	103.1	17.5
	20	45.8	8.01	57.3	9.8	68.8	11.6	74.5	12.6	80.2	13.6	91.7	15.7	103.1	18.2
	21	45.8	8.07	57.3	9.8	68.8	11.7	74.5	12.7	80.2	13.7	91.7	16.0	103.1	18.8
	23	45.8	8.19	57.3	10.0	68.8	11.9	74.5	13.1	80.2	14.4	91.7	17.1	103.1	20.1
	25	45.8	8.32	57.3	10.3	68.8	12.7	74.5	14.0	80.2	15.4	91.7	18.3	103.1	21.5
	27	45.8	8.67	57.3	10.9	68.8	13.5	74.5	14.9	80.2	16.4	91.7	19.5	103.1	23.0
	29	45.8	9.2	57.3	11.6	68.8	14.3	74.5	15.8	80.2	17.4	91.7	20.8	103.1	24.5
	31	45.8	9.7	57.3	12.3	68.8	15.2	74.5	16.8	80.2	18.5	91.7	22.1	103.1	26.1
	33	45.8	10.3	57.3	13.0	68.8	16.2	74.5	17.9	80.2	19.7	91.7	23.6	103.1	27.8
	35	45.8	10.8	57.3	13.8	68.8	17.2	74.5	19.0	80.2	20.9	91.7	25.1	103.1	29.6
37	45.8	11.4	57.3	14.6	68.8	18.2	74.5	20.1	80.2	22.2	91.7	26.7	103.1	31.5	
39	45.8	12.1	57.3	15.4	68.8	19.3	74.5	21.4	80.2	23.6	91.7	28.3	102.3	33.1	
60% 63.84 kW	10	39.3	6.66	49.1	7.92	58.9	9.27	63.8	10.0	68.8	10.7	78.6	12.2	88.4	13.8
	12	39.3	6.74	49.1	8.03	58.9	9.41	63.8	10.1	68.8	10.9	78.6	12.4	88.4	14.0
	14	39.3	6.82	49.1	8.14	58.9	9.55	63.8	10.3	68.8	11.1	78.6	12.6	88.4	14.3
	16	39.3	6.91	49.1	8.25	58.9	9.70	63.8	10.5	68.8	11.2	78.6	12.8	88.4	14.5
	18	39.3	7.00	49.1	8.37	58.9	9.9	63.8	10.6	68.8	11.4	78.6	13.1	88.4	14.8
	20	39.3	7.09	49.1	8.50	58.9	10.0	63.8	10.8	68.8	11.6	78.6	13.3	88.4	15.1
	21	39.3	7.13	49.1	8.56	58.9	10.1	63.8	10.9	68.8	11.7	78.6	13.4	88.4	15.3
	23	39.3	7.23	49.1	8.69	58.9	10.3	63.8	11.1	68.8	11.9	78.6	14.0	88.4	16.3
	25	39.3	7.34	49.1	8.83	58.9	10.6	63.8	11.6	68.8	12.7	78.6	15.0	88.4	17.4
	27	39.3	7.51	49.1	9.29	58.9	11.3	63.8	12.4	68.8	13.5	78.6	15.9	88.4	18.6
	29	39.3	7.93	49.1	9.8	58.9	12.0	63.8	13.1	68.8	14.3	78.6	17.0	88.4	19.8
	31	39.3	8.38	49.1	10.4	58.9	12.7	63.8	13.9	68.8	15.2	78.6	18.0	88.4	21.1
	33	39.3	8.83	49.1	11.0	58.9	13.5	63.8	14.8	68.8	16.2	78.6	19.2	88.4	22.4
	35	39.3	9.3	49.1	11.6	58.9	14.2	63.8	15.7	68.8	17.2	78.6	20.4	88.4	23.8
37	39.3	9.8	49.1	12.3	58.9	15.1	63.8	16.6	68.8	18.2	78.6	21.6	88.4	25.3	
39	39.3	10.3	49.1	13.0	58.9	16.0	63.8	17.6	68.8	19.3	78.6	22.9	88.4	26.9	
50% 53.20 kW	10	32.7	5.88	40.9	6.86	49.1	7.92	53.2	8.47	57.3	9.04	65.5	10.2	73.7	11.5
	12	32.7	5.94	40.9	6.95	49.1	8.03	53.2	8.59	57.3	9.17	65.5	10.4	73.7	11.6
	14	32.7	6.01	40.9	7.03	49.1	8.14	53.2	8.71	57.3	9.31	65.5	10.5	73.7	11.8
	16	32.7	6.07	40.9	7.12	49.1	8.25	53.2	8.84	57.3	9.45	65.5	10.7	73.7	12.0
	18	32.7	6.14	40.9	7.22	49.1	8.37	53.2	8.98	57.3	9.60	65.5	10.9	73.7	12.2
	20	32.7	6.21	40.9	7.31	49.1	8.50	53.2	9.12	57.3	9.75	65.5	11.1	73.7	12.5
	21	32.7	6.25	40.9	7.36	49.1	8.56	53.2	9.19	57.3	9.83	65.5	11.2	73.7	12.6
	23	32.7	6.33	40.9	7.47	49.1	8.69	53.2	9.34	57.3	10.0	65.5	11.4	73.7	12.9
	25	32.7	6.41	40.9	7.58	49.1	8.83	53.2	9.51	57.3	10.3	65.5	12.0	73.7	13.8
	27	32.7	6.49	40.9	7.79	49.1	9.29	53.2	10.1	57.3	10.9	65.5	12.7	73.7	14.7
	29	32.7	6.79	40.9	8.23	49.1	9.8	53.2	10.7	57.3	11.6	65.5	13.5	73.7	15.6
	31	32.7	7.16	40.9	8.70	49.1	10.4	53.2	11.3	57.3	12.3	65.5	14.4	73.7	16.6
	33	32.7	7.54	40.9	9.18	49.1	11.0	53.2	12.0	57.3	13.0	65.5	15.2	73.7	17.6
	35	32.7	7.93	40.9	9.7	49.1	11.6	53.2	12.7	57.3	13.8	65.5	16.2	73.7	18.7
37	32.7	8.34	40.9	10.2	49.1	12.3	53.2	13.4	57.3	14.6	65.5	17.1	73.7	19.9	
39	32.7	8.76	40.9	10.8	49.1	13.0	53.2	14.2	57.3	15.4	65.5	18.1	73.7	21.1	

3D079549

5 Таблицы производительности

5 - 1 Таблицы холодопроизводительности

RXYQ40T															
Indoor air temp. °CWB															
Combination(%) (Capacity index)	Outdoor air temp. (°CDB)	14.0		16.0		18.0		19.0		20.0		22.0		24.0	
		TC	PI	TC	PI	TC	PI	TC	PI	TC	PI	TC	PI	TC	PI
		KW		KW		KW		KW		KW		KW		KW	
130% 144.95 kW	10	89.2	13.2	112	16.8	134	20.5	140	21.2	143	20.7	147	19.7	151	18.6
	12	89.2	13.5	112	17.1	134	20.9	139	21.1	141	20.6	145	19.5	149	19.5
	14	89.2	13.7	112	17.4	134	21.3	137	21.0	139	20.5	143	20.4	147	20.7
	16	89.2	13.9	112	17.7	133	21.4	135	21.2	137	21.3	141	21.5	145	21.8
	18	89.2	14.2	112	18.1	131	22.1	133	22.3	135	22.4	139	22.6	144	22.9
	20	89.2	14.5	112	18.9	129	23.2	131	23.3	133	23.5	138	23.8	142	24.0
	21	89.2	14.6	112	19.6	128	23.7	130	23.9	133	24.0	137	24.3	141	24.6
	23	89.2	15.5	112	21.0	127	24.8	129	25.0	131	25.1	135	25.4	139	25.7
	25	89.2	16.6	112	22.5	125	25.9	127	26.1	129	26.2	133	26.5	137	26.9
	27	89.2	17.7	112	24.0	123	27.0	125	27.2	127	27.3	131	27.7	135	28.0
	29	89.2	18.8	112	25.6	121	28.1	123	28.3	125	28.5	129	28.8	134	29.2
	31	89.2	20.0	112	27.3	119	29.2	121	29.4	123	29.6	128	30.0	132	30.3
	33	89.2	21.3	112	29.1	117	30.3	120	30.5	122	30.7	126	31.1	130	31.5
	35	89.2	22.6	112	31.0	116	31.4	118	31.6	120	31.8	124	32.2	128	32.7
	37	89.2	24.0	110	32.1	114	32.5	116	32.7	118	33.0	122	33.4	126	33.9
	39	89.2	25.5	108	33.2	112	33.6	114	33.9	116	34.1	120	34.6	125	35.0
120% 133.80 kW	10	82.3	12.2	103	15.4	124	18.8	134	20.5	140	21.2	144	20.3	148	19.3
	12	82.3	12.4	103	15.7	124	19.1	134	20.9	138	21.1	142	20.2	146	19.4
	14	82.3	12.6	103	16.0	124	19.5	134	21.3	137	21.0	140	20.3	144	20.5
	16	82.3	12.8	103	16.2	124	19.8	133	21.4	135	21.2	139	21.4	143	21.6
	18	82.3	13.1	103	16.6	124	20.4	131	22.1	133	22.2	137	22.5	141	22.7
	20	82.3	13.3	103	17.0	124	21.9	129	23.2	131	23.3	135	23.6	139	23.8
	21	82.3	13.4	103	17.6	124	22.7	128	23.7	130	23.9	134	24.1	138	24.4
	23	82.3	14.0	103	18.8	124	24.3	127	24.8	128	25.0	132	25.2	136	25.5
	25	82.3	14.9	103	20.1	123	25.8	125	25.9	127	26.1	131	26.4	134	26.6
	27	82.3	15.9	103	21.4	121	26.8	123	27.0	125	27.2	129	27.5	133	27.8
	29	82.3	16.9	103	22.9	119	27.9	121	28.1	123	28.3	127	28.6	131	28.9
	31	82.3	18.0	103	24.4	117	29.0	119	29.2	121	29.4	125	29.7	129	30.1
	33	82.3	19.1	103	25.9	116	30.1	117	30.3	119	30.5	123	30.9	127	31.2
	35	82.3	20.3	103	27.6	114	31.2	116	31.4	118	31.6	121	32.0	125	32.4
	37	82.3	21.6	103	29.4	112	32.3	114	32.5	116	32.7	120	33.1	123	33.5
	39	82.3	22.9	103	31.3	110	33.4	112	33.6	114	33.9	118	34.3	122	34.7
110% 122.65 kW	10	75.5	11.2	94	14.0	113	17.1	123	18.6	132	20.2	142	20.9	145	20.1
	12	75.5	11.4	94	14.3	113	17.4	123	19.0	132	20.6	140	20.8	143	19.9
	14	75.5	11.6	94	14.5	113	17.7	123	19.3	132	21.0	138	20.7	141	20.3
	16	75.5	11.7	94	14.8	113	18.0	123	19.7	132	21.4	136	21.2	140	21.4
	18	75.5	12.0	94	15.1	113	18.4	123	20.2	131	22.1	134	22.3	138	22.5
	20	75.5	12.2	94	15.4	113	19.4	123	21.7	129	23.2	132	23.4	136	23.6
	21	75.5	12.3	94	15.6	113	20.0	123	22.5	128	23.7	132	24.0	135	24.2
	23	75.5	12.6	94	16.7	113	21.5	123	24.1	126	24.8	130	25.1	133	25.3
	25	75.5	13.4	94	17.8	113	22.9	123	25.8	124	25.9	128	26.2	131	26.4
	27	75.5	14.3	94	19.0	113	24.5	121	26.8	123	27.0	126	27.3	130	27.5
	29	75.5	15.2	94	20.3	113	26.2	119	27.9	121	28.1	124	28.4	128	28.7
	31	75.5	16.1	94	21.6	113	27.9	117	29.0	119	29.2	123	29.5	126	29.8
	33	75.5	17.1	94	23.0	113	29.7	115	30.1	117	30.3	121	30.6	124	30.9
	35	75.5	18.2	94	24.4	112	31.0	114	31.2	115	31.4	119	31.7	122	32.1
	37	75.5	19.3	94	26.0	110	32.1	112	32.3	114	32.5	117	32.9	121	33.2
	39	75.5	20.4	94	27.6	108	33.2	110	33.4	112	33.6	115	34.0	119	34.4
100% 111.50 kW	10	68.6	10.2	85.8	12.7	103	15.4	112	16.8	120	18.2	137	21.1	142	20.8
	12	68.6	10.4	85.8	12.9	103	15.7	112	17.1	120	18.5	137	21.5	140	20.7
	14	68.6	10.5	85.8	13.2	103	16.0	112	17.4	120	18.9	135	21.4	139	20.5
	16	68.6	10.7	85.8	13.4	103	16.2	112	17.7	120	19.2	134	21.2	137	21.3
	18	68.6	10.9	85.8	13.6	103	16.6	112	18.1	120	19.6	132	22.2	135	22.4
	20	68.6	11.1	85.8	13.9	103	17.0	112	18.9	120	21.0	130	23.2	133	23.5
	21	68.6	11.2	85.8	14.0	103	17.6	112	19.6	120	21.8	129	23.8	132	24.0
	23	68.6	11.4	85.8	14.8	103	18.8	112	21.0	120	23.3	127	24.9	130	25.1
	25	68.6	12.0	85.8	15.7	103	20.1	112	22.5	120	25.0	125	26.0	129	26.2
	27	68.6	12.7	85.8	16.8	103	21.4	112	24.0	120	26.7	124	27.1	127	27.3
	29	68.6	13.5	85.8	17.9	103	22.9	112	25.6	119	27.9	122	28.2	125	28.4
	31	68.6	14.3	85.8	19.0	103	24.4	112	27.3	117	29.0	120	29.3	123	29.5
	33	68.6	15.2	85.8	20.2	103	25.9	112	29.1	115	30.1	118	30.4	121	30.7
	35	68.6	16.1	85.8	21.5	103	27.6	112	31.0	113	31.1	116	31.5	120	31.8
	37	68.6	17.1	85.8	22.8	103	29.4	110	32.1	111	32.2	115	32.6	118	32.9
	39	68.6	18.1	85.8	24.2	103	31.3	108	33.2	109	33.4	113	33.7	116	34.1

NOTES - ANMERKUNGEN - Σημειώσεις - NOTAS - REMARQUES - NOTE - OPMERKINGEN - примечания - NOTLAR

- The above table shows the average value of conditions which may occur.
Die obige Tabelle zeigt den Durchschnittswert der Bedingungen, die auftreten können.
 Στον παραπάνω πίνακα αναγράφεται η μέση τιμή για συνθήκες που μπορεί να προκύψουν.
La tabla de arriba muestra el valor medio de condiciones que pueden ocurrir.
 Le tableau ci-dessus donne la valeur moyenne pour des conditions qui peuvent survenir.
La tabella in alto mostra il valore delle condizioni medie che si possono riscontrare.
 De tabel hierboven geeft de gemiddelde waarde aan van situaties die kunnen voorvallen.
Таблица расположенная выше показывает среднее значение условий, которые могут наступить.
 Yukarıdaki tablo meydana gelebilecek koşulların ortalama değerini göstermektedir.

3D079549

5 Таблицы производительности

5 - 1 Таблицы холодопроизводительности

5

RXYQ40T															
Indoor air temp. °CWB															
Combination(%) (Capacity index)	Outdoor air temp. (°CDB)	14.0		16.0		18.0		19.0		20.0		22.0		24.0	
		TC	PI	TC	PI	TC	PI	TC	PI	TC	PI	TC	PI	TC	PI
		KW	KW	KW	KW	KW	KW	KW	KW	KW	KW	KW	KW	KW	KW
90% 100.35 kW	10	61.8	9.3	77.2	11.4	92.6	13.8	100	15.0	108	16.2	124	18.8	139	21.4
	12	61.8	9.4	77.2	11.6	92.6	14.0	100	15.3	108	16.5	124	19.1	137	21.4
	14	61.8	9.5	77.2	11.8	92.6	14.3	100	15.5	108	16.8	124	19.5	136	21.3
	16	61.8	9.7	77.2	12.0	92.6	14.5	100	15.8	108	17.1	124	19.8	134	21.2
	18	61.8	9.8	77.2	12.2	92.6	14.8	100	16.1	108	17.5	124	20.4	132	22.2
	20	61.8	10.0	77.2	12.4	92.6	15.1	100	16.4	108	18.1	124	21.9	130	23.3
	21	61.8	10.1	77.2	12.6	92.6	15.3	100	17.0	108	18.8	124	22.7	129	23.8
	23	61.8	10.2	77.2	12.9	92.6	16.3	100	18.1	108	20.1	124	24.3	128	24.9
	25	61.8	10.6	77.2	13.8	92.6	17.4	100	19.4	108	21.5	123	25.8	126	26.0
	27	61.8	11.3	77.2	14.7	92.6	18.6	100	20.7	108	22.9	121	26.8	124	27.1
	29	61.8	12.0	77.2	15.6	92.6	19.8	100	22.1	108	24.5	119	27.9	122	28.2
	31	61.8	12.7	77.2	16.6	92.6	21.1	100	23.5	108	26.1	117	29.0	120	29.3
	33	61.8	13.4	77.2	17.6	92.6	22.4	100	25.0	108	27.8	116	30.1	118	30.4
	35	61.8	14.2	77.2	18.7	92.6	23.8	100	26.6	108	29.6	114	31.2	117	31.5
	37	61.8	15.1	77.2	19.8	92.6	25.3	100	28.3	108	31.5	112	32.3	115	32.6
	39	61.8	15.9	77.2	21.0	92.6	26.9	100	30.1	107	33.1	110	33.4	113	33.8
80% 89.20 kW	10	54.9	8.3	68.6	10.2	82.3	12.2	89.2	13.2	96.1	14.3	110	16.5	124	18.8
	12	54.9	8.5	68.6	10.4	82.3	12.4	89.2	13.5	96.1	14.6	110	16.8	124	19.1
	14	54.9	8.6	68.6	10.5	82.3	12.6	89.2	13.7	96.1	14.8	110	17.1	124	19.5
	16	54.9	8.7	68.6	10.7	82.3	12.8	89.2	13.9	96.1	15.1	110	17.4	124	19.8
	18	54.9	8.8	68.6	10.9	82.3	13.1	89.2	14.2	96.1	15.4	110	17.8	124	20.4
	20	54.9	9.0	68.6	11.1	82.3	13.3	89.2	14.5	96.1	15.7	110	18.5	124	21.9
	21	54.9	9.0	68.6	11.2	82.3	13.4	89.2	14.6	96.1	16.0	110	19.2	124	22.7
	23	54.9	9.2	68.6	11.4	82.3	14.0	89.2	15.5	96.1	17.1	110	20.5	124	24.3
	25	54.9	9.3	68.6	12.0	82.3	14.9	89.2	16.6	96.1	18.3	110	22.0	123	25.8
	27	54.9	9.9	68.6	12.7	82.3	15.9	89.2	17.7	96.1	19.5	110	23.5	121	26.8
	29	54.9	10.5	68.6	13.5	82.3	16.9	89.2	18.8	96.1	20.8	110	25.0	119	27.9
	31	54.9	11.1	68.6	14.3	82.3	18.0	89.2	20.0	96.1	22.1	110	26.7	117	29.0
	33	54.9	11.8	68.6	15.2	82.3	19.1	89.2	21.3	96.1	23.6	110	28.4	116	30.1
	35	54.9	12.5	68.6	16.1	82.3	20.3	89.2	22.6	96.1	25.1	110	30.3	114	31.2
	37	54.9	13.2	68.6	17.1	82.3	21.6	89.2	24.0	96.1	26.6	109	32.0	112	32.3
	39	54.9	13.9	68.6	18.1	82.3	22.9	89.2	25.5	96.1	28.3	108	33.1	110	33.4
70% 78.05 kW	10	48.0	7.47	60.0	9.0	72.0	10.7	78.1	11.6	84.1	12.5	96.1	14.3	108	16.2
	12	48.0	7.57	60.0	9.2	72.0	10.9	78.1	11.8	84.1	12.7	96.1	14.6	108	16.5
	14	48.0	7.67	60.0	9.3	72.0	11.0	78.1	11.9	84.1	12.9	96.1	14.8	108	16.8
	16	48.0	7.78	60.0	9.4	72.0	11.2	78.1	12.2	84.1	13.1	96.1	15.1	108	17.1
	18	48.0	7.88	60.0	9.6	72.0	11.4	78.1	12.4	84.1	13.3	96.1	15.4	108	17.5
	20	48.0	8.00	60.0	9.7	72.0	11.6	78.1	12.6	84.1	13.6	96.1	15.7	108	18.1
	21	48.0	8.06	60.0	9.8	72.0	11.7	78.1	12.7	84.1	13.7	96.1	16.0	108	18.8
	23	48.0	8.2	60.0	10.0	72.0	11.9	78.1	13.1	84.1	14.4	96.1	17.1	108	20.1
	25	48.0	8.3	60.0	10.3	72.0	12.7	78.1	14.0	84.1	15.3	96.1	18.3	108	21.5
	27	48.0	8.7	60.0	10.9	72.0	13.5	78.1	14.9	84.1	16.3	96.1	19.5	108	22.9
	29	48.0	9.2	60.0	11.6	72.0	14.3	78.1	15.8	84.1	17.4	96.1	20.8	108	24.5
	31	48.0	9.7	60.0	12.3	72.0	15.2	78.1	16.8	84.1	18.5	96.1	22.1	108	26.1
	33	48.0	10.2	60.0	13.0	72.0	16.2	78.1	17.9	84.1	19.7	96.1	23.6	108	27.8
	35	48.0	10.8	60.0	13.8	72.0	17.1	78.1	19.0	84.1	20.9	96.1	25.1	108	29.6
	37	48.0	11.4	60.0	14.6	72.0	18.2	78.1	20.1	84.1	22.2	96.1	26.6	108	31.5
	39	48.0	12.0	60.0	15.4	72.0	19.3	78.1	21.3	84.1	23.6	96.1	28.3	107	33.1
60% 66.90 kW	10	41.2	6.65	51.5	7.90	61.8	9.3	66.9	10.0	72.0	10.7	82.3	12.2	92.6	13.8
	12	41.2	6.72	51.5	8.01	61.8	9.4	66.9	10.1	72.0	10.9	82.3	12.4	92.6	14.0
	14	41.2	6.81	51.5	8.12	61.8	9.5	66.9	10.3	72.0	11.0	82.3	12.6	92.6	14.3
	16	41.2	6.89	51.5	8.24	61.8	9.7	66.9	10.4	72.0	11.2	82.3	12.8	92.6	14.5
	18	41.2	6.98	51.5	8.36	61.8	9.8	66.9	10.6	72.0	11.4	82.3	13.1	92.6	14.8
	20	41.2	7.07	51.5	8.48	61.8	10.0	66.9	10.8	72.0	11.6	82.3	13.3	92.6	15.1
	21	41.2	7.12	51.5	8.5	61.8	10.1	66.9	10.9	72.0	11.7	82.3	13.4	92.6	15.3
	23	41.2	7.22	51.5	8.7	61.8	10.2	66.9	11.1	72.0	11.9	82.3	14.0	92.6	16.3
	25	41.2	7.32	51.5	8.8	61.8	10.6	66.9	11.6	72.0	12.7	82.3	14.9	92.6	17.4
	27	41.2	7.49	51.5	9.3	61.8	11.3	66.9	12.3	72.0	13.5	82.3	15.9	92.6	18.6
	29	41.2	7.92	51.5	9.8	61.8	12.0	66.9	13.1	72.0	14.3	82.3	16.9	92.6	19.8
	31	41.2	8.4	51.5	10.4	61.8	12.7	66.9	13.9	72.0	15.2	82.3	18.0	92.6	21.1
	33	41.2	8.8	51.5	11.0	61.8	13.4	66.9	14.8	72.0	16.2	82.3	19.1	92.6	22.4
	35	41.2	9.3	51.5	11.6	61.8	14.2	66.9	15.6	72.0	17.1	82.3	20.3	92.6	23.8
	37	41.2	9.8	51.5	12.3	61.8	15.1	66.9	16.6	72.0	18.2	82.3	21.6	92.6	25.3
	39	41.2	10.3	51.5	13.0	61.8	15.9	66.9	17.6	72.0	19.3	82.3	22.9	92.6	26.9
50% 55.75 kW	10	34.3	5.86	42.9	6.85	51.5	7.90	55.8	8.46	60.0	9.0	68.6	10.2	77.2	11.4
	12	34.3	5.93	42.9	6.93	51.5	8.01	55.8	8.57	60.0	9.2	68.6	10.4	77.2	11.6
	14	34.3	5.99	42.9	7.02	51.5	8.12	55.8	8.70	60.0	9.3	68.6	10.5	77.2	11.8
	16	34.3	6.06	42.9	7.11	51.5	8.24	55.8	8.83	60.0	9.4	68.6	10.7	77.2	12.0
	18	34.3	6.13	42.9	7.20	51.5	8.36	55.8	9.0	60.0	9.6	68.6	10.9	77.2	12.2
	20	34.3	6.20	42.9	7.30	51.5	8.48	55.8	9.1	60.0	9.7	68.6	11.1	77.2	12.4
	21	34.3	6.24	42.9	7.35	51.5	8.54	55.8	9.2	60.0	9.8	68.6	11.2	77.2	12.6
	23	34.3	6.31	42.9	7.45	51.5	8.68	55.8	9.3	60.0	10.0	68.6	11.4	77.2	12.9
	25	34.3	6.39	42.9	7.56	51.5	8.8	55.8	9.5	60.0	10.3	68.6	12.0	77.2	13.8
	27	34.3	6.48	42.9	7.77	51.5	9.3	55.8	10.1	60.0	10.9	68.6	12.7	77.2	14.7
	29	34.3	6.78	42.9	8.22	51.5	9.8	55.8	10.7	60.0	11.6	68.6	13.5	77.2	15.6
	31	34.3	7.14	42.9	8.7	51.5	10.4	55.8	11.3	60.0	12.3	68.6	14.3	77.2	16.6
	33	34.3	7.52	42.9	9.2	51.5	11.0	55.8	12.0	60.0	13.0	68.6	15.2	77.2	17.6
	35	34.3	7.91	42.9	9.7	51.5	11.6	55.8	12.7	60.0	13.8	68.6	16.1	77.2	18.7
	37	34.3	8.32	42.9	10.2	51.5	12.3	55.8	13.4	60.0	14.6	68.6	17.1	77.2	19.8
	39	34.3	8.7	42.9	10.7	51.5	13.0	55.8	14.2	60.0	15.4	68.6	18.1	77.2	21.0

3D079549

5 Таблицы производительности

5 - 1 Таблицы холодопроизводительности

RXYQ42T																
Indoor air temp. °CWB																
Combination(%) (Capacity index)	Outdoor air temp. (°CDB)	14.0		16.0		18.0		19.0		20.0		22.0		24.0		
		TC	PI	TC	PI	TC	PI	TC	PI	TC	PI	TC	PI	TC	PI	
		KW		KW		KW		KW		KW		KW		KW		KW
130% 144.95 kW	10	94	14,3	118	18,1	142	22,1	149	22,8	151	22,2	155	21,1	160	20,0	
	12	94	14,5	118	18,4	142	22,4	147	22,7	149	22,1	153	21,0	158	21,0	
	14	94	14,8	118	18,7	142	22,9	145	22,6	147	22,0	151	22,0	156	22,2	
	16	94	15,0	118	19,1	141	23,0	143	22,8	145	22,9	149	23,1	154	23,4	
	18	94	15,3	118	19,4	139	23,8	141	23,9	143	24,1	148	24,3	152	24,6	
	20	94	15,6	118	20,4	137	24,9	139	25,1	141	25,2	146	25,5	150	25,8	
	21	94	15,7	118	21,1	136	25,5	138	25,7	140	25,8	145	26,1	149	26,4	
	23	94	16,7	118	22,6	134	26,7	136	26,8	138	27,0	143	27,3	147	27,6	
	25	94	17,8	118	24,1	132	27,8	134	28,0	136	28,2	141	28,5	145	28,9	
	27	94	19,0	118	25,8	130	29,0	132	29,2	135	29,4	139	29,7	143	30,1	
	29	94	20,2	118	27,5	128	30,2	130	30,4	133	30,6	137	31,0	141	31,3	
	31	94	21,5	118	29,3	126	31,4	128	31,6	131	31,8	135	32,2	140	32,6	
	33	94	22,9	118	31,3	124	32,6	127	32,8	129	33,0	133	33,4	138	33,8	
	35	94	24,3	118	33,3	122	33,8	125	34,0	127	34,2	131	34,7	136	35,1	
	37	94	25,9	116	34,5	120	34,9	123	35,2	125	35,4	129	35,9	134	36,4	
	39	94	27,5	114	35,6	119	36,2	121	36,4	123	36,7	127	37,2	132	37,7	
	120% 133.80 kW	10	87,1	13,2	109	16,6	131	20,2	142	22,1	148	22,8	153	21,8	157	20,8
		12	87,1	13,4	109	16,9	131	20,6	142	22,4	147	22,7	151	21,7	155	20,8
14		87,1	13,6	109	17,2	131	20,9	142	22,9	145	22,6	149	21,8	153	22,0	
16		87,1	13,8	109	17,5	131	21,3	141	23,0	143	22,7	147	23,0	151	23,2	
18		87,1	14,1	109	17,8	131	21,9	139	23,8	141	23,9	145	24,2	149	24,4	
20		87,1	14,3	109	18,3	131	23,5	137	24,9	139	25,1	143	25,3	147	25,6	
21		87,1	14,5	109	18,9	131	24,4	136	25,5	138	25,7	142	25,9	146	26,2	
23		87,1	15,1	109	20,2	131	26,1	134	26,7	136	26,8	140	27,1	144	27,4	
25		87,1	16,1	109	21,6	130	27,7	132	27,8	134	28,0	138	28,3	142	28,6	
27		87,1	17,1	109	23,0	128	28,8	130	29,0	132	29,2	136	29,5	140	29,9	
29		87,1	18,2	109	24,6	126	30,0	128	30,2	130	30,4	134	30,7	138	31,1	
31		87,1	19,4	109	26,2	124	31,2	126	31,4	128	31,6	132	31,9	136	32,3	
33		87,1	20,6	109	27,9	122	32,4	124	32,6	126	32,8	130	32,2	135	33,5	
35		87,1	21,9	109	29,7	120	33,5	122	33,8	124	34,0	129	34,4	133	34,8	
37		87,1	23,2	109	31,6	118	34,7	120	34,9	123	35,2	127	35,6	131	36,0	
39		87,1	24,7	109	33,6	117	35,9	119	36,2	121	36,4	125	36,8	129	37,3	
110% 122.65 kW		10	79,9	12,1	100	15,1	120	18,4	130	20,0	140	21,7	150	22,5	154	21,6
		12	79,9	12,3	100	15,4	120	18,7	130	20,4	140	22,1	148	22,4	152	21,4
	14	79,9	12,5	100	15,7	120	19,0	130	20,8	140	22,5	146	22,3	150	21,9	
	16	79,9	12,7	100	15,9	120	19,4	130	21,2	140	22,9	144	22,8	148	23,0	
	18	79,9	12,9	100	16,2	120	19,7	130	21,7	138	23,8	142	24,0	146	24,2	
	20	79,9	13,1	100	16,5	120	20,8	130	23,3	136	24,9	140	25,2	144	25,4	
	21	79,9	13,2	100	16,8	120	21,5	130	24,1	136	25,5	139	25,7	143	26,0	
	23	79,9	13,6	100	18,0	120	23,1	130	25,9	134	26,7	137	26,9	141	27,2	
	25	79,9	14,4	100	19,2	120	24,7	130	27,7	132	27,8	135	28,1	139	28,4	
	27	79,9	15,4	100	20,5	120	26,3	128	28,8	130	29,0	133	29,3	137	29,6	
	29	79,9	16,3	100	21,8	120	28,1	126	30,0	128	30,2	132	30,5	135	30,8	
	31	79,9	17,4	100	23,2	120	30,0	124	31,2	126	31,3	130	31,7	133	32,0	
	33	79,9	18,4	100	24,7	120	32,0	122	32,3	124	32,5	128	32,9	131	33,3	
	35	79,9	19,6	100	26,3	118	33,3	120	33,5	122	33,7	126	34,1	130	34,5	
	37	79,9	20,8	100	27,9	116	34,5	118	34,7	120	34,9	124	35,3	128	35,7	
	39	79,9	22,0	100	29,7	115	35,7	116	35,9	118	36,1	122	36,5	126	37,0	
	100% 111.50 kW	10	72,6	11,0	90,8	13,7	109	16,6	118	18,1	127	19,6	145	22,7	150	22,3
		12	72,6	11,2	90,8	13,9	109	16,9	118	18,4	127	19,9	145	23,1	149	22,2
14		72,6	11,4	90,8	14,2	109	17,2	118	18,7	127	20,3	143	22,9	147	22,1	
16		72,6	11,5	90,8	14,4	109	17,5	118	19,1	127	20,7	141	22,8	145	22,9	
18		72,6	11,7	90,8	14,7	109	17,8	118	19,4	127	21,1	139	23,8	143	24,0	
20		72,6	11,9	90,8	14,9	109	18,3	118	20,4	127	22,6	137	25,0	141	25,2	
21		72,6	12,0	90,8	15,1	109	18,9	118	21,1	127	23,4	137	25,6	140	25,8	
23		72,6	12,2	90,8	15,9	109	20,2	118	22,6	127	25,1	135	26,7	138	27,0	
25		72,6	12,9	90,8	16,9	109	21,6	118	24,1	127	26,8	133	27,9	136	28,2	
27		72,6	13,7	90,8	18,1	109	23,0	118	25,8	127	28,7	131	29,1	134	29,4	
29		72,6	14,6	90,8	19,2	109	24,6	118	27,5	125	30,0	129	30,3	132	30,5	
31		72,6	15,5	90,8	20,4	109	26,2	118	29,3	124	31,1	127	31,4	130	31,7	
33		72,6	16,4	90,8	21,7	109	27,9	118	31,3	122	32,3	125	32,6	128	33,0	
35		72,6	17,4	90,8	23,1	109	29,7	118	33,3	120	33,5	123	33,8	126	34,2	
37		72,6	18,4	90,8	24,5	109	31,6	116	34,5	118	34,7	121	35,0	125	35,4	
39		72,6	19,5	90,8	26,0	109	33,6	114	35,6	116	35,8	119	36,2	123	36,6	

NOTES - ANMERKUNGEN - Σημειώσεις - NOTAS - REMARQUES - NOTE - OPMERKINGEN - примечания - NOTLAR

- The above table shows the average value of conditions which may occur.
Die obige Tabelle zeigt den Durchschnittswert der Bedingungen, die auftreten können.
 Στον παραπάνω πίνακα αναγράφεται η μέση τιμή για συνθήκες που μπορεί να προκύψουν.
La tabla de arriba muestra el valor medio de condiciones que pueden ocurrir.
 Le tableau ci-dessus donne la valeur moyenne pour des conditions qui peuvent survenir.
La tabella in alto mostra il valore delle condizioni medie che si possono riscontrare.
 De tabel hierboven geeft de gemiddelde waarde aan van situaties die kunnen voorvallen.
 Таблица расположенная выше показывает среднее значение условий, которые могут наступить.
 Yukarıdaki tablo meydana gelebilecek koşulların ortalama değerini göstermektedir.

3D079549

5 Таблицы производительности

5 - 1 Таблицы холодопроизводительности

5

RXYQ42T															
Indoor air temp. °CWB															
Combination(%) (Capacity index)	Outdoor air temp. (°CDB)	14.0		16.0		18.0		19.0		20.0		22.0		24.0	
		TC	PI	TC	PI	TC	PI	TC	PI	TC	PI	TC	PI	TC	PI
		KW	KW	KW	KW	KW	KW	KW	KW	KW	KW	KW	KW	KW	KW
90% 100.35 kW	10	61.8	9.3	77.2	11.4	92.6	13.8	100	15.0	108	16.2	124	18.8	139	21.4
	12	61.8	9.4	77.2	11.6	92.6	14.0	100	15.3	108	16.5	124	19.1	137	21.4
	14	61.8	9.5	77.2	11.8	92.6	14.3	100	15.5	108	16.8	124	19.5	136	21.3
	16	61.8	9.7	77.2	12.0	92.6	14.5	100	15.8	108	17.1	124	19.8	134	21.2
	18	61.8	9.8	77.2	12.2	92.6	14.8	100	16.1	108	17.5	124	20.4	132	22.2
	20	61.8	10.0	77.2	12.4	92.6	15.1	100	16.4	108	18.1	124	21.9	130	23.3
	21	61.8	10.1	77.2	12.6	92.6	15.3	100	17.0	108	18.8	124	22.7	129	23.8
	23	61.8	10.2	77.2	12.9	92.6	16.3	100	18.1	108	20.1	124	24.3	128	24.9
	25	61.8	10.6	77.2	13.8	92.6	17.4	100	19.4	108	21.5	123	25.8	126	26.0
	27	61.8	11.3	77.2	14.7	92.6	18.6	100	20.7	108	22.9	121	26.8	124	27.1
	29	61.8	12.0	77.2	15.6	92.6	19.8	100	22.1	108	24.5	119	27.9	122	28.2
	31	61.8	12.7	77.2	16.6	92.6	21.1	100	23.5	108	26.1	117	29.0	120	29.3
	33	61.8	13.4	77.2	17.6	92.6	22.4	100	25.0	108	27.8	116	30.1	118	30.4
	35	61.8	14.2	77.2	18.7	92.6	23.8	100	26.6	108	29.6	114	31.2	117	31.5
37	61.8	15.1	77.2	19.8	92.6	25.3	100	28.3	108	31.5	112	32.3	115	32.6	
39	61.8	15.9	77.2	21.0	92.6	26.9	100	30.1	107	33.1	110	33.4	113	33.8	
80% 89.20 kW	10	54.9	8.3	68.6	10.2	82.3	12.2	89.2	13.2	96.1	14.3	110	16.5	124	18.8
	12	54.9	8.5	68.6	10.4	82.3	12.4	89.2	13.5	96.1	14.6	110	16.8	124	19.1
	14	54.9	8.6	68.6	10.5	82.3	12.6	89.2	13.7	96.1	14.8	110	17.1	124	19.5
	16	54.9	8.7	68.6	10.7	82.3	12.8	89.2	13.9	96.1	15.1	110	17.4	124	19.8
	18	54.9	8.8	68.6	10.9	82.3	13.1	89.2	14.2	96.1	15.4	110	17.8	124	20.4
	20	54.9	9.0	68.6	11.1	82.3	13.3	89.2	14.5	96.1	15.7	110	18.5	124	21.9
	21	54.9	9.0	68.6	11.2	82.3	13.4	89.2	14.6	96.1	16.0	110	19.2	124	22.7
	23	54.9	9.2	68.6	11.4	82.3	14.0	89.2	15.5	96.1	17.1	110	20.5	124	24.3
	25	54.9	9.3	68.6	12.0	82.3	14.9	89.2	16.6	96.1	18.3	110	22.0	123	25.8
	27	54.9	9.9	68.6	12.7	82.3	15.9	89.2	17.7	96.1	19.5	110	23.5	121	26.8
	29	54.9	10.5	68.6	13.5	82.3	16.9	89.2	18.8	96.1	20.8	110	25.0	119	27.9
	31	54.9	11.1	68.6	14.3	82.3	18.0	89.2	20.0	96.1	22.1	110	26.7	117	29.0
	33	54.9	11.8	68.6	15.2	82.3	19.1	89.2	21.3	96.1	23.6	110	28.4	116	30.1
	35	54.9	12.5	68.6	16.1	82.3	20.3	89.2	22.6	96.1	25.1	110	30.3	114	31.2
37	54.9	13.2	68.6	17.1	82.3	21.6	89.2	24.0	96.1	26.6	109	32.0	112	32.3	
39	54.9	13.9	68.6	18.1	82.3	22.9	89.2	25.5	96.1	28.3	108	33.1	110	33.4	
70% 78.05 kW	10	48.0	7.47	60.0	9.0	72.0	10.7	78.1	11.6	84.1	12.5	96.1	14.3	108	16.2
	12	48.0	7.57	60.0	9.2	72.0	10.9	78.1	11.8	84.1	12.7	96.1	14.6	108	16.5
	14	48.0	7.67	60.0	9.3	72.0	11.0	78.1	11.9	84.1	12.9	96.1	14.8	108	16.8
	16	48.0	7.78	60.0	9.4	72.0	11.2	78.1	12.2	84.1	13.1	96.1	15.1	108	17.1
	18	48.0	7.88	60.0	9.6	72.0	11.4	78.1	12.4	84.1	13.3	96.1	15.4	108	17.5
	20	48.0	8.00	60.0	9.7	72.0	11.6	78.1	12.6	84.1	13.6	96.1	15.7	108	18.1
	21	48.0	8.06	60.0	9.8	72.0	11.7	78.1	12.7	84.1	13.7	96.1	16.0	108	18.8
	23	48.0	8.2	60.0	10.0	72.0	11.9	78.1	13.1	84.1	14.4	96.1	17.1	108	20.1
	25	48.0	8.3	60.0	10.3	72.0	12.7	78.1	14.0	84.1	15.3	96.1	18.3	108	21.5
	27	48.0	8.7	60.0	10.9	72.0	13.5	78.1	14.9	84.1	16.3	96.1	19.5	108	22.9
	29	48.0	9.2	60.0	11.6	72.0	14.3	78.1	15.8	84.1	17.4	96.1	20.8	108	24.5
	31	48.0	9.7	60.0	12.3	72.0	15.2	78.1	16.8	84.1	18.5	96.1	22.1	108	26.1
	33	48.0	10.2	60.0	13.0	72.0	16.2	78.1	17.9	84.1	19.7	96.1	23.6	108	27.8
	35	48.0	10.8	60.0	13.8	72.0	17.1	78.1	19.0	84.1	20.9	96.1	25.1	108	29.6
37	48.0	11.4	60.0	14.6	72.0	18.2	78.1	20.1	84.1	22.2	96.1	26.6	108	31.5	
39	48.0	12.0	60.0	15.4	72.0	19.3	78.1	21.3	84.1	23.6	96.1	28.3	107	33.1	
60% 66.90 kW	10	41.2	6.65	51.5	7.90	61.8	9.3	66.9	10.0	72.0	10.7	82.3	12.2	92.6	13.8
	12	41.2	6.72	51.5	8.01	61.8	9.4	66.9	10.1	72.0	10.9	82.3	12.4	92.6	14.0
	14	41.2	6.81	51.5	8.12	61.8	9.5	66.9	10.3	72.0	11.0	82.3	12.6	92.6	14.3
	16	41.2	6.89	51.5	8.24	61.8	9.7	66.9	10.4	72.0	11.2	82.3	12.8	92.6	14.5
	18	41.2	6.98	51.5	8.36	61.8	9.8	66.9	10.6	72.0	11.4	82.3	13.1	92.6	14.8
	20	41.2	7.07	51.5	8.48	61.8	10.0	66.9	10.8	72.0	11.6	82.3	13.3	92.6	15.1
	21	41.2	7.12	51.5	8.5	61.8	10.1	66.9	10.9	72.0	11.7	82.3	13.4	92.6	15.3
	23	41.2	7.22	51.5	8.7	61.8	10.2	66.9	11.1	72.0	11.9	82.3	14.0	92.6	16.3
	25	41.2	7.32	51.5	8.8	61.8	10.6	66.9	11.6	72.0	12.7	82.3	14.9	92.6	17.4
	27	41.2	7.49	51.5	9.3	61.8	11.3	66.9	12.3	72.0	13.5	82.3	15.9	92.6	18.6
	29	41.2	7.92	51.5	9.8	61.8	12.0	66.9	13.1	72.0	14.3	82.3	16.9	92.6	19.8
	31	41.2	8.4	51.5	10.4	61.8	12.7	66.9	13.9	72.0	15.2	82.3	18.0	92.6	21.1
	33	41.2	8.8	51.5	11.0	61.8	13.4	66.9	14.8	72.0	16.2	82.3	19.1	92.6	22.4
	35	41.2	9.3	51.5	11.6	61.8	14.2	66.9	15.6	72.0	17.1	82.3	20.3	92.6	23.8
37	41.2	9.8	51.5	12.3	61.8	15.1	66.9	16.6	72.0	18.2	82.3	21.6	92.6	25.3	
39	41.2	10.3	51.5	13.0	61.8	15.9	66.9	17.6	72.0	19.3	82.3	22.9	92.6	26.9	
50% 55.75 kW	10	34.3	5.86	42.9	6.85	51.5	7.90	55.8	8.46	60.0	9.0	68.6	10.2	77.2	11.4
	12	34.3	5.93	42.9	6.93	51.5	8.01	55.8	8.57	60.0	9.2	68.6	10.4	77.2	11.6
	14	34.3	5.99	42.9	7.02	51.5	8.12	55.8	8.70	60.0	9.3	68.6	10.5	77.2	11.8
	16	34.3	6.06	42.9	7.11	51.5	8.24	55.8	8.83	60.0	9.4	68.6	10.7	77.2	12.0
	18	34.3	6.13	42.9	7.20	51.5	8.36	55.8	9.0	60.0	9.6	68.6	10.9	77.2	12.2
	20	34.3	6.20	42.9	7.30	51.5	8.48	55.8	9.1	60.0	9.7	68.6	11.1	77.2	12.4
	21	34.3	6.24	42.9	7.35	51.5	8.54	55.8	9.2	60.0	9.8	68.6	11.2	77.2	12.6
	23	34.3	6.31	42.9	7.45	51.5	8.68	55.8	9.3	60.0	10.0	68.6	11.4	77.2	12.9
	25	34.3	6.39	42.9	7.56	51.5	8.8	55.8	9.5	60.0	10.3	68.6	12.0	77.2	13.8
	27	34.3	6.48	42.9	7.77	51.5	9.3	55.8	10.1	60.0	10.9	68.6	12.7	77.2	14.7
	29	34.3	6.78	42.9	8.22	51.5	9.8	55.8	10.7	60.0	11.6	68.6	13.5	77.2	15.6
	31	34.3	7.14	42.9	8.7	51.5	10.4	55.8	11.3	60.0	12.3	68.6	14.3	77.2	16.6
	33	34.3	7.52	42.9	9.2	51.5	11.0	55.8	12.0	60.0	13.0	68.6	15.2	77.2	17.6
	35	34.3	7.91	42.9	9.7	51.5	11.6	55.8	12.7	60.0	13.8	68.6	16.1	77.2	18.7
37	34.3	8.32	42.9	10.2	51.5	12.3	55.8	13.4	60.0	14.6	68.6	17.1	77.2	19.8	
39	34.3	8.7	42.9	10.7	51.5	13.0	55.8	14.2	60.0	15.4	68.6	18.1	77.2	21.0	

3D079549

5 Таблицы производительности

5 - 1 Таблицы холодопроизводительности

RXYQ44T																
Indoor air temp. °CWB																
Combination(%) (Capacity index)	Outdoor air temp. (°CDB)	14.0		16.0		18.0		19.0		20.0		22.0		24.0		
		TC	PI	TC	PI	TC	PI	TC	PI	TC	PI	TC	PI	TC	PI	
		KW	KW	KW	KW	KW	KW	KW	KW	KW	KW	KW	KW	KW	KW	KW
130% 160.55 kW	10	99	15.0	124	19.0	148	23.2	156	23.9	158	23.4	162	22.2	167	21.0	
	12	99	15.2	124	19.3	148	23.6	154	23.8	156	23.2	160	22.0	165	22.1	
	14	99	15.5	124	19.7	148	24.0	152	23.7	154	23.1	158	23.1	163	23.3	
	16	99	15.8	124	20.0	147	24.2	150	23.9	152	24.0	156	24.3	161	24.6	
	18	99	16.1	124	20.4	145	25.0	148	25.1	150	25.3	154	25.6	159	25.9	
	20	99	16.4	124	21.4	143	26.2	145	26.4	148	26.5	152	26.8	157	27.1	
	21	99	16.5	124	22.2	142	26.8	144	27.0	147	27.1	151	27.4	156	27.8	
	23	99	17.6	124	23.7	140	28.0	142	28.2	145	28.4	149	28.7	154	29.0	
	25	99	18.7	124	25.4	138	29.3	140	29.4	143	29.6	147	30.0	152	30.3	
	27	99	20.0	124	27.1	136	30.5	138	30.7	141	30.9	145	31.3	150	31.6	
	29	99	21.3	124	28.9	134	31.7	136	31.9	139	32.1	143	32.5	148	32.9	
	31	99	22.6	124	30.8	132	33.0	134	33.2	137	33.4	141	33.8	146	34.2	
	33	99	24.1	124	32.8	130	34.2	132	34.4	135	34.7	139	35.1	144	35.6	
	35	99	25.6	124	35.0	128	35.5	130	35.7	133	35.9	137	36.4	142	36.9	
	37	99	27.2	121	36.2	126	36.7	128	37.0	131	37.2	135	37.7	140	38.2	
	39	99	28.9	119	37.5	124	38.0	126	38.3	129	38.5	133	39.0	138	39.6	
	120% 148.20 kW	10	91	13.8	114	17.4	137	21.2	148	23.2	155	24.0	160	22.9	164	21.8
		12	91	14.0	114	17.7	137	21.6	148	23.6	153	23.9	158	22.8	162	21.9
14		91	14.3	114	18.0	137	22.0	148	24.0	151	23.7	156	22.9	160	23.2	
16		91	14.5	114	18.4	137	22.4	147	24.2	149	23.9	154	24.1	158	24.4	
18		91	14.8	114	18.7	137	23.0	145	25.0	147	25.1	152	25.4	156	25.7	
20		91	15.0	114	19.2	137	24.7	143	26.2	145	26.3	150	26.6	154	26.9	
21		91	15.2	114	19.8	137	25.6	142	26.8	144	27.0	149	27.3	153	27.5	
23		91	15.9	114	21.2	137	27.5	140	28.0	142	28.2	147	28.5	151	28.8	
25		91	16.9	114	22.7	136	29.1	138	29.3	140	29.4	145	29.8	149	30.1	
27		91	18.0	114	24.2	134	30.3	136	30.5	138	30.7	143	31.0	147	31.4	
29		91	19.2	114	25.8	132	31.5	134	31.7	136	31.9	141	32.3	145	32.7	
31		91	20.4	114	27.5	130	32.8	132	33.0	134	33.2	139	33.6	143	34.0	
33		91	21.6	114	29.3	128	34.0	130	34.2	132	34.4	137	34.8	141	35.3	
35		91	23.0	114	31.2	126	35.2	128	35.5	130	35.7	135	36.1	139	36.6	
37		91	24.4	114	33.2	124	36.5	126	36.7	128	37.0	133	37.4	137	37.9	
39		91	25.9	114	35.3	122	37.7	124	38.0	126	38.2	131	38.7	135	39.2	
110% 135.85 kW		10	83.6	12.7	105	15.9	125	19.3	136	21.1	146	22.8	157	23.6	161	22.7
		12	83.6	12.9	105	16.2	125	19.6	136	21.4	146	23.3	155	23.5	159	22.5
	14	83.6	13.1	105	16.4	125	20.0	136	21.8	146	23.7	153	23.4	157	23.0	
	16	83.6	13.3	105	16.7	125	20.4	136	22.2	146	24.1	151	24.0	155	24.2	
	18	83.6	13.5	105	17.0	125	20.7	136	22.8	145	25.0	149	25.2	153	25.5	
	20	83.6	13.8	105	17.4	125	21.9	136	24.5	143	26.2	147	26.4	151	26.7	
	21	83.6	13.9	105	17.7	125	22.6	136	25.4	142	26.8	146	27.1	150	27.3	
	23	83.6	14.2	105	18.9	125	24.2	136	27.2	140	28.0	144	28.3	148	28.6	
	25	83.6	15.2	105	20.2	125	25.9	136	29.1	138	29.2	142	29.5	146	29.8	
	27	83.6	16.2	105	21.5	125	27.7	134	30.3	136	30.5	140	30.8	144	31.1	
	29	83.6	17.2	105	22.9	125	29.5	132	31.5	134	31.7	138	32.0	142	32.4	
	31	83.6	18.2	105	24.4	125	31.5	130	32.8	132	32.9	136	33.3	140	33.7	
	33	83.6	19.4	105	26.0	125	33.6	128	34.0	130	34.2	134	34.6	138	34.9	
	35	83.6	20.6	105	27.6	124	35.0	126	35.2	128	35.4	132	35.8	136	36.2	
	37	83.6	21.8	105	29.4	122	36.3	124	36.5	126	36.7	130	37.1	134	37.5	
	39	83.6	23.1	105	31.2	120	37.5	122	37.7	124	37.9	128	38.4	132	38.8	
	100% 123.50 kW	10	76.0	11.6	95.0	14.4	114	17.4	124	19.0	133	20.6	152	23.8	158	23.5
		12	76.0	11.7	95.0	14.6	114	17.7	124	19.3	133	20.9	152	24.2	155	23.3
14		76.0	11.9	95.0	14.9	114	18.0	124	19.7	133	21.3	150	24.1	153	23.2	
16		76.0	12.1	95.0	15.1	114	18.4	124	20.0	133	21.7	148	24.0	151	24.0	
18		76.0	12.3	95.0	15.4	114	18.7	124	20.4	133	22.1	146	25.0	149	25.3	
20		76.0	12.5	95.0	15.7	114	19.2	124	21.4	133	23.8	144	26.2	147	26.5	
21		76.0	12.6	95.0	15.8	114	19.8	124	22.2	133	24.6	143	26.9	146	27.1	
23		76.0	12.9	95.0	16.7	114	21.2	124	23.7	133	26.4	141	28.1	144	28.3	
25		76.0	13.5	95.0	17.8	114	22.7	124	25.4	133	28.2	139	29.3	142	29.6	
27		76.0	14.4	95.0	19.0	114	24.2	124	27.1	133	30.1	137	30.5	140	30.8	
29		76.0	15.3	95.0	20.2	114	25.8	124	28.9	131	31.5	135	31.8	138	32.1	
31		76.0	16.2	95.0	21.5	114	27.5	124	30.8	129	32.7	133	33.0	136	33.4	
33		76.0	17.2	95.0	22.8	114	29.3	124	32.8	127	33.9	131	34.3	134	34.6	
35		76.0	18.3	95.0	24.3	114	31.2	124	35.0	125	35.2	129	35.5	132	35.9	
37		76.0	19.4	95.0	25.8	114	33.2	121	36.2	123	36.4	127	36.8	130	37.2	
39		76.0	20.5	95.0	27.4	114	35.3	119	37.5	121	37.7	125	38.1	128	38.5	

NOTES - ANMERKUNGEN - Σημειώσεις - NOTAS - REMARQUES - NOTE - OPMERKINGEN - примечания - NOTLAR

- The above table shows the average value of conditions which may occur.
Die obige Tabelle zeigt den Durchschnittswert der Bedingungen, die auftreten können.
 Στον παραπάνω πίνακα αναγράφεται η μέση τιμή για συνθήκες που μπορεί να προκύψουν.
La tabla de arriba muestra el valor medio de condiciones que pueden ocurrir.
 Le tableau ci-dessus donne la valeur moyenne pour des conditions qui peuvent survenir.
 La tabella in alto mostra il valore delle condizioni medie che si possono riscontrare.
 De tabel hierboven geeft de gemiddelde waarde aan van situaties die kunnen voorvallen.
 Таблица расположенная выше показывает среднее значение условий, которые могут наступить.
 Yukarıdaki tablo meydana gelebilecek koşulların ortalama değerini göstermektedir.

3D079549

5 Таблицы производительности

5 - 1 Таблицы холодопроизводительности

5

RXYQ44T															
Indoor air temp. °CWB															
Combination(%) (Capacity index)	Outdoor air temp. (°CDB)	14.0		16.0		18.0		19.0		20.0		22.0		24.0	
		TC	PI	TC	PI	TC	PI	TC	PI	TC	PI	TC	PI	TC	PI
		KW	KW	KW	KW	KW	KW	KW	KW	KW	KW	KW	KW	KW	KW
90% 111.15 kW	10	68.4	10.5	85.5	13.0	103	15.6	111	17.0	120	18.4	137	21.2	154	24.1
	12	68.4	10.7	85.5	13.2	103	15.9	111	17.3	120	18.7	137	21.6	152	24.1
	14	68.4	10.8	85.5	13.4	103	16.1	111	17.6	120	19.0	137	22.0	150	24.0
	16	68.4	11.0	85.5	13.6	103	16.4	111	17.9	120	19.4	137	22.4	148	23.9
	18	68.4	11.2	85.5	13.8	103	16.7	111	18.2	120	19.7	137	23.0	146	25.1
	20	68.4	11.3	85.5	14.1	103	17.0	111	18.5	120	20.5	137	24.7	144	26.3
	21	68.4	11.4	85.5	14.2	103	17.3	111	19.2	120	21.2	137	25.6	143	26.9
	23	68.4	11.6	85.5	14.6	103	18.4	111	20.5	120	22.7	137	27.5	141	28.1
	25	68.4	12.0	85.5	15.6	103	19.7	111	21.9	120	24.3	136	29.1	139	29.3
	27	68.4	12.8	85.5	16.6	103	21.0	111	23.4	120	25.9	134	30.3	137	30.6
	29	68.4	13.6	85.5	17.7	103	22.4	111	24.9	120	27.7	132	31.5	135	31.8
	31	68.4	14.4	85.5	18.8	103	23.8	111	26.6	120	29.5	130	32.8	133	33.1
	33	68.4	15.2	85.5	19.9	103	25.3	111	28.3	120	31.4	128	34.0	131	34.3
	35	68.4	16.1	85.5	21.1	103	26.9	111	30.1	120	33.4	126	35.2	129	35.6
	37	68.4	17.1	85.5	22.4	103	28.6	111	32.0	120	35.6	124	36.5	127	36.8
	39	68.4	18.0	85.5	23.8	103	30.4	111	34.0	119	37.4	122	37.7	125	38.1
80% 98.8 kW	10	60.8	9.5	76.0	11.6	91.2	13.8	98.8	15.0	106	16.2	122	18.7	137	21.2
	12	60.8	9.6	76.0	11.7	91.2	14.0	98.8	15.2	106	16.5	122	19.0	137	21.6
	14	60.8	9.7	76.0	11.9	91.2	14.3	98.8	15.5	106	16.8	122	19.3	137	22.0
	16	60.8	9.9	76.0	12.1	91.2	14.5	98.8	15.8	106	17.1	122	19.7	137	22.4
	18	60.8	10.0	76.0	12.3	91.2	14.8	98.8	16.1	106	17.4	122	20.1	137	23.0
	20	60.8	10.2	76.0	12.5	91.2	15.0	98.8	16.4	106	17.7	122	21.0	137	24.7
	21	60.8	10.3	76.0	12.6	91.2	15.2	98.8	16.5	106	18.1	122	21.7	137	25.6
	23	60.8	10.4	76.0	12.9	91.2	15.9	98.8	17.6	106	19.3	122	23.2	137	27.5
	25	60.8	10.6	76.0	13.5	91.2	16.9	98.8	18.7	106	20.7	122	24.8	136	29.1
	27	60.8	11.2	76.0	14.4	91.2	18.0	98.8	20.0	106	22.0	122	26.5	134	30.3
	29	60.8	11.9	76.0	15.3	91.2	19.2	98.8	21.3	106	23.5	122	28.3	132	31.5
	31	60.8	12.6	76.0	16.2	91.2	20.4	98.8	22.6	106	25.0	122	30.1	130	32.8
	33	60.8	13.3	76.0	17.2	91.2	21.6	98.8	24.1	106	26.6	122	32.1	128	34.0
	35	60.8	14.1	76.0	18.3	91.2	23.0	98.8	25.6	106	28.3	122	34.2	126	35.2
	37	60.8	14.9	76.0	19.4	91.2	24.4	98.8	27.2	106	30.1	121	36.2	124	36.5
	39	60.8	15.8	76.0	20.5	91.2	25.9	98.8	28.9	106	32.0	119	37.4	122	37.7
70% 86.45 kW	10	53.2	8.49	66.5	10.2	79.8	12.1	86.5	13.1	93.1	14.1	106	16.2	120	18.4
	12	53.2	8.6	66.5	10.4	79.8	12.3	86.5	13.3	93.1	14.3	106	16.5	120	18.7
	14	53.2	8.7	66.5	10.5	79.8	12.5	86.5	13.5	93.1	14.6	106	16.8	120	19.0
	16	53.2	8.8	66.5	10.7	79.8	12.7	86.5	13.8	93.1	14.8	106	17.1	120	19.4
	18	53.2	9.0	66.5	10.9	79.8	12.9	86.5	14.0	93.1	15.1	106	17.4	120	19.7
	20	53.2	9.1	66.5	11.0	79.8	13.1	86.5	14.2	93.1	15.4	106	17.7	120	20.5
	21	53.2	9.1	66.5	11.1	79.8	13.3	86.5	14.4	93.1	15.5	106	18.1	120	21.2
	23	53.2	9.3	66.5	11.3	79.8	13.5	86.5	14.8	93.1	16.3	106	19.3	120	22.7
	25	53.2	9.4	66.5	11.7	79.8	14.4	86.5	15.8	93.1	17.4	106	20.7	120	24.3
	27	53.2	9.8	66.5	12.4	79.8	15.3	86.5	16.8	93.1	18.5	106	22.0	120	25.9
	29	53.2	10.4	66.5	13.1	79.8	16.2	86.5	17.9	93.1	19.7	106	23.5	120	27.7
	31	53.2	11.0	66.5	13.9	79.8	17.2	86.5	19.0	93.1	20.9	106	25.0	120	29.5
	33	53.2	11.6	66.5	14.7	79.8	18.3	86.5	20.2	93.1	22.2	106	26.6	120	31.4
	35	53.2	12.3	66.5	15.6	79.8	19.4	86.5	21.5	93.1	23.6	106	28.3	120	33.4
	37	53.2	12.9	66.5	16.5	79.8	20.6	86.5	22.8	93.1	25.1	106	30.1	120	35.6
	39	53.2	13.7	66.5	17.5	79.8	21.8	86.5	24.1	93.1	26.6	106	32.0	119	37.4
60% 74.10 kW	10	45.6	7.56	57.0	9.0	68.4	10.5	74.1	11.3	79.8	12.1	91.2	13.8	102.6	15.6
	12	45.6	7.65	57.0	9.1	68.4	10.7	74.1	11.5	79.8	12.3	91.2	14.0	102.6	15.9
	14	45.6	7.74	57.0	9.2	68.4	10.8	74.1	11.6	79.8	12.5	91.2	14.3	102.6	16.1
	16	45.6	7.84	57.0	9.4	68.4	11.0	74.1	11.8	79.8	12.7	91.2	14.5	102.6	16.4
	18	45.6	7.94	57.0	9.5	68.4	11.2	74.1	12.0	79.8	12.9	91.2	14.8	102.6	16.7
	20	45.6	8.04	57.0	9.6	68.4	11.3	74.1	12.2	79.8	13.1	91.2	15.0	102.6	17.0
	21	45.6	8.09	57.0	9.7	68.4	11.4	74.1	12.3	79.8	13.3	91.2	15.2	102.6	17.3
	23	45.6	8.20	57.0	9.8	68.4	11.6	74.1	12.5	79.8	13.5	91.2	15.9	102.6	18.4
	25	45.6	8.32	57.0	10.0	68.4	12.0	74.1	13.2	79.8	14.4	91.2	16.9	102.6	19.7
	27	45.6	8.5	57.0	10.5	68.4	12.8	74.1	14.0	79.8	15.3	91.2	18.0	102.6	21.0
	29	45.6	9.0	57.0	11.1	68.4	13.6	74.1	14.9	79.8	16.2	91.2	19.2	102.6	22.4
	31	45.6	9.5	57.0	11.8	68.4	14.4	74.1	15.8	79.8	17.2	91.2	20.4	102.6	23.8
	33	45.6	10.0	57.0	12.5	68.4	15.2	74.1	16.7	79.8	18.3	91.2	21.6	102.6	25.3
	35	45.6	10.6	57.0	13.2	68.4	16.1	74.1	17.7	79.8	19.4	91.2	23.0	102.6	26.9
	37	45.6	11.1	57.0	13.9	68.4	17.1	74.1	18.8	79.8	20.6	91.2	24.4	102.6	28.6
	39	45.6	11.7	57.0	14.7	68.4	18.0	74.1	19.9	79.8	21.8	91.2	25.9	102.6	30.4
50% 61.75 kW	10	38.0	6.68	47.5	7.79	57.0	8.98	61.8	9.6	66.5	10.2	76.0	11.6	85.5	13.0
	12	38.0	6.75	47.5	7.88	57.0	9.1	61.8	9.7	66.5	10.4	76.0	11.7	85.5	13.2
	14	38.0	6.82	47.5	7.98	57.0	9.2	61.8	9.9	66.5	10.5	76.0	11.9	85.5	13.4
	16	38.0	6.90	47.5	8.08	57.0	9.4	61.8	10.0	66.5	10.7	76.0	12.1	85.5	13.6
	18	38.0	6.97	47.5	8.18	57.0	9.5	61.8	10.2	66.5	10.9	76.0	12.3	85.5	13.8
	20	38.0	7.06	47.5	8.29	57.0	9.6	61.8	10.3	66.5	11.0	76.0	12.5	85.5	14.1
	21	38.0	7.10	47.5	8.35	57.0	9.7	61.8	10.4	66.5	11.1	76.0	12.6	85.5	14.2
	23	38.0	7.18	47.5	8.47	57.0	9.8	61.8	10.6	66.5	11.3	76.0	12.9	85.5	14.6
	25	38.0	7.27	47.5	8.59	57.0	10.0	61.8	10.8	66.5	11.7	76.0	13.5	85.5	15.6
	27	38.0	7.37	47.5	8.83	57.0	10.5	61.8	11.4	66.5	12.4	76.0	14.4	85.5	16.6
	29	38.0	7.71	47.5	9.3	57.0	11.1	61.8	12.1	66.5	13.1	76.0	15.3	85.5	17.1
	31	38.0	8.12	47.5	9.9	57.0	11.8	61.8	12.8	66.5	13.9	76.0	16.2	85.5	18.8
	33	38.0	8.55	47.5	10.4	57.0	12.5	61.8	13.6	66.5	14.7	76.0	17.2	85.5	19.9
	35	38.0	9.0	47.5	11.0	57.0	13.2	61.8	14.4	66.5	15.6	76.0	18.3	85.5	21.1
	37	38.0	9.5	47.5	11.6	57.0	13.9	61.8	15.2	66.5	16.5	76.0	19.4	85.5	22.4
	39	38.0	9.9	47.5	12.2	57.0	14.7	61.8	16.0	66.5	17.5	76.0	20.5	85.5	23.8

3D079549

5 Таблицы производительности

5 - 1 Таблицы холодопроизводительности

RXYQ46T															
Indoor air temp. °CWB															
Combination(%) (Capacity index)	Outdoor air temp. (°CDB)	14.0		16.0		18.0		19.0		20.0		22.0		24.0	
		TC	PI	TC	PI	TC	PI	TC	PI	TC	PI	TC	PI	TC	PI
		KW	KW	KW	KW	KW	KW	KW	KW	KW	KW	KW	KW	KW	KW
130% 169.00 kW	10	104	15.9	130	20.1	156	24.5	164	25.3	166	24.7	171	23.5	176	22.2
	12	104	16.2	130	20.5	156	24.9	162	25.2	164	24.6	169	23.3	174	23.3
	14	104	16.4	130	20.8	156	25.4	160	25.1	162	24.4	167	24.4	172	24.7
	16	104	16.7	130	21.2	155	25.6	157	25.3	160	25.4	165	25.7	170	26.0
	18	104	17.0	130	21.6	153	26.4	155	26.6	158	26.7	163	27.0	167	27.3
	20	104	17.3	130	22.7	151	27.7	153	27.9	156	28.0	160	28.4	165	28.7
	21	104	17.5	130	23.4	150	28.4	152	28.5	155	28.7	159	29.0	164	29.4
	23	104	18.6	130	25.1	148	29.6	150	29.8	152	30.0	157	30.4	162	30.7
	25	104	19.8	130	26.8	145	30.9	148	31.1	150	31.3	155	31.7	160	32.1
	27	104	21.1	130	28.7	143	32.2	146	32.4	148	32.6	153	33.0	158	33.5
	29	104	22.5	130	30.6	141	33.5	144	33.8	146	34.0	151	34.4	156	34.8
	31	104	24.0	130	32.6	139	34.9	142	35.1	144	35.3	149	35.8	154	36.2
	33	104	25.5	130	34.7	137	36.2	139	36.4	142	36.7	147	37.1	152	37.6
	35	104	27.1	130	37.0	135	37.5	137	37.8	140	38.0	145	38.5	149	39.0
	37	104	28.8	128	38.3	133	38.8	135	39.1	138	39.4	142	39.9	147	40.4
	39	104	30.5	126	39.6	131	40.2	133	40.5	136	40.7	140	41.3	145	41.8
120% 156.00 kW	10	96	14.7	120	18.5	144	22.5	156	24.5	164	25.4	168	24.2	173	23.1
	12	96	14.9	120	18.8	144	22.9	156	24.9	161	25.2	166	24.1	170	23.2
	14	96	15.1	120	19.1	144	23.3	156	25.4	159	25.1	164	24.2	168	24.5
	16	96	15.4	120	19.4	144	23.7	155	25.6	157	25.3	162	25.5	166	25.8
	18	96	15.7	120	19.8	144	24.4	153	26.4	155	26.6	160	26.8	164	27.1
	20	96	15.9	120	20.3	144	26.2	151	27.7	153	27.9	157	28.2	162	28.5
	21	96	16.1	120	21.0	144	27.1	150	28.4	152	28.5	156	28.8	161	29.1
	23	96	16.8	120	22.5	144	29.0	148	29.6	150	29.8	154	30.1	159	30.5
	25	96	17.9	120	24.0	143	30.8	145	30.9	148	31.1	152	31.5	157	31.8
	27	96	19.1	120	25.6	141	32.1	143	32.2	146	32.4	150	32.8	155	33.2
	29	96	20.3	120	27.3	139	33.4	141	33.5	143	33.7	148	34.1	152	34.5
	31	96	21.6	120	29.1	137	34.7	139	34.9	141	35.1	146	35.5	150	35.9
	33	96	22.9	120	31.0	135	36.0	137	36.2	139	36.4	144	36.8	148	37.3
	35	96	24.3	120	33.0	133	37.3	135	37.5	137	37.7	142	38.2	146	38.7
	37	96	25.8	120	35.1	131	38.6	133	38.8	135	39.1	139	39.6	144	40.1
	39	96	27.4	120	37.3	128	39.9	131	40.2	133	40.4	137	40.9	142	41.5
110% 143.00 kW	10	88.0	13.4	110	16.8	132	20.4	143	22.3	154	24.2	165	25.0	169	24.0
	12	88.0	13.7	110	17.1	132	20.8	143	22.7	154	24.6	163	24.9	167	23.8
	14	88.0	13.9	110	17.4	132	21.2	143	23.1	154	25.0	161	24.7	165	24.3
	16	88.0	14.1	110	17.7	132	21.6	143	23.5	154	25.5	159	25.4	163	25.6
	18	88.0	14.3	110	18.1	132	22.0	143	24.1	152	26.4	157	26.7	161	26.9
	20	88.0	14.6	110	18.4	132	23.1	143	25.9	150	27.7	154	28.0	159	28.2
	21	88.0	14.7	110	18.7	132	24.0	143	26.8	149	28.3	153	28.6	158	28.9
	23	88.0	15.1	110	20.0	132	25.6	143	28.7	147	29.6	151	29.9	155	30.2
	25	88.0	16.1	110	21.4	132	27.4	143	30.7	145	30.9	149	31.2	153	31.6
	27	88.0	17.1	110	22.8	132	29.3	141	32.0	143	32.2	147	32.6	151	32.9
	29	88.0	18.2	110	24.3	132	31.3	139	33.3	141	33.5	145	33.9	149	34.2
	31	88.0	19.3	110	25.8	132	33.3	137	34.6	139	34.8	143	35.2	147	35.6
	33	88.0	20.5	110	27.5	132	35.5	135	35.9	137	36.1	141	36.5	145	36.9
	35	88.0	21.8	110	29.2	130	37.0	132	37.3	134	37.5	139	37.9	143	38.3
	37	88.0	23.1	110	31.1	128	38.3	130	38.6	132	38.8	136	39.2	141	39.7
	39	88.0	24.5	110	33.0	126	39.7	128	39.9	130	40.1	134	40.6	138	41.1
100% 130.00 kW	10	80.0	12.3	100	15.3	120	18.5	130	20.1	140	21.8	160	25.2	166	24.8
	12	80.0	12.5	100	15.5	120	18.8	130	20.5	140	22.2	160	25.6	164	24.7
	14	80.0	12.7	100	15.8	120	19.1	130	20.8	140	22.6	158	25.5	162	24.5
	16	80.0	12.9	100	16.1	120	19.4	130	21.2	140	23.0	156	25.4	159	25.4
	18	80.0	13.1	100	16.3	120	19.8	130	21.6	140	23.4	154	26.5	157	26.7
	20	80.0	13.3	100	16.6	120	20.3	130	22.7	140	25.1	151	27.8	155	28.0
	21	80.0	13.4	100	16.8	120	21.0	130	23.4	140	26.0	150	28.4	154	28.7
	23	80.0	13.6	100	17.7	120	22.5	130	25.1	140	27.9	148	29.7	152	30.0
	25	80.0	14.4	100	18.9	120	24.0	130	26.8	140	29.8	146	31.0	150	31.3
	27	80.0	15.3	100	20.1	120	25.6	130	28.7	140	31.9	144	32.3	148	32.6
	29	80.0	16.2	100	21.4	120	27.3	130	30.6	138	33.3	142	33.6	146	33.9
	31	80.0	17.2	100	22.7	120	29.1	130	32.6	136	34.6	140	34.9	144	35.3
	33	80.0	18.3	100	24.2	120	31.0	130	34.7	134	35.9	138	36.3	141	36.6
	35	80.0	19.4	100	25.7	120	33.0	130	37.0	132	37.2	136	37.6	139	38.0
	37	80.0	20.5	100	27.3	120	35.1	128	38.3	130	38.5	133	38.9	137	39.3
	39	80.0	21.7	100	29.0	120	37.3	126	39.6	128	39.8	131	40.3	135	40.7

NOTES - ANMERKUNGEN - Σημειώσεις - NOTAS - REMARQUES - NOTE - OPMERKINGEN - примечания - NOTLAR

- The above table shows the average value of conditions which may occur.
Die obige Tabelle zeigt den Durchschnittswert der Bedingungen, die auftreten können.
 Στον παραπάνω πίνακα αναγράφεται η μέση τιμή για συνθήκες που μπορεί να προκύψουν.
La tabla de arriba muestra el valor medio de condiciones que pueden ocurrir.
 Le tableau ci-dessus donne la valeur moyenne pour des conditions qui peuvent survenir.
La tabella in alto mostra il valore delle condizioni medie che si possono riscontrare.
 De tabel hierboven geeft de gemiddelde waarde aan van situaties die kunnen voorvallen.
Таблица расположенная выше показывает среднее значение условий, которые могут наступить.
 Yukarıdaki tablo meydana gelebilecek koşulların ortalama değerini göstermektedir.

3D079549

5 Таблицы производительности

5 - 1 Таблицы холодопроизводительности

5

RXYQ46T															
Indoor air temp. °CWB															
Combination(%) (Capacity index)	Outdoor air temp. (°CDB)	14.0		16.0		18.0		19.0		20.0		22.0		24.0	
		TC	PI	TC	PI	TC	PI	TC	PI	TC	PI	TC	PI	TC	PI
		KW	KW	KW	KW	KW	KW	KW	KW	KW	KW	KW	KW	KW	KW
90% 117.00 kW	10	72.0	11.2	90.0	13.7	108	16.5	117	18.0	126	19.4	144	22.5	162	25.5
	12	72.0	11.3	90.0	14.0	108	16.8	117	18.3	126	19.8	144	22.9	160	25.5
	14	72.0	11.5	90.0	14.2	108	17.1	117	18.6	126	20.1	144	23.3	158	25.4
	16	72.0	11.7	90.0	14.4	108	17.4	117	18.9	126	20.5	144	23.7	156	25.3
	18	72.0	11.8	90.0	14.7	108	17.7	117	19.3	126	20.9	144	24.4	154	26.5
	20	72.0	12.0	90.0	14.9	108	18.0	117	19.6	126	21.7	144	26.2	152	27.8
	21	72.0	12.1	90.0	15.1	108	18.3	117	20.3	126	22.5	144	27.1	151	28.4
	23	72.0	12.3	90.0	15.5	108	19.5	117	21.7	126	24.0	144	29.0	149	29.7
	25	72.0	12.8	90.0	16.5	108	20.8	117	23.2	126	25.7	143	30.8	147	31.0
	27	72.0	13.6	90.0	17.6	108	22.2	117	24.7	126	27.4	141	32.1	144	32.3
	29	72.0	14.4	90.0	18.7	108	23.7	117	26.4	126	29.3	139	33.4	142	33.6
	31	72.0	15.2	90.0	19.9	108	25.2	117	28.1	126	31.2	137	34.7	140	35.0
	33	72.0	16.1	90.0	21.1	108	26.8	117	29.9	126	33.2	135	36.0	138	36.3
	35	72.0	17.1	90.0	22.4	108	28.5	117	31.8	126	35.4	133	37.3	136	37.6
37	72.0	18.1	90.0	23.8	108	30.3	117	33.9	126	37.6	131	38.6	134	39.0	
39	72.0	19.1	90.0	25.2	108	32.2	117	36.0	125	39.5	128	39.9	132	40.3	
80% 104.00 kW	10	64.0	10.1	80.0	12.3	96.0	14.7	104	15.9	112	17.2	128	19.8	144	22.5
	12	64.0	10.2	80.0	12.5	96.0	14.9	104	16.2	112	17.5	128	20.1	144	22.9
	14	64.0	10.4	80.0	12.7	96.0	15.1	104	16.4	112	17.8	128	20.5	144	23.3
	16	64.0	10.5	80.0	12.9	96.0	15.4	104	16.7	112	18.1	128	20.8	144	23.7
	18	64.0	10.7	80.0	13.1	96.0	15.7	104	17.0	112	18.4	128	21.2	144	24.4
	20	64.0	10.8	80.0	13.3	96.0	15.9	104	17.3	112	18.7	128	22.2	144	26.2
	21	64.0	10.9	80.0	13.4	96.0	16.1	104	17.5	112	19.2	128	22.9	144	27.1
	23	64.0	11.1	80.0	13.6	96.0	16.8	104	18.6	112	20.5	128	24.6	144	29.0
	25	64.0	11.3	80.0	14.4	96.0	17.9	104	19.8	112	21.9	128	26.3	143	30.8
	27	64.0	11.9	80.0	15.3	96.0	19.1	104	21.1	112	23.3	128	28.0	141	32.1
	29	64.0	12.7	80.0	16.2	96.0	20.3	104	22.5	112	24.9	128	29.9	139	33.4
	31	64.0	13.4	80.0	17.2	96.0	21.6	104	24.0	112	26.5	128	31.9	137	34.7
	33	64.0	14.2	80.0	18.3	96.0	22.9	104	25.5	112	28.2	128	34.0	135	36.0
	35	64.0	15.0	80.0	19.4	96.0	24.3	104	27.1	112	30.0	128	36.2	133	37.3
37	64.0	15.8	80.0	20.5	96.0	25.8	104	28.8	112	31.8	128	38.3	131	38.6	
39	64.0	16.7	80.0	21.7	96.0	27.4	104	30.5	112	33.8	125	39.6	128	39.9	
70% 91.00 kW	10	56.0	9.0	70.0	10.9	84.0	12.9	91.0	13.9	98.0	15.0	112	17.2	126	19.4
	12	56.0	9.1	70.0	11.0	84.0	13.1	91.0	14.1	98.0	15.2	112	17.5	126	19.8
	14	56.0	9.3	70.0	11.2	84.0	13.3	91.0	14.3	98.0	15.5	112	17.8	126	20.1
	16	56.0	9.4	70.0	11.4	84.0	13.5	91.0	14.6	98.0	15.7	112	18.1	126	20.5
	18	56.0	9.5	70.0	11.5	84.0	13.7	91.0	14.8	98.0	16.0	112	18.4	126	20.9
	20	56.0	9.7	70.0	11.7	84.0	13.9	91.0	15.1	98.0	16.3	112	18.7	126	21.7
	21	56.0	9.7	70.0	11.8	84.0	14.1	91.0	15.2	98.0	16.4	112	19.2	126	22.5
	23	56.0	9.9	70.0	12.0	84.0	14.3	91.0	15.7	98.0	17.2	112	20.5	126	24.0
	25	56.0	10.0	70.0	12.4	84.0	15.2	91.0	16.8	98.0	18.4	112	21.9	126	25.7
	27	56.0	10.4	70.0	13.1	84.0	16.2	91.0	17.8	98.0	19.6	112	23.3	126	27.4
	29	56.0	11.0	70.0	13.9	84.0	17.2	91.0	19.0	98.0	20.8	112	24.9	126	29.3
	31	56.0	11.7	70.0	14.8	84.0	18.3	91.0	20.2	98.0	22.2	112	26.5	126	31.2
	33	56.0	12.3	70.0	15.6	84.0	19.4	91.0	21.4	98.0	23.6	112	28.2	126	33.2
	35	56.0	13.0	70.0	16.6	84.0	20.5	91.0	22.7	98.0	25.0	112	30.0	126	35.4
37	56.0	13.7	70.0	17.5	84.0	21.8	91.0	24.1	98.0	26.6	112	31.8	126	37.6	
39	56.0	14.5	70.0	18.5	84.0	23.1	91.0	25.6	98.0	28.2	112	33.8	125	39.5	
60% 78.00 kW	10	48.0	8.05	60.0	9.5	72.0	11.2	78.0	12.0	84.0	12.9	96.0	14.7	108	16.5
	12	48.0	8.14	60.0	9.7	72.0	11.3	78.0	12.2	84.0	13.1	96.0	14.9	108	16.8
	14	48.0	8.24	60.0	9.8	72.0	11.5	78.0	12.4	84.0	13.3	96.0	15.1	108	17.1
	16	48.0	8.34	60.0	9.9	72.0	11.7	78.0	12.6	84.0	13.5	96.0	15.4	108	17.4
	18	48.0	8.4	60.0	10.1	72.0	11.8	78.0	12.8	84.0	13.7	96.0	15.7	108	17.7
	20	48.0	8.6	60.0	10.2	72.0	12.0	78.0	13.0	84.0	13.9	96.0	15.9	108	18.0
	21	48.0	8.6	60.0	10.3	72.0	12.1	78.0	13.1	84.0	14.1	96.0	16.1	108	18.3
	23	48.0	8.7	60.0	10.5	72.0	12.3	78.0	13.3	84.0	14.3	96.0	16.8	108	19.5
	25	48.0	8.9	60.0	10.6	72.0	12.8	78.0	14.0	84.0	15.2	96.0	17.9	108	20.8
	27	48.0	9.1	60.0	11.2	72.0	13.6	78.0	14.8	84.0	16.2	96.0	19.1	108	22.2
	29	48.0	9.6	60.0	11.8	72.0	14.4	78.0	15.8	84.0	17.2	96.0	20.3	108	23.7
	31	48.0	10.1	60.0	12.5	72.0	15.2	78.0	16.7	84.0	18.3	96.0	21.6	108	25.2
	33	48.0	10.7	60.0	13.2	72.0	16.1	78.0	17.7	84.0	19.4	96.0	22.9	108	26.8
	35	48.0	11.2	60.0	14.0	72.0	17.1	78.0	18.8	84.0	20.5	96.0	24.3	108	28.5
37	48.0	11.8	60.0	14.8	72.0	18.1	78.0	19.9	84.0	21.8	96.0	25.8	108	30.3	
39	48.0	12.4	60.0	15.6	72.0	19.1	78.0	21.1	84.0	23.1	96.0	27.4	108	32.2	
50% 65.00 kW	10	40.0	7.12	50.0	8.29	60.0	9.5	65.0	10.2	70.0	10.9	80.0	12.3	90.0	13.7
	12	40.0	7.20	50.0	8.39	60.0	9.7	65.0	10.3	70.0	11.0	80.0	12.5	90.0	14.0
	14	40.0	7.27	50.0	8.49	60.0	9.8	65.0	10.5	70.0	11.2	80.0	12.7	90.0	14.2
	16	40.0	7.35	50.0	8.60	60.0	9.9	65.0	10.6	70.0	11.4	80.0	12.9	90.0	14.4
	18	40.0	7.43	50.0	8.7	60.0	10.1	65.0	10.8	70.0	11.5	80.0	13.1	90.0	14.7
	20	40.0	7.52	50.0	8.8	60.0	10.2	65.0	11.0	70.0	11.7	80.0	13.3	90.0	14.9
	21	40.0	7.56	50.0	8.9	60.0	10.3	65.0	11.1	70.0	11.8	80.0	13.4	90.0	15.1
	23	40.0	7.65	50.0	9.0	60.0	10.5	65.0	11.2	70.0	12.0	80.0	13.6	90.0	15.5
	25	40.0	7.75	50.0	9.1	60.0	10.6	65.0	11.4	70.0	12.4	80.0	14.4	90.0	16.5
	27	40.0	7.85	50.0	9.4	60.0	11.2	65.0	12.1	70.0	13.1	80.0	15.3	90.0	17.6
	29	40.0	8.21	50.0	9.9	60.0	11.8	65.0	12.9	70.0	13.9	80.0	16.2	90.0	18.7
	31	40.0	8.7	50.0	10.5	60.0	12.5	65.0	13.6	70.0	14.8	80.0	17.2	90.0	19.9
	33	40.0	9.1	50.0	11.1	60.0	13.2	65.0	14.4	70.0	15.6	80.0	18.3	90.0	21.1
	35	40.0	9.6	50.0	11.7	60.0	14.0	65.0	15.2	70.0	16.6	80.0	19.4	90.0	22.4
37	40.0	10.1	50.0	12.3	60.0	14.8	65.0	16.1	70.0	17.5	80.0	20.5	90.0	23.8	
39	40.0	10.6	50.0	12.9	60.0	15.6	65.0	17.0	70.0	18.5	80.0	21.7	90.0	25.2	

3D079549

5 Таблицы производительности

5 - 1 Таблицы холодопроизводительности

RXYQ48T															
Indoor air temp. °CWB															
Combination(%) (Capacity index)	Outdoor air temp. (°CDB)	14.0		16.0		18.0		19.0		20.0		22.0		24.0	
		TC	PI	TC	PI	TC	PI	TC	PI	TC	PI	TC	PI	TC	PI
		KW	KW	KW	KW	KW	KW	KW	KW	KW	KW	KW	KW	KW	KW
130% 175.50 kW	10	108	16.7	135	21.2	162	25.8	170	26.7	173	26.1	178	24.7	183	23.4
	12	108	17.0	135	21.6	162	26.3	168	26.6	170	25.9	175	24.6	180	24.6
	14	108	17.3	135	21.9	162	26.8	166	26.4	168	25.8	173	25.7	178	26.0
	16	108	17.6	135	22.3	161	26.9	163	26.7	166	26.8	171	27.1	176	27.4
	18	108	17.9	135	22.8	159	27.8	161	28.0	164	28.2	169	28.5	174	28.8
	20	108	18.3	135	23.9	157	29.2	159	29.4	162	29.5	167	29.9	172	30.2
	21	108	18.4	135	24.7	155	29.9	158	30.1	160	30.2	166	30.6	171	30.9
	23	108	19.6	135	26.5	153	31.2	156	31.4	158	31.6	163	32.0	168	32.4
	25	108	20.9	135	28.3	151	32.6	154	32.8	156	33.0	161	33.4	166	33.8
	27	108	22.3	135	30.2	149	34.0	151	34.2	154	34.4	159	34.8	164	35.3
	29	108	23.7	135	32.2	147	35.4	149	35.6	152	35.8	157	36.3	162	36.7
	31	108	25.3	135	34.4	144	36.7	147	37.0	149	37.2	155	37.7	160	38.2
	33	108	26.9	135	36.6	142	38.1	145	38.4	147	38.6	152	39.1	157	39.6
	35	108	28.5	135	39.0	140	39.5	143	39.8	145	40.1	150	40.6	155	41.1
	37	108	30.3	133	40.4	138	40.9	140	41.2	143	41.5	148	42.1	153	42.6
	39	108	32.2	131	41.8	136	42.3	138	42.6	141	42.9	146	43.5	151	44.1
120% 162.00 kW	10	100	15.4	125	19.5	150	23.7	162	25.8	170	26.7	174	25.6	179	24.3
	12	100	15.7	125	19.8	150	24.1	162	26.3	168	26.6	172	25.4	177	24.4
	14	100	16.0	125	20.1	150	24.5	162	26.8	165	26.5	170	25.5	175	25.8
	16	100	16.2	125	20.5	150	25.0	161	26.9	163	26.6	168	26.9	173	27.2
	18	100	16.5	125	20.9	150	25.7	159	27.8	161	28.0	166	28.3	170	28.6
	20	100	16.8	125	21.4	150	27.6	157	29.2	159	29.4	164	29.7	168	30.0
	21	100	17.0	125	22.1	150	28.6	155	29.9	158	30.0	162	30.4	167	30.7
	23	100	17.7	125	23.7	150	30.6	153	31.2	156	31.4	160	31.8	165	32.1
	25	100	18.9	125	25.3	149	32.4	151	32.6	153	32.8	158	33.2	163	33.5
	27	100	20.1	125	27.0	147	33.8	149	34.0	151	34.2	156	34.6	160	35.0
	29	100	21.4	125	28.8	144	35.2	147	35.4	149	35.6	154	36.0	158	36.4
	31	100	22.7	125	30.7	142	36.5	144	36.7	147	37.0	151	37.4	156	37.8
	33	100	24.2	125	32.7	140	37.9	142	38.1	145	38.4	149	38.8	154	39.3
	35	100	25.7	125	34.8	138	39.3	140	39.5	142	39.8	147	40.3	152	40.8
	37	100	27.2	125	37.0	136	40.7	138	40.9	140	41.2	145	41.7	150	42.2
	39	100	28.9	125	39.3	133	42.1	136	42.3	138	42.6	143	43.2	147	43.7
110% 148.50 kW	10	91	14.2	114	17.7	137	21.5	149	23.5	160	25.5	171	26.3	176	25.3
	12	91	14.4	114	18.1	137	21.9	149	23.9	160	25.9	169	26.2	173	25.1
	14	91	14.6	114	18.4	137	22.3	149	24.3	160	26.4	167	26.1	171	25.6
	16	91	14.9	114	18.7	137	22.7	149	24.8	160	26.9	165	26.7	169	27.0
	18	91	15.1	114	19.0	137	23.1	149	25.4	158	27.8	163	28.1	167	28.4
	20	91	15.4	114	19.4	137	24.4	149	27.3	156	29.2	160	29.5	165	29.8
	21	91	15.5	114	19.7	137	25.2	149	28.3	155	29.9	159	30.2	164	30.5
	23	91	15.9	114	21.1	137	27.0	149	30.3	153	31.2	157	31.5	161	31.9
	25	91	17.0	114	22.5	137	28.9	149	32.4	151	32.6	155	32.9	159	33.3
	27	91	18.0	114	24.0	137	30.9	146	33.8	148	34.0	153	34.3	157	34.7
	29	91	19.2	114	25.6	137	32.9	144	35.1	146	35.3	151	35.7	155	36.1
	31	91	20.4	114	27.2	137	35.1	142	36.5	144	36.7	148	37.1	153	37.5
	33	91	21.6	114	29.0	137	37.4	140	37.9	142	38.1	146	38.5	150	38.9
	35	91	23.0	114	30.8	135	39.0	138	39.3	140	39.5	144	39.9	148	40.4
	37	91	24.3	114	32.7	133	40.4	135	40.7	137	40.9	142	41.4	146	41.8
	39	91	25.8	114	34.8	131	41.8	133	42.0	135	42.3	140	42.8	144	43.3
100% 135.00 kW	10	83.1	12.9	104	16.1	125	19.5	135	21.2	145	23.0	166	26.6	172	26.2
	12	83.1	13.1	104	16.4	125	19.8	135	21.6	145	23.4	166	27.0	170	26.0
	14	83.1	13.3	104	16.6	125	20.1	135	21.9	145	23.8	164	26.9	168	25.9
	16	83.1	13.6	104	16.9	125	20.5	135	22.3	145	24.2	162	26.7	166	26.8
	18	83.1	13.8	104	17.2	125	20.9	135	22.8	145	24.7	159	27.9	163	28.1
	20	83.1	14.0	104	17.5	125	21.4	135	23.9	145	26.5	157	29.3	161	29.5
	21	83.1	14.1	104	17.7	125	22.1	135	24.7	145	27.4	156	29.9	160	30.2
	23	83.1	14.4	104	18.6	125	23.7	135	26.5	145	29.4	154	31.3	158	31.6
	25	83.1	15.1	104	19.9	125	25.3	135	28.3	145	31.4	152	32.7	156	33.0
	27	83.1	16.1	104	21.2	125	27.0	135	30.2	145	33.6	150	34.0	154	34.4
	29	83.1	17.1	104	22.5	125	28.8	135	32.2	144	35.1	147	35.4	151	35.8
	31	83.1	18.2	104	24.0	125	30.7	135	34.4	141	36.5	145	36.8	149	37.2
	33	83.1	19.2	104	25.5	125	32.7	135	36.6	139	37.8	143	38.2	147	38.6
	35	83.1	20.4	104	27.1	125	34.8	135	39.0	137	39.2	141	39.6	145	40.0
	37	83.1	21.6	104	28.8	125	37.0	133	40.4	135	40.6	139	41.0	143	41.4
	39	83.1	22.9	104	30.5	125	39.3	131	41.8	133	42.0	136	42.4	140	42.9

NOTES - ANMERKUNGEN - Σημειώσεις - NOTAS - REMARQUES - NOTE - OPMERKINGEN - примечания - NOTLAR

- The above table shows the average value of conditions which may occur.
Die obige Tabelle zeigt den Durchschnittswert der Bedingungen, die auftreten können.
 Στον παραπάνω πίνακα αναγράφεται η μέση τιμή για συνθήκες που μπορεί να προκύψουν.
La tabla de arriba muestra el valor medio de condiciones que pueden ocurrir.
 Le tableau ci-dessus donne la valeur moyenne pour des conditions qui peuvent survenir.
La tabella in alto mostra il valore delle condizioni medie che si possono riscontrare.
 De tabel hierboven geeft de gemiddelde waarde aan van situaties die kunnen voorvallen.
Таблица расположенная выше показывает среднее значение условий, которые могут наступить.
 Yukarıdaki tablo meydana gelebilecek koşulların ortalama değerini göstermektedir.

3D079549

5 Таблицы производительности

5 - 1 Таблицы холодопроизводительности

RXYQ48T

Indoor air temp. °CWB

Combination(%) (Capacity index)	Outdoor air temp. (°CDB)	14.0		16.0		18.0		19.0		20.0		22.0		24.0	
		TC	PI	TC	PI	TC	PI	TC	PI	TC	PI	TC	PI	TC	PI
		KW	KW	KW	KW	KW	KW	KW	KW	KW	KW	KW	KW	KW	KW
90% 121.50 kW	10	74.8	11.8	93.5	14.5	112	17.4	122	18.9	131	20.5	150	23.7	168	26.9
	12	74.8	11.9	93.5	14.7	112	17.7	122	19.3	131	20.8	150	24.1	166	26.9
	14	74.8	12.1	93.5	15.0	112	18.0	122	19.6	131	21.2	150	24.5	164	26.8
	16	74.8	12.3	93.5	15.2	112	18.3	122	20.0	131	21.6	150	25.0	162	26.6
	18	74.8	12.5	93.5	15.5	112	18.7	122	20.3	131	22.0	150	25.7	160	27.9
	20	74.8	12.7	93.5	15.7	112	19.0	122	20.7	131	22.9	150	27.6	158	29.3
	21	74.8	12.8	93.5	15.9	112	19.3	122	21.4	131	23.7	150	28.6	157	30.0
	23	74.8	13.0	93.5	16.4	112	20.6	122	22.9	131	25.3	150	30.6	154	31.3
	25	74.8	13.5	93.5	17.4	112	22.0	122	24.4	131	27.1	149	32.4	152	32.7
	27	74.8	14.3	93.5	18.5	112	23.4	122	26.1	131	28.9	147	33.8	150	34.1
	29	74.8	15.2	93.5	19.7	112	24.9	122	27.8	131	30.8	144	35.2	148	35.5
	31	74.8	16.1	93.5	21.0	112	26.6	122	29.6	131	32.9	142	36.5	146	36.9
	33	74.8	17.0	93.5	22.3	112	28.2	122	31.5	131	35.0	140	37.9	143	38.3
	35	74.8	18.0	93.5	23.6	112	30.0	122	33.6	131	37.3	138	39.3	141	39.7
37	74.8	19.1	93.5	25.1	112	31.9	122	35.7	131	39.7	136	40.7	139	41.1	
39	74.8	20.2	93.5	26.6	112	33.9	122	37.9	130	41.7	133	42.1	137	42.5	
80% 108.00 kW	10	66.5	10.6	83.1	12.9	100	15.4	108	16.7	116	18.1	133	20.8	150	23.7
	12	66.5	10.8	83.1	13.1	100	15.7	108	17.0	116	18.4	133	21.2	150	24.1
	14	66.5	10.9	83.1	13.3	100	16.0	108	17.3	116	18.7	133	21.6	150	24.5
	16	66.5	11.1	83.1	13.6	100	16.2	108	17.6	116	19.0	133	22.0	150	25.0
	18	66.5	11.2	83.1	13.8	100	16.5	108	17.9	116	19.4	133	22.4	150	25.7
	20	66.5	11.4	83.1	14.0	100	16.8	108	18.3	116	19.8	133	23.4	150	27.6
	21	66.5	11.5	83.1	14.1	100	17.0	108	18.4	116	20.2	133	24.2	150	28.6
	23	66.5	11.7	83.1	14.4	100	17.7	108	19.6	116	21.6	133	25.9	150	30.6
	25	66.5	11.9	83.1	15.1	100	18.9	108	20.9	116	23.1	133	27.7	149	32.4
	27	66.5	12.6	83.1	16.1	100	20.1	108	22.3	116	24.6	133	29.5	147	33.8
	29	66.5	13.3	83.1	17.1	100	21.4	108	23.7	116	26.2	133	31.5	144	35.2
	31	66.5	14.1	83.1	18.2	100	22.7	108	25.3	116	27.9	133	33.6	142	36.5
	33	66.5	14.9	83.1	19.2	100	24.2	108	26.9	116	29.7	133	35.8	140	37.9
	35	66.5	15.8	83.1	20.4	100	25.7	108	28.5	116	31.6	133	38.1	138	39.3
37	66.5	16.7	83.1	21.6	100	27.2	108	30.3	116	33.6	132	40.3	136	40.7	
39	66.5	17.6	83.1	22.9	100	28.9	108	32.2	116	35.7	130	41.7	133	42.1	
70% 94.50 kW	10	58.2	9.5	72.7	11.5	87.2	13.6	94.5	14.6	102	15.8	116	18.1	131	20.5
	12	58.2	9.6	72.7	11.6	87.2	13.8	94.5	14.9	102	16.0	116	18.4	131	20.8
	14	58.2	9.8	72.7	11.8	87.2	14.0	94.5	15.1	102	16.3	116	18.7	131	21.1
	16	58.2	9.9	72.7	12.0	87.2	14.2	94.5	15.4	102	16.6	116	19.0	131	21.6
	18	58.2	10.0	72.7	12.2	87.2	14.4	94.5	15.6	102	16.9	116	19.4	131	22.0
	20	58.2	10.2	72.7	12.4	87.2	14.7	94.5	15.9	102	17.2	116	19.8	131	22.9
	21	58.2	10.3	72.7	12.5	87.2	14.8	94.5	16.1	102	17.3	116	20.2	131	23.7
	23	58.2	10.4	72.7	12.7	87.2	15.1	94.5	16.6	102	18.2	116	21.6	131	25.3
	25	58.2	10.6	72.7	13.0	87.2	16.0	94.5	17.7	102	19.4	116	23.1	131	27.1
	27	58.2	11.0	72.7	13.8	87.2	17.1	94.5	18.8	102	20.6	116	24.6	131	28.9
	29	58.2	11.6	72.7	14.7	87.2	18.1	94.5	20.0	102	22.0	116	26.2	131	30.8
	31	58.2	12.3	72.7	15.6	87.2	19.2	94.5	21.2	102	23.4	116	27.9	131	32.9
	33	58.2	13.0	72.7	16.5	87.2	20.4	94.5	22.6	102	24.8	116	29.7	131	35.0
	35	58.2	13.7	72.7	17.4	87.2	21.7	94.5	24.0	102	26.4	116	31.6	131	37.3
37	58.2	14.5	72.7	18.5	87.2	23.0	94.5	25.4	102	28.0	116	33.6	131	39.7	
39	58.2	15.3	72.7	19.5	87.2	24.3	94.5	27.0	102	29.7	116	35.7	130	41.7	
60% 81.00 kW	10	49.8	8.5	62.3	10.1	74.8	11.8	81.0	12.6	87.2	13.6	99.7	15.4	112	17.4
	12	49.8	8.6	62.3	10.2	74.8	11.9	81.0	12.8	87.2	13.8	99.7	15.7	112	17.7
	14	49.8	8.7	62.3	10.3	74.8	12.1	81.0	13.0	87.2	14.0	99.7	16.0	112	18.0
	16	49.8	8.8	62.3	10.5	74.8	12.3	81.0	13.2	87.2	14.2	99.7	16.2	112	18.3
	18	49.8	8.9	62.3	10.6	74.8	12.5	81.0	13.5	87.2	14.4	99.7	16.5	112	18.7
	20	49.8	9.0	62.3	10.8	74.8	12.7	81.0	13.7	87.2	14.7	99.7	16.8	112	19.0
	21	49.8	9.1	62.3	10.9	74.8	12.8	81.0	13.8	87.2	14.8	99.7	17.0	112	19.3
	23	49.8	9.2	62.3	11.0	74.8	13.0	81.0	14.0	87.2	15.1	99.7	17.7	112	20.6
	25	49.8	9.3	62.3	11.2	74.8	13.5	81.0	14.7	87.2	16.0	99.7	18.9	112	22.0
	27	49.8	9.5	62.3	11.8	74.8	14.3	81.0	15.6	87.2	17.1	99.7	20.1	112	23.4
	29	49.8	10.1	62.3	12.5	74.8	15.2	81.0	16.6	87.2	18.1	99.7	21.4	112	24.9
	31	49.8	10.6	62.3	13.2	74.8	16.1	81.0	17.6	87.2	19.2	99.7	22.7	112	26.6
	33	49.8	11.2	62.3	14.0	74.8	17.0	81.0	18.7	87.2	20.4	99.7	24.2	112	28.2
	35	49.8	11.8	62.3	14.7	74.8	18.0	81.0	19.8	87.2	21.7	99.7	25.7	112	30.0
37	49.8	12.5	62.3	15.6	74.8	19.1	81.0	21.0	87.2	23.0	99.7	27.2	112	31.9	
39	49.8	13.1	62.3	16.4	74.8	20.2	81.0	22.2	87.2	24.3	99.7	28.9	112	33.9	
50% 67.50 kW	10	41.5	7.51	51.9	8.7	62.3	10.1	67.5	10.8	72.7	11.5	83.1	12.9	93.5	14.5
	12	41.5	7.59	51.9	8.8	62.3	10.2	67.5	10.9	72.7	11.6	83.1	13.1	93.5	14.7
	14	41.5	7.67	51.9	9.0	62.3	10.3	67.5	11.1	72.7	11.8	83.1	13.3	93.5	15.0
	16	41.5	7.75	51.9	9.1	62.3	10.5	67.5	11.2	72.7	12.0	83.1	13.6	93.5	15.2
	18	41.5	7.84	51.9	9.2	62.3	10.6	67.5	11.4	72.7	12.2	83.1	13.8	93.5	15.5
	20	41.5	7.93	51.9	9.3	62.3	10.8	67.5	11.6	72.7	12.4	83.1	14.0	93.5	15.7
	21	41.5	7.97	51.9	9.4	62.3	10.9	67.5	11.6	72.7	12.5	83.1	14.1	93.5	15.9
	23	41.5	8.07	51.9	9.5	62.3	11.0	67.5	11.8	72.7	12.7	83.1	14.4	93.5	16.4
	25	41.5	8.17	51.9	9.6	62.3	11.2	67.5	12.1	72.7	13.0	83.1	15.1	93.5	17.4
	27	41.5	8.27	51.9	9.9	62.3	11.8	67.5	12.8	72.7	13.8	83.1	16.1	93.5	18.5
	29	41.5	8.7	51.9	10.5	62.3	12.5	67.5	13.6	72.7	14.7	83.1	17.1	93.5	19.7
	31	41.5	9.1	51.9	11.0	62.3	13.2	67.5	14.4	72.7	15.6	83.1	18.2	93.5	21.0
	33	41.5	9.6	51.9	11.7	62.3	14.0	67.5	15.2	72.7	16.5	83.1	19.2	93.5	22.3
	35	41.5	10.1	51.9	12.3	62.3	14.7	67.5	16.1	72.7	17.4	83.1	20.4	93.5	23.6
37	41.5	10.6	51.9	13.0	62.3	15.6	67.5	17.0	72.7	18.5	83.1	21.6	93.5	25.1	
39	41.5	11.1	51.9	13.6	62.3	16.4	67.5	17.9	72.7	19.5	83.1	22.9	93.5	26.6	

3D079549

5 Таблицы производительности

5 - 1 Таблицы холодопроизводительности

RXYQ50T																
Indoor air temp. °CWB																
Combination(%) (Capacity index)	Outdoor air temp. (°CDB)	14.0		16.0		18.0		19.0		20.0		22.0		24.0		
		TC	PI	TC	PI	TC	PI	TC	PI	TC	PI	TC	PI	TC	PI	
		KW		KW		KW		KW		KW		KW		KW		KW
130% 182.00 kW	10	112	17.5	140	22.1	168	27.0	176	27.9	179	27.2	184	25.8	189	24.4	
	12	112	17.8	140	22.5	168	27.4	174	27.7	177	27.0	182	25.6	187	25.7	
	14	112	18.1	140	22.9	168	27.9	172	27.6	174	26.9	180	26.8	185	27.1	
	16	112	18.4	140	23.3	167	28.1	169	27.8	172	28.0	177	28.3	183	28.6	
	18	112	18.7	140	23.8	165	29.1	167	29.2	170	29.4	175	29.7	180	30.1	
	20	112	19.1	140	24.9	162	30.5	165	30.7	168	30.8	173	31.2	178	31.6	
	21	112	19.2	140	25.8	161	31.2	164	31.4	166	31.6	172	31.9	177	32.3	
	23	112	20.5	140	27.6	159	32.6	162	32.8	164	33.0	169	33.4	175	33.8	
	25	112	21.8	140	29.5	157	34.0	159	34.2	162	34.5	167	34.9	172	35.3	
	27	112	23.3	140	31.5	154	35.5	157	35.7	160	35.9	165	36.4	170	36.8	
	29	112	24.8	140	33.6	152	36.9	155	37.1	157	37.4	163	37.8	168	38.3	
	31	112	26.4	140	35.9	150	38.3	152	38.6	155	38.8	160	39.3	166	39.8	
	33	112	28.0	140	38.2	148	39.8	150	40.1	153	40.3	158	40.8	163	41.4	
	35	112	29.8	140	40.7	145	41.3	148	41.5	150	41.8	156	42.4	161	42.9	
	37	112	31.6	138	42.1	143	42.7	146	43.0	148	43.3	153	43.9	159	44.5	
	39	112	33.6	135	43.6	141	44.2	143	44.5	146	44.8	151	45.4	156	46.0	
	120% 168.00 kW	10	103	16.1	129	20.3	155	24.7	168	27.0	176	27.9	181	26.7	186	25.4
		12	103	16.4	129	20.7	155	25.1	168	27.4	174	27.8	179	26.5	184	25.5
14		103	16.7	129	21.0	155	25.6	168	27.9	172	27.6	176	26.7	181	26.9	
16		103	16.9	129	21.4	155	26.1	167	28.1	169	27.8	174	28.1	179	28.4	
18		103	17.2	129	21.8	155	26.8	165	29.1	167	29.2	172	29.5	177	29.8	
20		103	17.5	129	22.3	155	28.8	162	30.5	165	30.6	170	31.0	174	31.3	
21		103	17.7	129	23.1	155	29.8	161	31.2	164	31.4	168	31.7	173	32.0	
23		103	18.5	129	24.7	155	31.9	159	32.6	161	32.8	166	33.2	171	33.5	
25		103	19.7	129	26.4	154	33.8	157	34.0	159	34.2	164	34.6	169	35.0	
27		103	21.0	129	28.2	152	35.3	154	35.5	157	35.7	162	36.1	166	36.5	
29		103	22.3	129	30.1	150	36.7	152	36.9	154	37.1	159	37.6	164	38.0	
31		103	23.7	129	32.0	147	38.1	150	38.3	152	38.6	157	39.0	162	39.5	
33		103	25.2	129	34.1	145	39.6	148	39.8	150	40.0	155	40.5	160	41.0	
35		103	26.8	129	36.3	143	41.0	145	41.3	148	41.5	152	42.0	157	42.5	
37		103	28.4	129	38.6	141	42.4	143	42.7	145	43.0	150	43.5	155	44.1	
39		103	30.2	129	41.1	138	43.9	141	44.2	143	44.5	148	45.0	153	45.6	
110% 154.00 kW		10	95	14.8	118	18.5	142	22.5	154	24.5	166	26.6	178	27.5	182	26.4
		12	95	15.0	118	18.8	142	22.9	154	25.0	166	27.1	175	27.4	180	26.2
	14	95	15.3	118	19.2	142	23.3	154	25.4	166	27.5	173	27.2	178	26.7	
	16	95	15.5	118	19.5	142	23.7	154	25.9	166	28.0	171	27.9	175	28.2	
	18	95	15.8	118	19.9	142	24.2	154	26.5	164	29.0	169	29.3	173	29.6	
	20	95	16.1	118	20.2	142	25.5	154	28.5	162	30.5	166	30.8	171	31.1	
	21	95	16.2	118	20.6	142	26.3	154	29.5	161	31.2	165	31.5	170	31.8	
	23	95	16.6	118	22.0	142	28.2	154	31.6	159	32.6	163	32.9	167	33.2	
	25	95	17.7	118	23.5	142	30.2	154	33.8	156	34.0	161	34.4	165	34.7	
	27	95	18.8	118	25.0	142	32.2	152	35.2	154	35.4	158	35.8	163	36.2	
	29	95	20.0	118	26.7	142	34.4	149	36.7	152	36.9	156	37.3	161	37.7	
	31	95	21.3	118	28.4	142	36.7	147	38.1	149	38.3	154	38.7	158	39.1	
	33	95	22.6	118	30.2	142	39.1	145	39.5	147	39.8	152	40.2	156	40.6	
	35	95	24.0	118	32.1	140	40.7	143	41.0	145	41.2	149	41.7	154	42.1	
	37	95	25.4	118	34.2	138	42.2	140	42.4	143	42.7	147	43.2	151	43.7	
	39	95	26.9	118	36.3	136	43.6	138	43.9	140	44.1	145	44.7	149	45.2	
	100% 140.00 kW	10	86.2	13.5	108	16.8	129	20.3	140	22.1	151	24.0	172	27.7	179	27.3
		12	86.2	13.7	108	17.1	129	20.7	140	22.5	151	24.4	172	28.2	176	27.1
14		86.2	13.9	108	17.4	129	21.0	140	22.9	151	24.8	170	28.0	174	27.0	
16		86.2	14.1	108	17.7	129	21.4	140	23.3	151	25.3	168	27.9	172	27.9	
18		86.2	14.4	108	18.0	129	21.8	140	23.8	151	25.8	165	29.1	169	29.4	
20		86.2	14.6	108	18.3	129	22.3	140	24.9	151	27.7	163	30.5	167	30.8	
21		86.2	14.7	108	18.5	129	23.1	140	25.8	151	28.6	162	31.2	166	31.5	
23		86.2	15.0	108	19.4	129	24.7	140	27.6	151	30.7	160	32.7	164	33.0	
25		86.2	15.8	108	20.7	129	26.4	140	29.5	151	32.8	157	34.1	161	34.4	
27		86.2	16.8	108	22.1	129	28.2	140	31.5	151	35.1	155	35.5	159	35.9	
29		86.2	17.8	108	23.5	129	30.1	140	33.6	149	36.6	153	37.0	157	37.3	
31		86.2	18.9	108	25.0	129	32.0	140	35.9	147	38.0	151	38.4	155	38.8	
33		86.2	20.1	108	26.6	129	34.1	140	38.2	144	39.5	148	39.9	152	40.3	
35		86.2	21.3	108	28.3	129	36.3	140	40.7	142	40.9	146	41.3	150	41.8	
37		86.2	22.6	108	30.0	129	38.6	138	42.1	140	42.4	144	42.8	148	43.3	
39		86.2	23.9	108	31.9	129	41.1	135	43.6	137	43.8	141	44.3	146	44.8	

NOTES - ANMERKUNGEN - Σημειώσεις - NOTAS - REMARQUES - NOTE - OPMERKINGEN - примечания - NOTLAR

- The above table shows the average value of conditions which may occur.
Die obige Tabelle zeigt den Durchschnittswert der Bedingungen, die auftreten können.
 Στον παραπάνω πίνακα αναγράφεται η μέση τιμή για συνθήκες που μπορεί να προκύψουν.
La tabla de arriba muestra el valor medio de condiciones que pueden ocurrir.
 Le tableau ci-dessus donne la valeur moyenne pour des conditions qui peuvent survenir.
La tabella in alto mostra il valore delle condizioni medie che si possono riscontrare.
 De tabel hierboven geeft de gemiddelde waarde aan van situaties die kunnen voorvallen.
Таблица расположенная выше показывает среднее значение условий, которые могут наступить.
 Yukarıdaki tablo meydana gelebilecek koşulların ortalama değerini göstermektedir.

3D079549

5 Таблицы производительности

5 - 1 Таблицы холодопроизводительности

5

RXYQ50T															
Indoor air temp. °CWB															
Combination(%) (Capacity index)	Outdoor air temp. (°CDB)	14.0		16.0		18.0		19.0		20.0		22.0		24.0	
		TC	PI	TC	PI	TC	PI	TC	PI	TC	PI	TC	PI	TC	PI
		KW	KW	KW	KW	KW	KW	KW	KW	KW	KW	KW	KW	KW	KW
90% 126.00 kW	10	77.5	12.3	96.9	15.1	116	18.2	126	19.8	136	21.4	155	24.7	174	28.1
	12	77.5	12.4	96.9	15.4	116	18.5	126	20.1	136	21.8	155	25.1	173	28.1
	14	77.5	12.6	96.9	15.6	116	18.8	126	20.5	136	22.1	155	25.6	170	27.9
	16	77.5	12.8	96.9	15.9	116	19.1	126	20.8	136	22.5	155	26.1	168	27.8
	18	77.5	13.0	96.9	16.1	116	19.5	126	21.2	136	23.0	155	26.8	166	29.1
	20	77.5	13.2	96.9	16.4	116	19.8	126	21.6	136	23.9	155	28.8	164	30.6
	21	77.5	13.3	96.9	16.6	116	20.1	126	22.3	136	24.7	155	29.8	162	31.3
	23	77.5	13.6	96.9	17.1	116	21.5	126	23.9	136	26.4	155	31.9	160	32.7
	25	77.5	14.0	96.9	18.2	116	22.9	126	25.5	136	28.3	154	33.8	158	34.1
	27	77.5	14.9	96.9	19.4	116	24.4	126	27.2	136	30.2	152	35.3	156	35.6
	29	77.5	15.8	96.9	20.6	116	26.0	126	29.0	136	32.2	150	36.7	153	37.0
	31	77.5	16.8	96.9	21.9	116	27.7	126	30.9	136	34.3	147	38.1	151	38.5
	33	77.5	17.8	96.9	23.2	116	29.5	126	32.9	136	36.5	145	39.6	149	39.9
	35	77.5	18.8	96.9	24.6	116	31.3	126	35.0	136	38.9	143	41.0	146	41.4
37	77.5	19.9	96.9	26.1	116	33.3	126	37.2	136	41.4	141	42.4	144	42.9	
39	77.5	21.0	96.9	27.7	116	35.4	126	39.6	135	43.5	138	43.9	142	44.3	
80% 112.00 kW	10	68.9	11.1	86.2	13.5	103	16.1	112	17.5	121	18.9	138	21.7	155	24.7
	12	68.9	11.2	86.2	13.7	103	16.4	112	17.8	121	19.2	138	22.1	155	25.1
	14	68.9	11.4	86.2	13.9	103	16.7	112	18.1	121	19.5	138	22.5	155	25.6
	16	68.9	11.5	86.2	14.1	103	16.9	112	18.4	121	19.9	138	22.9	155	26.1
	18	68.9	11.7	86.2	14.4	103	17.2	112	18.7	121	20.2	138	23.4	155	26.8
	20	68.9	11.9	86.2	14.6	103	17.5	112	19.1	121	20.6	138	24.4	155	28.8
	21	68.9	12.0	86.2	14.7	103	17.7	112	19.2	121	21.1	138	25.2	155	29.8
	23	68.9	12.2	86.2	15.0	103	18.5	112	20.5	121	22.5	138	27.0	155	31.9
	25	68.9	12.4	86.2	15.8	103	19.7	112	21.8	121	24.1	138	28.9	154	33.8
	27	68.9	13.1	86.2	16.8	103	21.0	112	23.3	121	25.7	138	30.8	152	35.3
	29	68.9	13.9	86.2	17.8	103	22.3	112	24.8	121	27.3	138	32.9	150	36.7
	31	68.9	14.7	86.2	18.9	103	23.7	112	26.4	121	29.1	138	35.1	147	38.1
	33	68.9	15.6	86.2	20.1	103	25.2	112	28.0	121	31.0	138	37.4	145	39.6
	35	68.9	16.5	86.2	21.3	103	26.8	112	29.8	121	33.0	138	39.8	143	41.0
37	68.9	17.4	86.2	22.6	103	28.4	112	31.6	121	35.0	137	42.1	141	42.4	
39	68.9	18.4	86.2	23.9	103	30.2	112	33.6	121	37.2	135	43.5	138	43.9	
70% 98.00 kW	10	60.3	9.9	75.4	12.0	90.5	14.1	98.0	15.3	106	16.5	121	18.9	136	21.4
	12	60.3	10.1	75.4	12.1	90.5	14.4	98.0	15.5	106	16.7	121	19.2	136	21.8
	14	60.3	10.2	75.4	12.3	90.5	14.6	98.0	15.8	106	17.0	121	19.5	136	22.1
	16	60.3	10.3	75.4	12.5	90.5	14.8	98.0	16.0	106	17.3	121	19.9	136	22.5
	18	60.3	10.5	75.4	12.7	90.5	15.1	98.0	16.3	106	17.6	121	20.2	136	23.0
	20	60.3	10.6	75.4	12.9	90.5	15.3	98.0	16.6	106	17.9	121	20.6	136	23.9
	21	60.3	10.7	75.4	13.0	90.5	15.5	98.0	16.8	106	18.1	121	21.1	136	24.7
	23	60.3	10.9	75.4	13.2	90.5	15.7	98.0	17.3	106	19.0	121	22.5	136	26.4
	25	60.3	11.0	75.4	13.6	90.5	16.7	98.0	18.4	106	20.2	121	24.1	136	28.3
	27	60.3	11.5	75.4	14.5	90.5	17.8	98.0	19.6	106	21.5	121	25.7	136	30.2
	29	60.3	12.2	75.4	15.3	90.5	18.9	98.0	20.9	106	22.9	121	27.3	136	32.2
	31	60.3	12.8	75.4	16.2	90.5	20.1	98.0	22.2	106	24.4	121	29.1	136	34.3
	33	60.3	13.6	75.4	17.2	90.5	21.3	98.0	23.5	106	25.9	121	31.0	136	36.5
	35	60.3	14.3	75.4	18.2	90.5	22.6	98.0	25.0	106	27.5	121	33.0	136	38.9
37	60.3	15.1	75.4	19.3	90.5	24.0	98.0	26.5	106	29.2	121	35.0	136	41.4	
39	60.3	15.9	75.4	20.4	90.5	25.4	98.0	28.1	106	31.0	121	37.2	135	43.5	
60% 84.00 kW	10	51.7	8.9	64.6	10.5	77.5	12.3	84.0	13.2	90.5	14.1	103.4	16.1	116	18.2
	12	51.7	9.0	64.6	10.6	77.5	12.4	84.0	13.4	90.5	14.4	103.4	16.4	116	18.5
	14	51.7	9.1	64.6	10.8	77.5	12.6	84.0	13.6	90.5	14.6	103.4	16.7	116	18.8
	16	51.7	9.2	64.6	10.9	77.5	12.8	84.0	13.8	90.5	14.8	103.4	16.9	116	19.1
	18	51.7	9.3	64.6	11.1	77.5	13.0	84.0	14.0	90.5	15.1	103.4	17.2	116	19.5
	20	51.7	9.4	64.6	11.3	77.5	13.2	84.0	14.3	90.5	15.3	103.4	17.5	116	19.8
	21	51.7	9.5	64.6	11.3	77.5	13.3	84.0	14.4	90.5	15.5	103.4	17.7	116	20.1
	23	51.7	9.6	64.6	11.5	77.5	13.6	84.0	14.6	90.5	15.7	103.4	18.5	116	21.5
	25	51.7	9.7	64.6	11.7	77.5	14.0	84.0	15.4	90.5	16.7	103.4	19.7	116	22.9
	27	51.7	10.0	64.6	12.3	77.5	14.9	84.0	16.3	90.5	17.8	103.4	21.0	116	24.4
	29	51.7	10.5	64.6	13.0	77.5	15.8	84.0	17.3	90.5	18.9	103.4	22.3	116	26.0
	31	51.7	11.1	64.6	13.8	77.5	16.8	84.0	18.4	90.5	20.1	103.4	23.7	116	27.7
	33	51.7	11.7	64.6	14.6	77.5	17.8	84.0	19.5	90.5	21.3	103.4	25.2	116	29.5
	35	51.7	12.3	64.6	15.4	77.5	18.8	84.0	20.7	90.5	22.6	103.4	26.8	116	31.3
37	51.7	13.0	64.6	16.2	77.5	19.9	84.0	21.9	90.5	24.0	103.4	28.4	116	33.3	
39	51.7	13.7	64.6	17.2	77.5	21.0	84.0	23.2	90.5	25.4	103.4	30.2	116	35.4	
50% 70.00 kW	10	43.1	7.84	53.8	9.1	64.6	10.5	70.0	11.2	75.4	12.0	86.2	13.5	96.9	15.1
	12	43.1	7.92	53.8	9.2	64.6	10.6	70.0	11.4	75.4	12.1	86.2	13.7	96.9	15.4
	14	43.1	8.00	53.8	9.3	64.6	10.8	70.0	11.5	75.4	12.3	86.2	13.9	96.9	15.6
	16	43.1	8.09	53.8	9.5	64.6	10.9	70.0	11.7	75.4	12.5	86.2	14.1	96.9	15.9
	18	43.1	8.18	53.8	9.6	64.6	11.1	70.0	11.9	75.4	12.7	86.2	14.4	96.9	16.1
	20	43.1	8.27	53.8	9.7	64.6	11.3	70.0	12.1	75.4	12.9	86.2	14.6	96.9	16.4
	21	43.1	8.32	53.8	9.8	64.6	11.3	70.0	12.2	75.4	13.0	86.2	14.7	96.9	16.6
	23	43.1	8.42	53.8	9.9	64.6	11.5	70.0	12.3	75.4	13.2	86.2	15.0	96.9	17.1
	25	43.1	8.52	53.8	10.1	64.6	11.7	70.0	12.6	75.4	13.6	86.2	15.8	96.9	18.2
	27	43.1	8.63	53.8	10.3	64.6	12.3	70.0	13.3	75.4	14.5	86.2	16.8	96.9	19.4
	29	43.1	9.0	53.8	10.9	64.6	13.0	70.0	14.1	75.4	15.3	86.2	17.8	96.9	20.6
	31	43.1	9.5	53.8	11.5	64.6	13.8	70.0	15.0	75.4	16.2	86.2	18.9	96.9	21.9
	33	43.1	10.0	53.8	12.2	64.6	14.6	70.0	15.9	75.4	17.2	86.2	20.1	96.9	23.2
	35	43.1	10.5	53.8	12.8	64.6	15.4	70.0	16.8	75.4	18.2	86.2	21.3	96.9	24.6
37	43.1	11.1	53.8	13.5	64.6	16.2	70.0	17.7	75.4	19.3	86.2	22.6	96.9	26.1	
39	43.1	11.6	53.8	14.2	64.6	17.2	70.0	18.7	75.4	20.4	86.2	23.9	96.9	27.7	

3D079549

5 Таблицы производительности

5 - 1 Таблицы холодопроизводительности

RXYQ52T															
Indoor air temp. °CWB															
Combination(%) (Capacity index)	Outdoor air temp. (°CDB)	14.0		16.0		18.0		19.0		20.0		22.0		24.0	
		TC	PI	TC	PI	TC	PI	TC	PI	TC	PI	TC	PI	TC	PI
		KW		KW		KW		KW		KW		KW		KW	
130% 188.50 kW	10	116	18.2	145	23.0	174	28.1	183	29.0	185	28.3	191	26.9	196	25.4
	12	116	18.5	145	23.4	174	28.6	180	28.9	183	28.2	188	26.7	194	26.7
	14	116	18.8	145	23.9	174	29.1	178	28.7	181	28.0	186	28.0	191	28.3
	16	116	19.2	145	24.3	173	29.3	176	29.0	178	29.1	184	29.5	189	29.8
	18	116	19.5	145	24.7	170	30.3	173	30.5	176	30.6	181	31.0	187	31.3
	20	116	19.9	145	26.0	168	31.8	171	31.9	174	32.1	179	32.5	184	32.9
	21	116	20.0	145	26.9	167	32.5	170	32.7	172	32.9	178	33.3	183	33.6
	23	116	21.3	145	28.8	165	34.0	167	34.2	170	34.4	175	34.8	181	35.2
	25	116	22.7	145	30.7	162	35.5	165	35.7	168	35.9	173	36.3	178	36.8
	27	116	24.2	145	32.8	160	36.9	163	37.2	165	37.4	171	37.9	176	38.3
	29	116	25.8	145	35.0	158	38.4	160	38.7	163	38.9	168	39.4	174	39.9
	31	116	27.5	145	37.4	155	39.9	158	40.2	161	40.5	166	41.0	171	41.5
	33	116	29.2	145	39.8	153	41.5	155	41.7	158	42.0	164	42.6	169	43.1
	35	116	31.0	145	42.4	150	43.0	153	43.3	156	43.6	161	44.1	167	44.7
	37	116	33.0	143	43.9	148	44.5	151	44.8	153	45.1	159	45.7	164	46.3
	39	116	35.0	140	45.4	146	46.0	148	46.4	151	46.7	157	47.3	162	48.0
120% 174.00 kW	10	107	16.8	134	21.1	161	25.7	174	28.1	182	29.1	187	27.8	192	26.5
	12	107	17.1	134	21.5	161	26.2	174	28.6	180	28.9	185	27.6	190	26.5
	14	107	17.3	134	21.9	161	26.7	174	29.1	178	28.8	183	27.8	188	28.1
	16	107	17.6	134	22.3	161	27.2	173	29.3	175	29.0	180	29.3	185	29.6
	18	107	18.0	134	22.7	161	27.9	170	30.3	173	30.4	178	30.8	183	31.1
	20	107	18.3	134	23.3	161	30.0	168	31.8	171	31.9	176	32.3	181	32.6
	21	107	18.4	134	24.1	161	31.1	167	32.5	169	32.7	174	33.0	179	33.4
	23	107	19.2	134	25.8	161	33.3	165	34.0	167	34.2	172	34.5	177	34.9
	25	107	20.5	134	27.5	160	35.3	162	35.5	165	35.7	170	36.1	175	36.5
	27	107	21.9	134	29.4	157	36.7	160	36.9	162	37.2	167	37.6	172	38.0
	29	107	23.3	134	31.3	155	38.2	158	38.4	160	38.7	165	39.1	170	39.6
	31	107	24.7	134	33.4	153	39.7	155	39.9	158	40.2	163	40.7	168	41.1
	33	107	26.3	134	35.5	150	41.2	153	41.5	155	41.7	160	42.2	165	42.7
	35	107	27.9	134	37.8	148	42.7	150	43.0	153	43.2	158	43.8	163	44.3
	37	107	29.6	134	40.2	146	44.2	148	44.5	151	44.8	156	45.3	161	45.9
	39	107	31.4	134	42.8	143	45.7	146	46.0	148	46.3	153	46.9	158	47.5
110% 159.50 kW	10	98	15.4	123	19.3	147	23.4	160	25.5	172	27.7	184	28.6	189	27.5
	12	98	15.7	123	19.6	147	23.8	160	26.0	172	28.2	182	28.5	186	27.3
	14	98	15.9	123	20.0	147	24.3	160	26.5	172	28.7	179	28.3	184	27.8
	16	98	16.2	123	20.3	147	24.7	160	26.9	172	29.2	177	29.1	182	29.3
	18	98	16.4	123	20.7	147	25.2	160	27.7	170	30.3	175	30.5	179	30.8
	20	98	16.7	123	21.1	147	26.5	160	29.7	168	31.7	172	32.0	177	32.4
	21	98	16.9	123	21.4	147	27.4	160	30.7	167	32.5	171	32.8	176	33.1
	23	98	17.3	123	22.9	147	29.4	160	32.9	164	33.9	169	34.3	173	34.6
	25	98	18.4	123	24.5	147	31.4	160	35.2	162	35.4	166	35.8	171	36.2
	27	98	19.6	123	26.1	147	33.6	157	36.7	159	36.9	164	37.3	169	37.7
	29	98	20.9	123	27.8	147	35.8	155	38.2	157	38.4	162	38.8	166	39.2
	31	98	22.2	123	29.6	147	38.2	152	39.7	155	39.9	159	40.3	164	40.8
	33	98	23.5	123	31.5	147	40.7	150	41.2	152	41.4	157	41.9	162	42.3
	35	98	25.0	123	33.5	145	42.4	148	42.7	150	42.9	155	43.4	159	43.9
	37	98	26.5	123	35.6	143	43.9	145	44.2	148	44.5	152	45.0	157	45.5
	39	98	28.1	123	37.8	141	45.4	143	45.7	145	46.0	150	46.5	154	47.1
100% 145.00 kW	10	89.2	14.1	112	17.5	134	21.1	145	23.0	156	25.0	178	28.9	185	28.4
	12	89.2	14.3	112	17.8	134	21.5	145	23.4	156	25.4	178	29.4	183	28.3
	14	89.2	14.5	112	18.1	134	21.9	145	23.9	156	25.9	176	29.2	180	28.1
	16	89.2	14.7	112	18.4	134	22.3	145	24.3	156	26.3	174	29.1	178	29.1
	18	89.2	15.0	112	18.7	134	22.7	145	24.7	156	26.8	171	30.3	175	30.6
	20	89.2	15.2	112	19.1	134	23.3	145	26.0	156	28.8	169	31.8	173	32.1
	21	89.2	15.4	112	19.2	134	24.1	145	26.9	156	29.8	168	32.5	172	32.8
	23	89.2	15.6	112	20.3	134	25.8	145	28.8	156	31.9	165	34.0	170	34.3
	25	89.2	16.5	112	21.6	134	27.5	145	30.7	156	34.2	163	35.5	167	35.9
	27	89.2	17.5	112	23.0	134	29.4	145	32.8	156	36.5	161	37.0	165	37.4
	29	89.2	18.6	112	24.5	134	31.3	145	35.0	154	38.1	158	38.5	163	38.9
	31	89.2	19.7	112	26.1	134	33.4	145	37.4	152	39.6	156	40.0	160	40.4
	33	89.2	20.9	112	27.7	134	35.5	145	39.8	149	41.1	154	41.5	158	42.0
	35	89.2	22.2	112	29.4	134	37.8	145	42.4	147	42.6	151	43.1	155	43.5
	37	89.2	23.5	112	31.3	134	40.2	143	43.9	145	44.1	149	44.6	153	45.1
	39	89.2	24.9	112	33.2	134	42.8	140	45.4	142	45.6	147	46.1	151	46.6

NOTES - ANMERKUNGEN - Σημειώσεις - NOTAS - REMARQUES - NOTE - OPMERKINGEN - примечания - NOTLAR

- The above table shows the average value of conditions which may occur.
Die obige Tabelle zeigt den Durchschnittswert der Bedingungen, die auftreten können.
 Στον παραπάνω πίνακα αναγράφεται η μέση τιμή για συνθήκες που μπορεί να προκύψουν.
La tabla de arriba muestra el valor medio de condiciones que pueden ocurrir.
 Le tableau ci-dessus donne la valeur moyenne pour des conditions qui peuvent survenir.
La tabella in alto mostra il valore delle condizioni medie che si possono riscontrare.
 De tabel hierboven geeft de gemiddelde waarde aan van situaties die kunnen voorvallen.
Таблица расположенная выше показывает среднее значение условий, которые могут наступить.
 Yukarıdaki tablo meydana gelebilecek koşulların ortalama değerini göstermektedir.

3D079549

5 Таблицы производительности

5 - 1 Таблицы холодопроизводительности

5

RXYQ52T															
Indoor air temp. °CWB															
Combination(%) (Capacity index)	Outdoor air temp. (°CDB)	14.0		16.0		18.0		19.0		20.0		22.0		24.0	
		TC	PI	TC	PI	TC	PI	TC	PI	TC	PI	TC	PI	TC	PI
		KW	KW	KW	KW	KW	KW	KW	KW	KW	KW	KW	KW	KW	KW
90% 130.50 kW	10	80.3	12.8	100.4	15.8	120	18.9	131	20.6	141	22.3	161	25.7	181	29.3
	12	80.3	13.0	100.4	16.0	120	19.3	131	20.9	141	22.7	161	26.2	179	29.3
	14	80.3	13.2	100.4	16.3	120	19.6	131	21.3	141	23.1	161	26.7	176	29.1
	16	80.3	13.4	100.4	16.5	120	19.9	131	21.7	141	23.5	161	27.2	174	29.0
	18	80.3	13.6	100.4	16.8	120	20.3	131	22.1	141	23.9	161	27.9	172	30.4
	20	80.3	13.8	100.4	17.1	120	20.7	131	22.5	141	24.9	161	30.0	169	31.8
	21	80.3	13.9	100.4	17.3	120	20.9	131	23.3	141	25.7	161	31.1	168	32.6
	23	80.3	14.1	100.4	17.8	120	22.4	131	24.9	141	27.5	161	33.3	166	34.1
	25	80.3	14.6	100.4	18.9	120	23.9	131	26.6	141	29.4	160	35.3	163	35.6
	27	80.3	15.5	100.4	20.2	120	25.5	131	28.4	141	31.4	157	36.7	161	37.1
	29	80.3	16.5	100.4	21.4	120	27.1	131	30.2	141	33.5	155	38.2	159	38.6
	31	80.3	17.5	100.4	22.8	120	28.9	131	32.2	141	35.7	153	39.7	156	40.1
	33	80.3	18.5	100.4	24.2	120	30.7	131	34.3	141	38.1	150	41.2	154	41.6
	35	80.3	19.6	100.4	25.7	120	32.7	131	36.5	141	40.5	148	42.7	152	43.1
37	80.3	20.7	100.4	27.2	120	34.7	131	38.8	141	43.1	146	44.2	149	44.6	
39	80.3	21.9	100.4	28.9	120	36.9	131	41.3	139	45.3	143	45.7	147	46.2	
80% 116.00 kW	10	71.4	11.5	89.2	14.1	107	16.8	116	18.2	125	19.7	143	22.7	161	25.7
	12	71.4	11.7	89.2	14.3	107	17.1	116	18.5	125	20.0	143	23.1	161	26.2
	14	71.4	11.9	89.2	14.5	107	17.3	116	18.8	125	20.3	143	23.5	161	26.7
	16	71.4	12.0	89.2	14.7	107	17.6	116	19.2	125	20.7	143	23.9	161	27.2
	18	71.4	12.2	89.2	15.0	107	18.0	116	19.5	125	21.1	143	24.3	161	27.9
	20	71.4	12.4	89.2	15.2	107	18.3	116	19.9	125	21.5	143	25.4	161	30.0
	21	71.4	12.5	89.2	15.4	107	18.4	116	20.0	125	22.0	143	26.3	161	31.1
	23	71.4	12.7	89.2	15.6	107	19.2	116	21.3	125	23.5	143	28.1	161	33.3
	25	71.4	12.9	89.2	16.5	107	20.5	116	22.7	125	25.1	143	30.1	160	35.3
	27	71.4	13.7	89.2	17.5	107	21.9	116	24.2	125	26.7	143	32.1	157	36.7
	29	71.4	14.5	89.2	18.6	107	23.3	116	25.8	125	28.5	143	34.3	155	38.2
	31	71.4	15.3	89.2	19.7	107	24.7	116	27.5	125	30.3	143	36.5	153	39.7
	33	71.4	16.2	89.2	20.9	107	26.3	116	29.2	125	32.3	143	38.9	150	41.2
	35	71.4	17.2	89.2	22.2	107	27.9	116	31.0	125	34.3	143	41.5	148	42.7
37	71.4	18.1	89.2	23.5	107	29.6	116	33.0	125	36.5	142	43.8	146	44.2	
39	71.4	19.2	89.2	24.9	107	31.4	116	35.0	125	38.8	140	45.3	143	45.7	
70% 101.50 kW	10	62.5	10.4	78.1	12.5	93.7	14.7	101.5	15.9	109	17.1	125	19.7	141	22.3
	12	62.5	10.5	78.1	12.6	93.7	15.0	101.5	16.2	109	17.4	125	20.0	141	22.7
	14	62.5	10.6	78.1	12.8	93.7	15.2	101.5	16.4	109	17.7	125	20.3	141	23.1
	16	62.5	10.8	78.1	13.0	93.7	15.4	101.5	16.7	109	18.0	125	20.7	141	23.5
	18	62.5	10.9	78.1	13.2	93.7	15.7	101.5	17.0	109	18.3	125	21.1	141	23.9
	20	62.5	11.1	78.1	13.4	93.7	16.0	101.5	17.3	109	18.7	125	21.5	141	24.9
	21	62.5	11.1	78.1	13.5	93.7	16.1	101.5	17.5	109	18.8	125	22.0	141	25.7
	23	62.5	11.3	78.1	13.8	93.7	16.4	101.5	18.0	109	19.8	125	23.5	141	27.5
	25	62.5	11.5	78.1	14.2	93.7	17.4	101.5	19.2	109	21.1	125	25.1	141	29.4
	27	62.5	12.0	78.1	15.1	93.7	18.5	101.5	20.4	109	22.4	125	26.7	141	31.4
	29	62.5	12.7	78.1	16.0	93.7	19.7	101.5	21.7	109	23.9	125	28.5	141	33.5
	31	62.5	13.4	78.1	16.9	93.7	20.9	101.5	23.1	109	25.4	125	30.3	141	35.7
	33	62.5	14.1	78.1	17.9	93.7	22.2	101.5	24.5	109	27.0	125	32.3	141	38.1
	35	62.5	14.9	78.1	19.0	93.7	23.5	101.5	26.0	109	28.7	125	34.3	141	40.5
37	62.5	15.8	78.1	20.1	93.7	25.0	101.5	27.6	109	30.4	125	36.5	141	43.1	
39	62.5	16.6	78.1	21.2	93.7	26.4	101.5	29.3	109	32.3	125	38.8	139	45.3	
60% 87.00 kW	10	53.5	9.2	66.9	10.9	80.3	12.8	87.0	13.7	93.7	14.7	107.1	16.8	120	18.9
	12	53.5	9.3	66.9	11.1	80.3	13.0	87.0	14.0	93.7	15.0	107.1	17.1	120	19.3
	14	53.5	9.4	66.9	11.2	80.3	13.2	87.0	14.2	93.7	15.2	107.1	17.3	120	19.6
	16	53.5	9.6	66.9	11.4	80.3	13.4	87.0	14.4	93.7	15.4	107.1	17.6	120	19.9
	18	53.5	9.7	66.9	11.6	80.3	13.6	87.0	14.6	93.7	15.7	107.1	18.0	120	20.3
	20	53.5	9.8	66.9	11.7	80.3	13.8	87.0	14.9	93.7	16.0	107.1	18.3	120	20.7
	21	53.5	9.9	66.9	11.8	80.3	13.9	87.0	15.0	93.7	16.1	107.1	18.4	120	20.9
	23	53.5	10.0	66.9	12.0	80.3	14.1	87.0	15.2	93.7	16.4	107.1	19.2	120	22.4
	25	53.5	10.1	66.9	12.2	80.3	14.6	87.0	16.0	93.7	17.4	107.1	20.5	120	23.9
	27	53.5	10.4	66.9	12.8	80.3	15.5	87.0	17.0	93.7	18.5	107.1	21.9	120	25.5
	29	53.5	11.0	66.9	13.6	80.3	16.5	87.0	18.1	93.7	19.7	107.1	23.3	120	27.1
	31	53.5	11.6	66.9	14.3	80.3	17.5	87.0	19.2	93.7	20.9	107.1	24.7	120	28.9
	33	53.5	12.2	66.9	15.2	80.3	18.5	87.0	20.3	93.7	22.2	107.1	26.3	120	30.7
	35	53.5	12.9	66.9	16.0	80.3	19.6	87.0	21.5	93.7	23.5	107.1	27.9	120	32.7
37	53.5	13.6	66.9	16.9	80.3	20.7	87.0	22.8	93.7	25.0	107.1	29.6	120	34.7	
39	53.5	14.3	66.9	17.9	80.3	21.9	87.0	24.1	93.7	26.4	107.1	31.4	120	36.9	
50% 72.50 kW	10	44.6	8.16	55.8	9.5	66.9	10.9	72.5	11.7	78.1	12.5	89.2	14.1	100.4	15.8
	12	44.6	8.25	55.8	9.6	66.9	11.1	72.5	11.9	78.1	12.6	89.2	14.3	100.4	16.0
	14	44.6	8.33	55.8	9.7	66.9	11.2	72.5	12.0	78.1	12.8	89.2	14.5	100.4	16.3
	16	44.6	8.42	55.8	9.9	66.9	11.4	72.5	12.2	78.1	13.0	89.2	14.7	100.4	16.5
	18	44.6	8.52	55.8	10.0	66.9	11.6	72.5	12.4	78.1	13.2	89.2	15.0	100.4	16.8
	20	44.6	8.62	55.8	10.1	66.9	11.7	72.5	12.6	78.1	13.4	89.2	15.2	100.4	17.1
	21	44.6	8.67	55.8	10.2	66.9	11.8	72.5	12.7	78.1	13.5	89.2	15.4	100.4	17.3
	23	44.6	8.77	55.8	10.3	66.9	12.0	72.5	12.9	78.1	13.8	89.2	15.6	100.4	17.8
	25	44.6	8.88	55.8	10.5	66.9	12.2	72.5	13.1	78.1	14.2	89.2	16.5	100.4	18.9
	27	44.6	8.99	55.8	10.8	66.9	12.8	72.5	13.9	78.1	15.1	89.2	17.5	100.4	20.2
	29	44.6	9.4	55.8	11.4	66.9	13.6	72.5	14.7	78.1	16.0	89.2	18.6	100.4	21.4
	31	44.6	9.9	55.8	12.0	66.9	14.3	72.5	15.6	78.1	16.9	89.2	19.7	100.4	22.8
	33	44.6	10.4	55.8	12.7	66.9	15.2	72.5	16.5	78.1	17.9	89.2	20.9	100.4	24.2
	35	44.6	11.0	55.8	13.4	66.9	16.0	72.5	17.5	78.1	19.0	89.2	22.2	100.4	25.7
37	44.6	11.5	55.8	14.1	66.9	16.9	72.5	18.5	78.1	20.1	89.2	23.5	100.4	27.2	
39	44.6	12.1	55.8	14.8	66.9	17.9	72.5	19.5	78.1	21.2	89.2	24.9	100.4	28.9	

3D079549

5 Таблицы производительности

5 - 1 Таблицы холодопроизводительности

RXYQ54T

TC : Total capacity (kW); PI : Power Input (kW) (Comp. + Outdoor fan motor)

Indoor air temp. °CWB

Combination(%) (Capacity index)	Outdoor air temp. (°CDB)	14.0		16.0		18.0		19.0		20.0		22.0		24.0		
		TC	PI	TC	PI	TC	PI	TC	PI	TC	PI	TC	PI	TC	PI	
		KW	KW	KW	KW	KW	KW	KW	KW	KW	KW	KW	KW	KW	KW	KW
130% 195.00 kW	10	120	18.9	150	24.0	180	29.2	189	30.2	192	29.5	197	28.0	203	26.5	
	12	120	19.3	150	24.4	180	29.7	186	30.0	189	29.3	195	27.8	201	27.8	
	14	120	19.6	150	24.8	180	30.3	184	29.9	187	29.1	192	29.1	198	29.4	
	16	120	19.9	150	25.3	179	30.5	182	30.1	184	30.3	190	30.6	196	31.0	
	18	120	20.3	150	25.7	176	31.5	179	31.7	182	31.9	188	32.2	193	32.6	
	20	120	20.7	150	27.0	174	33.0	177	33.2	180	33.4	185	33.8	191	34.2	
	21	120	20.8	150	27.9	173	33.8	176	34.0	178	34.2	184	34.6	190	35.0	
	23	120	22.2	150	29.9	170	35.3	173	35.5	176	35.8	181	36.2	187	36.6	
	25	120	23.6	150	32.0	168	36.9	171	37.1	173	37.3	179	37.8	185	38.2	
	27	120	25.2	150	34.2	165	38.4	168	38.7	171	38.9	177	39.4	182	39.9	
	29	120	26.8	150	36.4	163	40.0	166	40.2	169	40.5	174	41.0	180	41.5	
	31	120	28.6	150	38.9	160	41.6	163	41.8	166	42.1	172	42.6	177	43.2	
	33	120	30.4	150	41.4	158	43.1	161	43.4	164	43.7	169	44.3	175	44.8	
	35	120	32.3	150	44.1	156	44.7	158	45.0	161	45.3	167	45.9	172	46.5	
	37	120	34.3	148	45.7	153	46.3	156	46.6	159	46.9	164	47.5	170	48.2	
	39	120	36.4	145	47.2	151	47.9	154	48.2	156	48.5	162	49.2	168	49.9	
	120% 180.00 kW	10	111	17.5	138	22.0	166	26.8	180	29.2	189	30.2	194	28.9	199	27.5
		12	111	17.7	138	22.4	166	27.2	180	29.7	186	30.1	191	28.7	197	27.6
14		111	18.0	138	22.8	166	27.7	180	30.3	184	29.9	189	28.9	194	29.2	
16		111	18.4	138	23.2	166	28.2	179	30.5	181	30.1	187	30.4	192	30.8	
18		111	18.7	138	23.6	166	29.1	176	31.5	179	31.7	184	32.0	189	32.3	
20		111	19.0	138	24.2	166	31.2	174	33.0	177	33.2	182	33.6	187	33.9	
21		111	19.2	138	25.0	166	32.3	173	33.8	175	34.0	180	34.3	186	34.7	
23		111	20.0	138	26.8	166	34.6	170	35.3	173	35.5	178	35.9	183	36.3	
25		111	21.3	138	28.6	165	36.7	168	36.9	170	37.1	176	37.5	181	37.9	
27		111	22.7	138	30.5	163	38.2	165	38.4	168	38.7	173	39.1	178	39.5	
29		111	24.2	138	32.6	160	39.8	163	40.0	166	40.2	171	40.7	176	41.2	
31		111	25.7	138	34.7	158	41.3	160	41.6	163	41.8	168	42.3	173	42.8	
33		111	27.3	138	36.9	155	42.9	158	43.1	161	43.4	166	43.9	171	44.4	
35		111	29.0	138	39.3	153	44.4	156	44.7	158	45.0	163	45.5	169	46.1	
37		111	30.8	138	41.8	151	46.0	153	46.3	156	46.6	161	47.2	166	47.7	
39		111	32.7	138	44.5	148	47.6	151	47.9	153	48.2	159	48.8	164	49.4	
110% 165.00 kW		10	102	16.0	127	20.1	152	24.4	165	26.6	178	28.8	190	29.8	195	28.6
		12	102	16.3	127	20.4	152	24.8	165	27.0	178	29.3	188	29.6	193	28.4
	14	102	16.5	127	20.8	152	25.2	165	27.5	178	29.8	186	29.5	190	29.0	
	16	102	16.8	127	21.1	152	25.7	165	28.0	178	30.4	183	30.2	188	30.5	
	18	102	17.1	127	21.5	152	26.2	165	28.8	176	31.5	181	31.8	185	32.1	
	20	102	17.4	127	21.9	152	27.6	165	30.9	173	33.0	178	33.3	183	33.7	
	21	102	17.6	127	22.3	152	28.5	165	32.0	172	33.8	177	34.1	182	34.4	
	23	102	18.0	127	23.8	152	30.6	165	34.3	170	35.3	175	35.7	179	36.0	
	25	102	19.2	127	25.4	152	32.7	165	36.6	167	36.8	172	37.2	177	37.6	
	27	102	20.4	127	27.1	152	34.9	163	38.2	165	38.4	170	38.8	174	39.2	
	29	102	21.7	127	28.9	152	37.2	160	39.7	163	39.9	167	40.4	172	40.8	
	31	102	23.0	127	30.8	152	39.7	158	41.3	160	41.5	165	42.0	170	42.4	
	33	102	24.5	127	32.8	152	42.3	155	42.8	158	43.1	162	43.6	167	44.0	
	35	102	26.0	127	34.8	150	44.1	153	44.4	155	44.7	160	45.2	165	45.7	
	37	102	27.5	127	37.0	148	45.7	150	46.0	153	46.2	157	46.8	162	47.3	
	39	102	29.2	127	39.3	146	47.3	148	47.5	150	47.8	155	48.4	160	49.0	
	100% 150.00 kW	10	92.3	14.6	115	18.2	138	22.0	150	24.0	162	26.0	185	30.0	191	29.6
		12	92.3	14.9	115	18.5	138	22.4	150	24.4	162	26.4	185	30.5	189	29.4
14		92.3	15.1	115	18.8	138	22.8	150	24.8	162	26.9	182	30.4	186	29.2	
16		92.3	15.3	115	19.1	138	23.2	150	25.3	162	27.4	180	30.2	184	30.3	
18		92.3	15.6	115	19.5	138	23.6	150	25.7	162	27.9	177	31.5	182	31.8	
20		92.3	15.8	115	19.8	138	24.2	150	27.0	162	30.0	175	33.1	179	33.4	
21		92.3	16.0	115	20.0	138	25.0	150	27.9	162	31.0	174	33.9	178	34.2	
23		92.3	16.3	115	21.1	138	26.8	150	29.9	162	33.2	171	35.4	175	35.7	
25		92.3	17.1	115	22.5	138	28.6	150	32.0	162	35.5	169	36.9	173	37.3	
27		92.3	18.2	115	23.9	138	30.5	150	34.2	162	38.0	166	38.5	171	38.9	
29		92.3	19.3	115	25.5	138	32.6	150	36.4	159	39.7	164	40.1	168	40.5	
31		92.3	20.5	115	27.1	138	34.7	150	38.9	157	41.2	161	41.6	166	42.0	
33		92.3	21.8	115	28.8	138	36.9	150	41.4	155	42.8	159	43.2	163	43.6	
35		92.3	23.1	115	30.6	138	39.3	150	44.1	152	44.3	156	44.8	161	45.3	
37		92.3	24.4	115	32.5	138	41.8	148	45.7	150	45.9	154	46.4	158	46.9	
39		92.3	25.9	115	34.5	138	44.5	145	47.2	147	47.5	152	48.0	156	48.5	

NOTES - ANMERKUNGEN - Σημειώσεις - NOTAS - REMARQUES - NOTE - OPMERKINGEN - примечания - NOTLAR

- The above table shows the average value of conditions which may occur.
Die obige Tabelle zeigt den Durchschnittswert der Bedingungen, die auftreten können.
 Στον παραπάνω πίνακα αναγράφεται η μέση τιμή για συνθήκες που μπορεί να προκύψουν.
La tabla de arriba muestra el valor medio de condiciones que pueden ocurrir.
 Le tableau ci-dessus donne la valeur moyenne pour des conditions qui peuvent survenir.
La tabella in alto mostra il valore delle condizioni medie che si possono riscontrare.
 De tabel hierboven geeft de gemiddelde waarde aan van situaties die kunnen voorvallen.
Таблица расположенная выше показывает среднее значение условий, которые могут наступить.
 Yukarıdaki tablo meydana gelebilecek koşulların ortalama değerini göstermektedir.

3D079549

5 Таблицы производительности

5 - 1 Таблицы холодопроизводительности

5

RXYQ54T															
Indoor air temp. °CWB															
Combination(%) (Capacity index)	Outdoor air temp. (°CDB)	14.0		16.0		18.0		19.0		20.0		22.0		24.0	
		TC	PI	TC	PI	TC	PI	TC	PI	TC	PI	TC	PI	TC	PI
		KW	KW	KW	KW	KW	KW	KW	KW	KW	KW	KW	KW	KW	KW
90% 135.00 kW	10	83.1	13.3	103.8	16.4	125	19.7	135	21.4	145	23.2	166	26.8	187	30.4
	12	83.1	13.5	103.8	16.6	125	20.0	135	21.8	145	23.6	166	27.2	185	30.4
	14	83.1	13.7	103.8	16.9	125	20.4	135	22.2	145	24.0	166	27.7	183	30.3
	16	83.1	13.9	103.8	17.2	125	20.7	135	22.6	145	24.4	166	28.2	180	30.1
	18	83.1	14.1	103.8	17.5	125	21.1	135	23.0	145	24.9	166	29.1	178	31.6
	20	83.1	14.3	103.8	17.8	125	21.5	135	23.4	145	25.9	166	31.2	175	33.1
	21	83.1	14.5	103.8	18.0	125	21.8	135	24.2	145	26.8	166	32.3	174	33.9
	23	83.1	14.7	103.8	18.5	125	23.3	135	25.9	145	28.6	166	34.6	172	35.4
	25	83.1	15.2	103.8	19.7	125	24.8	135	27.6	145	30.6	165	36.7	169	37.0
	27	83.1	16.2	103.8	21.0	125	26.5	135	29.5	145	32.7	163	38.2	167	38.5
	29	83.1	17.1	103.8	22.3	125	28.2	135	31.4	145	34.9	160	39.8	164	40.1
	31	83.1	18.2	103.8	23.7	125	30.0	135	33.5	145	37.2	158	41.3	162	41.7
	33	83.1	19.2	103.8	25.2	125	31.9	135	35.7	145	39.6	155	42.9	159	43.3
	35	83.1	20.4	103.8	26.7	125	34.0	135	37.9	145	42.2	153	44.4	157	44.8
37	83.1	21.6	103.8	28.3	125	36.1	135	40.4	145	44.9	151	46.0	154	46.4	
39	83.1	22.8	103.8	30.0	125	38.4	135	42.9	144	47.1	148	47.6	152	48.0	
80% 120.00 kW	10	73.8	12.0	92.3	14.6	111	17.5	120	18.9	129	20.5	148	23.6	166	26.8
	12	73.8	12.2	92.3	14.9	111	17.7	120	19.3	129	20.8	148	24.0	166	27.2
	14	73.8	12.3	92.3	15.1	111	18.0	120	19.6	129	21.2	148	24.4	166	27.7
	16	73.8	12.5	92.3	15.3	111	18.4	120	19.9	129	21.5	148	24.8	166	28.2
	18	73.8	12.7	92.3	15.6	111	18.7	120	20.3	129	21.9	148	25.3	166	29.1
	20	73.8	12.9	92.3	15.8	111	19.0	120	20.7	129	22.3	148	26.4	166	31.2
	21	73.8	13.0	92.3	16.0	111	19.2	120	20.8	129	22.8	148	27.4	166	32.3
	23	73.8	13.2	92.3	16.3	111	20.0	120	22.2	129	24.4	148	29.3	166	34.6
	25	73.8	13.4	92.3	17.1	111	21.3	120	23.6	129	26.1	148	31.3	165	36.7
	27	73.8	14.2	92.3	18.2	111	22.7	120	25.2	129	27.8	148	33.4	163	38.2
	29	73.8	15.1	92.3	19.3	111	24.2	120	26.8	129	29.6	148	35.6	160	39.8
	31	73.8	16.0	92.3	20.5	111	25.7	120	28.6	129	31.5	148	38.0	158	41.3
	33	73.8	16.9	92.3	21.8	111	27.3	120	30.4	129	33.6	148	40.5	155	42.9
	35	73.8	17.9	92.3	23.1	111	29.0	120	32.3	129	35.7	148	43.1	153	44.4
37	73.8	18.9	92.3	24.4	111	30.8	120	34.3	129	38.0	147	45.6	151	46.0	
39	73.8	19.9	92.3	25.9	111	32.7	120	36.4	129	40.3	145	47.2	148	47.6	
70% 105.00 kW	10	64.6	10.8	80.8	13.0	96.9	15.3	105.0	16.6	113	17.8	129	20.5	145	23.2
	12	64.6	10.9	80.8	13.1	96.9	15.6	105.0	16.8	113	18.1	129	20.8	145	23.6
	14	64.6	11.0	80.8	13.3	96.9	15.8	105.0	17.1	113	18.4	129	21.2	145	24.0
	16	64.6	11.2	80.8	13.5	96.9	16.1	105.0	17.4	113	18.7	129	21.5	145	24.4
	18	64.6	11.4	80.8	13.8	96.9	16.3	105.0	17.7	113	19.1	129	21.9	145	24.9
	20	64.6	11.5	80.8	14.0	96.9	16.6	105.0	18.0	113	19.4	129	22.3	145	25.9
	21	64.6	11.6	80.8	14.1	96.9	16.8	105.0	18.2	113	19.6	129	22.8	145	26.8
	23	64.6	11.8	80.8	14.3	96.9	17.1	105.0	18.7	113	20.5	129	24.4	145	28.6
	25	64.6	11.9	80.8	14.7	96.9	18.1	105.0	20.0	113	21.9	129	26.1	145	30.6
	27	64.6	12.4	80.8	15.7	96.9	19.3	105.0	21.3	113	23.3	129	27.8	145	32.7
	29	64.6	13.2	80.8	16.6	96.9	20.5	105.0	22.6	113	24.8	129	29.6	145	34.9
	31	64.6	13.9	80.8	17.6	96.9	21.8	105.0	24.0	113	26.4	129	31.5	145	37.2
	33	64.6	14.7	80.8	18.6	96.9	23.1	105.0	25.5	113	28.1	129	33.6	145	39.6
	35	64.6	15.5	80.8	19.7	96.9	24.5	105.0	27.1	113	29.8	129	35.7	145	42.2
37	64.6	16.4	80.8	20.9	96.9	26.0	105.0	28.7	113	31.7	129	38.0	145	44.9	
39	64.6	17.3	80.8	22.1	96.9	27.5	105.0	30.5	113	33.6	129	40.3	144	47.1	
60% 90.00 kW	10	55.4	9.6	69.2	11.4	83.1	13.3	90.0	14.3	96.9	15.3	110.8	17.5	125	19.7
	12	55.4	9.7	69.2	11.5	83.1	13.5	90.0	14.5	96.9	15.6	110.8	17.7	125	20.0
	14	55.4	9.8	69.2	11.7	83.1	13.7	90.0	14.7	96.9	15.8	110.8	18.0	125	20.4
	16	55.4	9.9	69.2	11.8	83.1	13.9	90.0	15.0	96.9	16.1	110.8	18.4	125	20.7
	18	55.4	10.1	69.2	12.0	83.1	14.1	90.0	15.2	96.9	16.3	110.8	18.7	125	21.1
	20	55.4	10.2	69.2	12.2	83.1	14.3	90.0	15.5	96.9	16.6	110.8	19.0	125	21.5
	21	55.4	10.3	69.2	12.3	83.1	14.5	90.0	15.6	96.9	16.8	110.8	19.2	125	21.8
	23	55.4	10.4	69.2	12.5	83.1	14.7	90.0	15.9	96.9	17.1	110.8	20.0	125	23.3
	25	55.4	10.5	69.2	12.7	83.1	15.2	90.0	16.6	96.9	18.1	110.8	21.3	125	24.8
	27	55.4	10.8	69.2	13.3	83.1	16.2	90.0	17.7	96.9	19.3	110.8	22.7	125	26.5
	29	55.4	11.4	69.2	14.1	83.1	17.1	90.0	18.8	96.9	20.5	110.8	24.2	125	28.2
	31	55.4	12.0	69.2	14.9	83.1	18.2	90.0	19.9	96.9	21.8	110.8	25.7	125	30.0
	33	55.4	12.7	69.2	15.8	83.1	19.2	90.0	21.1	96.9	23.1	110.8	27.3	125	31.9
	35	55.4	13.4	69.2	16.7	83.1	20.4	90.0	22.4	96.9	24.5	110.8	29.0	125	34.0
37	55.4	14.1	69.2	17.6	83.1	21.6	90.0	23.7	96.9	26.0	110.8	30.8	125	36.1	
39	55.4	14.8	69.2	18.6	83.1	22.8	90.0	25.1	96.9	27.5	110.8	32.7	125	38.4	
50% 75.00 kW	10	46.2	8.49	57.7	9.9	69.2	11.4	75.0	12.2	80.8	13.0	92.3	14.6	103.8	16.4
	12	46.2	8.58	57.7	10.0	69.2	11.5	75.0	12.3	80.8	13.1	92.3	14.9	103.8	16.6
	14	46.2	8.67	57.7	10.1	69.2	11.7	75.0	12.5	80.8	13.3	92.3	15.1	103.8	16.9
	16	46.2	8.76	57.7	10.2	69.2	11.8	75.0	12.7	80.8	13.5	92.3	15.3	103.8	17.2
	18	46.2	8.86	57.7	10.4	69.2	12.0	75.0	12.9	80.8	13.8	92.3	15.6	103.8	17.5
	20	46.2	8.96	57.7	10.5	69.2	12.2	75.0	13.1	80.8	14.0	92.3	15.8	103.8	17.8
	21	46.2	9.01	57.7	10.6	69.2	12.3	75.0	13.2	80.8	14.1	92.3	16.0	103.8	18.0
	23	46.2	9.12	57.7	10.7	69.2	12.5	75.0	13.4	80.8	14.3	92.3	16.3	103.8	18.5
	25	46.2	9.24	57.7	10.9	69.2	12.7	75.0	13.6	80.8	14.7	92.3	17.1	103.8	19.7
	27	46.2	9.35	57.7	11.2	69.2	13.3	75.0	14.5	80.8	15.7	92.3	18.2	103.8	21.0
	29	46.2	9.8	57.7	11.8	69.2	14.1	75.0	15.3	80.8	16.6	92.3	19.3	103.8	22.3
	31	46.2	10.3	57.7	12.5	69.2	14.9	75.0	16.2	80.8	17.6	92.3	20.5	103.8	23.7
	33	46.2	10.9	57.7	13.2	69.2	15.8	75.0	17.2	80.8	18.6	92.3	21.8	103.8	25.2
	35	46.2	11.4	57.7	13.9	69.2	16.7	75.0	18.2	80.8	19.7	92.3	23.1	103.8	26.7
37	46.2	12.0	57.7	14.6	69.2	17.6	75.0	19.2	80.8	20.9	92.3	24.4	103.8	28.3	
39	46.2	12.6	57.7	15.4	69.2	18.6	75.0	20.3	80.8	22.1	92.3	25.9	103.8	30.0	

3D079549

5 Таблицы производительности

5 - 2 Таблицы теплопроизводительностей

RXYQ8T		Indoor air temp. °CDB												
Combination(%) (Capacity index)	Outdoor air temp.		16.0		18.0		20.0		21.0		22.0		24.0	
	(°CDB)	(°CWB)	TC	PI	TC	PI	TC	PI	TC	PI	TC	PI	TC	PI
			KW	KW	KW	KW	KW	KW	KW	KW	KW	KW	KW	KW
130% 29.12 kW	-19.8	-20.0	15.2	2.94	15.1	3.26	15.0	3.57	15.0	3.73	15.0	3.89	14.9	4.21
	-18.8	-19.0	15.6	3.09	15.6	3.39	15.5	3.70	15.5	3.86	15.4	4.01	15.4	4.32
	-16.7	-17.0	16.5	3.35	16.5	3.64	16.4	3.93	16.4	4.08	16.3	4.22	16.2	4.51
	-13.7	-15.0	17.4	3.59	17.3	3.87	17.3	4.14	17.2	4.28	17.2	4.42	17.1	4.69
	-11.8	-13.0	18.3	3.81	18.2	4.07	18.2	4.33	18.1	4.46	18.1	4.59	18.0	4.85
	-9.8	-11.0	19.2	4.01	19.1	4.25	19.1	4.50	19.0	4.63	19.0	4.75	18.9	5.00
	-9.5	-10.0	19.7	4.10	19.6	4.34	19.5	4.58	19.5	4.70	19.4	4.82	19.4	5.06
	-8.5	-9.1	20.1	4.18	20.0	4.41	19.9	4.65	19.9	4.77	19.8	4.89	19.8	5.12
	-7.0	-7.6	20.7	4.30	20.7	4.53	20.6	4.76	20.6	4.87	20.5	4.99	20.5	5.21
	-5.0	-5.6	21.6	4.45	21.5	4.67	21.5	4.89	21.4	5.00	21.4	5.11	21.3	5.33
	-3.0	-3.7	22.5	4.58	22.4	4.80	22.3	5.01	22.3	5.11	22.3	5.22	22.2	5.43
	0.0	-0.7	23.8	4.78	23.7	4.97	23.7	5.17	23.6	5.27	23.6	5.37	23.5	5.57
	3.0	2.2	25.1	4.94	25.0	5.13	25.0	5.32	24.9	5.41	24.9	5.51	24.8	5.69
	5.0	4.1	26.0	5.04	25.9	5.22	25.8	5.41	25.8	5.50	25.7	5.59	25.7	5.77
	7.0	6.0	26.8	5.14	26.7	5.31	26.7	5.49	26.6	5.58	26.6	5.66	26.5	5.84
	9.0	7.9	27.7	5.22	27.6	5.39	27.5	5.56	27.5	5.65	27.4	5.74	27.4	5.91
11.0	9.8	28.5	5.31	28.4	5.47	28.4	5.64	28.3	5.72	28.3	5.80	28.2	5.97	
13.0	11.8	29.4	5.39	29.3	5.55	29.3	5.71	29.2	5.79	29.2	5.87	29.1	6.04	
15.0	13.7	30.2	5.46	30.2	5.62	30.1	5.77	30.1	5.85	30.0	5.92	29.9	6.11	
120% 26.88 kW	-19.8	-20.0	15.1	3.31	15.0	3.60	15.0	3.89	14.9	4.04	14.9	4.18	14.9	4.48
	-18.8	-19.0	15.6	3.44	15.5	3.72	15.4	4.01	15.4	4.15	15.4	4.29	15.3	4.58
	-16.7	-17.0	16.4	3.69	16.4	3.96	16.3	4.22	16.3	4.36	16.3	4.49	16.2	4.76
	-13.7	-15.0	17.3	3.91	17.3	4.16	17.2	4.42	17.2	4.54	17.2	4.67	17.1	4.92
	-11.8	-13.0	18.2	4.11	18.2	4.35	18.1	4.59	18.1	4.71	18.0	4.83	18.0	5.07
	-9.8	-11.0	19.1	4.29	19.1	4.52	19.0	4.75	19.0	4.86	18.9	4.98	18.9	5.21
	-9.5	-10.0	19.6	4.38	19.5	4.60	19.4	4.82	19.4	4.93	19.4	5.05	19.3	5.27
	-8.5	-9.1	20.0	4.45	19.9	4.67	19.8	4.89	19.8	5.00	19.8	5.10	19.7	5.32
	-7.0	-7.6	20.6	4.56	20.6	4.77	20.5	4.99	20.5	5.09	20.5	5.20	20.4	5.41
	-5.0	-5.6	21.5	4.70	21.5	4.91	21.4	5.11	21.4	5.21	21.3	5.31	21.3	5.51
	-3.0	-3.7	22.4	4.83	22.3	5.02	22.3	5.22	22.2	5.31	22.2	5.41	22.1	5.61
	0.0	-0.7	23.7	5.01	23.7	5.19	23.6	5.37	23.6	5.46	23.5	5.56	23.5	5.74
	3.0	2.2	25.0	5.16	25.0	5.33	24.9	5.51	24.9	5.59	24.8	5.68	24.8	5.85
	5.0	4.1	25.9	5.25	25.8	5.42	25.7	5.59	25.7	5.67	25.7	5.76	25.6	5.94
	7.0	6.0	26.7	5.34	26.7	5.50	26.6	5.66	26.6	5.74	26.5	5.83	26.4	6.01
	9.0	7.9	27.6	5.42	27.5	5.58	27.4	5.74	27.4	5.81	27.4	5.89	27.3	6.08
11.0	9.8	28.4	5.50	28.4	5.65	28.3	5.80	28.3	5.88	28.2	5.96	28.1	6.15	
13.0	11.8	29.3	5.57	29.3	5.72	29.2	5.87	29.2	5.95	29.1	6.03	29.0	6.22	
15.0	13.7	30.2	5.64	30.1	5.79	30.0	5.92	29.9	6.00	29.8	6.08	29.7	6.29	
110% 24.64 kW	-19.8	-20.0	15.0	3.67	15.0	3.94	14.9	4.21	14.9	4.34	14.9	4.48	14.8	4.74
	-18.8	-19.0	15.5	3.80	15.4	4.06	15.4	4.32	15.3	4.45	15.3	4.58	15.2	4.84
	-16.7	-17.0	16.4	4.02	16.3	4.27	16.2	4.51	16.2	4.64	16.2	4.76	16.1	5.01
	-13.7	-15.0	17.3	4.23	17.2	4.46	17.1	4.69	17.1	4.81	17.1	4.92	17.0	5.16
	-11.8	-13.0	18.2	4.41	18.1	4.63	18.0	4.85	18.0	4.96	18.0	5.07	17.9	5.29
	-9.8	-11.0	19.0	4.58	19.0	4.79	18.9	5.00	18.9	5.10	18.9	5.21	18.8	5.42
	-9.5	-10.0	19.5	4.66	19.4	4.86	19.4	5.06	19.3	5.17	19.3	5.27	19.3	5.47
	-8.5	-9.1	19.9	4.72	19.8	4.92	19.8	5.12	19.8	5.22	19.7	5.32	19.7	5.52
	-7.0	-7.6	20.6	4.83	20.5	5.02	20.5	5.21	20.4	5.31	20.4	5.41	20.3	5.60
	-5.0	-5.6	21.5	4.96	21.4	5.14	21.3	5.33	21.3	5.42	21.3	5.51	21.2	5.70
	-3.0	-3.7	22.3	5.07	22.3	5.25	22.2	5.43	22.2	5.52	22.1	5.61	22.1	5.78
	0.0	-0.7	23.6	5.23	23.6	5.40	23.5	5.57	23.5	5.65	23.5	5.74	23.3	5.85
	3.0	2.2	24.9	5.38	24.9	5.54	24.8	5.69	24.8	5.77	24.8	5.85	24.8	5.94
	5.0	4.1	25.8	5.46	25.7	5.62	25.7	5.77	25.6	5.85	25.4	5.84	25.4	5.93
	7.0	6.0	26.6	5.54	26.6	5.69	26.5	5.84	26.4	5.89	26.4	5.96	26.3	6.02
	9.0	7.9	27.5	5.62	27.4	5.76	27.4	5.91	27.4	5.97	27.3	6.04	27.2	6.11
11.0	9.8	28.3	5.69	28.3	5.83	28.3	5.98	28.2	6.04	28.1	6.11	28.0	6.18	
13.0	11.8	29.2	5.76	29.2	5.89	29.1	6.04	29.0	6.10	28.9	6.17	28.8	6.24	
15.0	13.7	30.1	5.82	29.6	5.83	29.5	6.00	29.4	6.06	29.3	6.13	29.2	6.21	
100% 22.40 kW	-19.8	-20.0	14.9	4.04	14.9	4.28	14.8	4.52	14.8	4.65	14.8	4.77	14.7	5.01
	-18.8	-19.0	15.4	4.15	15.3	4.39	15.3	4.62	15.3	4.74	15.2	4.86	15.2	5.10
	-16.7	-17.0	16.3	4.36	16.2	4.58	16.2	4.80	16.2	4.92	16.1	5.03	16.1	5.25
	-13.7	-15.0	17.2	4.54	17.1	4.76	17.1	4.97	17.0	5.07	17.0	5.18	17.0	5.39
	-11.8	-13.0	18.1	4.71	18.0	4.91	18.0	5.11	17.9	5.21	17.9	5.31	17.9	5.51
	-9.8	-11.0	19.0	4.86	18.9	5.05	18.9	5.25	18.8	5.34	18.8	5.44	18.8	5.63
	-9.5	-10.0	19.4	4.93	19.4	5.12	19.3	5.31	19.3	5.40	19.3	5.49	19.2	5.68
	-8.5	-9.1	19.8	5.00	19.8	5.18	19.7	5.36	19.7	5.45	19.7	5.54	19.6	5.72
	-7.0	-7.6	20.5	5.09	20.4	5.27	20.4	5.44	20.4	5.53	20.3	5.62	20.3	5.80
	-5.0	-5.6	21.4	5.21	21.3	5.38	21.3	5.55	21.2	5.63	21.2	5.72	21.2	5.88
	-3.0	-3.7	22.2	5.31	22.2	5.48	22.1	5.64	22.1	5.72	22.1	5.80	22.0	5.96
	0.0	-0.7	23.6	5.46	23.5	5.62	23.5	5.77	23.4	5.85	23.4	5.93	23.3	6.04
	3.0	2.2	24.9	5.59	24.8	5.74	24.8	5.88	24.7	5.96	24.7	6.04	24.6	6.12
	5.0	4.1	25.7	5.67	25.7	5.81	25.6	5.95	25.5	6.03	25.4	6.11	25.3	6.20
	7.0	6.0	26.6	5.74	26.5	5.88	26.4	6.02	26.3	6.10	26.2	6.18	26.1	6.28
	9.0	7.9	27.4	5.81	27.3	5.89	27.2	6.07	27.1	6.15	27.0	6.23	26.9	6.36
11.0	9.8	28.3	5.88	28.2	5.96	28.1	6.14	28.0	6.22	27.9	6.30	27.8	6.44	
13.0	11.8	28.8	5.85	28.7	5.93	28.6	6.11	28.5	6.19	28.4	6.27	28.3	6.52	
15.0	13.7	28.8	5.65	28.9	5.20	28.8	4.77	28.7	4.56	28.6	4.35	28.5	3.95	

NOTES - ANMERKUNGEN - Σημειώσεις - NOTAS - REMARQUES - NOTE - OPMERKINGEN - примечания - NOTLAR

- is shown as reference. When selecting the unit models, avoid the Outdoor air temperature range shown by .
 dient als Verweis. Vermeiden Sie bei der Auswahl der Gerätemodelle den als markierten Temperaturbereich der Außenluft.
 Η είναι ενδεικτική, κατά την επιλογή των μοντέλων των μονάδων, αποφεύγετε το εύρος θερμοκρασίας εξωτερικού αέρα που υποδεικνύεται .
 se muestra como referencia. Cuando seleccione los modelos de unidad, evite el intervalo de temperaturas del aire exterior indicado mediante .
 est montré comme référence. Lors du choix des modèles d'unités, évitez la plage de températures de l'air extérieur illustré par .
 valori riportati unicamente come riferimento. Nel selezionare i modelli delle unità, non considerare i valori di temperatura dell'aria esterna indicati con il colore .
 is als referentie getoond. Wanneer modellen van eenheden worden gekozen, vermijd dan het bereik van buitenluchttemperaturen geïllustreerd door .
- показан как. При выборе модели устройства избегайте внешнюю температуру воздуха, указанную в .
 referans olarak gösterilmektedir. Ünite modellerini seçerken, belirtilen Dış hava sıcaklığı aralığından kaçınınız .
 The above table shows the average value of conditions which may occur.
 Die obige Tabelle zeigt den Durchschnittswert der Bedingungen, die auftreten können.
 Στον παραπάνω πίνακα αναγράφεται η μέση τιμή για συνθήκες που μπορεί να προκύψουν.
 La tabla de arriba muestra el valor medio de condiciones que pueden ocurrir.
 Le tableau ci-dessus donne la valeur moyenne pour des conditions qui peuvent survenir.
 La tabella in alto mostra il valore delle condizioni medie che si possono riscontrare.
 De tabel hierboven geeft de gemiddelde waarde aan van situaties die kunnen voorvallen.
 Таблица расположенная выше показывает среднее значение условий, которые могут наступить.
 Yukarıdaki tablo meydana gelebilecek koşulların ortalama

5 Таблицы производительности

5 - 2 Таблицы теплопроизводительностей

5

RXYQ8T														
Indoor air temp. °CDB														
Combination(%) (Capacity index)	Outdoor air temp.		16.0		18.0		20.0		21.0		22.0		24.0	
			TC	PI	TC	PI	TC	PI	TC	PI	TC	PI	TC	PI
	(°CDB)	(°CWB)	KW	KW	KW	KW	KW	KW	KW	KW	KW	KW	KW	KW
90% 20.16 kW	-19.8	-20.0	14.9	4.40	14.8	4.62	14.8	4.84	14.7	4.95	14.7	5.06	14.7	5.28
	-18.8	-19.0	15.3	4.51	15.3	4.72	15.2	4.93	15.2	5.04	15.2	5.14	15.1	5.36
	-16.7	-17.0	16.2	4.69	16.2	4.89	16.1	5.09	16.1	5.20	16.1	5.30	16.0	5.50
	-13.7	-15.0	17.1	4.86	17.1	5.05	17.0	5.24	17.0	5.34	17.0	5.43	16.9	5.62
	-11.8	-13.0	18.0	5.01	17.9	5.19	17.9	5.37	17.9	5.46	17.9	5.55	17.8	5.73
	-9.8	-11.0	18.9	5.15	18.8	5.32	18.8	5.49	18.8	5.58	18.7	5.66	18.7	5.84
	-9.5	-10.0	19.3	5.21	19.3	5.38	19.2	5.55	19.2	5.63	19.2	5.72	19.0	5.83
	-8.5	-9.1	19.7	5.27	19.7	5.43	19.6	5.60	19.6	5.68	19.6	5.76	19.0	5.69
	-7.0	-7.6	20.4	5.36	20.4	5.51	20.3	5.67	20.3	5.75	20.3	5.83	19.0	5.46
	-5.0	-5.6	21.3	5.46	21.3	5.61	21.2	5.77	21.2	5.84	20.8	5.75	19.0	5.18
	-3.0	-3.7	22.2	5.56	22.1	5.70	22.1	5.85	21.6	5.76	20.8	5.48	19.0	4.94
	0.0	-0.7	23.5	5.69	23.4	5.83	22.5	5.62	21.6	5.36	20.8	5.11	19.0	4.61
	3.0	2.2	24.8	5.81	24.2	5.75	22.5	5.26	21.6	5.03	20.8	4.79	19.0	4.34
	5.0	4.1	25.6	5.88	24.2	5.52	22.5	5.06	21.6	4.83	20.8	4.61	19.0	4.17
	7.0	6.0	26.0	5.77	24.2	5.31	22.5	4.87	21.6	4.65	20.8	4.44	19.0	4.02
	9.0	7.9	26.0	5.55	24.2	5.11	22.5	4.69	21.6	4.48	20.8	4.28	19.0	3.88
	11.0	9.8	26.0	5.35	24.2	4.93	22.5	4.53	21.6	4.33	20.8	4.13	19.0	3.75
13.0	11.8	26.0	5.15	24.2	4.76	22.5	4.37	21.6	4.18	20.8	3.99	19.0	3.63	
15.0	13.7	26.0	4.98	24.2	4.60	22.5	4.23	21.6	4.05	20.8	3.87	19.0	3.52	
80% 17.92 kW	-19.8	-20.0	14.8	4.77	14.7	4.96	14.7	5.16	14.7	5.26	14.7	5.35	14.6	5.55
	-18.8	-19.0	15.2	4.86	15.2	5.05	15.2	5.24	15.1	5.33	15.1	5.43	15.1	5.62
	-16.7	-17.0	16.1	5.03	16.1	5.21	16.0	5.38	16.0	5.47	16.0	5.56	16.0	5.74
	-13.7	-15.0	17.0	5.18	17.0	5.35	16.9	5.52	16.9	5.60	16.9	5.68	16.9	5.85
	-11.8	-13.0	17.9	5.31	17.9	5.47	17.8	5.63	17.8	5.71	17.8	5.79	16.9	5.53
	-9.8	-11.0	18.8	5.44	18.8	5.59	18.7	5.74	18.7	5.82	18.5	5.78	16.9	5.21
	-9.5	-10.0	19.3	5.49	19.2	5.64	19.2	5.79	19.2	5.87	18.5	5.62	16.9	5.07
	-8.5	-9.1	19.7	5.54	19.6	5.69	19.6	5.83	19.2	5.75	18.5	5.48	16.9	4.94
	-7.0	-7.6	20.3	5.62	20.3	5.76	20.0	5.79	19.2	5.52	18.5	5.26	16.9	4.75
	-5.0	-5.6	21.2	5.72	21.2	5.85	20.0	5.49	19.2	5.24	18.5	5.00	16.9	4.52
	-3.0	-3.7	22.1	5.80	21.5	5.72	20.0	5.24	19.2	5.00	18.5	4.77	16.9	4.32
	0.0	-0.7	23.1	5.79	21.5	5.33	20.0	4.89	19.2	4.67	18.5	4.45	16.9	4.04
	3.0	2.2	23.1	5.42	21.5	5.00	20.0	4.59	19.2	4.39	18.5	4.19	16.9	3.80
	5.0	4.1	23.1	5.21	21.5	4.81	20.0	4.41	19.2	4.22	18.5	4.03	16.9	3.66
	7.0	6.0	23.1	5.01	21.5	4.63	20.0	4.25	19.2	4.07	18.5	3.89	16.9	3.53
	9.0	7.9	23.1	4.83	21.5	4.46	20.0	4.10	19.2	3.93	18.5	3.75	16.9	3.42
	11.0	9.8	23.1	4.66	21.5	4.31	20.0	3.96	19.2	3.80	18.5	3.63	16.9	3.31
13.0	11.8	23.1	4.50	21.5	4.16	20.0	3.83	19.2	3.67	18.5	3.51	16.9	3.20	
15.0	13.7	23.1	4.35	21.5	4.03	20.0	3.71	19.2	3.55	18.5	3.40	16.9	3.10	
70% 15.68 kW	-19.8	-20.0	14.7	5.13	14.7	5.31	14.6	5.48	14.6	5.56	14.6	5.65	14.6	5.82
	-18.8	-19.0	15.2	5.22	15.1	5.38	15.1	5.55	15.1	5.63	15.0	5.71	14.8	5.75
	-16.7	-17.0	16.0	5.36	16.0	5.52	16.0	5.67	16.0	5.75	15.9	5.83	14.8	5.36
	-13.7	-15.0	16.9	5.49	16.9	5.64	16.9	5.79	16.8	5.85	16.2	5.57	14.8	5.02
	-11.8	-13.0	17.8	5.61	17.8	5.75	17.5	5.76	16.8	5.49	16.2	5.23	14.8	4.73
	-9.8	-11.0	18.7	5.72	18.7	5.86	17.5	5.42	16.8	5.18	16.2	4.94	14.8	4.46
	-9.5	-10.0	19.2	5.77	18.8	5.76	17.5	5.27	16.8	5.03	16.2	4.80	14.8	4.34
	-8.5	-9.1	19.6	5.82	18.8	5.62	17.5	5.14	16.8	4.91	16.2	4.68	14.8	4.24
	-7.0	-7.6	20.2	5.86	18.8	5.39	17.5	4.94	16.8	4.72	16.2	4.50	14.8	4.08
	-5.0	-5.6	20.2	5.56	18.8	5.12	17.5	4.70	16.8	4.49	16.2	4.28	14.8	3.89
	-3.0	-3.7	20.2	5.30	18.8	4.89	17.5	4.49	16.8	4.29	16.2	4.10	14.8	3.72
	0.0	-0.7	20.2	4.94	18.8	4.56	17.5	4.19	16.8	4.01	16.2	3.83	14.8	3.49
	3.0	2.2	20.2	4.64	18.8	4.29	17.5	3.95	16.8	3.78	16.2	3.61	14.8	3.29
	5.0	4.1	20.2	4.46	18.8	4.13	17.5	3.80	16.8	3.64	16.2	3.48	14.8	3.17
	7.0	6.0	20.2	4.30	18.8	3.98	17.5	3.67	16.8	3.51	16.2	3.36	14.8	3.07
	9.0	7.9	20.2	4.15	18.8	3.84	17.5	3.54	16.8	3.40	16.2	3.25	14.8	2.97
	11.0	9.8	20.2	4.01	18.8	3.71	17.5	3.43	16.8	3.29	16.2	3.15	14.8	2.88
13.0	11.8	20.2	3.87	18.8	3.59	17.5	3.31	16.8	3.18	16.2	3.05	14.8	2.79	
15.0	13.7	20.2	3.75	18.8	3.48	17.5	3.21	16.8	3.08	16.2	2.96	14.8	2.71	
60% 13.44 kW	-19.8	-20.0	14.6	5.50	14.6	5.65	14.6	5.79	14.4	5.79	13.8	5.51	12.7	4.97
	-18.8	-19.0	15.1	5.57	15.0	5.71	15.0	5.85	14.4	5.58	13.8	5.31	12.7	4.79
	-16.7	-17.0	16.0	5.70	15.9	5.83	15.0	5.45	14.4	5.20	13.8	4.95	12.7	4.48
	-13.7	-15.0	16.9	5.81	16.2	5.57	15.0	5.10	14.4	4.87	13.8	4.65	12.7	4.21
	-11.8	-13.0	17.3	5.68	16.2	5.23	15.0	4.80	14.4	4.58	13.8	4.37	12.7	3.97
	-9.8	-11.0	17.3	5.35	16.2	4.94	15.0	4.53	14.4	4.33	13.8	4.14	12.7	3.75
	-9.5	-10.0	17.3	5.20	16.2	4.80	15.0	4.41	14.4	4.21	13.8	4.03	12.7	3.66
	-8.5	-9.1	17.3	5.08	16.2	4.68	15.0	4.30	14.4	4.12	13.8	3.93	12.7	3.57
	-7.0	-7.6	17.3	4.88	16.2	4.50	15.0	4.14	14.4	3.96	13.8	3.79	12.7	3.45
	-5.0	-5.6	17.3	4.64	16.2	4.28	15.0	3.94	14.4	3.78	13.8	3.61	12.7	3.29
	-3.0	-3.7	17.3	4.43	16.2	4.10	15.0	3.77	14.4	3.62	13.8	3.46	12.7	3.15
	0.0	-0.7	17.3	4.14	16.2	3.83	15.0	3.54	14.4	3.39	13.8	3.25	12.7	2.96
	3.0	2.2	17.3	3.90	16.2	3.61	15.0	3.34	14.4	3.20	13.8	3.07	12.7	2.80
	5.0	4.1	17.3	3.75	16.2	3.48	15.0	3.22	14.4	3.09	13.8	2.96	12.7	2.71
	7.0	6.0	17.3	3.62	16.2	3.36	15.0	3.11	14.4	2.98	13.8	2.86	12.7	2.62
	9.0	7.9	17.3	3.50	16.2	3.25	15.0	3.01	14.4	2.89	13.8	2.77	12.7	2.54
	11.0	9.8	17.3	3.39	16.2	3.15	15.0	2.91	14.4	2.80	13.8	2.69	12.7	2.46
13.0	11.8	17.3	3.28	16.2	3.05	15.0	2.82	14.4	2.71	13.8	2.60	12.7	2.39	
15.0	13.7	17.3	3.18	16.2	2.96	15.0	2.74	14.4	2.64	13.8	2.53	12.7	2.33	
50% 11.20 kW	-19.8	-20.0	14.4	5.79	13.5	5.33	12.5	4.88	12.0	4.66	11.5	4.45	10.6	4.03
	-18.8	-19.0	14.4	5.58	13.5	5.14	12.5	4.71	12.0	4.50	11.5	4.30	10.6	3.90
	-16.7	-17.0	14.4	5.20	13.5	4.79	12.5	4.40	12.0	4.21	11.5	4.02	10.6	3.65
	-13.7	-15.0	14.4	4.87	13.5	4.50	12.5	4.13	12.0	3.96	11.5	3.78	10.6	3.44
	-11.8	-13.0	14.4	4.58	13.5	4.24	12.5	3.90	12.0	3.73	11.5	3.57	10.6	3.25
	-9.8	-11.0	14.4	4.33	13.5	4.01	12.5	3.69	12.0	3.54	11.5	3.39	10.6	3.09
	-9.5	-10.0	14.4	4.21	13.5	3.90	12.5	3.60	12.0	3.45	11.5	3.30	10.6	3.01
	-8.5	-9.1	14.4	4.12	13.5	3.81	12.5	3.52	12.0	3.37	11.5	3.23	10.6	2.95
	-7.0	-7.6	14.4	3.96	13.5	3.67	12.5	3.39	12.0	3.25	11.5	3.11	10.6	2.85
	-5.0	-5.6	14.4	3.78	13.5	3.50	12.5	3.24	12.0	3.10	11.5	2.98	10.6	2.72
	-3.0	-3.7	14.4	3.62	13.5	3.36	12.5	3.10	12.0	2.98	11.5	2.86	10.6	2.62
	0.0	-0.7	14.4	3.39	13.5	3.15	12.5	2.92	12.0	2.80	11.5	2.69</		

5 Таблицы производительности

5 - 2 Таблицы теплопроизводительностей

RYYQ10T		Indoor air temp. °CDB												TC: Total capacity (kW); PI: Power Input (kW) (Comp. + Outdoor fan motor)	
Combination(%) (Capacity index)	Outdoor air temp.		16.0		18.0		20.0		21.0		22.0		24.0		
	(°CDB)	(°CWB)	TC	PI	TC	PI	TC	PI	TC	PI	TC	PI	TC	PI	
130% 36.40 kW	-19.8	-20.0	19.3	4.26	19.2	4.71	19.1	5.15	19.1	5.37	19.0	5.59	18.9	6.03	
	-18.8	-19.0	19.6	4.38	19.5	4.82	19.4	5.25	19.4	5.47	19.3	5.69	19.3	6.12	
	-16.7	-17.0	20.3	4.64	20.2	5.06	20.2	5.47	20.1	5.68	20.1	5.89	20.0	6.31	
	-13.7	-15.0	21.1	4.90	21.1	5.30	21.0	5.70	20.9	5.90	20.9	6.10	20.8	6.50	
	-11.8	-13.0	22.1	5.17	22.0	5.55	21.9	5.94	21.8	6.13	21.8	6.32	21.7	6.70	
	-9.8	-11.0	23.1	5.44	23.0	5.81	22.9	6.17	22.9	6.35	22.8	6.54	22.7	6.90	
	-9.5	-10.0	23.6	5.57	23.5	5.93	23.4	6.29	23.4	6.47	23.3	6.65	23.3	7.00	
	-8.5	-9.1	24.1	5.69	24.0	6.04	23.9	6.39	23.9	6.57	23.9	6.74	23.8	7.09	
	-7.0	-7.6	25.0	5.89	24.9	6.23	24.8	6.57	24.8	6.73	24.7	6.90	24.6	7.24	
	-5.0	-5.6	26.2	6.15	26.2	6.47	26.1	6.79	26.0	6.95	26.0	7.11	25.9	7.43	
	-3.0	-3.7	27.5	6.39	27.4	6.69	27.3	7.00	27.3	7.15	27.3	7.30	27.2	7.61	
	0.0	-0.7	29.7	6.75	29.6	7.03	29.5	7.31	29.5	7.45	29.4	7.59	29.4	7.88	
	3.0	2.2	32.0	7.07	31.9	7.34	31.8	7.60	31.8	7.73	31.8	7.86	31.7	8.12	
	5.0	4.1	33.6	7.28	33.5	7.52	33.5	7.77	33.4	7.90	33.4	8.02	33.3	8.27	
	7.0	6.0	35.3	7.47	35.2	7.70	35.2	7.94	35.1	8.06	35.1	8.17	34.7	8.28	
	9.0	7.9	37.1	7.65	37.0	7.87	36.9	8.10	36.9	8.21	36.9	8.32	34.7	7.79	
11.0	9.8	39.0	7.82	38.9	8.03	38.8	8.25	38.8	8.35	37.8	8.14	34.7	7.33		
13.0	11.8	41.0	7.99	41.0	8.19	40.9	8.40	39.4	8.03	37.8	7.64	34.7	6.89		
15.0	13.7	43.1	8.15	43.0	8.34	41.0	7.93	39.4	7.56	37.8	7.20	34.7	6.50		
120% 33.60 kW	-19.8	-20.0	19.2	4.77	19.1	5.18	19.0	5.59	19.0	5.79	18.9	6.00	18.9	6.40	
	-18.8	-19.0	19.5	4.89	19.4	5.29	19.3	5.69	19.3	5.89	19.3	6.09	19.2	6.49	
	-16.7	-17.0	20.2	5.12	20.1	5.51	20.1	5.89	20.0	6.08	20.0	6.28	19.9	6.66	
	-13.7	-15.0	21.1	5.36	21.0	5.73	20.9	6.10	20.9	6.29	20.8	6.47	20.7	6.84	
	-11.8	-13.0	22.0	5.61	21.9	5.97	21.8	6.32	21.8	6.50	21.7	6.67	21.6	7.03	
	-9.8	-11.0	23.0	5.86	22.9	6.20	22.8	6.54	22.8	6.71	22.7	6.88	22.7	7.21	
	-9.5	-10.0	23.5	5.99	23.4	6.32	23.3	6.65	23.3	6.81	23.3	6.98	23.2	7.31	
	-8.5	-9.1	24.0	6.10	23.9	6.42	23.9	6.74	23.8	6.90	23.8	7.07	23.7	7.39	
	-7.0	-7.6	24.9	6.28	24.8	6.59	24.7	6.90	24.7	7.06	24.7	7.21	24.6	7.52	
	-5.0	-5.6	26.1	6.52	26.1	6.82	26.0	7.11	25.9	7.26	25.9	7.41	25.8	7.70	
	-3.0	-3.7	27.4	6.74	27.3	7.02	27.3	7.30	27.2	7.44	27.2	7.58	27.1	7.87	
	0.0	-0.7	29.6	7.07	29.5	7.33	29.4	7.59	29.4	7.72	29.4	7.85	29.3	8.11	
	3.0	2.2	31.9	7.38	31.8	7.62	31.8	7.86	31.7	7.98	31.7	8.10	31.6	8.34	
	5.0	4.1	33.5	7.56	33.5	7.79	33.4	8.02	33.3	8.13	33.3	8.25	32.0	7.99	
	7.0	6.0	35.2	7.74	35.2	7.96	35.1	8.17	35.0	8.28	34.9	8.35	32.0	7.52	
	9.0	7.9	37.0	7.91	36.9	8.11	36.9	8.32	36.3	8.25	34.9	7.85	32.0	7.08	
11.0	9.8	38.9	8.07	38.8	8.26	37.8	8.14	36.3	7.77	34.9	7.39	32.0	6.67		
13.0	11.8	40.9	8.23	40.7	8.36	37.8	7.64	36.3	7.29	34.9	6.95	32.0	6.28		
15.0	13.7	43.0	8.37	40.7	7.87	37.8	7.20	36.3	6.88	34.9	6.56	32.0	5.93		
110% 30.80 kW	-19.8	-20.0	19.1	5.28	19.0	5.66	18.9	6.03	18.9	6.22	18.9	6.40	18.8	6.78	
	-18.8	-19.0	19.4	5.39	19.3	5.75	19.3	6.12	19.2	6.30	19.2	6.49	19.1	6.85	
	-16.7	-17.0	20.1	5.60	20.1	5.96	20.0	6.31	19.9	6.49	19.9	6.66	19.8	7.02	
	-13.7	-15.0	21.0	5.83	20.9	6.16	20.8	6.50	20.8	6.67	20.7	6.84	20.7	7.18	
	-11.8	-13.0	21.9	6.05	21.8	6.38	21.7	6.70	21.7	6.87	21.6	7.03	21.6	7.35	
	-9.8	-11.0	22.9	6.28	22.8	6.59	22.7	6.90	22.7	7.06	22.7	7.21	22.6	7.52	
	-9.5	-10.0	23.4	6.40	23.3	6.70	23.3	7.00	23.2	7.15	23.2	7.31	23.1	7.61	
	-8.5	-9.1	23.9	6.50	23.8	6.80	23.8	7.09	23.7	7.24	23.7	7.39	23.6	7.68	
	-7.0	-7.6	24.8	6.67	24.7	6.95	24.6	7.24	24.6	7.38	24.6	7.52	24.5	7.81	
	-5.0	-5.6	26.0	6.89	26.0	7.16	25.9	7.43	25.9	7.57	25.8	7.70	25.8	7.97	
	-3.0	-3.7	27.3	7.09	27.2	7.35	27.2	7.61	27.1	7.74	27.1	7.87	27.0	8.12	
	0.0	-0.7	29.5	7.40	29.4	7.64	29.4	7.88	29.3	7.99	29.3	8.11	29.2	8.35	
	3.0	2.2	31.8	7.68	31.7	7.90	31.7	8.12	31.6	8.23	31.6	8.34	29.3	7.65	
	5.0	4.1	33.4	7.85	33.4	8.06	33.3	8.27	33.3	8.37	32.0	7.99	29.3	7.20	
	7.0	6.0	35.1	8.01	35.1	8.21	34.7	8.28	33.3	7.89	32.0	7.52	29.3	6.78	
	9.0	7.9	36.9	8.17	36.8	8.36	34.7	7.79	33.3	7.43	32.0	7.08	29.3	6.39	
11.0	9.8	38.8	8.31	37.3	8.02	34.7	7.33	33.3	7.00	32.0	6.67	29.3	6.03		
13.0	11.8	40.0	8.18	37.3	7.53	34.7	6.89	33.3	6.58	32.0	6.28	29.3	5.68		
15.0	13.7	40.0	7.70	37.3	7.10	34.7	6.50	33.3	6.22	32.0	5.93	29.3	5.38		
100% 28.00 kW	-19.8	-20.0	19.0	5.79	18.9	6.13	18.8	6.47	18.8	6.64	18.8	6.81	18.7	7.15	
	-18.8	-19.0	19.3	5.89	19.2	6.22	19.2	6.55	19.1	6.72	19.1	6.89	19.0	7.22	
	-16.7	-17.0	20.0	6.08	20.0	6.40	19.9	6.73	19.9	6.89	19.8	7.05	19.8	7.37	
	-13.7	-15.0	20.9	6.29	20.8	6.60	20.7	6.90	20.7	7.06	20.7	7.21	20.6	7.52	
	-11.8	-13.0	21.8	6.50	21.7	6.79	21.6	7.09	21.6	7.23	21.6	7.38	21.5	7.68	
	-9.8	-11.0	22.8	6.71	22.7	6.99	22.6	7.27	22.6	7.41	22.6	7.55	22.5	7.83	
	-9.5	-10.0	23.3	6.81	23.2	7.09	23.2	7.36	23.1	7.50	23.1	7.64	23.0	7.91	
	-8.5	-9.1	23.8	6.90	23.7	7.17	23.7	7.44	23.6	7.58	23.6	7.71	23.5	7.98	
	-7.0	-7.6	24.7	7.06	24.6	7.32	24.6	7.58	24.5	7.71	24.5	7.84	24.4	8.09	
	-5.0	-5.6	25.9	7.26	25.9	7.51	25.8	7.75	25.8	7.87	25.7	8.00	25.7	8.24	
	-3.0	-3.7	27.2	7.44	27.2	7.68	27.1	7.91	27.1	8.03	27.0	8.15	26.7	8.23	
	0.0	-0.7	29.4	7.72	29.3	7.94	29.3	8.16	29.2	8.27	29.1	8.31	26.7	7.48	
	3.0	2.2	31.7	7.98	31.7	8.18	31.5	8.34	30.3	7.95	29.1	7.57	26.7	6.83	
	5.0	4.1	33.3	8.13	33.3	8.32	31.5	7.84	30.3	7.48	29.1	7.13	26.7	6.43	
	7.0	6.0	35.0	8.28	33.9	8.07	31.5	7.38	30.3	7.04	29.1	6.71	26.7	6.07	
	9.0	7.9	36.3	8.25	33.9	7.59	31.5	6.95	30.3	6.64	29.1	6.33	26.7	5.73	
11.0	9.8	36.3	7.77	33.9	7.15	31.5	6.55	30.3	6.26	29.1	5.98	26.7	5.42		
13.0	11.8	36.3	7.29	33.9	6.72	31.5	6.17	30.3	5.90	29.1	5.63	26.7	5.11		
15.0	13.7	36.3	6.88	33.9	6.35	31.5	5.83	30.3	5.58	29.1	5.33	26.7	4.84		

NOTES - ANMERKUNGEN - Σημειώσεις - NOTAS - REMARQUES - NOTE - OPMERKINGEN - примечания - NOTLAR

- █ is shown as reference. When selecting the unit models, avoid the Outdoor air temperature range shown by █.

█ dient als Verweis. Vermeiden Sie bei der Auswahl der Gerätemodelle den als markierten Temperaturbereich der Außenluft.

Н █ είναι ενδεικτική, κατά την επιλογή των μοντέλων των μονάδων, αποφεύγετε το εύρος θερμοκρασίας εξωτερικού αέρα που υποδεικνύεται █.

█ se muestra como referencia. Cuando seleccione los modelos de unidad, evite el intervalo de temperaturas del aire exterior indicado mediante █.

█ est montré comme référence. Lors du choix des modèles d'unités, évitez la plage de températures de l'air extérieur illustré par █.

█ valori riportati unicamente come riferimento. Nel selezionare i modelli delle unità, non considerare i valori di temperatura dell'aria esterna indicati con il colore █.

█ is als referentie getoond. Wanneer modellen van eenheden worden gekozen, vermijd dan het bereik van buitenluchttemperaturen geïllustreerd door █.

█ показан как. При выборе модели устройства избегайте внешнюю температуру воздуха, указанную в █.

█ referans olarak gösterilmektedir. Ünite modellerini seçerken, belirtilen Dış hava sıcaklığı aralığından kaçınınız █.
- The above table shows the average value of conditions which may occur.

Die obige Tabelle zeigt den Durchschnittswert der Bedingungen, die auftreten können.

Στον παραπάνω πίνακα αναγράφεται η μέση τιμή για συνθήκες που μπορεί να προκύψουν.

La tabla de arriba muestra el valor medio de condiciones que pueden ocurrir.

Le tableau ci-dessus donne la valeur moyenne pour des conditions qui peuvent survenir.

La tabella in alto mostra il valore delle condizioni medie che si possono riscontrare.

De tabel hierboven geeft de gemiddelde waarde aan van situaties die kunnen voorvallen.

Таблица расположенная выше показывает среднее значение условий, которые могут наступить.

Yukarıdaki tablo meydana gelebilecek koşulların ortalama değerini göstermektedir.

3D079549

5 Таблицы производительности

5 - 2 Таблицы теплопроизводительностей

5

RYYQ10T														
Indoor air temp. °CDB														
Combination(%) (Capacity index)	Outdoor air temp.		16.0		18.0		20.0		21.0		22.0		24.0	
			TC	PI	TC	PI	TC	PI	TC	PI	TC	PI	TC	PI
	(°CDB)	(°CWB)	KW	KW	KW	KW	KW	KW	KW	KW	KW	KW	KW	KW
90% 25.20 kW	-19.8	-20.0	18.9	6.30	18.8	6.61	18.8	6.91	18.7	7.07	18.7	7.22	18.6	7.53
	-18.8	-19.0	19.2	6.39	19.1	6.69	19.1	6.99	19.1	7.14	19.0	7.29	19.0	7.59
	-16.7	-17.0	19.9	6.57	19.9	6.85	19.8	7.14	19.8	7.29	19.8	7.43	19.7	7.72
	-13.7	-15.0	20.8	6.75	20.7	7.03	20.6	7.31	20.6	7.44	20.6	7.58	20.5	7.86
	-11.8	-13.0	21.7	6.94	21.6	7.20	21.5	7.47	21.5	7.60	21.5	7.74	21.4	8.00
	-9.8	-11.0	22.7	7.13	22.6	7.38	22.6	7.64	22.5	7.76	22.5	7.89	22.4	8.14
	-9.5	-10.0	23.2	7.22	23.1	7.47	23.1	7.72	23.1	7.84	23.0	7.96	23.0	8.21
	-8.5	-9.1	23.7	7.31	23.7	7.55	23.6	7.79	23.6	7.91	23.5	8.03	23.5	8.28
	-7.0	-7.6	24.6	7.45	24.5	7.68	24.5	7.91	24.4	8.03	24.4	8.15	24.0	8.18
	-5.0	-5.6	25.8	7.63	25.8	7.85	25.7	8.07	25.7	8.18	25.7	8.29	24.0	7.69
	-3.0	-3.7	27.1	7.80	27.1	8.01	27.0	8.22	27.0	8.32	26.2	8.05	24.0	7.25
	0.0	-0.7	29.3	8.05	29.2	8.24	28.4	8.06	27.3	7.69	26.2	7.32	24.0	6.60
	3.0	2.2	31.6	8.28	30.5	8.03	28.4	7.34	27.3	7.01	26.2	6.68	24.0	6.04
	5.0	4.1	32.7	8.21	30.5	7.55	28.4	6.92	27.3	6.60	26.2	6.30	24.0	5.70
	7.0	6.0	32.7	7.72	30.5	7.11	28.4	6.52	27.3	6.23	26.2	5.94	24.0	5.39
	9.0	7.9	32.7	7.27	30.5	6.70	28.4	6.15	27.3	5.88	26.2	5.61	24.0	5.10
	11.0	9.8	32.7	6.85	30.5	6.32	28.4	5.81	27.3	5.55	26.2	5.31	24.0	4.82
13.0	11.8	32.7	6.44	30.5	5.95	28.4	5.47	27.3	5.24	26.2	5.01	24.0	4.56	
15.0	13.7	32.7	6.09	30.5	5.63	28.4	5.18	27.3	4.96	26.2	4.75	24.0	4.33	
80% 22.40 kW	-19.8	-20.0	18.8	6.81	18.7	7.08	18.7	7.36	18.6	7.49	18.6	7.63	18.6	7.90
	-18.8	-19.0	19.1	6.89	19.0	7.16	19.0	7.42	19.0	7.56	18.9	7.69	18.9	7.96
	-16.7	-17.0	19.8	7.05	19.8	7.30	19.7	7.56	19.7	7.69	19.7	7.82	19.6	8.08
	-13.7	-15.0	20.7	7.21	20.6	7.46	20.5	7.71	20.5	7.83	20.5	7.95	20.4	8.20
	-11.8	-13.0	21.6	7.38	21.5	7.62	21.5	7.85	21.4	7.97	21.4	8.09	21.3	8.31
	-9.8	-11.0	22.6	7.55	22.5	7.78	22.5	8.00	22.4	8.11	22.4	8.23	21.3	7.85
	-9.5	-10.0	23.1	7.64	23.1	7.85	23.0	8.07	23.0	8.18	23.0	8.29	21.3	7.62
	-8.5	-9.1	23.6	7.71	23.6	7.93	23.5	8.14	23.5	8.25	23.3	8.25	21.3	7.42
	-7.0	-7.6	24.5	7.84	24.4	8.04	24.4	8.25	24.2	8.28	23.3	7.88	21.3	7.10
	-5.0	-5.6	25.7	8.00	25.7	8.19	25.2	8.17	24.2	7.79	23.3	7.41	21.3	6.69
	-3.0	-3.7	27.0	8.15	27.0	8.33	25.2	7.69	24.2	7.34	23.3	6.99	21.3	6.31
	0.0	-0.7	29.1	8.31	27.1	7.65	25.2	7.00	24.2	6.68	23.3	6.37	21.3	5.77
	3.0	2.2	29.1	7.57	27.1	6.97	25.2	6.39	24.2	6.11	23.3	5.83	21.3	5.29
	5.0	4.1	29.1	7.13	27.1	6.57	25.2	6.03	24.2	5.77	23.3	5.51	21.3	5.00
	7.0	6.0	29.1	6.71	27.1	6.20	25.2	5.69	24.2	5.45	23.3	5.21	21.3	4.73
	9.0	7.9	29.1	6.33	27.1	5.85	25.2	5.38	24.2	5.15	23.3	4.93	21.3	4.48
	11.0	9.8	29.1	5.98	27.1	5.53	25.2	5.09	24.2	4.88	23.3	4.67	21.3	4.25
13.0	11.8	29.1	5.63	27.1	5.21	25.2	4.81	24.2	4.61	23.3	4.41	21.3	4.03	
15.0	13.7	29.1	5.33	27.1	4.94	25.2	4.56	24.2	4.37	23.3	4.19	21.3	3.83	
70% 19.60 kW	-19.8	-20.0	18.7	7.32	18.6	7.56	18.6	7.80	18.6	7.92	18.5	8.04	18.5	8.27
	-18.8	-19.0	19.0	7.39	19.0	7.62	18.9	7.86	18.9	7.97	18.9	8.09	18.7	8.21
	-16.7	-17.0	19.7	7.53	19.7	7.75	19.6	7.98	19.6	8.09	19.6	8.20	18.7	7.84
	-13.7	-15.0	20.6	7.68	20.5	7.89	20.5	8.11	20.4	8.21	20.4	8.28	18.7	7.45
	-11.8	-13.0	21.5	7.82	21.4	8.03	21.4	8.24	21.2	8.25	20.4	7.85	18.7	7.07
	-9.8	-11.0	22.5	7.97	22.4	8.17	22.1	8.17	21.2	7.79	20.4	7.42	18.7	6.69
	-9.5	-10.0	23.0	8.05	23.0	8.24	22.1	7.94	21.2	7.57	20.4	7.21	18.7	6.51
	-8.5	-9.1	23.5	8.11	23.5	8.30	22.1	7.73	21.2	7.37	20.4	7.02	18.7	6.34
	-7.0	-7.6	24.4	8.22	23.7	8.08	22.1	7.39	21.2	7.05	20.4	6.72	18.7	6.08
	-5.0	-5.6	25.4	8.26	23.7	7.60	22.1	6.96	21.2	6.64	20.4	6.33	18.7	5.73
	-3.0	-3.7	25.4	7.78	23.7	7.16	22.1	6.56	21.2	6.27	20.4	5.98	18.7	5.42
	0.0	-0.7	25.4	7.08	23.7	6.53	22.1	5.99	21.2	5.73	20.4	5.47	18.7	4.97
	3.0	2.2	25.4	6.47	23.7	5.97	22.1	5.49	21.2	5.26	20.4	5.02	18.7	4.57
	5.0	4.1	25.4	6.10	23.7	5.64	22.1	5.19	21.2	4.97	20.4	4.75	18.7	4.33
	7.0	6.0	25.4	5.76	23.7	5.33	22.1	4.91	21.2	4.71	20.4	4.50	18.7	4.11
	9.0	7.9	25.4	5.44	23.7	5.04	22.1	4.65	21.2	4.46	20.4	4.27	18.7	3.90
	11.0	9.8	25.4	5.14	23.7	4.77	22.1	4.41	21.2	4.23	20.4	4.05	18.7	3.71
13.0	11.8	25.4	4.86	23.7	4.51	22.1	4.17	21.2	4.00	20.4	3.84	18.7	3.52	
15.0	13.7	25.4	4.61	23.7	4.28	22.1	3.96	21.2	3.81	20.4	3.65	18.7	3.35	
60% 16.80 kW	-19.8	-20.0	18.6	7.83	18.5	8.04	18.5	8.24	18.2	8.13	17.4	7.74	16.0	6.97
	-18.8	-19.0	18.9	7.89	18.9	8.09	18.8	8.29	18.2	7.95	17.4	7.57	16.0	6.83
	-16.7	-17.0	19.6	8.01	19.6	8.20	18.9	7.96	18.2	7.59	17.4	7.23	16.0	6.53
	-13.7	-15.0	20.5	8.14	20.4	8.28	18.9	7.57	18.2	7.22	17.4	6.88	16.0	6.22
	-11.8	-13.0	21.4	8.27	20.4	7.85	18.9	7.18	18.2	6.85	17.4	6.53	16.0	5.91
	-9.8	-11.0	21.8	8.06	20.4	7.42	18.9	6.79	18.2	6.49	17.4	6.19	16.0	5.61
	-9.5	-10.0	21.8	7.83	20.4	7.21	18.9	6.61	18.2	6.31	17.4	6.02	16.0	5.46
	-8.5	-9.1	21.8	7.63	20.4	7.02	18.9	6.44	18.2	6.15	17.4	5.87	16.0	5.32
	-7.0	-7.6	21.8	7.29	20.4	6.72	18.9	6.17	18.2	5.90	17.4	5.63	16.0	5.11
	-5.0	-5.6	21.8	6.87	20.4	6.33	18.9	5.82	18.2	5.57	17.4	5.32	16.0	4.83
	-3.0	-3.7	21.8	6.48	20.4	5.98	18.9	5.50	18.2	5.27	17.4	5.04	16.0	4.58
	0.0	-0.7	21.8	5.92	20.4	5.47	18.9	5.04	18.2	4.83	17.4	4.62	16.0	4.21
	3.0	2.2	21.8	5.42	20.4	5.02	18.9	4.64	18.2	4.45	17.4	4.26	16.0	3.89
	5.0	4.1	21.8	5.13	20.4	4.75	18.9	4.39	18.2	4.21	17.4	4.04	16.0	3.69
	7.0	6.0	21.8	4.85	20.4	4.50	18.9	4.16	18.2	4.00	17.4	3.83	16.0	3.51
	9.0	7.9	21.8	4.59	20.4	4.27	18.9	3.95	18.2	3.80	17.4	3.64	16.0	3.34
	11.0	9.8	21.8	4.36	20.4	4.05	18.9	3.75	18.2	3.61	17.4	3.46	16.0	3.18
13.0	11.8	21.8	4.12	20.4	3.84	18.9	3.56	18.2	3.43	17.4	3.29	16.0	3.03	
15.0	13.7	21.8	3.92	20.4	3.65	18.9	3.39	18.2	3.26	17.4	3.14	16.0	2.89	
50% 14.00 kW	-19.8	-20.0	18.2	8.13	17.0	7.48	15.8	6.85	15.1	6.54	14.5	6.24	13.3	5.65
	-18.8	-19.0	18.2	7.95	17.0	7.32	15.8	6.70	15.1	6.40	14.5	6.11	13.3	5.53
	-16.7	-17.0	18.2	7.59	17.0	6.99	15.8	6.41	15.1	6.13	14.5	5.85	13.3	5.30
	-13.7	-15.0	18.2	7.22	17.0	6.66	15.8	6.11	15.1	5.84	14.5	5.58	13.3	5.06
	-11.8	-13.0	18.2	6.85	17.0	6.32	15.8	5.81	15.1	5.56	14.5	5.31	13.3	4.82
	-9.8	-11.0	18.2	6.49	17.0	5.99	15.8	5.51	15.1	5.27	14.5	5.04	13.3	4.59
	-9.5	-10.0	18.2	6.31	17.0	5.83	15.8	5.36	15.1	5.14	14.5	4.91	13.3	4.47
	-8.5	-9.1	18.2	6.15	17.0	5.69	15.8	5.23	15.1	5.01	14.5	4.79	13.3	4.37
	-7.0	-7.6	18.2	5.90	17.0	5.45	15.8	5.02	15.1	4.81	14.5	4.60	13.3	4.20
	-5.0	-5.6	18.2	5.57	17.0	5.15	15.8	4.75	15.1	4.56	14.5	4.36	13.3	3.98
	-3.0	-3.7	18.2	5.27	17.0	4.88	15.8	4.51	15.1	4.32	14.5	4.14	13.3	3.79
	0.0	-0.7	18.2	4.83	17.0	4.48	15.8							

5 Таблицы производительности

5 - 2 Таблицы теплопроизводительностей

RXYQ12T		Indoor air temp. °CDB												TC: Total capacity (kW); PI: Power Input (kW) (Comp. + Outdoor fan motor)	
Combination(%) (Capacity index)	Outdoor air temp.		16.0		18.0		20.0		21.0		22.0		24.0		
	(°CDB)	(°CWB)	TC	PI	TC	PI	TC	PI	TC	PI	TC	PI	TC	PI	
			KW	KW	KW	KW	KW	KW	KW	KW	KW	KW	KW	KW	KW
130% 43.55 kW	-19.8	-20.0	21.6	4.29	21.5	4.84	21.4	5.39	21.3	5.66	21.3	5.94	21.2	6.49	
	-18.8	-19.0	21.9	4.44	21.8	4.98	21.7	5.52	21.7	5.79	21.6	6.06	21.5	6.60	
	-16.7	-17.0	22.7	4.75	22.6	5.27	22.5	5.79	22.5	6.05	22.4	6.31	22.3	6.82	
	-13.7	-15.0	23.7	5.07	23.6	5.57	23.5	6.07	23.4	6.32	23.4	6.57	23.3	7.06	
	-11.8	-13.0	24.7	5.40	24.6	5.88	24.5	6.35	24.4	6.59	24.4	6.83	24.3	7.30	
	-9.8	-11.0	25.8	5.73	25.7	6.19	25.6	6.64	25.5	6.87	25.5	7.09	25.4	7.55	
	-9.5	-10.0	26.4	5.90	26.3	6.34	26.2	6.78	26.1	7.01	26.1	7.23	26.0	7.67	
	-8.5	-9.1	27.0	6.05	26.9	6.48	26.8	6.91	26.7	7.13	26.7	7.34	26.6	7.78	
	-7.0	-7.6	27.9	6.29	27.8	6.71	27.7	7.12	27.7	7.33	27.6	7.54	27.5	7.96	
	-5.0	-5.6	29.3	6.60	29.2	7.00	29.1	7.40	29.1	7.59	29.0	7.79	28.9	8.19	
	-3.0	-3.7	30.8	6.89	30.7	7.27	30.6	7.65	30.5	7.84	30.5	8.02	30.4	8.40	
	0.0	-0.7	33.2	7.33	33.1	7.68	33.0	8.03	32.9	8.20	32.9	8.38	32.8	8.72	
	3.0	2.2	35.8	7.73	35.7	8.05	35.6	8.37	35.5	8.53	35.5	8.69	35.4	9.01	
	5.0	4.1	37.6	7.97	37.5	8.28	37.4	8.58	37.3	8.73	37.3	8.89	37.2	9.19	
	7.0	6.0	39.5	8.20	39.4	8.49	39.3	8.78	39.2	8.93	39.2	9.07	39.1	9.36	
	9.0	7.9	41.5	8.42	41.4	8.70	41.3	8.97	41.2	9.11	41.2	9.25	41.0	9.53	
11.0	9.8	43.5	8.63	43.4	8.89	43.3	9.15	43.3	9.28	43.2	9.42	41.3	9.03		
13.0	11.8	45.8	8.83	45.7	9.08	45.6	9.33	45.6	9.46	45.0	9.41	41.3	8.48		
15.0	13.7	48.1	9.02	48.0	9.25	47.9	9.49	47.9	9.31	45.0	8.87	41.3	8.00		
120% 40.20 kW	-19.8	-20.0	21.5	4.92	21.4	5.43	21.3	5.94	21.2	6.19	21.2	6.44	21.1	6.95	
	-18.8	-19.0	21.8	5.06	21.7	5.56	21.6	6.06	21.6	6.31	21.5	6.55	21.4	7.05	
	-16.7	-17.0	22.6	5.35	22.5	5.83	22.4	6.31	22.4	6.55	22.3	6.78	22.3	7.26	
	-13.7	-15.0	23.5	5.65	23.5	6.11	23.4	6.57	23.3	6.79	23.3	7.02	23.2	7.48	
	-11.8	-13.0	24.6	5.95	24.5	6.39	24.4	6.83	24.3	7.05	24.3	7.27	24.2	7.71	
	-9.8	-11.0	25.7	6.26	25.6	6.68	25.5	7.09	25.4	7.30	25.4	7.51	25.3	7.93	
	-9.5	-10.0	26.3	6.41	26.2	6.82	26.1	7.23	26.0	7.43	26.0	7.63	25.9	8.04	
	-8.5	-9.1	26.8	6.55	26.8	6.94	26.7	7.34	26.6	7.54	26.6	7.74	26.5	8.14	
	-7.0	-7.6	27.8	6.77	27.7	7.15	27.6	7.54	27.6	7.73	27.5	7.92	27.4	8.31	
	-5.0	-5.6	29.2	7.06	29.1	7.43	29.0	7.79	29.0	7.97	28.9	8.16	28.8	8.52	
	-3.0	-3.7	30.6	7.33	30.6	7.68	30.5	8.02	30.4	8.20	30.4	8.37	30.3	8.72	
	0.0	-0.7	33.1	7.73	33.0	8.05	32.9	8.38	32.8	8.54	32.8	8.70	32.7	9.02	
	3.0	2.2	35.7	8.10	35.6	8.40	35.5	8.69	35.4	8.84	35.4	8.99	35.3	9.29	
	5.0	4.1	37.5	8.32	37.4	8.61	37.3	8.89	37.2	9.03	37.2	9.17	37.1	9.45	
	7.0	6.0	39.4	8.54	39.3	8.81	39.2	9.07	39.1	9.21	39.1	9.34	38.1	9.27	
	9.0	7.9	41.3	8.74	41.2	8.99	41.2	9.25	41.1	9.38	41.1	9.50	38.1	8.72	
11.0	9.8	43.4	8.93	43.3	9.17	43.2	9.42	43.2	9.54	41.5	9.11	38.1	8.22		
13.0	11.8	45.7	9.12	45.6	9.35	45.0	9.41	43.3	8.98	41.5	8.55	38.1	7.73		
15.0	13.7	48.0	9.29	47.9	9.51	45.0	8.87	43.3	8.46	41.5	8.07	38.1	7.30		
110% 36.85 kW	-19.8	-20.0	21.3	5.56	21.2	6.02	21.2	6.49	21.1	6.72	21.1	6.95	21.0	7.41	
	-18.8	-19.0	21.7	5.68	21.6	6.14	21.5	6.60	21.5	6.82	21.4	7.05	21.4	7.51	
	-16.7	-17.0	22.5	5.95	22.4	6.39	22.3	6.82	22.3	7.04	22.3	7.26	22.2	7.70	
	-13.7	-15.0	23.4	6.22	23.3	6.64	23.3	7.06	23.2	7.27	23.2	7.48	23.1	7.90	
	-11.8	-13.0	24.4	6.50	24.4	6.90	24.3	7.30	24.2	7.51	24.2	7.71	24.1	8.11	
	-9.8	-11.0	25.6	6.78	25.5	7.16	25.4	7.55	25.4	7.74	25.3	7.93	25.2	8.31	
	-9.5	-10.0	26.2	6.92	26.1	7.29	26.0	7.67	25.9	7.86	25.9	8.04	25.8	8.42	
	-8.5	-9.1	26.7	7.04	26.6	7.41	26.6	7.78	26.5	7.96	26.5	8.14	26.4	8.51	
	-7.0	-7.6	27.7	7.25	27.6	7.60	27.5	7.96	27.5	8.13	27.4	8.31	27.4	8.66	
	-5.0	-5.6	29.1	7.52	29.0	7.85	28.9	8.19	28.9	8.36	28.8	8.52	28.8	8.86	
	-3.0	-3.7	30.5	7.76	30.4	8.08	30.4	8.40	30.3	8.56	30.3	8.72	30.2	9.04	
	0.0	-0.7	33.0	8.13	32.9	8.43	32.8	8.72	32.7	8.87	32.7	9.02	32.6	9.31	
	3.0	2.2	35.5	8.47	35.5	8.74	35.4	9.01	35.3	9.15	35.3	9.29	34.9	9.44	
	5.0	4.1	37.3	8.68	37.3	8.93	37.2	9.19	37.1	9.32	37.1	9.45	34.9	8.88	
	7.0	6.0	39.2	8.87	39.1	9.12	39.1	9.36	39.0	9.49	38.1	9.27	34.9	8.36	
	9.0	7.9	41.2	9.06	41.1	9.29	41.0	9.53	39.7	9.16	38.1	8.72	34.9	7.88	
11.0	9.8	43.3	9.23	43.2	9.46	41.3	9.03	39.7	8.62	38.1	8.22	34.9	7.43		
13.0	11.8	45.6	9.41	44.4	9.26	41.3	8.48	39.7	8.10	38.1	7.73	34.9	7.00		
15.0	13.7	47.6	9.48	44.4	8.73	41.3	8.00	39.7	7.65	38.1	7.30	34.9	6.62		
100% 33.50 kW	-19.8	-20.0	21.2	6.19	21.1	6.61	21.1	7.03	21.0	7.25	21.0	7.46	20.9	7.88	
	-18.8	-19.0	21.6	6.31	21.5	6.72	21.4	7.13	21.4	7.34	21.3	7.55	21.3	7.96	
	-16.7	-17.0	22.4	6.55	22.3	6.94	22.2	7.34	22.2	7.54	22.2	7.74	22.1	8.14	
	-13.7	-15.0	23.3	6.79	23.2	7.18	23.2	7.56	23.1	7.75	23.1	7.94	23.0	8.32	
	-11.8	-13.0	24.3	7.05	24.2	7.41	24.2	7.78	24.1	7.96	24.1	8.15	24.0	8.51	
	-9.8	-11.0	25.4	7.30	25.4	7.65	25.3	8.00	25.3	8.18	25.2	8.35	25.1	8.70	
	-9.5	-10.0	26.0	7.43	26.0	7.77	25.9	8.11	25.9	8.28	25.8	8.45	25.7	8.79	
	-8.5	-9.1	26.6	7.54	26.5	7.88	26.5	8.21	26.4	8.38	26.4	8.54	26.3	8.88	
	-7.0	-7.6	27.6	7.73	27.5	8.05	27.4	8.37	27.4	8.53	27.4	8.69	27.3	9.01	
	-5.0	-5.6	29.0	7.97	28.9	8.28	28.8	8.58	28.8	8.74	28.8	8.89	28.7	9.19	
	-3.0	-3.7	30.4	8.20	30.3	8.49	30.3	8.78	30.2	8.92	30.2	9.07	30.1	9.36	
	0.0	-0.7	32.8	8.54	32.8	8.80	32.7	9.07	32.6	9.21	32.6	9.34	31.7	9.24	
	3.0	2.2	35.4	8.84	35.3	9.09	35.3	9.34	35.2	9.46	34.6	9.34	31.7	8.43	
	5.0	4.1	37.2	9.03	37.1	9.26	37.1	9.50	36.1	9.23	34.6	8.79	31.7	7.94	
	7.0	6.0	39.1	9.21	39.0	9.43	37.5	9.10	36.1	8.68	34.6	8.28	31.7	7.48	
	9.0	7.9	41.1	9.38	40.4	9.36	37.5	8.57	36.1	8.18	34.6	7.80	31.7	7.06	
11.0	9.8	43.2	9.54	40.4	8.81	37.5	8.07	36.1	7.71	34.6	7.36	31.7	6.67		
13.0	11.8	43.3	8.98	40.4	8.28	37.5	7.59	36.1	7.26	34.6	6.93	31.7	6.29		
15.0	13.7	43.3	8.46	40.4	7.81	37.5	7.17	36.1	6.86	34.6	6.56	31.7	5.96		

NOTES - ANMERKUNGEN - Σημειώσεις - NOTAS - REMARQUES - NOTE - OPMERKINGEN - примечания - NOTLAR

- █ is shown as reference. When selecting the unit models, avoid the Outdoor air temperature range shown by █.

█ dient als Verweis. Vermeiden Sie bei der Auswahl der Gerätemodelle den als markierten Temperaturbereich der Außenluft.

Н █ είναι ενδεικτική, κατά την επιλογή των μοντέλων των μονάδων, αποφεύγετε το εύρος θερμοκρασίας εξωτερικού αέρα που υποδεικνύεται █.

█ se muestra como referencia. Cuando seleccione los modelos de unidad, evite el intervalo de temperaturas del aire exterior indicado mediante █.

█ est montré comme référence. Lors du choix des modèles d'unités, évitez la plage de températures de l'air extérieur illustré par █.

█ valori riportati unicamente come riferimento. Nel selezionare i modelli delle unità, non considerare i valori di temperatura dell'aria esterna indicati con il colore █.

█ is als referentie getoond. Wanneer modellen van eenheden worden gekozen, vermijd dan het bereik van buitenluchttemperaturen geïllustreerd door █.

█ показан как. При выборе модели устройства избегайте внешнюю температуру воздуха, указанную в █.

█ referans olarak gösterilmektedir. Ünite modellerini seçerken, belirtilen Dış hava sıcaklığı aralığından kaçınınız █.
- The above table shows the average value of conditions which may occur.

Die obige Tabelle zeigt den Durchschnittswert der Bedingungen, die auftreten können.

Στον παραπάνω πίνακα αναγράφεται η μέση τιμή για συνθήκες που μπορεί να προκύψουν.

La tabla de arriba muestra el valor medio de condiciones que pueden ocurrir.

Le tableau ci-dessus donne la valeur moyenne pour des conditions qui peuvent survenir.

La tabella in alto mostra il valore delle condizioni medie che si possono riscontrare.

De tabel hierboven geeft de gemidd

5 Таблицы производительности

5 - 2 Таблицы теплопроизводительностей

5

RXYQ12T														
Indoor air temp. °CDB														
Combination(%) (Capacity index)	Outdoor air temp.		16.0		18.0		20.0		21.0		22.0		24.0	
			TC	PI	TC	PI	TC	PI	TC	PI	TC	PI	TC	PI
	(°CDB)	(°CWB)	KW	KW	KW	KW	KW	KW	KW	KW	KW	KW	KW	KW
90% 30.15 kW	-19.8	-20.0	21.1	6.82	21.0	7.20	21.0	7.58	20.9	7.77	20.9	7.96	20.8	8.34
	-18.8	-19.0	21.5	6.93	21.4	7.30	21.3	7.67	21.3	7.86	21.2	8.05	21.2	8.42
	-16.7	-17.0	22.3	7.14	22.2	7.50	22.1	7.86	22.1	8.04	22.1	8.22	22.0	8.58
	-13.7	-15.0	23.2	7.37	23.1	7.71	23.0	8.06	23.0	8.23	23.0	8.40	22.9	8.74
	-11.8	-13.0	24.2	7.60	24.1	7.93	24.1	8.25	24.0	8.42	24.0	8.58	23.9	8.91
	-9.8	-11.0	25.3	7.83	25.3	8.14	25.2	8.45	25.2	8.61	25.1	8.77	25.0	9.08
	-9.5	-10.0	25.9	7.94	25.9	8.25	25.8	8.55	25.8	8.71	25.7	8.86	25.6	9.17
	-8.5	-9.1	26.5	8.04	26.4	8.34	26.3	8.64	26.3	8.79	26.3	8.94	26.2	9.24
	-7.0	-7.6	27.5	8.21	27.4	8.50	27.3	8.79	27.3	8.93	27.3	9.08	27.2	9.37
	-5.0	-5.6	28.9	8.43	28.8	8.71	28.7	8.98	28.7	9.12	28.7	9.25	28.6	9.51
	-3.0	-3.7	30.3	8.63	30.2	8.89	30.1	9.16	30.1	9.29	30.1	9.42	28.6	8.96
	0.0	-0.7	32.7	8.94	32.7	9.18	32.6	9.42	32.5	9.50	31.2	9.04	28.6	8.16
	3.0	2.2	35.3	9.21	35.2	9.44	33.8	9.07	32.5	8.65	31.2	8.25	28.6	7.46
	5.0	4.1	37.1	9.38	36.3	9.32	33.8	8.53	32.5	8.15	31.2	7.77	28.6	7.04
	7.0	6.0	38.9	9.52	36.3	8.77	33.8	8.04	32.5	7.68	31.2	7.33	28.6	6.64
	9.0	7.9	38.9	8.96	36.3	8.26	33.8	7.58	32.5	7.24	31.2	6.92	28.6	6.28
11.0	9.8	38.9	8.44	36.3	7.79	33.8	7.15	32.5	6.84	31.2	6.54	28.6	5.94	
13.0	11.8	38.9	7.93	36.3	7.33	33.8	6.74	32.5	6.45	31.2	6.17	28.6	5.61	
15.0	13.7	38.9	7.49	36.3	6.92	33.8	6.38	32.5	6.11	31.2	5.84	28.6	5.32	
80% 26.80 kW	-19.8	-20.0	21.0	7.46	20.9	7.79	20.9	8.13	20.8	8.30	20.8	8.47	20.7	8.81
	-18.8	-19.0	21.3	7.55	21.3	7.88	21.2	8.21	21.2	8.38	21.2	8.54	21.1	8.87
	-16.7	-17.0	22.2	7.74	22.1	8.06	22.0	8.38	22.0	8.54	22.0	8.70	21.9	9.02
	-13.7	-15.0	23.1	7.94	23.0	8.25	22.9	8.55	22.9	8.71	22.9	8.86	22.8	9.16
	-11.8	-13.0	24.1	8.15	24.0	8.44	24.0	8.73	23.9	8.88	23.9	9.02	23.8	9.31
	-9.8	-11.0	25.2	8.35	25.1	8.63	25.1	8.91	25.1	9.05	25.0	9.19	25.0	9.47
	-9.5	-10.0	25.8	8.45	25.7	8.72	25.7	9.00	25.7	9.13	25.6	9.27	25.4	9.44
	-8.5	-9.1	26.4	8.54	26.3	8.81	26.2	9.08	26.2	9.21	26.2	9.34	25.4	9.19
	-7.0	-7.6	27.4	8.69	27.3	8.95	27.2	9.21	27.2	9.33	27.2	9.46	25.4	8.79
	-5.0	-5.6	28.8	8.89	28.7	9.13	28.6	9.38	28.6	9.50	27.7	9.17	25.4	8.27
	-3.0	-3.7	30.2	9.07	30.1	9.30	30.0	9.51	28.8	9.07	27.7	8.64	25.4	7.81
	0.0	-0.7	32.6	9.34	32.3	9.44	30.0	8.64	28.8	8.26	27.7	7.87	25.4	7.12
	3.0	2.2	34.6	9.34	32.3	8.61	30.0	7.89	28.8	7.54	27.7	7.20	25.4	6.53
	5.0	4.1	34.6	8.79	32.3	8.11	30.0	7.44	28.8	7.12	27.7	6.80	25.4	6.17
	7.0	6.0	34.6	8.28	32.3	7.64	30.0	7.02	28.8	6.72	27.7	6.42	25.4	5.84
	9.0	7.9	34.6	7.80	32.3	7.21	30.0	6.63	28.8	6.35	27.7	6.07	25.4	5.53
11.0	9.8	34.6	7.36	32.3	6.81	30.0	6.27	28.8	6.01	27.7	5.75	25.4	5.24	
13.0	11.8	34.6	6.93	32.3	6.42	30.0	5.92	28.8	5.67	27.7	5.43	25.4	4.96	
15.0	13.7	34.6	6.56	32.3	6.08	30.0	5.61	28.8	5.38	27.7	5.15	25.4	4.71	
70% 23.45 kW	-19.8	-20.0	20.9	8.09	20.8	8.38	20.7	8.68	20.7	8.83	20.7	8.98	20.6	9.27
	-18.8	-19.0	21.2	8.17	21.2	8.46	21.1	8.75	21.1	8.90	21.1	9.04	21.0	9.33
	-16.7	-17.0	22.0	8.34	22.0	8.62	21.9	8.90	21.9	9.04	21.9	9.18	21.8	9.46
	-13.7	-15.0	23.0	8.51	22.9	8.78	22.8	9.05	22.8	9.18	22.8	9.32	22.8	9.24
	-11.8	-13.0	24.0	8.69	23.9	8.95	23.9	9.21	23.8	9.33	23.8	9.46	22.2	8.76
	-9.8	-11.0	25.1	8.87	25.0	9.12	25.0	9.36	25.0	9.48	24.2	9.19	22.2	8.29
	-9.5	-10.0	25.7	8.96	25.6	9.20	25.6	9.44	25.2	9.37	24.2	8.93	22.2	8.06
	-8.5	-9.1	26.3	9.04	26.2	9.27	26.1	9.51	25.2	9.13	24.2	8.70	22.2	7.85
	-7.0	-7.6	27.2	9.17	27.2	9.40	26.3	9.14	25.2	8.73	24.2	8.32	22.2	7.52
	-5.0	-5.6	28.6	9.34	28.3	9.40	26.3	8.60	25.2	8.22	24.2	7.83	22.2	7.09
	-3.0	-3.7	30.1	9.50	28.3	8.86	26.3	8.12	25.2	7.75	24.2	7.40	22.2	6.71
	0.0	-0.7	30.3	8.74	28.3	8.06	26.3	7.40	25.2	7.08	24.2	6.76	22.2	6.14
	3.0	2.2	30.3	7.98	28.3	7.37	26.3	6.78	25.2	6.49	24.2	6.20	22.2	5.64
	5.0	4.1	30.3	7.52	28.3	6.95	26.3	6.40	25.2	6.13	24.2	5.87	22.2	5.34
	7.0	6.0	30.3	7.10	28.3	6.57	26.3	6.05	25.2	5.80	24.2	5.55	22.2	5.07
	9.0	7.9	30.3	6.70	28.3	6.21	26.3	5.73	25.2	5.49	24.2	5.26	22.2	4.81
11.0	9.8	30.3	6.34	28.3	5.88	26.3	5.43	25.2	5.21	24.2	4.99	22.2	4.56	
13.0	11.8	30.3	5.98	28.3	5.55	26.3	5.13	25.2	4.93	24.2	4.73	22.2	4.33	
15.0	13.7	30.3	5.67	28.3	5.27	26.3	4.88	25.2	4.68	24.2	4.49	22.2	4.12	
60% 20.10 kW	-19.8	-20.0	20.7	8.72	20.7	8.98	20.6	9.23	20.6	9.36	20.6	9.48	19.0	8.66
	-18.8	-19.0	21.1	8.79	21.1	9.04	21.0	9.29	21.0	9.41	20.8	9.40	19.0	8.47
	-16.7	-17.0	21.9	8.94	21.9	9.18	21.8	9.42	21.6	9.42	20.8	8.97	19.0	8.10
	-13.7	-15.0	22.8	9.09	22.8	9.32	22.5	9.39	21.6	8.96	20.8	8.53	19.0	7.71
	-11.8	-13.0	23.9	9.24	23.8	9.46	22.5	8.90	21.6	8.49	20.8	8.10	19.0	7.32
	-9.8	-11.0	25.0	9.40	24.2	9.19	22.5	8.42	21.6	8.04	20.8	7.67	19.0	6.94
	-9.5	-10.0	25.6	9.47	24.2	8.93	22.5	8.18	21.6	7.82	20.8	7.46	19.0	6.76
	-8.5	-9.1	26.0	9.44	24.2	8.70	22.5	7.97	21.6	7.62	20.8	7.27	19.0	6.59
	-7.0	-7.6	26.0	9.03	24.2	8.32	22.5	7.63	21.6	7.30	20.8	6.97	19.0	6.32
	-5.0	-5.6	26.0	8.49	24.2	7.83	22.5	7.20	21.6	6.88	20.8	6.58	19.0	5.98
	-3.0	-3.7	26.0	8.01	24.2	7.40	22.5	6.80	21.6	6.51	20.8	6.22	19.0	5.66
	0.0	-0.7	26.0	7.31	24.2	6.76	22.5	6.23	21.6	5.97	20.8	5.71	19.0	5.20
	3.0	2.2	26.0	6.69	24.2	6.20	22.5	5.72	21.6	5.49	20.8	5.26	19.0	4.80
	5.0	4.1	26.0	6.33	24.2	5.87	22.5	5.42	21.6	5.20	20.8	4.98	19.0	4.56
	7.0	6.0	26.0	5.98	24.2	5.55	22.5	5.13	21.6	4.93	20.8	4.73	19.0	4.33
	9.0	7.9	26.0	5.66	24.2	5.26	22.5	4.87	21.6	4.68	20.8	4.49	19.0	4.12
11.0	9.8	26.0	5.36	24.2	4.99	22.5	4.62	21.6	4.45	20.8	4.27	19.0	3.92	
13.0	11.8	26.0	5.08	24.2	4.73	22.5	4.38	21.6	4.22	20.8	4.05	19.0	3.72	
15.0	13.7	26.0	4.82	24.2	4.49	22.5	4.17	21.6	4.02	20.8	3.86	19.0	3.55	
50% 16.75 kW	-19.8	-20.0	20.6	9.36	20.2	9.29	18.8	8.50	18.0	8.12	17.3	7.74	15.9	7.01
	-18.8	-19.0	21.0	9.41	20.2	9.09	18.8	8.32	18.0	7.95	17.3	7.58	15.9	6.87
	-16.7	-17.0	21.6	9.42	20.2	8.68	18.8	7.95	18.0	7.60	17.3	7.25	15.9	6.58
	-13.7	-15.0	21.6	8.96	20.2	8.26	18.8	7.58	18.0	7.24	17.3	6.92	15.9	6.28
	-11.8	-13.0	21.6	8.49	20.2	7.84	18.8	7.20	18.0	6.89	17.3	6.58	15.9	5.98
	-9.8	-11.0	21.6	8.04	20.2	7.42	18.8	6.83	18.0	6.53	17.3	6.24	15.9	5.68
	-9.5	-10.0	21.6	7.82	20.2	7.22	18.8	6.64	18.0	6.36	17.3	6.08	15.9	5.54
	-8.5	-9.1	21.6	7.62	20.2	7.04	18.8	6.48	18.0	6.21	17.3	5.94	15.9	5.41
	-7.0	-7.6	21.6	7.30	20.2	6.75	18.8	6.22	18.0	5.96	17.3	5.70	15.9	5.20
	-5.0	-5.6	21.6	6.88	20.2	6.37	18.8	5.88	18.0	5.63	17.3	5.39	15.9	4.93
	-3.0	-3.7	21.6	6.51	20.2	6.04	18.8	5.57	18.0	5.34	17.3	5.12	15.9	4.68
	0.0	-0.7	21.6	5.97	20.2	5.54	18.8	5.12	18.0	4.92	17.3	4.72		

5 Таблицы производительности

5 - 2 Таблицы теплопроизводительностей

RXYQ14T		Indoor air temp. °CDB												TC: Total capacity (kW); PI: Power Input (kW) (Comp. + Outdoor fan motor)	
Combination(%) (Capacity index)	Outdoor air temp.		16.0		18.0		20.0		21.0		22.0		24.0		
	(°CDB)	(°CWB)	TC	PI	TC	PI	TC	PI	TC	PI	TC	PI	TC	PI	
130% 52.00 kW	-19.8	-20.0	26.4	5.61	26.3	6.28	26.1	6.95	26.1	7.28	26.0	7.62	25.9	8.29	
	-18.8	-19.0	26.8	5.80	26.7	6.46	26.6	7.11	26.5	7.44	26.5	7.77	26.4	8.43	
	-16.7	-17.0	27.9	6.19	27.8	6.82	27.6	7.45	27.6	7.77	27.5	8.09	27.4	8.72	
	-13.7	-15.0	29.0	6.59	28.9	7.20	28.8	7.80	28.7	8.11	28.7	8.41	28.5	9.02	
	-11.8	-13.0	30.3	7.00	30.2	7.58	30.0	8.15	30.0	8.44	29.9	8.73	29.8	9.31	
	-9.8	-11.0	31.7	7.40	31.5	7.95	31.4	8.50	31.4	8.78	31.3	9.06	31.2	9.6	
	-9.5	-10.0	32.4	7.60	32.3	8.14	32.1	8.68	32.1	8.95	32.0	9.22	31.9	9.8	
	-8.5	-9.1	33.1	7.78	33.0	8.30	32.8	8.83	32.8	9.10	32.7	9.36	32.6	9.9	
	-7.0	-7.6	34.3	8.07	34.1	8.58	34.0	9.09	34.0	9.34	33.9	9.6	33.8	10.1	
	-5.0	-5.6	36.0	8.45	35.8	8.93	35.7	9.4	35.7	9.7	35.6	9.9	35.5	10.4	
	-3.0	-3.7	37.7	8.80	37.5	9.26	37.4	9.7	37.4	10.0	37.3	10.2	37.2	10.6	
	0.0	-0.7	40.6	9.3	40.5	9.7	40.3	10.2	40.3	10.4	40.2	10.6	40.1	11.0	
	3.0	2.2	43.7	9.8	43.5	10.2	43.4	10.6	43.4	10.8	43.3	11.0	43.2	11.4	
	5.0	4.1	45.8	10.1	45.7	10.5	45.6	10.8	45.5	11.0	45.4	11.2	45.3	11.6	
	7.0	6.0	48.0	10.4	47.9	10.7	47.8	11.1	47.7	11.3	47.7	11.4	47.6	11.8	
	9.0	7.9	50.4	10.6	50.3	11.0	50.2	11.3	50.1	11.5	50.0	11.6	49.5	11.8	
11.0	9.8	52.9	10.9	52.7	11.2	52.6	11.5	52.5	11.7	52.5	11.8	49.5	11.2		
13.0	11.8	55.6	11.1	55.4	11.4	55.3	11.7	55.2	11.9	54.0	11.6	49.5	10.5		
15.0	13.7	58.2	11.3	58.1	11.6	58.0	11.9	56.3	11.5	54.0	11.0	49.5	9.9		
120% 48.00 kW	-19.8	-20.0	26.2	6.38	26.1	7.00	26.0	7.62	26.0	7.93	25.9	8.24	25.8	8.86	
	-18.8	-19.0	26.7	6.56	26.6	7.16	26.5	7.77	26.4	8.08	26.4	8.38	26.3	8.99	
	-16.7	-17.0	27.7	6.92	27.6	7.50	27.5	8.09	27.5	8.38	27.4	8.67	27.3	9.26	
	-13.7	-15.0	28.9	7.29	28.8	7.85	28.7	8.41	28.6	8.69	28.5	8.97	28.4	9.53	
	-11.8	-13.0	30.1	7.66	30.0	8.20	29.9	8.73	29.9	9.00	29.8	9.27	29.7	9.8	
	-9.8	-11.0	31.5	8.04	31.4	8.55	31.3	9.06	31.2	9.31	31.2	9.6	31.1	10.1	
	-9.5	-10.0	32.3	8.22	32.1	8.72	32.0	9.22	32.0	9.5	31.9	9.7	31.8	10.2	
	-8.5	-9.1	32.9	8.39	32.8	8.87	32.7	9.4	32.7	9.6	32.6	9.8	32.5	10.3	
	-7.0	-7.6	34.1	8.66	34.0	9.13	33.9	9.6	33.8	9.8	33.8	10.1	33.7	10.5	
	-5.0	-5.6	35.8	9.01	35.7	9.5	35.6	9.9	35.5	10.1	35.5	10.3	35.4	10.8	
	-3.0	-3.7	37.5	9.3	37.4	9.8	37.3	10.2	37.2	10.4	37.2	10.6	37.1	11.0	
	0.0	-0.7	40.4	9.8	40.3	10.2	40.2	10.6	40.2	10.8	40.1	11.0	40.0	11.4	
	3.0	2.2	43.5	10.3	43.4	10.6	43.3	11.0	43.2	11.2	43.2	11.3	43.1	11.7	
	5.0	4.1	45.7	10.5	45.5	10.9	45.4	11.2	45.4	11.4	45.3	11.6	45.2	11.9	
	7.0	6.0	47.9	10.8	47.8	11.1	47.7	11.4	47.6	11.6	47.6	11.8	47.5	11.4	
	9.0	7.9	50.3	11.0	50.1	11.3	50.0	11.6	50.0	11.8	49.8	11.9	49.7	10.8	
11.0	9.8	52.7	11.2	52.6	11.5	52.5	11.8	51.9	11.8	49.8	11.2	49.7	10.1		
13.0	11.8	55.4	11.5	55.3	11.8	54.0	11.6	51.9	11.1	49.8	10.6	49.7	9.6		
15.0	13.7	58.1	11.7	58.0	12.0	54.0	11.0	51.9	10.5	49.8	10.0	49.7	9.0		
110% 44.00 kW	-19.8	-20.0	26.1	7.16	26.0	7.72	25.9	8.29	25.8	8.58	25.8	8.86	25.7	9.43	
	-18.8	-19.0	26.6	7.32	26.5	7.87	26.4	8.43	26.3	8.71	26.3	8.99	26.1	9.55	
	-16.7	-17.0	27.6	7.65	27.5	8.18	27.4	8.72	27.3	8.99	27.3	9.26	27.2	9.79	
	-13.7	-15.0	28.7	7.99	28.6	8.50	28.5	9.02	28.5	9.27	28.4	9.53	28.3	10.0	
	-11.8	-13.0	30.0	8.33	29.9	8.82	29.8	9.31	29.7	9.6	29.7	9.8	29.6	10.3	
	-9.8	-11.0	31.4	8.68	31.3	9.14	31.2	9.6	31.1	9.8	31.1	10.1	31.0	10.5	
	-9.5	-10.0	32.1	8.84	32.0	9.3	31.9	9.8	31.8	10.0	31.8	10.2	31.7	10.7	
	-8.5	-9.1	32.8	9.00	32.7	9.4	32.6	9.9	32.5	10.1	32.5	10.3	32.4	10.8	
	-7.0	-7.6	34.0	9.2	33.9	9.7	33.8	10.1	33.7	10.3	33.7	10.5	33.6	11.0	
	-5.0	-5.6	35.7	9.6	35.6	10.0	35.5	10.4	35.4	10.6	35.4	10.8	35.3	11.2	
	-3.0	-3.7	37.4	9.9	37.3	10.3	37.2	10.6	37.1	10.8	37.1	11.0	37.0	11.4	
	0.0	-0.7	40.3	10.3	40.2	10.7	40.1	11.0	40.0	11.2	40.0	11.4	39.9	11.7	
	3.0	2.2	43.4	10.7	43.3	11.0	43.2	11.4	43.1	11.5	43.1	11.7	43.0	11.6	
	5.0	4.1	45.5	11.0	45.4	11.3	45.3	11.6	45.3	11.7	45.2	11.9	45.1	10.9	
	7.0	6.0	47.8	11.2	47.7	11.5	47.6	11.8	47.5	11.9	47.5	11.4	47.4	10.3	
	9.0	7.9	50.1	11.4	50.0	11.7	49.5	11.8	47.6	11.3	45.7	10.8	41.9	9.7	
11.0	9.8	52.6	11.6	52.5	11.9	49.5	11.2	47.6	10.6	45.7	10.1	41.9	9.2		
13.0	11.8	55.3	11.8	53.3	11.5	49.5	10.5	47.6	10.0	45.7	9.6	41.9	8.66		
15.0	13.7	57.1	11.8	53.3	10.8	49.5	9.9	47.6	9.5	45.7	9.0	41.9	8.20		
100% 40.00 kW	-19.8	-20.0	26.0	7.93	25.9	8.45	25.8	8.96	25.7	9.22	25.7	9.48	25.6	10.00	
	-18.8	-19.0	26.4	8.08	26.3	8.58	26.2	9.09	26.2	9.34	26.1	9.60	26.0	10.1	
	-16.7	-17.0	27.5	8.38	27.4	8.87	27.3	9.35	27.2	9.60	27.2	9.8	27.1	10.3	
	-13.7	-15.0	28.6	8.69	28.5	9.16	28.4	9.6	28.4	9.9	28.3	10.1	28.2	10.6	
	-11.8	-13.0	29.9	9.00	29.8	9.4	29.7	9.9	29.6	10.1	29.6	10.3	29.5	10.8	
	-9.8	-11.0	31.2	9.3	31.1	9.7	31.0	10.2	31.0	10.4	31.0	10.6	30.9	11.0	
	-9.5	-10.0	32.0	9.5	31.9	9.9	31.8	10.3	31.7	10.5	31.7	10.7	31.6	11.1	
	-8.5	-9.1	32.7	9.6	32.6	10.0	32.5	10.4	32.4	10.6	32.4	10.8	32.3	11.2	
	-7.0	-7.6	33.8	9.8	33.7	10.2	33.7	10.6	33.6	10.8	33.6	11.0	33.5	11.4	
	-5.0	-5.6	35.5	10.1	35.4	10.5	35.3	10.9	35.3	11.1	35.2	11.2	35.2	11.6	
	-3.0	-3.7	37.2	10.4	37.2	10.7	37.1	11.1	37.0	11.3	37.0	11.5	36.9	11.8	
	0.0	-0.7	40.2	10.8	40.1	11.1	40.0	11.5	39.9	11.6	39.9	11.8	38.1	11.3	
	3.0	2.2	43.2	11.2	43.1	11.5	43.0	11.8	43.0	11.9	41.5	11.5	38.1	10.3	
	5.0	4.1	45.4	11.4	45.3	11.7	45.0	11.9	43.3	11.3	41.5	10.8	38.1	9.8	
	7.0	6.0	47.6	11.6	47.5	11.9	45.0	11.2	43.3	10.7	41.5	10.2	38.1	9.21	
	9.0	7.9	50.0	11.8	48.5	11.5	45.0	10.6	43.3	10.1	41.5	9.6	38.1	8.71	
11.0	9.8	51.9	11.8	48.5	10.9	45.0	10.0	43.3	9.5	41.5	9.09	38.1	8.24		
13.0	11.8	51.9	11.1	48.5	10.2	45.0	9.4	43.3	8.98	41.5	8.58	38.1	7.78		
15.0	13.7	51.9	10.5	48.5	9.7	45.0	8.89	43.3	8.50	41.5	8.12	38.1	7.38		

NOTES - ANMERKUNGEN - Σημειώσεις - NOTAS - REMARQUES - NOTE - OPMERKINGEN - примечания - NOTLAR

- █ is shown as reference. When selecting the unit models, avoid the Outdoor air temperature range shown by █.

█ dient als Verweis. Vermeiden Sie bei der Auswahl der Gerätemodelle den als markierten Temperaturbereich der Außenluft.

█ είναι ενδεικτική, κατά την επιλογή των μοντέλων των μονάδων, αποφεύγετε το εύρος θερμοκρασίας εξωτερικού αέρα που υποδεικνύεται.

█ se muestra como referencia. Cuando seleccione los modelos de unidad, evite el intervalo de temperaturas de aire exterior indicado mediante █.

█ est montré comme référence. Lors du choix des modèles d'unités, évitez la plage de températures de l'air extérieur illustré par █.

█ valori riportati unicamente come riferimento. Nel selezionare i modelli delle unità, non considerare i valori di temperatura dell'aria esterna indicati con il colore █.

█ is als referentie getoond. Wanneer modellen van eenheden worden gekozen, vermijd dan het bereik van buitenluchttemperaturen geïllustreerd door █.

█ показан как. При выборе модели устройства избегайте внешнюю температуру воздуха, указанную в █.

█ referans olarak gösterilmektedir. Ünite modellerini seçerken, belirtilen dış hava sıcaklığı aralığından kaçınınız.
- The above table shows the average value of conditions which may occur.

Die obige Tabelle zeigt den Durchschnittswert der Bedingungen, die auftreten können.

Στον παραπάνω πίνακα αναγράφεται η μέση τιμή για συνθήκες που μπορεί να προκύψουν.

La tabla de arriba muestra el valor medio de condiciones que pueden ocurrir.

Le tableau ci-dessus donne la valeur moyenne pour des conditions qui peuvent survenir.

La tabella in alto mostra il valore delle condizioni medie che si possono riscontrare.

De tabel hierboven geeft de gemiddelde waarde aan van situaties die kunnen voorvallen.

Таблица расположенная выше показывает среднее значение условий, которые могут наступить.

Yukarıdaki tablo meydana gelebilecek koşulların ortalama değerini göstermektedir.

3D079549

5 Таблицы производительности

5 - 2 Таблицы теплопроизводительностей

5

RXYQ14T														
Indoor air temp. °CDB														
Combination(%) (Capacity index)	Outdoor air temp.		16.0		18.0		20.0		21.0		22.0		24.0	
	°CDB	°CWB	TC	PI	TC	PI	TC	PI	TC	PI	TC	PI	TC	PI
			KW	KW	KW	KW	KW	KW	KW	KW	KW	KW	KW	KW
90% 36.0 kW	-19.8	-20.0	25.8	8.70	25.7	9.17	25.6	9.63	25.6	9.87	25.6	10.1	25.5	10.6
	-18.8	-19.0	26.3	8.84	26.2	9.29	26.1	9.75	26.1	10.0	26.0	10.2	25.9	10.7
	-16.7	-17.0	27.3	9.11	27.2	9.55	27.1	10.0	27.1	10.2	27.1	10.4	27.0	10.9
	-13.7	-15.0	28.5	9.39	28.4	9.8	28.3	10.2	28.2	10.4	28.2	10.6	28.1	11.1
	-11.8	-13.0	29.7	9.7	29.6	10.1	29.5	10.5	29.5	10.7	29.5	10.9	29.4	11.3
	-9.8	-11.0	31.1	10.0	31.0	10.3	30.9	10.7	30.9	10.9	30.8	11.1	30.8	11.5
	-9.5	-10.0	31.8	10.1	31.7	10.5	31.7	10.8	31.6	11.0	31.6	11.2	31.5	11.6
	-8.5	-9.1	32.5	10.2	32.4	10.6	32.3	10.9	32.3	11.1	32.3	11.3	32.2	11.7
	-7.0	-7.6	33.7	10.4	33.6	10.8	33.5	11.1	33.5	11.3	33.4	11.5	33.4	11.8
	-5.0	-5.6	35.4	10.7	35.3	11.0	35.2	11.4	35.2	11.5	35.1	11.7	34.3	11.6
	-3.0	-3.7	37.1	10.9	37.0	11.2	36.9	11.6	36.9	11.7	36.8	11.9	34.3	10.9
	0.0	-0.7	40.0	11.3	39.9	11.6	39.9	11.9	38.9	11.6	37.4	11.1	34.3	10.0
	3.0	2.2	43.1	11.6	43.0	11.9	40.5	11.1	38.9	10.6	37.4	10.1	34.3	9.15
	5.0	4.1	45.2	11.8	43.6	11.4	40.5	10.5	38.9	10.0	37.4	9.55	34.3	8.64
	7.0	6.0	46.7	11.7	43.6	10.8	40.5	9.9	38.9	9.45	37.4	9.02	34.3	8.18
	9.0	7.9	46.7	11.0	43.6	10.2	40.5	9.34	38.9	8.93	37.4	8.53	34.3	7.74
	11.0	9.8	46.7	10.4	43.6	9.6	40.5	8.83	38.9	8.45	37.4	8.07	34.3	7.34
13.0	11.8	46.7	9.8	43.6	9.06	40.5	8.33	38.9	7.98	37.4	7.63	34.3	6.94	
15.0	13.7	46.7	9.3	43.6	8.58	40.5	7.90	38.9	7.56	37.4	7.24	34.3	6.59	
80% 32.0 kW	-19.8	-20.0	25.7	9.48	25.6	9.89	25.5	10.3	25.5	10.5	25.4	10.7	25.4	11.1
	-18.8	-19.0	26.1	9.60	26.1	10.0	26.0	10.4	25.9	10.6	25.9	10.8	25.8	11.2
	-16.7	-17.0	27.2	9.8	27.1	10.2	27.0	10.6	27.0	10.8	26.9	11.0	26.9	11.4
	-13.7	-15.0	28.3	10.1	28.2	10.5	28.2	10.8	28.1	11.0	28.1	11.2	28.0	11.6
	-11.8	-13.0	29.6	10.3	29.5	10.7	29.4	11.1	29.4	11.2	29.3	11.4	29.3	11.8
	-9.8	-11.0	31.0	10.6	30.9	10.9	30.8	11.3	30.8	11.4	30.7	11.6	30.5	11.8
	-9.5	-10.0	31.7	10.7	31.6	11.0	31.5	11.4	31.5	11.5	31.5	11.7	30.5	11.5
	-8.5	-9.1	32.4	10.8	32.3	11.1	32.2	11.5	32.2	11.6	32.1	11.8	30.5	11.2
	-7.0	-7.6	33.6	11.0	33.5	11.3	33.4	11.6	33.4	11.8	33.2	11.9	30.5	10.7
	-5.0	-5.6	35.2	11.2	35.2	11.5	35.1	11.8	34.6	11.7	33.2	11.2	30.5	10.1
	-3.0	-3.7	37.0	11.5	36.9	11.7	36.0	11.6	34.6	11.1	33.2	10.6	30.5	9.54
	0.0	-0.7	39.9	11.8	38.8	11.6	36.0	10.6	34.6	10.1	33.2	9.64	30.5	8.72
	3.0	2.2	41.5	11.5	38.8	10.6	36.0	9.68	34.6	9.25	33.2	8.83	30.5	8.01
	5.0	4.1	41.5	10.8	38.8	10.0	36.0	9.14	34.6	8.74	33.2	8.35	30.5	7.58
	7.0	6.0	41.5	10.2	38.8	9.40	36.0	8.64	34.6	8.27	33.2	7.90	30.5	7.18
	9.0	7.9	41.5	9.62	38.8	8.89	36.0	8.17	34.6	7.83	33.2	7.48	30.5	6.81
	11.0	9.8	41.5	9.09	38.8	8.41	36.0	7.74	34.6	7.42	33.2	7.10	30.5	6.47
13.0	11.8	41.5	8.58	38.8	7.94	36.0	7.32	34.6	7.02	33.2	6.72	30.5	6.13	
15.0	13.7	41.5	8.12	38.8	7.53	36.0	6.95	34.6	6.66	33.2	6.38	30.5	5.83	
70% 28.0 kW	-19.8	-20.0	25.5	10.3	25.5	10.6	25.4	11.0	25.4	11.2	25.3	11.3	25.3	11.7
	-18.8	-19.0	26.0	10.4	25.9	10.7	25.9	11.1	25.8	11.2	25.8	11.4	25.7	11.8
	-16.7	-17.0	27.0	10.6	27.0	10.9	26.9	11.3	26.9	11.4	26.8	11.6	26.7	11.9
	-13.7	-15.0	28.2	10.8	28.1	11.1	28.0	11.4	28.0	11.6	28.0	11.8	26.7	11.3
	-11.8	-13.0	29.4	11.0	29.4	11.3	29.3	11.6	29.3	11.8	29.1	11.8	26.7	10.7
	-9.8	-11.0	30.8	11.2	30.7	11.5	30.7	11.8	30.3	11.8	29.1	11.2	26.7	10.1
	-9.5	-10.0	31.5	11.3	31.5	11.6	31.4	11.9	30.3	11.4	29.1	10.9	26.7	9.8
	-8.5	-9.1	32.2	11.4	32.2	11.7	31.5	11.7	30.3	11.1	29.1	10.6	26.7	9.57
	-7.0	-7.6	33.4	11.6	33.4	11.9	31.5	11.1	30.3	10.6	29.1	10.1	26.7	9.17
	-5.0	-5.6	35.1	11.8	33.9	11.5	31.5	10.5	30.3	10.03	29.1	9.56	26.7	8.66
	-3.0	-3.7	36.3	11.7	33.9	10.8	31.5	9.91	30.3	9.47	29.1	9.04	26.7	8.19
	0.0	-0.7	36.3	10.7	33.9	9.87	31.5	9.06	30.3	8.67	29.1	8.28	26.7	7.52
	3.0	2.2	36.3	9.79	33.9	9.04	31.5	8.32	30.3	7.96	29.1	7.61	26.7	6.93
	5.0	4.1	36.3	9.24	33.9	8.55	31.5	7.87	30.3	7.54	29.1	7.21	26.7	6.57
	7.0	6.0	36.3	8.74	33.9	8.08	31.5	7.45	30.3	7.14	29.1	6.83	26.7	6.24
	9.0	7.9	36.3	8.26	33.9	7.65	31.5	7.06	30.3	6.77	29.1	6.49	26.7	5.92
	11.0	9.8	36.3	7.82	33.9	7.26	31.5	6.70	30.3	6.43	29.1	6.16	26.7	5.63
13.0	11.8	36.3	7.40	33.9	6.87	31.5	6.35	30.3	6.09	29.1	5.84	26.7	5.35	
15.0	13.7	36.3	7.02	33.9	6.52	31.5	6.04	30.3	5.80	29.1	5.56	26.7	5.10	
60% 24.0 kW	-19.8	-20.0	25.4	11.0	25.3	11.3	25.3	11.6	25.2	11.8	24.9	11.7	22.8	10.6
	-18.8	-19.0	25.9	11.1	25.8	11.4	25.7	11.7	25.7	11.9	24.9	11.5	22.8	10.4
	-16.7	-17.0	26.9	11.3	26.8	11.6	26.8	11.9	26.0	11.5	24.9	10.9	22.8	9.9
	-13.7	-15.0	28.0	11.5	28.0	11.8	27.0	11.4	26.0	10.9	24.9	10.4	22.8	9.40
	-11.8	-13.0	29.3	11.7	29.1	11.8	27.0	10.8	26.0	10.3	24.9	9.9	22.8	8.92
	-9.8	-11.0	30.7	11.9	29.1	11.2	27.0	10.3	26.0	9.79	24.9	9.34	22.8	8.46
	-9.5	-10.0	31.2	11.8	29.1	10.9	27.0	9.97	26.0	9.52	24.9	9.09	22.8	8.24
	-8.5	-9.1	31.2	11.5	29.1	10.6	27.0	9.71	26.0	9.28	24.9	8.86	22.8	8.04
	-7.0	-7.6	31.2	11.0	29.1	10.14	27.0	9.31	26.0	8.90	24.9	8.50	22.8	7.71
	-5.0	-5.6	31.2	10.36	29.1	9.56	27.0	8.78	26.0	8.40	24.9	8.03	22.8	7.30
	-3.0	-3.7	31.2	9.79	29.1	9.04	27.0	8.31	26.0	7.96	24.9	7.61	22.8	6.92
	0.0	-0.7	31.2	8.95	29.1	8.28	27.0	7.63	26.0	7.31	24.9	6.99	22.8	6.37
	3.0	2.2	31.2	8.21	29.1	7.61	27.0	7.02	26.0	6.73	24.9	6.45	22.8	5.89
	5.0	4.1	31.2	7.77	29.1	7.21	27.0	6.66	26.0	6.39	24.9	6.12	22.8	5.60
	7.0	6.0	31.2	7.36	29.1	6.83	27.0	6.32	26.0	6.07	24.9	5.82	22.8	5.33
	9.0	7.9	31.2	6.98	29.1	6.49	27.0	6.00	26.0	5.77	24.9	5.53	22.8	5.07
	11.0	9.8	31.2	6.62	29.1	6.16	27.0	5.71	26.0	5.49	24.9	5.27	22.8	4.84
13.0	11.8	31.2	6.28	29.1	5.84	27.0	5.42	26.0	5.21	24.9	5.01	22.8	4.60	
15.0	13.7	31.2	5.97	29.1	5.56	27.0	5.17	26.0	4.97	24.9	4.78	22.8	4.40	
50% 20.0 kW	-19.8	-20.0	25.2	11.8	24.2	11.4	22.5	10.4	21.6	9.9	20.8	9.5	19.0	8.57
	-18.8	-19.0	25.7	11.9	24.2	11.1	22.5	10.2	21.6	9.7	20.8	9.3	19.0	8.39
	-16.7	-17.0	26.0	11.5	24.2	10.6	22.5	9.7	21.6	9.27	20.8	8.85	19.0	8.03
	-13.7	-15.0	26.0	10.9	24.2	10.1	22.5	9.23	21.6	8.83	20.8	8.43	19.0	7.66
	-11.8													

5 Таблицы производительности

5 - 2 Таблицы теплопроизводительностей

RXYQ16T		Indoor air temp. °CDB												TC: Total capacity (kW); PI: Power Input (kW) (Comp. + Outdoor fan motor)	
Combination(%) (Capacity index)	Outdoor air temp.		16.0		18.0		20.0		21.0		22.0		24.0		
	(°CDB)	(°CWB)	KW	PI	KW	PI	KW	PI	KW	PI	KW	PI	KW	PI	
130% 58.50 kW	-19.8	-20.0	29.4	6.49	29.3	7.26	29.2	8.03	29.1	8.41	29.0	8.80	28.9	9.56	
	-18.8	-19.0	30.0	6.71	29.8	7.46	29.7	8.22	29.6	8.59	29.5	8.97	29.4	9.72	
	-16.7	-17.0	31.1	7.16	31.0	7.88	30.8	8.61	30.8	8.97	30.7	9.33	30.6	10.05	
	-13.7	-15.0	32.4	7.62	32.2	8.31	32.1	9.01	32.0	9.35	32.0	9.70	31.8	10.39	
	-11.8	-13.0	33.8	8.08	33.6	8.75	33.5	9.41	33.4	9.74	33.4	10.07	33.2	10.73	
	-9.8	-11.0	35.3	8.54	35.2	9.18	35.0	9.81	35.0	10.12	34.9	10.44	34.8	11.1	
	-9.5	-10.0	36.1	8.77	36.0	9.39	35.9	10.01	35.8	10.31	35.7	10.6	35.6	11.2	
	-8.5	-9.1	36.9	8.98	36.8	9.58	36.6	10.18	36.6	10.48	36.5	10.8	36.4	11.4	
	-7.0	-7.6	38.2	9.31	38.1	9.89	38.0	10.5	37.9	10.8	37.8	11.1	37.7	11.6	
	-5.0	-5.6	40.1	9.74	40.0	10.30	39.8	10.8	39.8	11.1	39.7	11.4	39.6	12.0	
	-3.0	-3.7	42.0	10.14	41.9	10.7	41.8	11.2	41.7	11.5	41.6	11.7	41.5	12.2	
	0.0	-0.7	45.3	10.7	45.1	11.2	45.0	11.7	44.9	12.0	44.9	12.2	44.7	12.7	
	3.0	2.2	48.7	11.3	48.6	11.7	48.4	12.2	48.4	12.4	48.3	12.6	48.2	13.1	
	5.0	4.1	51.1	11.6	51.0	12.0	50.8	12.5	50.8	12.7	50.7	12.9	50.5	13.3	
	7.0	6.0	53.6	11.9	53.5	12.3	53.3	12.7	53.3	13.0	53.2	13.2	53.1	13.6	
	9.0	7.9	56.2	12.2	56.1	12.6	56.0	13.0	55.9	13.2	55.8	13.4	55.0	13.5	
11.0	9.8	59.0	12.5	58.8	12.9	58.7	13.3	58.6	13.4	58.6	13.6	58.0	12.7		
13.0	11.8	62.0	12.8	61.8	13.1	61.7	13.5	61.6	13.7	61.0	13.3	60.0	12.0		
15.0	13.7	65.0	13.0	64.8	13.4	64.7	13.7	62.5	13.2	60.0	12.6	55.0	11.3		
120% 54.00 kW	-19.8	-20.0	29.3	7.38	29.1	8.09	29.0	8.80	29.0	9.15	28.9	9.50	28.8	10.21	
	-18.8	-19.0	29.8	7.58	29.7	8.28	29.5	8.97	29.5	9.32	29.4	9.67	29.3	10.36	
	-16.7	-17.0	30.9	8.00	30.8	8.66	30.7	9.33	30.6	9.66	30.6	10.00	30.4	10.67	
	-13.7	-15.0	32.2	8.42	32.1	9.06	32.0	9.70	31.9	10.02	31.8	10.34	31.7	11.0	
	-11.8	-13.0	33.6	8.85	33.5	9.46	33.4	10.07	33.3	10.38	33.2	10.7	33.1	11.3	
	-9.8	-11.0	35.2	9.27	35.0	9.86	34.9	10.44	34.8	10.7	34.8	11.0	34.7	11.6	
	-9.5	-10.0	36.0	9.48	35.9	10.05	35.7	10.6	35.7	10.9	35.6	11.2	35.5	11.8	
	-8.5	-9.1	36.7	9.67	36.6	10.23	36.5	10.8	36.4	11.1	36.4	11.3	36.2	11.9	
	-7.0	-7.6	38.1	9.98	37.9	10.5	37.8	11.1	37.8	11.3	37.7	11.6	37.6	12.1	
	-5.0	-5.6	40.0	10.4	39.8	10.9	39.7	11.4	39.6	11.7	39.6	11.9	39.5	12.4	
	-3.0	-3.7	41.9	10.8	41.7	11.2	41.6	11.7	41.6	12.0	41.5	12.2	41.4	12.7	
	0.0	-0.7	45.1	11.3	45.0	11.8	44.9	12.2	44.8	12.4	44.7	12.7	44.6	13.1	
	3.0	2.2	48.5	11.8	48.4	12.2	48.3	12.6	48.2	12.8	48.2	13.1	48.0	13.5	
	5.0	4.1	50.9	12.1	50.8	12.5	50.7	12.9	50.6	13.1	50.6	13.3	50.4	13.7	
	7.0	6.0	53.4	12.4	53.3	12.8	53.2	13.2	53.1	13.3	53.1	13.5	50.8	13.0	
	9.0	7.9	56.1	12.7	55.9	13.0	55.8	13.4	55.8	13.6	55.4	13.6	50.8	12.3	
11.0	9.8	58.8	12.9	58.7	13.3	58.6	13.6	57.7	13.5	55.4	12.9	50.8	11.6		
13.0	11.8	61.8	13.2	61.7	13.5	60.0	13.3	57.7	12.7	55.4	12.1	50.8	10.9		
15.0	13.7	64.8	13.4	64.6	13.7	60.0	12.6	57.7	12.0	55.4	11.4	50.8	10.3		
110% 49.50 kW	-19.8	-20.0	29.1	8.27	29.0	8.91	28.9	9.56	28.8	9.89	28.8	10.21	28.6	10.86	
	-18.8	-19.0	29.6	8.45	29.5	9.09	29.4	9.72	29.3	10.04	29.3	10.36	29.2	11.00	
	-16.7	-17.0	30.8	8.83	30.7	9.44	30.6	10.05	30.5	10.36	30.4	10.67	30.3	11.3	
	-13.7	-15.0	32.1	9.22	31.9	9.81	31.8	10.39	31.8	10.68	31.7	11.0	31.6	11.6	
	-11.8	-13.0	33.5	9.61	33.4	10.17	33.2	10.7	33.2	11.0	33.1	11.3	33.0	11.9	
	-9.8	-11.0	35.0	10.00	34.9	10.5	34.8	11.1	34.7	11.3	34.7	11.6	34.5	12.1	
	-9.5	-10.0	35.8	10.20	35.7	10.7	35.6	11.2	35.5	11.5	35.5	11.8	35.4	12.3	
	-8.5	-9.1	36.6	10.4	36.5	10.9	36.4	11.4	36.3	11.6	36.2	11.9	36.1	12.4	
	-7.0	-7.6	37.9	10.7	37.8	11.1	37.7	11.6	37.6	11.9	37.6	12.1	37.5	12.6	
	-5.0	-5.6	39.8	11.0	39.7	11.5	39.6	12.0	39.5	12.2	39.5	12.4	39.3	12.9	
	-3.0	-3.7	41.7	11.4	41.6	11.8	41.5	12.2	41.4	12.5	41.4	12.7	41.2	13.1	
	0.0	-0.7	45.0	11.9	44.8	12.3	44.7	12.7	44.7	12.9	44.6	13.1	44.5	13.5	
	3.0	2.2	48.4	12.3	48.3	12.7	48.2	13.1	48.1	13.3	48.0	13.5	46.5	13.2	
	5.0	4.1	50.8	12.6	50.7	13.0	50.5	13.3	50.5	13.5	50.4	13.7	46.5	12.5	
	7.0	6.0	53.3	12.9	53.2	13.2	53.1	13.6	52.9	13.7	50.8	13.0	46.5	11.8	
	9.0	7.9	55.9	13.1	55.8	13.5	55.0	13.5	52.9	12.9	50.8	12.3	46.5	11.1	
11.0	9.8	58.7	13.4	58.5	13.7	55.0	12.7	52.9	12.2	50.8	11.6	46.5	10.5		
13.0	11.8	61.7	13.6	59.2	13.1	55.0	12.0	52.9	11.5	50.8	10.9	46.5	9.9		
15.0	13.7	63.5	13.4	59.2	12.4	55.0	11.3	52.9	10.8	50.8	10.3	46.5	9.4		
100% 45.00 kW	-19.8	-20.0	29.0	9.15	28.8	9.74	28.7	10.33	28.7	10.63	28.6	10.92	28.5	11.5	
	-18.8	-19.0	29.5	9.32	29.4	9.90	29.3	10.48	29.2	10.77	29.2	11.06	29.1	11.6	
	-16.7	-17.0	30.6	9.66	30.5	10.22	30.4	10.78	30.4	11.1	30.3	11.3	30.2	11.9	
	-13.7	-15.0	31.9	10.02	31.8	10.55	31.7	11.1	31.6	11.4	31.6	11.6	31.5	12.2	
	-11.8	-13.0	33.3	10.38	33.2	10.9	33.1	11.4	33.0	11.6	33.0	11.9	32.9	12.4	
	-9.8	-11.0	34.8	10.7	34.7	11.2	34.6	11.7	34.6	11.9	34.5	12.2	34.4	12.7	
	-9.5	-10.0	35.7	10.9	35.6	11.4	35.5	11.9	35.4	12.1	35.3	12.3	35.2	12.8	
	-8.5	-9.1	36.4	11.1	36.3	11.5	36.2	12.0	36.2	12.2	36.1	12.5	36.0	12.9	
	-7.0	-7.6	37.8	11.3	37.7	11.8	37.5	12.2	37.5	12.4	37.4	12.7	37.3	13.1	
	-5.0	-5.6	39.6	11.7	39.5	12.1	39.4	12.5	39.4	12.7	39.3	12.9	39.2	13.4	
	-3.0	-3.7	41.6	12.0	41.4	12.4	41.3	12.8	41.3	13.0	41.2	13.2	41.1	13.6	
	0.0	-0.7	44.8	12.4	44.7	12.8	44.6	13.2	44.5	13.4	44.5	13.6	42.3	12.9	
	3.0	2.2	48.2	12.8	48.1	13.2	48.0	13.5	48.0	13.7	48.0	13.9	47.3	13.4	
	5.0	4.1	50.6	13.1	50.5	13.4	50.0	13.6	48.1	13.0	46.2	12.3	42.3	11.1	
	7.0	6.0	53.1	13.3	53.0	13.7	50.0	12.8	48.1	12.2	46.2	11.6	42.3	10.5	
	9.0	7.9	55.8	13.6	53.8	13.2	50.0	12.1	48.1	11.5	46.2	11.0	42.3	10.0	
11.0	9.8	57.7	13.5	53.8	12.4	50.0	11.4	48.1	10.9	46.2	10.4	42.3	9.4		
13.0	11.8	57.7	12.7	53.8	11.7	50.0	10.7	48.1	10.3	46.2	9.8	42.3	8.9		
15.0	13.7	57.7	12.0	53.8	11.1	50.0	10.2	48.1	9.7	46.2	9.3	42.3	8.44		

NOTES - ANMERKUNGEN - Σημειώσεις - NOTAS - REMARQUES - NOTE - OPMERKINGEN - примечания - NOTLAR

- █ is shown as reference. When selecting the unit models, avoid the Outdoor air temperature range shown by █.

█ dient als Verweis. Vermeiden Sie bei der Auswahl der Gerätemodelle den als markierten Temperaturbereich der Außenluft.

Η █ είναι ενδεικτική, κατά την επιλογή των μοντέλων των μονάδων, αποφεύγετε το εύρος θερμοκρασίας εξωτερικού αέρα που υποδεικνύεται █.

█ se muestra como referencia. Cuando seleccione los modelos de unidad, evite el intervalo de temperaturas del aire exterior indicado mediante █.

█ est montré comme référence. Lors du choix des modèles d'unités, évitez la plage de températures de l'air extérieur illustré par █.

█ valori riportati unicamente come riferimento. Nel selezionare i modelli delle unità, non considerare i valori di temperatura dell'aria esterna indicati con il colore █.

█ is als referentie getoond. Wanneer modellen van eenheden worden gekozen, vermijd dan het bereik van buitenluchttemperaturen geïllustreerd door █.

█ показан как. При выборе модели устройства избегайте внешнюю температуру воздуха, указанную в █.

█ referans olarak gösterilmektedir. Ünite modellerini seçerken, belirtilen Dış hava sıcaklığı aralığından kaçınınız █.
- The above table shows the average value of conditions which may occur.

Die obige Tabelle zeigt den Durchschnittswert der Bedingungen, die auftreten können.

Στον παραπάνω πίνακα αναγράφεται η μέση τιμή για συνθήκες που μπορεί να προκύψουν.

La tabla de arriba muestra el valor medio de condiciones que pueden ocurrir.

Le tableau ci-dessus donne la valeur moyenne pour des conditions qui peuvent survenir.

La tabella in alto mostra il valore delle condizioni medie che si possono riscontrare.

De tabel hierboven geeft de gemiddelde waarde aan van situaties die kunnen voorvallen.

Таблица расположенная выше показывает среднее значение условий, которые могут наступить.

Yukarıdaki tablo meydana gelebilecek koşulların ortalama değerini göstermektedir.

3D079549

5 Таблицы производительности

5 - 2 Таблицы теплопроизводительностей

5

RXYQ16T																
Indoor air temp. °CDB																
Combination(%) (Capacity index)	Outdoor air temp.		16.0		18.0		20.0		21.0		22.0		24.0			
	(°CDB)	(°CWB)	TC	PI	TC	PI	TC	PI	TC	PI	TC	PI	TC	PI		
			KW	KW	KW	KW	KW	KW	KW	KW	KW	KW	KW	KW		
90% 40.50 kW	-19.8	-20.0	28.8	10.04	28.7	10.57	28.6	11.10	28.6	11.4	28.5	11.6	28.4	12.2		
	-18.8	-19.0	29.3	10.19	29.2	10.71	29.1	11.2	29.1	11.5	29.0	11.8	28.9	12.3		
	-16.7	-17.0	30.5	10.50	30.4	11.0	30.3	11.5	30.2	11.8	30.2	12.0	30.1	12.5		
	-13.7	-15.0	31.7	10.8	31.7	11.3	31.6	11.8	31.5	12.0	31.5	12.3	31.4	12.7		
	-11.8	-13.0	33.2	11.1	33.1	11.6	33.0	12.1	32.9	12.3	32.9	12.5	32.8	13.0		
	-9.8	-11.0	34.7	11.5	34.6	11.9	34.5	12.3	34.5	12.6	34.4	12.8	34.3	13.2		
	-9.5	-10.0	35.5	11.6	35.4	12.0	35.3	12.5	35.3	12.7	35.2	12.9	35.1	13.3		
	-8.5	-9.1	36.3	11.8	36.2	12.2	36.1	12.6	36.0	12.8	36.0	13.0	35.9	13.4		
	-7.0	-7.6	37.6	12.0	37.5	12.4	37.4	12.8	37.4	13.0	37.3	13.2	37.2	13.6		
	-5.0	-5.6	39.5	12.3	39.4	12.7	39.3	13.1	39.2	13.3	39.2	13.4	38.1	13.3		
	-3.0	-3.7	41.4	12.6	41.3	12.9	41.2	13.3	41.2	13.5	41.1	13.7	38.1	12.5		
	0.0	-0.7	44.6	13.0	44.6	13.3	44.5	13.7	43.3	13.3	43.3	13.3	41.5	12.6	38.1	11.4
	3.0	2.2	48.1	13.4	48.0	13.7	45.0	12.7	43.3	12.1	41.5	11.6	38.1	10.5		
	5.0	4.1	50.5	13.6	48.5	13.1	45.0	12.0	43.3	11.4	41.5	10.9	38.1	9.9		
	7.0	6.0	51.9	13.4	48.5	12.3	45.0	11.3	43.3	10.8	41.5	10.3	38.1	9.3		
	9.0	7.9	51.9	12.6	48.5	11.6	45.0	10.7	43.3	10.2	41.5	9.7	38.1	8.85		
	11.0	9.8	51.9	11.9	48.5	11.0	45.0	10.1	43.3	9.7	41.5	9.2	38.1	8.38		
13.0	11.8	51.9	11.2	48.5	10.4	45.0	9.5	43.3	9.1	41.5	8.72	38.1	7.93			
15.0	13.7	51.9	10.6	48.5	9.8	45.0	9.0	43.3	8.65	41.5	8.27	38.1	7.53			
80% 36.00 kW	-19.8	-20.0	28.6	10.92	28.6	11.4	28.5	11.9	28.4	12.1	28.4	12.3	28.3	12.8		
	-18.8	-19.0	29.2	11.1	29.1	11.5	29.0	12.0	28.9	12.2	28.9	12.4	28.8	12.9		
	-16.7	-17.0	30.3	11.3	30.2	11.8	30.1	12.2	30.1	12.4	30.1	12.7	30.0	13.1		
	-13.7	-15.0	31.6	11.6	31.5	12.0	31.4	12.5	31.4	12.7	31.3	12.9	31.2	13.3		
	-11.8	-13.0	33.0	11.9	32.9	12.3	32.8	12.7	32.8	12.9	32.7	13.1	32.7	13.5		
	-9.8	-11.0	34.5	12.2	34.4	12.6	34.4	13.0	34.3	13.2	34.3	13.4	33.8	13.5		
	-9.5	-10.0	35.3	12.3	35.3	12.7	35.2	13.1	35.1	13.3	35.1	13.5	33.8	13.1		
	-8.5	-9.1	36.1	12.5	36.0	12.8	35.9	13.2	35.9	13.4	35.9	13.6	33.8	12.8		
	-7.0	-7.6	37.4	12.7	37.4	13.0	37.3	13.4	37.2	13.6	36.9	13.6	33.8	12.2		
	-5.0	-5.6	39.3	12.9	39.2	13.3	39.2	13.6	38.5	13.4	36.9	12.8	33.8	11.5		
	-3.0	-3.7	41.2	13.2	41.2	13.5	40.0	13.3	38.5	12.7	36.9	12.1	33.8	10.9		
	0.0	-0.7	44.5	13.6	43.1	13.2	40.0	12.1	38.5	11.5	36.9	11.0	33.8	10.0		
	3.0	2.2	46.2	13.1	43.1	12.1	40.0	11.1	38.5	10.6	36.9	10.1	33.8	9.16		
	5.0	4.1	46.2	12.3	43.1	11.4	40.0	10.4	38.5	10.0	36.9	9.54	33.8	8.67		
	7.0	6.0	46.2	11.6	43.1	10.7	40.0	9.9	38.5	9.45	36.9	9.03	33.8	8.21		
	9.0	7.9	46.2	11.0	43.1	10.2	40.0	9.34	38.5	8.94	36.9	8.55	33.8	7.79		
	11.0	9.8	46.2	10.4	43.1	9.6	40.0	8.85	38.5	8.48	36.9	8.11	33.8	7.39		
13.0	11.8	46.2	9.8	43.1	9.07	40.0	8.37	38.5	8.02	36.9	7.68	33.8	7.01			
15.0	13.7	46.2	9.3	43.1	8.60	40.0	7.94	38.5	7.62	36.9	7.29	33.8	6.67			
70% 31.50 kW	-19.8	-20.0	28.5	11.8	28.4	12.2	28.3	12.6	28.3	12.8	28.3	13.0	28.2	13.5		
	-18.8	-19.0	29.0	11.9	28.9	12.3	28.9	12.7	28.8	12.9	28.8	13.1	28.7	13.5		
	-16.7	-17.0	30.2	12.2	30.1	12.6	30.0	12.9	30.0	13.1	29.9	13.3	29.6	13.6		
	-13.7	-15.0	31.4	12.4	31.4	12.8	31.3	13.2	31.2	13.4	31.2	13.5	29.6	12.9		
	-11.8	-13.0	32.8	12.7	32.8	13.0	32.7	13.4	32.7	13.6	32.3	13.5	29.6	12.2		
	-9.8	-11.0	34.4	12.9	34.3	13.3	34.2	13.6	33.7	13.4	32.3	12.8	29.6	11.5		
	-9.5	-10.0	35.2	13.0	35.1	13.4	35.0	13.7	33.7	13.0	32.3	12.4	29.6	11.2		
	-8.5	-9.1	36.0	13.2	35.9	13.5	35.0	13.3	33.7	12.7	32.3	12.1	29.6	10.9		
	-7.0	-7.6	37.3	13.3	37.2	13.6	35.0	12.7	33.7	12.2	32.3	11.6	29.6	10.5		
	-5.0	-5.6	39.2	13.6	37.7	13.1	35.0	12.0	33.7	11.5	32.3	10.9	29.6	9.89		
	-3.0	-3.7	40.4	13.4	37.7	12.4	35.0	11.3	33.7	10.8	32.3	10.3	29.6	9.36		
	0.0	-0.7	40.4	12.2	37.7	11.3	35.0	10.4	33.7	9.90	32.3	9.46	29.6	8.59		
	3.0	2.2	40.4	11.2	37.7	10.3	35.0	9.50	33.7	9.10	32.3	8.70	29.6	7.91		
	5.0	4.1	40.4	10.6	37.7	9.77	35.0	8.99	33.7	8.61	32.3	8.24	29.6	7.51		
	7.0	6.0	40.4	10.0	37.7	9.24	35.0	8.52	33.7	8.16	32.3	7.81	29.6	7.13		
	9.0	7.9	40.4	9.44	37.7	8.75	35.0	8.07	33.7	7.74	32.3	7.41	29.6	6.77		
	11.0	9.8	40.4	8.94	37.7	8.29	35.0	7.66	33.7	7.35	32.3	7.04	29.6	6.44		
13.0	11.8	40.4	8.45	37.7	7.85	35.0	7.25	33.7	6.96	32.3	6.68	29.6	6.12			
15.0	13.7	40.4	8.02	37.7	7.45	35.0	6.90	33.7	6.63	32.3	6.36	29.6	5.83			
60% 27.00 kW	-19.8	-20.0	28.3	12.7	28.3	13.0	28.2	13.4	28.2	13.6	27.7	13.4	25.4	12.1		
	-18.8	-19.0	28.8	12.8	28.8	13.1	28.7	13.5	28.7	13.7	27.7	13.1	25.4	11.8		
	-16.7	-17.0	30.0	13.0	29.9	13.3	29.9	13.7	28.8	13.1	27.7	12.5	25.4	11.3		
	-13.7	-15.0	31.3	13.2	31.2	13.5	30.0	13.1	28.8	12.5	27.7	11.9	25.4	10.7		
	-11.8	-13.0	32.7	13.4	32.3	13.5	30.0	12.4	28.8	11.8	27.7	11.3	25.4	10.2		
	-9.8	-11.0	34.2	13.6	32.3	12.8	30.0	11.7	28.8	11.2	27.7	10.7	25.4	9.67		
	-9.5	-10.0	34.6	13.5	32.3	12.4	30.0	11.4	28.8	10.9	27.7	10.4	25.4	9.41		
	-8.5	-9.1	34.6	13.1	32.3	12.1	30.0	11.1	28.8	10.6	27.7	10.1	25.4	9.18		
	-7.0	-7.6	34.6	12.6	32.3	11.6	30.0	10.6	28.8	10.17	27.7	9.71	25.4	8.81		
	-5.0	-5.6	34.6	11.8	32.3	10.9	30.0	10.04	28.8	9.60	27.7	9.18	25.4	8.34		
	-3.0	-3.7	34.6	11.2	32.3	10.33	30.0	9.50	28.8	9.09	27.7	8.69	25.4	7.91		
	0.0	-0.7	34.6	10.23	32.3	9.46	30.0	8.71	28.8	8.35	27.7	7.99	25.4	7.28		
	3.0	2.2	34.6	9.39	32.3	8.70	30.0	8.03	28.8	7.70	27.7	7.37	25.4	6.73		
	5.0	4.1	34.6	8.88	32.3	8.24	30.0	7.61	28.8	7.30	27.7	7.00	25.4	6.40		
	7.0	6.0	34.6	8.41	32.3	7.81	30.0	7.22	28.8	6.93	27.7	6.65	25.4	6.09		
	9.0	7.9	34.6	7.98	32.3	7.41	30.0	6.86	28.8	6.59	27.7	6.32	25.4	5.80		
	11.0	9.8	34.6	7.57	32.3	7.04	30.0	6.52	28.8	6.27	27.7	6.02	25.4	5.53		
13.0	11.8	34.6	7.17	32.3	6.68	30.0	6.19	28.8	5.96	27.7	5.72	25.4	5.26			
15.0	13.7	34.6	6.82	32.3	6.36	30.0	5.90	28.8	5.68	27.7	5.46	25.4	5.03			
50% 22.50 kW	-19.8	-20.0	28.2	13.6	26.9	13.0	25.0	11.9	24.0	11.3	23.1	10.8	21.2	9.8		
	-18.8	-19.0	28.7	13.7	26.9	12.7	25.0	11.6	24.0	11.1	23.1	10.6	21.2	9.6		
	-16.7	-17.0	28.8	13.1	26.9	12.1	25.0	11.1	24.0	10.6	23.1	10.1	21.2	9.17		
	-13.7	-15.0	28.8	12.5	26.9	11.5	25.0	10.6	24.0	10.1	23.1	9.64	21.2	8.75		
	-11.8	-13.0	28.8	11.8	26.9	10.9	25.0	10.02	24.0	9.59	23.1	9.16	21.2	8.33		
	-9.8	-11.0	28.8	11.2	26.9	10.3	25.0	9.51	24.0	9.10	23.1	8.70	21.2	7.92		
	-9.5	-10.0	28.8	10.9	26.9	10.06	25.0	9.25	24.0	8.86	23.1	8.47	21.2	7.71		
	-8.5	-9.1	28.8	10.6	26.9	9.81	25.0	9.03	24.0	8.65	23.1	8.27	21.2	7.54		
	-7.0	-7.6	28.8	10.17	26.9	9.41	25.0	8.67	24.0	8.30	23.1	7.95	21.2	7.25		
	-5.0	-5.6	28.8	9.60	26.9	8.89	25.0	8.20	24.0	7.86	23.1	7.53	21.2	6.88		
	-3.0	-3.7	28.8	9.09	26.9	8.43	25.0	7.78	24.0	7.47	23.1	7.15	21.2	6.54		
	0.0	-0.7	28.8	8.35	26.9	7.75	25.0	7.17	24.0	6.88						

5 Таблицы производительности

5 - 2 Таблицы теплопроизводительностей

RXYQ18T		Indoor air temp. °CDB												TC: Total capacity (kW); PI: Power Input (kW) (Comp. + Outdoor fan motor)	
Combination(%) (Capacity index)	Outdoor air temp.		16.0		18.0		20.0		21.0		22.0		24.0		
	(°CDB)	(°CWB)	TC	PI	TC	PI	TC	PI	TC	PI	TC	PI	TC	PI	
130% 65.00 kW	-19.8	-20.0	32.8	7.11	32.6	7.97	32.5	8.83	32.4	9.26	32.3	9.68	32.2	10.5	
	-18.8	-19.0	33.4	7.36	33.2	8.20	33.0	9.04	33.0	9.46	32.9	9.9	32.7	10.7	
	-16.7	-17.0	34.6	7.86	34.5	8.67	34.3	9.48	34.3	9.9	34.2	10.3	34.0	11.1	
	-13.7	-15.0	36.1	8.38	35.9	9.16	35.7	9.9	35.7	10.3	35.6	10.7	35.4	11.5	
	-11.8	-13.0	37.6	8.90	37.5	9.6	37.3	10.4	37.2	10.8	37.2	11.1	37.0	11.9	
	-9.8	-11.0	39.3	9.4	39.2	10.1	39.0	10.8	38.9	11.2	38.9	11.5	38.7	12.3	
	-9.5	-10.0	40.2	9.7	40.1	10.4	39.9	11.1	39.9	11.4	39.8	11.8	39.6	12.4	
	-8.5	-9.1	41.1	9.9	40.9	10.6	40.8	11.3	40.7	11.6	40.6	11.9	40.5	12.6	
	-7.0	-7.6	42.6	10.3	42.4	10.9	42.3	11.6	42.2	11.9	42.1	12.2	42.0	12.9	
	-5.0	-5.6	44.7	10.8	44.5	11.4	44.4	12.0	44.3	12.3	44.2	12.6	44.1	13.3	
	-3.0	-3.7	46.8	11.2	46.6	11.8	46.5	12.4	46.4	12.7	46.3	13.0	46.2	13.6	
	0.0	-0.7	50.4	11.9	50.3	12.5	50.1	13.0	50.0	13.3	50.0	13.6	49.8	14.1	
	3.0	2.2	54.2	12.5	54.1	13.0	53.9	13.6	53.8	13.8	53.8	14.1	53.6	14.6	
	5.0	4.1	56.9	12.9	56.7	13.4	56.6	13.9	56.5	14.1	56.4	14.4	56.3	14.8	
	7.0	6.0	59.7	13.3	59.5	13.7	59.4	14.2	59.3	14.4	59.2	14.7	59.1	15.1	
	9.0	7.9	62.6	13.6	62.5	14.1	62.3	14.5	62.2	14.7	62.1	14.9	61.6	15.2	
11.0	9.8	65.7	13.9	65.5	14.4	65.3	14.8	65.3	15.0	65.2	15.2	61.6	14.4		
13.0	11.8	69.0	14.3	68.9	14.7	68.7	15.1	68.6	15.3	67.2	15.0	61.6	13.5		
15.0	13.7	72.3	14.6	72.2	14.9	72.0	15.3	70.0	14.9	67.2	14.2	61.6	12.8		
120% 60.00 kW	-19.8	-20.0	32.6	8.10	32.5	8.89	32.3	9.68	32.2	10.1	32.2	10.5	32.0	11.3	
	-18.8	-19.0	33.2	8.33	33.0	9.11	32.9	9.9	32.8	10.3	32.8	10.7	32.6	11.4	
	-16.7	-17.0	34.5	8.80	34.3	9.5	34.2	10.3	34.1	10.7	34.0	11.0	33.9	11.8	
	-13.7	-15.0	35.9	9.3	35.7	10.0	35.6	10.7	35.5	11.1	35.5	11.4	35.3	12.1	
	-11.8	-13.0	37.4	9.8	37.3	10.4	37.2	11.1	37.1	11.5	37.0	11.8	36.9	12.5	
	-9.8	-11.0	39.2	10.2	39.0	10.9	38.9	11.5	38.8	11.9	38.7	12.2	38.6	12.9	
	-9.5	-10.0	40.1	10.5	39.9	11.1	39.8	11.8	39.7	12.1	39.6	12.4	39.5	13.0	
	-8.5	-9.1	40.9	10.7	40.8	11.3	40.6	11.9	40.6	12.3	40.5	12.6	40.3	13.2	
	-7.0	-7.6	42.4	11.0	42.3	11.6	42.1	12.2	42.0	12.5	42.0	12.8	41.8	13.5	
	-5.0	-5.6	44.5	11.5	44.4	12.1	44.2	12.6	44.1	12.9	44.1	13.2	43.9	13.8	
	-3.0	-3.7	46.6	11.9	46.5	12.5	46.3	13.0	46.3	13.3	46.2	13.6	46.1	14.1	
	0.0	-0.7	50.2	12.6	50.1	13.1	50.0	13.6	49.9	13.8	49.8	14.1	49.7	14.6	
	3.0	2.2	54.1	13.1	53.9	13.6	53.8	14.1	53.7	14.3	53.6	14.5	53.5	15.0	
	5.0	4.1	56.7	13.5	56.6	13.9	56.4	14.4	56.4	14.6	56.3	14.8	56.2	15.3	
	7.0	6.0	59.5	13.8	59.4	14.2	59.2	14.7	59.2	14.9	59.1	15.1	56.9	14.7	
	9.0	7.9	62.4	14.1	62.3	14.5	62.1	14.9	62.1	15.1	62.0	15.3	56.9	13.8	
11.0	9.8	65.5	14.4	65.3	14.8	65.2	15.2	64.6	15.2	62.0	14.5	56.9	13.1		
13.0	11.8	68.8	14.7	68.7	15.1	67.2	15.0	64.6	14.3	62.0	13.6	56.9	12.3		
15.0	13.7	72.1	15.0	72.0	15.4	67.2	14.2	64.6	13.5	62.0	12.9	56.9	11.7		
110% 55.00 kW	-19.8	-20.0	32.4	9.09	32.3	9.8	32.2	10.5	32.1	10.9	32.0	11.3	31.9	12.0	
	-18.8	-19.0	33.0	9.30	32.9	10.0	32.7	10.7	32.7	11.1	32.6	11.4	32.5	12.1	
	-16.7	-17.0	34.3	9.7	34.1	10.4	34.0	11.1	34.0	11.4	33.9	11.8	33.8	12.5	
	-13.7	-15.0	35.7	10.2	35.6	10.8	35.4	11.5	35.4	11.8	35.3	12.1	35.2	12.8	
	-11.8	-13.0	37.3	10.6	37.1	11.2	37.0	11.9	36.9	12.2	36.9	12.5	36.7	13.1	
	-9.8	-11.0	39.0	11.1	38.8	11.7	38.7	12.3	38.7	12.6	38.6	12.9	38.5	13.5	
	-9.5	-10.0	39.9	11.3	39.8	11.9	39.6	12.4	39.6	12.7	39.5	13.0	39.4	13.6	
	-8.5	-9.1	40.7	11.5	40.6	12.0	40.5	12.6	40.4	12.9	40.3	13.2	40.2	13.8	
	-7.0	-7.6	42.2	11.8	42.1	12.3	42.0	12.9	41.9	13.2	41.8	13.5	41.7	14.0	
	-5.0	-5.6	44.3	12.2	44.2	12.7	44.1	13.3	44.0	13.5	43.9	13.8	43.8	14.3	
	-3.0	-3.7	46.4	12.6	46.3	13.1	46.2	13.6	46.1	13.9	46.1	14.1	45.9	14.6	
	0.0	-0.7	50.1	13.2	49.9	13.6	49.8	14.1	49.7	14.3	49.7	14.6	49.5	15.0	
	3.0	2.2	53.9	13.7	53.7	14.1	53.6	14.6	53.6	14.8	53.5	15.0	52.1	14.9	
	5.0	4.1	56.5	14.0	56.4	14.4	56.3	14.8	56.2	15.1	56.2	15.3	52.1	14.0	
	7.0	6.0	59.3	14.3	59.2	14.7	59.1	15.1	59.0	15.3	56.9	14.7	52.1	13.2	
	9.0	7.9	62.3	14.6	62.1	15.0	61.6	15.2	59.2	14.5	56.9	13.8	52.1	12.5	
11.0	9.8	65.3	14.9	65.2	15.3	61.6	14.4	59.2	13.7	56.9	13.1	52.1	11.8		
13.0	11.8	68.7	15.2	66.3	14.8	61.6	13.5	59.2	12.9	56.9	12.3	52.1	11.1		
15.0	13.7	71.1	15.1	66.3	13.9	61.6	12.8	59.2	12.2	56.9	11.7	52.1	10.6		
100% 50.00 kW	-19.8	-20.0	32.2	10.1	32.1	10.7	32.0	11.4	31.9	11.7	31.9	12.1	31.8	12.7	
	-18.8	-19.0	32.8	10.3	32.7	10.9	32.6	11.6	32.5	11.9	32.5	12.2	32.4	12.9	
	-16.7	-17.0	34.1	10.7	34.0	11.3	33.9	11.9	33.8	12.2	33.7	12.5	33.6	13.2	
	-13.7	-15.0	35.5	11.1	35.4	11.7	35.3	12.3	35.2	12.6	35.2	12.9	35.1	13.5	
	-11.8	-13.0	37.1	11.5	37.0	12.0	36.9	12.6	36.8	12.9	36.7	13.2	36.6	13.8	
	-9.8	-11.0	38.8	11.9	38.7	12.4	38.6	13.0	38.5	13.2	38.4	13.5	38.3	14.1	
	-9.5	-10.0	39.7	12.1	39.6	12.6	39.5	13.1	39.4	13.4	39.4	13.7	39.2	14.2	
	-8.5	-9.1	40.6	12.3	40.4	12.8	40.3	13.3	40.3	13.6	40.2	13.8	40.1	14.3	
	-7.0	-7.6	42.0	12.5	41.9	13.1	41.8	13.6	41.7	13.8	41.7	14.1	41.6	14.6	
	-5.0	-5.6	44.1	12.9	44.0	13.4	43.9	13.9	43.8	14.1	43.8	14.4	43.7	14.8	
	-3.0	-3.7	46.3	13.3	46.1	13.7	46.0	14.2	46.0	14.4	45.9	14.6	45.8	15.1	
	0.0	-0.7	49.9	13.8	49.8	14.2	49.7	14.7	49.6	14.9	49.5	15.1	47.4	14.5	
	3.0	2.2	53.7	14.3	53.6	14.7	53.5	15.1	53.4	15.3	51.7	14.7	47.4	13.3	
	5.0	4.1	56.4	14.6	56.2	15.0	56.0	15.3	53.8	14.6	51.7	13.9	47.4	12.5	
	7.0	6.0	59.2	14.9	59.0	15.2	56.0	14.4	53.8	13.7	51.7	13.1	47.4	11.8	
	9.0	7.9	62.1	15.1	60.3	14.8	56.0	13.6	53.8	13.0	51.7	12.4	47.4	11.2	
11.0	9.8	64.6	15.2	60.3	14.0	56.0	12.8	53.8	12.3	51.7	11.7	47.4	10.6		
13.0	11.8	64.6	14.3	60.3	13.2	56.0	12.1	53.8	11.6	51.7	11.0	47.4	10.0		
15.0	13.7	64.6	13.5	60.3	12.5	56.0	11.5	53.8	11.0	51.7	10.5	47.4	9.5		

NOTES - ANMERKUNGEN - Σημειώσεις - NOTAS - REMARQUES - NOTE - OPMERKINGEN - примечания - NOTLAR

- █ is shown as reference. When selecting the unit models, avoid the Outdoor air temperature range shown by █.

█ dient als Verweis. Vermeiden Sie bei der Auswahl der Gerätemodelle den als markierten Temperaturbereich der Außenluft.

█ είναι ενδεικτική, κατά την επιλογή των μοντέλων των μονάδων, αποφεύγετε το εύρος θερμοκρασίας εξωτερικού αέρα που υποδεικνύεται.

█ se muestra como referencia. Cuando seleccione los modelos de unidad, evite el intervalo de temperaturas del aire exterior indicado mediante █.

█ est montré comme référence. Lors du choix des modèles d'unités, évitez la plage de températures de l'air extérieur illustré par █.

█ valori riportati unicamente come riferimento. Nel selezionare i modelli delle unità, non considerare i valori di temperatura dell'aria esterna indicati con il colore █.

█ is als referentie getoond. Wanneer modellen van eenheden worden gekozen, vermijd dan het bereik van buitenluchttemperaturen geïllustreerd door █.

█ показан как. При выборе модели устройства избегайте внешнюю температуру воздуха, указанную в █.

█ referans olarak gösterilmektedir. Ünite modellerini seçerken, belirtilen Dış hava sıcaklığı aralığından kaçınınız █.
- The above table shows the average value of conditions which may occur.

Die obige Tabelle zeigt den Durchschnittswert der Bedingungen, die auftreten können.

Στον παραπάνω πίνακα αναγράφεται η μέση τιμή για συνθήκες που μπορεί να προκύψουν.

La tabla de arriba muestra el valor medio de condiciones que pueden ocurrir.

Le tableau ci-dessus donne la valeur moyenne pour des conditions qui peuvent survenir.

La tabella in alto mostra il valore delle condizioni medie che si possono riscontrare.

De tabel hierboven geeft de gemiddelde waarde aan van situaties die kunnen voorvallen.

Таблица расположенная выше показывает среднее значение условий, которые могут наступить.

Yukarıdaki tablo meydana gelebilecek koşulların ortalama değerini göstermektedir.

3D079549

5 Таблицы производительности

5 - 2 Таблицы теплопроизводительностей

5

RXYQ18T														
Indoor air temp. °CDB														
Combination(%) (Capacity index)	Outdoor air temp.		16.0		18.0		20.0		21.0		22.0		24.0	
			TC	PI	TC	PI	TC	PI	TC	PI	TC	PI	TC	PI
	(°CDB)	(°CWB)	KW	KW	KW	KW	KW	KW	KW	KW	KW	KW	KW	KW
90% 45.00 kW	-19.8	-20.0	32.1	11.1	32.0	11.7	31.8	12.3	31.8	12.6	31.7	12.8	31.6	13.4
	-18.8	-19.0	32.6	11.2	32.5	11.8	32.4	12.4	32.4	12.7	32.3	13.0	32.2	13.6
	-16.7	-17.0	33.9	11.6	33.8	12.2	33.7	12.7	33.7	13.0	33.6	13.3	33.5	13.8
	-13.7	-15.0	35.3	12.0	35.2	12.5	35.1	13.0	35.1	13.3	35.0	13.6	34.9	14.1
	-11.8	-13.0	36.9	12.3	36.8	12.8	36.7	13.4	36.6	13.6	36.6	13.9	36.5	14.4
	-9.8	-11.0	38.6	12.7	38.5	13.2	38.4	13.7	38.4	13.9	38.3	14.2	38.2	14.7
	-9.5	-10.0	39.5	12.9	39.4	13.4	39.3	13.8	39.3	14.1	39.2	14.3	39.1	14.8
	-8.5	-9.1	40.4	13.0	40.3	13.5	40.2	14.0	40.1	14.2	40.1	14.4	40.0	14.9
	-7.0	-7.6	41.9	13.3	41.8	13.8	41.7	14.2	41.6	14.4	41.5	14.7	41.4	15.1
	-5.0	-5.6	44.0	13.6	43.9	14.1	43.8	14.5	43.7	14.7	43.6	14.9	42.6	14.9
	-3.0	-3.7	46.1	14.0	46.0	14.4	45.9	14.8	45.8	15.0	45.8	15.2	42.6	14.0
	0.0	-0.7	49.7	14.4	49.6	14.8	49.5	15.2	48.5	14.9	46.5	14.2	42.6	12.8
	3.0	2.2	53.5	14.9	53.4	15.2	50.4	14.3	48.5	13.6	46.5	13.0	42.6	11.7
	5.0	4.1	56.2	15.1	54.3	14.7	50.4	13.5	48.5	12.9	46.5	12.3	42.6	11.1
	7.0	6.0	58.2	15.1	54.3	13.9	50.4	12.7	48.5	12.2	46.5	11.6	42.6	10.5
	9.0	7.9	58.2	14.2	54.3	13.1	50.4	12.0	48.5	11.5	46.5	11.0	42.6	10.0
11.0	9.8	58.2	13.4	54.3	12.4	50.4	11.4	48.5	10.9	46.5	10.4	42.6	9.4	
13.0	11.8	58.2	12.6	54.3	11.7	50.4	10.7	48.5	10.3	46.5	9.8	42.6	8.9	
15.0	13.7	58.2	12.0	54.3	11.1	50.4	10.2	48.5	9.7	46.5	9.3	42.6	8.49	
80% 40.00 kW	-19.8	-20.0	31.9	12.1	31.8	12.6	31.7	13.1	31.6	13.4	31.6	13.6	31.5	14.2
	-18.8	-19.0	32.5	12.2	32.4	12.7	32.3	13.2	32.2	13.5	32.2	13.8	32.1	14.3
	-16.7	-17.0	33.7	12.5	33.7	13.0	33.6	13.5	33.5	13.8	33.5	14.0	33.4	14.5
	-13.7	-15.0	35.2	12.9	35.1	13.3	35.0	13.8	34.9	14.0	34.9	14.3	34.8	14.8
	-11.8	-13.0	36.7	13.2	36.6	13.6	36.5	14.1	36.5	14.3	36.5	14.6	36.4	15.0
	-9.8	-11.0	38.4	13.5	38.4	13.9	38.3	14.4	38.2	14.6	38.2	14.8	37.9	15.1
	-9.5	-10.0	39.4	13.7	39.3	14.1	39.2	14.5	39.1	14.7	39.1	14.9	37.9	14.7
	-8.5	-9.1	40.2	13.8	40.1	14.2	40.0	14.6	40.0	14.9	39.9	15.1	37.9	14.3
	-7.0	-7.6	41.7	14.1	41.6	14.5	41.5	14.9	41.5	15.1	41.4	15.2	37.9	13.7
	-5.0	-5.6	43.8	14.4	43.7	14.7	43.6	15.1	43.1	15.1	41.4	14.3	37.9	12.9
	-3.0	-3.7	45.9	14.6	45.8	15.0	44.8	14.9	43.1	14.2	41.4	13.5	37.9	12.2
	0.0	-0.7	49.5	15.1	48.2	14.8	44.8	13.6	43.1	13.0	41.4	12.4	37.9	11.2
	3.0	2.2	51.7	14.7	48.2	13.6	44.8	12.4	43.1	11.9	41.4	11.3	37.9	10.3
	5.0	4.1	51.7	13.9	48.2	12.8	44.8	11.7	43.1	11.2	41.4	10.7	37.9	9.7
	7.0	6.0	51.7	13.1	48.2	12.1	44.8	11.1	43.1	10.6	41.4	10.2	37.9	9.2
	9.0	7.9	51.7	12.4	48.2	11.4	44.8	10.5	43.1	10.1	41.4	9.6	37.9	8.76
11.0	9.8	51.7	11.7	48.2	10.8	44.8	10.0	43.1	9.5	41.4	9.1	37.9	8.32	
13.0	11.8	51.7	11.0	48.2	10.2	44.8	9.4	43.1	9.0	41.4	8.65	37.9	7.89	
15.0	13.7	51.7	10.5	48.2	9.7	44.8	9.0	43.1	8.58	41.4	8.22	37.9	7.51	
70% 35.00 kW	-19.8	-20.0	31.7	13.0	31.6	13.5	31.5	14.0	31.5	14.2	31.5	14.4	31.4	14.9
	-18.8	-19.0	32.3	13.2	32.2	13.6	32.1	14.1	32.1	14.3	32.0	14.5	32.0	15.0
	-16.7	-17.0	33.6	13.5	33.5	13.9	33.4	14.3	33.4	14.6	33.3	14.8	33.2	15.2
	-13.7	-15.0	35.0	13.7	34.9	14.2	34.8	14.6	34.8	14.8	34.7	15.0	33.2	14.4
	-11.8	-13.0	36.6	14.0	36.5	14.4	36.4	14.8	36.4	15.0	36.2	15.2	33.2	13.7
	-9.8	-11.0	38.3	14.3	38.2	14.7	38.1	15.1	37.7	15.0	36.2	14.3	33.2	12.9
	-9.5	-10.0	39.2	14.5	39.1	14.8	39.0	15.2	37.7	14.6	36.2	13.9	33.2	12.6
	-8.5	-9.1	40.0	14.6	39.9	15.0	39.2	14.9	37.7	14.2	36.2	13.6	33.2	12.3
	-7.0	-7.6	41.5	14.8	41.4	15.2	39.2	14.3	37.7	13.6	36.2	13.0	33.2	11.7
	-5.0	-5.6	43.6	15.1	42.2	14.7	39.2	13.5	37.7	12.8	36.2	12.3	33.2	11.1
	-3.0	-3.7	45.2	15.1	42.2	13.9	39.2	12.7	37.7	12.1	36.2	11.6	33.2	10.5
	0.0	-0.7	45.2	13.7	42.2	12.7	39.2	11.6	37.7	11.1	36.2	10.6	33.2	9.65
	3.0	2.2	45.2	12.6	42.2	11.6	39.2	10.7	37.7	10.2	36.2	9.8	33.2	8.90
	5.0	4.1	45.2	11.9	42.2	11.0	39.2	10.1	37.7	9.7	36.2	9.26	33.2	8.44
	7.0	6.0	45.2	11.2	42.2	10.4	39.2	9.6	37.7	9.18	36.2	8.79	33.2	8.02
	9.0	7.9	45.2	10.6	42.2	9.8	39.2	9.08	37.7	8.71	36.2	8.34	33.2	7.62
11.0	9.8	45.2	10.1	42.2	9.3	39.2	8.62	37.7	8.27	36.2	7.93	33.2	7.25	
13.0	11.8	45.2	9.5	42.2	8.84	39.2	8.17	37.7	7.85	36.2	7.52	33.2	6.89	
15.0	13.7	45.2	9.0	42.2	8.40	39.2	7.78	37.7	7.47	36.2	7.17	33.2	6.57	
60% 30.00 kW	-19.8	-20.0	31.5	14.0	31.5	14.4	31.4	14.8	31.4	15.0	31.0	15.0	28.4	13.5
	-18.8	-19.0	32.1	14.2	32.0	14.5	32.0	14.9	31.9	15.1	31.0	14.7	28.4	13.2
	-16.7	-17.0	33.4	14.4	33.3	14.8	33.3	15.1	32.3	14.7	31.0	14.0	28.4	12.6
	-13.7	-15.0	34.8	14.6	34.7	15.0	33.6	14.6	32.3	14.0	31.0	13.3	28.4	12.0
	-11.8	-13.0	36.4	14.9	36.2	15.2	33.6	13.9	32.3	13.2	31.0	12.6	28.4	11.4
	-9.8	-11.0	38.1	15.1	36.2	14.3	33.6	13.1	32.3	12.5	31.0	12.0	28.4	10.8
	-9.5	-10.0	38.8	15.1	36.2	13.9	33.6	12.8	32.3	12.2	31.0	11.6	28.4	10.5
	-8.5	-9.1	38.8	14.7	36.2	13.6	33.6	12.4	32.3	11.9	31.0	11.3	28.4	10.3
	-7.0	-7.6	38.8	14.1	36.2	13.0	33.6	11.9	32.3	11.4	31.0	10.9	28.4	9.88
	-5.0	-5.6	38.8	13.3	36.2	12.3	33.6	11.3	32.3	10.8	31.0	10.3	28.4	9.35
	-3.0	-3.7	38.8	12.6	36.2	11.6	33.6	10.7	32.3	10.20	31.0	9.76	28.4	8.88
	0.0	-0.7	38.8	11.5	36.2	10.6	33.6	9.79	32.3	9.38	31.0	8.97	28.4	8.18
	3.0	2.2	38.8	10.5	36.2	9.77	33.6	9.02	32.3	8.65	31.0	8.28	28.4	7.57
	5.0	4.1	38.8	10.0	36.2	9.26	33.6	8.56	32.3	8.21	31.0	7.87	28.4	7.20
	7.0	6.0	38.8	9.47	36.2	8.79	33.6	8.13	32.3	7.80	31.0	7.48	28.4	6.85
	9.0	7.9	38.8	8.98	36.2	8.34	33.6	7.72	32.3	7.42	31.0	7.12	28.4	6.53
11.0	9.8	38.8	8.52	36.2	7.93	33.6	7.35	32.3	7.06	31.0	6.78	28.4	6.22	
13.0	11.8	38.8	8.08	36.2	7.52	33.6	6.98	32.3	6.71	31.0	6.45	28.4	5.93	
15.0	13.7	38.8	7.69	36.2	7.17	33.6	6.66	32.3	6.40	31.0	6.16	28.4	5.67	
50% 25.00 kW	-19.8	-20.0	31.4	15.0	30.2	14.5	28.0	13.3	26.9	12.7	25.8	12.1	23.7	10.9
	-18.8	-19.0	31.9	15.1	30.2	14.2	28.0	13.0	26.9	12.4	25.8	11.8	23.7	10.7
	-16.7	-17.0	32.3	14.7	30.2	13.5	28.0	12.4	26.9	11.8	25.8	11.3	23.7	10.3
	-13.7	-15.0	32.3	14.0	30.2	12.9	28.0	11.8	26.9	11.3	25.8	10.8	23.7	9.79
	-11.8	-13.0	32.3	13.2	30.2	12.2	28.0	11.2	26.9	10.7	25.8	10.26	23.7	9.32
	-9.8	-11.0	32.3	12.5	30.2	11.6	28.0	10.6	26.9	10.19	25.8	9.74	23.7	8.86
	-9.5	-10.0	32.3	12.2	30.2	11.3	28.0	10.37	26.9	9.92	25.8	9.49	23.7	8.64
	-8.5	-9.1	32.3	11.9	30.2	11.0	28.0	10.12	26.9	9.69	25.8	9.27	23.7	8.44
	-7.0	-7.6	32.3	11.4	30.2	10.54	28.0	9.71	26.9	9.31	25.8	8.91	23.7	8.12
	-5.0	-5.6	32.3	10.8	30.2	9.97	28.0	9.20	26.9	8.82	25.8	8.44	23.7	7.71
	-3.0	-3.7	32.3	10.20	30.2	9.46	28.0	8.73	26.9	8.38	25.8	8.03	23.7	7.34
	0.0	-0.7	32.3	9.38	30.2	8.71	28.0	8.05	26.9	7.73	25.8	7.41	23.7	6

5 Таблицы производительности

5 - 2 Таблицы теплопроизводительностей

RXYQ20T		Indoor air temp. °CDB												
Combination(%) (Capacity index)	Outdoor air temp.		16.0		18.0		20.0		21.0		22.0		24.0	
	(°CDB)	(°CWB)	TC	PI	TC	PI	TC	PI	TC	PI	TC	PI	TC	PI
			KW	KW	KW	KW	KW	KW	KW	KW	KW	KW	KW	KW
130% 72.80 kW	-19.8	-20.0	36.2	7.79	36.1	8.79	35.9	9.79	35.8	10.3	35.7	10.8	35.6	11.8
	-18.8	-19.0	37.0	8.14	36.9	9.12	36.7	10.1	36.6	10.6	36.5	11.1	36.4	12.1
	-16.7	-17.0	38.7	8.83	38.5	9.8	38.4	10.7	38.3	11.2	38.2	11.6	38.0	12.6
	-13.7	-15.0	40.5	9.49	40.3	10.4	40.2	11.3	40.1	11.7	40.0	12.2	39.8	13.1
	-11.8	-13.0	42.4	10.1	42.2	11.0	42.0	11.8	41.9	12.3	41.9	12.7	41.7	13.5
	-9.8	-11.0	44.4	10.7	44.2	11.6	44.0	12.4	43.9	12.8	43.8	13.2	43.7	14.0
	-9.5	-10.0	45.4	11.0	45.2	11.8	45.0	12.6	45.0	13.0	44.9	13.4	44.7	14.2
	-8.5	-9.1	46.3	11.3	46.2	12.1	46.0	12.8	45.9	13.2	45.8	13.6	45.7	14.4
	-7.0	-7.6	48.0	11.7	47.8	12.5	47.6	13.2	47.5	13.6	47.4	14.0	47.3	14.7
	-5.0	-5.6	50.2	12.3	50.1	13.0	49.9	13.7	49.8	14.0	49.7	14.4	49.5	15.1
	-3.0	-3.7	52.5	12.8	52.3	13.4	52.1	14.1	52.0	14.5	51.9	14.8	51.8	15.5
	0.0	-0.7	56.2	13.5	56.0	14.1	55.8	14.7	55.8	15.1	55.7	15.4	55.5	16.0
	3.0	2.2	60.0	14.1	59.8	14.7	59.7	15.3	59.6	15.6	59.5	15.9	59.3	16.5
	5.0	4.1	62.6	14.5	62.4	15.1	62.3	15.7	62.2	15.9	62.1	16.2	61.9	16.8
	7.0	6.0	65.3	14.9	65.1	15.4	65.0	16.0	64.9	16.3	64.8	16.5	64.6	17.1
	9.0	7.9	68.1	15.3	67.9	15.8	67.8	16.3	67.7	16.6	67.6	16.8	67.4	17.3
11.0	9.8	71.0	15.6	70.8	16.1	70.7	16.6	70.6	16.8	70.5	17.1	70.3	17.2	
13.0	11.8	74.2	15.9	74.0	16.4	73.8	16.9	73.7	17.1	73.6	17.4	73.4	17.3	
15.0	13.7	77.2	16.2	77.1	16.7	76.9	17.2	76.8	17.4	76.7	17.2	76.6	17.2	
120% 67.20 kW	-19.8	-20.0	36.0	8.94	35.9	9.87	35.7	10.8	35.6	11.3	35.6	11.7	35.4	12.6
	-18.8	-19.0	36.8	9.27	36.7	10.2	36.5	11.1	36.4	11.5	36.4	12.0	36.2	12.9
	-16.7	-17.0	38.5	9.9	38.4	10.8	38.2	11.6	38.1	12.1	38.0	12.5	37.9	13.4
	-13.7	-15.0	40.3	10.5	40.1	11.3	40.0	12.2	39.9	12.6	39.8	13.0	39.7	13.8
	-11.8	-13.0	42.2	11.1	42.0	11.9	41.9	12.7	41.8	13.1	41.7	13.5	41.5	14.2
	-9.8	-11.0	44.2	11.7	44.0	12.4	43.8	13.2	43.8	13.5	43.7	13.9	43.5	14.7
	-9.5	-10.0	45.2	12.0	45.0	12.7	44.9	13.4	44.8	13.8	44.7	14.1	44.6	14.9
	-8.5	-9.1	46.1	12.2	46.0	12.9	45.8	13.6	45.7	14.0	45.7	14.3	45.5	15.1
	-7.0	-7.6	47.8	12.6	47.6	13.3	47.4	14.0	47.4	14.3	47.3	14.7	47.1	15.3
	-5.0	-5.6	50.0	13.1	49.9	13.7	49.7	14.4	49.6	14.7	49.5	15.1	49.4	15.7
	-3.0	-3.7	52.3	13.5	52.1	14.2	51.9	14.8	51.9	15.1	51.8	15.4	51.6	16.0
	0.0	-0.7	56.0	14.2	55.8	14.8	55.7	15.4	55.6	15.7	55.5	16.0	55.3	16.5
	3.0	2.2	59.8	14.8	59.6	15.4	59.5	15.9	59.4	16.2	59.3	16.4	59.2	17.0
	5.0	4.1	62.4	15.2	62.3	15.7	62.1	16.2	62.0	16.5	61.9	16.7	61.8	17.3
	7.0	6.0	65.1	15.5	65.0	16.0	64.8	16.5	64.7	16.8	64.6	17.0	64.0	17.3
	9.0	7.9	67.9	15.9	67.8	16.3	67.6	16.8	67.5	17.1	67.4	17.3	67.0	17.3
11.0	9.8	70.8	16.2	70.7	16.6	70.5	17.1	70.4	17.3	69.8	17.3	69.0	17.3	
13.0	11.8	74.0	16.5	73.8	16.9	73.6	17.4	73.5	17.3	73.4	17.3	73.0	17.3	
15.0	13.7	77.0	16.8	76.9	17.2	76.8	17.2	76.7	17.2	76.6	17.2	76.0	17.2	
110% 61.60 kW	-19.8	-20.0	35.8	10.1	35.7	10.9	35.6	11.8	35.5	12.2	35.4	12.6	35.3	13.5
	-18.8	-19.0	36.6	10.4	36.5	11.2	36.4	12.1	36.3	12.5	36.2	12.9	36.1	13.7
	-16.7	-17.0	38.3	11.0	38.2	11.8	38.0	12.6	38.0	13.0	37.9	13.4	37.7	14.1
	-13.7	-15.0	40.1	11.5	40.0	12.3	39.8	13.1	39.7	13.4	39.7	13.8	39.5	14.6
	-11.8	-13.0	42.0	12.1	41.8	12.8	41.7	13.5	41.6	13.9	41.5	14.2	41.4	15.0
	-9.8	-11.0	44.0	12.6	43.8	13.3	43.7	14.0	43.6	14.3	43.5	14.7	43.4	15.4
	-9.5	-10.0	45.0	12.9	44.8	13.5	44.7	14.2	44.6	14.5	44.6	14.9	44.4	15.5
	-8.5	-9.1	45.9	13.1	45.8	13.7	45.7	14.4	45.6	14.7	45.5	15.1	45.4	15.7
	-7.0	-7.6	47.6	13.4	47.4	14.1	47.3	14.7	47.2	15.0	47.1	15.3	47.0	16.0
	-5.0	-5.6	49.8	13.9	49.7	14.5	49.5	15.1	49.5	15.4	49.4	15.7	49.2	16.3
	-3.0	-3.7	52.1	14.3	51.9	14.9	51.8	15.5	51.7	15.8	51.6	16.0	51.5	16.6
	0.0	-0.7	55.8	14.9	55.6	15.5	55.5	16.0	55.4	16.3	55.3	16.5	55.2	17.1
	3.0	2.2	59.6	15.5	59.5	16.0	59.3	16.5	59.2	16.7	59.2	17.0	58.6	17.3
	5.0	4.1	62.2	15.8	62.1	16.3	61.9	16.8	61.9	17.0	61.8	17.3	61.6	17.3
	7.0	6.0	64.9	16.2	64.8	16.6	64.6	17.1	64.6	17.3	64.0	17.3	63.6	17.3
	9.0	7.9	67.7	16.5	67.6	16.9	67.4	17.3	67.3	17.3	67.0	17.3	66.6	17.3
11.0	9.8	70.6	16.8	70.5	17.2	70.3	17.2	70.2	17.2	70.0	17.2	69.6	17.3	
13.0	11.8	73.8	17.0	73.6	17.4	73.5	17.3	73.4	17.3	73.0	17.3	72.6	17.3	
15.0	13.7	76.8	17.3	76.6	17.0	76.5	17.2	76.4	17.2	76.0	17.2	75.6	17.2	
100% 56.00 kW	-19.8	-20.0	35.6	11.3	35.5	12.0	35.4	12.8	35.3	13.2	35.2	13.6	35.1	14.3
	-18.8	-19.0	36.4	11.5	36.3	12.3	36.2	13.0	36.1	13.4	36.0	13.8	35.9	14.5
	-16.7	-17.0	38.1	12.1	38.0	12.8	37.9	13.5	37.8	13.9	37.7	14.2	37.6	14.9
	-13.7	-15.0	39.9	12.6	39.8	13.3	39.6	13.9	39.6	14.3	39.5	14.6	39.4	15.3
	-11.8	-13.0	41.8	13.1	41.7	13.7	41.5	14.4	41.5	14.7	41.4	15.0	41.3	15.7
	-9.8	-11.0	43.8	13.5	43.6	14.2	43.5	14.8	43.4	15.1	43.4	15.4	43.2	16.0
	-9.5	-10.0	44.8	13.8	44.7	14.4	44.5	15.0	44.5	15.3	44.4	15.6	44.3	16.2
	-8.5	-9.1	45.7	14.0	45.6	14.6	45.5	15.2	45.4	15.5	45.3	15.8	45.2	16.4
	-7.0	-7.6	47.4	14.3	47.2	14.9	47.1	15.5	47.0	15.7	47.0	16.0	46.8	16.6
	-5.0	-5.6	49.6	14.7	49.5	15.3	49.4	15.8	49.3	16.1	49.2	16.4	49.1	16.9
	-3.0	-3.7	51.9	15.1	51.7	15.6	51.6	16.2	51.5	16.4	51.5	16.7	51.3	17.2
	0.0	-0.7	55.6	15.7	55.5	16.2	55.3	16.6	55.3	16.9	55.2	17.1	55.0	17.5
	3.0	2.2	59.4	16.2	59.3	16.6	59.1	17.1	59.1	17.3	58.2	17.1	58.0	17.5
	5.0	4.1	62.0	16.5	61.9	16.9	61.8	17.4	61.7	17.4	61.6	17.4	61.4	17.5
	7.0	6.0	64.7	16.8	64.6	17.2	64.5	17.0	64.4	17.0	64.3	17.0	64.2	17.0
	9.0	7.9	67.5	17.1	67.4	17.5	67.3	17.2	67.2	17.2	67.1	17.2	67.0	17.2
11.0	9.8	70.4	17.3	70.3	17.8	70.2	17.5	70.1	17.5	70.0	17.5	69.9	17.5	
13.0	11.8	72.7	17.3	72.6	17.8	72.5	17.5	72.4	17.5	72.3	17.5	72.2	17.5	
15.0	13.7	72.7	16.4	72.6	15.2	72.5	15.2	72.4	15.2	72.3	15.2	72.2	15.2	

NOTES - ANMERKUNGEN - Σημειώσεις - NOTAS - REMARQUES - NOTE - OPMERKINGEN - примечания - NOTLAR

- █ is shown as reference. When selecting the unit models, avoid the Outdoor air temperature range shown by █.

█ dient als Verweis. Vermeiden Sie bei der Auswahl der Gerätemodelle den als markierten Temperaturbereich der Außenluft.

Н █ είναι ενδεικτική, κατά την επιλογή των μοντέλων των μονάδων, αποφεύγετε το εύρος θερμοκρασίας εξωτερικού αέρα που υποδεικνύεται █.

█ se muestra como referencia. Cuando seleccione los modelos de unidad, evite el intervalo de temperaturas del aire exterior indicado mediante █.

█ est montré comme référence. Lors du choix des modèles d'unités, évitez la plage de températures de l'air extérieur illustré par █.

█ valori riportati unicamente come riferimento. Nel selezionare i modelli delle unità, non considerare i valori di temperatura dell'aria esterna indicati con il colore █.

█ is als referentie getoond. Wanneer modellen van eenheden worden gekozen, vermijd dan het bereik van buitenluchttemperaturen geïllustreerd door █.

█ показан как. При выборе модели устройства избегайте внешнюю температуру воздуха, указанную в █.

█ referans olarak gösterilmektedir. Ünite modellerini seçerken, belirtilen Dış hava sıcaklığı aralığından kaçınınız █.
- The above table shows the average value of conditions which may occur.

Die obige Tabelle zeigt den Durchschnittswert der Bedingungen, die auftreten können.

Στον παραπάνω πίνακα αναγράφεται η μέση τιμή για συνθήκες που μπορεί να προκύψουν.

La tabla de arriba muestra el valor medio de condiciones que pueden ocurrir.

Le tableau ci-dessus donne la valeur moyenne pour des conditions qui peuvent survenir.

La tabella in alto mostra il valore delle condizioni medie che si possono riscontrare.

De tabel hierboven geeft de gemiddelde waarde aan van situaties die kunnen voorvallen.

Таблица расположенная выше показывает среднее значение условий, которые могут наступ

5 Таблицы производительности

5 - 2 Таблицы теплопроизводительностей

5

RXYQ20T														
Indoor air temp. °CDB														
Combination(%) (Capacity index)	Outdoor air temp.		16.0		18.0		20.0		21.0		22.0		24.0	
			TC	PI	TC	PI	TC	PI	TC	PI	TC	PI	TC	PI
	(°CDB)	(°CWB)	KW	KW	KW	KW	KW	KW	KW	KW	KW	KW	KW	KW
90% 50.40 kW	-19.8	-20.0	35.4	12.4	35.3	13.1	35.2	13.8	35.1	14.1	35.1	14.5	35.0	15.2
	-18.8	-19.0	36.2	12.7	36.1	13.3	36.0	14.0	35.9	14.3	35.9	14.7	35.8	15.4
	-16.7	-17.0	37.9	13.1	37.8	13.8	37.7	14.4	37.6	14.8	37.6	15.1	37.4	15.7
	-13.7	-15.0	39.7	13.6	39.6	14.2	39.5	14.8	39.4	15.1	39.3	15.5	39.2	16.1
	-11.8	-13.0	41.6	14.1	41.5	14.6	41.3	15.2	41.3	15.5	41.2	15.8	41.1	16.4
	-9.8	-11.0	43.6	14.5	43.4	15.0	43.3	15.6	43.3	15.9	43.2	16.2	43.1	16.7
	-9.5	-10.0	44.6	14.7	44.5	15.2	44.4	15.8	44.3	16.1	44.2	16.3	44.1	16.9
	-8.5	-9.1	45.5	14.9	45.4	15.4	45.3	15.9	45.2	16.2	45.2	16.5	45.1	17.0
	-7.0	-7.6	47.2	15.2	47.1	15.7	46.9	16.2	46.9	16.5	46.8	16.7	46.7	17.2
	-5.0	-5.6	49.4	15.5	49.3	16.0	49.2	16.5	49.1	16.8	49.1	17.0	48.0	17.0
	-3.0	-3.7	51.7	15.9	51.5	16.4	51.4	16.8	51.4	17.1	51.3	17.3	48.0	16.1
	0.0	-0.7	55.4	16.4	55.3	16.8	55.1	17.3	54.5	17.2	52.3	16.4	48.0	14.8
	3.0	2.2	59.2	16.9	59.1	17.3	56.7	16.6	54.5	15.9	52.3	15.1	48.0	13.7
	5.0	4.1	61.8	17.1	61.1	17.2	56.7	15.8	54.5	15.1	52.3	14.4	48.0	13.0
	7.0	6.0	64.5	17.4	61.1	16.4	56.7	15.0	54.5	14.3	52.3	13.7	48.0	12.4
	9.0	7.9	65.4	16.9	61.1	15.6	56.7	14.3	54.5	13.7	52.3	13.0	48.0	11.8
	11.0	9.8	65.4	16.1	61.1	14.8	56.7	13.6	54.5	13.0	52.3	12.4	48.0	11.3
13.0	11.8	65.4	15.2	61.1	14.1	56.7	12.9	54.5	12.4	52.3	11.8	48.0	10.8	
15.0	13.7	65.4	14.5	61.1	13.4	56.7	12.4	54.5	11.8	52.3	11.3	48.0	10.3	
80% 44.80 kW	-19.8	-20.0	35.2	13.6	35.1	14.2	35.0	14.8	35.0	15.1	34.9	15.4	34.8	16.0
	-18.8	-19.0	36.0	13.8	35.9	14.4	35.8	15.0	35.8	15.3	35.7	15.6	35.6	16.2
	-16.7	-17.0	37.7	14.2	37.6	14.8	37.5	15.4	37.5	15.7	37.4	15.9	37.3	16.5
	-13.7	-15.0	39.5	14.6	39.4	15.2	39.3	15.7	39.2	16.0	39.2	16.3	39.1	16.8
	-11.8	-13.0	41.4	15.0	41.3	15.6	41.2	16.1	41.1	16.3	41.1	16.6	41.0	17.1
	-9.8	-11.0	43.4	15.4	43.3	15.9	43.2	16.4	43.1	16.7	43.0	16.9	42.6	16.7
	-9.5	-10.0	44.4	15.6	44.3	16.1	44.2	16.6	44.1	16.8	44.1	17.1	42.6	16.2
	-8.5	-9.1	45.3	15.8	45.2	16.2	45.1	16.7	45.1	17.0	45.0	17.2	42.6	16.3
	-7.0	-7.6	47.0	16.0	46.9	16.5	46.8	16.9	46.7	17.2	46.5	17.3	42.6	15.6
	-5.0	-5.6	49.2	16.4	49.1	16.8	49.0	17.2	48.5	17.2	46.5	16.4	42.6	14.8
	-3.0	-3.7	51.5	16.7	51.4	17.1	50.4	17.1	48.5	16.3	46.5	15.5	42.6	14.0
	0.0	-0.7	55.2	17.1	54.3	17.1	50.4	15.7	48.5	15.0	46.5	14.3	42.6	12.9
	3.0	2.2	58.2	17.1	54.3	15.8	50.4	14.5	48.5	13.9	46.5	13.2	42.6	12.0
	5.0	4.1	58.2	16.3	54.3	15.0	50.4	13.8	48.5	13.2	46.5	12.6	42.6	11.4
	7.0	6.0	58.2	15.5	54.3	14.3	50.4	13.1	48.5	12.6	46.5	12.0	42.6	10.9
	9.0	7.9	58.2	14.7	54.3	13.6	50.4	12.5	48.5	12.0	46.5	11.4	42.6	10.41
	11.0	9.8	58.2	14.0	54.3	12.9	50.4	11.9	48.5	11.4	46.5	10.9	42.6	9.95
13.0	11.8	58.2	13.3	54.3	12.3	50.4	11.4	48.5	10.9	46.5	10.42	42.6	9.50	
15.0	13.7	58.2	12.7	54.3	11.8	50.4	10.9	48.5	10.41	46.5	9.97	42.6	9.10	
70% 39.20 kW	-19.8	-20.0	35.0	14.7	35.0	15.3	34.9	15.8	34.8	16.1	34.8	16.3	34.7	16.9
	-18.8	-19.0	35.9	14.9	35.8	15.4	35.7	16.0	35.6	16.2	35.6	16.5	35.5	17.0
	-16.7	-17.0	37.5	15.3	37.4	15.8	37.3	16.3	37.3	16.5	37.2	16.8	37.2	17.3
	-13.7	-15.0	39.3	15.7	39.2	16.1	39.1	16.6	39.1	16.9	39.0	17.1	37.3	16.5
	-11.8	-13.0	41.2	16.0	41.1	16.5	41.0	16.9	41.0	17.2	40.7	17.3	37.3	15.6
	-9.8	-11.0	43.2	16.3	43.1	16.8	43.0	17.2	42.4	17.1	40.7	16.3	37.3	14.7
	-9.5	-10.0	44.2	16.5	44.1	16.9	44.0	17.4	42.4	16.6	40.7	15.8	37.3	14.3
	-8.5	-9.1	45.1	16.7	45.1	17.1	44.1	17.0	42.4	16.2	40.7	15.4	37.3	14.0
	-7.0	-7.6	46.8	16.9	46.7	17.3	44.1	16.3	42.4	15.5	40.7	14.8	37.3	13.4
	-5.0	-5.6	49.0	17.2	47.5	16.8	44.1	15.4	42.4	14.7	40.7	14.0	37.3	12.7
	-3.0	-3.7	50.9	17.3	47.5	15.9	44.1	14.6	42.4	13.9	40.7	13.3	37.3	12.1
	0.0	-0.7	50.9	15.9	47.5	14.6	44.1	13.4	42.4	12.9	40.7	12.3	37.3	11.2
	3.0	2.2	50.9	14.7	47.5	13.5	44.1	12.5	42.4	11.9	40.7	11.4	37.3	10.38
	5.0	4.1	50.9	13.9	47.5	12.9	44.1	11.9	42.4	11.4	40.7	10.87	37.3	9.90
	7.0	6.0	50.9	13.3	47.5	12.3	44.1	11.3	42.4	10.84	40.7	10.37	37.3	9.46
	9.0	7.9	50.9	12.6	47.5	11.7	44.1	10.79	42.4	10.35	40.7	9.91	37.3	9.05
	11.0	9.8	50.9	12.0	47.5	11.2	44.1	10.31	42.4	9.89	40.7	9.48	37.3	8.67
13.0	11.8	50.9	11.5	47.5	10.65	44.1	9.84	42.4	9.45	40.7	9.06	37.3	8.29	
15.0	13.7	50.9	11.0	47.5	10.19	44.1	9.43	42.4	9.05	40.7	8.68	37.3	7.95	
60% 33.60 kW	-19.8	-20.0	34.9	15.9	34.8	16.3	34.7	16.8	34.7	17.0	34.6	17.3	32.0	15.8
	-18.8	-19.0	35.7	16.0	35.6	16.5	35.5	16.9	35.5	17.2	34.9	17.0	32.0	15.3
	-16.7	-17.0	37.3	16.4	37.2	16.8	37.2	17.2	36.3	16.9	34.9	16.1	32.0	14.5
	-13.7	-15.0	39.1	16.7	39.0	17.1	37.8	16.7	36.3	16.0	34.9	15.2	32.0	13.8
	-11.8	-13.0	41.0	17.0	40.7	17.3	37.8	15.8	36.3	15.1	34.9	14.4	32.0	13.0
	-9.8	-11.0	43.0	17.3	40.7	16.3	37.8	14.9	36.3	14.3	34.9	13.6	32.0	12.3
	-9.5	-10.0	43.6	17.2	40.7	15.8	37.8	14.5	36.3	13.9	34.9	13.3	32.0	12.0
	-8.5	-9.1	43.6	16.8	40.7	15.4	37.8	14.2	36.3	13.5	34.9	12.9	32.0	11.7
	-7.0	-7.6	43.6	16.0	40.7	14.8	37.8	13.6	36.3	13.0	34.9	12.4	32.0	11.28
	-5.0	-5.6	43.6	15.2	40.7	14.0	37.8	12.9	36.3	12.3	34.9	11.8	32.0	10.71
	-3.0	-3.7	43.6	14.4	40.7	13.3	37.8	12.2	36.3	11.7	34.9	11.21	32.0	10.21
	0.0	-0.7	43.6	13.3	40.7	12.3	37.8	11.32	36.3	10.85	34.9	10.38	32.0	9.47
	3.0	2.2	43.6	12.3	40.7	11.40	37.8	10.52	36.3	10.09	34.9	9.67	32.0	8.83
	5.0	4.1	43.6	11.7	40.7	10.87	37.8	10.04	36.3	9.63	34.9	9.23	32.0	8.45
	7.0	6.0	43.6	11.17	40.7	10.37	37.8	9.59	36.3	9.21	34.9	8.83	32.0	8.09
	9.0	7.9	43.6	10.67	40.7	9.91	37.8	9.17	36.3	8.81	34.9	8.45	32.0	7.75
	11.0	9.8	43.6	10.19	40.7	9.48	37.8	8.78	36.3	8.44	34.9	8.10	32.0	7.44
13.0	11.8	43.6	9.73	40.7	9.06	37.8	8.40	36.3	8.07	34.9	7.75	32.0	7.13	
15.0	13.7	43.6	9.32	40.7	8.68	37.8	8.06	36.3	7.75	34.9	7.45	32.0	6.85	
50% 28.00 kW	-19.8	-20.0	34.7	17.0	33.9	16.9	31.5	15.5	30.3	14.8	29.1	14.1	26.7	12.8
	-18.8	-19.0	35.5	17.2	33.9	16.4	31.5	15.1	30.3	14.4	29.1	13.7	26.7	12.4
	-16.7	-17.0	36.3	16.9	33.9	15.6	31.5	14.3	30.3	13.6	29.1	13.0	26.7	11.8
	-13.7	-15.0	36.3	16.0	33.9	14.7	31.5	13.5	30.3	12.9	29.1	12.3	26.7	11.22
	-11.8	-13.0	36.3	15.1	33.9	13.9	31.5	12.8	30.3	12.3	29.1	11.7	26.7	10.65
	-9.8	-11.0	36.3	14.3	33.9	13.2	31.5	12.1	30.3	11.62	29.1	11.11	26.7	10.12
	-9.5	-10.0	36.3	13.9	33.9	12.8	31.5	11.8	30.3	11.32	29.1	10.83	26.7	9.87
	-8.5	-9.1	36.3	13.5	33.9	12.5	31.5	11.54	30.3	11.06	29.1	10.58	26.7	9.65
	-7.0	-7.6	36.3	13.0	33.9	12.0	31.5	11.10	30.3	10.64	29.1	10.18	26.7	9.29
	-5.0	-5.6	36.3	12.3	33.9	11.42	31.5	10.54	30.3	10.11	29.1	9.68	26.7	8.84
	-3.0	-3.7	36.3	11.72	33.9	10.87	31.5	10.04	30.3	9.63	29.1	9.23	26.7	8.45
	0.0	-0.7												

5 Таблицы производительности

5 - 2 Таблицы теплопроизводительностей

RXYQ22T		Indoor air temp. °CDB												TC: Total capacity (kW); PI: Power Input (kW) (Comp. + Outdoor fan motor)	
Combination(%) (Capacity index)	Outdoor air temp.		16.0		18.0		20.0		21.0		22.0		24.0		
	(°CDB)	(°CWB)	TC	PI	TC	PI	TC	PI	TC	PI	TC	PI	TC	PI	
130% 79.95 kW	-19.8	-20.0	40.8	8.60	40.6	9.59	40.5	10.6	40.4	11.1	40.3	11.6	40.1	12.6	
	-18.8	-19.0	41.5	8.87	41.3	9.8	41.2	10.8	41.1	11.3	41.0	11.8	40.8	12.8	
	-16.7	-17.0	43.1	9.4	42.9	10.4	42.7	11.3	42.6	11.8	42.5	12.2	42.3	13.2	
	-13.7	-15.0	44.8	10.0	44.6	10.9	44.4	11.8	44.3	12.3	44.2	12.7	44.1	13.6	
	-11.8	-13.0	46.7	10.6	46.6	11.5	46.4	12.3	46.3	12.8	46.2	13.2	46.0	14.1	
	-9.8	-11.0	48.9	11.2	48.7	12.0	48.5	12.9	48.4	13.3	48.3	13.7	48.1	14.5	
	-9.5	-10.0	50.0	11.5	49.8	12.3	49.6	13.1	49.5	13.5	49.4	13.9	49.3	14.7	
	-8.5	-9.1	51.1	11.8	50.9	12.6	50.7	13.3	50.6	13.7	50.5	14.1	50.3	14.9	
	-7.0	-7.6	52.9	12.2	52.7	13.0	52.6	13.7	52.5	14.1	52.4	14.5	52.2	15.2	
	-5.0	-5.6	55.6	12.8	55.4	13.5	55.2	14.2	55.1	14.6	55.0	14.9	54.8	15.7	
	-3.0	-3.7	58.3	13.3	58.1	14.0	57.9	14.7	57.8	15.0	57.7	15.4	57.5	16.0	
	0.0	-0.7	62.9	14.1	62.7	14.7	62.5	15.4	62.4	15.7	62.3	16.0	62.2	16.6	
	3.0	2.2	67.8	14.8	67.6	15.4	67.4	16.0	67.3	16.3	67.2	16.6	67.0	17.2	
	5.0	4.1	71.2	15.3	71.0	15.8	70.8	16.4	70.7	16.6	70.6	16.9	70.5	17.5	
	7.0	6.0	74.8	15.7	74.6	16.2	74.4	16.7	74.3	17.0	74.2	17.3	74.1	17.8	
	9.0	7.9	78.6	16.1	78.4	16.6	78.2	17.1	78.1	17.3	78.0	17.6	75.9	17.4	
11.0	9.8	82.5	16.5	82.3	16.9	82.1	17.4	82.1	17.6	82.0	17.9	75.9	16.4		
13.0	11.8	86.9	16.8	86.7	17.3	86.5	17.7	86.3	17.9	82.8	17.0	75.9	15.4		
15.0	13.7	91.2	17.2	91.0	17.6	89.7	17.7	86.3	16.9	82.8	16.1	75.9	14.5		
120% 73.80 kW	-19.8	-20.0	40.6	9.7	40.4	10.7	40.3	11.6	40.2	12.0	40.1	12.5	39.9	13.4	
	-18.8	-19.0	41.3	10.0	41.1	10.9	41.0	11.8	40.9	12.2	40.8	12.7	40.6	13.6	
	-16.7	-17.0	42.9	10.5	42.7	11.4	42.5	12.2	42.4	12.7	42.3	13.1	42.2	14.0	
	-13.7	-15.0	44.6	11.1	44.4	11.9	44.2	12.7	44.2	13.1	44.1	13.5	43.9	14.4	
	-11.8	-13.0	46.5	11.6	46.4	12.4	46.2	13.2	46.1	13.6	46.0	14.0	45.8	14.8	
	-9.8	-11.0	48.7	12.2	48.5	12.9	48.3	13.7	48.2	14.1	48.1	14.4	48.0	15.2	
	-9.5	-10.0	49.8	12.4	49.6	13.2	49.4	13.9	49.4	14.3	49.3	14.7	49.1	15.4	
	-8.5	-9.1	50.9	12.7	50.7	13.4	50.5	14.1	50.4	14.5	50.3	14.8	50.2	15.6	
	-7.0	-7.6	52.7	13.1	52.5	13.8	52.4	14.5	52.3	14.8	52.2	15.2	52.0	15.9	
	-5.0	-5.6	55.4	13.6	55.2	14.3	55.0	14.9	54.9	15.3	54.8	15.6	54.7	16.3	
	-3.0	-3.7	58.1	14.1	57.9	14.7	57.7	15.4	57.6	15.7	57.5	16.0	57.4	16.6	
	0.0	-0.7	62.7	14.8	62.5	15.4	62.3	16.0	62.3	16.3	62.2	16.6	62.0	17.2	
	3.0	2.2	67.6	15.5	67.4	16.0	67.2	16.6	67.1	16.8	67.0	17.1	66.9	17.6	
	5.0	4.1	71.0	15.9	70.8	16.4	70.6	16.9	70.6	17.2	70.5	17.4	70.1	17.9	
	7.0	6.0	74.6	16.3	74.4	16.8	74.2	17.3	74.2	17.5	74.1	17.7	70.1	16.8	
	9.0	7.9	78.4	16.7	78.2	17.1	78.0	17.6	77.9	17.8	76.4	17.5	70.1	15.8	
11.0	9.8	82.3	17.0	82.1	17.4	82.0	17.9	79.6	17.3	76.4	16.5	70.1	14.9		
13.0	11.8	86.7	17.3	86.5	17.8	82.8	17.0	79.6	16.3	76.4	15.5	70.1	14.0		
15.0	13.7	91.0	17.7	89.2	17.5	82.8	16.1	79.6	15.3	76.4	14.6	70.1	13.2		
110% 67.65 kW	-19.8	-20.0	40.4	10.9	40.2	11.7	40.1	12.6	40.0	13.0	39.9	13.4	39.8	14.3	
	-18.8	-19.0	41.1	11.1	40.9	11.9	40.8	12.8	40.7	13.2	40.6	13.6	40.5	14.4	
	-16.7	-17.0	42.6	11.6	42.5	12.4	42.3	13.2	42.2	13.6	42.2	14.0	42.0	14.8	
	-13.7	-15.0	44.4	12.1	44.2	12.9	44.1	13.6	44.0	14.0	43.9	14.4	43.7	15.1	
	-11.8	-13.0	46.3	12.6	46.2	13.3	46.0	14.1	45.9	14.4	45.8	14.8	45.7	15.5	
	-9.8	-11.0	48.4	13.1	48.3	13.8	48.1	14.5	48.0	14.8	48.0	15.2	47.8	15.9	
	-9.5	-10.0	49.6	13.4	49.4	14.0	49.3	14.7	49.2	15.1	49.1	15.4	48.9	16.1	
	-8.5	-9.1	50.6	13.6	50.5	14.2	50.3	14.9	50.2	15.2	50.2	15.6	50.0	16.2	
	-7.0	-7.6	52.5	14.0	52.3	14.6	52.2	15.2	52.1	15.6	52.0	15.9	51.9	16.5	
	-5.0	-5.6	55.2	14.4	55.0	15.0	54.8	15.7	54.8	16.0	54.7	16.3	54.5	16.9	
	-3.0	-3.7	57.9	14.9	57.7	15.5	57.5	16.0	57.5	16.3	57.4	16.6	57.2	17.2	
	0.0	-0.7	62.5	15.6	62.3	16.1	62.2	16.6	62.1	16.9	62.0	17.2	61.8	17.7	
	3.0	2.2	67.4	16.2	67.2	16.7	67.0	17.2	67.0	17.4	66.9	17.6	64.2	17.1	
	5.0	4.1	70.8	16.5	70.6	17.0	70.5	17.5	70.4	17.7	70.1	17.9	64.2	16.1	
	7.0	6.0	74.4	16.9	74.2	17.3	74.1	17.8	73.0	17.6	70.1	16.8	64.2	15.1	
	9.0	7.9	78.1	17.2	78.0	17.7	75.9	17.4	73.0	16.6	70.1	15.8	64.2	14.3	
11.0	9.8	82.1	17.5	81.7	17.9	75.9	16.4	73.0	15.6	70.1	14.9	64.2	13.5		
13.0	11.8	86.4	17.9	81.7	16.8	75.9	15.4	73.0	14.7	70.1	14.0	64.2	12.7		
15.0	13.7	87.6	17.2	81.7	15.8	75.9	14.5	73.0	13.9	70.1	13.2	64.2	12.0		
100% 61.50 kW	-19.8	-20.0	40.2	12.0	40.0	12.8	39.9	13.6	39.8	13.9	39.7	14.3	39.6	15.1	
	-18.8	-19.0	40.9	12.2	40.7	13.0	40.6	13.7	40.5	14.1	40.4	14.5	40.3	15.2	
	-16.7	-17.0	42.4	12.7	42.3	13.4	42.1	14.1	42.1	14.5	42.0	14.8	41.8	15.6	
	-13.7	-15.0	44.2	13.1	44.0	13.8	43.9	14.5	43.8	14.9	43.7	15.2	43.6	15.9	
	-11.8	-13.0	46.1	13.6	45.9	14.3	45.8	14.9	45.7	15.2	45.7	15.6	45.5	16.2	
	-9.8	-11.0	48.2	14.1	48.1	14.7	47.9	15.3	47.9	15.6	47.8	15.9	47.6	16.6	
	-9.5	-10.0	49.4	14.3	49.2	14.9	49.1	15.5	49.0	15.8	48.9	16.1	48.8	16.7	
	-8.5	-9.1	50.4	14.5	50.3	15.1	50.1	15.7	50.1	16.0	50.0	16.3	49.8	16.9	
	-7.0	-7.6	52.3	14.8	52.1	15.4	52.0	16.0	51.9	16.3	51.8	16.6	51.7	17.1	
	-5.0	-5.6	54.9	15.3	54.8	15.8	54.6	16.4	54.6	16.6	54.5	16.9	54.4	17.5	
	-3.0	-3.7	57.6	15.7	57.5	16.2	57.3	16.7	57.3	17.0	57.2	17.2	57.1	17.8	
	0.0	-0.7	62.3	16.3	62.1	16.8	62.0	17.3	61.9	17.5	61.8	17.7	58.4	16.7	
	3.0	2.2	67.1	16.8	67.0	17.3	66.8	17.7	66.3	17.8	63.7	16.9	58.4	15.3	
	5.0	4.1	70.6	17.2	70.4	17.6	69.0	17.5	66.3	16.7	63.7	15.9	58.4	14.4	
	7.0	6.0	74.2	17.5	74.0	17.9	69.0	16.5	66.3	15.7	63.7	15.0	58.4	13.6	
	9.0	7.9	77.9	17.8	74.3	16.9	69.0	15.5	66.3	14.8	63.7	14.1	58.4	12.8	
11.0	9.8	79.6	17.3	74.3	16.0	69.0	14.6	66.3	14.0	63.7	13.3	58.4	12.1		
13.0	11.8	79.6	16.3	74.3	15.0	69.0	13.8	66.3	13.1	63.7	12.6	58.4	11.4		
15.0	13.7	79.6	15.3	74.3	14.1	69.0	13.0	66.3	12.4	63.7	11.9	58.4	10.8		

NOTES - ANMERKUNGEN - Σημειώσεις - NOTAS - REMARQUES - NOTE - OPMERKINGEN - примечания - NOTLAR

- is shown as reference. When selecting the unit models, avoid the Outdoor air temperature range shown by .
 dient als Verweis. Vermijden Sie bei der Auswahl der Gerätemodelle den als markierten Temperaturbereich der Außenluft.
 Η είναι ενδεικτική, κατά την επιλογή των μοντέλων των μονάδων, αποφύγετε το εύρος θερμοκρασίας εξωτερικού αέρα που υποδεικνύεται .
 se muestra como referencia. Cuando seleccione los modelos de unidad, evite el intervalo de temperaturas del aire exterior indicado mediante .
 est montré comme référence. Lors du choix des modèles d'unités, évitez la plage de températures de l'air extérieur illustré par .
 valori riportati unicamente come riferimento. Nel selezionare i modelli delle unità, non considerare i valori di temperatura dell'aria esterna indicati con il colore .
 is als referentie getoond. Wanneer modellen van eenheden worden gekozen, vermijd dan het bereik van buitenluchttemperaturen geïllustreerd door .

показан как. При выборе модели устройства избегайте внешнюю температуру воздуха, указанную в .
 referans olarak gösterilmektedir. Ünite modellerini seçerken, belirtilen Dış hava sıcaklığı aralığından kaçınınız .
 The above table shows the average value of conditions which may occur.
 Die obige Tabelle zeigt den Durchschnittswert der Bedingungen, die auftreten können.
 Στον παραπάνω πίνακα αναγράφεται η μέση τιμή για συνθήκες που μπορεί να προκύψουν.
 La tabla de arriba muestra el valor medio de condiciones que pueden ocurrir.
 Le tableau ci-dessus donne la valeur moyenne pour des conditions qui peuvent survenir.
 La tabella in alto mostra il valore delle condizioni medie che si possono riscontrare.
 De tabel hierboven geeft de gemiddelde waarde aan van situaties die kunnen voorkomen.
 Таблица расположенная выше показывает среднее значение условий, которые могут наступить.
 Yukarıdaki tablo meydana gelebilecek koşulların ortalama değerini göstermektedir.

3D079549

5 Таблицы производительности

5 - 2 Таблицы теплопроизводительностей

5

RXYQ22T														
Indoor air temp. °CDB														
Combination(%) (Capacity index)	Outdoor air temp.		16.0		18.0		20.0		21.0		22.0		24.0	
			TC	PI	TC	PI	TC	PI	TC	PI	TC	PI	TC	PI
	(°CDB)	(°CWB)	KW	KW	KW	KW	KW	KW	KW	KW	KW	KW	KW	KW
90% 55.35 kW	-19.8	-20.0	40.0	13.2	39.8	13.9	39.7	14.6	39.6	14.9	39.6	15.2	39.4	15.9
	-18.8	-19.0	40.7	13.4	40.5	14.0	40.4	14.7	40.3	15.1	40.3	15.4	40.1	16.1
	-16.7	-17.0	42.2	13.8	42.1	14.4	41.9	15.1	41.9	15.4	41.8	15.7	41.7	16.4
	-13.7	-15.0	43.9	14.2	43.8	14.8	43.7	15.4	43.6	15.7	43.6	16.0	43.4	16.7
	-11.8	-13.0	45.9	14.6	45.7	15.2	45.6	15.8	45.5	16.1	45.5	16.4	45.4	17.0
	-9.8	-11.0	48.0	15.0	47.9	15.6	47.7	16.1	47.7	16.4	47.6	16.7	47.5	17.3
	-9.5	-10.0	49.1	15.2	49.0	15.8	48.9	16.3	48.8	16.6	48.7	16.9	48.6	17.4
	-8.5	-9.1	50.2	15.4	50.1	15.9	49.9	16.5	49.9	16.7	49.8	17.0	49.7	17.6
	-7.0	-7.6	52.1	15.7	51.9	16.2	51.8	16.7	51.7	17.0	51.7	17.3	51.5	17.8
	-5.0	-5.6	54.7	16.1	54.6	16.6	54.5	17.1	54.4	17.3	54.3	17.6	52.5	17.2
	-3.0	-3.7	57.4	16.5	57.3	16.9	57.2	17.4	57.1	17.6	57.0	17.9	52.5	16.2
	0.0	-0.7	62.0	17.0	61.9	17.4	61.8	17.9	59.7	17.2	57.3	16.4	52.5	14.8
	3.0	2.2	66.9	17.5	66.8	17.9	62.1	16.4	59.7	15.7	57.3	14.9	52.5	13.5
	5.0	4.1	70.3	17.8	66.9	16.9	62.1	15.5	59.7	14.8	57.3	14.1	52.5	12.7
	7.0	6.0	71.7	17.2	66.9	15.9	62.1	14.6	59.7	13.9	57.3	13.3	52.5	12.0
	9.0	7.9	71.7	16.2	66.9	15.0	62.1	13.7	59.7	13.1	57.3	12.5	52.5	11.4
	11.0	9.8	71.7	15.3	66.9	14.1	62.1	13.0	59.7	12.4	57.3	11.8	52.5	10.8
13.0	11.8	71.7	14.4	66.9	13.3	62.1	12.2	59.7	11.7	57.3	11.2	52.5	10.2	
15.0	13.7	71.7	13.6	66.9	12.5	62.1	11.5	59.7	11.1	57.3	10.6	52.5	9.6	
80% 49.20 kW	-19.8	-20.0	39.7	14.3	39.6	14.9	39.5	15.5	39.5	15.9	39.4	16.2	39.3	16.8
	-18.8	-19.0	40.4	14.5	40.3	15.1	40.2	15.7	40.2	16.0	40.1	16.3	40.0	16.9
	-16.7	-17.0	42.0	14.8	41.9	15.4	41.8	16.0	41.7	16.3	41.6	16.6	41.5	17.2
	-13.7	-15.0	43.7	15.2	43.6	15.8	43.5	16.3	43.4	16.6	43.4	16.9	43.3	17.4
	-11.8	-13.0	45.7	15.6	45.5	16.1	45.4	16.6	45.4	16.9	45.3	17.2	45.2	17.7
	-9.8	-11.0	47.8	15.9	47.7	16.5	47.6	17.0	47.5	17.2	47.4	17.5	46.7	17.6
	-9.5	-10.0	48.9	16.1	48.8	16.6	48.7	17.1	48.6	17.4	48.6	17.6	46.7	17.1
	-8.5	-9.1	50.0	16.3	49.9	16.8	49.8	17.3	49.7	17.5	49.6	17.7	46.7	16.6
	-7.0	-7.6	51.8	16.6	51.7	17.0	51.6	17.5	51.6	17.7	51.0	17.7	46.7	15.9
	-5.0	-5.6	54.5	16.9	54.4	17.4	54.3	17.8	53.1	17.4	51.0	16.6	46.7	15.0
	-3.0	-3.7	57.2	17.2	57.1	17.7	55.2	17.2	53.1	16.4	51.0	15.6	46.7	14.1
	0.0	-0.7	61.8	17.7	59.4	17.1	55.2	15.7	53.1	14.9	51.0	14.3	46.7	12.9
	3.0	2.2	63.7	16.9	59.4	15.6	55.2	14.3	53.1	13.7	51.0	13.0	46.7	11.8
	5.0	4.1	63.7	15.9	59.4	14.7	55.2	13.5	53.1	12.9	51.0	12.3	46.7	11.2
	7.0	6.0	63.7	15.0	59.4	13.8	55.2	12.7	53.1	12.2	51.0	11.6	46.7	10.6
	9.0	7.9	63.7	14.1	59.4	13.1	55.2	12.0	53.1	11.5	51.0	11.0	46.7	10.0
	11.0	9.8	63.7	13.3	59.4	12.3	55.2	11.4	53.1	10.9	51.0	10.4	46.7	9.5
13.0	11.8	63.7	12.6	59.4	11.6	55.2	10.7	53.1	10.3	51.0	9.8	46.7	9.0	
15.0	13.7	63.7	11.9	59.4	11.0	55.2	10.2	53.1	9.7	51.0	9.3	46.7	8.53	
70% 43.05 kW	-19.8	-20.0	39.5	15.5	39.4	16.0	39.3	16.5	39.3	16.8	39.2	17.1	39.1	17.6
	-18.8	-19.0	40.2	15.6	40.1	16.1	40.0	16.7	40.0	16.9	39.9	17.2	39.8	17.7
	-16.7	-17.0	41.8	15.9	41.7	16.4	41.6	16.9	41.5	17.2	41.5	17.4	40.9	17.6
	-13.7	-15.0	43.5	16.2	43.4	16.7	43.3	17.2	43.3	17.5	43.2	17.7	40.9	16.7
	-11.8	-13.0	45.4	16.6	45.3	17.0	45.2	17.5	45.2	17.7	44.6	17.6	40.9	15.9
	-9.8	-11.0	47.6	16.9	47.5	17.3	47.4	17.8	46.4	17.5	44.6	16.6	40.9	15.0
	-9.5	-10.0	48.7	17.1	48.6	17.5	48.3	17.8	46.4	17.0	44.6	16.2	40.9	14.6
	-8.5	-9.1	49.8	17.2	49.7	17.6	48.3	17.3	46.4	16.5	44.6	15.7	40.9	14.2
	-7.0	-7.6	51.6	17.4	51.5	17.8	48.3	16.6	46.4	15.8	44.6	15.1	40.9	13.6
	-5.0	-5.6	54.3	17.7	52.0	17.0	48.3	15.6	46.4	14.9	44.6	14.2	40.9	12.8
	-3.0	-3.7	55.7	17.4	52.0	16.0	48.3	14.7	46.4	14.0	44.6	13.4	40.9	12.1
	0.0	-0.7	55.7	15.8	52.0	14.6	48.3	13.4	46.4	12.8	44.6	12.2	40.9	11.1
	3.0	2.2	55.7	14.5	52.0	13.3	48.3	12.3	46.4	11.7	44.6	11.2	40.9	10.2
	5.0	4.1	55.7	13.6	52.0	12.6	48.3	11.6	46.4	11.1	44.6	10.6	40.9	9.7
	7.0	6.0	55.7	12.9	52.0	11.9	48.3	11.0	46.4	10.5	44.6	10.1	40.9	9.17
	9.0	7.9	55.7	12.1	52.0	11.2	48.3	10.4	46.4	9.9	44.6	9.5	40.9	8.70
	11.0	9.8	55.7	11.5	52.0	10.6	48.3	9.8	46.4	9.4	44.6	9.04	40.9	8.27
13.0	11.8	55.7	10.8	52.0	10.1	48.3	9.3	46.4	8.93	44.6	8.56	40.9	7.84	
15.0	13.7	55.7	10.3	52.0	9.5	48.3	8.83	46.4	8.48	44.6	8.14	40.9	7.46	
60% 36.90 kW	-19.8	-20.0	39.3	16.6	39.2	17.1	39.1	17.5	39.1	17.8	38.2	17.4	35.0	15.7
	-18.8	-19.0	40.0	16.7	39.9	17.2	39.8	17.6	39.8	17.9	38.2	17.0	35.0	15.3
	-16.7	-17.0	41.6	17.0	41.5	17.4	41.4	17.9	39.8	17.1	38.2	16.2	35.0	14.7
	-13.7	-15.0	43.3	17.3	43.2	17.7	41.4	17.0	39.8	16.2	38.2	15.5	35.0	14.0
	-11.8	-13.0	45.2	17.6	44.6	17.6	41.4	16.1	39.8	15.4	38.2	14.7	35.0	13.3
	-9.8	-11.0	47.3	17.8	44.6	16.6	41.4	15.2	39.8	14.6	38.2	13.9	35.0	12.6
	-9.5	-10.0	47.8	17.6	44.6	16.2	41.4	14.8	39.8	14.2	38.2	13.5	35.0	12.2
	-8.5	-9.1	47.8	17.1	44.6	15.7	41.4	14.4	39.8	13.8	38.2	13.2	35.0	11.9
	-7.0	-7.6	47.8	16.3	44.6	15.1	41.4	13.8	39.8	13.2	38.2	12.6	35.0	11.4
	-5.0	-5.6	47.8	15.4	44.6	14.2	41.4	13.0	39.8	12.5	38.2	11.9	35.0	10.8
	-3.0	-3.7	47.8	14.5	44.6	13.4	41.4	12.3	39.8	11.8	38.2	11.3	35.0	10.3
	0.0	-0.7	47.8	13.2	44.6	12.2	41.4	11.3	39.8	10.8	38.2	10.3	35.0	9.43
	3.0	2.2	47.8	12.1	44.6	11.2	41.4	10.4	39.8	9.94	38.2	9.52	35.0	8.69
	5.0	4.1	47.8	11.5	44.6	10.6	41.4	9.81	39.8	9.41	38.2	9.02	35.0	8.25
	7.0	6.0	47.8	10.8	44.6	10.1	41.4	9.30	39.8	8.93	38.2	8.56	35.0	7.84
	9.0	7.9	47.8	10.3	44.6	9.53	41.4	8.82	39.8	8.47	38.2	8.13	35.0	7.45
	11.0	9.8	47.8	9.7	44.6	9.04	41.4	8.38	39.8	8.05	38.2	7.73	35.0	7.10
13.0	11.8	47.8	9.19	44.6	8.56	41.4	7.94	39.8	7.64	38.2	7.34	35.0	6.74	
15.0	13.7	47.8	8.73	44.6	8.14	41.4	7.56	39.8	7.27	38.2	6.99	35.0	6.44	
50% 30.75 kW	-19.8	-20.0	39.1	17.8	37.2	16.8	34.5	15.4	33.2	14.7	31.8	14.0	29.2	12.7
	-18.8	-19.0	39.8	17.9	37.2	16.5	34.5	15.1	33.2	14.4	31.8	13.7	29.2	12.4
	-16.7	-17.0	39.8	17.1	37.2	15.7	34.5	14.4	33.2	13.8	31.8	13.1	29.2	11.9
	-13.7	-15.0	39.8	16.2	37.2	15.0	34.5	13.7	33.2	13.1	31.8	12.5	29.2	11.4
	-11.8	-13.0	39.8	15.4	37.2	14.2	34.5	13.0	33.2	12.5	31.8	11.9	29.2	10.8
	-9.8	-11.0	39.8	14.6	37.2	13.4	34.5	12.4	33.2	11.8	31.8	11.3	29.2	10.29
	-9.5	-10.0	39.8	14.2	37.2	13.1	34.5	12.0	33.2	11.5	31.8	11.0	29.2	10.03
	-8.5	-9.1	39.8	13.8	37.2	12.8	34.5	11.7	33.2	11.2	31.8	10.7	29.2	9.79
	-7.0	-7.6	39.8	13.2	37.2	12.2	34.5	11.3	33.2	10.8	31.8	10.32	29.2	9.41
	-5.0	-5.6	39.8	12.5	37.2	11.5	34.5	10.6	33.2	10.20	31.8	9.77	29.2	8.92
	-3.0	-3.7	39.8	11.8	37.2	10.9	34.5	10.09	33.2	9.68	31.8	9.27	29.2	8.48
	0.0	-0.7	39.8	10.8	37.2	10.03	34.5	9.28						

5 Таблицы производительности

5 - 2 Таблицы теплопроизводительностей

RXYQ24T		Indoor air temp. °CDB												
Combination(%) (Capacity index)	Outdoor air temp.		16.0		18.0		20.0		21.0		22.0		24.0	
	(°CDB)	(°CWB)	TC	PI	TC	PI	TC	PI	TC	PI	TC	PI	TC	PI
			KW	KW	KW	KW	KW	KW	KW	KW	KW	KW	KW	KW
130% 87.62 kW	-19.8	-20.0	44.6	9.48	44.4	10.6	44.2	11.6	44.1	12.2	44.0	12.7	43.8	13.8
	-18.8	-19.0	45.6	9.9	45.4	10.9	45.2	12.0	45.1	12.5	45.0	13.0	44.8	14.1
	-16.7	-17.0	47.6	10.6	47.4	11.6	47.2	12.6	47.1	13.1	47.0	13.6	46.8	14.6
	-13.7	-15.0	49.8	11.3	49.6	12.3	49.4	13.2	49.3	13.7	49.2	14.2	49.0	15.2
	-11.8	-13.0	52.1	12.0	51.9	12.9	51.7	13.8	51.6	14.3	51.5	14.7	51.3	15.7
	-9.8	-11.0	54.5	12.6	54.3	13.5	54.1	14.4	54.0	14.8	53.9	15.3	53.7	16.1
	-9.5	-10.0	55.8	12.9	55.6	13.8	55.4	14.7	55.3	15.1	55.2	15.5	55.0	16.4
	-8.5	-9.1	57.0	13.2	56.7	14.1	56.5	14.9	56.4	15.3	56.3	15.7	56.1	16.6
	-7.0	-7.6	59.0	13.7	58.7	14.5	58.5	15.3	58.4	15.7	58.3	16.1	58.1	16.9
	-5.0	-5.6	61.7	14.3	61.5	15.0	61.3	15.8	61.2	16.2	61.1	16.6	60.9	17.3
	-3.0	-3.7	64.5	14.8	64.3	15.5	64.1	16.2	64.0	16.6	63.9	17.0	63.7	17.7
	0.0	-0.7	69.1	15.6	68.9	16.2	68.7	16.9	68.6	17.3	68.5	17.6	68.3	18.3
	3.0	2.2	73.8	16.2	73.6	16.9	73.4	17.5	73.3	17.8	73.2	18.2	73.0	18.8
	5.0	4.1	77.0	16.7	76.8	17.3	76.6	17.9	76.5	18.2	76.4	18.5	76.2	19.1
	7.0	6.0	80.4	17.1	80.2	17.7	80.0	18.2	79.9	18.5	79.8	18.8	79.6	19.4
	9.0	7.9	83.9	17.4	83.7	18.0	83.5	18.6	83.4	18.8	83.3	19.1	83.1	19.5
11.0	9.8	87.5	17.8	87.3	18.3	87.1	18.9	87.0	19.1	86.8	19.4	86.6	19.5	
13.0	11.8	91.4	18.2	91.2	18.7	91.0	19.2	90.9	19.4	90.0	19.4	90.0	19.4	
15.0	13.7	95.2	18.5	95.0	19.0	94.8	19.5	94.8	19.5	93.8	19.4	90.0	18.5	82.5
120% 80.88 kW	-19.8	-20.0	44.4	10.7	44.2	11.7	44.0	12.7	43.9	13.2	43.8	13.7	43.6	14.7
	-18.8	-19.0	45.3	11.1	45.2	12.1	45.0	13.0	44.9	13.5	44.8	14.0	44.6	15.0
	-16.7	-17.0	47.4	11.7	47.2	12.7	47.0	13.6	46.9	14.1	46.8	14.6	46.6	15.5
	-13.7	-15.0	49.6	12.4	49.4	13.3	49.2	14.2	49.1	14.6	49.0	15.1	48.8	16.0
	-11.8	-13.0	51.9	13.0	51.7	13.9	51.5	14.7	51.4	15.2	51.3	15.6	51.1	16.4
	-9.8	-11.0	54.3	13.6	54.1	14.4	53.9	15.3	53.8	15.7	53.7	16.1	53.5	16.9
	-9.5	-10.0	55.6	13.9	55.4	14.7	55.2	15.5	55.1	15.9	55.0	16.3	54.8	17.1
	-8.5	-9.1	56.7	14.2	56.5	15.0	56.3	15.7	56.2	16.1	56.1	16.5	56.0	17.3
	-7.0	-7.6	58.7	14.6	58.5	15.4	58.3	16.1	58.2	16.5	58.1	16.8	58.0	17.6
	-5.0	-5.6	61.5	15.1	61.3	15.9	61.1	16.6	61.0	16.9	60.9	17.3	60.7	18.0
	-3.0	-3.7	64.3	15.6	64.1	16.3	63.9	17.0	63.8	17.3	63.7	17.7	63.5	18.3
	0.0	-0.7	68.9	16.3	68.7	17.0	68.5	17.6	68.4	17.9	68.3	18.2	68.1	18.9
	3.0	2.2	73.6	17.0	73.4	17.6	73.2	18.2	73.1	18.5	73.0	18.7	72.8	19.3
	5.0	4.1	76.8	17.4	76.6	17.9	76.4	18.5	76.3	18.8	76.2	19.1	76.1	19.6
	7.0	6.0	80.2	17.7	80.0	18.3	79.8	18.8	79.7	19.1	79.6	19.4	79.4	19.6
	9.0	7.9	83.6	18.1	83.4	18.6	83.3	19.1	83.2	19.4	83.1	19.6	83.0	19.6
11.0	9.8	87.2	18.4	87.0	18.9	86.8	19.4	86.5	19.6	86.4	19.6	86.3	19.6	
13.0	11.8	91.1	18.8	90.9	19.2	90.0	19.4	86.5	18.6	83.1	17.7	76.2	16.0	
15.0	13.7	95.0	19.1	94.8	19.5	90.0	18.5	86.5	17.6	83.1	16.8	76.2	15.2	
110% 74.14 kW	-19.8	-20.0	44.1	12.0	44.0	12.9	43.8	13.8	43.7	14.3	43.6	14.7	43.4	15.7
	-18.8	-19.0	45.1	12.3	44.9	13.2	44.8	14.1	44.7	14.5	44.6	15.0	44.4	15.9
	-16.7	-17.0	47.1	12.9	47.0	13.8	46.8	14.6	46.7	15.1	46.6	15.5	46.5	16.3
	-13.7	-15.0	49.3	13.5	49.1	14.3	49.0	15.2	48.9	15.6	48.8	16.0	48.6	16.8
	-11.8	-13.0	51.6	14.1	51.4	14.9	51.3	15.7	51.2	16.0	51.1	16.4	50.9	17.2
	-9.8	-11.0	54.1	14.7	53.9	15.4	53.7	16.1	53.6	16.5	53.5	16.9	53.4	17.6
	-9.5	-10.0	55.3	14.9	55.1	15.6	55.0	16.4	54.9	16.7	54.8	17.1	54.6	17.8
	-8.5	-9.1	56.5	15.2	56.3	15.9	56.1	16.6	56.0	16.9	56.0	17.3	55.8	18.0
	-7.0	-7.6	58.5	15.5	58.3	16.2	58.1	16.9	58.0	17.2	58.0	17.6	57.8	18.3
	-5.0	-5.6	61.3	16.0	61.1	16.7	60.9	17.3	60.8	17.7	60.7	18.0	60.6	18.6
	-3.0	-3.7	64.0	16.5	63.8	17.1	63.7	17.7	63.6	18.0	63.5	18.3	63.3	19.0
	0.0	-0.7	68.6	17.1	68.4	17.7	68.3	18.3	68.2	18.6	68.1	18.9	67.9	19.4
	3.0	2.2	73.3	17.7	73.2	18.3	73.0	18.8	72.9	19.1	72.8	19.3	72.7	19.4
	5.0	4.1	76.6	18.1	76.4	18.6	76.2	19.1	76.1	19.4	76.1	19.6	76.0	19.6
	7.0	6.0	79.9	18.4	79.8	18.9	79.6	19.4	79.3	19.6	79.2	19.6	79.1	19.6
	9.0	7.9	83.4	18.7	83.2	19.2	82.5	19.5	79.3	18.6	76.2	17.7	69.8	16.0
11.0	9.8	87.0	19.0	86.8	19.5	82.5	18.5	79.3	17.6	76.2	16.8	69.8	15.2	
13.0	11.8	90.9	19.4	88.8	19.1	82.5	17.5	79.3	16.7	76.2	16.0	69.8	14.4	
15.0	13.7	94.7	19.6	88.8	18.2	82.5	16.7	79.3	15.9	76.2	15.2	69.8	13.8	
100% 67.40 kW	-19.8	-20.0	43.9	13.2	43.7	14.1	43.6	14.9	43.5	15.3	43.4	15.7	43.3	16.6
	-18.8	-19.0	44.9	13.5	44.7	14.3	44.6	15.2	44.5	15.6	44.4	16.0	44.2	16.8
	-16.7	-17.0	46.9	14.1	46.8	14.9	46.6	15.6	46.5	16.0	46.4	16.4	46.3	17.2
	-13.7	-15.0	49.1	14.6	48.9	15.4	48.8	16.1	48.7	16.5	48.6	16.9	48.5	17.6
	-11.8	-13.0	51.4	15.2	51.2	15.9	51.1	16.6	51.0	16.9	50.9	17.3	50.8	18.0
	-9.8	-11.0	53.8	15.7	53.7	16.3	53.5	17.0	53.4	17.4	53.3	17.7	53.2	18.4
	-9.5	-10.0	55.1	15.9	54.9	16.6	54.8	17.2	54.7	17.6	54.6	17.9	54.4	18.5
	-8.5	-9.1	56.2	16.1	56.1	16.8	55.9	17.4	55.8	17.7	55.8	18.1	55.6	18.7
	-7.0	-7.6	58.2	16.5	58.1	17.1	57.9	17.7	57.8	18.0	57.8	18.3	57.6	19.0
	-5.0	-5.6	61.0	16.9	60.9	17.5	60.7	18.1	60.6	18.4	60.5	18.7	60.4	19.3
	-3.0	-3.7	63.8	17.3	63.6	17.9	63.5	18.5	63.4	18.7	63.3	19.0	63.2	19.6
	0.0	-0.7	68.4	17.9	68.2	18.4	68.1	19.0	68.0	19.2	67.9	19.5	67.8	19.6
	3.0	2.2	73.1	18.5	72.9	18.9	72.8	19.4	72.1	19.4	69.2	18.5	63.5	16.7
	5.0	4.1	76.3	18.8	76.2	19.2	75.0	19.3	72.1	18.4	69.2	17.5	63.5	15.8
	7.0	6.0	79.7	19.1	79.5	19.5	75.0	18.3	72.1	17.5	69.2	16.7	63.5	15.1
	9.0	7.9	83.2	19.4	80.8	19.0	75.0	17.4	72.1	16.6	69.2	15.8	63.5	14.3
11.0	9.8	86.5	19.6	80.8	18.0	75.0	16.5	72.1	15.8	69.2	15.1	63.5	13.6	
13.0	11.8	86.5	18.6	80.8	17.1	75.0	15.7	72.1	15.0	69.2	14.3	63.5	13.0	
15.0	13.7	86.5	17.6	80.8	16.3	75.0	14.9	72.1	14.3	69.2	13.6	63.5	12.4	

NOTES - ANMERKUNGEN - Σημειώσεις - NOTAS - REMARQUES - NOTE - OPMERKINGEN - примечания - NOTLAR

- █ is shown as reference. When selecting the unit models, avoid the Outdoor air temperature range shown by █.

█ dient als Verweis. Vermeiden Sie bei der Auswahl der Gerätemodelle den als markierten Temperaturbereich der Außenluft.

Н █ είναι ενδεικτική, κατά την επιλογή των μοντέλων των μονάδων, αποφεύγετε το εύρος θερμοκρασίας εξωτερικού αέρα που υποδεικνύεται █.

█ se muestra como referencia. Cuando seleccione los modelos de unidad, evite el intervalo de temperaturas del aire exterior indicado mediante █.

█ est montré comme référence. Lors du choix des modèles d'unités, évitez la plage de températures de l'air extérieur illustré par █.

█ valori riportati unicamente come riferimento. Nel selezionare i modelli delle unità, non considerare i valori di temperatura dell'aria esterna indicati con il colore █.

█ is als referentie getoond. Wanneer modellen van eenheden worden gekozen, vermijd dan het bereik van buitenluchttemperaturen geïllustreerd door █.

█ показан как. При выборе модели устройства избегайте внешнюю температуру воздуха, указанную в █.

█ referans olarak gösterilmektedir. Ünite modellerini seçerken, belirtilen Dış hava sıcaklığı aralığından kaçınınız █.
- The above table shows the average value of conditions which may occur.

Die obige Tabelle zeigt den Durchschnittswert der Bedingungen, die auftreten können.

Στον παραπάνω πίνακα αναγράφεται η μέση τιμή για συνθήκες που μπορεί να προκύψουν.

La tabla de arriba muestra el valor medio de condiciones que pueden ocurrir.

Le tableau ci-dessus donne la valeur moyenne pour des conditions qui peuvent survenir.

La tabella in alto mostra il valore delle condizioni medie che si possono riscontrare.

De tabel hierboven geeft de gemiddelde waarde aan van situaties die kunnen voorvallen.

Таблица расположенная

5 Таблицы производительности

5 - 2 Таблицы теплопроизводительностей

5

RXYQ24T														
Indoor air temp. °CDB														
Combination(%) (Capacity index)	Outdoor air temp.		16.0		18.0		20.0		21.0		22.0		24.0	
			TC	PI	TC	PI	TC	PI	TC	PI	TC	PI	TC	PI
	(°CDB)	(°CWB)	KW	KW	KW	KW	KW	KW	KW	KW	KW	KW	KW	KW
90% 60.66 kW	-19.8	-20.0	43.7	14.5	43.5	15.2	43.4	16.0	43.3	16.4	43.2	16.7	43.1	17.5
	-18.8	-19.0	44.6	14.7	44.5	15.5	44.3	16.2	44.3	16.6	44.2	16.9	44.1	17.7
	-16.7	-17.0	46.7	15.3	46.5	16.0	46.4	16.7	46.3	17.0	46.2	17.4	46.1	18.1
	-13.7	-15.0	48.8	15.7	48.7	16.4	48.6	17.1	48.5	17.4	48.4	17.8	48.3	18.4
	-11.8	-13.0	51.1	16.2	51.0	16.9	50.9	17.5	50.8	17.8	50.7	18.1	50.6	18.8
	-9.8	-11.0	53.6	16.7	53.4	17.3	53.3	17.9	53.2	18.2	53.2	18.5	53.0	19.1
	-9.5	-10.0	54.8	16.9	54.7	17.5	54.6	18.1	54.5	18.4	54.4	18.7	54.3	19.3
	-8.5	-9.1	56.0	17.1	55.9	17.7	55.7	18.3	55.7	18.5	55.6	18.8	55.4	19.4
	-7.0	-7.6	58.0	17.4	57.9	18.0	57.7	18.5	57.7	18.8	57.6	19.1	57.1	19.5
	-5.0	-5.6	60.8	17.8	60.6	18.3	60.5	18.9	60.4	19.1	60.4	19.4	57.1	18.4
	-3.0	-3.7	63.5	18.2	63.4	18.7	63.3	19.2	63.2	19.4	62.3	19.3	57.1	17.4
	0.0	-0.7	68.1	18.7	68.0	19.2	67.5	19.5	64.9	18.6	62.3	17.7	57.1	16.0
	3.0	2.2	72.9	19.2	72.7	19.6	67.5	18.0	64.9	17.1	62.3	16.3	57.1	14.8
	5.0	4.1	76.1	19.5	72.7	18.6	67.5	17.0	64.9	16.3	62.3	15.5	57.1	14.0
	7.0	6.0	77.9	19.2	72.7	17.6	67.5	16.2	64.9	15.5	62.3	14.7	57.1	13.4
	9.0	7.9	77.9	18.2	72.7	16.8	67.5	15.4	64.9	14.7	62.3	14.0	57.1	12.7
11.0	9.8	77.9	17.3	72.7	15.9	67.5	14.6	64.9	14.0	62.3	13.4	57.1	12.1	
13.0	11.8	77.9	16.4	72.7	15.1	67.5	13.9	64.9	13.3	62.3	12.7	57.1	11.6	
15.0	13.7	77.9	15.6	72.7	14.4	67.5	13.3	64.9	12.7	62.3	12.1	57.1	11.1	
80% 53.92 kW	-19.8	-20.0	43.4	15.7	43.3	16.4	43.2	17.1	43.1	17.4	43.0	17.7	42.9	18.4
	-18.8	-19.0	44.4	16.0	44.3	16.6	44.1	17.3	44.1	17.6	44.0	17.9	43.9	18.6
	-16.7	-17.0	46.4	16.4	46.3	17.0	46.2	17.7	46.1	18.0	46.1	18.3	45.9	18.9
	-13.7	-15.0	48.6	16.9	48.5	17.5	48.4	18.0	48.3	18.3	48.2	18.6	48.1	19.2
	-11.8	-13.0	50.9	17.3	50.8	17.8	50.7	18.4	50.6	18.7	50.5	19.0	50.4	19.5
	-9.8	-11.0	53.3	17.7	53.2	18.2	53.1	18.8	53.0	19.0	53.0	19.3	50.8	18.7
	-9.5	-10.0	54.6	17.9	54.5	18.4	54.4	18.9	54.3	19.2	54.2	19.5	50.8	18.1
	-8.5	-9.1	55.8	18.1	55.6	18.6	55.5	19.1	55.5	19.3	55.4	19.6	50.8	17.7
	-7.0	-7.6	57.8	18.3	57.6	18.8	57.5	19.3	57.5	19.6	55.4	18.8	50.8	16.9
	-5.0	-5.6	60.5	18.7	60.4	19.2	60.0	19.5	57.7	18.6	55.4	17.7	50.8	16.0
	-3.0	-3.7	63.3	19.0	63.2	19.5	60.0	18.4	57.7	17.6	55.4	16.8	50.8	15.2
	0.0	-0.7	67.9	19.5	64.6	18.5	60.0	16.9	57.7	16.2	55.4	15.4	50.8	14.0
	3.0	2.2	69.2	18.5	64.6	17.0	60.0	15.6	57.7	14.9	55.4	14.3	50.8	12.9
	5.0	4.1	69.2	17.5	64.6	16.2	60.0	14.9	57.7	14.2	55.4	13.6	50.8	12.3
	7.0	6.0	69.2	16.7	64.6	15.4	60.0	14.1	57.7	13.5	55.4	12.9	50.8	11.7
	9.0	7.9	69.2	15.8	64.6	14.6	60.0	13.4	57.7	12.9	55.4	12.3	50.8	11.2
11.0	9.8	69.2	15.1	64.6	13.9	60.0	12.8	57.7	12.3	55.4	11.7	50.8	10.7	
13.0	11.8	69.2	14.3	64.6	13.2	60.0	12.2	57.7	11.7	55.4	11.2	50.8	10.2	
15.0	13.7	69.2	13.6	64.6	12.6	60.0	11.7	57.7	11.2	55.4	10.7	50.8	9.8	
70% 47.18 kW	-19.8	-20.0	43.2	17.0	43.1	17.6	43.0	18.2	42.9	18.5	42.9	18.7	42.7	19.3
	-18.8	-19.0	44.2	17.2	44.0	17.8	43.9	18.3	43.9	18.6	43.8	18.9	43.7	19.5
	-16.7	-17.0	46.2	17.6	46.1	18.1	46.0	18.7	45.9	19.0	45.9	19.2	44.4	18.9
	-13.7	-15.0	48.4	18.0	48.3	18.5	48.2	19.0	48.1	19.3	48.0	19.5	44.4	17.8
	-11.8	-13.0	50.7	18.3	50.6	18.8	50.5	19.3	50.4	19.6	48.5	18.7	44.4	16.9
	-9.8	-11.0	53.1	18.7	53.0	19.2	52.5	19.4	50.5	18.5	48.5	17.6	44.4	15.9
	-9.5	-10.0	54.4	18.9	54.3	19.3	52.5	18.9	50.5	18.0	48.5	17.1	44.4	15.5
	-8.5	-9.1	55.5	19.0	55.4	19.5	52.5	18.4	50.5	17.5	48.5	16.7	44.4	15.1
	-7.0	-7.6	57.5	19.3	56.5	19.2	52.5	17.6	50.5	16.8	48.5	16.0	44.4	14.5
	-5.0	-5.6	60.3	19.6	56.5	18.1	52.5	16.6	50.5	15.9	48.5	15.2	44.4	13.7
	-3.0	-3.7	60.6	18.7	56.5	17.2	52.5	15.8	50.5	15.1	48.5	14.4	44.4	13.0
	0.0	-0.7	60.6	17.1	56.5	15.8	52.5	14.5	50.5	13.9	48.5	13.3	44.4	12.1
	3.0	2.2	60.6	15.8	56.5	14.6	52.5	13.4	50.5	12.9	48.5	12.3	44.4	11.2
	5.0	4.1	60.6	15.0	56.5	13.9	52.5	12.8	50.5	12.2	48.5	11.7	44.4	10.7
	7.0	6.0	60.6	14.3	56.5	13.2	52.5	12.2	50.5	11.7	48.5	11.2	44.4	10.2
	9.0	7.9	60.6	13.6	56.5	12.6	52.5	11.6	50.5	11.1	48.5	10.7	44.4	9.7
11.0	9.8	60.6	13.0	56.5	12.0	52.5	11.1	50.5	10.6	48.5	10.2	44.4	9.3	
13.0	11.8	60.6	12.3	56.5	11.4	52.5	10.6	50.5	10.1	48.5	9.7	44.4	8.9	
15.0	13.7	60.6	11.8	56.5	10.9	52.5	10.1	50.5	9.7	48.5	9.3	44.4	8.54	
60% 40.44 kW	-19.8	-20.0	42.9	18.2	42.9	18.7	42.8	19.2	42.7	19.5	41.5	18.9	38.1	17.1
	-18.8	-19.0	43.9	18.4	43.8	18.9	43.7	19.4	43.3	19.3	41.5	18.4	38.1	16.6
	-16.7	-17.0	46.0	18.8	45.9	19.2	45.0	19.2	43.3	18.3	41.5	17.4	38.1	15.7
	-13.7	-15.0	48.1	19.1	48.0	19.5	45.0	18.1	43.3	17.3	41.5	16.5	38.1	14.9
	-11.8	-13.0	50.4	19.4	48.5	18.7	45.0	17.1	43.3	16.3	41.5	15.6	38.1	14.1
	-9.8	-11.0	51.9	19.2	48.5	17.6	45.0	16.2	43.3	15.5	41.5	14.7	38.1	13.4
	-9.5	-10.0	51.9	18.6	48.5	17.1	45.0	15.7	43.3	15.0	41.5	14.3	38.1	13.0
	-8.5	-9.1	51.9	18.1	48.5	16.7	45.0	15.3	43.3	14.7	41.5	14.0	38.1	12.7
	-7.0	-7.6	51.9	17.4	48.5	16.0	45.0	14.7	43.3	14.1	41.5	13.4	38.1	12.2
	-5.0	-5.6	51.9	16.4	48.5	15.2	45.0	13.9	43.3	13.3	41.5	12.7	38.1	11.6
	-3.0	-3.7	51.9	15.6	48.5	14.4	45.0	13.2	43.3	12.7	41.5	12.1	38.1	11.0
	0.0	-0.7	51.9	14.3	48.5	13.3	45.0	12.2	43.3	11.7	41.5	11.2	38.1	10.2
	3.0	2.2	51.9	13.3	48.5	12.3	45.0	11.3	43.3	10.9	41.5	10.4	38.1	9.5
	5.0	4.1	51.9	12.6	48.5	11.7	45.0	10.8	43.3	10.4	41.5	10.0	38.1	9.1
	7.0	6.0	51.9	12.0	48.5	11.2	45.0	10.3	43.3	9.9	41.5	9.5	38.1	8.71
	9.0	7.9	51.9	11.5	48.5	10.7	45.0	9.9	43.3	9.5	41.5	9.1	38.1	8.34
11.0	9.8	51.9	11.0	48.5	10.2	45.0	9.4	43.3	9.08	41.5	8.71	38.1	8.00	
13.0	11.8	51.9	10.5	48.5	9.7	45.0	9.02	43.3	8.68	41.5	8.33	38.1	7.66	
15.0	13.7	51.9	10.0	48.5	9.3	45.0	8.65	43.3	8.32	41.5	7.99	38.1	7.35	
50% 33.70 kW	-19.8	-20.0	42.7	19.5	40.4	18.3	37.5	16.77	36.1	16.0	34.6	15.3	31.7	13.8
	-18.8	-19.0	43.3	19.3	40.4	17.8	37.5	16.3	36.1	15.6	34.6	14.9	31.7	13.5
	-16.7	-17.0	43.3	18.3	40.4	16.9	37.5	15.5	36.1	14.8	34.6	14.1	31.7	12.8
	-13.7	-15.0	43.3	17.3	40.4	15.9	37.5	14.6	36.1	14.0	34.6	13.4	31.7	12.2
	-11.8	-13.0	43.3	16.3	40.4	15.1	37.5	13.9	36.1	13.3	34.6	12.7	31.7	11.5
	-9.8	-11.0	43.3	15.5	40.4	14.3	37.5	13.1	36.1	12.6	34.6	12.0	31.7	11.0
	-9.5	-10.0	43.3	15.0	40.4	13.9	37.5	12.8	36.1	12.3	34.6	11.7	31.7	10.7
	-8.5	-9.1	43.3	14.7	40.4	13.6	37.5	12.5	36.1	12.0	34.6	11.5	31.7	10.4
	-7.0	-7.6	43.3	14.1	40.4	13.0	37.5	12.0	36.1	11.5	34.6	11.0	31.7	10.1
	-5.0	-5.6	43.3	13.3	40.4	12.4	37.5	11.4	36.1	10.9	34.6	10.5	31.7	9.6
	-3.0	-3.7	43.3	12.7	40.4	11.8	37.5	10.9	36.1	10.4	34.6	10.0	31.7	9.13
	0.0	-0.7	43.3	11.7	40.4	10.9	37.5	10.1	36.1	9.7	34.6	9.27	31.7	8.50

5 Таблицы производительности

5 - 2 Таблицы теплопроизводительностей

RXYQ26T		Indoor air temp. °CDB												TC: Total capacity (kW); PI: Power Input (kW) (Comp. + Outdoor fan motor)	
Combination(%) (Capacity index)	Outdoor air temp.		16.0		18.0		20.0		21.0		22.0		24.0		
	(°CDB)	(°CWB)	TC	PI	TC	PI	TC	PI	TC	PI	TC	PI	TC	PI	
			KW	KW	KW	KW	KW	KW	KW	KW	KW	KW	KW	KW	KW
130% 95.55 kW	-19.8	-20.0	48.5	10.13	48.3	11.3	48.1	12.5	48.0	13.1	47.9	13.7	47.6	14.9	
	-18.8	-19.0	49.6	10.5	49.4	11.7	49.1	12.9	49.0	13.5	48.9	14.1	48.7	15.2	
	-16.7	-17.0	51.8	11.3	51.5	12.5	51.3	13.6	51.2	14.2	51.1	14.7	50.9	15.8	
	-13.7	-15.0	54.1	12.1	53.9	13.2	53.7	14.3	53.6	14.8	53.4	15.3	53.2	16.4	
	-11.8	-13.0	56.6	12.9	56.4	13.9	56.2	14.9	56.0	15.4	55.9	15.9	55.7	17.0	
	-9.8	-11.0	59.2	13.6	59.0	14.6	58.8	15.6	58.7	16.0	58.6	16.5	58.3	17.5	
	-9.5	-10.0	60.6	14.0	60.4	14.9	60.2	15.9	60.0	16.3	59.9	16.8	59.7	17.8	
	-8.5	-9.1	61.9	14.3	61.6	15.2	61.4	16.1	61.3	16.6	61.2	17.1	61.0	18.0	
	-7.0	-7.6	64.1	14.8	63.8	15.7	63.6	16.6	63.5	17.0	63.4	17.5	63.1	18.4	
	-5.0	-5.6	67.1	15.4	66.9	16.3	66.6	17.1	66.5	17.6	66.4	18.0	66.2	18.8	
	-3.0	-3.7	70.1	16.0	69.9	16.8	69.6	17.6	69.5	18.0	69.4	18.5	69.2	19.3	
	0.0	-0.7	75.1	16.9	74.9	17.6	74.7	18.4	74.6	18.8	74.4	19.1	74.2	19.9	
	3.0	2.2	80.3	17.6	80.1	18.3	79.8	19.1	79.7	19.4	79.6	19.8	79.4	20.5	
	5.0	4.1	83.8	18.1	83.6	18.8	83.4	19.5	83.3	19.8	83.2	20.1	82.9	20.8	
	7.0	6.0	87.5	18.6	87.3	19.2	87.1	19.9	87.0	20.2	86.8	20.5	86.6	21.2	
	9.0	7.9	91.3	19.0	91.1	19.6	90.9	20.2	90.8	20.5	90.7	20.8	90.4	21.5	
11.0	9.8	95.3	19.4	95.1	20.0	94.8	20.6	94.7	20.9	94.6	21.2	90.8	20.5		
13.0	11.8	99.6	19.8	99.4	20.4	99.1	20.9	99.0	21.2	98.9	21.5	90.8	19.4		
15.0	13.7	103.8	20.2	103.6	20.7	103.3	21.2	103.1	21.5	99.0	20.5	90.8	18.4		
120% 88.20 kW	-19.8	-20.0	48.3	11.5	48.1	12.6	47.9	13.7	47.8	14.3	47.6	14.9	47.4	16.0	
	-18.8	-19.0	49.3	11.9	49.1	13.0	48.9	14.1	48.8	14.6	48.7	15.2	48.5	16.2	
	-16.7	-17.0	51.5	12.6	51.3	13.7	51.1	14.7	51.0	15.2	50.9	15.8	50.7	16.8	
	-13.7	-15.0	53.9	13.4	53.6	14.4	53.4	15.3	53.3	15.8	53.2	16.3	53.0	17.3	
	-11.8	-13.0	56.3	14.1	56.1	15.0	55.9	15.9	55.8	16.4	55.7	16.9	55.5	17.8	
	-9.8	-11.0	59.0	14.7	58.8	15.6	58.6	16.5	58.5	17.0	58.4	17.4	58.1	18.3	
	-9.5	-10.0	60.3	15.1	60.1	15.9	59.9	16.8	59.8	17.3	59.7	17.7	59.5	18.6	
	-8.5	-9.1	61.6	15.3	61.4	16.2	61.2	17.1	61.1	17.5	61.0	17.9	60.8	18.8	
	-7.0	-7.6	63.8	15.8	63.6	16.6	63.4	17.5	63.3	17.9	63.2	18.3	63.0	19.1	
	-5.0	-5.6	66.8	16.4	66.6	17.2	66.4	18.0	66.3	18.4	66.2	18.8	66.0	19.6	
	-3.0	-3.7	69.8	16.9	69.6	17.7	69.4	18.5	69.3	18.8	69.2	19.2	69.0	20.0	
	0.0	-0.7	74.9	17.7	74.6	18.4	74.4	19.1	74.3	19.5	74.2	19.8	74.0	20.5	
	3.0	2.2	80.0	18.5	79.8	19.1	79.6	19.8	79.5	20.1	79.4	20.4	79.2	21.1	
	5.0	4.1	83.6	18.9	83.4	19.5	83.2	20.1	83.1	20.5	82.9	20.8	82.7	21.4	
	7.0	6.0	87.3	19.3	87.1	19.9	86.8	20.5	86.7	20.8	86.6	21.1	86.4	20.7	
	9.0	7.9	91.1	19.7	90.9	20.3	90.7	20.8	90.6	21.1	90.4	21.4	90.2	19.6	
11.0	9.8	95.0	20.1	94.8	20.6	94.6	21.2	94.5	21.4	94.4	20.7	94.2	18.6		
13.0	11.8	99.3	20.4	99.1	21.0	98.9	21.5	98.8	21.5	98.7	21.4	98.6	17.7		
15.0	13.7	103.5	20.8	103.3	21.3	103.1	21.8	102.9	21.5	102.8	21.4	102.7	16.8		
110% 80.85 kW	-19.8	-20.0	48.0	12.9	47.8	13.9	47.6	14.9	47.5	15.5	47.4	16.0	47.2	17.0	
	-18.8	-19.0	49.1	13.3	48.9	14.3	48.7	15.2	48.6	15.7	48.5	16.2	48.3	17.2	
	-16.7	-17.0	51.3	13.9	51.1	14.9	50.9	15.8	50.8	16.3	50.7	16.8	50.5	17.7	
	-13.7	-15.0	53.6	14.6	53.4	15.5	53.2	16.4	53.1	16.9	53.0	17.3	52.8	18.2	
	-11.8	-13.0	56.1	15.2	55.9	16.1	55.7	17.0	55.6	17.4	55.5	17.8	55.3	18.7	
	-9.8	-11.0	58.7	15.9	58.5	16.7	58.3	17.5	58.2	17.9	58.1	18.3	58.0	19.2	
	-9.5	-10.0	60.1	16.2	59.9	17.0	59.7	17.8	59.6	18.2	59.5	18.6	59.3	19.4	
	-8.5	-9.1	61.4	16.4	61.2	17.2	61.0	18.0	60.9	18.4	60.8	18.8	60.6	19.6	
	-7.0	-7.6	63.5	16.8	63.3	17.6	63.1	18.4	63.1	18.7	63.0	19.1	62.8	19.9	
	-5.0	-5.6	66.6	17.4	66.4	18.1	66.2	18.8	66.1	19.2	66.0	19.6	65.8	20.3	
	-3.0	-3.7	69.6	17.9	69.4	18.6	69.2	19.3	69.1	19.6	69.0	20.0	68.8	20.6	
	0.0	-0.7	74.6	18.6	74.4	19.3	74.2	19.9	74.1	20.2	74.0	20.5	73.8	21.2	
	3.0	2.2	79.8	19.3	79.6	19.9	79.4	20.5	79.3	20.8	79.2	21.1	78.9	20.7	
	5.0	4.1	83.3	19.7	83.1	20.2	82.9	20.8	82.8	21.1	82.7	21.4	82.5	19.7	
	7.0	6.0	87.0	20.1	86.8	20.6	86.6	21.2	86.5	21.4	86.4	20.7	86.2	18.6	
	9.0	7.9	90.8	20.4	90.6	20.9	90.4	21.5	90.3	21.6	90.2	21.4	90.0	17.7	
11.0	9.8	94.8	20.8	94.6	21.3	94.4	21.8	94.3	21.9	94.2	21.6	94.0	16.8		
13.0	11.8	99.1	21.1	98.9	21.6	98.8	22.1	98.7	22.2	98.6	21.9	98.4	16.0		
15.0	13.7	103.3	21.4	103.1	21.9	102.9	22.4	102.8	22.5	102.7	22.2	102.5	15.2		
100% 73.50 kW	-19.8	-20.0	47.8	14.3	47.6	15.2	47.4	16.2	47.3	16.6	47.2	17.1	47.1	18.0	
	-18.8	-19.0	48.8	14.6	48.6	15.5	48.4	16.4	48.4	16.9	48.3	17.3	48.1	18.2	
	-16.7	-17.0	51.0	15.2	50.8	16.1	50.6	17.0	50.6	17.4	50.5	17.8	50.3	18.7	
	-13.7	-15.0	53.3	15.8	53.2	16.7	53.0	17.5	52.9	17.9	52.8	18.3	52.6	19.1	
	-11.8	-13.0	55.8	16.4	55.6	17.2	55.5	18.0	55.4	18.4	55.3	18.8	55.1	19.6	
	-9.8	-11.0	58.5	17.0	58.3	17.7	58.1	18.5	58.0	18.9	57.9	19.2	57.8	20.0	
	-9.5	-10.0	59.8	17.3	59.7	18.0	59.5	18.7	59.4	19.1	59.3	19.4	59.1	20.2	
	-8.5	-9.1	61.1	17.5	60.9	18.2	60.7	18.9	60.7	19.3	60.6	19.6	60.4	20.4	
	-7.0	-7.6	63.3	17.9	63.1	18.6	62.9	19.3	62.8	19.6	62.7	20.0	62.6	20.6	
	-5.0	-5.6	66.3	18.4	66.1	19.0	65.9	19.7	65.9	20.0	65.8	20.4	65.6	21.0	
	-3.0	-3.7	69.3	18.8	69.1	19.5	68.9	20.1	68.9	20.4	68.8	20.7	68.6	21.3	
	0.0	-0.7	74.3	19.5	74.2	20.1	74.0	20.7	73.9	21.0	73.8	21.2	73.6	20.3	
	3.0	2.2	79.5	20.1	79.3	20.6	79.2	21.2	79.1	21.5	79.0	21.6	78.8	18.5	
	5.0	4.1	83.1	20.5	82.9	21.0	82.8	21.4	82.7	21.7	82.6	21.8	82.4	17.6	
	7.0	6.0	86.7	20.8	86.6	21.3	86.5	21.8	86.4	22.0	86.3	22.1	86.1	16.7	
	9.0	7.9	90.6	21.1	90.5	21.6	90.4	22.1	90.3	22.2	90.2	22.2	90.0	15.9	
11.0	9.8	94.5	21.4	94.4	21.9	94.3	22.4	94.2	22.5	94.1	22.4	94.0	15.1		
13.0	11.8	98.4	21.7	98.3	22.2	98.2	22.7	98.1	22.8	98.0	22.7	97.9	14.4		
15.0	13.7	102.3	22.0	102.2	22.5	102.1	23.0	102.0	23.1	101.9	23.0	101.8	13.7		

NOTES - ANMERKUNGEN - Σημειώσεις - NOTAS - REMARQUES - NOTE - OPMERKINGEN - примечания - NOTLAR

- is shown as reference. When selecting the unit models, avoid the Outdoor air temperature range shown by .
 dient als Verweis. Vermijden Sie bei der Auswahl der Gerätemodelle den als markierten Temperaturbereich der Außenluft.
 Η είναι ενδεικτική, κατά την επιλογή των μοντέλων των μονάδων, αποφύγετε το εύρος θερμοκρασίας εξωτερικού αέρα που υποδεικνύεται.
 se muestra como referencia. Cuando seleccione los modelos de unidad, evite el intervalo de temperaturas del aire exterior indicado mediante .
 est montré comme référence. Lors du choix des modèles d'unités, évitez la plage de températures de l'air extérieur illustré par .
 valori riportati unicamente come riferimento. Nel selezionare i modelli delle unità, non considerare i valori di temperatura dell'aria esterna indicati con il colore .
 is als referentie getoond. Wanneer modellen van eenheden worden gekozen, vermijd dan het bereik van buitenluchttemperaturen geïllustreerd door .
- показан как. При выборе модели устройства избегайте внешнюю температуру воздуха, указанную в .
 referans olarak gösterilmektedir. Ünite modellerini seçerken, belirtilen Dış hava sıcaklığı aralığından kaçınınız .
 The above table shows the average value of conditions which may occur.
 Die obige Tabelle zeigt den Durchschnittswert der Bedingungen, die auftreten können.
 Στον παραπάνω πίνακα αναγράφεται η μέση τιμή για συνθήκες που μπορεί να προκύψουν.
 La tabla de arriba muestra el valor medio de condiciones que pueden ocurrir.
 Le tableau ci-dessus donne la valeur moyenne pour des conditions qui peuvent survenir.
 La tabella in alto mostra il valore delle condizioni medie che si possono riscontrare.
 De tabel hierboven geeft de gemiddelde

5 Таблицы производительности

5 - 2 Таблицы теплопроизводительностей

5

RXYQ26T														
Indoor air temp. °CDB														
Combination(%) (Capacity index)	Outdoor air temp.		16.0		18.0		20.0		21.0		22.0		24.0	
			TC	PI	TC	PI	TC	PI	TC	PI	TC	PI	TC	PI
	(°CDB)	(°CWB)	KW	KW	KW	KW	KW	KW	KW	KW	KW	KW	KW	KW
90% 66.15 kW	-19.8	-20.0	47.5	15.7	47.3	16.5	47.2	17.4	47.1	17.8	47.0	18.2	46.9	19.0
	-18.8	-19.0	48.5	16.0	48.4	16.8	48.2	17.6	48.1	18.0	48.1	18.4	47.9	19.2
	-16.7	-17.0	50.7	16.5	50.6	17.3	50.4	18.1	50.3	18.5	50.3	18.9	50.1	19.6
	-13.7	-15.0	53.1	17.1	52.9	17.8	52.8	18.6	52.7	18.9	52.6	19.3	52.4	20.0
	-11.8	-13.0	55.6	17.6	55.4	18.3	55.2	19.0	55.2	19.4	55.1	19.7	54.9	20.4
	-9.8	-11.0	58.2	18.1	58.0	18.8	57.9	19.5	57.8	19.8	57.7	20.1	57.6	20.8
	-9.5	-10.0	59.6	18.4	59.4	19.0	59.3	19.7	59.2	20.0	59.1	20.3	58.9	21.0
	-8.5	-9.1	60.8	18.6	60.7	19.2	60.5	19.9	60.4	20.2	60.4	20.5	60.2	21.1
	-7.0	-7.6	63.0	18.9	62.9	19.5	62.7	20.2	62.6	20.5	62.5	20.8	62.4	21.4
	-5.0	-5.6	66.0	19.4	65.9	20.0	65.7	20.5	65.6	20.8	65.6	21.1	62.8	20.4
	-3.0	-3.7	69.0	19.8	68.9	20.3	68.7	20.9	68.7	21.2	68.5	21.4	62.8	19.3
	0.0	-0.7	74.1	20.4	73.9	20.9	73.8	21.4	71.4	20.6	68.5	19.7	62.8	17.8
	3.0	2.2	79.2	20.9	79.1	21.4	74.3	19.9	71.4	19.0	68.5	18.1	62.8	16.4
	5.0	4.1	82.8	21.2	80.0	20.6	74.3	18.9	71.4	18.0	68.5	17.2	62.8	15.6
	7.0	6.0	85.7	21.2	80.0	19.6	74.3	17.9	71.4	17.1	68.5	16.3	62.8	14.8
	9.0	7.9	85.7	20.1	80.0	18.6	74.3	17.0	71.4	16.3	68.5	15.5	62.8	14.1
	11.0	9.8	85.7	19.1	80.0	17.6	74.3	16.2	71.4	15.5	68.5	14.8	62.8	13.5
13.0	11.8	85.7	18.1	80.0	16.7	74.3	15.4	71.4	14.7	68.5	14.1	62.8	12.8	
15.0	13.7	85.7	17.3	80.0	15.9	74.3	14.7	71.4	14.0	68.5	13.4	62.8	12.2	
80% 58.80 kW	-19.8	-20.0	47.2	17.1	47.1	17.8	47.0	18.6	46.9	18.9	46.8	19.3	46.7	20.0
	-18.8	-19.0	48.3	17.3	48.1	18.1	48.0	18.8	47.9	19.1	47.9	19.5	47.7	20.2
	-16.7	-17.0	50.5	17.8	50.3	18.5	50.2	19.2	50.1	19.6	50.1	19.9	49.9	20.6
	-13.7	-15.0	52.8	18.3	52.7	19.0	52.5	19.6	52.5	20.0	52.4	20.3	52.3	21.0
	-11.8	-13.0	55.3	18.8	55.2	19.4	55.0	20.0	55.0	20.4	54.9	20.7	54.7	21.3
	-9.8	-11.0	57.9	19.2	57.8	19.8	57.7	20.4	57.6	20.7	57.5	21.0	55.8	20.7
	-9.5	-10.0	59.3	19.4	59.2	20.0	59.0	20.6	59.0	20.9	58.9	21.2	55.8	20.1
	-8.5	-9.1	60.6	19.6	60.4	20.2	60.3	20.8	60.2	21.1	60.2	21.4	55.8	19.6
	-7.0	-7.6	62.7	20.0	62.6	20.5	62.5	21.1	62.4	21.3	60.9	20.9	55.8	18.8
	-5.0	-5.6	65.8	20.4	65.6	20.9	65.5	21.4	63.5	20.7	60.9	19.7	55.8	17.8
	-3.0	-3.7	68.8	20.7	68.6	21.2	66.0	20.5	63.5	19.6	60.9	18.6	55.8	16.8
	0.0	-0.7	73.8	21.2	71.1	20.5	66.0	18.8	63.5	18.0	60.9	17.1	55.8	15.5
	3.0	2.2	76.2	20.5	71.1	18.9	66.0	17.3	63.5	16.6	60.9	15.8	55.8	14.4
	5.0	4.1	76.2	19.5	71.1	17.9	66.0	16.5	63.5	15.8	60.9	15.0	55.8	13.7
	7.0	6.0	76.2	18.5	71.1	17.0	66.0	15.7	63.5	15.0	60.9	14.3	55.8	13.0
	9.0	7.9	76.2	17.5	71.1	16.2	66.0	14.9	63.5	14.3	60.9	13.6	55.8	12.4
	11.0	9.8	76.2	16.7	71.1	15.4	66.0	14.2	63.5	13.6	60.9	13.0	55.8	11.9
13.0	11.8	76.2	15.8	71.1	14.7	66.0	13.5	63.5	12.9	60.9	12.4	55.8	11.3	
15.0	13.7	76.2	15.1	71.1	14.0	66.0	12.9	63.5	12.4	60.9	11.8	55.8	10.8	
70% 51.45 kW	-19.8	-20.0	47.0	18.5	46.8	19.1	46.7	19.8	46.7	20.1	46.6	20.4	46.5	21.1
	-18.8	-19.0	48.0	18.7	47.9	19.3	47.8	20.0	47.7	20.3	47.6	20.6	47.5	21.2
	-16.7	-17.0	50.2	19.1	50.1	19.7	50.0	20.3	49.9	20.6	49.8	20.9	48.9	21.0
	-13.7	-15.0	52.6	19.6	52.4	20.1	52.3	20.7	52.2	21.0	52.2	21.3	48.9	19.8
	-11.8	-13.0	55.0	20.0	54.9	20.5	54.8	21.1	54.7	21.3	53.3	20.8	48.9	18.7
	-9.8	-11.0	57.7	20.4	57.6	20.9	57.4	21.4	55.5	20.6	53.3	19.6	48.9	17.7
	-9.5	-10.0	59.0	20.5	58.9	21.1	57.8	21.0	55.5	20.0	53.3	19.1	48.9	17.2
	-8.5	-9.1	60.3	20.7	60.2	21.2	57.8	20.4	55.5	19.5	53.3	18.6	48.9	16.8
	-7.0	-7.6	62.5	21.0	62.2	21.4	57.8	19.6	55.5	18.7	53.3	17.8	48.9	16.1
	-5.0	-5.6	65.5	21.3	62.2	20.2	57.8	18.5	55.5	17.6	53.3	16.8	48.9	15.3
	-3.0	-3.7	66.6	20.7	62.2	19.1	57.8	17.5	55.5	16.7	53.3	16.0	48.9	14.5
	0.0	-0.7	66.6	19.0	62.2	17.5	57.8	16.1	55.5	15.4	53.3	14.7	48.9	13.4
	3.0	2.2	66.6	17.5	62.2	16.2	57.8	14.9	55.5	14.3	53.3	13.6	48.9	12.4
	5.0	4.1	66.6	16.7	62.2	15.4	57.8	14.2	55.5	13.6	53.3	13.0	48.9	11.8
	7.0	6.0	66.6	15.8	62.2	14.7	57.8	13.5	55.5	12.9	53.3	12.4	48.9	11.3
	9.0	7.9	66.6	15.1	62.2	14.0	57.8	12.9	55.5	12.3	53.3	11.8	48.9	10.8
	11.0	9.8	66.6	14.3	62.2	13.3	57.8	12.3	55.5	11.8	53.3	11.3	48.9	10.3
13.0	11.8	66.6	13.6	62.2	12.7	57.8	11.7	55.5	11.2	53.3	10.8	48.9	9.9	
15.0	13.7	66.6	13.0	62.2	12.1	57.8	11.2	55.5	10.8	53.3	10.3	48.9	9.5	
60% 44.10 kW	-19.8	-20.0	46.7	19.9	46.6	20.4	46.5	21.0	46.4	21.2	45.7	21.0	41.9	18.9
	-18.8	-19.0	47.8	20.0	47.6	20.6	47.5	21.1	47.5	21.4	45.7	20.5	41.9	18.4
	-16.7	-17.0	49.9	20.4	49.8	20.9	49.5	21.3	47.6	20.3	45.7	19.4	41.9	17.5
	-13.7	-15.0	52.3	20.8	52.2	21.3	49.5	20.1	47.6	19.2	45.7	18.3	41.9	16.6
	-11.8	-13.0	54.8	21.1	53.3	20.8	49.5	19.0	47.6	18.2	45.7	17.3	41.9	15.7
	-9.8	-11.0	57.1	21.3	53.3	19.6	49.5	18.0	47.6	17.2	45.7	16.4	41.9	14.9
	-9.5	-10.0	57.1	20.7	53.3	19.1	49.5	17.5	47.6	16.7	45.7	15.9	41.9	14.5
	-8.5	-9.1	57.1	20.2	53.3	18.6	49.5	17.0	47.6	16.3	45.7	15.6	41.9	14.1
	-7.0	-7.6	57.1	19.3	53.3	17.8	49.5	16.4	47.6	15.6	45.7	14.9	41.9	13.6
	-5.0	-5.6	57.1	18.2	53.3	16.8	49.5	15.5	47.6	14.8	45.7	14.2	41.9	12.9
	-3.0	-3.7	57.1	17.3	53.3	16.0	49.5	14.7	47.6	14.1	45.7	13.5	41.9	12.3
	0.0	-0.7	57.1	15.9	53.3	14.7	49.5	13.6	47.6	13.0	45.7	12.4	41.9	11.4
	3.0	2.2	57.1	14.7	53.3	13.6	49.5	12.6	47.6	12.1	45.7	11.6	41.9	10.6
	5.0	4.1	57.1	14.0	53.3	13.0	49.5	12.0	47.6	11.5	45.7	11.0	41.9	10.1
	7.0	6.0	57.1	13.3	53.3	12.4	49.5	11.5	47.6	11.0	45.7	10.5	41.9	9.7
	9.0	7.9	57.1	12.7	53.3	11.8	49.5	10.9	47.6	10.5	45.7	10.1	41.9	9.24
	11.0	9.8	57.1	12.1	53.3	11.3	49.5	10.5	47.6	10.1	45.7	9.6	41.9	8.86
13.0	11.8	57.1	11.6	53.3	10.8	49.5	10.0	47.6	9.6	45.7	9.22	41.9	8.48	
15.0	13.7	57.1	11.1	53.3	10.3	49.5	9.6	47.6	9.2	45.7	8.85	41.9	8.14	
50% 36.75 kW	-19.8	-20.0	46.4	21.2	44.4	20.3	41.3	18.6	39.7	17.8	38.1	17.0	34.9	15.4
	-18.8	-19.0	47.5	21.4	44.4	19.8	41.3	18.1	39.7	17.3	38.1	16.5	34.9	15.0
	-16.7	-17.0	47.6	20.3	44.4	18.7	41.3	17.2	39.7	16.4	38.1	15.7	34.9	14.2
	-13.7	-15.0	47.6	19.2	44.4	17.7	41.3	16.3	39.7	15.6	38.1	14.9	34.9	13.5
	-11.8	-13.0	47.6	18.2	44.4	16.8	41.3	15.4	39.7	14.8	38.1	14.1	34.9	12.8
	-9.8	-11.0	47.6	17.2	44.4	15.9	41.3	14.6	39.7	14.0	38.1	13.4	34.9	12.2
	-9.5	-10.0	47.6	16.7	44.4	15.4	41.3	14.2	39.7	13.6	38.1	13.0	34.9	11.9
	-8.5	-9.1	47.6	16.3	44.4	15.1	41.3	13.9	39.7	13.3	38.1	12.7	34.9	11.6
	-7.0	-7.6	47.6	15.6	44.4	14.5	41.3	13.3	39.7	12.8	38.1	12.2	34.9	11.2
	-5.0	-5.6	47.6	14.8	44.4	13.7	41.3	12.7	39.7	12.1	38.1	11.6	34.9	10.6
	-3.0	-3.7	47.6	14.1	44.4	13.1	41.3	12.1	39.7	11.6	38.1	11.1	34.9	10.1
	0.0	-0.7	47.6	13.0	44.4	12.1	41.3	11.2						

5 Таблицы производительности

5 - 2 Таблицы теплопроизводительностей

RXYQ28T		TC: Total capacity (kW); PI: Power Input (kW) (Comp. + Outdoor fan motor)												
Indoor air temp. °CDB														
Combination(%) (Capacity index)	Outdoor air temp.		16.0		18.0		20.0		21.0		22.0		24.0	
	(°CDB)	(°CWB)	TC	PI	TC	PI	TC	PI	TC	PI	TC	PI	TC	PI
130% 102.05 kW	-19.8	-20.0	51.0	10.8	50.8	12.1	50.5	13.4	50.4	14.1	50.3	14.7	50.1	16.0
	-18.8	-19.0	51.9	11.2	51.7	12.4	51.4	13.7	51.3	14.4	51.2	15.0	50.9	16.3
	-16.7	-17.0	53.9	11.9	53.6	13.2	53.4	14.4	53.3	15.0	53.2	15.6	52.9	16.9
	-13.7	-15.0	56.1	12.7	55.8	13.9	55.6	15.1	55.5	15.7	55.4	16.3	55.1	17.5
	-11.8	-13.0	58.5	13.5	58.3	14.6	58.0	15.8	57.9	16.3	57.8	16.9	57.5	18.0
	-9.8	-11.0	61.2	14.3	60.9	15.4	60.7	16.4	60.6	17.0	60.4	17.5	60.2	18.6
	-9.5	-10.0	62.6	14.7	62.3	15.7	62.1	16.8	62.0	17.3	61.9	17.8	61.6	18.9
	-8.5	-9.1	63.9	15.0	63.7	16.1	63.4	17.1	63.3	17.6	63.2	18.1	62.9	19.2
	-7.0	-7.6	66.2	15.6	66.0	16.6	65.7	17.6	65.6	18.1	65.5	18.6	65.2	19.6
	-5.0	-5.6	69.5	16.3	69.2	17.3	69.0	18.2	68.9	18.7	68.8	19.2	68.5	20.1
	-3.0	-3.7	72.8	17.0	72.6	17.9	72.3	18.8	72.2	19.3	72.1	19.7	71.9	20.6
	0.0	-0.7	78.5	18.1	78.3	18.9	78.0	19.7	77.9	20.2	77.8	20.6	77.5	21.4
	3.0	2.2	84.5	19.0	84.3	19.8	84.0	20.5	83.9	20.9	83.8	21.3	83.5	22.1
	5.0	4.1	88.7	19.6	88.4	20.3	88.2	21.0	88.1	21.4	88.0	21.8	87.7	22.5
	7.0	6.0	93.1	20.1	92.8	20.8	92.6	21.5	92.5	21.9	92.4	22.2	92.1	22.9
	9.0	7.9	97.7	20.6	97.4	21.3	97.2	22.0	97.1	22.3	97.0	22.6	96.3	23.1
11.0	9.8	102.5	21.1	102.2	21.8	102.0	22.4	101.9	22.7	101.8	23.0	96.3	21.8	
13.0	11.8	107.8	21.6	107.5	22.2	107.3	22.8	107.2	23.1	107.1	23.4	96.3	20.5	
15.0	13.7	113	22.1	113	22.6	113	23.2	113	23.5	113	23.8	96.3	19.3	
120% 94.20 kW	-19.8	-20.0	50.7	12.3	50.5	13.5	50.3	14.7	50.2	15.3	50.1	15.9	49.8	17.2
	-18.8	-19.0	51.6	12.6	51.4	13.8	51.2	15.0	51.1	15.6	51.0	16.2	50.7	17.4
	-16.7	-17.0	53.6	13.3	53.4	14.5	53.2	15.6	53.0	16.2	52.9	16.8	52.7	17.9
	-13.7	-15.0	55.8	14.1	55.6	15.2	55.4	16.3	55.2	16.8	55.1	17.4	54.9	18.5
	-11.8	-13.0	58.2	14.8	58.0	15.8	57.8	16.9	57.7	17.4	57.6	17.9	57.3	19.0
	-9.8	-11.0	60.9	15.5	60.7	16.5	60.4	17.5	60.3	18.0	60.2	18.5	60.0	19.5
	-9.5	-10.0	62.3	15.9	62.1	16.9	61.9	17.8	61.7	18.3	61.6	18.8	61.4	19.8
	-8.5	-9.1	63.6	16.2	63.4	17.2	63.2	18.1	63.1	18.6	63.0	19.1	62.7	20.0
	-7.0	-7.6	65.9	16.7	65.7	17.7	65.5	18.6	65.4	19.0	65.3	19.5	65.0	20.4
	-5.0	-5.6	69.2	17.4	69.0	18.3	68.8	19.2	68.7	19.6	68.5	20.1	68.3	20.9
	-3.0	-3.7	72.5	18.1	72.3	18.9	72.1	19.7	72.0	20.2	71.9	20.6	71.7	21.4
	0.0	-0.7	78.2	19.0	78.0	19.8	77.8	20.6	77.7	21.0	77.6	21.3	77.3	22.1
	3.0	2.2	84.2	19.9	84.0	20.6	83.8	21.3	83.7	21.7	83.6	22.0	83.3	22.7
	5.0	4.1	88.4	20.4	88.2	21.1	88.0	21.8	87.9	22.1	87.7	22.5	87.5	23.1
	7.0	6.0	92.8	20.9	92.6	21.6	92.4	22.2	92.2	22.5	92.1	22.9	88.8	22.3
	9.0	7.9	97.4	21.4	97.2	22.0	97.0	22.6	96.8	22.9	96.7	23.3	88.8	21.0
11.0	9.8	102.2	21.9	102.0	22.4	101.8	23.0	101.0	23.1	96.9	22.0	88.8	19.8	
13.0	11.8	107.5	22.3	107.3	22.9	105.0	22.7	101.0	21.7	96.9	20.7	88.8	18.7	
15.0	13.7	113	22.7	113	23.2	105	21.4	101	20.5	96.9	19.5	88.8	17.6	
110% 86.35 kW	-19.8	-20.0	50.5	13.8	50.3	14.9	50.1	16.0	50.0	16.6	49.8	17.2	49.6	18.3
	-18.8	-19.0	51.4	14.1	51.2	15.2	50.9	16.3	50.8	16.9	50.7	17.4	50.5	18.5
	-16.7	-17.0	53.3	14.8	53.1	15.8	52.9	16.9	52.8	17.4	52.7	17.9	52.5	19.0
	-13.7	-15.0	55.5	15.4	55.3	16.4	55.1	17.5	55.0	18.0	54.9	18.5	54.7	19.5
	-11.8	-13.0	57.9	16.1	57.7	17.1	57.5	18.0	57.4	18.5	57.3	19.0	57.1	20.0
	-9.8	-11.0	60.6	16.8	60.4	17.7	60.2	18.6	60.1	19.1	60.0	19.5	59.8	20.5
	-9.5	-10.0	62.0	17.1	61.8	18.0	61.6	18.9	61.5	19.4	61.4	19.8	61.2	20.7
	-8.5	-9.1	63.3	17.4	63.1	18.3	62.9	19.2	62.8	19.6	62.7	20.0	62.5	20.9
	-7.0	-7.6	65.7	17.9	65.5	18.7	65.2	19.6	65.1	20.0	65.0	20.4	64.8	21.3
	-5.0	-5.6	68.9	18.5	68.7	19.3	68.5	20.1	68.4	20.5	68.3	20.9	68.1	21.7
	-3.0	-3.7	72.3	19.1	72.1	19.9	71.9	20.6	71.8	21.0	71.7	21.4	71.5	22.2
	0.0	-0.7	78.0	20.0	77.7	20.7	77.5	21.4	77.4	21.8	77.3	22.1	77.1	22.8
	3.0	2.2	83.9	20.8	83.7	21.4	83.5	22.1	83.4	22.4	83.3	22.7	83.1	23.4
	5.0	4.1	88.1	21.3	87.9	21.9	87.7	22.5	87.6	22.8	87.5	23.1	87.4	23.8
	7.0	6.0	92.5	21.7	92.3	22.3	92.1	22.9	92.0	23.2	91.9	23.5	91.8	24.2
	9.0	7.9	97.1	22.2	96.9	22.7	96.3	23.1	92.5	22.1	88.8	21.0	81.4	19.0
11.0	9.8	101.9	22.6	101.7	23.1	96.3	21.8	92.5	20.8	88.8	19.8	81.4	17.9	
13.0	11.8	107.2	23.0	103.7	22.4	96.3	20.5	92.5	19.6	88.8	18.7	81.4	16.9	
15.0	13.7	111	22.9	104	21.1	96.3	19.3	92.5	18.5	88.8	17.6	81.4	16.0	
100% 78.50 kW	-19.8	-20.0	50.2	15.3	50.0	16.3	49.8	17.4	49.7	17.9	49.6	18.4	49.4	19.4
	-18.8	-19.0	51.1	15.6	50.9	16.6	50.7	17.6	50.6	18.1	50.5	18.6	50.3	19.6
	-16.7	-17.0	53.0	16.2	52.9	17.2	52.7	18.1	52.6	18.6	52.5	19.1	52.3	20.0
	-13.7	-15.0	55.2	16.8	55.1	17.7	54.9	18.6	54.8	19.1	54.7	19.6	54.5	20.5
	-11.8	-13.0	57.7	17.4	57.5	18.3	57.3	19.2	57.2	19.6	57.1	20.0	56.9	20.9
	-9.8	-11.0	60.3	18.0	60.1	18.9	60.0	19.7	59.9	20.1	59.8	20.5	59.6	21.4
	-9.5	-10.0	61.7	18.3	61.6	19.1	61.4	20.0	61.3	20.4	61.2	20.8	61.0	21.6
	-8.5	-9.1	63.1	18.6	62.9	19.4	62.7	20.2	62.6	20.6	62.5	21.0	62.3	21.8
	-7.0	-7.6	65.4	19.0	65.2	19.8	65.0	20.6	64.9	21.0	64.8	21.4	64.6	22.1
	-5.0	-5.6	68.7	19.6	68.5	20.4	68.3	21.1	68.2	21.5	68.1	21.8	67.9	22.5
	-3.0	-3.7	72.0	20.2	71.8	20.9	71.6	21.5	71.5	21.9	71.4	22.2	71.3	22.9
	0.0	-0.7	77.7	21.0	77.5	21.6	77.3	22.2	77.2	22.6	77.1	22.9	77.0	23.4
	3.0	2.2	83.7	21.7	83.5	22.3	83.3	22.9	83.2	23.2	83.1	23.5	83.0	24.0
	5.0	4.1	87.9	22.1	87.7	22.7	87.5	23.3	87.4	23.6	87.3	23.9	87.2	24.4
	7.0	6.0	92.2	22.5	92.1	23.1	92.0	23.7	91.9	24.0	91.8	24.3	91.7	24.8
	9.0	7.9	96.8	22.9	96.7	23.5	96.6	24.1	96.5	24.4	96.4	24.7	96.3	25.2
11.0	9.8	101.0	23.1	100.9	23.7	100.8	24.3	100.7	24.6	100.6	24.9	100.5	25.4	
13.0	11.8	101.0	21.7	94.2	20.0	87.5	18.3	84.1	17.5	80.8	16.7	74.0	15.2	
15.0	13.7	101.0	20.5	94.2	18.9	87.5	17.3	84.1	16.6	80.8	15.8	74.0	14.4	

NOTES - ANMERKUNGEN - Σημειώσεις - NOTAS - REMARQUES - NOTE - OPMERKINGEN - примечания - NOTLAR

- █ is shown as reference. When selecting the unit models, avoid the Outdoor air temperature range shown by █.

█ dient als Verweis. Vermeiden Sie bei der Auswahl der Gerätemodelle den als markierten Temperaturbereich der Außenluft.

Η █ είναι ενδεικτική, κατά την επιλογή των μοντέλων των μονάδων, αποφύγετε το εύρος θερμοκρασίας εξωτερικού αέρα που υποδεικνύεται █.

█ se muestra como referencia. Cuando seleccione los modelos de unidad, evite el intervalo de temperaturas del aire exterior indicado mediante █.

█ est montré comme référence. Lors du choix des modèles d'unités, évitez la plage de températures de l'air extérieur illustré par █.

█ valori riportati unicamente come riferimento. Nel selezionare i modelli delle unità, non considerare i valori di temperatura dell'aria esterna indicati con il colore █.

█ is als referentie getoond. Wanneer modellen van eenheden worden gekozen, vermijd dan het bereik van buitenluchttemperaturen geïllustreerd door █.

█ показан как. При выборе модели устройства избегайте внешнюю температуру воздуха, указанную в █.

█ referans olarak gösterilmektedir. Ünite modellerini seçerken, belirtilen Dış hava sıcaklığı aralığından kaçınınız █.

The above table shows the average value of conditions which may occur.

Die obige Tabelle zeigt den Durchschnittswert der Bedingungen, die auftreten können.

Στον παραπάνω πίνακα αναγράφεται η μέση τιμή για συνθήκες που μπορεί να προκύψουν.

La tabla de arriba muestra el valor medio de condiciones que pueden ocurrir.

Le tableau ci-dessus donne la valeur moyenne pour des conditions qui peuvent survenir.

La tabella in alto mostra il valore delle condizioni medie che si possono riscontrare.

De tabel hierboven geeft de gemiddelde waarde aan van situaties die kunnen voorvallen.

Таблица расположенная выше показывает среднее значение условий, которые могут наступить.

Yukarıdaki tablo meydana gelebilecek koşulların ortalama değerini göstermektedir.

3D079549A

5 Таблицы производительности

5 - 2 Таблицы теплопроизводительностей

5

RXYQ28T														
Indoor air temp. °CDB														
Combination(%) (Capacity index)	Outdoor air temp.		16.0		18.0		20.0		21.0		22.0		24.0	
			TC	PI	TC	PI	TC	PI	TC	PI	TC	PI	TC	PI
	(°CDB)	(°CWB)	KW	KW	KW	KW	KW	KW	KW	KW	KW	KW	KW	KW
90% 70.65 kW	-19.8	-20.0	49.9	16.9	49.7	17.8	49.6	18.7	49.5	19.1	49.4	19.6	49.2	20.5
	-18.8	-19.0	50.8	17.1	50.6	18.0	50.5	18.9	50.4	19.3	50.3	19.8	50.1	20.7
	-16.7	-17.0	52.8	17.6	52.6	18.5	52.4	19.4	52.4	19.8	52.3	20.2	52.1	21.1
	-13.7	-15.0	55.0	18.2	54.8	19.0	54.6	19.8	54.6	20.2	54.5	20.7	54.3	21.5
	-11.8	-13.0	57.4	18.7	57.2	19.5	57.1	20.3	57.0	20.7	56.9	21.1	56.7	21.9
	-9.8	-11.0	60.1	19.3	59.9	20.0	59.7	20.8	59.6	21.2	59.6	21.5	59.4	22.3
	-9.5	-10.0	61.5	19.6	61.3	20.3	61.1	21.0	61.1	21.4	61.0	21.8	60.8	22.5
	-8.5	-9.1	62.8	19.8	62.6	20.5	62.5	21.2	62.4	21.6	62.3	22.0	62.1	22.7
	-7.0	-7.6	65.1	20.2	64.9	20.9	64.8	21.6	64.7	21.9	64.6	22.3	64.4	23.0
	-5.0	-5.6	68.4	20.7	68.2	21.4	68.1	22.0	68.0	22.4	67.9	22.7	66.6	22.8
	-3.0	-3.7	71.7	21.2	71.5	21.8	71.4	22.5	71.3	22.8	71.2	23.1	66.6	21.5
	0.0	-0.7	77.4	21.9	77.2	22.5	77.1	23.1	75.7	22.8	72.7	21.7	66.6	19.6
	3.0	2.2	83.4	22.6	83.2	23.1	78.8	21.8	75.7	20.8	72.7	19.8	66.6	17.9
	5.0	4.1	87.6	23.0	84.8	22.4	78.8	20.5	75.7	19.6	72.7	18.7	66.6	16.9
	7.0	6.0	90.9	22.9	84.8	21.1	78.8	19.3	75.7	18.5	72.7	17.6	66.6	16.0
	9.0	7.9	90.9	21.6	84.8	19.9	78.8	18.3	75.7	17.5	72.7	16.7	66.6	15.1
	11.0	9.8	90.9	20.3	84.8	18.8	78.8	17.2	75.7	16.5	72.7	15.8	66.6	14.3
13.0	11.8	90.9	19.2	84.8	17.7	78.8	16.3	75.7	15.6	72.7	14.9	66.6	13.5	
15.0	13.7	90.9	18.1	84.8	16.7	78.8	15.4	75.7	14.8	72.7	14.1	66.6	12.9	
80% 62.80 kW	-19.8	-20.0	49.6	18.4	49.5	19.2	49.3	20.0	49.3	20.4	49.2	20.8	49.0	21.6
	-18.8	-19.0	50.5	18.6	50.4	19.4	50.2	20.2	50.2	20.6	50.1	21.0	49.9	21.8
	-16.7	-17.0	52.5	19.1	52.3	19.8	52.2	20.6	52.1	21.0	52.0	21.4	51.9	22.1
	-13.7	-15.0	54.7	19.6	54.5	20.3	54.4	21.0	54.3	21.4	54.2	21.8	54.1	22.5
	-11.8	-13.0	57.1	20.0	57.0	20.7	56.8	21.4	56.7	21.8	56.7	22.1	56.5	22.8
	-9.8	-11.0	59.8	20.5	59.6	21.2	59.5	21.9	59.4	22.2	59.3	22.5	59.2	23.2
	-9.5	-10.0	61.2	20.8	61.0	21.4	60.9	22.1	60.8	22.4	60.7	22.7	59.2	22.6
	-8.5	-9.1	62.5	21.0	62.4	21.6	62.2	22.3	62.1	22.6	62.1	22.9	59.2	22.0
	-7.0	-7.6	64.8	21.4	64.7	22.0	64.5	22.6	64.5	22.9	64.4	23.2	59.2	21.0
	-5.0	-5.6	68.1	21.8	68.0	22.4	67.8	23.0	67.3	23.0	66.6	21.9	59.2	19.8
	-3.0	-3.7	71.4	22.2	71.3	22.8	70.0	22.8	67.3	21.7	64.6	20.7	59.2	18.7
	0.0	-0.7	77.1	22.9	75.4	22.6	70.0	20.7	67.3	19.8	64.6	18.9	59.2	17.1
	3.0	2.2	80.8	22.4	75.4	20.7	70.0	19.0	67.3	18.1	64.6	17.3	59.2	15.7
	5.0	4.1	80.8	21.1	75.4	19.5	70.0	17.9	67.3	17.1	64.6	16.3	59.2	14.8
	7.0	6.0	80.8	19.9	75.4	18.4	70.0	16.9	67.3	16.2	64.6	15.5	59.2	14.0
	9.0	7.9	80.8	18.8	75.4	17.4	70.0	16.0	67.3	15.3	64.6	14.6	59.2	13.3
	11.0	9.8	80.8	17.8	75.4	16.4	70.0	15.1	67.3	14.5	64.6	13.9	59.2	12.6
13.0	11.8	80.8	16.7	75.4	15.5	70.0	14.3	67.3	13.7	64.6	13.1	59.2	12.0	
15.0	13.7	80.8	15.8	75.4	14.7	70.0	13.6	67.3	13.0	64.6	12.5	59.2	11.4	
70% 54.95 kW	-19.8	-20.0	49.4	19.9	49.2	20.6	49.1	21.3	49.0	21.7	49.0	22.0	48.8	22.7
	-18.8	-19.0	50.2	20.1	50.1	20.8	50.0	21.5	49.9	21.8	49.9	22.2	49.7	22.9
	-16.7	-17.0	52.2	20.5	52.1	21.2	52.0	21.8	51.9	22.2	51.8	22.5	51.7	23.2
	-13.7	-15.0	54.4	20.9	54.3	21.6	54.2	22.2	54.1	22.5	54.0	22.8	51.8	22.1
	-11.8	-13.0	56.8	21.4	56.7	22.0	56.6	22.6	56.5	22.9	56.5	23.2	51.8	20.9
	-9.8	-11.0	59.5	21.8	59.4	22.4	59.2	23.0	58.9	23.1	58.9	23.4	51.8	19.8
	-9.5	-10.0	60.9	22.0	60.8	22.6	60.7	23.1	58.9	22.4	56.5	21.3	51.8	19.3
	-8.5	-9.1	62.2	22.2	62.1	22.7	61.3	22.9	58.9	21.8	56.5	20.8	51.8	18.8
	-7.0	-7.6	64.5	22.5	64.4	23.0	61.3	21.9	58.9	20.9	56.5	19.9	51.8	18.0
	-5.0	-5.6	67.8	22.9	66.0	22.5	61.3	20.6	58.9	19.7	56.5	18.8	51.8	17.0
	-3.0	-3.7	70.7	23.0	66.0	21.2	61.3	19.4	58.9	18.6	56.5	17.7	51.8	16.1
	0.0	-0.7	70.7	21.0	66.0	19.3	61.3	17.8	58.9	17.0	56.5	16.2	51.8	14.7
	3.0	2.2	70.7	19.2	66.0	17.7	61.3	16.3	58.9	15.6	56.5	14.9	51.8	13.6
	5.0	4.1	70.7	18.1	66.0	16.7	61.3	15.4	58.9	14.7	56.5	14.1	51.8	12.9
	7.0	6.0	70.7	17.1	66.0	15.8	61.3	14.6	58.9	14.0	56.5	13.4	51.8	12.2
	9.0	7.9	70.7	16.1	66.0	15.0	61.3	13.8	58.9	13.2	56.5	12.7	51.8	11.6
	11.0	9.8	70.7	15.3	66.0	14.2	61.3	13.1	58.9	12.6	56.5	12.0	51.8	11.0
13.0	11.8	70.7	14.4	66.0	13.4	61.3	12.4	58.9	11.9	56.5	11.4	51.8	10.4	
15.0	13.7	70.7	13.7	66.0	12.7	61.3	11.8	58.9	11.3	56.5	10.9	51.8	10.0	
60% 47.10 kW	-19.8	-20.0	49.1	21.4	49.0	22.0	48.9	22.6	48.8	22.9	48.5	23.0	44.4	20.7
	-18.8	-19.0	50.0	21.6	49.9	22.2	49.8	22.8	49.7	23.1	48.5	22.5	44.4	20.3
	-16.7	-17.0	51.9	21.9	51.8	22.5	51.7	23.1	50.5	22.5	48.5	21.5	44.4	19.4
	-13.7	-15.0	54.1	22.3	54.0	22.8	52.5	22.4	50.5	21.4	48.5	20.4	44.4	18.4
	-11.8	-13.0	56.6	22.7	56.5	23.2	52.5	21.3	50.5	20.3	48.5	19.4	44.4	17.5
	-9.8	-11.0	59.2	23.0	56.5	22.0	52.5	20.1	50.5	19.2	48.5	18.3	44.4	16.6
	-9.5	-10.0	60.6	23.2	56.5	21.3	52.5	19.6	50.5	18.7	48.5	17.8	44.4	16.2
	-8.5	-9.1	60.6	22.6	56.5	20.8	52.5	19.1	50.5	18.2	48.5	17.4	44.4	15.8
	-7.0	-7.6	60.6	21.6	56.5	19.9	52.5	18.3	50.5	17.5	48.5	16.7	44.4	15.1
	-5.0	-5.6	60.6	20.3	56.5	18.8	52.5	17.2	50.5	16.5	48.5	15.7	44.4	14.3
	-3.0	-3.7	60.6	19.2	56.5	17.7	52.5	16.3	50.5	15.6	48.5	14.9	44.4	13.6
	0.0	-0.7	60.6	17.5	56.5	16.2	52.5	14.9	50.5	14.3	48.5	13.7	44.4	12.5
	3.0	2.2	60.6	16.1	56.5	14.9	52.5	13.7	50.5	13.2	48.5	12.6	44.4	11.5
	5.0	4.1	60.6	15.2	56.5	14.1	52.5	13.0	50.5	12.5	48.5	12.0	44.4	11.0
	7.0	6.0	60.6	14.4	56.5	13.4	52.5	12.4	50.5	11.9	48.5	11.4	44.4	10.4
	9.0	7.9	60.6	13.6	56.5	12.7	52.5	11.7	50.5	11.3	48.5	10.8	44.4	9.9
	11.0	9.8	60.6	12.9	56.5	12.0	52.5	11.2	50.5	10.7	48.5	10.3	44.4	9.4
13.0	11.8	60.6	12.2	56.5	11.4	52.5	10.6	50.5	10.2	48.5	9.8	44.4	8.99	
15.0	13.7	60.6	11.6	56.5	10.9	52.5	10.1	50.5	9.7	48.5	9.3	44.4	8.58	
50% 39.25 kW	-19.8	-20.0	48.8	22.9	47.1	22.3	43.8	20.4	42.1	19.5	40.4	18.6	37.0	16.8
	-18.8	-19.0	49.7	23.1	47.1	21.8	43.8	19.9	42.1	19.0	40.4	18.2	37.0	16.5
	-16.7	-17.0	50.5	22.5	47.1	20.8	43.8	19.0	42.1	18.2	40.4	17.4	37.0	15.7
	-13.7	-15.0	50.5	21.4	47.1	19.7	43.8	18.1	42.1	17.3	40.4	16.5	37.0	15.0
	-11.8	-13.0	50.5	20.3	47.1	18.7	43.8	17.2	42.1	16.5	40.4	15.7	37.0	14.3
	-9.8	-11.0	50.5	19.2	47.1	17.8	43.8	16.3	42.1	15.6	40.4	14.9	37.0	13.6
	-9.5	-10.0	50.5	18.7	47.1	17.3	43.8	15.9	42.1	15.2	40.4	14.5	37.0	13.2
	-8.5	-9.1	50.5	18.2	47.1	16.8	43.8	15.5	42.1	14.8	40.4	14.2	37.0	12.9
	-7.0	-7.6	50.5	17.5	47.1	16.1	43.8	14.9	42.1	14.3	40.4	13.6	37.0	12.4
	-5.0	-5.6	50.5	16.5	47.1	15.3	43.8	14.1	42.1	13.5	40.4	12.9	37.0	11.8
	-3.0	-3.7	50.5	15.6	47.1	14.5	43.8	13.4	42.1	12.8	40.4	12.3	37.0	11.2
	0.0	-0.7	50.5	14.3	47.1	13.3	43.8							

5 Таблицы производительности

5 - 2 Таблицы теплопроизводительностей

RXYQ30T		Indoor air temp. °CDB												
Combination(%) (Capacity index)	Outdoor air temp.		16.0		18.0		20.0		21.0		22.0		24.0	
	(°CDB)	(°CWB)	TC	PI	TC	PI	TC	PI	TC	PI	TC	PI	TC	PI
			KW	KW	KW	KW	KW	KW	KW	KW	KW	KW	KW	KW
130% 108.55 kW	-19.8	-20.0	54.3	11.4	54.1	12.9	53.8	14.3	53.7	15.0	53.6	15.7	53.3	17.1
	-18.8	-19.0	55.3	11.8	55.0	13.2	54.8	14.6	54.7	15.3	54.5	16.0	54.3	17.4
	-16.7	-17.0	57.4	12.7	57.1	14.0	56.9	15.3	56.7	16.0	56.6	16.7	56.4	18.0
	-13.7	-15.0	59.7	13.5	59.5	14.8	59.2	16.0	59.1	16.7	59.0	17.3	58.7	18.6
	-11.8	-13.0	62.3	14.3	62.0	15.6	61.8	16.8	61.7	17.4	61.5	18.0	61.3	19.2
	-9.8	-11.0	65.1	15.2	64.9	16.4	64.6	17.5	64.5	18.1	64.4	18.7	64.1	19.9
	-9.5	-10.0	66.6	15.6	66.4	16.8	66.1	17.9	66.0	18.5	65.9	19.0	65.6	20.2
	-8.5	-9.1	68.1	16.0	67.8	17.1	67.5	18.2	67.4	18.8	67.3	19.3	67.0	20.4
	-7.0	-7.6	70.5	16.6	70.3	17.7	70.0	18.8	69.9	19.3	69.7	19.8	69.5	20.9
	-5.0	-5.6	74.0	17.4	73.8	18.4	73.5	19.5	73.4	20.0	73.2	20.5	73.0	21.5
	-3.0	-3.7	77.6	18.2	77.3	19.1	77.1	20.1	76.9	20.6	76.8	21.1	76.5	22.0
	0.0	-0.7	83.6	19.3	83.4	20.2	83.1	21.1	83.0	21.5	82.9	22.0	82.6	22.8
	3.0	2.2	90.0	20.3	89.7	21.1	89.5	21.9	89.4	22.3	89.2	22.8	89.0	23.6
	5.0	4.1	94.5	20.9	94.2	21.7	94.0	22.5	93.8	22.9	93.7	23.3	93.4	24.0
	7.0	6.0	99.2	21.5	98.9	22.2	98.6	23.0	98.5	23.3	98.4	23.7	98.1	24.5
	9.0	7.9	104	22.0	104	22.7	104	23.5	103	23.8	103	24.2	103	24.8
11.0	9.8	109	22.6	109	23.2	109	23.9	109	24.3	108	24.6	108	25.4	
13.0	11.8	115	23.1	115	23.7	114	24.4	114	24.7	112	24.4	112	26.0	
15.0	13.7	120	23.5	120	24.2	120	24.8	117	24.1	112	23.0	103	22.8	
120% 100.20 kW	-19.8	-20.0	54.0	13.1	53.8	14.4	53.6	15.7	53.5	16.3	53.3	17.0	53.1	18.3
	-18.8	-19.0	55.0	13.4	54.8	14.7	54.5	16.0	54.4	16.6	54.3	17.3	54.1	18.6
	-16.7	-17.0	57.1	14.2	56.9	15.4	56.6	16.7	56.5	17.3	56.4	17.9	56.1	19.1
	-13.7	-15.0	59.4	15.0	59.2	16.1	59.0	17.3	58.8	17.9	58.7	18.5	58.5	19.7
	-11.8	-13.0	62.0	15.8	61.8	16.9	61.5	18.0	61.4	18.6	61.3	19.1	61.1	20.3
	-9.8	-11.0	64.8	16.5	64.6	17.6	64.4	18.7	64.2	19.2	64.1	19.8	63.9	20.8
	-9.5	-10.0	66.3	16.9	66.1	18.0	65.9	19.0	65.8	19.6	65.6	20.1	65.4	21.1
	-8.5	-9.1	67.8	17.3	67.5	18.3	67.3	19.3	67.2	19.8	67.0	20.4	66.8	21.4
	-7.0	-7.6	70.2	17.8	70.0	18.8	69.7	19.8	69.6	20.3	69.5	20.8	69.3	21.8
	-5.0	-5.6	73.7	18.6	73.5	19.5	73.2	20.5	73.1	20.9	73.0	21.4	72.8	22.3
	-3.0	-3.7	77.3	19.3	77.0	20.2	76.8	21.1	76.7	21.5	76.6	22.0	76.3	22.9
	0.0	-0.7	83.3	20.3	83.1	21.1	82.9	22.0	82.7	22.4	82.6	22.8	82.4	23.6
	3.0	2.2	89.7	21.2	89.5	22.0	89.2	22.8	89.1	23.1	89.0	23.5	88.8	24.3
	5.0	4.1	94.2	21.8	93.9	22.5	93.7	23.3	93.6	23.6	93.5	24.0	93.2	24.7
	7.0	6.0	98.9	22.3	98.6	23.0	98.4	23.7	98.3	24.1	98.2	24.4	97.9	25.4
	9.0	7.9	104	22.9	104	23.5	103	24.2	103	24.5	103	24.8	102.5	26.0
11.0	9.8	109	23.3	109	24.0	108	24.6	108	24.8	104	23.6	103	24.8	
13.0	11.8	115	23.8	114	24.4	112	24.4	108	23.3	104	22.2	94.9	20.0	
15.0	13.7	120	24.3	120	24.8	112	23.0	108	21.9	104	20.9	94.9	18.9	
110% 91.85 kW	-19.8	-20.0	53.7	14.7	53.5	15.9	53.3	17.1	53.2	17.7	53.1	18.3	52.9	19.5
	-18.8	-19.0	54.7	15.0	54.5	16.2	54.3	17.4	54.2	18.0	54.1	18.6	53.8	19.7
	-16.7	-17.0	56.8	15.7	56.6	16.9	56.4	18.0	56.2	18.5	56.1	19.1	55.9	20.2
	-13.7	-15.0	59.1	16.4	58.9	17.5	58.7	18.6	58.6	19.1	58.5	19.7	58.3	20.8
	-11.8	-13.0	61.7	17.2	61.5	18.2	61.3	19.2	61.2	19.7	61.1	20.3	60.8	21.3
	-9.8	-11.0	64.5	17.9	64.3	18.9	64.1	19.9	64.0	20.3	63.9	20.8	63.7	21.8
	-9.5	-10.0	66.1	18.2	65.8	19.2	65.6	20.2	65.5	20.6	65.4	21.1	65.2	22.1
	-8.5	-9.1	67.5	18.6	67.2	19.5	67.0	20.4	66.9	20.9	66.8	21.4	66.6	22.3
	-7.0	-7.6	69.9	19.1	69.7	20.0	69.5	20.9	69.4	21.3	69.3	21.8	69.1	22.7
	-5.0	-5.6	73.4	19.8	73.2	20.6	73.0	21.5	72.9	21.9	72.8	22.3	72.6	23.2
	-3.0	-3.7	77.0	20.4	76.8	21.2	76.5	22.0	76.4	22.4	76.3	22.9	76.1	23.7
	0.0	-0.7	83.0	21.3	82.8	22.1	82.6	22.8	82.5	23.2	82.4	23.6	82.2	24.4
	3.0	2.2	89.4	22.2	89.2	22.9	89.0	23.6	88.9	23.9	88.8	24.3	88.7	25.0
	5.0	4.1	93.9	22.7	93.7	23.4	93.4	24.0	93.3	24.4	93.2	24.7	93.0	25.4
	7.0	6.0	98.6	23.2	98.3	23.8	98.1	24.5	98.0	24.8	97.9	25.1	97.8	25.9
	9.0	7.9	103	23.7	103	24.3	103	24.8	103	25.1	103	25.4	103	26.0
11.0	9.8	109	24.1	108	24.7	108	25.3	108	25.6	108	25.9	108	26.6	
13.0	11.8	114	24.6	114	25.2	114	25.5	114	25.8	114	26.1	114	27.2	
15.0	13.7	119	24.6	119	25.6	119	26.0	119	26.4	119	26.8	119	27.6	
100% 83.50 kW	-19.8	-20.0	53.5	16.3	53.3	17.4	53.1	18.5	53.0	19.0	52.9	19.6	52.7	20.7
	-18.8	-19.0	54.4	16.6	54.2	17.7	54.0	18.8	53.9	19.3	53.8	19.8	53.6	20.9
	-16.7	-17.0	56.5	17.3	56.3	18.3	56.1	19.3	56.0	19.8	55.9	20.3	55.7	21.4
	-13.7	-15.0	58.8	17.9	58.6	18.9	58.4	19.9	58.3	20.4	58.2	20.9	58.0	21.8
	-11.8	-13.0	61.4	18.6	61.2	19.5	61.0	20.4	60.9	20.9	60.8	21.4	60.6	22.3
	-9.8	-11.0	64.2	19.2	64.1	20.1	63.9	21.0	63.8	21.5	63.7	21.9	63.5	22.8
	-9.5	-10.0	65.8	19.6	65.6	20.4	65.4	21.3	65.3	21.7	65.2	22.2	65.0	23.0
	-8.5	-9.1	67.2	19.8	67.0	20.7	66.8	21.6	66.7	22.0	66.6	22.4	66.4	23.3
	-7.0	-7.6	69.6	20.3	69.4	21.1	69.2	22.0	69.1	22.4	69.0	22.8	68.8	23.6
	-5.0	-5.6	73.1	20.9	72.9	21.7	72.7	22.5	72.6	22.9	72.5	23.3	72.3	24.1
	-3.0	-3.7	76.7	21.5	76.5	22.3	76.3	23.0	76.2	23.4	76.1	23.7	75.9	24.5
	0.0	-0.7	82.7	22.4	82.5	23.1	82.3	23.7	82.2	24.1	82.1	24.4	81.9	24.8
	3.0	2.2	89.1	23.1	88.9	23.8	88.7	24.4	88.6	24.7	88.5	25.0	88.3	25.4
	5.0	4.1	93.6	23.6	93.4	24.2	93.2	24.8	93.1	25.1	93.0	25.4	92.8	25.8
	7.0	6.0	98.3	24.1	98.1	24.6	97.9	25.2	97.8	25.5	97.7	25.8	97.5	26.2
	9.0	7.9	103	24.5	103	25.0	102.5	25.5	102.5	25.9	102.5	26.2	102.5	26.6
11.0	9.8	108	24.8	108	25.3	108	25.8	108	26.1	108	26.4	108	26.8	
13.0	11.8	108	23.3	108	24.8	108	25.3	108	25.8	108	26.3	108	26.8	
15.0	13.7	108	21.9	108	23.4	108	24.4	108	25.4	108	26.4	108	27.4	

NOTES - ANMERKUNGEN - Σημειώσεις - NOTAS - REMARQUES - NOTE - OPMERKINGEN - примечания - NOTLAR

- is shown as reference. When selecting the unit models, avoid the Outdoor air temperature range shown by .
 dient als Verweis. Vermeiden Sie bei der Auswahl der Gerätemodelle den als markierten Temperaturbereich der Außenluft.
 Η είναι ενδεικτική, κατά την επιλογή των μοντέλων των μονάδων, αποφύγετε το εύρος θερμοκρασίας εξωτερικού αέρα που υποδεικνύεται.
 se muestra como referencia. Cuando seleccione los modelos de unidad, evite el intervalo de temperaturas de aire exterior indicado mediante .
 est montré comme référence. Lors du choix des modèles d'unités, évitez la plage de températures de l'air extérieur illustré par .
 valori riportati unicamente come riferimento. Nel selezionare i modelli delle unità, non considerare i valori di temperatura dell'aria esterna indicati con il colore .
 is als referentie getoond. Wanneer modellen van eenheden worden gekozen, vermijd dan het bereik van buitenluchttemperaturen geïllustreerd door .
- показан как. При выборе модели устройства избегайте внешнюю температуру воздуха, указанную в .
 referans olarak gösterilmektedir. Ünite modellerini seçerken, belirtilen dış hava sıcaklığı aralığından kaçınınız .
 The above table shows the average value of conditions which may occur.
 Die obige Tabelle zeigt den Durchschnittswert der Bedingungen, die auftreten können.
 Στον παραπάνω πίνακα αναγράφεται η μέση τιμή για συνθήκες που μπορεί να προκύψουν.
 La tabla de arriba muestra el valor medio de condiciones que pueden ocurrir.
 Le tableau ci-dessus donne la valeur moyenne pour des conditions qui peuvent survenir.
 La tabella in alto mostra il valore delle condizioni medie che si possono riscontrare.
 De tabel hierboven geeft de gemiddelde waarde aan van situaties die kunnen voorvallen.
 Таблица расположенная выше показывает среднее значение условий, которые могут наступить.
 Yukarıdaki tablo meydana gelebilecek koşulların ortalama değerini göstermektedir.

3D079549

5 Таблицы производительности

5 - 2 Таблицы теплопроизводительностей

5

RXYQ30T														
Indoor air temp. °CDB														
Combination (%) (Capacity index)	Outdoor air temp.		16.0		18.0		20.0		21.0		22.0		24.0	
			TC	PI	TC	PI	TC	PI	TC	PI	TC	PI	TC	PI
	(°CDB)	(°CWB)	KW	KW	KW	KW	KW	KW	KW	KW	KW	KW	KW	KW
90% 75.15 kW	-19.8	-20.0	53.2	18.0	53.0	18.9	52.8	19.9	52.7	20.4	52.6	20.9	52.4	21.9
	-18.8	-19.0	54.1	18.2	53.9	19.2	53.8	20.2	53.7	20.6	53.6	21.1	53.4	22.1
	-16.7	-17.0	56.2	18.8	56.0	19.7	55.8	20.6	55.8	21.1	55.7	21.6	55.5	22.5
	-13.7	-15.0	58.5	19.4	58.4	20.3	58.2	21.2	58.1	21.6	58.0	22.0	57.8	22.9
	-11.8	-13.0	61.1	20.0	60.9	20.8	60.8	21.7	60.7	22.1	60.6	22.5	60.4	23.4
	-9.8	-11.0	64.0	20.6	63.8	21.4	63.6	22.2	63.5	22.6	63.4	23.0	63.2	23.8
	-9.5	-10.0	65.5	20.9	65.3	21.6	65.1	22.4	65.0	22.8	64.9	23.2	64.8	24.0
	-8.5	-9.1	66.9	21.1	66.7	21.9	66.5	22.7	66.4	23.0	66.3	23.4	66.2	24.2
	-7.0	-7.6	69.3	21.6	69.2	22.3	69.0	23.0	68.9	23.4	68.8	23.8	68.6	24.5
	-5.0	-5.6	72.8	22.1	72.7	22.8	72.5	23.5	72.4	23.9	72.3	24.2	71.2	24.4
	-3.0	-3.7	76.4	22.6	76.2	23.3	76.0	24.0	75.9	24.3	75.8	24.6	71.2	23.0
	0.0	-0.7	82.4	23.4	82.3	24.0	82.1	24.6	80.9	24.4	80.9	24.4	77.7	21.0
	3.0	2.2	88.8	24.1	88.6	24.7	84.2	23.4	80.9	22.3	77.7	21.3	71.2	19.2
	5.0	4.1	93.3	24.5	90.6	24.0	84.2	22.0	80.9	21.0	77.7	20.0	71.2	18.2
	7.0	6.0	97.1	24.6	90.6	22.6	84.2	20.8	80.9	19.8	77.7	18.9	71.2	17.2
	9.0	7.9	97.1	23.2	90.6	21.3	84.2	19.6	80.9	18.7	77.7	17.9	71.2	16.2
11.0	9.8	97.1	21.8	90.6	20.1	84.2	18.5	80.9	17.7	77.7	16.9	71.2	15.4	
13.0	11.8	97.1	20.5	90.6	19.0	84.2	17.5	80.9	16.7	77.7	16.0	71.2	14.5	
15.0	13.7	97.1	19.4	90.6	18.0	84.2	16.5	80.9	15.8	77.7	15.1	71.2	13.8	
80% 66.80 kW	-19.8	-20.0	52.9	19.6	52.7	20.5	52.5	21.3	52.5	21.8	52.4	22.2	52.2	23.1
	-18.8	-19.0	53.8	19.8	53.7	20.7	53.5	21.5	53.4	22.0	53.3	22.4	53.2	23.2
	-16.7	-17.0	55.9	20.3	55.7	21.2	55.6	22.0	55.5	22.4	55.4	22.8	55.3	23.6
	-13.7	-15.0	58.2	20.9	58.1	21.6	57.9	22.4	57.8	22.8	57.8	23.2	57.6	24.0
	-11.8	-13.0	60.8	21.4	60.7	22.1	60.5	22.9	60.4	23.3	60.4	23.6	60.2	24.4
	-9.8	-11.0	63.7	21.9	63.5	22.6	63.3	23.3	63.3	23.7	63.2	24.1	63.0	24.8
	-9.5	-10.0	65.2	22.2	65.0	22.9	64.9	23.6	64.8	23.9	64.7	24.3	63.3	24.2
	-8.5	-9.1	66.6	22.4	66.4	23.1	66.3	23.8	66.2	24.1	66.1	24.5	63.3	23.6
	-7.0	-7.6	69.0	22.8	68.9	23.4	68.7	24.1	68.6	24.4	68.6	24.8	63.3	22.6
	-5.0	-5.6	72.5	23.3	72.4	23.9	72.2	24.5	71.9	24.7	69.0	23.6	63.3	21.2
	-3.0	-3.7	76.1	23.7	75.9	24.3	74.8	24.4	71.9	23.3	69.0	22.2	63.3	20.1
	0.0	-0.7	82.1	24.4	80.6	24.3	74.8	22.3	71.9	21.2	69.0	20.3	63.3	18.3
	3.0	2.2	86.3	24.1	80.6	22.2	74.8	20.3	71.9	19.4	69.0	18.6	63.3	16.8
	5.0	4.1	86.3	22.7	80.6	20.9	74.8	19.2	71.9	18.4	69.0	17.5	63.3	15.9
	7.0	6.0	86.3	21.4	80.6	19.7	74.8	18.1	71.9	17.3	69.0	16.6	63.3	15.1
	9.0	7.9	86.3	20.2	80.6	18.6	74.8	17.1	71.9	16.4	69.0	15.7	63.3	14.3
11.0	9.8	86.3	19.0	80.6	17.6	74.8	16.2	71.9	15.5	69.0	14.9	63.3	13.6	
13.0	11.8	86.3	18.0	80.6	16.6	74.8	15.3	71.9	14.7	69.0	14.1	63.3	12.8	
15.0	13.7	86.3	17.0	80.6	15.8	74.8	14.5	71.9	13.9	69.0	13.4	63.3	12.2	
70% 58.45 kW	-19.8	-20.0	52.6	21.2	52.4	22.0	52.3	22.7	52.2	23.1	52.2	23.5	52.0	24.3
	-18.8	-19.0	53.5	21.4	53.4	22.2	53.2	22.9	53.2	23.3	53.1	23.7	53.0	24.4
	-16.7	-17.0	55.6	21.9	55.5	22.6	55.3	23.3	55.3	23.7	55.2	24.0	55.1	24.7
	-13.7	-15.0	57.9	22.3	57.8	23.0	57.7	23.7	57.6	24.1	57.5	24.4	55.4	23.7
	-11.8	-13.0	60.5	22.8	60.4	23.5	60.3	24.1	60.2	24.4	60.1	24.8	55.4	22.5
	-9.8	-11.0	63.4	23.3	63.2	23.9	63.1	24.5	62.9	24.8	60.4	23.6	55.4	21.3
	-9.5	-10.0	64.9	23.5	64.7	24.1	64.6	24.7	62.9	24.1	60.4	22.9	55.4	20.7
	-8.5	-9.1	66.3	23.7	66.1	24.3	66.0	24.6	62.9	23.4	60.4	22.3	55.4	20.2
	-7.0	-7.6	68.7	24.0	68.6	24.6	68.5	23.5	62.9	22.4	60.4	21.4	55.4	19.3
	-5.0	-5.6	72.2	24.5	70.5	24.1	69.5	22.1	62.9	21.1	60.4	20.1	55.4	18.2
	-3.0	-3.7	75.5	24.7	70.5	22.8	69.5	20.9	62.9	19.9	60.4	19.0	55.4	17.2
	0.0	-0.7	75.5	22.5	70.5	20.8	69.5	19.1	62.9	18.2	60.4	17.4	55.4	15.8
	3.0	2.2	75.5	20.6	70.5	19.0	69.5	17.5	62.9	16.7	60.4	16.0	55.4	14.5
	5.0	4.1	75.5	19.4	70.5	17.9	69.5	16.5	62.9	15.8	60.4	15.1	55.4	13.8
	7.0	6.0	75.5	18.3	70.5	17.0	69.5	15.6	62.9	15.0	60.4	14.3	55.4	13.1
	9.0	7.9	75.5	17.3	70.5	16.1	69.5	14.8	62.9	14.2	60.4	13.6	55.4	12.4
11.0	9.8	75.5	16.4	70.5	15.2	69.5	14.0	62.9	13.5	60.4	12.9	55.4	11.8	
13.0	11.8	75.5	15.5	70.5	14.4	69.5	13.3	62.9	12.8	60.4	12.2	55.4	11.2	
15.0	13.7	75.5	14.7	70.5	13.7	69.5	12.6	62.9	12.1	60.4	11.6	55.4	10.7	
60% 50.10 kW	-19.8	-20.0	52.3	22.9	52.2	23.5	52.0	24.2	52.0	24.5	51.8	24.7	47.5	22.3
	-18.8	-19.0	53.2	23.0	53.1	23.7	53.0	24.3	52.9	24.6	51.8	24.2	47.5	21.8
	-16.7	-17.0	55.3	23.4	55.2	24.0	55.1	24.6	53.9	24.2	51.8	23.0	47.5	20.8
	-13.7	-15.0	57.7	23.8	57.5	24.4	56.1	24.1	53.9	23.0	51.8	21.9	47.5	19.8
	-11.8	-13.0	60.2	24.2	60.1	24.8	56.1	22.8	53.9	21.8	51.8	20.8	47.5	18.8
	-9.8	-11.0	63.1	24.6	60.4	23.6	56.1	21.6	53.9	20.6	51.8	19.7	47.5	17.8
	-9.5	-10.0	64.6	24.8	60.4	22.9	56.1	21.0	53.9	20.1	51.8	19.1	47.5	17.3
	-8.5	-9.1	64.7	24.2	60.4	22.3	56.1	20.5	53.9	19.6	51.8	18.7	47.5	16.9
	-7.0	-7.6	64.7	23.2	60.4	21.4	56.1	19.6	53.9	18.7	51.8	17.9	47.5	16.2
	-5.0	-5.6	64.7	21.8	60.4	20.1	56.1	18.5	53.9	17.7	51.8	16.9	47.5	15.4
	-3.0	-3.7	64.7	20.6	60.4	19.0	56.1	17.5	53.9	16.7	51.8	16.0	47.5	14.6
	0.0	-0.7	64.7	18.8	60.4	17.4	56.1	16.0	53.9	15.4	51.8	14.7	47.5	13.4
	3.0	2.2	64.7	17.3	60.4	16.0	56.1	14.8	53.9	14.1	51.8	13.5	47.5	12.4
	5.0	4.1	64.7	16.3	60.4	15.1	56.1	14.0	53.9	13.4	51.8	12.9	47.5	11.8
	7.0	6.0	64.7	15.4	60.4	14.3	56.1	13.3	53.9	12.7	51.8	12.2	47.5	11.2
	9.0	7.9	64.7	14.6	60.4	13.6	56.1	12.6	53.9	12.1	51.8	11.6	47.5	10.6
11.0	9.8	64.7	13.9	60.4	12.9	56.1	12.0	53.9	11.5	51.8	11.0	47.5	10.1	
13.0	11.8	64.7	13.1	60.4	12.2	56.1	11.4	53.9	10.9	51.8	10.5	47.5	9.6	
15.0	13.7	64.7	12.5	60.4	11.6	56.1	10.8	53.9	10.4	51.8	10.0	47.5	9.2	
50% 41.75 kW	-19.8	-20.0	52.0	24.5	50.3	23.9	46.8	21.9	45.0	20.9	43.2	19.9	39.6	18.0
	-18.8	-19.0	52.9	24.6	50.3	23.4	46.8	21.4	45.0	20.4	43.2	19.5	39.6	17.7
	-16.7	-17.0	53.9	24.2	50.3	22.3	46.8	20.4	45.0	19.5	43.2	18.6	39.6	16.9
	-13.7	-15.0	53.9	23.0	50.3	21.2	46.8	19.5	45.0	18.6	43.2	17.8	39.6	16.1
	-11.8	-13.0	53.9	21.8	50.3	20.1	46.8	18.5	45.0	17.7	43.2	16.9	39.6	15.3
	-9.8	-11.0	53.9	20.6	50.3	19.1	46.8	17.5	45.0	16.8	43.2	16.0	39.6	14.6
	-9.5	-10.0	53.9	20.1	50.3	18.5	46.8	17.1	45.0	16.3	43.2	15.6	39.6	14.2
	-8.5	-9.1	53.9	19.6	50.3	18.1	46.8	16.6	45.0	15.9	43.2	15.2	39.6	13.9
	-7.0	-7.6	53.9	18.7	50.3	17.3	46.8	16.0	45.0	15.3	43.2	14.6	39.6	13.3
	-5.0	-5.6	53.9	17.7	50.3	16.4	46.8	15.1	45.0	14.5	43.2	13.9	39.6	12.7
	-3.0	-3.7	53.9	16.7	50.3	15.5	46.8	14.3	45.0	13.7	43.2	13.2	39.6	12.0
	0.0	-0.7	53.9	15.4	50.3	14.3	46.8	13.2	45.0	12.7	43.2	12.1		

5 Таблицы производительности

5 - 2 Таблицы теплопроизводительностей

RXYQ32T		Indoor air temp. °CDB												
Combination(%) (Capacity index)	Outdoor air temp.		16.0		18.0		20.0		21.0		22.0		24.0	
	(°CDB)	(°CWB)	TC	PI	TC	PI	TC	PI	TC	PI	TC	PI	TC	PI
130% 117.00 kW	-19.8	-20.0	58.8	13.0	58.6	14.5	58.3	16.1	58.2	16.8	58.0	17.59	57.8	19.13
	-18.8	-19.0	59.9	13.4	59.6	14.9	59.4	16.4	59.2	17.2	59.1	17.94	58.8	19.45
	-16.7	-17.0	62.2	14.3	61.9	15.8	61.6	17.2	61.5	17.9	61.4	18.66	61.1	20.11
	-13.7	-15.0	64.8	15.2	64.5	16.6	64.2	18.0	64.1	18.7	63.9	19.4	63.7	20.8
	-11.8	-13.0	67.6	16.2	67.3	17.5	67.0	18.8	66.9	19.5	66.7	20.1	66.5	21.5
	-9.8	-11.0	70.6	17.1	70.4	18.4	70.1	19.6	70.0	20.2	69.8	20.9	69.5	22.1
	-9.5	-10.0	72.3	17.5	72.0	18.8	71.7	20.0	71.6	20.6	71.5	21.2	71.2	22.5
	-8.5	-9.1	73.8	18.0	73.5	19.2	73.3	20.4	73.1	21.0	73.0	21.6	72.7	22.8
	-7.0	-7.6	76.5	18.6	76.2	19.8	75.9	20.9	75.8	21.5	75.6	22.1	75.4	23.3
	-5.0	-5.6	80.2	19.5	80.0	20.6	79.7	21.7	79.5	22.3	79.4	22.8	79.1	23.9
	-3.0	-3.7	84.1	20.3	83.8	21.3	83.5	22.4	83.4	22.9	83.2	23.4	83.0	24.5
	0.0	-0.7	90.6	21.5	90.3	22.5	90.0	23.4	89.9	23.9	89.7	24.4	89.5	25.4
	3.0	2.2	97.4	22.6	97.1	23.5	96.9	24.4	96.7	24.8	96.6	25.3	96.3	26.2
	5.0	4.1	102.2	23.2	101.9	24.1	101.6	24.9	101.5	25.4	101.4	25.8	101.1	26.7
	7.0	6.0	107	23.9	107	24.7	107	25.5	107	25.9	106	26.3	106	27.1
	9.0	7.9	112	24.5	112	25.2	112	26.0	112	26.4	112	26.8	110	27.0
	11.0	9.8	118	25.0	118	25.8	117	26.5	117	26.9	117	27.3	110	27.5
13.0	11.8	124	25.6	124	26.3	123	27.0	123	27.4	120	26.6	110	24.0	
15.0	13.7	130	26.1	130	26.8	129	27.4	125	26.4	120	25.1	110	22.7	
120% 108.00 kW	-19.8	-20.0	58.5	14.8	58.3	16.2	58.0	17.6	57.9	18.3	57.8	19.0	57.5	20.4
	-18.8	-19.0	59.6	15.2	59.3	16.6	59.1	17.9	59.0	18.6	58.8	19.3	58.6	20.7
	-16.7	-17.0	61.9	16.0	61.6	17.3	61.4	18.7	61.2	19.3	61.1	20.0	60.9	21.3
	-13.7	-15.0	64.4	16.8	64.2	18.1	63.9	19.4	63.8	20.0	63.7	20.7	63.4	22.0
	-11.8	-13.0	67.3	17.7	67.0	18.9	66.7	20.1	66.6	20.8	66.5	21.4	66.2	22.6
	-9.8	-11.0	70.3	18.5	70.1	19.7	69.8	20.9	69.7	21.5	69.6	22.0	69.3	23.2
	-9.5	-10.0	72.0	19.0	71.7	20.1	71.5	21.2	71.3	21.8	71.2	22.4	70.9	23.5
	-8.5	-9.1	73.5	19.3	73.2	20.5	73.0	21.6	72.9	22.1	72.7	22.7	72.5	23.8
	-7.0	-7.6	76.1	20.0	75.9	21.0	75.6	22.1	75.5	22.6	75.4	23.2	75.1	24.3
	-5.0	-5.6	79.9	20.8	79.7	21.8	79.4	22.8	79.3	23.3	79.2	23.8	78.9	24.8
	-3.0	-3.7	83.7	21.5	83.5	22.5	83.2	23.4	83.1	23.9	83.0	24.4	82.7	25.4
	0.0	-0.7	90.2	22.6	90.0	23.5	89.7	24.4	89.6	24.9	89.5	25.3	89.2	26.2
	3.0	2.2	97.1	23.6	96.8	24.4	96.6	25.3	96.5	25.7	96.3	26.1	96.1	26.9
	5.0	4.1	101.9	24.2	101.6	25.0	101.4	25.8	101.2	26.2	101.1	26.6	100.9	27.4
	7.0	6.0	107	24.8	107	25.6	106	26.3	106	26.7	106	27.1	102	26.1
	9.0	7.9	112	25.4	112	26.1	112	26.8	112	27.2	111	27.3	102	24.6
	11.0	9.8	118	25.9	117	26.6	117	27.3	115	27.0	111	25.7	102	23.2
13.0	11.8	124	26.4	123	27.1	120	26.6	115	25.4	111	24.2	102	21.9	
15.0	13.7	130	26.9	129	27.5	120	25.1	115	24.0	111	22.9	102	20.7	
110% 99.00 kW	-19.8	-20.0	58.2	16.5	58.0	17.8	57.8	19.1	57.6	19.8	57.5	20.4	57.3	21.7
	-18.8	-19.0	59.3	16.9	59.0	18.2	58.8	19.4	58.7	20.1	58.6	20.7	58.3	22.0
	-16.7	-17.0	61.6	17.7	61.3	18.9	61.1	20.1	61.0	20.7	60.9	21.3	60.6	22.6
	-13.7	-15.0	64.1	18.4	63.9	19.6	63.7	20.8	63.5	21.4	63.4	22.0	63.2	23.1
	-11.8	-13.0	66.9	19.2	66.7	20.3	66.5	21.5	66.4	22.0	66.2	22.6	66.0	23.7
	-9.8	-11.0	70.0	20.0	69.8	21.1	69.5	22.1	69.4	22.7	69.3	23.2	69.1	24.3
	-9.5	-10.0	71.6	20.4	71.4	21.4	71.2	22.5	71.1	23.0	70.9	23.5	70.7	24.6
	-8.5	-9.1	73.2	20.7	72.9	21.8	72.7	22.8	72.6	23.3	72.5	23.8	72.2	24.8
	-7.0	-7.6	75.8	21.3	75.6	22.3	75.4	23.3	75.2	23.8	75.1	24.3	74.9	25.2
	-5.0	-5.6	79.6	22.0	79.4	23.0	79.1	23.9	79.0	24.4	78.9	24.8	78.7	25.8
	-3.0	-3.7	83.4	22.7	83.2	23.6	83.0	24.5	82.8	24.9	82.7	25.4	82.5	26.3
	0.0	-0.7	89.9	23.7	89.7	24.6	89.5	25.4	89.4	25.8	89.2	26.2	89.0	27.0
	3.0	2.2	96.8	24.6	96.5	25.4	96.3	26.2	96.2	26.6	96.1	26.9	93.1	26.5
	5.0	4.1	101.6	25.2	101.3	25.9	101.1	26.7	101.0	27.0	100.9	27.4	93.1	24.9
	7.0	6.0	107	25.7	106	26.4	106	27.1	106	27.4	102	26.1	93.1	23.5
	9.0	7.9	112	26.3	112	26.9	110	27.0	106	25.8	102	24.6	93.1	22.2
	11.0	9.8	117	26.7	117	27.4	110	25.5	106	24.3	102	23.2	93.1	21.0
13.0	11.8	123	27.2	118	26.2	110	24.0	106	22.9	102	21.9	93.1	19.8	
15.0	13.7	127	26.9	118	24.7	110	22.7	106	21.7	102	20.7	93.1	18.7	
100% 90.00 kW	-19.8	-20.0	57.9	18.3	57.7	19.5	57.5	20.7	57.4	21.3	57.3	21.8	57.1	23.0
	-18.8	-19.0	59.0	18.6	58.7	19.8	58.5	21.0	58.4	21.5	58.3	22.1	58.1	23.3
	-16.7	-17.0	61.2	19.3	61.0	20.4	60.8	21.6	60.7	22.1	60.6	22.7	60.4	23.8
	-13.7	-15.0	63.8	20.0	63.6	21.1	63.4	22.2	63.3	22.7	63.2	23.2	63.0	24.3
	-11.8	-13.0	66.6	20.8	66.4	21.8	66.2	22.8	66.1	23.3	66.0	23.8	65.8	24.8
	-9.8	-11.0	69.7	21.5	69.5	22.4	69.3	23.4	69.2	23.9	69.1	24.4	68.9	25.4
	-9.5	-10.0	71.3	21.8	71.1	22.8	70.9	23.7	70.8	24.2	70.7	24.7	70.5	25.6
	-8.5	-9.1	72.9	22.1	72.6	23.1	72.4	24.0	72.3	24.5	72.2	24.9	72.0	25.8
	-7.0	-7.6	75.5	22.6	75.3	23.5	75.1	24.4	75.0	24.9	74.9	25.3	74.7	26.2
	-5.0	-5.6	79.3	23.3	79.1	24.2	78.9	25.0	78.8	25.4	78.7	25.9	78.4	26.7
	-3.0	-3.7	83.1	23.9	82.9	24.7	82.7	25.6	82.6	26.0	82.5	26.4	82.3	27.2
	0.0	-0.7	89.6	24.9	89.4	25.6	89.2	26.4	89.1	26.7	89.0	27.1	84.6	25.9
	3.0	2.2	96.5	25.7	96.3	26.4	96.0	27.1	95.9	27.4	92.3	26.2	84.6	23.6
	5.0	4.1	101.2	26.2	101.0	26.9	100.0	27.2	96.2	25.9	92.3	24.7	84.6	22.3
	7.0	6.0	106	26.7	106	27.3	100	25.6	96.2	24.4	92.3	23.3	84.6	21.1
	9.0	7.9	112	27.2	108	26.4	100	24.1	96.2	23.1	92.3	22.0	84.6	19.9
	11.0	9.8	115	27.0	108	24.9	100	22.8	96.2	21.8	92.3	20.8	84.6	18.8
13.0	11.8	115	25.4	108	23.4	100	21.5	96.2	20.5	92.3	19.6	84.6	17.8	
15.0	13.7	115	24.0	108	22.1	100	20.3	96.2	19.4	92.3	18.6	84.6	16.9	

NOTES - ANMERKUNGEN - Σημειώσεις - NOTAS - REMARQUES - NOTE - OPMERKINGEN - примечания - NOTLAR

1. [] is shown as reference. When selecting the unit models, avoid the Outdoor air temperature range shown by [].
 dient als Verweis. Vermeiden Sie bei der Auswahl der Gerätemodelle den als markierten Temperaturbereich der Außenluft.
 Η [] είναι ενδεικτική, κατά την επιλογή των μοντέλων των μονάδων, αποφεύγετε το εύρος θερμοκρασίας εξωτερικού αέρα που υποδεικνύεται [].
 se muestra como referencia. Cuando seleccione los modelos de unidad, evite el intervalo de temperaturas del aire exterior indicado mediante [].
 est montré comme référence. Lors du choix des modèles d'unités, évitez la plage de températures de l'air extérieur illustré par [].
 valori riportati unicamente come riferimento. Nel selezionare i modelli delle unità, non considerare i valori di temperatura dell'aria esterna indicati con il colore [].
 is als referentie getoond. Wanneer modellen van eenheden worden gekozen, vermijd dan het bereik van buitenluchttemperaturen geïllustreerd door [].

2. The above table shows the average value of conditions which may occur.
 Die obige Tabelle zeigt den Durchschnittswert der Bedingungen, die auftreten können.
 Στον παραπάνω πίνακα αναγράφεται η μέση τιμή για συνθήκες που μπορεί να προκύψουν.
 La tabla de arriba muestra el valor medio de condiciones que pueden ocurrir.
 Le tableau ci-dessus donne la valeur moyenne pour des conditions qui peuvent survenir.
 La tabella in alto mostra il valore delle condizioni medie che si possono riscontrare.
 De tabel hierboven geeft de gemiddelde waarde aan van situaties die kunnen voorvallen.
 Таблица расположенная выше показывает среднее значение условий, которые могут наступить.
 Yukarıdaki tablo meydana gelebilecek koşulların ortalama değerini göstermektedir.

5 Таблицы производительности

5 - 2 Таблицы теплопроизводительностей

5

RXYQ32T														
Indoor air temp. °CDB														
Combination(%) (Capacity index)	Outdoor air temp.		16.0		18.0		20.0		21.0		22.0		24.0	
			TC	PI	TC	PI	TC	PI	TC	PI	TC	PI	TC	PI
	(°CDB)	(°CWB)	KW	KW	KW	KW	KW	KW	KW	KW	KW	KW	KW	KW
90% 81.00 kW	-19.8	-20.0	57.6	20.1	57.4	21.1	57.2	22.2	57.1	22.7	57.0	23.3	56.8	24.3
	-18.8	-19.0	58.6	20.4	58.4	21.4	58.3	22.5	58.2	23.0	58.1	23.5	57.9	24.5
	-16.7	-17.0	60.9	21.0	60.7	22.0	60.6	23.0	60.5	23.5	60.4	24.0	60.2	25.0
	-13.7	-15.0	63.5	21.6	63.3	22.6	63.1	23.6	63.0	24.0	62.9	24.5	62.7	25.5
	-11.8	-13.0	66.3	22.3	66.1	23.2	65.9	24.1	65.8	24.6	65.7	25.0	65.5	25.9
	-9.8	-11.0	69.4	22.9	69.2	23.8	69.0	24.7	68.9	25.1	68.8	25.5	68.6	26.4
	-9.5	-10.0	71.0	23.2	70.8	24.1	70.6	24.9	70.5	25.4	70.4	25.8	70.3	26.7
	-8.5	-9.1	72.5	23.5	72.3	24.4	72.2	25.2	72.1	25.6	72.0	26.0	71.8	26.9
	-7.0	-7.6	75.2	24.0	75.0	24.8	74.8	25.6	74.7	26.0	74.6	26.4	74.4	27.2
	-5.0	-5.6	79.0	24.6	78.8	25.4	78.6	26.1	78.5	26.5	78.4	26.9	78.2	26.5
	-3.0	-3.7	82.8	25.1	82.6	25.9	82.4	26.6	82.3	27.0	82.2	27.3	82.1	25.0
	0.0	-0.7	89.3	26.0	89.1	26.7	88.9	27.3	88.5	26.6	88.1	25.3	87.2	22.8
	3.0	2.2	96.1	26.7	96.0	27.4	90.0	25.4	86.5	24.3	83.1	23.1	76.2	20.9
	5.0	4.1	100.9	27.2	96.9	26.2	90.0	24.0	86.5	22.9	83.1	21.8	76.2	19.8
	7.0	6.0	104	26.8	96.9	24.7	90.0	22.6	86.5	21.6	83.1	20.6	76.2	18.7
	9.0	7.9	104	25.2	96.9	23.3	90.0	21.4	86.5	20.4	83.1	19.5	76.2	17.7
11.0	9.8	104	23.8	96.9	22.0	90.0	20.2	86.5	19.3	83.1	18.4	76.2	16.8	
13.0	11.8	104	22.4	96.9	20.7	90.0	19.1	86.5	18.2	83.1	17.4	76.2	15.9	
15.0	13.7	104	21.2	96.9	19.6	90.0	18.1	86.5	17.3	83.1	16.5	76.2	15.1	
80% 72.00 kW	-19.8	-20.0	57.3	21.8	57.1	22.8	56.9	23.7	56.8	24.2	56.8	24.7	56.6	25.6
	-18.8	-19.0	58.3	22.1	58.2	23.0	58.0	24.0	57.9	24.4	57.8	24.9	57.6	25.8
	-16.7	-17.0	60.6	22.7	60.4	23.6	60.3	24.4	60.2	24.9	60.1	25.3	59.9	26.2
	-13.7	-15.0	63.2	23.2	63.0	24.1	62.8	24.9	62.8	25.4	62.7	25.8	62.5	26.6
	-11.8	-13.0	66.0	23.8	65.8	24.6	65.7	25.4	65.6	25.8	65.5	26.3	65.3	27.1
	-9.8	-11.0	69.1	24.4	68.9	25.2	68.7	25.9	68.6	26.3	68.6	26.7	68.4	27.1
	-9.5	-10.0	70.7	24.7	70.5	25.4	70.4	26.2	70.3	26.6	70.2	26.9	70.1	26.3
	-8.5	-9.1	72.2	24.9	72.1	25.7	71.9	26.4	71.8	26.8	71.7	27.1	71.6	25.6
	-7.0	-7.6	74.9	25.3	74.7	26.0	74.5	26.8	74.5	27.1	74.4	27.2	74.3	24.5
	-5.0	-5.6	78.7	25.9	78.5	26.5	78.3	27.2	78.2	27.6	78.1	27.9	78.0	23.1
	-3.0	-3.7	82.5	26.4	82.3	27.0	82.0	26.5	81.9	25.3	81.8	24.1	81.7	21.8
	0.0	-0.7	89.0	27.1	88.2	26.4	88.0	24.2	87.9	23.1	87.8	22.0	87.7	19.9
	3.0	2.2	92.3	26.2	92.2	24.1	92.0	22.1	91.9	21.2	91.8	20.2	91.7	18.3
	5.0	4.1	92.3	24.7	92.2	22.8	92.0	20.9	91.9	20.0	91.8	19.1	91.7	17.3
	7.0	6.0	92.3	23.3	92.2	21.5	92.0	19.8	91.9	18.9	91.8	18.1	91.7	16.4
	9.0	7.9	92.3	22.0	92.2	20.3	92.0	18.7	91.9	17.9	91.8	17.1	91.7	15.6
11.0	9.8	92.3	20.8	92.2	19.2	92.0	17.7	91.9	17.0	91.8	16.2	91.7	14.8	
13.0	11.8	92.3	19.6	92.2	18.1	92.0	16.7	91.9	16.0	91.8	15.4	91.7	14.0	
15.0	13.7	92.3	18.6	92.2	17.2	92.0	15.9	91.9	15.2	91.8	14.6	91.7	13.3	
70% 63.00 kW	-19.8	-20.0	57.0	23.6	56.8	24.4	56.7	25.3	56.6	25.7	56.5	26.1	56.4	26.9
	-18.8	-19.0	58.0	23.8	57.9	24.7	57.7	25.5	57.6	25.9	57.6	26.3	57.4	27.1
	-16.7	-17.0	60.3	24.3	60.2	25.1	60.0	25.9	59.9	26.3	59.9	26.7	59.2	27.1
	-13.7	-15.0	62.9	24.8	62.7	25.6	62.6	26.3	62.5	26.7	62.4	27.1	62.2	25.7
	-11.8	-13.0	65.7	25.3	65.5	26.1	65.4	26.8	65.3	27.1	65.2	27.1	65.1	24.4
	-9.8	-11.0	68.7	25.8	68.6	26.5	68.5	27.2	68.4	27.6	68.3	27.6	68.2	23.1
	-9.5	-10.0	70.4	26.1	70.2	26.8	70.0	27.4	69.9	26.1	69.8	24.9	69.7	22.4
	-8.5	-9.1	71.9	26.3	71.8	27.0	71.7	27.6	71.6	27.9	71.5	27.9	71.4	21.9
	-7.0	-7.6	74.6	26.7	74.4	27.3	74.3	28.0	74.2	28.3	74.1	28.3	74.0	21.0
	-5.0	-5.6	78.3	27.1	78.1	27.8	78.0	28.5	77.9	27.8	77.8	27.1	77.7	19.8
	-3.0	-3.7	80.8	26.9	80.6	27.4	80.5	27.7	80.4	27.7	80.3	27.7	80.2	18.7
	0.0	-0.7	80.8	24.5	80.6	22.6	80.5	20.7	80.4	19.8	80.3	18.9	80.2	17.2
	3.0	2.2	80.8	22.4	80.6	20.7	80.5	19.0	80.4	18.2	80.3	17.4	80.2	15.8
	5.0	4.1	80.8	21.1	80.6	19.5	80.5	18.0	80.4	17.2	80.3	16.5	80.2	15.0
	7.0	6.0	80.8	20.0	80.6	18.5	80.5	17.0	80.4	16.3	80.3	15.6	80.2	14.3
	9.0	7.9	80.8	18.9	80.6	17.5	80.5	16.1	80.4	15.5	80.3	14.8	80.2	13.5
11.0	9.8	80.8	17.9	80.6	16.6	80.5	15.3	80.4	14.7	80.3	14.1	80.2	12.9	
13.0	11.8	80.8	16.9	80.6	15.7	80.5	14.5	80.4	13.9	80.3	13.4	80.2	12.2	
15.0	13.7	80.8	16.0	80.6	14.9	80.5	13.8	80.4	13.3	80.3	12.7	80.2	11.7	
60% 54.00 kW	-19.8	-20.0	56.6	25.4	56.5	26.1	56.4	26.8	56.3	27.2	56.2	26.8	56.1	24.2
	-18.8	-19.0	57.7	25.6	57.6	26.3	57.4	27.0	57.3	27.3	57.2	26.2	57.1	23.7
	-16.7	-17.0	60.0	26.0	59.9	26.7	59.7	27.3	59.6	27.6	59.5	26.0	59.4	22.6
	-13.7	-15.0	62.5	26.4	62.4	27.1	62.3	27.8	62.2	28.1	62.1	27.1	62.0	21.5
	-11.8	-13.0	65.4	26.9	65.3	27.6	65.2	28.3	65.1	28.6	65.0	27.6	64.9	20.4
	-9.8	-11.0	68.4	27.3	68.3	28.0	68.2	28.7	68.1	29.0	68.0	28.0	67.9	19.3
	-9.5	-10.0	69.2	27.0	69.1	27.7	69.0	28.4	68.9	27.7	68.8	26.7	68.7	18.8
	-8.5	-9.1	69.2	26.3	69.1	24.2	69.0	22.2	68.9	21.2	68.8	20.3	68.7	18.4
	-7.0	-7.6	69.2	25.1	69.1	23.2	69.0	21.3	68.9	20.3	68.8	19.4	68.7	17.6
	-5.0	-5.6	69.2	23.7	69.1	21.9	69.0	20.1	68.9	19.2	68.8	18.4	68.7	16.7
	-3.0	-3.7	69.2	22.4	69.1	20.7	69.0	19.0	68.9	18.2	68.8	17.4	68.7	15.8
	0.0	-0.7	69.2	20.5	69.1	18.9	69.0	17.4	68.9	16.7	68.8	16.0	68.7	14.6
	3.0	2.2	69.2	18.8	69.1	17.4	69.0	16.1	68.9	15.4	68.8	14.7	68.7	13.5
	5.0	4.1	69.2	17.8	69.1	16.5	69.0	15.2	68.9	14.6	68.8	14.0	68.7	12.8
	7.0	6.0	69.2	16.8	69.1	15.6	69.0	14.4	68.9	13.9	68.8	13.3	68.7	12.2
	9.0	7.9	69.2	16.0	69.1	14.8	69.0	13.7	68.9	13.2	68.8	12.6	68.7	11.6
11.0	9.8	69.2	15.1	69.1	14.1	69.0	13.0	68.9	12.5	68.8	12.0	68.7	11.1	
13.0	11.8	69.2	14.3	69.1	13.4	69.0	12.4	68.9	11.9	68.8	11.4	68.7	10.5	
15.0	13.7	69.2	13.6	69.1	12.7	69.0	11.8	68.9	11.4	68.8	10.9	68.7	10.1	
50% 45.00 kW	-19.8	-20.0	56.3	27.2	56.2	27.9	56.1	28.6	56.0	28.9	55.9	28.5	55.8	27.5
	-18.8	-19.0	57.4	27.3	57.3	28.0	57.2	28.7	57.1	29.0	57.0	28.6	56.9	27.6
	-16.7	-17.0	59.7	27.8	59.6	28.5	59.5	29.2	59.4	29.5	59.3	29.0	59.2	28.1
	-13.7	-15.0	62.1	28.2	62.0	28.9	61.9	29.6	61.8	30.0	61.7	29.5	61.6	28.6
	-11.8	-13.0	64.5	28.6	64.4	29.3	64.3	30.0	64.2	30.4	64.1	29.9	64.0	28.7
	-9.8	-11.0	67.0	29.0	66.9	29.7	66.8	30.4	66.7	30.8	66.6	30.3	66.5	29.8
	-9.5	-10.0	67.7	28.7	67.6	29.4	67.5	30.1	67.4	30.5	67.3	30.0	67.2	29.3
	-8.5	-9.1	68.4	28.4	68.3	29.1	68.2	29.8	68.1	30.2	68.0	29.7	67.9	28.6
	-7.0	-7.6	70.9	28.8	70.8	29.5	70.7	30.2	70.6	30.6	70.5	30.1	70.4	29.1
	-5.0	-5.6	73.4	29.2	73.3	30.0	73.2	30.7	73.1	31.1	73.0	30.6	72.9	28.1
	-3.0	-3.7	75.9	29.6	75.8	30.4	75.7	31.1	75.6	31.5	75.5	31.0	75.4	27.1
	0.0	-0.7	83.4	30.0	83.3	30.7	83.2	31.4	83.1	31.8	83.0	31.3		

5 Таблицы производительности

5 - 2 Таблицы теплопроизводительностей

RXYQ34T		Indoor air temp. °CDB												
Combination(%) (Capacity index)	Outdoor air temp.		16.0		18.0		20.0		21.0		22.0		24.0	
	(°CDB)	(°CWB)	TC	PI	TC	PI	TC	PI	TC	PI	TC	PI	TC	PI
			KW	KW	KW	KW	KW	KW	KW	KW	KW	KW	KW	KW
130% 123.50 kW	-19.8	-20.0	62.2	13.7	61.9	15.3	61.6	16.9	61.5	17.7	61.3	18.5	61.0	20.2
	-18.8	-19.0	63.3	14.1	63.0	15.7	62.7	17.3	62.6	18.1	62.4	18.9	62.1	20.5
	-16.7	-17.0	65.7	15.1	65.4	16.6	65.2	18.1	65.0	18.9	64.9	19.7	64.6	21.2
	-13.7	-15.0	68.4	16.0	68.1	17.5	67.9	19.0	67.7	19.7	67.6	20.5	67.3	21.9
	-11.8	-13.0	71.4	17.0	71.1	18.4	70.8	19.8	70.7	20.6	70.5	21.3	70.2	22.7
	-9.8	-11.0	74.7	18.0	74.4	19.4	74.1	20.7	73.9	21.4	73.8	22.0	73.5	23.4
	-9.5	-10.0	76.4	18.5	76.1	19.8	75.8	21.1	75.7	21.8	75.5	22.4	75.2	23.7
	-8.5	-9.1	78.0	18.9	77.7	20.2	77.4	21.5	77.3	22.1	77.1	22.8	76.8	24.1
	-7.0	-7.6	80.8	19.6	80.5	20.9	80.2	22.1	80.1	22.7	79.9	23.3	79.6	24.6
	-5.0	-5.6	84.8	20.6	84.5	21.7	84.2	22.9	84.1	23.5	83.9	24.1	83.6	25.3
	-3.0	-3.7	88.8	21.4	88.5	22.5	88.2	23.6	88.1	24.2	88.0	24.8	87.7	25.9
	0.0	-0.7	96	22.7	95	23.7	95	24.8	95	25.3	95	25.8	95	26.8
	3.0	2.2	103	23.8	103	24.8	102	25.7	102	26.2	102	26.7	102	27.7
	5.0	4.1	108	24.5	108	25.5	107	26.4	107	26.8	107	27.3	107	28.2
	7.0	6.0	113	25.2	113	26.1	113	26.9	113	27.4	112	27.8	112	28.7
	9.0	7.9	119	25.8	119	26.7	118	27.5	118	27.9	118	28.3	117	28.7
11.0	9.8	125	26.5	124	27.2	124	28.0	124	28.4	124	28.8	117	27.1	
13.0	11.8	131	27.1	131	27.8	130	28.5	130	28.9	127	28.3	117	25.5	
15.0	13.7	137	27.6	137	28.3	137	29.0	133	28.0	127	26.7	117	24.1	
120% 114.00 kW	-19.8	-20.0	61.9	15.5	61.6	17.0	61.3	18.5	61.2	19.3	61.1	20.1	60.8	21.6
	-18.8	-19.0	63.0	16.0	62.7	17.4	62.4	18.9	62.3	19.7	62.2	20.4	61.9	21.9
	-16.7	-17.0	65.4	16.8	65.1	18.3	64.9	19.7	64.7	20.4	64.6	21.1	64.3	22.5
	-13.7	-15.0	68.1	17.7	67.8	19.1	67.6	20.5	67.4	21.1	67.3	21.8	67.0	23.2
	-11.8	-13.0	71.1	18.7	70.8	20.0	70.5	21.3	70.4	21.9	70.3	22.6	70.0	23.9
	-9.8	-11.0	74.3	19.6	74.1	20.8	73.8	22.0	73.6	22.7	73.5	23.3	73.2	24.5
	-9.5	-10.0	76.0	20.0	75.8	21.2	75.5	22.4	75.4	23.0	75.2	23.6	75.0	24.9
	-8.5	-9.1	77.7	20.4	77.4	21.6	77.1	22.8	77.0	23.4	76.9	24.0	76.6	25.1
	-7.0	-7.6	80.5	21.1	80.2	22.2	79.9	23.3	79.8	23.9	79.7	24.5	79.4	25.6
	-5.0	-5.6	84.5	21.9	84.2	23.0	83.9	24.1	83.8	24.6	83.6	25.2	83.4	26.3
	-3.0	-3.7	88.5	22.7	88.2	23.7	88.0	24.8	87.8	25.3	87.7	25.8	87.4	26.8
	0.0	-0.7	95	23.9	95	24.8	95	25.8	95	26.3	95	26.7	94.3	27.7
	3.0	2.2	103	24.9	102	25.8	102	26.7	102	27.2	102	27.6	102	28.5
	5.0	4.1	108	25.6	107	26.4	107	27.3	107	27.7	107	28.1	107	29.0
	7.0	6.0	113	26.2	113	27.0	112	27.8	112	28.2	112	28.6	108	27.7
	9.0	7.9	118	26.8	118	27.6	118	28.3	118	28.7	117	29.0	108	26.1
11.0	9.8	124	27.4	124	28.1	124	28.8	122	28.7	117	27.3	108	24.6	
13.0	11.8	131	27.9	130	28.6	127	28.3	122	27.0	117	25.7	108	23.2	
15.0	13.7	137	28.4	137	29.1	127	26.7	122	25.5	117	24.3	108	22.0	
110% 104.50 kW	-19.8	-20.0	61.5	17.4	61.3	18.8	61.0	20.2	60.9	20.9	60.8	21.6	60.5	22.9
	-18.8	-19.0	62.6	17.8	62.4	19.2	62.1	20.5	62.0	21.2	61.9	21.9	61.7	23.2
	-16.7	-17.0	65.1	18.6	64.8	19.9	64.6	21.2	64.4	21.9	64.3	22.5	64.1	23.8
	-13.7	-15.0	67.8	19.4	67.5	20.7	67.3	21.9	67.1	22.6	67.0	23.2	66.8	24.4
	-11.8	-13.0	70.7	20.3	70.5	21.5	70.2	22.7	70.1	23.3	70.0	23.9	69.8	25.0
	-9.8	-11.0	74.0	21.1	73.7	22.2	73.5	23.4	73.4	24.0	73.2	24.5	73.0	25.7
	-9.5	-10.0	75.7	21.5	75.5	22.6	75.2	23.7	75.1	24.3	75.0	24.9	74.7	26.0
	-8.5	-9.1	77.3	21.9	77.1	23.0	76.8	24.1	76.7	24.6	76.6	25.1	76.3	26.2
	-7.0	-7.6	80.1	22.5	79.9	23.5	79.6	24.6	79.5	25.1	79.4	25.6	79.1	26.7
	-5.0	-5.6	84.1	23.3	83.9	24.3	83.6	25.3	83.5	25.8	83.4	26.3	83.1	27.3
	-3.0	-3.7	88.2	24.0	87.9	24.9	87.7	25.9	87.5	26.4	87.4	26.8	87.2	27.8
	0.0	-0.7	95	25.1	95	25.9	95	26.8	94	27.3	94.3	27.7	94.1	28.6
	3.0	2.2	102	26.0	102	26.9	102	27.7	102	28.1	102	28.5	99	28.1
	5.0	4.1	107	26.6	107	27.4	107	28.2	107	28.6	107	29.0	99	26.5
	7.0	6.0	113	27.2	112	27.9	112	28.7	112	29.1	108	27.7	99	25.0
	9.0	7.9	118	27.8	118	28.5	117	28.7	112	27.4	108	26.1	99	23.6
11.0	9.8	124	28.3	124	28.9	117	27.1	112	25.9	108	24.6	99	22.3	
13.0	11.8	130	28.8	126	27.8	117	25.5	112	24.3	108	23.2	99	21.0	
15.0	13.7	135	28.5	126	26.3	117	24.1	112	23.0	108	22.0	99	19.9	
100% 95.00 kW	-19.8	-20.0	61.2	19.3	61.0	20.6	60.7	21.8	60.6	22.4	60.5	23.1	60.3	24.3
	-18.8	-19.0	62.3	19.7	62.1	20.9	61.9	22.1	61.7	22.7	61.6	23.4	61.4	24.6
	-16.7	-17.0	64.7	20.4	64.5	21.6	64.3	22.8	64.2	23.4	64.1	23.9	63.8	25.1
	-13.7	-15.0	67.4	21.1	67.2	22.3	67.0	23.4	66.9	24.0	66.8	24.5	66.5	25.7
	-11.8	-13.0	70.4	21.9	70.2	23.0	70.0	24.1	69.8	24.6	69.7	25.2	69.5	26.2
	-9.8	-11.0	73.6	22.7	73.4	23.7	73.2	24.7	73.1	25.2	73.0	25.8	72.8	26.8
	-9.5	-10.0	75.4	23.0	75.2	24.0	74.9	25.1	74.8	25.6	74.7	26.1	74.5	27.1
	-8.5	-9.1	77.0	23.4	76.8	24.4	76.5	25.3	76.4	25.8	76.3	26.3	76.1	27.3
	-7.0	-7.6	79.8	23.9	79.6	24.9	79.3	25.8	79.2	26.3	79.1	26.8	78.9	27.7
	-5.0	-5.6	83.8	24.6	83.6	25.5	83.3	26.4	83.2	26.9	83.1	27.3	82.9	28.2
	-3.0	-3.7	87.8	25.3	87.6	26.1	87.4	27.0	87.3	27.4	87.1	27.9	86.9	28.7
	0.0	-0.7	95	26.3	94	27.1	94.3	27.9	94.1	28.3	94.0	28.7	89.7	27.5
	3.0	2.2	102	27.2	102	27.9	101	28.6	101	29.0	98	27.8	89.7	25.1
	5.0	4.1	107	27.7	107	28.4	106	28.9	102	27.5	98	26.2	89.7	23.7
	7.0	6.0	112	28.2	112	28.9	106	27.2	102	26.0	98	24.7	89.7	22.4
	9.0	7.9	118	28.7	114	28.0	106	25.6	102	24.5	98	23.4	89.7	21.1
11.0	9.8	122	28.7	114	26.4	106	24.2	102	23.1	98	22.1	89.7	20.0	
13.0	11.8	122	27.0	114	24.9	106	22.8	102	21.8	98	20.8	89.7	18.9	
15.0	13.7	122	25.5	114	23.5	106	21.6	102	20.6	98	19.7	89.7	17.9	

NOTES - ANMERKUNGEN - Σημειώσεις - NOTAS - REMARQUES - NOTE - OPMERKINGEN - примечания - NOTLAR

1. [] is shown as reference. When selecting the unit models, avoid the Outdoor air temperature range shown by [].
 dient als Verweis. Vermeiden Sie bei der Auswahl der Gerätemodelle den als markierten Temperaturbereich der Außenluft.
 Η [] είναι ενδεικτική, κατά την επιλογή των μοντέλων των μονάδων, αποφύγετε το εύρος θερμοκρασίας εξωτερικού αέρα που υποδεικνύεται [].
 se muestra como referencia. Cuando seleccione los modelos de unidad, evite el intervalo de temperaturas del aire exterior indicado mediante [].
 est montré comme référence. Lors du choix des modèles d'unités, évitez la plage de températures de l'air extérieur illustré par [].
 valori riportati unicamente come riferimento. Nel selezionare i modelli delle unità, non considerare i valori di temperatura dell'aria esterna indicati con il colore [].
 is als referentie getoond. Wanneer modellen van eenheden worden gekozen, vermijd dan het bereik van buitenluchttemperaturen geïllustreerd door [].

2. The above table shows the average value of conditions which may occur.
 Die obige Tabelle zeigt den Durchschnittswert der Bedingungen, die auftreten können.
 Στον παραπάνω πίνακα αναγράφεται η μέση τιμή για συνθήκες που μπορεί να προκύψουν.
 La tabla de arriba muestra el valor medio de condiciones que pueden ocurrir.
 Le tableau ci-dessus donne la valeur moyenne pour des conditions qui peuvent survenir.
 La tabella in alto mostra il valore delle condizioni medie che si possono riscontrare.
 De tabel hierboven geeft de gemiddelde waarde aan van situaties die kunnen voorvallen.
 Таблица расположенная выше показывает среднее значение условий, которые могут наступить.
 Yukarıdaki tablo meydana gelebilecek koşulların ortalama değerini göstermektedir.

5 Таблицы производительности

5 - 2 Таблицы теплопроизводительностей

5

RXYQ34T														
Indoor air temp. °CDB														
Combination (%) (Capacity index)	Outdoor air temp.		16.0		18.0		20.0		21.0		22.0		24.0	
			TC	PI	TC	PI	TC	PI	TC	PI	TC	PI	TC	PI
	(°CDB)	(°CWB)	KW	KW	KW	KW	KW	KW	KW	KW	KW	KW	KW	KW
90% 85.50 kW	-19.8	-20.0	60.9	21.2	60.7	22.3	60.5	23.4	60.4	24.0	60.3	24.6	60.1	25.7
	-18.8	-19.0	62.0	21.5	61.8	22.6	61.6	23.7	61.5	24.3	61.4	24.8	61.2	25.9
	-16.7	-17.0	64.4	22.2	64.2	23.2	64.0	24.3	63.9	24.8	63.8	25.4	63.6	26.4
	-13.7	-15.0	67.1	22.8	66.9	23.9	66.7	24.9	66.6	25.4	66.5	25.9	66.3	26.9
	-11.8	-13.0	70.1	23.5	69.9	24.5	69.7	25.5	69.6	26.0	69.5	26.5	69.3	27.4
	-9.8	-11.0	73.3	24.2	73.1	25.1	72.9	26.1	72.8	26.5	72.7	27.0	72.5	27.9
	-9.5	-10.0	75.0	24.5	74.8	25.5	74.6	26.4	74.5	26.8	74.4	27.3	74.2	28.2
	-8.5	-9.1	76.7	24.8	76.5	25.7	76.2	26.6	76.1	27.1	76.0	27.5	75.8	28.4
	-7.0	-7.6	79.5	25.3	79.3	26.2	79.1	27.1	79.0	27.5	78.9	27.9	78.7	28.8
	-5.0	-5.6	83.4	26.0	83.2	26.8	83.0	27.6	82.9	28.0	82.8	28.4	80.7	28.2
	-3.0	-3.7	87.5	26.6	87.3	27.3	87.1	28.1	87.0	28.5	86.9	28.9	80.7	26.6
	0.0	-0.7	94.4	27.5	94.2	28.2	94.0	28.9	91.7	28.2	88.1	26.9	80.7	24.3
	3.0	2.2	102	28.3	101	28.9	95.4	27.0	91.7	25.8	88.1	24.6	80.7	22.2
	5.0	4.1	107	28.8	103	27.8	95.4	25.5	91.7	24.3	88.1	23.2	80.7	21.0
	7.0	6.0	110	28.5	103	26.2	95.4	24.0	91.7	23.0	88.1	21.9	80.7	19.9
	9.0	7.9	110	26.8	103	24.7	95.4	22.7	91.7	21.7	88.1	20.7	80.7	18.8
	11.0	9.8	110	25.3	103	23.3	95.4	21.4	91.7	20.5	88.1	19.6	80.7	17.8
13.0	11.8	110	23.8	103	22.0	95.4	20.2	91.7	19.4	88.1	18.5	80.7	16.9	
15.0	13.7	110	22.5	103	20.8	95.4	19.2	91.7	18.4	88.1	17.6	80.7	16.0	
80% 76.00 kW	-19.8	-20.0	60.5	23.1	60.3	24.1	60.2	25.1	60.1	25.6	60.0	26.1	59.8	27.1
	-18.8	-19.0	61.6	23.4	61.5	24.3	61.3	25.3	61.2	25.8	61.1	26.3	60.9	27.3
	-16.7	-17.0	64.1	23.9	63.9	24.9	63.7	25.8	63.6	26.3	63.5	26.8	63.3	27.7
	-13.7	-15.0	66.8	24.5	66.6	25.5	66.4	26.4	66.3	26.8	66.2	27.3	66.0	28.2
	-11.8	-13.0	69.7	25.2	69.6	26.0	69.4	26.9	69.3	27.3	69.2	27.8	69.0	28.6
	-9.8	-11.0	73.0	25.8	72.8	26.6	72.6	27.4	72.5	27.8	72.4	28.2	71.8	28.7
	-9.5	-10.0	74.7	26.1	74.5	26.9	74.3	27.7	74.3	28.1	74.2	28.5	71.8	27.9
	-8.5	-9.1	76.3	26.3	76.1	27.1	76.0	27.9	75.9	28.3	75.8	28.7	71.8	27.2
	-7.0	-7.6	79.1	26.8	78.9	27.5	78.8	28.3	78.7	28.7	78.3	28.9	71.8	26.0
	-5.0	-5.6	83.1	27.3	82.9	28.1	82.8	28.8	81.5	28.5	78.3	27.2	71.8	24.5
	-3.0	-3.7	87.1	27.9	87.0	28.6	84.8	28.2	81.5	26.9	78.3	25.6	71.8	23.2
	0.0	-0.7	94.0	28.7	91.3	28.1	84.8	25.7	81.5	24.5	78.3	23.4	71.8	21.2
	3.0	2.2	97.8	27.8	91.3	25.6	84.8	23.5	81.5	22.5	78.3	21.5	71.8	19.5
	5.0	4.1	97.8	26.2	91.3	24.2	84.8	22.2	81.5	21.2	78.3	20.3	71.8	18.4
	7.0	6.0	97.8	24.7	91.3	22.8	84.8	21.0	81.5	20.1	78.3	19.2	71.8	17.4
	9.0	7.9	97.8	23.4	91.3	21.6	84.8	19.9	81.5	19.0	78.3	18.2	71.8	16.5
	11.0	9.8	97.8	22.1	91.3	20.4	84.8	18.8	81.5	18.0	78.3	17.2	71.8	15.7
13.0	11.8	97.8	20.8	91.3	19.3	84.8	17.8	81.5	17.0	78.3	16.3	71.8	14.9	
15.0	13.7	97.8	19.7	91.3	18.3	84.8	16.9	81.5	16.2	78.3	15.5	71.8	14.2	
70% 66.50 kW	-19.8	-20.0	60.2	24.9	60.0	25.8	59.9	26.7	59.8	27.1	59.7	27.6	59.6	28.5
	-18.8	-19.0	61.3	25.2	61.1	26.1	61.0	26.9	60.9	27.4	60.8	27.8	60.7	28.6
	-16.7	-17.0	63.7	25.7	63.6	26.5	63.4	27.4	63.3	27.8	63.3	28.2	62.8	28.8
	-13.7	-15.0	66.4	26.2	66.3	27.0	66.1	27.8	66.0	28.2	66.0	28.6	62.8	27.4
	-11.8	-13.0	69.4	26.8	69.2	27.5	69.1	28.3	69.0	28.7	68.5	28.8	62.8	25.9
	-9.8	-11.0	72.6	27.3	72.5	28.0	72.3	28.8	71.3	28.5	68.5	27.2	62.8	24.5
	-9.5	-10.0	74.4	27.6	74.2	28.3	74.1	29.0	71.3	27.7	68.5	26.4	62.8	23.8
	-8.5	-9.1	76.0	27.8	75.8	28.5	74.2	28.3	71.3	27.0	68.5	25.7	62.8	23.2
	-7.0	-7.6	78.8	28.2	78.6	28.9	74.2	27.1	71.3	25.8	68.5	24.6	62.8	22.3
	-5.0	-5.6	82.8	28.7	79.9	27.8	74.2	25.5	71.3	24.3	68.5	23.2	62.8	21.0
	-3.0	-3.7	85.6	28.5	79.9	26.3	74.2	24.1	71.3	23.0	68.5	22.0	62.8	19.9
	0.0	-0.7	85.6	26.0	79.9	24.0	74.2	22.0	71.3	21.0	68.5	20.1	62.8	18.3
	3.0	2.2	85.6	23.8	79.9	22.0	74.2	20.2	71.3	19.3	68.5	18.5	62.8	16.8
	5.0	4.1	85.6	22.4	79.9	20.8	74.2	19.1	71.3	18.3	68.5	17.5	62.8	16.0
	7.0	6.0	85.6	21.2	79.9	19.6	74.2	18.1	71.3	17.3	68.5	16.6	62.8	15.1
	9.0	7.9	85.6	20.1	79.9	18.6	74.2	17.2	71.3	16.4	68.5	15.8	62.8	14.4
	11.0	9.8	85.6	19.0	79.9	17.6	74.2	16.3	71.3	15.6	68.5	15.0	62.8	13.7
13.0	11.8	85.6	18.0	79.9	16.7	74.2	15.4	71.3	14.8	68.5	14.2	62.8	13.0	
15.0	13.7	85.6	17.0	79.9	15.8	74.2	14.7	71.3	14.1	68.5	13.5	62.8	12.4	
60% 57.00 kW	-19.8	-20.0	59.8	26.8	59.7	27.6	59.6	28.3	59.5	28.7	58.7	28.5	53.8	25.7
	-18.8	-19.0	61.0	27.0	60.8	27.8	60.7	28.5	60.6	28.9	58.7	27.9	53.8	25.1
	-16.7	-17.0	63.4	27.5	63.3	28.2	63.1	28.9	61.2	27.9	58.7	26.6	53.8	24.0
	-13.7	-15.0	66.1	27.9	66.0	28.6	63.6	27.8	61.2	26.5	58.7	25.3	53.8	22.8
	-11.8	-13.0	69.1	28.4	68.5	28.8	63.6	26.3	61.2	25.1	58.7	24.0	53.8	21.7
	-9.8	-11.0	72.3	28.9	68.5	27.2	63.6	24.9	61.2	23.8	58.7	22.7	53.8	20.5
	-9.5	-10.0	73.4	28.7	68.5	26.4	63.6	24.2	61.2	23.1	58.7	22.1	53.8	20.0
	-8.5	-9.1	73.4	27.9	68.5	25.7	63.6	23.6	61.2	22.5	58.7	21.5	53.8	19.5
	-7.0	-7.6	73.4	26.7	68.5	24.6	63.6	22.6	61.2	21.6	58.7	20.6	53.8	18.7
	-5.0	-5.6	73.4	25.2	68.5	23.2	63.6	21.3	61.2	20.4	58.7	19.5	53.8	17.7
	-3.0	-3.7	73.4	23.8	68.5	22.0	63.6	20.2	61.2	19.3	58.7	18.5	53.8	16.8
	0.0	-0.7	73.4	21.7	68.5	20.1	63.6	18.5	61.2	17.7	58.7	17.0	53.8	15.5
	3.0	2.2	73.4	19.9	68.5	18.5	63.6	17.1	61.2	16.4	58.7	15.7	53.8	14.3
	5.0	4.1	73.4	18.9	68.5	17.5	63.6	16.2	61.2	15.5	58.7	14.9	53.8	13.6
	7.0	6.0	73.4	17.9	68.5	16.6	63.6	15.3	61.2	14.7	58.7	14.1	53.8	12.9
	9.0	7.9	73.4	16.9	68.5	15.8	63.6	14.6	61.2	14.0	58.7	13.4	53.8	12.3
	11.0	9.8	73.4	16.1	68.5	15.0	63.6	13.9	61.2	13.3	58.7	12.8	53.8	11.7
13.0	11.8	73.4	15.2	68.5	14.2	63.6	13.2	61.2	12.7	58.7	12.2	53.8	11.2	
15.0	13.7	73.4	14.5	68.5	13.5	63.6	12.5	61.2	12.1	58.7	11.6	53.8	10.7	
50% 47.50 kW	-19.8	-20.0	59.5	28.7	57.1	27.6	53.0	25.2	51.0	24.1	48.9	23.0	44.8	20.8
	-18.8	-19.0	60.6	28.9	57.1	27.0	53.0	24.7	51.0	23.6	48.9	22.5	44.8	20.4
	-16.7	-17.0	61.2	27.9	57.1	25.7	53.0	23.6	51.0	22.5	48.9	21.5	44.8	19.5
	-13.7	-15.0	61.2	26.5	57.1	24.4	53.0	22.4	51.0	21.4	48.9	20.5	44.8	18.6
	-11.8	-13.0	61.2	25.1	57.1	23.2	53.0	21.3	51.0	20.4	48.9	19.5	44.8	17.7
	-9.8	-11.0	61.2	23.8	57.1	22.0	53.0	20.2	51.0	19.3	48.9	18.5	44.8	16.8
	-9.5	-10.0	61.2	23.1	57.1	21.4	53.0	19.7	51.0	18.8	48.9	18.0	44.8	16.4
	-8.5	-9.1	61.2	22.5	57.1	20.8	53.0	19.2	51.0	18.4	48.9	17.6	44.8	16.0
	-7.0	-7.6	61.2	21.6	57.1	20.0	53.0	18.4	51.0	17.6	48.9	16.9	44.8	15.4
	-5.0	-5.6	61.2	20.4	57.1	18.9	53.0	17.4	51.0	16.7	48.9	16.0	44.8	14.6
	-3.0	-3.7	61.2	19.3	57.1	17.9	53.0	16.5	51.0	15.9	48.9	15.2	44.8	13.9
	0.0	-0.7	61.2	17.7	57.1	16.5	53.0	15.2	51.0	14.6	48.9	14.0	44.8	12.

5 Таблицы производительности

5 - 2 Таблицы теплопроизводительностей

RXYQ36T		Indoor air temp. °CDB												
Combination(%) (Capacity index)	Outdoor air temp.		16.0		18.0		20.0		21.0		22.0		24.0	
	(°CDB)	(°CWB)	TC	PI	TC	PI	TC	PI	TC	PI	TC	PI	TC	PI
			KW	KW	KW	KW	KW	KW	KW	KW	KW	KW	KW	KW
130% 131.30 kW	-19.8	-20.0	65.3	14.2	65.0	16.0	64.7	17.8	64.5	18.7	64.4	19.6	64.1	21.3
	-18.8	-19.0	66.5	14.7	66.2	16.5	65.9	18.2	65.7	19.1	65.6	20.0	65.2	21.7
	-16.7	-17.0	69.0	15.7	68.7	17.4	68.4	19.1	68.3	20.0	68.1	20.8	67.8	22.5
	-13.7	-15.0	71.9	16.8	71.6	18.4	71.2	20.0	71.1	20.8	70.9	21.7	70.6	23.3
	-11.8	-13.0	75.0	17.9	74.7	19.4	74.4	21.0	74.2	21.7	74.1	22.5	73.7	24.1
	-9.8	-11.0	78.4	19.0	78.1	20.4	77.8	21.9	77.6	22.6	77.5	23.4	77.2	24.9
	-9.5	-10.0	80.2	19.5	79.9	20.9	79.6	22.4	79.4	23.1	79.3	23.8	79.0	25.2
	-8.5	-9.1	81.9	20.0	81.6	21.4	81.3	22.8	81.1	23.5	81.0	24.2	80.7	25.6
	-7.0	-7.6	84.8	20.7	84.5	22.1	84.2	23.5	84.1	24.1	83.9	24.8	83.6	26.2
	-5.0	-5.6	89.0	21.8	88.7	23.0	88.4	24.3	88.2	25.0	88.1	25.6	87.8	26.9
	-3.0	-3.7	93.3	22.7	93.0	23.9	92.6	25.1	92.5	25.8	92.3	26.4	92.0	27.6
	0.0	-0.7	100	24.1	100	25.2	100	26.4	100	26.9	100	27.5	99	28.6
	3.0	2.2	108	25.3	108	26.4	107	27.4	107	28.0	107	28.5	107	29.5
	5.0	4.1	113	26.1	113	27.1	113	28.1	113	28.6	112	29.1	112	30.1
	7.0	6.0	119	26.8	119	27.8	118	28.8	118	29.2	118	29.7	118	30.7
	9.0	7.9	125	27.5	124	28.5	124	29.4	124	29.8	124	30.3	124	31.2
11.0	9.8	131	28.2	131	29.1	130	29.9	130	30.4	130	30.8	124	29.7	
13.0	11.8	137	28.9	137	29.7	137	30.5	137	30.9	136	31.0	124	27.9	
15.0	13.7	144	29.5	144	30.2	143	31.0	141	30.7	136	29.2	124	26.4	
120% 121.20 kW	-19.8	-20.0	65.0	16.3	64.7	17.9	64.4	19.6	64.3	20.4	64.1	21.2	63.8	22.9
	-18.8	-19.0	66.1	16.7	65.8	18.3	65.6	20.0	65.4	20.8	65.3	21.6	65.0	23.2
	-16.7	-17.0	68.7	17.7	68.4	19.2	68.1	20.8	68.0	21.6	67.8	22.4	67.5	23.9
	-13.7	-15.0	71.5	18.7	71.2	20.2	70.9	21.7	70.8	22.4	70.7	23.1	70.4	24.6
	-11.8	-13.0	74.6	19.7	74.3	21.1	74.1	22.5	73.9	23.2	73.8	23.9	73.5	25.4
	-9.8	-11.0	78.0	20.7	77.8	22.0	77.5	23.4	77.3	24.1	77.2	24.7	76.9	26.1
	-9.5	-10.0	79.8	21.2	79.6	22.5	79.3	23.8	79.1	24.5	79.0	25.1	78.7	26.5
	-8.5	-9.1	81.5	21.6	81.3	22.9	81.0	24.2	80.8	24.8	80.7	25.5	80.4	26.8
	-7.0	-7.6	84.5	22.3	84.2	23.6	83.9	24.8	83.8	25.4	83.6	26.1	83.3	27.3
	-5.0	-5.6	88.7	23.2	88.4	24.4	88.1	25.6	88.0	26.2	87.8	26.8	87.5	28.0
	-3.0	-3.7	92.9	24.1	92.6	25.2	92.3	26.4	92.2	26.9	92.0	27.5	91.8	28.6
	0.0	-0.7	100	25.4	100	26.4	100	27.5	99	28.0	99	28.5	99	29.6
	3.0	2.2	108	26.6	107	27.5	107	28.5	107	29.0	107	29.5	107	30.4
	5.0	4.1	113	27.3	113	28.2	112	29.1	112	29.6	112	30.0	112	31.0
	7.0	6.0	119	27.9	118	28.8	118	29.7	118	30.1	118	30.6	115	30.3
	9.0	7.9	124	28.6	124	29.4	124	30.3	124	30.7	124	31.1	115	28.6
11.0	9.8	130	29.2	130	30.0	130	30.8	130	31.2	125	29.9	115	27.0	
13.0	11.8	137	29.8	137	30.6	136	31.0	130	29.6	125	28.2	115	25.4	
15.0	13.7	144	30.4	143	31.1	136	29.2	130	27.9	125	26.6	115	24.1	
110% 111.10 kW	-19.8	-20.0	64.6	18.3	64.3	19.8	64.1	21.3	64.0	22.1	63.8	22.9	63.6	24.4
	-18.8	-19.0	65.8	18.7	65.5	20.2	65.2	21.7	65.1	22.5	65.0	23.2	64.7	24.7
	-16.7	-17.0	68.3	19.6	68.1	21.1	67.8	22.5	67.7	23.2	67.5	23.9	67.3	25.3
	-13.7	-15.0	71.2	20.5	70.9	21.9	70.6	23.3	70.5	24.0	70.4	24.6	70.1	26.0
	-11.8	-13.0	74.3	21.5	74.0	22.8	73.7	24.1	73.6	24.7	73.5	25.4	73.2	26.7
	-9.8	-11.0	77.7	22.4	77.4	23.6	77.2	24.9	77.0	25.5	76.9	26.1	76.6	27.3
	-9.5	-10.0	79.5	22.8	79.2	24.0	79.0	25.2	78.8	25.9	78.7	26.5	78.4	27.7
	-8.5	-9.1	81.2	23.2	80.9	24.4	80.7	25.6	80.5	26.2	80.4	26.8	80.1	28.0
	-7.0	-7.6	84.1	23.9	83.9	25.0	83.6	26.2	83.5	26.7	83.3	27.3	83.1	28.5
	-5.0	-5.6	88.3	24.7	88.0	25.8	87.8	26.9	87.7	27.5	87.5	28.0	87.3	29.1
	-3.0	-3.7	92.5	25.5	92.3	26.6	92.0	27.6	91.9	28.1	91.8	28.6	91.5	29.7
	0.0	-0.7	100	26.7	100	27.7	99	28.6	99	29.1	99	29.6	99	30.5
	3.0	2.2	107	27.8	107	28.7	107	29.5	107	30.0	107	30.4	105	30.8
	5.0	4.1	113	28.4	112	29.3	112	30.1	112	30.5	112	31.0	105	29.0
	7.0	6.0	118	29.0	118	29.9	118	30.7	118	31.1	115	30.3	105	27.4
	9.0	7.9	124	29.6	124	30.4	124	31.2	120	30.0	115	28.6	105	25.8
11.0	9.8	130	30.2	130	30.9	124	29.7	120	28.3	115	27.0	105	24.4	
13.0	11.8	137	30.8	134	30.5	124	27.9	120	26.7	115	25.4	105	23.0	
15.0	13.7	143	31.3	134	28.8	124	26.4	120	25.2	115	24.1	105	21.8	
100% 101.00 kW	-19.8	-20.0	64.3	20.4	64.0	21.8	63.8	23.1	63.7	23.8	63.5	24.5	63.3	25.9
	-18.8	-19.0	65.4	20.8	65.2	22.1	64.9	23.5	64.8	24.1	64.7	24.8	64.5	26.2
	-16.7	-17.0	68.0	21.6	67.7	22.9	67.5	24.2	67.4	24.8	67.2	25.5	67.0	26.8
	-13.7	-15.0	70.8	22.4	70.6	23.6	70.3	24.9	70.2	25.5	70.1	26.1	69.8	27.4
	-11.8	-13.0	73.9	23.2	73.7	24.4	73.4	25.6	73.3	26.2	73.2	26.8	73.0	28.0
	-9.8	-11.0	77.3	24.1	77.1	25.2	76.8	26.3	76.7	26.9	76.6	27.5	76.4	28.6
	-9.5	-10.0	79.1	24.5	78.9	25.6	78.7	26.7	78.5	27.2	78.4	27.8	78.2	28.9
	-8.5	-9.1	80.8	24.8	80.6	25.9	80.3	27.0	80.2	27.5	80.1	28.1	79.9	29.2
	-7.0	-7.6	83.8	25.4	83.5	26.5	83.3	27.5	83.2	28.0	83.1	28.6	82.8	29.6
	-5.0	-5.6	88.0	26.2	87.7	27.2	87.5	28.2	87.4	28.7	87.2	29.2	87.0	30.2
	-3.0	-3.7	92.2	26.9	92.0	27.9	91.7	28.8	91.6	29.3	91.5	29.8	91.2	30.7
	0.0	-0.7	99	28.0	99	28.9	99	29.8	99	30.2	99	30.6	95.6	30.1
	3.0	2.2	107	29.0	107	29.8	107	30.6	106	31.0	104	30.5	95.6	27.5
	5.0	4.1	112	29.6	112	30.3	112	31.1	109	30.2	104	28.7	95.6	26.0
	7.0	6.0	118	30.1	118	30.9	113	29.8	109	28.4	104	27.1	95.6	24.5
	9.0	7.9	124	30.7	122	30.7	113	28.1	109	26.8	104	25.6	95.6	23.2
11.0	9.8	130	31.2	122	28.9	113	26.5	109	25.3	104	24.2	95.6	21.9	
13.0	11.8	130	29.6	122	27.2	113	25.0	109	23.9	104	22.8	95.6	20.7	
15.0	13.7	130	27.9	122	25.7	113	23.6	109	22.6	104	21.6	95.6	19.6	

NOTES - ANMERKUNGEN - Σημειώσεις - NOTAS - REMARQUES - NOTE - OPMERKINGEN - примечания - NOTLAR

- █ is shown as reference. When selecting the unit models, avoid the Outdoor air temperature range shown by █.

█ dient als Verweis. Vermeiden Sie bei der Auswahl der Gerätemodelle den als markierten Temperaturbereich der Außenluft.

Н █ είναι ενδεικτική, κατά την επιλογή των μοντέλων των μονάδων, αποφεύγετε το εύρος θερμοκρασίας εξωτερικού αέρα που υποδεικνύεται █.

█ se muestra como referencia. Cuando seleccione los modelos de unidad, evite el intervalo de temperaturas de aire exterior indicado mediante █.

█ est montré comme référence. Lors du choix des modèles d'unités, évitez la plage de températures de l'air extérieur illustré par █.

█ valori riportati unicamente come riferimento. Nel selezionare i modelli delle unità, non considerare i valori di temperatura dell'aria esterna indicati con il colore █.

█ is als referentie getoond. Wanneer modellen van eenheden worden gekozen, vermijd dan het bereik van buitenluchttemperaturen geïllustreerd door █.

█ показан как. При выборе модели устройства избегайте внешнюю температуру воздуха, указанную в █.

█ referans olarak gösterilmektedir. Ünite modellerini seçerken, belirtilen Dış hava sıcaklığı aralığından kaçınınız █.

The above table shows the average value of conditions which may occur.

Die obige Tabelle zeigt den Durchschnittswert der Bedingungen, die auftreten können.

Στον παραπάνω πίνακα αναγράφεται η μέση τιμή για συνθήκες που μπορεί να προκύψουν.

La tabla de arriba muestra el valor medio de condiciones que pueden ocurrir.

Le tableau ci-dessus donne la valeur moyenne pour des conditions qui peuvent survenir.

La tabella in alto mostra il valore delle condizioni medie che si possono riscontrare.

De tabel hierboven geeft de gemiddelde waarde aan van situaties die kunnen voorvallen.

Таблица расположенная выше показывает среднее значение условий, которые могут наступить.

Yukarıdaki tablo meydana gelebilecek koşulların ortalama değerini göstermektedir.

3D079549

5 Таблицы производительности

5 - 2 Таблицы теплопроизводительностей

5

RXYQ36T														
Indoor air temp. °CDB														
Combination(%) (Capacity index)	Outdoor air temp.		16.0		18.0		20.0		21.0		22.0		24.0	
			TC	PI	TC	PI	TC	PI	TC	PI	TC	PI	TC	PI
	(°CDB)	(°CWB)	KW	KW	KW	KW	KW	KW	KW	KW	KW	KW	KW	KW
90% 90.90 kW	-19.8	-20.0	63.9	22.4	63.7	23.7	63.5	24.9	63.4	25.5	63.3	26.2	63.0	27.4
	-18.8	-19.0	65.1	22.8	64.8	24.0	64.6	25.2	64.5	25.8	64.4	26.4	64.2	27.6
	-16.7	-17.0	67.6	23.5	67.4	24.7	67.2	25.9	67.1	26.4	67.0	27.0	66.7	28.2
	-13.7	-15.0	70.4	24.3	70.2	25.4	70.0	26.5	69.9	27.1	69.8	27.6	69.6	28.7
	-11.8	-13.0	73.6	25.0	73.3	26.1	73.1	27.1	73.0	27.7	72.9	28.2	72.7	29.3
	-9.8	-11.0	77.0	25.8	76.8	26.8	76.5	27.8	76.4	28.3	76.3	28.8	76.1	29.8
	-9.5	-10.0	78.8	26.1	78.6	27.1	78.3	28.1	78.2	28.6	78.1	29.1	77.9	30.1
	-8.5	-9.1	80.5	26.5	80.3	27.4	80.0	28.4	79.9	28.9	79.8	29.4	79.6	30.3
	-7.0	-7.6	83.4	27.0	83.2	27.9	83.0	28.9	82.9	29.3	82.8	29.8	82.6	30.7
	-5.0	-5.6	87.6	27.7	87.4	28.6	87.2	29.5	87.1	29.9	87.0	30.4	86.1	30.9
	-3.0	-3.7	91.8	28.3	91.6	29.2	91.4	30.0	91.3	30.5	91.2	30.9	86.1	29.1
	0.0	-0.7	99	29.3	99	30.1	99	30.9	97.8	30.9	93.9	29.4	86.1	26.6
	3.0	2.2	107	30.2	106	30.9	102	29.6	97.8	28.2	93.9	26.9	86.1	24.3
	5.0	4.1	112	30.7	110	30.5	102	27.9	97.8	26.6	93.9	25.4	86.1	23.0
	7.0	6.0	117	31.2	110	28.7	102	26.3	97.8	25.1	93.9	24.0	86.1	21.8
	9.0	7.9	117	29.4	110	27.1	102	24.9	97.8	23.8	93.9	22.7	86.1	20.6
	11.0	9.8	117	27.7	110	25.6	102	23.5	97.8	22.5	93.9	21.5	86.1	19.5
13.0	11.8	117	26.1	110	24.1	102	22.2	97.8	21.2	93.9	20.3	86.1	18.5	
15.0	13.7	117	24.7	110	22.8	102	21.0	97.8	20.1	93.9	19.3	86.1	17.5	
80% 80.80 kW	-19.8	-20.0	63.5	24.5	63.3	25.6	63.2	26.7	63.1	27.3	63.0	27.8	62.8	28.9
	-18.8	-19.0	64.7	24.8	64.5	25.9	64.3	27.0	64.2	27.5	64.1	28.1	63.9	29.1
	-16.7	-17.0	67.2	25.5	67.1	26.5	66.9	27.5	66.8	28.1	66.7	28.6	66.5	29.6
	-13.7	-15.0	70.1	26.1	69.9	27.1	69.7	28.1	69.6	28.6	69.5	29.1	69.3	30.1
	-11.8	-13.0	73.2	26.8	73.0	27.7	72.8	28.7	72.7	29.2	72.6	29.6	72.4	30.6
	-9.8	-11.0	76.6	27.5	76.4	28.4	76.2	29.3	76.1	29.7	76.0	30.2	75.8	31.1
	-9.5	-10.0	78.4	27.8	78.2	28.7	78.0	29.6	77.9	30.0	77.8	30.4	76.5	30.6
	-8.5	-9.1	80.1	28.1	79.9	28.9	79.7	29.8	79.6	30.2	79.5	30.7	76.5	29.8
	-7.0	-7.6	83.1	28.6	82.9	29.4	82.7	30.2	82.6	30.6	82.5	31.1	76.5	28.5
	-5.0	-5.6	87.2	29.2	87.0	30.0	86.9	30.8	86.8	31.2	83.4	29.8	76.5	26.9
	-3.0	-3.7	91.5	29.8	91.3	30.5	90.4	30.9	86.9	29.5	83.4	28.1	76.5	25.4
	0.0	-0.7	99	30.6	97.4	30.8	90.4	28.2	86.9	26.9	83.4	25.6	76.5	23.2
	3.0	2.2	104	30.5	97.4	28.1	90.4	25.8	86.9	24.6	83.4	23.5	76.5	21.3
	5.0	4.1	104	28.7	97.4	26.5	90.4	24.3	86.9	23.3	83.4	22.2	76.5	20.2
	7.0	6.0	104	27.1	97.4	25.0	90.4	23.0	86.9	22.0	83.4	21.0	76.5	19.1
	9.0	7.9	104	25.6	97.4	23.6	90.4	21.8	86.9	20.8	83.4	19.9	76.5	18.1
	11.0	9.8	104	24.2	97.4	22.4	90.4	20.6	86.9	19.7	83.4	18.9	76.5	17.2
13.0	11.8	104	22.8	97.4	21.1	90.4	19.5	86.9	18.7	83.4	17.9	76.5	16.3	
15.0	13.7	104	21.6	97.4	20.0	90.4	18.5	86.9	17.7	83.4	17.0	76.5	15.5	
70% 70.7 kW	-19.8	-20.0	63.2	26.6	63.0	27.5	62.8	28.5	62.8	29.0	62.7	29.4	62.5	30.4
	-18.8	-19.0	64.3	26.8	64.2	27.8	64.0	28.7	63.9	29.2	63.8	29.7	63.7	30.6
	-16.7	-17.0	66.9	27.4	66.7	28.3	66.6	29.2	66.5	29.7	66.4	30.1	66.2	31.0
	-13.7	-15.0	69.7	28.0	69.6	28.9	69.4	29.7	69.3	30.2	69.2	30.6	66.9	30.0
	-11.8	-13.0	72.8	28.6	72.7	29.4	72.5	30.2	72.4	30.6	72.3	31.1	66.9	28.4
	-9.8	-11.0	76.3	29.2	76.1	29.9	75.9	30.7	75.8	31.1	73.0	29.8	66.9	26.9
	-9.5	-10.0	78.1	29.4	77.9	30.2	77.7	31.0	76.1	30.4	73.0	28.9	66.9	26.1
	-8.5	-9.1	79.8	29.7	79.6	30.5	79.1	31.0	76.1	29.6	73.0	28.2	66.9	25.5
	-7.0	-7.6	82.7	30.1	82.5	30.9	79.1	29.7	76.1	28.3	73.0	27.0	66.9	24.4
	-5.0	-5.6	86.9	30.7	85.2	30.5	79.1	27.9	76.1	26.7	73.0	25.4	66.9	23.0
	-3.0	-3.7	91.1	31.2	85.2	28.8	79.1	26.4	76.1	25.2	73.0	24.1	66.9	21.8
	0.0	-0.7	91.3	28.5	85.2	26.3	79.1	24.1	76.1	23.1	73.0	22.0	66.9	20.0
	3.0	2.2	91.3	26.0	85.2	24.1	79.1	22.1	76.1	21.2	73.0	20.2	66.9	18.4
	5.0	4.1	91.3	24.6	85.2	22.7	79.1	20.9	76.1	20.1	73.0	19.2	66.9	17.5
	7.0	6.0	91.3	23.2	85.2	21.5	79.1	19.8	76.1	19.0	73.0	18.2	66.9	16.6
	9.0	7.9	91.3	22.0	85.2	20.4	79.1	18.8	76.1	18.0	73.0	17.3	66.9	15.8
	11.0	9.8	91.3	20.8	85.2	19.3	79.1	17.8	76.1	17.1	73.0	16.4	66.9	15.0
13.0	11.8	91.3	19.7	85.2	18.3	79.1	16.9	76.1	16.2	73.0	15.5	66.9	14.2	
15.0	13.7	91.3	18.7	85.2	17.4	79.1	16.1	76.1	15.4	73.0	14.8	66.9	13.6	
60% 60.60 kW	-19.8	-20.0	62.8	28.6	62.7	29.4	62.5	30.3	62.5	30.7	62.4	31.1	62.4	28.2
	-18.8	-19.0	64.0	28.9	63.8	29.7	63.7	30.5	63.6	30.9	62.6	30.5	62.6	27.5
	-16.7	-17.0	66.5	29.3	66.4	30.1	66.2	30.9	65.2	30.6	62.6	29.1	62.6	26.3
	-13.7	-15.0	69.4	29.8	69.2	30.6	67.8	30.4	65.2	29.0	62.6	27.7	62.6	25.0
	-11.8	-13.0	72.5	30.4	72.3	31.1	67.8	28.8	65.2	27.5	62.6	26.2	62.6	23.7
	-9.8	-11.0	75.9	30.9	73.0	29.8	67.8	27.3	65.2	26.1	62.6	24.9	62.6	22.5
	-9.5	-10.0	77.7	31.1	73.0	28.9	67.8	26.5	65.2	25.3	62.6	24.2	62.6	21.9
	-8.5	-9.1	78.2	30.6	73.0	28.2	67.8	25.8	65.2	24.7	62.6	23.6	62.6	21.4
	-7.0	-7.6	78.2	29.3	73.0	27.0	67.8	24.8	65.2	23.7	62.6	22.6	62.6	20.5
	-5.0	-5.6	78.2	27.6	73.0	25.4	67.8	23.4	65.2	22.4	62.6	21.4	62.6	19.4
	-3.0	-3.7	78.2	26.0	73.0	24.1	67.8	22.1	65.2	21.2	62.6	20.2	62.6	18.4
	0.0	-0.7	78.2	23.8	73.0	22.0	67.8	20.3	65.2	19.4	62.6	18.6	62.6	17.0
	3.0	2.2	78.2	21.9	73.0	20.2	67.8	18.7	65.2	17.9	62.6	17.2	62.6	15.7
	5.0	4.1	78.2	20.7	73.0	19.2	67.8	17.7	65.2	17.0	62.6	16.3	62.6	14.9
	7.0	6.0	78.2	19.6	73.0	18.2	67.8	16.8	65.2	16.1	62.6	15.5	62.6	14.2
	9.0	7.9	78.2	18.6	73.0	17.3	67.8	16.0	65.2	15.3	62.6	14.7	62.6	13.5
	11.0	9.8	78.2	17.6	73.0	16.4	67.8	15.2	65.2	14.6	62.6	14.0	62.6	12.9
13.0	11.8	78.2	16.7	73.0	15.5	67.8	14.4	65.2	13.9	62.6	13.3	62.6	12.2	
15.0	13.7	78.2	15.9	73.0	14.8	67.8	13.7	65.2	13.2	62.6	12.7	62.6	11.7	
50% 50.50 kW	-19.8	-20.0	62.5	30.7	60.8	30.2	56.5	27.7	54.3	26.4	52.2	25.2	47.8	22.8
	-18.8	-19.0	63.6	30.9	60.8	29.5	56.5	27.1	54.3	25.8	52.2	24.7	47.8	22.3
	-16.7	-17.0	65.2	30.6	60.8	28.2	56.5	25.8	54.3	24.7	52.2	23.5	47.8	21.4
	-13.7	-15.0	65.2	29.0	60.8	26.8	56.5	24.6	54.3	23.5	52.2	22.4	47.8	20.4
	-11.8	-13.0	65.2	27.5	60.8	25.4	56.5	23.3	54.3	22.3	52.2	21.3	47.8	19.4
	-9.8	-11.0	65.2	26.1	60.8	24.1	56.5	22.1	54.3	21.2	52.2	20.3	47.8	18.4
	-9.5	-10.0	65.2	25.3	60.8	23.4	56.5	21.5	54.3	20.6	52.2	19.7	47.8	18.0
	-8.5	-9.1	65.2	24.7	60.8	22.8	56.5	21.0	54.3	20.1	52.2	19.3	47.8	17.5
	-7.0	-7.6	65.2	23.7	60.8	21.9	56.5	20.2	54.3	19.3	52.2	18.5	47.8	16.9
	-5.0	-5.6	65.2	22.4	60.8	20.7	56.5	19.1	54.3	18.3	52.2	17.5	47.8	16.0
	-3.0	-3.7	65.2	21.2	60.8	19.6	56.5	18.1	54.3	17.4	52.2	16.7	47.8	15.2
	0.0	-0.7	65.2	19.4	60.8	18.0	56.5	16.7	54.3	16.0	52.2	15.		

5 Таблицы производительности

5 - 2 Таблицы теплопроизводительностей

RXYQ38T		Indoor air temp. °CDB												TC: Total capacity (kW); PI: Power Input (kW) (Comp. + Outdoor fan motor)		
Combination(%) (Capacity index)	Outdoor air temp.		16.0		18.0		20.0		21.0		22.0		24.0		TC	PI
	(°CDB)	(°CWB)	KW	PI	KW	PI	KW	PI	KW	PI	KW	PI	KW	PI		
130% 138.32 kW	-19.8	-20.0	70.3	15.1	70.0	16.8	69.7	18.6	69.5	19.5	69.4	20.4	69.0	22.2		
	-18.8	-19.0	71.8	15.6	71.4	17.4	71.1	19.1	70.9	20.0	70.8	20.9	70.4	22.6		
	-16.7	-17.0	74.8	16.8	74.4	18.4	74.1	20.1	74.0	20.9	73.8	21.8	73.5	23.4		
	-13.7	-15.0	78.0	17.9	77.7	19.5	77.4	21.1	77.2	21.9	77.1	22.7	76.7	24.3		
	-11.8	-13.0	81.6	19.0	81.2	20.5	80.9	22.0	80.7	22.8	80.6	23.6	80.2	25.1		
	-9.8	-11.0	85.3	20.1	85.0	21.5	84.7	23.0	84.5	23.7	84.3	24.4	84.0	25.9		
	-9.5	-10.0	87.3	20.6	87.0	22.0	86.6	23.4	86.5	24.1	86.3	24.8	86.0	26.3		
	-8.5	-9.1	89.1	21.0	88.8	22.4	88.5	23.8	88.3	24.5	88.2	25.2	87.8	26.6		
	-7.0	-7.6	92.3	21.8	92.0	23.1	91.7	24.5	91.5	25.1	91.3	25.8	91.0	27.2		
	-5.0	-5.6	96.7	22.8	96.4	24.1	96.1	25.3	95.9	26.0	95.8	26.6	95.4	27.9		
	-3.0	-3.7	101	23.7	101	24.9	101	26.1	100	26.7	100	27.3	100	28.5		
	0.0	-0.7	109	25.0	108	26.1	108	27.2	108	27.8	108	28.4	107	29.5		
	3.0	2.2	116	26.2	116	27.2	116	28.3	116	28.8	115	29.3	115	30.4		
	5.0	4.1	122	26.9	122	27.9	121	28.9	121	29.4	121	29.9	121	30.9		
	7.0	6.0	127	27.6	127	28.6	127	29.5	127	30.0	126	30.5	126	31.4		
	9.0	7.9	133	28.3	133	29.2	133	30.1	132	30.5	132	31.0	131	31.7		
11.0	9.8	139	28.9	139	29.8	139	30.6	139	31.1	138	31.5	131	30.0			
13.0	11.8	146	29.5	146	30.3	145	31.2	145	31.6	143	31.4	131	28.3			
15.0	13.7	152	30.1	152	30.9	152	31.6	149	31.3	143	29.8	131	26.9			
120% 127.68 kW	-19.8	-20.0	70.0	17.1	69.7	18.8	69.4	20.4	69.2	21.2	69.1	22.0	68.8	23.7		
	-18.8	-19.0	71.4	17.6	71.1	19.2	70.8	20.9	70.6	21.7	70.5	22.5	70.2	24.1		
	-16.7	-17.0	74.4	18.7	74.1	20.2	73.8	21.8	73.6	22.5	73.5	23.3	73.2	24.8		
	-13.7	-15.0	77.7	19.7	77.4	21.2	77.1	22.7	76.9	23.4	76.8	24.1	76.5	25.6		
	-11.8	-13.0	81.2	20.7	80.9	22.1	80.6	23.6	80.4	24.3	80.3	25.0	80.0	26.4		
	-9.8	-11.0	84.9	21.7	84.6	23.1	84.3	24.4	84.2	25.1	84.0	25.8	83.7	27.1		
	-9.5	-10.0	86.9	22.2	86.6	23.5	86.3	24.8	86.2	25.5	86.0	26.1	85.7	27.4		
	-8.5	-9.1	88.8	22.6	88.5	23.9	88.2	25.2	88.0	25.8	87.9	26.5	87.6	27.8		
	-7.0	-7.6	91.9	23.3	91.6	24.6	91.3	25.8	91.2	26.4	91.0	27.0	90.7	28.3		
	-5.0	-5.6	96.4	24.2	96.1	25.4	95.8	26.6	95.6	27.2	95.5	27.8	95.2	28.9		
	-3.0	-3.7	101	25.1	101	26.2	100	27.3	100	27.9	100	28.4	100	29.5		
	0.0	-0.7	108	26.3	108	27.3	108	28.4	108	28.9	107	29.4	107	30.4		
	3.0	2.2	116	27.4	116	28.4	115	29.3	115	29.8	115	30.3	115	31.3		
	5.0	4.1	121	28.1	121	29.0	121	29.9	121	30.4	121	30.8	120	31.8		
	7.0	6.0	127	28.7	127	29.6	126	30.5	126	30.9	126	31.3	121	30.4		
	9.0	7.9	133	29.3	133	30.2	132	31.0	132	31.4	132	31.8	121	28.8		
11.0	9.8	139	29.9	139	30.7	138	31.5	138	31.8	132	30.3	121	27.3			
13.0	11.8	146	30.5	145	31.2	143	31.4	138	30.0	132	28.6	121	25.8			
15.0	13.7	152	31.0	152	31.7	143	29.8	138	28.4	132	27.1	121	24.5			
110% 117.04 kW	-19.8	-20.0	69.6	19.2	69.3	20.7	69.0	22.2	68.9	22.9	68.8	23.7	68.5	25.2		
	-18.8	-19.0	71.0	19.6	70.7	21.1	70.4	22.6	70.3	23.3	70.2	24.1	69.9	25.6		
	-16.7	-17.0	74.0	20.6	73.7	22.0	73.5	23.4	73.3	24.1	73.2	24.8	72.9	26.3		
	-13.7	-15.0	77.3	21.6	77.0	22.9	76.7	24.3	76.6	24.9	76.5	25.6	76.2	27.0		
	-11.8	-13.0	80.8	22.5	80.5	23.8	80.2	25.1	80.1	25.7	80.0	26.4	79.7	27.6		
	-9.8	-11.0	84.6	23.4	84.3	24.6	84.0	25.9	83.9	26.5	83.7	27.1	83.5	28.3		
	-9.5	-10.0	86.5	23.9	86.3	25.1	86.0	26.3	85.9	26.9	85.7	27.4	85.4	28.6		
	-8.5	-9.1	88.4	24.2	88.1	25.4	87.8	26.6	87.7	27.2	87.6	27.8	87.3	28.9		
	-7.0	-7.6	91.6	24.9	91.3	26.0	91.0	27.2	90.9	27.7	90.7	28.3	90.4	29.4		
	-5.0	-5.6	96.0	25.7	95.7	26.8	95.4	27.9	95.3	28.4	95.2	28.9	94.9	30.0		
	-3.0	-3.7	100	26.5	100	27.5	100	28.5	100	29.0	100	29.5	99	30.6		
	0.0	-0.7	108	27.6	108	28.5	107	29.5	107	30.0	107	30.4	107	31.4		
	3.0	2.2	116	28.6	115	29.5	115	30.4	115	30.8	115	31.3	111	30.7		
	5.0	4.1	121	29.2	121	30.1	121	30.9	120	31.3	120	31.8	111	29.0		
	7.0	6.0	127	29.8	126	30.6	126	31.4	126	31.8	121	30.4	111	27.5		
	9.0	7.9	133	30.4	132	31.1	131	31.7	126	30.2	121	28.8	111	26.0		
11.0	9.8	139	30.9	138	31.6	131	30.0	126	28.6	121	27.3	111	24.7			
13.0	11.8	145	31.4	142	31.0	131	28.3	126	27.1	121	25.8	111	23.4			
15.0	13.7	152	31.9	142	29.3	131	26.9	126	25.7	121	24.5	111	22.2			
100% 106.40 kW	-19.8	-20.0	69.2	21.2	69.0	22.6	68.7	24.0	68.6	24.6	68.4	25.3	68.2	26.7		
	-18.8	-19.0	70.6	21.7	70.4	23.0	70.1	24.3	70.0	25.0	69.9	25.7	69.6	27.0		
	-16.7	-17.0	73.6	22.5	73.4	23.8	73.1	25.1	73.0	25.7	72.9	26.4	72.6	27.7		
	-13.7	-15.0	76.9	23.4	76.7	24.6	76.4	25.9	76.3	26.5	76.1	27.1	75.9	28.3		
	-11.8	-13.0	80.4	24.3	80.2	25.4	79.9	26.6	79.8	27.2	79.7	27.8	79.4	28.9		
	-9.8	-11.0	84.2	25.1	83.9	26.2	83.7	27.3	83.6	27.9	83.4	28.4	83.2	29.5		
	-9.5	-10.0	86.2	25.5	85.9	26.6	85.7	27.7	85.5	28.2	85.4	28.8	85.2	29.8		
	-8.5	-9.1	88.0	25.8	87.8	26.9	87.5	28.0	87.4	28.5	87.2	29.0	87.0	30.1		
	-7.0	-7.6	91.2	26.4	90.9	27.5	90.7	28.5	90.5	29.0	90.4	29.5	90.2	30.5		
	-5.0	-5.6	95.6	27.2	95.4	28.2	95.1	29.1	95.0	29.6	94.9	30.1	94.6	31.1		
	-3.0	-3.7	100	27.9	100	28.8	100	29.7	99	30.2	99	30.7	99	31.6		
	0.0	-0.7	108	28.9	107	29.8	107	30.6	107	31.1	107	31.5	101	29.8		
	3.0	2.2	115	29.8	115	30.6	115	31.4	115	31.8	110	30.4	101	27.4		
	5.0	4.1	121	30.4	120	31.1	120	31.6	115	30.2	110	28.7	101	25.9		
	7.0	6.0	126	30.9	126	31.6	120	29.9	115	28.5	110	27.2	101	24.6		
	9.0	7.9	132	31.4	129	30.9	120	28.3	115	27.0	110	25.8	101	23.3		
11.0	9.8	138	31.8	129	29.3	120	26.8	115	25.6	110	24.4	101	22.1			
13.0	11.8	138	30.0	129	27.6	120	25.4	115	24.2	110	23.1	101	21.0			
15.0	13.7	138	28.4	129	26.2	120	24.1	115	23.0	110	22.0	101	20.0			

NOTES - ANMERKUNGEN - Σημειώσεις - NOTAS - REMARQUES - NOTE - OPMERKINGEN - примечания - NOTLAR

- █ is shown as reference. When selecting the unit models, avoid the Outdoor air temperature range shown by █.

█ dient als Verweis. Vermeiden Sie bei der Auswahl der Gerätemodelle den als markierten Temperaturbereich der Außenluft.

Н █ είναι ενδεικτική, κατά την επιλογή των μοντέλων των μονάδων, αποφεύγετε το εύρος θερμοκρασίας εξωτερικού αέρα που υποδεικνύεται █.

█ se muestra como referencia. Cuando seleccione los modelos de unidad, evite el intervalo de temperaturas del aire exterior indicado mediante █.

█ est montré comme référence. Lors du choix des modèles d'unités, évitez la plage de températures de l'air extérieur illustré par █.

█ valori riportati unicamente come riferimento. Nel selezionare i modelli delle unità, non considerare i valori di temperatura dell'aria esterna indicati con il colore █.

█ is als referentie getoond. Wanneer modellen van eenheden worden gekozen, vermijd dan het bereik van buitenluchttemperaturen geïllustreerd door █.

█ показан как. При выборе модели устройства избегайте внешнюю температуру воздуха, указанную в █.

█ referans olarak gösterilmektedir. Ünite modellerini seçerken, belirtilen Dış hava sıcaklığı aralığından kaçınınız █.

The above table shows the average value of conditions which may occur.

Die obige Tabelle zeigt den Durchschnittswert der Bedingungen, die auftreten können.

Στον παραπάνω πίνακα αναγράφεται η μέση τιμή για συνθήκες που μπορεί να προκύψουν.

La tabla de arriba muestra el valor medio de condiciones que pueden ocurrir.

Le tableau ci-dessus donne la valeur moyenne pour des conditions qui peuvent survenir.

La tabella in alto mostra il valore delle condizioni medie che si possono riscontrare.

De tabel hierboven geeft de gemiddelde waarde aan van situaties die kunnen voorkomen.

Таблица расположенная выше показывает среднее значение условий, которые могут наступить.

Yukarıdaki tablo meydana gelebilecek koşulların ortalama değerini göstermektedir.

3D079549

5 Таблицы производительности

5 - 2 Таблицы теплопроизводительностей

5

RXYQ38T														
Indoor air temp. °CDB														
Combination (%) (Capacity index)	Outdoor air temp.		16.0		18.0		20.0		21.0		22.0		24.0	
			TC	PI	TC	PI	TC	PI	TC	PI	TC	PI	TC	PI
	(°CDB)	(°CWB)	KW	KW	KW	KW	KW	KW	KW	KW	KW	KW	KW	KW
90% 95.76 kW	-19.8	-20.0	68.8	23.3	68.6	24.5	68.4	25.7	68.3	26.4	68.1	27.0	67.9	28.2
	-18.8	-19.0	70.2	23.7	70.0	24.9	69.8	26.1	69.7	26.7	69.6	27.3	69.3	28.5
	-16.7	-17.0	73.3	24.5	73.0	25.6	72.8	26.8	72.7	27.4	72.6	27.9	72.4	29.1
	-13.7	-15.0	76.5	25.2	76.3	26.3	76.1	27.5	76.0	28.0	75.8	28.6	75.6	29.7
	-11.8	-13.0	80.0	26.0	79.8	27.1	79.6	28.1	79.5	28.6	79.4	29.2	79.1	30.2
	-9.8	-11.0	83.8	26.8	83.6	27.8	83.4	28.8	83.2	29.3	83.1	29.8	82.9	30.8
	-9.5	-10.0	85.8	27.1	85.6	28.1	85.3	29.1	85.2	29.6	85.1	30.1	84.9	31.0
	-8.5	-9.1	87.6	27.4	87.4	28.4	87.2	29.4	87.1	29.8	86.9	30.3	86.7	31.3
	-7.0	-7.6	90.8	28.0	90.6	28.9	90.3	29.8	90.2	30.3	90.1	30.7	89.9	31.7
	-5.0	-5.6	95.2	28.7	95.0	29.5	94.8	30.4	94.7	30.9	94.6	31.3	91.0	30.4
	-3.0	-3.7	100	29.3	99	30.1	99	30.9	99	31.4	99	31.8	91.0	28.8
	0.0	-0.7	107	30.2	107	31.0	107	31.7	103	30.6	99	29.2	91.0	26.3
	3.0	2.2	115	31.0	115	31.7	108	29.5	103	28.1	99	26.8	91.0	24.2
	5.0	4.1	120	31.5	116	30.4	108	27.9	103	26.6	99	25.4	91.0	23.0
	7.0	6.0	124	31.3	116	28.8	108	26.4	103	25.2	99	24.1	91.0	21.8
	9.0	7.9	124	29.6	116	27.3	108	25.0	103	23.9	99	22.8	91.0	20.7
	11.0	9.8	124	28.0	116	25.8	108	23.7	103	22.7	99	21.7	91.0	19.7
13.0	11.8	124	26.5	116	24.5	108	22.5	103	21.5	99	20.6	91.0	18.7	
15.0	13.7	124	25.1	116	23.2	108	21.4	103	20.5	99	19.6	91.0	17.8	
80% 85.12 kW	-19.8	-20.0	68.4	25.3	68.2	26.4	68.0	27.5	67.9	28.1	67.8	28.6	67.6	29.7
	-18.8	-19.0	69.9	25.7	69.7	26.8	69.5	27.8	69.4	28.4	69.3	28.9	69.1	30.0
	-16.7	-17.0	72.9	26.4	72.7	27.4	72.5	28.4	72.4	29.0	72.3	29.5	72.1	30.5
	-13.7	-15.0	76.1	27.1	75.9	28.1	75.7	29.0	75.6	29.5	75.5	30.0	75.3	31.0
	-11.8	-13.0	79.7	27.8	79.5	28.7	79.3	29.6	79.2	30.1	79.1	30.6	78.9	31.5
	-9.8	-11.0	83.4	28.4	83.2	29.3	83.0	30.2	82.9	30.7	82.8	31.1	80.9	31.0
	-9.5	-10.0	85.4	28.8	85.2	29.6	85.0	30.5	84.9	30.9	84.8	31.4	80.9	30.1
	-8.5	-9.1	87.2	29.0	87.0	29.9	86.8	30.8	86.7	31.2	86.6	31.6	80.9	29.3
	-7.0	-7.6	90.4	29.5	90.2	30.3	90.0	31.2	89.9	31.6	89.8	31.1	80.9	28.0
	-5.0	-5.6	94.9	30.1	94.7	30.9	94.5	31.7	91.9	30.8	88.2	29.3	80.9	26.5
	-3.0	-3.7	99	30.7	99	31.4	95.6	30.5	91.9	29.1	88.2	27.7	80.9	25.1
	0.0	-0.7	107	31.5	103	30.5	95.6	27.9	91.9	26.7	88.2	25.4	80.9	23.0
	3.0	2.2	110	30.4	103	28.0	95.6	25.7	91.9	24.5	88.2	23.4	80.9	21.2
	5.0	4.1	110	28.7	103	26.5	95.6	24.3	91.9	23.3	88.2	22.2	80.9	20.2
	7.0	6.0	110	27.2	103	25.1	95.6	23.1	91.9	22.1	88.2	21.1	80.9	19.2
	9.0	7.9	110	25.8	103	23.8	95.6	21.9	91.9	21.0	88.2	20.0	80.9	18.2
	11.0	9.8	110	24.4	103	22.6	95.6	20.8	91.9	19.9	88.2	19.1	80.9	17.4
13.0	11.8	110	23.1	103	21.4	95.6	19.7	91.9	18.9	88.2	18.1	80.9	16.5	
15.0	13.7	110	22.0	103	20.4	95.6	18.8	91.9	18.0	88.2	17.3	80.9	15.8	
70% 74.48 kW	-19.8	-20.0	68.1	27.4	67.9	28.4	67.7	29.3	67.6	29.8	67.5	30.3	67.4	31.2
	-18.8	-19.0	69.5	27.7	69.3	28.6	69.1	29.6	69.0	30.0	69.0	30.5	68.8	31.5
	-16.7	-17.0	72.5	28.3	72.3	29.2	72.2	30.1	72.1	30.6	72.0	31.0	70.8	31.2
	-13.7	-15.0	75.8	28.9	75.6	29.8	75.4	30.6	75.3	31.1	75.2	31.5	70.8	29.5
	-11.8	-13.0	79.3	29.5	79.1	30.3	78.9	31.2	78.9	31.6	77.2	31.0	70.8	28.0
	-9.8	-11.0	83.1	30.1	82.9	30.9	82.7	31.7	80.4	30.7	77.2	29.3	70.8	26.4
	-9.5	-10.0	85.0	30.4	84.9	31.2	83.7	31.3	80.4	29.9	77.2	28.5	70.8	25.7
	-8.5	-9.1	86.9	30.6	86.7	31.4	83.7	30.5	80.4	29.1	77.2	27.7	70.8	25.1
	-7.0	-7.6	90.0	31.1	89.9	31.8	83.7	29.2	80.4	27.9	77.2	26.6	70.8	24.0
	-5.0	-5.6	94.5	31.6	90.1	30.1	83.7	27.5	80.4	26.3	77.2	25.1	70.8	22.7
	-3.0	-3.7	96.5	30.9	90.1	28.4	83.7	26.1	80.4	24.9	77.2	23.8	70.8	21.5
	0.0	-0.7	96.5	28.2	90.1	26.0	83.7	23.9	80.4	22.9	77.2	21.8	70.8	19.8
	3.0	2.2	96.5	25.9	90.1	24.0	83.7	22.0	80.4	21.1	77.2	20.2	70.8	18.4
	5.0	4.1	96.5	24.6	90.1	22.7	83.7	20.9	80.4	20.0	77.2	19.2	70.8	17.5
	7.0	6.0	96.5	23.3	90.1	21.6	83.7	19.9	80.4	19.1	77.2	18.2	70.8	16.6
	9.0	7.9	96.5	22.1	90.1	20.5	83.7	18.9	80.4	18.1	77.2	17.4	70.8	15.9
	11.0	9.8	96.5	21.0	90.1	19.5	83.7	18.0	80.4	17.3	77.2	16.6	70.8	15.1
13.0	11.8	96.5	20.0	90.1	18.5	83.7	17.1	80.4	16.4	77.2	15.8	70.8	14.4	
15.0	13.7	96.5	19.0	90.1	17.7	83.7	16.3	80.4	15.7	77.2	15.0	70.8	13.8	
60% 63.84 kW	-19.8	-20.0	67.7	29.4	67.5	30.3	67.4	31.1	67.3	31.5	66.2	31.1	60.7	28.1
	-18.8	-19.0	69.1	29.7	69.0	30.5	68.8	31.3	68.7	31.7	66.2	30.3	60.7	27.4
	-16.7	-17.0	72.1	30.2	72.0	31.0	71.7	31.7	68.9	30.2	66.2	28.8	60.7	26.0
	-13.7	-15.0	75.4	30.8	75.2	31.5	71.7	30.0	68.9	28.6	66.2	27.3	60.7	24.7
	-11.8	-13.0	78.9	31.3	77.2	31.0	71.7	28.4	68.9	27.1	66.2	25.8	60.7	23.4
	-9.8	-11.0	82.7	31.8	77.2	29.3	71.7	26.8	68.9	25.6	66.2	24.5	60.7	22.2
	-9.5	-10.0	82.7	30.9	77.2	28.5	71.7	26.1	68.9	24.9	66.2	23.8	60.7	21.6
	-8.5	-9.1	82.7	30.1	77.2	27.7	71.7	25.4	68.9	24.3	66.2	23.2	60.7	21.1
	-7.0	-7.6	82.7	28.8	77.2	26.6	71.7	24.4	68.9	23.3	66.2	22.3	60.7	20.2
	-5.0	-5.6	82.7	27.2	77.2	25.1	71.7	23.0	68.9	22.1	66.2	21.1	60.7	19.2
	-3.0	-3.7	82.7	25.7	77.2	23.8	71.7	21.9	68.9	20.9	66.2	20.0	60.7	18.2
	0.0	-0.7	82.7	23.6	77.2	21.8	71.7	20.1	68.9	19.3	66.2	18.5	60.7	16.8
	3.0	2.2	82.7	21.8	77.2	20.2	71.7	18.6	68.9	17.9	66.2	17.1	60.7	15.6
	5.0	4.1	82.7	20.7	77.2	19.2	71.7	17.7	68.9	17.0	66.2	16.3	60.7	14.9
	7.0	6.0	82.7	19.6	77.2	18.2	71.7	16.9	68.9	16.2	66.2	15.5	60.7	14.2
	9.0	7.9	82.7	18.7	77.2	17.4	71.7	16.1	68.9	15.4	66.2	14.8	60.7	13.6
	11.0	9.8	82.7	17.8	77.2	16.6	71.7	15.3	68.9	14.7	66.2	14.1	60.7	13.0
13.0	11.8	82.7	16.9	77.2	15.8	71.7	14.6	68.9	14.0	66.2	13.5	60.7	12.4	
15.0	13.7	82.7	16.1	77.2	15.0	71.7	14.0	68.9	13.4	66.2	12.9	60.7	11.9	
50% 53.20 kW	-19.8	-20.0	67.3	31.5	64.3	30.1	59.8	27.6	57.5	26.3	55.2	25.1	50.6	22.7
	-18.8	-19.0	68.7	31.7	64.3	29.3	59.8	26.9	57.5	25.7	55.2	24.5	50.6	22.2
	-16.7	-17.0	68.9	30.2	64.3	27.9	59.8	25.5	57.5	24.4	55.2	23.3	50.6	21.1
	-13.7	-15.0	68.9	28.6	64.3	26.4	59.8	24.2	57.5	23.2	55.2	22.1	50.6	20.1
	-11.8	-13.0	68.9	27.1	64.3	25.0	59.8	23.0	57.5	22.0	55.2	21.0	50.6	19.1
	-9.8	-11.0	68.9	25.6	64.3	23.7	59.8	21.8	57.5	20.9	55.2	19.9	50.6	18.2
	-9.5	-10.0	68.9	24.9	64.3	23.0	59.8	21.2	57.5	20.3	55.2	19.4	50.6	17.7
	-8.5	-9.1	68.9	24.3	64.3	22.5	59.8	20.7	57.5	19.8	55.2	19.0	50.6	17.3
	-7.0	-7.6	68.9	23.3	64.3	21.6	59.8	19.9	57.5	19.1	55.2	18.2	50.6	16.6
	-5.0	-5.6	68.9	22.1	64.3	20.4	59.8	18.8	57.5	18.1	55.2	17.3	50.6	15.8
	-3.0	-3.7	68.9	20.9	64.3	19.4	59.8	17.9	57.5	17.2	55.2	16.5	50.6	15.1
	0.0	-0.7	68.9	19.3	64.3	17.9	59.8	16.6	57.5	15.9	55.2	15.3	50.6	14.0
	3.0	2.2	68.9	17.9	64.3	16.6								

5 Таблицы производительности

5 - 2 Таблицы теплопроизводительностей

RXYQ40T		Indoor air temp. °CDB												
		16.0		18.0		20.0		21.0		22.0		24.0		
Combination(%) (Capacity index)	Outdoor air temp.		TC	PI	TC	PI	TC	PI	TC	PI	TC	PI	TC	PI
	(°CDB)	(°CWB)	KW	KW	KW	KW	KW	KW	KW	KW	KW	KW	KW	KW
130% 144.95 kW	-19.8	-20.0	74.3	16.0	73.9	17.9	73.6	19.7	73.4	20.6	73.3	21.6	72.9	23.4
	-18.8	-19.0	75.8	16.6	75.5	18.4	75.1	20.2	74.9	21.1	74.8	22.0	74.4	23.8
	-16.7	-17.0	79.0	17.8	78.7	19.5	78.3	21.3	78.1	22.1	78.0	23.0	77.6	24.7
	-13.7	-15.0	82.5	19.0	82.1	20.6	81.8	22.3	81.6	23.1	81.4	23.9	81.1	25.6
	-11.8	-13.0	86.2	20.1	85.8	21.7	85.5	23.3	85.3	24.0	85.2	24.8	84.8	26.4
	-9.8	-11.0	90.2	21.2	89.8	22.7	89.5	24.2	89.3	25.0	89.1	25.7	88.8	27.2
	-9.5	-10.0	92.3	21.8	91.9	23.2	91.6	24.7	91.4	25.4	91.2	26.1	90.9	27.6
	-8.5	-9.1	94.2	22.2	93.8	23.7	93.5	25.1	93.3	25.8	93.2	26.5	92.8	28.0
	-7.0	-7.6	97.5	23.0	97.2	24.4	96.8	25.8	96.7	26.5	96.5	27.2	96.2	28.5
	-5.0	-5.6	102	24.0	102	25.3	102	26.6	101	27.3	101	28.0	101	29.3
	-3.0	-3.7	107	24.9	107	26.2	106	27.4	106	28.1	106	28.7	106	29.9
	0.0	-0.7	115	26.3	114	27.5	114	28.6	114	29.2	114	29.8	113	30.9
	3.0	2.2	123	27.5	123	28.6	122	29.7	122	30.2	122	30.8	122	31.8
	5.0	4.1	129	28.3	128	29.3	128	30.3	128	30.8	128	31.4	127	32.4
	7.0	6.0	134	29.0	134	30.0	134	30.9	134	31.4	133	31.9	133	32.9
	9.0	7.9	141	29.6	140	30.6	140	31.5	140	32.0	140	32.5	138	32.8
11.0	9.8	147	30.3	147	31.2	146	32.1	146	32.5	146	33.0	138	31.0	
13.0	11.8	154	30.9	154	31.8	153	32.6	153	33.1	150	32.5	138	29.3	
15.0	13.7	161	31.5	160	32.3	160	33.1	156	32.4	150	30.8	138	27.8	
120% 133.80 kW	-19.8	-20.0	73.9	18.2	73.6	19.9	73.3	21.6	73.1	22.4	72.9	23.3	72.6	25.0
	-18.8	-19.0	75.4	18.7	75.1	20.4	74.8	22.0	74.6	22.9	74.5	23.7	74.1	25.4
	-16.7	-17.0	78.6	19.8	78.3	21.4	78.0	23.0	77.8	23.8	77.7	24.6	77.3	26.2
	-13.7	-15.0	82.1	20.9	81.8	22.4	81.4	23.9	81.3	24.7	81.1	25.4	80.8	26.9
	-11.8	-13.0	85.8	21.9	85.5	23.4	85.2	24.8	85.0	25.5	84.8	26.3	84.5	27.7
	-9.8	-11.0	89.8	22.9	89.5	24.3	89.1	25.7	89.0	26.4	88.8	27.1	88.5	28.5
	-9.5	-10.0	91.9	23.4	91.5	24.8	91.2	26.1	91.1	26.8	90.9	27.5	90.6	28.8
	-8.5	-9.1	93.8	23.9	93.5	25.2	93.2	26.5	93.0	27.2	92.8	27.8	92.5	29.2
	-7.0	-7.6	97.1	24.6	96.8	25.9	96.5	27.2	96.3	27.8	96.2	28.4	95.9	29.7
	-5.0	-5.6	102	25.5	102	26.7	101	28.0	101	28.6	101	29.2	101	30.4
	-3.0	-3.7	107	26.4	106	27.5	106	28.7	106	29.3	106	29.8	105	31.0
	0.0	-0.7	114	27.6	114	28.7	114	29.8	114	30.3	113	30.9	113	31.9
	3.0	2.2	123	28.8	122	29.8	122	30.8	122	31.3	122	31.8	121	32.8
	5.0	4.1	128	29.5	128	30.4	128	31.4	127	31.8	127	32.3	127	33.3
	7.0	6.0	134	30.1	134	31.0	133	31.9	133	32.4	133	32.8	127	31.4
	9.0	7.9	140	30.7	140	31.6	140	32.5	139	32.9	138	33.0	127	29.8
11.0	9.8	147	31.3	146	32.2	146	33.0	144	32.8	138	31.3	127	28.2	
13.0	11.8	154	31.9	153	32.7	150	32.5	144	31.0	138	29.6	127	26.7	
15.0	13.7	160	32.4	160	33.2	150	30.8	144	29.4	138	28.0	127	25.3	
110% 122.65 kW	-19.8	-20.0	73.5	20.3	73.2	21.8	72.9	23.4	72.8	24.2	72.6	25.0	72.3	26.5
	-18.8	-19.0	75.0	20.8	74.7	22.3	74.4	23.8	74.3	24.6	74.1	25.4	73.8	26.9
	-16.7	-17.0	78.2	21.8	77.9	23.2	77.6	24.7	77.5	25.4	77.3	26.2	77.1	27.6
	-13.7	-15.0	81.7	22.8	81.4	24.2	81.1	25.6	80.9	26.2	80.8	26.9	80.5	28.3
	-11.8	-13.0	85.4	23.7	85.1	25.1	84.8	26.4	84.7	27.1	84.5	27.7	84.2	29.0
	-9.8	-11.0	89.4	24.7	89.1	25.9	88.8	27.2	88.7	27.8	88.5	28.5	88.2	29.7
	-9.5	-10.0	91.5	25.1	91.2	26.4	90.9	27.6	90.7	28.2	90.6	28.8	90.3	30.1
	-8.5	-9.1	93.4	25.5	93.1	26.7	92.8	28.0	92.7	28.6	92.5	29.2	92.2	30.4
	-7.0	-7.6	96.7	26.2	96.5	27.4	96.2	28.5	96.0	29.1	95.9	29.7	95.6	30.9
	-5.0	-5.6	101	27.0	101	28.2	101	29.3	101	29.8	101	30.4	100	31.5
	-3.0	-3.7	106	27.8	106	28.9	106	29.9	105	30.5	105	31.0	105	32.1
	0.0	-0.7	114	29.0	114	30.0	113	30.9	113	31.4	113	31.9	113	32.9
	3.0	2.2	122	30.0	122	30.9	122	31.8	121	32.3	121	32.8	116	31.7
	5.0	4.1	128	30.6	128	31.5	127	32.4	127	32.8	127	33.3	116	30.0
	7.0	6.0	134	31.2	133	32.1	133	32.9	132	33.0	127	31.4	116	28.4
	9.0	7.9	140	31.8	140	32.6	138	32.8	132	31.3	127	29.8	116	26.9
11.0	9.8	146	32.4	146	33.1	138	31.0	132	29.6	127	28.2	116	25.5	
13.0	11.8	153	32.9	148	32.0	138	29.3	132	28.0	127	26.7	116	24.2	
15.0	13.7	159	33.0	148	30.3	138	27.8	132	26.6	127	25.3	116	23.0	
100% 111.50 kW	-19.8	-20.0	73.1	22.4	72.8	23.8	72.6	25.2	72.4	25.9	72.3	26.7	72.1	28.1
	-18.8	-19.0	74.6	22.9	74.3	24.3	74.1	25.6	74.0	26.3	73.8	27.0	73.6	28.4
	-16.7	-17.0	77.8	23.8	77.6	25.1	77.3	26.4	77.2	27.1	77.0	27.7	76.8	29.1
	-13.7	-15.0	81.3	24.7	81.0	25.9	80.7	27.2	80.6	27.8	80.5	28.5	80.2	29.7
	-11.8	-13.0	85.0	25.5	84.7	26.8	84.5	28.0	84.3	28.6	84.2	29.2	83.9	30.4
	-9.8	-11.0	89.0	26.4	88.7	27.6	88.5	28.7	88.3	29.3	88.2	29.9	87.9	31.0
	-9.5	-10.0	91.1	26.8	90.8	27.9	90.5	29.1	90.4	29.6	90.3	30.2	90.0	31.3
	-8.5	-9.1	93.0	27.2	92.7	28.3	92.5	29.4	92.3	29.9	92.2	30.5	92.0	31.6
	-7.0	-7.6	96.3	27.8	96.1	28.8	95.8	29.9	95.7	30.4	95.6	31.0	95.3	32.0
	-5.0	-5.6	101	28.6	101	29.6	101	30.6	100	31.1	100	31.6	100	32.6
	-3.0	-3.7	106	29.3	105	30.2	105	31.2	105	31.7	105	32.2	105	33.1
	0.0	-0.7	114	30.3	113	31.2	113	32.1	113	32.6	113	33.0	106	30.8
	3.0	2.2	122	31.3	122	32.1	121	32.9	120	32.9	115	31.4	106	28.3
	5.0	4.1	127	31.8	127	32.6	125	32.6	120	31.1	115	29.7	106	26.8
	7.0	6.0	133	32.4	133	33.1	125	30.9	120	29.5	115	28.1	106	25.4
	9.0	7.9	139	32.9	135	31.9	125	29.2	120	27.9	115	26.6	106	24.1
11.0	9.8	144	32.8	135	30.2	125	27.7	120	26.5	115	25.3	106	22.9	
13.0	11.8	144	31.0	135	28.6	125	26.2	120	25.1	115	23.9	106	21.7	
15.0	13.7	144	29.4	135	27.1	125	24.9	120	23.8	115	22.8	106	20.7	

NOTES - ANMERKUNGEN - Σημειώσεις - NOTAS - REMARQUES - NOTE - OPMERKINGEN - примечания - NOTLAR

1. [] is shown as reference. When selecting the unit models, avoid the Outdoor air temperature range shown by [].
 dient als Verweis. Vermeiden Sie bei der Auswahl der Gerätemodelle den als markierten Temperaturbereich der Außenluft.
 Η [] είναι ενδεικτική, κατά την επιλογή των μοντέλων των μονάδων, αποφεύγετε το εύρος θερμοκρασίας εξωτερικού αέρα που υποδεικνύεται [].
 se muestra como referencia. Cuando seleccione los modelos de unidad, evite el intervalo de temperaturas del aire exterior indicado mediante [].
 est montré comme référence. Lors du choix des modèles d'unités, évitez la plage de températures de l'air extérieur illustré par [].
 valori riportati unicamente come riferimento. Nel selezionare i modelli delle unità, non considerare i valori di temperatura dell'aria esterna indicati con il colore [].
 is als referentie getoond. Wanneer modellen van eenheden worden gekozen, vermijd dan het bereik van buitenluchttemperaturen geïllustreerd door [].

2. The above table shows the average value of conditions which may occur.
 Die obige Tabelle zeigt den Durchschnittswert der Bedingungen, die auftreten können.
 Στον παραπάνω πίνακα αναγράφεται η μέση τιμή για συνθήκες που μπορεί να προκύψουν.
 La tabla de arriba muestra el valor medio de condiciones que pueden ocurrir.
 Le tableau ci-dessus donne la valeur moyenne pour des conditions qui peuvent survenir.
 La tabella in alto mostra il valore delle condizioni medie che si possono riscontrare.
 De tabel hierboven geeft de gemiddelde waarde aan van situaties die kunnen voorvallen.
 Таблица расположенная выше показывает среднее значение условий, которые могут наступить.
 Yukarıdaki tablo meydana gelebilecek koşulların ortalama değerini göstermektedir.

5 Таблицы производительности

5 - 2 Таблицы теплопроизводительностей

5

RXYQ40T														
Indoor air temp. °CDB														
Combination (%) (Capacity index)	Outdoor air temp.		16.0		18.0		20.0		21.0		22.0		24.0	
			TC	PI	TC	PI	TC	PI	TC	PI	TC	PI	TC	PI
	(°CDB)	(°CWB)	KW	KW	KW	KW	KW	KW	KW	KW	KW	KW	KW	KW
90% 100.35kW	-19.8	-20.0	72.7	24.5	72.5	25.8	72.2	27.1	72.1	27.7	72.0	28.4	71.8	29.6
	-18.8	-19.0	74.2	24.9	74.0	26.2	73.7	27.4	73.6	28.1	73.5	28.7	73.3	29.9
	-16.7	-17.0	77.4	25.8	77.2	27.0	76.9	28.1	76.8	28.7	76.7	29.3	76.5	30.5
	-13.7	-15.0	80.9	26.6	80.6	27.7	80.4	28.8	80.3	29.4	80.2	30.0	79.9	31.1
	-11.8	-13.0	84.6	27.4	84.4	28.4	84.1	29.5	84.0	30.1	83.9	30.6	83.7	31.7
	-9.8	-11.0	88.6	28.1	88.3	29.2	88.1	30.2	88.0	30.7	87.9	31.2	87.6	32.3
	-9.5	-10.0	90.7	28.5	90.4	29.5	90.2	30.5	90.1	31.0	90.0	31.5	89.7	32.6
	-8.5	-9.1	92.6	28.8	92.4	29.8	92.1	30.8	92.0	31.3	91.9	31.8	91.7	32.8
	-7.0	-7.6	96.0	29.4	95.7	30.3	95.5	31.3	95.4	31.8	95.2	32.2	95.0	33.2
	-5.0	-5.6	101	30.1	100	31.0	100	31.9	100	32.3	100	32.8	95.2	34.4
	-3.0	-3.7	105	30.7	105	31.6	105	32.4	105	32.9	104	32.9	95.2	29.7
	0.0	-0.7	113	31.7	113	32.5	113	33.2	108	31.6	104	30.1	95.2	27.2
	3.0	2.2	121	32.5	121	33.3	113	30.4	108	29.0	104	27.7	95.2	25.0
	5.0	4.1	127	33.0	121	31.4	113	28.8	108	27.5	104	26.2	95.2	23.7
	7.0	6.0	130	32.3	121	29.8	113	27.3	108	26.1	104	24.9	95.2	22.5
	9.0	7.9	130	30.6	121	28.2	113	25.9	108	24.7	104	23.6	95.2	21.4
	11.0	9.8	130	29.0	121	26.7	113	24.5	108	23.5	104	22.4	95.2	20.4
13.0	11.8	130	27.4	121	25.3	113	23.3	108	22.3	104	21.3	95.2	19.4	
15.0	13.7	130	26.0	121	24.0	113	22.1	108	21.2	104	20.3	95.2	18.5	
80% 89.20 kW	-19.8	-20.0	72.3	26.7	72.1	27.8	71.9	28.9	71.8	29.5	71.7	30.0	71.5	31.2
	-18.8	-19.0	73.8	27.0	73.6	28.1	73.4	29.2	73.3	29.8	73.2	30.3	73.0	31.4
	-16.7	-17.0	77.0	27.7	76.8	28.8	76.6	29.9	76.5	30.4	76.4	30.9	76.2	32.0
	-13.7	-15.0	80.5	28.5	80.3	29.5	80.1	30.5	80.0	31.0	79.9	31.5	79.6	32.5
	-11.8	-13.0	84.2	29.2	84.0	30.1	83.8	31.1	83.7	31.6	83.6	32.1	83.4	33.0
	-9.8	-11.0	88.2	29.9	88.0	30.8	87.8	31.7	87.7	32.2	87.6	32.6	87.4	31.9
	-9.5	-10.0	90.3	30.2	90.1	31.1	89.9	32.0	89.8	32.4	89.6	32.9	89.4	31.0
	-8.5	-9.1	92.2	30.5	92.0	31.4	91.8	32.2	91.7	32.7	91.6	33.1	91.4	30.2
	-7.0	-7.6	95.6	31.0	95.3	31.8	95.1	32.7	95.0	33.1	92.3	32.1	84.6	28.9
	-5.0	-5.6	100	31.6	100	32.4	100	33.2	96.2	31.8	92.3	30.2	84.6	27.3
	-3.0	-3.7	105	32.2	105	32.9	100	31.5	96.2	30.0	92.3	28.6	84.6	25.9
	0.0	-0.7	113	33.0	108	31.5	100	28.8	96.2	27.5	92.3	26.2	84.6	23.8
	3.0	2.2	115	31.4	108	28.9	100	26.5	96.2	25.3	92.3	24.2	84.6	21.9
	5.0	4.1	115	29.7	108	27.4	100	25.1	96.2	24.0	92.3	22.9	84.6	20.8
	7.0	6.0	115	28.1	108	25.9	100	23.8	96.2	22.8	92.3	21.8	84.6	19.8
	9.0	7.9	115	26.6	108	24.6	100	22.6	96.2	21.7	92.3	20.7	84.6	18.9
	11.0	9.8	115	25.3	108	23.4	100	21.5	96.2	20.6	92.3	19.7	84.6	18.0
13.0	11.8	115	23.9	108	22.2	100	20.4	96.2	19.6	92.3	18.7	84.6	17.1	
15.0	13.7	115	22.8	108	21.1	100	19.5	96.2	18.7	92.3	17.9	84.6	16.3	
70% 78.05 kW	-19.8	-20.0	71.9	28.8	71.7	29.8	71.6	30.8	71.5	31.3	71.4	31.7	71.2	32.7
	-18.8	-19.0	73.4	29.1	73.2	30.1	73.1	31.0	73.0	31.5	72.9	32.0	72.7	33.0
	-16.7	-17.0	76.6	29.7	76.4	30.7	76.3	31.6	76.2	32.1	76.1	32.5	74.0	32.2
	-13.7	-15.0	80.1	30.4	79.9	31.2	79.7	32.1	79.6	32.6	79.5	33.0	74.0	30.5
	-11.8	-13.0	83.8	31.0	83.6	31.8	83.4	32.7	83.4	33.1	80.8	32.0	74.0	28.8
	-9.8	-11.0	87.8	31.6	87.6	32.4	87.4	33.2	84.1	31.7	80.8	30.2	74.0	27.3
	-9.5	-10.0	89.9	31.9	89.7	32.7	87.5	32.3	84.1	30.8	80.8	29.3	74.0	26.5
	-8.5	-9.1	91.8	32.1	91.6	32.9	87.5	31.4	84.1	30.0	80.8	28.6	74.0	25.8
	-7.0	-7.6	95.2	32.6	94.2	32.9	87.5	30.1	84.1	28.7	80.8	27.4	74.0	24.8
	-5.0	-5.6	100	33.1	94.2	31.0	87.5	28.4	84.1	27.1	80.8	25.9	74.0	23.4
	-3.0	-3.7	101	31.8	94.2	29.3	87.5	26.9	84.1	25.7	80.8	24.5	74.0	22.2
	0.0	-0.7	101	29.1	94.2	26.9	87.5	24.7	84.1	23.6	80.8	22.6	74.0	20.5
	3.0	2.2	101	26.8	94.2	24.8	87.5	22.8	84.1	21.8	80.8	20.8	74.0	19.0
	5.0	4.1	101	25.4	94.2	23.5	87.5	21.6	84.1	20.7	80.8	19.8	74.0	18.0
	7.0	6.0	101	24.1	94.2	22.3	87.5	20.5	84.1	19.7	80.8	18.8	74.0	17.2
	9.0	7.9	101	22.9	94.2	21.2	87.5	19.5	84.1	18.7	80.8	17.9	74.0	16.4
	11.0	9.8	101	21.7	94.2	20.2	87.5	18.6	84.1	17.9	80.8	17.1	74.0	15.6
13.0	11.8	101	20.6	94.2	19.1	87.5	17.7	84.1	17.0	80.8	16.3	74.0	14.9	
15.0	13.7	101	19.7	94.2	18.3	87.5	16.9	84.1	16.2	80.8	15.6	74.0	14.3	
60% 66.90 kW	-19.8	-20.0	71.5	30.9	71.4	31.7	71.2	32.6	71.1	33.0	69.2	32.1	63.5	28.9
	-18.8	-19.0	73.0	31.2	72.9	32.0	72.7	32.8	72.1	32.9	69.2	31.3	63.5	28.2
	-16.7	-17.0	76.2	31.7	76.1	32.5	75.0	32.7	72.1	31.2	69.2	29.7	63.5	26.8
	-13.7	-15.0	79.7	32.3	79.5	33.0	75.0	30.9	72.1	29.5	69.2	28.1	63.5	25.4
	-11.8	-13.0	83.4	32.8	80.8	32.0	75.0	29.3	72.1	27.9	69.2	26.6	63.5	24.1
	-9.8	-11.0	86.5	32.8	80.8	30.2	75.0	27.7	72.1	26.4	69.2	25.2	63.5	22.9
	-9.5	-10.0	86.5	31.9	80.8	29.3	75.0	26.9	72.1	25.7	69.2	24.5	63.5	22.2
	-8.5	-9.1	86.5	31.0	80.8	28.6	75.0	26.2	72.1	25.1	69.2	23.9	63.5	21.7
	-7.0	-7.6	86.5	29.7	80.8	27.4	75.0	25.1	72.1	24.0	69.2	23.0	63.5	20.9
	-5.0	-5.6	86.5	28.0	80.8	25.9	75.0	23.8	72.1	22.7	69.2	21.7	63.5	19.8
	-3.0	-3.7	86.5	26.5	80.8	24.5	75.0	22.6	72.1	21.6	69.2	20.6	63.5	18.8
	0.0	-0.7	86.5	24.4	80.8	22.6	75.0	20.8	72.1	19.9	69.2	19.1	63.5	17.4
	3.0	2.2	86.5	22.5	80.8	20.8	75.0	19.2	72.1	18.4	69.2	17.7	63.5	16.1
	5.0	4.1	86.5	21.4	80.8	19.8	75.0	18.3	72.1	17.6	69.2	16.8	63.5	15.4
	7.0	6.0	86.5	20.3	80.8	18.8	75.0	17.4	72.1	16.7	69.2	16.0	63.5	14.7
	9.0	7.9	86.5	19.3	80.8	17.9	75.0	16.6	72.1	16.0	69.2	15.3	63.5	14.0
	11.0	9.8	86.5	18.4	80.8	17.1	75.0	15.9	72.1	15.2	69.2	14.6	63.5	13.4
13.0	11.8	86.5	17.5	80.8	16.3	75.0	15.1	72.1	14.5	69.2	14.0	63.5	12.8	
15.0	13.7	86.5	16.7	80.8	15.6	75.0	14.4	72.1	13.9	69.2	13.4	63.5	12.3	
50% 55.75 kW	-19.8	-20.0	71.1	33.0	67.3	31.0	62.5	28.4	60.1	27.2	57.7	25.9	52.9	23.5
	-18.8	-19.0	72.1	32.9	67.3	30.3	62.5	27.7	60.1	26.5	57.7	25.3	52.9	22.9
	-16.7	-17.0	72.1	31.2	67.3	28.7	62.5	26.3	60.1	25.2	57.7	24.0	52.9	21.8
	-13.7	-15.0	72.1	29.5	67.3	27.2	62.5	25.0	60.1	23.9	57.7	22.8	52.9	20.7
	-11.8	-13.0	72.1	27.9	67.3	25.8	62.5	23.7	60.1	22.7	57.7	21.7	52.9	19.7
	-9.8	-11.0	72.1	26.4	67.3	24.4	62.5	22.5	60.1	21.5	57.7	20.6	52.9	18.7
	-9.5	-10.0	72.1	25.7	67.3	23.8	62.5	21.9	60.1	20.9	57.7	20.0	52.9	18.3
	-8.5	-9.1	72.1	25.1	67.3	23.2	62.5	21.4	60.1	20.5	57.7	19.6	52.9	17.8
	-7.0	-7.6	72.1	24.0	67.3	22.3	62.5	20.5	60.1	19.7	57.7	18.8	52.9	17.2
	-5.0	-5.6	72.1	22.7	67.3	21.1	62.5	19.4	60.1	18.6	57.7	17.9	52.9	16.3
	-3.0	-3.7	72.1	21.6	67.3	20.0	62.5	18.5	60.1	17.7	57.7	17.0	52.9	15.5
	0.0	-0.7	72.1	19.9	67.3	18.5	62.5	17.1	60.1	16.4	57.7	15.8	52.9	14.4
	3.0	2.2	72.1	18.4	67.3	17.1	62.5							

5 Таблицы производительности

5 - 2 Таблицы теплопроизводительностей

RXYQ42T		Indoor air temp. °CDB												
Combination(%) (Capacity index)	Outdoor air temp.		16.0		18.0		20.0		21.0		22.0		24.0	
	(°CDB)	(°CWB)	TC	PI	TC	PI	TC	PI	TC	PI	TC	PI	TC	PI
130% 153.40 kW	-19.8	-20.0	78.7	17.5	78.3	19.5	78.0	21.5	77.8	22.5	77.6	23.4	77.3	25.41
	-18.8	-19.0	80.3	18.2	79.9	20.1	79.6	22.0	79.4	23.0	79.2	23.9	78.8	25.87
	-16.7	-17.0	83.7	19.4	83.3	21.3	82.9	23.1	82.8	24.0	82.6	24.9	82.2	26.79
	-13.7	-15.0	87.3	20.7	87.0	22.4	86.6	24.2	86.4	25.1	86.2	25.9	85.9	27.7
	-11.8	-13.0	91.3	21.9	90.9	23.6	90.5	25.2	90.4	26.1	90.2	26.9	89.8	28.6
	-9.8	-11.0	95.5	23.1	95.1	24.7	94.8	26.3	94.6	27.1	94.4	27.9	94.0	29.5
	-9.5	-10.0	97.7	23.6	97.3	25.2	97.0	26.8	96.8	27.5	96.6	28.3	96.2	29.9
	-8.5	-9.1	99.7	24.2	99.4	25.7	99.0	27.2	98.8	28.0	98.7	28.7	98.3	30.3
	-7.0	-7.6	103	25.0	103	26.5	103	27.9	102	28.7	102	29.4	102	30.9
	-5.0	-5.6	108	26.1	108	27.5	108	28.9	107	29.6	107	30.3	107	31.7
	-3.0	-3.7	113	27.0	113	28.4	112	29.7	112	30.4	112	31.1	112	32.4
	0.0	-0.7	122	28.5	121	29.7	121	31.0	121	31.6	121	32.2	120	33.5
	3.0	2.2	130	29.8	130	31.0	130	32.1	129	32.7	129	33.3	129	34.4
	5.0	4.1	136	30.6	136	31.7	136	32.8	135	33.4	135	33.9	135	35.0
	7.0	6.0	143	31.4	142	32.4	142	33.5	142	34.0	141	34.5	141	35.6
	9.0	7.9	149	32.1	149	33.1	148	34.1	148	34.6	148	35.1	145	35.0
11.0	9.8	156	32.8	155	33.7	155	34.7	155	35.2	155	35.7	145	33.1	
13.0	11.8	163	33.5	163	34.4	162	35.3	162	35.7	158	34.7	145	31.3	
15.0	13.7	170	34.1	170	34.9	170	35.8	164	34.5	158	32.9	145	29.7	
120% 141.60 kW	-19.8	-20.0	78.3	19.8	77.9	21.6	77.6	23.4	77.4	24.3	77.3	25.3	77.0	27.1
	-18.8	-19.0	79.9	20.4	79.5	22.2	79.2	23.9	79.0	24.8	78.9	25.7	78.5	27.5
	-16.7	-17.0	83.2	21.5	82.9	23.2	82.6	24.9	82.4	25.8	82.2	26.6	81.9	28.3
	-13.7	-15.0	86.9	22.7	86.6	24.3	86.2	25.9	86.1	26.8	85.9	27.6	85.6	29.2
	-11.8	-13.0	90.8	23.8	90.5	25.4	90.2	26.9	90.0	27.7	89.8	28.5	89.5	30.0
	-9.8	-11.0	95.1	24.9	94.7	26.4	94.4	27.9	94.2	28.6	94.1	29.3	93.7	30.8
	-9.5	-10.0	97.3	25.4	96.9	26.9	96.6	28.3	96.4	29.0	96.3	29.8	95.9	31.2
	-8.5	-9.1	99.3	25.9	99.0	27.3	98.7	28.7	98.5	29.4	98.3	30.1	98.0	31.6
	-7.0	-7.6	103	26.7	103	28.0	102	29.4	102	30.1	102	30.8	102	32.1
	-5.0	-5.6	108	27.7	107	29.0	107	30.3	107	30.9	107	31.6	106	32.9
	-3.0	-3.7	113	28.6	112	29.8	112	31.1	112	31.7	112	32.3	111	33.5
	0.0	-0.7	121	29.9	121	31.1	121	32.2	120	32.8	120	33.4	120	34.5
	3.0	2.2	130	31.1	130	32.2	129	33.3	129	33.8	129	34.3	129	35.4
	5.0	4.1	136	31.9	136	32.9	135	33.9	135	34.4	135	34.9	134	35.5
	7.0	6.0	142	32.6	142	33.6	141	34.5	141	35.0	141	35.5	134	33.6
	9.0	7.9	149	33.2	148	34.2	148	35.1	148	35.6	146	35.3	134	31.8
11.0	9.8	155	33.9	155	34.8	155	35.7	152	35.1	146	33.4	134	30.1	
13.0	11.8	163	34.5	162	35.4	158	34.7	152	33.1	146	31.5	134	28.5	
15.0	13.7	170	35.1	170	35.9	158	32.9	152	31.4	146	29.9	134	27.1	
110% 129.80 kW	-19.8	-20.0	77.9	22.1	77.6	23.7	77.3	25.4	77.1	26.2	77.0	27.1	76.6	28.7
	-18.8	-19.0	79.5	22.6	79.1	24.2	78.8	25.9	78.7	26.7	78.5	27.5	78.2	29.1
	-16.7	-17.0	82.8	23.7	82.5	25.2	82.2	26.8	82.1	27.6	81.9	28.3	81.6	29.9
	-13.7	-15.0	86.5	24.7	86.2	26.2	85.9	27.7	85.7	28.4	85.6	29.2	85.3	30.7
	-11.8	-13.0	90.4	25.8	90.1	27.2	89.8	28.6	89.7	29.3	89.5	30.0	89.2	31.4
	-9.8	-11.0	94.6	26.8	94.3	28.1	94.0	29.5	93.9	30.1	93.7	30.8	93.4	32.2
	-9.5	-10.0	96.9	27.2	96.5	28.6	96.2	29.9	96.1	30.5	95.9	31.2	95.6	32.5
	-8.5	-9.1	98.9	27.7	98.6	29.0	98.3	30.3	98.1	30.9	98.0	31.6	97.7	32.9
	-7.0	-7.6	102	28.4	102	29.6	102	30.9	102	31.5	102	32.1	101	33.4
	-5.0	-5.6	107	29.3	107	30.5	107	31.7	107	32.3	106	32.9	106	34.0
	-3.0	-3.7	112	30.1	112	31.3	112	32.4	112	33.0	111	33.5	111	34.7
	0.0	-0.7	121	31.4	120	32.4	120	33.5	120	34.0	120	34.5	120	35.6
	3.0	2.2	129	32.5	129	33.4	129	34.4	129	34.9	129	35.4	122	33.8
	5.0	4.1	135	33.1	135	34.1	135	35.0	135	35.5	134	35.5	122	32.0
	7.0	6.0	142	33.8	141	34.7	141	35.6	139	35.3	134	33.6	122	30.3
	9.0	7.9	148	34.4	148	35.3	145	35.0	139	33.4	134	31.8	122	28.7
11.0	9.8	155	35.0	155	35.8	145	33.1	139	31.6	134	30.1	122	27.2	
13.0	11.8	162	35.6	156	34.2	145	31.3	139	29.9	134	28.5	122	25.8	
15.0	13.7	167	35.2	156	32.4	145	29.7	139	28.4	134	27.1	122	24.5	
100% 118.00 kW	-19.8	-20.0	77.4	24.3	77.2	25.9	76.9	27.4	76.8	28.1	76.6	28.9	76.3	30.4
	-18.8	-19.0	79.0	24.8	78.8	26.3	78.5	27.8	78.3	28.5	78.2	29.3	77.9	30.7
	-16.7	-17.0	82.4	25.8	82.1	27.2	81.9	28.6	81.7	29.3	81.6	30.0	81.3	31.5
	-13.7	-15.0	86.1	26.8	85.8	28.1	85.5	29.5	85.4	30.1	85.2	30.8	85.0	32.2
	-11.8	-13.0	90.0	27.7	89.7	29.0	89.5	30.3	89.3	30.9	89.2	31.6	88.9	32.9
	-9.8	-11.0	94.2	28.6	93.9	29.8	93.7	31.1	93.5	31.7	93.4	32.3	93.1	33.5
	-9.5	-10.0	96.4	29.0	96.2	30.2	95.9	31.5	95.7	32.1	95.6	32.7	95.3	33.9
	-8.5	-9.1	98.5	29.4	98.2	30.6	97.9	31.8	97.8	32.4	97.7	33.0	97.4	34.1
	-7.0	-7.6	102	30.1	102	31.2	101	32.4	101	32.9	101.2	33.5	100.9	34.6
	-5.0	-5.6	107	30.9	107	32.0	106	33.1	106	33.6	106	34.2	106	35.2
	-3.0	-3.7	112	31.7	112	32.7	111	33.7	111	34.2	111	34.8	111	35.8
	0.0	-0.7	120	32.8	120	33.7	120	34.7	120	35.2	120	35.7	111	32.9
	3.0	2.2	129	33.8	129	34.7	128	35.6	126	35.2	121	33.5	111	30.2
	5.0	4.1	135	34.4	135	35.3	132	34.9	126	33.3	121	31.7	111	28.6
	7.0	6.0	141	35.0	141	35.8	132	33.0	126	31.5	121	30.0	111	27.1
	9.0	7.9	148	35.6	142	34.1	132	31.2	126	29.8	121	28.4	111	25.7
11.0	9.8	152	35.1	142	32.3	132	29.6	126	28.3	121	27.0	111	24.4	
13.0	11.8	152	33.1	142	30.5	132	28.0	126	26.8	121	25.5	111	23.2	
15.0	13.7	152	31.4	142	29.0	132	26.6	126	25.4	121	24.3	111	22.1	

NOTES - ANMERKUNGEN - Σημειώσεις - NOTAS - REMARQUES - NOTE - OPMERKINGEN - примечания - NOTLAR

1. [] is shown as reference. When selecting the unit models, avoid the Outdoor air temperature range shown by [].
 dient als Verweis. Vermeiden Sie bei der Auswahl der Gerätemodelle den als markierten Temperaturbereich der Außenluft.
 Η [] είναι ενδεικτική, κατά την επιλογή των μοντέλων των μονάδων, αποφεύγετε το εύρος θερμοκρασίας εξωτερικού αέρα που υποδεικνύεται [].
 se muestra como referencia. Cuando seleccione los modelos de unidad, evite el intervalo de temperaturas del aire exterior indicado mediante [].
 est montré comme référence. Lors du choix des modèles d'unités, évitez la plage de températures de l'air extérieur illustré par [].
 valori riportati unicamente come riferimento. Nel selezionare i modelli delle unità, non considerare i valori di temperatura dell'aria esterna indicati con il colore [].
 is als referentie getoond. Wanneer modellen van eenheden worden gekozen, vermijd dan het bereik van buitenluchttemperaturen geïllustreerd door [].

2. The above table shows the average value of conditions which may occur.
 Die obige Tabelle zeigt den Durchschnittswert der Bedingungen, die auftreten können.
 Στον παραπάνω πίνακα αναγράφεται η μέση τιμή για συνθήκες που μπορεί να προκύψουν.
 La tabla de arriba muestra el valor medio de condiciones que pueden ocurrir.
 Le tableau ci-dessus donne la valeur moyenne pour des conditions qui peuvent survenir.
 La tabella in alto mostra il valore delle condizioni medie che si possono riscontrare.
 De tabel hierboven geeft de gemiddelde waarde aan van situaties die kunnen voorvallen.
 Таблица расположенная выше показывает среднее значение условий, которые могут наступить.
 Yukarıdaki tablo meydana gelebilecek koşulların ortalama değerini göstermektedir.

5 Таблицы производительности

5 - 2 Таблицы теплопроизводительностей

5

RXYQ42T														
Indoor air temp. °CDB														
Combination(%) (Capacity index)	Outdoor air temp.		16.0		18.0		20.0		21.0		22.0		24.0	
			TC	PI	TC	PI	TC	PI	TC	PI	TC	PI	TC	PI
	(°CDB)	(°CWB)	KW	KW	KW	KW	KW	KW	KW	KW	KW	KW	KW	KW
90% 106.20 kW	-19.8	-20.0	77.0	26.6	76.8	28.0	76.5	29.3	76.4	30.0	76.3	30.7	76.0	32.1
	-18.8	-19.0	78.6	27.1	78.4	28.4	78.1	29.7	78.0	30.4	77.9	31.0	77.6	32.4
	-16.7	-17.0	82.0	27.9	81.8	29.2	81.5	30.5	81.4	31.1	81.3	31.7	81.0	33.0
	-13.7	-15.0	85.7	28.8	85.4	30.0	85.2	31.2	85.0	31.8	84.9	32.4	84.7	33.6
	-11.8	-13.0	89.6	29.6	89.3	30.8	89.1	31.9	89.0	32.5	88.8	33.1	88.6	34.3
	-9.8	-11.0	93.8	30.4	93.6	31.6	93.3	32.7	93.2	33.2	93.1	33.8	92.8	34.9
	-9.5	-10.0	96.0	30.8	95.8	31.9	95.5	33.0	95.4	33.6	95.3	34.1	95.0	35.2
	-8.5	-9.1	98.1	31.2	97.8	32.3	97.6	33.3	97.4	33.9	97.3	34.4	97.1	35.4
	-7.0	-7.6	102	31.8	101	32.8	101.1	33.8	101.0	34.3	100.9	34.8	100.1	35.6
	-5.0	-5.6	107	32.5	106	33.5	106	34.5	106	35.0	106	35.4	100	33.5
	-3.0	-3.7	112	33.2	111	34.1	111	35.1	111	35.5	109	35.2	100	31.7
	0.0	-0.7	120	34.2	120	35.1	118	35.4	114	33.8	109	32.2	100	29.1
	3.0	2.2	129	35.1	127	35.5	118	32.5	114	31.0	109	29.6	100	26.8
	5.0	4.1	135	35.7	127	33.6	118	30.8	114	29.4	109	28.0	100	25.4
	7.0	6.0	137	34.5	127	31.8	118	29.1	114	27.8	109	26.6	100	24.1
	9.0	7.9	137	32.6	127	30.1	118	27.6	114	26.4	109	25.2	100	22.9
	11.0	9.8	137	30.9	127	28.5	118	26.2	114	25.1	109	23.9	100	21.8
13.0	11.8	137	29.2	127	27.0	118	24.8	114	23.8	109	22.7	100	20.7	
15.0	13.7	137	27.8	127	25.7	118	23.6	114	22.6	109	21.6	100	19.7	
80% 94.40 kW	-19.8	-20.0	76.6	28.9	76.4	30.1	76.2	31.3	76.1	31.9	76.0	32.5	75.7	33.7
	-18.8	-19.0	78.2	29.3	78.0	30.5	77.8	31.6	77.7	32.2	77.5	32.8	77.3	34.0
	-16.7	-17.0	81.6	30.0	81.4	31.2	81.1	32.3	81.0	32.9	80.9	33.4	80.7	34.6
	-13.7	-15.0	85.2	30.8	85.0	31.9	84.8	33.0	84.7	33.5	84.6	34.1	84.4	35.1
	-11.8	-13.0	89.2	31.6	89.0	32.6	88.7	33.6	88.6	34.1	88.5	34.7	88.3	35.7
	-9.8	-11.0	93.4	32.3	93.2	33.3	93.0	34.3	92.8	34.8	92.7	35.2	89.0	34.1
	-9.5	-10.0	95.6	32.7	95.4	33.6	95.2	34.6	95.1	35.1	94.9	35.5	89.0	33.1
	-8.5	-9.1	97.7	33.0	97.4	33.9	97.2	34.8	97.1	35.3	97.0	35.8	89.0	32.3
	-7.0	-7.6	101.2	33.5	101.0	34.4	100.8	35.3	100.6	35.8	97.1	34.3	89.0	30.9
	-5.0	-5.6	106	34.2	106	35.0	105	35.6	101	34.0	97.1	32.3	89.0	29.2
	-3.0	-3.7	111	34.8	111	35.6	105	33.6	101	32.1	97.1	30.6	89.0	27.6
	0.0	-0.7	120	35.7	113	33.6	105	30.8	101	29.4	97.1	28.0	89.0	25.4
	3.0	2.2	121	33.5	113	30.9	105	28.3	101	27.1	97.1	25.8	89.0	23.4
	5.0	4.1	121	31.7	113	29.2	105	26.8	101	25.7	97.1	24.5	89.0	22.3
	7.0	6.0	121	30.0	113	27.7	105	25.4	101	24.3	97.1	23.3	89.0	21.2
	9.0	7.9	121	28.4	113	26.3	105	24.2	101	23.1	97.1	22.1	89.0	20.1
	11.0	9.8	121	27.0	113	24.9	105	23.0	101	22.0	97.1	21.0	89.0	19.2
13.0	11.8	121	25.5	113	23.6	105	21.8	101	20.9	97.1	20.0	89.0	18.2	
15.0	13.7	121	24.3	113	22.5	105	20.8	101	19.9	97.1	19.1	89.0	17.4	
70% 82.60 kW	-19.8	-20.0	76.2	31.1	76.0	32.2	75.8	33.3	75.7	33.8	75.6	34.3	75.4	35.4
	-18.8	-19.0	77.8	31.5	77.6	32.5	77.4	33.6	77.3	34.1	77.2	34.6	77.0	35.6
	-16.7	-17.0	81.2	32.2	81.0	33.2	80.8	34.1	80.7	34.6	80.6	35.1	77.9	34.4
	-13.7	-15.0	84.8	32.8	84.6	33.8	84.4	34.7	84.3	35.2	84.2	35.7	77.9	32.6
	-11.8	-13.0	88.8	33.5	88.6	34.4	88.4	35.3	88.3	35.8	85.0	34.2	77.9	30.8
	-9.8	-11.0	93.0	34.1	92.8	35.0	92.1	35.5	88.5	33.9	85.0	32.3	77.9	29.1
	-9.5	-10.0	95.2	34.5	95.0	35.3	92.1	34.5	88.5	32.9	85.0	31.4	77.9	28.3
	-8.5	-9.1	97.2	34.7	97.0	35.6	92.1	33.6	88.5	32.1	85.0	30.6	77.9	27.6
	-7.0	-7.6	100.8	35.2	99.1	35.2	92.1	32.2	88.5	30.7	85.0	29.3	77.9	26.5
	-5.0	-5.6	106	35.8	99.1	33.1	92.1	30.4	88.5	29.0	85.0	27.7	77.9	25.0
	-3.0	-3.7	106	34.0	99.1	31.3	92.1	28.7	88.5	27.5	85.0	26.2	77.9	23.8
	0.0	-0.7	106	31.1	99.1	28.7	92.1	26.4	88.5	25.2	85.0	24.1	77.9	21.9
	3.0	2.2	106	28.6	99.1	26.4	92.1	24.3	88.5	23.3	85.0	22.3	77.9	20.3
	5.0	4.1	106	27.1	99.1	25.1	92.1	23.1	88.5	22.1	85.0	21.2	77.9	19.3
	7.0	6.0	106	25.7	99.1	23.8	92.1	21.9	88.5	21.0	85.0	20.1	77.9	18.4
	9.0	7.9	106	24.4	99.1	22.6	92.1	20.9	88.5	20.0	85.0	19.2	77.9	17.5
	11.0	9.8	106	23.2	99.1	21.5	92.1	19.9	88.5	19.1	85.0	18.3	77.9	16.7
13.0	11.8	106	22.0	99.1	20.4	92.1	18.9	88.5	18.1	85.0	17.4	77.9	15.9	
15.0	13.7	106	21.0	99.1	19.5	92.1	18.0	88.5	17.3	85.0	16.6	77.9	15.2	
60% 70.80 kW	-19.8	-20.0	75.8	33.4	75.6	34.3	75.5	35.2	75.4	35.7	72.8	34.3	66.8	30.9
	-18.8	-19.0	77.4	33.7	77.2	34.6	77.0	35.5	75.9	35.1	72.8	33.4	66.8	30.2
	-16.7	-17.0	80.8	34.3	80.6	35.1	78.9	34.9	75.9	33.3	72.8	31.7	66.8	28.7
	-13.7	-15.0	84.4	34.9	84.2	35.7	78.9	33.1	75.9	31.6	72.8	30.1	66.8	27.2
	-11.8	-13.0	88.3	35.4	85.0	34.2	78.9	31.3	75.9	29.9	72.8	28.5	66.8	25.8
	-9.8	-11.0	91.0	35.1	85.0	32.3	78.9	29.6	75.9	28.3	72.8	27.0	66.8	24.4
	-9.5	-10.0	91.0	34.1	85.0	31.4	78.9	28.8	75.9	27.5	72.8	26.2	66.8	23.8
	-8.5	-9.1	91.0	33.2	85.0	30.6	78.9	28.0	75.9	26.8	72.8	25.6	66.8	23.2
	-7.0	-7.6	91.0	31.8	85.0	29.3	78.9	26.9	75.9	25.7	72.8	24.5	66.8	22.3
	-5.0	-5.6	91.0	30.0	85.0	27.7	78.9	25.4	75.9	24.3	72.8	23.2	66.8	21.1
	-3.0	-3.7	91.0	28.4	85.0	26.2	78.9	24.1	75.9	23.1	72.8	22.1	66.8	20.1
	0.0	-0.7	91.0	26.0	85.0	24.1	78.9	22.2	75.9	21.3	72.8	20.4	66.8	18.6
	3.0	2.2	91.0	24.0	85.0	22.3	78.9	20.5	75.9	19.7	72.8	18.9	66.8	17.2
	5.0	4.1	91.0	22.8	85.0	21.2	78.9	19.5	75.9	18.8	72.8	18.0	66.8	16.4
	7.0	6.0	91.0	21.7	85.0	20.1	78.9	18.6	75.9	17.9	72.8	17.1	66.8	15.7
	9.0	7.9	91.0	20.6	85.0	19.2	78.9	17.7	75.9	17.0	72.8	16.3	66.8	15.0
	11.0	9.8	91.0	19.6	85.0	18.3	78.9	16.9	75.9	16.3	72.8	15.6	66.8	14.3
13.0	11.8	91.0	18.7	85.0	17.4	78.9	16.1	75.9	15.5	72.8	14.9	66.8	13.7	
15.0	13.7	91.0	17.8	85.0	16.6	78.9	15.4	75.9	14.8	72.8	14.3	66.8	13.1	
50% 59.00 kW	-19.8	-20.0	75.4	35.7	70.8	33.2	65.8	30.4	63.2	29.0	60.7	27.7	55.6	25.1
	-18.8	-19.0	75.9	35.1	70.8	32.3	65.8	29.6	63.2	28.3	60.7	27.0	55.6	24.5
	-16.7	-17.0	75.9	33.3	70.8	30.7	65.8	28.2	63.2	26.9	60.7	25.7	55.6	23.3
	-13.7	-15.0	75.9	31.6	70.8	29.1	65.8	26.7	63.2	25.6	60.7	24.4	55.6	22.2
	-11.8	-13.0	75.9	29.9	70.8	27.6	65.8	25.3	63.2	24.2	60.7	23.2	55.6	21.1
	-9.8	-11.0	75.9	28.3	70.8	26.1	65.8	24.0	63.2	23.0	60.7	22.0	55.6	20.0
	-9.5	-10.0	75.9	27.5	70.8	25.4	65.8	23.4	63.2	22.4	60.7	21.4	55.6	19.5
	-8.5	-9.1	75.9	26.8	70.8	24.8	65.8	22.8	63.2	21.9	60.7	20.9	55.6	19.1
	-7.0	-7.6	75.9	25.7	70.8	23.8	65.8	21.9	63.2	21.0	60.7	20.1	55.6	18.3
	-5.0	-5.6	75.9	24.3	70.8	22.5	65.8	20.8	63.2	19.9	60.7	19.1	55.6	17.4
	-3.0	-3.7	75.9	23.1	70.8	21.4	65.8	19.8	63.2	19.0	60.7	18.2	55.6	16.6
	0.0	-0.7	75.9	21.3	70.8	19.8	65.8	18.3	63.2	17.5	60.7	16.8	55.6	15.4
	3.0	2.2	75.9	19.7										

5 Таблицы производительности

5 - 2 Таблицы теплопроизводительностей

RXYQ44T		Indoor air temp. °CDB												TC: Total capacity (kW); PI: Power Input (kW) (Comp. + Outdoor fan motor)	
Combination(%) (Capacity index)	Outdoor air temp.		16.0		18.0		20.0		21.0		22.0		24.0		
	(°CDB)	(°CWB)	TC KW	PI KW	TC KW	PI KW	TC KW	PI KW	TC KW	PI KW	TC KW	PI KW	TC KW	PI KW	
130% 160.55 kW	-19.8	-20.0	81.0	17.5	80.6	19.6	80.2	21.6	80.1	22.7	79.9	23.7	79.5	25.8	
	-18.8	-19.0	82.6	18.2	82.2	20.2	81.9	22.2	81.7	23.2	81.5	24.2	81.1	26.3	
	-16.7	-17.0	86.1	19.5	85.7	21.4	85.3	23.4	85.1	24.3	85.0	25.3	84.6	27.2	
	-13.7	-15.0	89.8	20.8	89.5	22.6	89.1	24.5	88.9	25.4	88.7	26.3	88.3	28.2	
	-11.8	-13.0	93.9	22.1	93.5	23.8	93.1	25.6	92.9	26.5	92.7	27.4	92.4	29.1	
	-9.8	-11.0	98.2	23.3	97.8	25.0	97.4	26.7	97.3	27.5	97.1	28.4	96.7	30.0	
	-9.5	-10.0	100	23.9	100	25.6	100	27.2	100	28.0	99.3	28.8	99.0	30.5	
	-8.5	-9.1	103	24.4	102	26.1	102	27.7	102	28.5	101	29.3	101	30.9	
	-7.0	-7.6	106	25.3	106	26.9	105	28.4	105	29.2	105	30.0	105	31.5	
	-5.0	-5.6	111	26.5	111	27.9	111	29.4	110	30.1	110	30.9	110	32.4	
	-3.0	-3.7	116	27.5	116	28.9	116	30.3	116	31.0	115	31.7	115	33.1	
	0.0	-0.7	125	29.0	125	30.3	124	31.6	124	32.3	124	32.9	124	34.3	
	3.0	2.2	134	30.4	134	31.6	133	32.8	133	33.4	133	34.0	133	35.3	
	5.0	4.1	140	31.2	140	32.4	139	33.6	139	34.1	139	34.7	139	35.9	
	7.0	6.0	147	32.1	146	33.2	146	34.3	146	34.8	146	35.4	145	36.5	
	9.0	7.9	153	32.8	153	33.9	153	34.9	152	35.5	152	36.0	151	36.8	
11.0	9.8	160	33.5	160	34.5	160	35.6	159	36.1	159	36.6	151	34.8		
13.0	11.8	168	34.3	168	35.2	167	36.2	167	36.7	165	36.5	151	32.9		
15.0	13.7	176	34.9	175	35.8	175	36.7	172	36.3	165	34.6	151	31.2		
120% 148.20 kW	-19.8	-20.0	80.6	19.9	80.2	21.8	79.9	23.7	79.7	24.7	79.5	25.6	79.2	27.5	
	-18.8	-19.0	82.2	20.5	81.8	22.4	81.5	24.2	81.3	25.2	81.1	26.1	80.8	28.0	
	-16.7	-17.0	85.6	21.7	85.3	23.5	85.0	25.3	84.8	26.2	84.6	27.1	84.3	28.9	
	-13.7	-15.0	89.4	22.9	89.1	24.6	88.7	26.3	88.5	27.2	88.4	28.0	88.0	29.7	
	-11.8	-13.0	93.4	24.1	93.1	25.7	92.7	27.4	92.6	28.2	92.4	29.0	92.0	30.6	
	-9.8	-11.0	97.8	25.2	97.4	26.8	97.1	28.4	96.9	29.1	96.7	29.9	96.4	31.5	
	-9.5	-10.0	100	25.8	100	27.3	99.3	28.8	99.2	29.6	99.0	30.4	98.7	31.9	
	-8.5	-9.1	102	26.3	102	27.8	101	29.3	101	30.0	101	30.8	101	32.2	
	-7.0	-7.6	106	27.1	105	28.5	105	30.0	105	30.7	105	31.4	104	32.8	
	-5.0	-5.6	111	28.2	111	29.5	110	30.9	110	31.6	110	32.2	110	33.6	
	-3.0	-3.7	116	29.1	116	30.4	115	31.7	115	32.4	115	33.0	115	34.3	
	0.0	-0.7	125	30.5	124	31.7	124	32.9	124	33.5	124	34.2	123	35.4	
	3.0	2.2	134	31.8	133	32.9	133	34.0	133	34.6	133	35.2	132	36.3	
	5.0	4.1	140	32.6	139	33.7	139	34.7	139	35.3	139	35.8	138	36.9	
	7.0	6.0	146	33.3	146	34.4	146	35.4	145	35.9	145	36.4	140	35.3	
	9.0	7.9	153	34.0	153	35.0	152	36.0	152	36.5	152	37.0	140	33.4	
11.0	9.8	160	34.7	160	35.6	159	36.6	159	36.9	152	35.1	140	31.7		
13.0	11.8	168	35.4	167	36.3	165	36.5	159	34.8	152	33.2	140	30.0		
15.0	13.7	175	36.0	175	36.8	165	34.6	159	33.0	152	31.5	140	28.4		
110% 135.85 kW	-19.8	-20.0	80.1	22.3	79.8	24.0	79.5	25.8	79.3	26.7	79.2	27.5	78.9	29.3	
	-18.8	-19.0	81.8	22.8	81.4	24.5	81.1	26.3	81.0	27.1	80.8	28.0	80.5	29.7	
	-16.7	-17.0	85.2	23.9	84.9	25.6	84.6	27.2	84.4	28.0	84.3	28.9	83.9	30.5	
	-13.7	-15.0	89.0	25.0	88.6	26.6	88.3	28.2	88.2	29.0	88.0	29.7	87.7	31.3	
	-11.8	-13.0	93.0	26.1	92.7	27.6	92.4	29.1	92.2	29.9	92.0	30.6	91.7	32.1	
	-9.8	-11.0	97.3	27.2	97.0	28.6	96.7	30.0	96.5	30.7	96.4	31.5	96.1	32.9	
	-9.5	-10.0	99.6	27.7	99.3	29.1	99.0	30.5	98.8	31.2	98.7	31.9	98.3	33.3	
	-8.5	-9.1	102	28.2	101	29.5	101	30.9	101	31.6	101	32.2	100	33.6	
	-7.0	-7.6	105	28.9	105	30.2	105	31.5	105	32.2	104	32.8	104	34.2	
	-5.0	-5.6	110	29.9	110	31.1	110	32.4	110	33.0	110	33.6	109	34.9	
	-3.0	-3.7	116	30.7	115	31.9	115	33.1	115	33.7	115	34.3	114	35.5	
	0.0	-0.7	124	32.0	124	33.1	124	34.3	123	34.8	123	35.4	123	36.5	
	3.0	2.2	133	33.2	133	34.2	133	35.3	132	35.8	132	36.3	128	35.6	
	5.0	4.1	139	33.9	139	34.9	139	35.9	139	36.4	138	36.9	128	33.7	
	7.0	6.0	146	34.6	145	35.5	145	36.5	145	37.0	140	35.3	128	31.9	
	9.0	7.9	153	35.3	152	36.2	151	36.8	145	35.1	140	33.4	128	30.2	
11.0	9.8	160	35.9	159	36.7	151	34.8	145	33.2	140	31.7	128	28.6		
13.0	11.8	167	36.5	163	35.9	151	32.9	145	31.4	140	30.0	128	27.1		
15.0	13.7	175	37.0	163	34.1	151	31.2	145	29.8	140	28.4	128	25.8		
100% 123.50 kW	-19.8	-20.0	79.7	24.7	79.4	26.3	79.1	27.8	79.0	28.6	78.8	29.4	78.5	31.0	
	-18.8	-19.0	81.3	25.2	81.0	26.7	80.7	28.3	80.6	29.1	80.5	29.8	80.2	31.4	
	-16.7	-17.0	84.8	26.2	84.5	27.7	84.2	29.2	84.1	29.9	83.9	30.7	83.6	32.1	
	-13.7	-15.0	88.5	27.2	88.2	28.6	88.0	30.0	87.8	30.7	87.7	31.5	87.4	32.9	
	-11.8	-13.0	92.6	28.2	92.3	29.5	92.0	30.9	91.8	31.6	91.7	32.2	91.4	33.6	
	-9.8	-11.0	96.9	29.1	96.6	30.4	96.3	31.7	96.2	32.4	96.0	33.0	95.7	34.3	
	-9.5	-10.0	99.2	29.6	98.9	30.9	98.6	32.1	98.4	32.8	98.3	33.4	98.0	34.7	
	-8.5	-9.1	101	30.0	101	31.3	101	32.5	101	33.1	100	33.7	100	35.0	
	-7.0	-7.6	105	30.7	105	31.9	104	33.1	104	33.7	104	34.3	104	35.5	
	-5.0	-5.6	110	31.6	110	32.7	109	33.8	109	34.4	109	35.0	109	36.1	
	-3.0	-3.7	115	32.4	115	33.4	115	34.5	114	35.1	114	35.6	114	36.7	
	0.0	-0.7	124	33.5	123	34.6	123	35.6	123	36.1	123	36.6	116	34.6	
	3.0	2.2	133	34.6	132	35.5	132	36.5	132	37.0	127	35.3	116	31.8	
	5.0	4.1	139	35.3	139	36.2	138	36.7	132	35.0	127	33.3	116	30.1	
	7.0	6.0	145	35.9	145	36.7	138	34.7	132	33.1	127	31.6	116	28.5	
	9.0	7.9	152	36.5	148	35.9	138	32.8	132	31.4	127	29.9	116	27.1	
11.0	9.8	159	36.9	148	34.0	138	31.1	132	29.7	127	28.4	116	25.7		
13.0	11.8	159	34.8	148	32.1	138	29.4	132	28.1	127	26.9	116	24.4		
15.0	13.7	159	33.0	148	30.4	138	28.0	132	26.7	127	25.5	116	23.2		

NOTES - ANMERKUNGEN - Σημειώσεις - NOTAS - REMARQUES - NOTE - OPMERKINGEN - примечания - NOTLAR

1. [] is shown as reference. When selecting the unit models, avoid the Outdoor air temperature range shown by [].
 dient als Verweis. Vermeiden Sie bei der Auswahl der Gerätemodelle den als markierten Temperaturbereich der Außenluft.
 Η [] είναι ενδεικτική, κατά την επιλογή των μοντέλων των μονάδων, αποφεύγετε το εύρος θερμοκρασίας εξωτερικού αέρα που υποδεικνύεται [].
 se muestra como referencia. Cuando seleccione los modelos de unidad, evite el intervalo de temperaturas del aire exterior indicado mediante [].
 est montré comme référence. Lors du choix des modèles d'unités, évitez la plage de températures de l'air extérieur illustré par [].
 valori riportati unicamente come riferimento. Nel selezionare i modelli delle unità, non considerare i valori di temperatura dell'aria esterna indicati con il colore [].
 is als referentie getoond. Wanneer modellen van eenheden worden gekozen, vermijd dan het bereik van buitenluchttemperaturen geïllustreerd door [].

2. The above table shows the average value of conditions which may occur.
 Die obige Tabelle zeigt den Durchschnittswert der Bedingungen, die auftreten können.
 Στον παραπάνω πίνακα αναγράφεται η μέση τιμή για συνθήκες που μπορεί να προκύψουν.
 La tabla de arriba muestra el valor medio de condiciones que pueden ocurrir.
 Le tableau ci-dessus donne la valeur moyenne pour des conditions qui peuvent survenir.
 La tabella in alto mostra il valore delle condizioni medie che si possono riscontrare.
 De tabel hierboven geeft de gemiddelde waarde aan van situaties die kunnen voorvallen.
 Таблица расположенная выше показывает среднее значение условий, которые могут наступить.
 Yukarıdaki tablo meydana gelebilecek koşulların ortalama değerini göstermektedir.

5 Таблицы производительности

5 - 2 Таблицы теплопроизводительностей

5

RXYQ44T														
Indoor air temp. °CDB														
Combination (%) (Capacity index)	Outdoor air temp.		16.0		18.0		20.0		21.0		22.0		24.0	
			TC	PI	TC	PI	TC	PI	TC	PI	TC	PI	TC	PI
	(°CDB)	(°CWB)	KW	KW	KW	KW	KW	KW	KW	KW	KW	KW	KW	KW
90% 111.15 kW	-19.8	-20.0	79.3	27.0	79.0	28.5	78.7	29.9	78.6	30.6	78.5	31.3	78.2	32.8
	-18.8	-19.0	80.9	27.5	80.6	28.9	80.4	30.3	80.2	31.0	80.1	31.7	79.8	33.1
	-16.7	-17.0	84.3	28.4	84.1	29.8	83.8	31.1	83.7	31.8	83.6	32.4	83.3	33.8
	-13.7	-15.0	88.1	29.3	87.8	30.6	87.6	31.9	87.4	32.5	87.3	33.2	87.1	34.4
	-11.8	-13.0	92.1	30.2	91.9	31.4	91.6	32.7	91.5	33.3	91.4	33.9	91.1	35.1
	-9.8	-11.0	96.5	31.1	96.2	32.2	95.9	33.4	95.8	34.0	95.7	34.6	95.4	35.7
	-9.5	-10.0	98.7	31.5	98.5	32.6	98.2	33.8	98.1	34.3	98.0	34.9	97.7	36.1
	-8.5	-9.1	101	31.9	101	33.0	100	34.1	100	34.7	100	35.2	100	36.3
	-7.0	-7.6	104	32.5	104	33.6	104	34.6	104	35.2	104	35.7	103	36.8
	-5.0	-5.6	110	33.3	109	34.3	109	35.3	109	35.8	109	36.3	105	35.3
	-3.0	-3.7	115	34.0	114	35.0	114	35.9	114	36.4	114	36.9	105	33.4
	0.0	-0.7	123	35.1	123	36.0	123	36.9	119	35.6	114	33.9	105	30.6
	3.0	2.2	132	36.0	132	36.9	124	34.2	119	32.7	114	31.1	105	28.2
	5.0	4.1	138	36.6	133	35.3	124	32.4	119	30.9	114	29.5	105	26.7
	7.0	6.0	143	36.3	133	33.4	124	30.6	119	29.3	114	27.9	105	25.3
	9.0	7.9	143	34.3	133	31.7	124	29.0	119	27.8	114	26.5	105	24.1
11.0	9.8	143	32.5	133	30.0	124	27.6	119	26.4	114	25.2	105	22.9	
13.0	11.8	143	30.7	133	28.4	124	26.1	119	25.0	114	23.9	105	21.7	
15.0	13.7	143	29.2	133	27.0	124	24.8	119	23.8	114	22.7	105	20.7	
80% 98.80 kW	-19.8	-20.0	78.8	29.4	78.6	30.7	78.4	32.0	78.2	32.6	78.1	33.3	77.9	34.5
	-18.8	-19.0	80.5	29.8	80.2	31.1	80.0	32.3	79.9	33.0	79.8	33.6	79.5	34.8
	-16.7	-17.0	83.9	30.7	83.7	31.8	83.4	33.0	83.3	33.6	83.2	34.2	83.0	35.4
	-13.7	-15.0	87.7	31.5	87.4	32.6	87.2	33.7	87.1	34.3	87.0	34.9	86.7	36.0
	-11.8	-13.0	91.7	32.2	91.5	33.3	91.2	34.4	91.1	35.0	91.0	35.5	90.8	36.6
	-9.8	-11.0	96.0	33.0	95.8	34.1	95.6	35.1	95.5	35.6	95.3	36.1	93.1	35.9
	-9.5	-10.0	98.3	33.4	98.1	34.4	97.8	35.4	97.7	35.9	97.6	36.4	93.1	34.9
	-8.5	-9.1	100	33.7	100	34.7	100	35.7	100	36.2	100	36.7	93.1	34.0
	-7.0	-7.6	104	34.3	104	35.2	104	36.2	103	36.7	102	36.1	93.1	32.6
	-5.0	-5.6	109	35.0	109	35.9	109	36.8	106	35.8	102	34.0	93.1	30.7
	-3.0	-3.7	114	35.6	114	36.5	110	35.4	106	33.8	102	32.2	93.1	29.1
	0.0	-0.7	123	36.6	118	35.4	110	32.4	106	30.9	102	29.5	93.1	26.7
	3.0	2.2	127	35.3	118	32.5	110	29.8	106	28.5	102	27.2	93.1	24.7
	5.0	4.1	127	33.3	118	30.7	110	28.2	106	27.0	102	25.8	93.1	23.4
	7.0	6.0	127	31.6	118	29.1	110	26.8	106	25.6	102	24.5	93.1	22.3
	9.0	7.9	127	29.9	118	27.6	110	25.4	106	24.3	102	23.3	93.1	21.2
11.0	9.8	127	28.4	118	26.2	110	24.2	106	23.1	102	22.1	93.1	20.2	
13.0	11.8	127	26.9	118	24.9	110	22.9	106	22.0	102	21.0	93.1	19.2	
15.0	13.7	127	25.5	118	23.7	110	21.8	106	20.9	102	20.0	93.1	18.3	
70% 86.45 kW	-19.8	-20.0	78.4	31.8	78.2	32.9	78.0	34.0	77.9	34.6	77.8	35.2	77.6	36.3
	-18.8	-19.0	80.0	32.2	79.8	33.3	79.6	34.4	79.5	34.9	79.4	35.4	79.2	36.5
	-16.7	-17.0	83.5	32.9	83.3	33.9	83.1	35.0	83.0	35.5	82.9	36.0	81.4	36.2
	-13.7	-15.0	87.2	33.6	87.0	34.6	86.8	35.6	86.7	36.1	86.6	36.6	81.4	34.3
	-11.8	-13.0	91.3	34.3	91.1	35.2	90.9	36.2	90.8	36.7	90.8	36.0	81.4	32.4
	-9.8	-11.0	95.6	35.0	95.4	35.9	95.2	36.8	92.5	35.7	88.8	34.0	81.4	30.7
	-9.5	-10.0	97.9	35.3	97.7	36.2	96.3	36.3	92.5	34.7	88.8	33.0	81.4	29.8
	-8.5	-9.1	100	35.6	100	36.5	96.3	35.4	92.5	33.8	88.8	32.2	81.4	29.1
	-7.0	-7.6	104	36.1	103	36.9	96.3	33.9	92.5	32.3	88.8	30.8	81.4	27.9
	-5.0	-5.6	109	36.7	104	34.9	96.3	32.0	92.5	30.5	88.8	29.1	81.4	26.4
	-3.0	-3.7	111	35.8	104	33.0	96.3	30.2	92.5	28.9	88.8	27.6	81.4	25.0
	0.0	-0.7	111	32.8	104	30.2	96.3	27.8	92.5	26.6	88.8	25.4	81.4	23.0
	3.0	2.2	111	30.1	104	27.8	96.3	25.6	92.5	24.5	88.8	23.4	81.4	21.3
	5.0	4.1	111	28.5	104	26.4	96.3	24.3	92.5	23.3	88.8	22.3	81.4	20.3
	7.0	6.0	111	27.1	104	25.0	96.3	23.1	92.5	22.1	88.8	21.2	81.4	19.3
	9.0	7.9	111	25.7	104	23.8	96.3	22.0	92.5	21.1	88.8	20.2	81.4	18.4
11.0	9.8	111	24.4	104	22.6	96.3	20.9	92.5	20.1	88.8	19.2	81.4	17.6	
13.0	11.8	111	23.2	104	21.5	96.3	19.9	92.5	19.1	88.8	18.3	81.4	16.7	
15.0	13.7	111	22.1	104	20.5	96.3	19.0	92.5	18.2	88.8	17.5	81.4	16.0	
60% 74.10 kW	-19.8	-20.0	78.0	34.2	77.8	35.2	77.6	36.1	77.5	36.6	76.2	36.1	69.8	32.6
	-18.8	-19.0	79.6	34.5	79.4	35.4	79.2	36.4	79.1	36.8	76.2	35.2	69.8	31.7
	-16.7	-17.0	83.0	35.1	82.9	36.0	82.5	36.8	79.3	35.1	76.2	33.4	69.8	30.2
	-13.7	-15.0	86.8	35.7	86.6	36.6	82.5	34.8	79.3	33.2	76.2	31.7	69.8	28.6
	-11.8	-13.0	90.8	36.3	88.8	36.0	82.5	32.9	79.3	31.5	76.2	30.0	69.8	27.1
	-9.8	-11.0	95.2	36.9	88.8	34.0	82.5	31.1	79.3	29.8	76.2	28.4	69.8	25.7
	-9.5	-10.0	95.2	35.9	88.8	33.0	82.5	30.3	79.3	28.9	76.2	27.6	69.8	25.0
	-8.5	-9.1	95.2	34.9	88.8	32.2	82.5	29.5	79.3	28.2	76.2	26.9	69.8	24.4
	-7.0	-7.6	95.2	33.4	88.8	30.8	82.5	28.3	79.3	27.1	76.2	25.8	69.8	23.5
	-5.0	-5.6	95.2	31.5	88.8	29.1	82.5	26.8	79.3	25.6	76.2	24.5	69.8	22.2
	-3.0	-3.7	95.2	29.9	88.8	27.6	82.5	25.4	79.3	24.3	76.2	23.2	69.8	21.1
	0.0	-0.7	95.2	27.4	88.8	25.4	82.5	23.4	79.3	22.4	76.2	21.4	69.8	19.5
	3.0	2.2	95.2	25.3	88.8	23.4	82.5	21.6	79.3	20.7	76.2	19.9	69.8	18.1
	5.0	4.1	95.2	24.0	88.8	22.3	82.5	20.6	79.3	19.7	76.2	18.9	69.8	17.3
	7.0	6.0	95.2	22.8	88.8	21.2	82.5	19.6	79.3	18.8	76.2	18.0	69.8	16.5
	9.0	7.9	95.2	21.7	88.8	20.2	82.5	18.7	79.3	17.9	76.2	17.2	69.8	15.8
11.0	9.8	95.2	20.7	88.8	19.2	82.5	17.8	79.3	17.1	76.2	16.4	69.8	15.1	
13.0	11.8	95.2	19.6	88.8	18.3	82.5	17.0	79.3	16.3	76.2	15.7	69.8	14.4	
15.0	13.7	95.2	18.7	88.8	17.5	82.5	16.2	79.3	15.6	76.2	15.0	69.8	13.8	
50% 61.75 kW	-19.8	-20.0	77.5	36.6	74.0	34.9	68.8	32.0	66.1	30.5	63.5	29.1	58.2	26.4
	-18.8	-19.0	79.1	36.8	74.0	34.0	68.8	31.2	66.1	29.8	63.5	28.4	58.2	25.8
	-16.7	-17.0	79.3	35.1	74.0	32.3	68.8	29.6	66.1	28.3	63.5	27.0	58.2	24.5
	-13.7	-15.0	79.3	33.2	74.0	30.6	68.8	28.1	66.1	26.9	63.5	25.7	58.2	23.3
	-11.8	-13.0	79.3	31.5	74.0	29.0	68.8	26.7	66.1	25.5	63.5	24.4	58.2	22.2
	-9.8	-11.0	79.3	29.8	74.0	27.5	68.8	25.3	66.1	24.2	63.5	23.2	58.2	21.1
	-9.5	-10.0	79.3	28.9	74.0	26.8	68.8	24.6	66.1	23.6	63.5	22.6	58.2	20.5
	-8.5	-9.1	79.3	28.2	74.0	26.1	68.8	24.0	66.1	23.0	63.5	22.0	58.2	20.1
	-7.0	-7.6	79.3	27.1	74.0	25.0	68.8	23.1	66.1	22.1	63.5	21.2	58.2	19.3
	-5.0	-5.6	79.3	25.6	74.0	23.7	68.8	21.9	66.1	21.0	63.5	20.1	58.2	18.4
	-3.0	-3.7	79.3	24.3	74.0	22.5	68.8	20.8	66.1	20.0	63.5	19.1	58.2	17.5
	0.0	-0.7	79.3	22.4	74.0	20.8	68.8	19.2	66.1	18.5	63.5	17.7	58.2	16.2
	3.0	2.2	79.3	20.7	74.0	19.3	68.8	17.9	66.1	17.2	63.5	16.5	58.2	15.1

5 Таблицы производительности

5 - 2 Таблицы теплопроизводительностей

RXYQ46T		Indoor air temp. °CDB												
Combination(%) (Capacity index)	Outdoor air temp.		16.0		18.0		20.0		21.0		22.0		24.0	
	(°CDB)	(°CWB)	TC	PI	TC	PI	TC	PI	TC	PI	TC	PI	TC	PI
			KW	KW	KW	KW	KW	KW	KW	KW	KW	KW	KW	KW
130% 169.00 kW	-19.8	-20.0	85.1	18.6	84.7	20.8	84.3	23.0	84.1	24.1	83.9	25.2	83.5	27.4
	-18.8	-19.0	86.6	19.2	86.2	21.3	85.8	23.5	85.6	24.6	85.4	25.7	85.0	27.8
	-16.7	-17.0	89.9	20.5	89.5	22.5	89.1	24.6	88.9	25.7	88.7	26.7	88.3	28.8
	-13.7	-15.0	93.6	21.8	93.2	23.8	92.8	25.8	92.6	26.8	92.4	27.8	92.0	29.8
	-11.8	-13.0	97.7	23.1	97.3	25.0	96.9	26.9	96.7	27.9	96.5	28.8	96.1	30.7
	-9.8	-11.0	102	24.4	102	26.3	101	28.1	101	29.0	101	29.9	101	31.7
	-9.5	-10.0	104	25.1	104	26.9	104	28.6	103	29.5	103	30.4	103	32.2
	-8.5	-9.1	107	25.7	106	27.4	106	29.2	106	30.0	105	30.9	105	32.6
	-7.0	-7.6	111	26.6	110	28.3	110	30.0	110	30.8	109	31.7	109	33.3
	-5.0	-5.6	116	27.9	116	29.5	115	31.1	115	31.9	115	32.7	114	34.3
	-3.0	-3.7	122	29.1	121	30.6	121	32.1	121	32.8	120	33.6	120	35.1
	0.0	-0.7	131	30.8	131	32.2	130	33.6	130	34.3	130	35.0	129	36.4
	3.0	2.2	141	32.3	141	33.6	140	34.9	140	35.6	140	36.2	139	37.5
	5.0	4.1	148	33.3	148	34.5	147	35.8	147	36.4	147	37.0	146	38.2
	7.0	6.0	155	34.2	155	35.4	154	36.6	154	37.2	154	37.7	154	38.9
	9.0	7.9	163	35.1	163	36.2	162	37.3	162	37.9	162	38.4	160	39.9
	11.0	9.8	171	35.9	170	37.0	170	38.0	170	38.6	170	39.1	160	40.6
13.0	11.8	180	36.7	179	37.7	179	38.7	179	39.3	174	38.2	160	41.4	
15.0	13.7	188	37.5	188	38.4	188	39.4	181	37.9	174	36.0	160	42.2	
120% 156.00 kW	-19.8	-20.0	84.7	21.1	84.3	23.1	83.9	25.2	83.8	26.2	83.6	27.2	83.2	29.3
	-18.8	-19.0	86.2	21.7	85.8	23.7	85.4	25.7	85.3	26.7	85.1	27.7	84.7	29.7
	-16.7	-17.0	89.5	22.9	89.1	24.8	88.7	26.7	88.6	27.7	88.4	28.6	88.0	30.6
	-13.7	-15.0	93.2	24.1	92.8	25.9	92.4	27.8	92.2	28.7	92.1	29.6	91.7	31.4
	-11.8	-13.0	97.2	25.3	96.9	27.1	96.5	28.8	96.3	29.7	96.1	30.6	95.8	32.4
	-9.8	-11.0	102	26.5	101	28.2	101	29.9	101	30.7	101	31.6	100	33.3
	-9.5	-10.0	104	27.1	104	28.8	103	30.4	103	31.2	103	32.1	103	33.7
	-8.5	-9.1	106	27.7	106	29.3	105	30.9	105	31.7	105	32.5	105	34.1
	-7.0	-7.6	110	28.6	110	30.1	109	31.7	109	32.4	109	33.2	109	34.8
	-5.0	-5.6	116	29.7	115	31.2	115	32.7	115	33.4	114	34.1	114	35.6
	-3.0	-3.7	121	30.8	121	32.2	120	33.6	120	34.3	120	35.0	120	36.4
	0.0	-0.7	131	32.4	130	33.7	130	35.0	130	35.6	129	36.3	129	37.6
	3.0	2.2	141	33.8	140	35.0	140	36.2	140	36.8	139	37.4	139	38.6
	5.0	4.1	147	34.7	147	35.9	147	37.0	147	37.6	146	38.2	146	39.3
	7.0	6.0	155	35.6	154	36.7	154	37.7	154	38.3	154	38.8	147	37.5
	9.0	7.9	162	36.4	162	37.4	162	38.4	162	39.0	161	39.2	147	35.3
	11.0	9.8	170	37.1	170	38.1	170	39.1	167	38.8	161	36.9	147	33.3
13.0	11.8	179	37.9	179	38.8	174	38.2	167	36.5	161	34.7	147	31.4	
15.0	13.7	188	38.6	187	39.4	174	36.0	167	34.4	161	32.8	147	29.7	
110% 143.00 kW	-19.8	-20.0	84.2	23.6	83.9	25.5	83.5	27.4	83.4	28.3	83.2	29.3	82.9	31.1
	-18.8	-19.0	85.7	24.2	85.4	26.0	85.0	27.8	84.9	28.8	84.7	29.7	84.4	31.5
	-16.7	-17.0	89.0	25.3	88.7	27.0	88.3	28.8	88.2	29.7	88.0	30.6	87.7	32.3
	-13.7	-15.0	92.7	26.4	92.4	28.1	92.0	29.8	91.9	30.6	91.7	31.4	91.4	33.1
	-11.8	-13.0	96.8	27.5	96.4	29.1	96.1	30.7	95.9	31.5	95.8	32.4	95.4	34.0
	-9.8	-11.0	101	28.6	101	30.2	101	31.7	100	32.5	100	33.3	100	34.8
	-9.5	-10.0	104	29.2	103	30.7	103	32.2	103	33.0	103	33.7	102	35.2
	-8.5	-9.1	106	29.7	105	31.2	105	32.6	105	33.4	105	34.1	104	35.6
	-7.0	-7.6	110	30.5	109	31.9	109	33.3	109	34.0	109	34.8	108	36.2
	-5.0	-5.6	115	31.6	115	32.9	114	34.3	114	34.9	114	35.6	114	37.0
	-3.0	-3.7	121	32.5	120	33.8	120	35.1	120	35.8	120	36.4	119	37.7
	0.0	-0.7	130	34.0	130	35.2	129	36.4	129	37.0	129	37.6	129	38.8
	3.0	2.2	140	35.3	140	36.4	139	37.5	139	38.1	139	38.6	135	38.1
	5.0	4.1	147	36.2	147	37.2	146	38.2	146	38.8	146	39.3	135	35.9
	7.0	6.0	154	36.9	154	37.9	154	38.9	153	39.4	147	37.5	135	33.8
	9.0	7.9	162	37.7	162	38.6	160	38.9	153	37.1	147	35.3	135	31.9
	11.0	9.8	170	38.4	170	39.3	160	36.6	153	35.0	147	33.3	135	30.1
13.0	11.8	179	39.1	172	37.6	160	34.4	153	32.9	147	31.4	135	28.4	
15.0	13.7	184	38.6	172	35.5	160	32.5	153	31.1	147	29.7	135	26.9	
100% 130.00 kW	-19.8	-20.0	83.8	26.2	83.5	27.9	83.1	29.6	83.0	30.4	82.8	31.3	82.5	33.0
	-18.8	-19.0	85.3	26.7	85.0	28.3	84.7	30.0	84.5	30.8	84.3	31.7	84.0	33.3
	-16.7	-17.0	88.6	27.7	88.3	29.3	88.0	30.9	87.8	31.7	87.6	32.5	87.3	34.1
	-13.7	-15.0	92.2	28.7	91.9	30.2	91.6	31.8	91.5	32.5	91.3	33.3	91.0	34.8
	-11.8	-13.0	96.3	29.7	96.0	31.2	95.7	32.6	95.5	33.4	95.4	34.1	95.1	35.6
	-9.8	-11.0	101	30.7	100	32.1	100	33.5	100	34.2	100	34.9	100	36.3
	-9.5	-10.0	103	31.2	103	32.6	102	34.0	102	34.7	102	35.3	102	36.7
	-8.5	-9.1	105	31.7	105	33.0	105	34.4	105	35.0	104	35.7	104	37.0
	-7.0	-7.6	109	32.4	109	33.7	109	35.0	108	35.7	108	36.3	108	37.6
	-5.0	-5.6	115	33.4	114	34.6	114	35.9	114	36.5	114	37.1	113	38.3
	-3.0	-3.7	120	34.3	120	35.5	120	36.6	119	37.2	119	37.8	119	39.0
	0.0	-0.7	130	35.6	129	36.7	129	37.8	129	38.3	129	38.9	123	37.2
	3.0	2.2	140	36.8	139	37.8	139	38.8	139	39.3	134	37.7	123	34.0
	5.0	4.1	147	37.6	146	38.5	145	39.1	139	37.3	134	35.5	123	32.1
	7.0	6.0	154	38.3	154	39.2	145	36.8	139	35.1	134	33.5	123	30.3
	9.0	7.9	162	39.0	156	37.9	145	34.7	139	33.1	134	31.6	123	28.6
	11.0	9.8	167	38.8	156	35.7	145	32.7	139	31.3	134	29.8	123	27.1
13.0	11.8	167	36.5	156	33.6	145	30.8	139	29.5	134	28.1	123	25.5	
15.0	13.7	167	34.4	156	31.7	145	29.2	139	27.9	134	26.7	123	24.2	

NOTES - ANMERKUNGEN - Σημειώσεις - NOTAS - REMARQUES - NOTE - OPMERKINGEN - примечания - NOTLAR

- is shown as reference. When selecting the unit models, avoid the Outdoor air temperature range shown by .
 dient als Verweis. Vermijden Sie bei der Auswahl der Gerätemodelle den als markierten Temperaturbereich der Außenluft.
 Η είναι ενδεικτική, κατά την επιλογή των μοντέλων των μονάδων, αποφύγετε το εύρος θερμοκρασίας εξωτερικού αέρα που υποδεικνύεται.
 se muestra como referencia. Cuando seleccione los modelos de unidad, evite el intervalo de temperaturas del aire exterior indicado mediante .
 est montré comme référence. Lors du choix des modèles d'unités, évitez la plage de températures de l'air extérieur illustré par .
 valori riportati unicamente come riferimento. Nel selezionare i modelli delle unità, non considerare i valori di temperatura dell'aria esterna indicati con il colore .
 is als referentie getoond. Wanneer modellen van eenheden worden gekozen, vermijd dan het bereik van buitenluchttemperaturen geïllustreerd door .
- показан как. При выборе модели устройства избегайте внешнюю температуру воздуха, указанную в .
 referans olarak gösterilmektedir. Ünite modellerini seçerken, belirtilen Dış hava sıcaklığı aralığından kaçınınız .
 The above table shows the average value of conditions which may occur.
 Die obige Tabelle zeigt den Durchschnittswert der Bedingungen, die auftreten können.
 Στον παραπάνω πίνακα αναγράφεται η μέση τιμή για συνθήκες που μπορεί να προκύψουν.
 La tabla de arriba muestra el valor medio de condiciones que pueden ocurrir.
 Le tableau ci-dessus donne la valeur moyenne pour des conditions qui peuvent survenir.
 La tabella in alto mostra il valore delle condizioni medie che si possono riscontrare.
 De tabel hierboven geeft de gemiddelde waarde aan van situaties die kunnen voorvallen.
 Таблица расположенная выше показывает среднее значение условий, которые могут наступить.
 Yukarıdaki tablo meydana gelebilecek koşulların ortalama değerini göstermektedir.

3D079549

5 Таблицы производительности

5 - 2 Таблицы теплопроизводительностей

5

RXYQ46T														
Indoor air temp. °CDB														
Combination(%) (Capacity index)	Outdoor air temp.		16.0		18.0		20.0		21.0		22.0		24.0	
			TC	PI	TC	PI	TC	PI	TC	PI	TC	PI	TC	PI
	(°CDB)	(°CWB)	KW	KW	KW	KW	KW	KW	KW	KW	KW	KW	KW	KW
90% 117.00 kW	-19.8	-20.0	83.3	28.7	83.0	30.3	82.7	31.8	82.6	32.6	82.5	33.3	82.2	34.9
	-18.8	-19.0	84.8	29.2	84.5	30.7	84.3	32.2	84.1	32.9	84.0	33.7	83.7	35.2
	-16.7	-17.0	88.1	30.1	87.8	31.5	87.6	33.0	87.4	33.7	87.3	34.4	87.0	35.8
	-13.7	-15.0	91.8	31.0	91.5	32.4	91.2	33.7	91.1	34.4	91.0	35.1	90.7	36.5
	-11.8	-13.0	95.8	31.9	95.6	33.2	95.3	34.6	95.2	35.2	95.0	35.9	94.7	37.2
	-9.8	-11.0	100	32.8	100	34.1	100	35.4	100	36.0	99	36.6	99	37.9
	-9.5	-10.0	103	33.3	102	34.5	102	35.8	102	36.4	102	37.0	102	38.2
	-8.5	-9.1	105	33.7	105	34.9	104	36.1	104	36.7	104	37.3	104	38.5
	-7.0	-7.6	109	34.4	108	35.5	108	36.7	108	37.3	108	37.9	108	39.0
	-5.0	-5.6	114	35.2	114	36.3	114	37.4	113	38.0	113	38.6	110	38.2
	-3.0	-3.7	120	36.0	119	37.1	119	38.1	119	38.7	119	39.2	110	36.0
	0.0	-0.7	129	37.3	129	38.2	129	39.2	125	38.2	120	36.4	110	32.9
	3.0	2.2	139	38.3	139	39.2	131	36.6	125	34.9	120	33.3	110	30.1
	5.0	4.1	146	39.0	141	37.6	131	34.5	125	32.9	120	31.4	110	28.4
	7.0	6.0	151	38.5	141	35.5	131	32.5	125	31.1	120	29.6	110	26.9
	9.0	7.9	151	36.3	141	33.4	131	30.7	125	29.3	120	28.0	110	25.4
	11.0	9.8	151	34.2	141	31.6	131	29.0	125	27.7	120	26.5	110	24.1
13.0	11.8	151	32.2	141	29.7	131	27.4	125	26.2	120	25.0	110	22.8	
15.0	13.7	151	30.4	141	28.1	131	25.9	125	24.8	120	23.7	110	21.6	
80% 104.00 kW	-19.8	-20.0	82.8	31.3	82.6	32.7	82.4	34.0	82.2	34.7	82.1	35.4	81.9	36.7
	-18.8	-19.0	84.3	31.7	84.1	33.0	83.9	34.3	83.7	35.0	83.6	35.7	83.4	37.0
	-16.7	-17.0	87.6	32.5	87.4	33.8	87.2	35.0	87.0	35.7	86.9	36.3	86.7	37.6
	-13.7	-15.0	91.3	33.3	91.1	34.5	90.8	35.7	90.7	36.4	90.6	37.0	90.3	38.2
	-11.8	-13.0	95.4	34.1	95.1	35.3	94.9	36.5	94.8	37.0	94.7	37.6	94.4	38.8
	-9.8	-11.0	100	34.9	100	36.1	99	37.2	99	37.7	99	38.3	98	39.0
	-9.5	-10.0	102	35.3	102	36.4	102	37.5	102	38.1	101	38.6	98	37.9
	-8.5	-9.1	104	35.7	104	36.8	104	37.8	104	38.4	104	38.9	98	36.9
	-7.0	-7.6	108	36.3	108	37.3	108	38.4	108	38.9	107	39.1	98	35.3
	-5.0	-5.6	114	37.1	113	38.1	113	39.0	112	38.7	107	36.8	98	33.2
	-3.0	-3.7	119	37.8	119	38.7	116	38.2	112	36.5	107	34.7	98	31.4
	0.0	-0.7	129	38.9	125	38.0	116	34.8	112	33.2	107	31.7	98	28.7
	3.0	2.2	134	37.7	125	34.7	116	31.8	112	30.4	107	29.0	98	26.3
	5.0	4.1	134	35.5	125	32.7	116	30.1	112	28.7	107	27.4	98	24.9
	7.0	6.0	134	33.5	125	30.9	116	28.4	112	27.2	107	26.0	98	23.6
	9.0	7.9	134	31.6	125	29.2	116	26.9	112	25.7	107	24.6	98	22.4
	11.0	9.8	134	29.8	125	27.6	116	25.4	112	24.4	107	23.3	98	21.2
13.0	11.8	134	28.1	125	26.1	116	24.0	112	23.0	107	22.0	98	20.1	
15.0	13.7	134	26.7	125	24.7	116	22.8	112	21.9	107	20.9	98	19.1	
70% 91.00 kW	-19.8	-20.0	82.4	33.8	82.2	35.0	82.0	36.2	81.8	36.8	81.7	37.4	81.5	38.6
	-18.8	-19.0	83.9	34.2	83.7	35.3	83.5	36.5	83.4	37.1	83.2	37.7	83.0	38.8
	-16.7	-17.0	87.2	34.9	87.0	36.0	86.8	37.1	86.7	37.7	86.5	38.2	86.3	39.0
	-13.7	-15.0	90.9	35.6	90.7	36.7	90.4	37.7	90.3	38.3	90.2	38.8	89.9	37.1
	-11.8	-13.0	94.9	36.3	94.7	37.3	94.5	38.4	94.4	38.9	93.7	39.0	89.9	35.2
	-9.8	-11.0	99	37.0	99	38.0	99	39.0	97.6	38.7	93.7	36.9	89.9	33.3
	-9.5	-10.0	102	37.4	102	38.4	101	39.3	97.6	37.6	93.7	35.8	89.9	32.3
	-8.5	-9.1	104	37.7	104	38.6	102	38.4	97.6	36.6	93.7	34.9	89.9	31.5
	-7.0	-7.6	108	38.2	108	39.1	102	36.7	97.6	35.0	93.7	33.4	89.9	30.2
	-5.0	-5.6	113	38.9	109	37.7	102	34.6	97.6	33.0	93.7	31.5	89.9	28.5
	-3.0	-3.7	117	38.7	109	35.6	102	32.6	97.6	31.2	93.7	29.7	89.9	27.0
	0.0	-0.7	117	35.2	109	32.5	102	29.8	97.6	28.5	93.7	27.2	89.9	24.7
	3.0	2.2	117	32.2	109	29.7	102	27.3	97.6	26.2	93.7	25.0	89.9	22.8
	5.0	4.1	117	30.4	109	28.1	102	25.9	97.6	24.8	93.7	23.7	89.9	21.6
	7.0	6.0	117	28.7	109	26.6	102	24.5	97.6	23.5	93.7	22.5	89.9	20.5
	9.0	7.9	117	27.1	109	25.1	102	23.2	97.6	22.2	93.7	21.3	89.9	19.5
	11.0	9.8	117	25.7	109	23.8	102	22.0	97.6	21.1	93.7	20.2	89.9	18.5
13.0	11.8	117	24.3	109	22.5	102	20.8	97.6	20.0	93.7	19.2	89.9	17.6	
15.0	13.7	117	23.0	109	21.4	102	19.8	97.6	19.0	93.7	18.3	89.9	16.7	
60% 78.00 kW	-19.8	-20.0	81.9	36.4	81.7	37.4	81.6	38.4	81.5	38.9	80.3	38.6	73.6	34.8
	-18.8	-19.0	83.4	36.7	83.2	37.7	83.1	38.7	83.0	39.2	80.3	37.8	73.6	34.1
	-16.7	-17.0	86.7	37.3	86.5	38.2	86.4	39.2	83.7	37.8	80.3	37.0	73.6	32.5
	-13.7	-15.0	90.4	37.9	90.2	38.8	87.0	37.7	83.7	35.9	80.3	34.2	73.6	30.9
	-11.8	-13.0	94.5	38.5	93.7	39.0	87.0	35.7	83.7	34.1	80.3	32.5	73.6	29.4
	-9.8	-11.0	98.9	39.1	93.7	36.9	87.0	33.8	83.7	32.3	80.3	30.8	73.6	27.9
	-9.5	-10.0	100.4	38.9	93.7	35.8	87.0	32.8	83.7	31.4	80.3	29.9	73.6	27.1
	-8.5	-9.1	100.4	37.9	93.7	34.9	87.0	32.0	83.7	30.6	80.3	29.2	73.6	26.5
	-7.0	-7.6	100.4	36.2	93.7	33.4	87.0	30.6	83.7	29.3	80.3	28.0	73.6	25.4
	-5.0	-5.6	100.4	34.1	93.7	31.5	87.0	28.9	83.7	27.7	80.3	26.4	73.6	24.0
	-3.0	-3.7	100.4	32.2	93.7	29.7	87.0	27.4	83.7	26.2	80.3	25.0	73.6	22.8
	0.0	-0.7	100.4	29.4	93.7	27.2	87.0	25.1	83.7	24.0	80.3	23.0	73.6	21.0
	3.0	2.2	100.4	27.0	93.7	25.0	87.0	23.1	83.7	22.1	80.3	21.2	73.6	19.4
	5.0	4.1	100.4	25.5	93.7	23.7	87.0	21.9	83.7	21.0	80.3	20.1	73.6	18.4
	7.0	6.0	100.4	24.2	93.7	22.5	87.0	20.8	83.7	19.9	80.3	19.1	73.6	17.5
	9.0	7.9	100.4	22.9	93.7	21.3	87.0	19.7	83.7	18.9	80.3	18.2	73.6	16.7
	11.0	9.8	100.4	21.7	93.7	20.2	87.0	18.7	83.7	18.0	80.3	17.3	73.6	15.9
13.0	11.8	100.4	20.6	93.7	19.2	87.0	17.8	83.7	17.1	80.3	16.4	73.6	15.1	
15.0	13.7	100.4	19.6	93.7	18.3	87.0	17.0	83.7	16.3	80.3	15.7	73.6	14.4	
50% 65.00 kW	-19.8	-20.0	81.5	38.9	78.1	37.4	72.5	34.2	69.7	32.7	66.9	31.2	61.3	28.2
	-18.8	-19.0	83.0	39.2	78.1	36.5	72.5	33.5	69.7	32.0	66.9	30.5	61.3	27.6
	-16.7	-17.0	83.7	37.8	78.1	34.8	72.5	31.9	69.7	30.5	66.9	29.1	61.3	26.4
	-13.7	-15.0	83.7	35.9	78.1	33.1	72.5	30.4	69.7	29.1	66.9	27.8	61.3	25.2
	-11.8	-13.0	83.7	34.1	78.1	31.4	72.5	28.9	69.7	27.6	66.9	26.4	61.3	24.0
	-9.8	-11.0	83.7	32.3	78.1	29.8	72.5	27.4	69.7	26.2	66.9	25.1	61.3	22.8
	-9.5	-10.0	83.7	31.4	78.1	29.0	72.5	26.7	69.7	25.5	66.9	24.4	61.3	22.2
	-8.5	-9.1	83.7	30.6	78.1	28.3	72.5	26.0	69.7	24.9	66.9	23.8	61.3	21.7
	-7.0	-7.6	83.7	29.3	78.1	27.1	72.5	25.0	69.7	23.9	66.9	22.9	61.3	20.9
	-5.0	-5.6	83.7	27.7	78.1	25.6	72.5	23.6	69.7	22.6	66.9	21.7	61.3	19.8
	-3.0	-3.7	83.7	26.2	78.1	24.3	72.5	22.4	69.7	21.5	66.9	20.6	61.3	18.8
	0.0	-0.7	83.7	24.0	78.1	22.3	72.5	20.6	69.7	19.8	66.9	19.0	61.3	17.4
	3.0	2.2	83.7	22.1	78.1	20.6	72.5	19.1	69.7	18.3	66.9	17.6	61.3	16.1
	5.0	4.1	83.7	21.0	78.1	19.5	7							

5 Таблицы производительности

5 - 2 Таблицы теплопроизводительностей

RXYQ48T		Indoor air temp. °CDB												
Combination(%) (Capacity index)	Outdoor air temp.		16.0		18.0		20.0		21.0		22.0		24.0	
	(°CDB)	(°CWB)	TC	PI	TC	PI	TC	PI	TC	PI	TC	PI	TC	PI
			KW	KW	KW	KW	KW	KW	KW	KW	KW	KW	KW	KW
130% 175.50 kW	-19.8	-20.0	88.2	19.4	87.7	21.7	87.3	24.0	87.1	25.2	86.9	26.4	86.5	28.7
	-18.8	-19.0	89.7	20.1	89.3	22.3	88.9	24.6	88.7	25.7	88.5	26.9	88.1	29.1
	-16.7	-17.0	93.1	21.4	92.7	23.6	92.3	25.8	92.1	26.9	91.9	27.9	91.5	30.1
	-13.7	-15.0	96.9	22.8	96.5	24.9	96.1	27.0	95.9	28.0	95.7	29.0	95.3	31.1
	-11.8	-13.0	101.1	24.2	100.7	26.2	100.3	28.2	100.1	29.2	99.9	30.2	99.5	32.1
	-9.8	-11.0	106	25.6	105	27.5	105	29.4	105	30.3	105	31.3	104	33.2
	-9.5	-10.0	108	26.3	108	28.1	107	30.0	107	30.9	107	31.8	107	33.7
	-8.5	-9.1	110	26.9	110	28.7	110	30.5	109	31.4	109	32.3	109	34.1
	-7.0	-7.6	114	27.9	114	29.6	114	31.4	113	32.2	113	33.1	113	34.9
	-5.0	-5.6	120	29.2	120	30.8	119	32.5	119	33.3	119	34.2	118	35.8
	-3.0	-3.7	126	30.4	125	32.0	125	33.6	125	34.3	125	35.1	124	36.7
	0.0	-0.7	136	32.2	135	33.7	135	35.1	135	35.9	134	36.6	134	38.1
	3.0	2.2	146	33.8	146	35.2	145	36.5	145	37.2	145	37.9	144	39.3
	5.0	4.1	153	34.8	153	36.1	152	37.4	152	38.1	152	38.7	152	40.0
	7.0	6.0	161	35.8	160	37.0	160	38.2	160	38.9	160	39.5	159	40.7
	9.0	7.9	169	36.7	168	37.9	168	39.0	168	39.6	168	40.2	165	40.6
11.0	9.8	177	37.6	177	38.7	176	39.8	176	40.3	176	40.9	165	38.2	
13.0	11.8	186	38.4	186	39.5	185	40.5	185	41.0	180	39.9	165	35.9	
15.0	13.7	195	39.2	195	40.2	194	41.2	188	39.5	180	37.6	165	33.9	
120% 162.00 kW	-19.8	-20.0	87.7	22.1	87.3	24.2	86.9	26.4	86.7	27.4	86.5	28.5	86.2	30.6
	-18.8	-19.0	89.2	22.7	88.9	24.8	88.5	26.9	88.3	27.9	88.1	29.0	87.7	31.0
	-16.7	-17.0	92.7	23.9	92.3	25.9	91.9	27.9	91.7	28.9	91.5	29.9	91.1	32.0
	-13.7	-15.0	96.5	25.2	96.1	27.1	95.7	29.0	95.5	30.0	95.3	31.0	94.9	32.9
	-11.8	-13.0	100.7	26.5	100.3	28.3	99.9	30.2	99.7	31.1	99.5	32.0	99.2	33.8
	-9.8	-11.0	105	27.8	105	29.5	105	31.3	104	32.1	104	33.0	104	34.8
	-9.5	-10.0	108	28.4	107	30.1	107	31.8	107	32.7	107	33.5	106	35.2
	-8.5	-9.1	110	29.0	110	30.6	109	32.3	109	33.1	109	34.0	108	35.7
	-7.0	-7.6	114	29.9	114	31.5	113	33.1	113	33.9	113	34.7	112	36.3
	-5.0	-5.6	120	31.1	119	32.6	119	34.2	119	34.9	119	35.7	118	37.2
	-3.0	-3.7	125	32.2	125	33.7	125	35.1	124	35.9	124	36.6	124	38.1
	0.0	-0.7	135	33.9	135	35.2	134	36.6	134	37.3	134	37.9	134	39.3
	3.0	2.2	146	35.4	145	36.6	145	37.9	145	38.5	144	39.1	144	40.4
	5.0	4.1	153	36.3	152	37.5	152	38.7	152	39.3	152	39.9	151	41.1
	7.0	6.0	160	37.2	160	38.3	160	39.5	159	40.0	159	40.6	152	39.1
	9.0	7.9	168	38.0	168	39.1	168	40.2	167	40.7	166	40.9	152	36.9
11.0	9.8	177	38.8	176	39.9	176	40.9	173	40.5	166	38.5	152	34.8	
13.0	11.8	186	39.6	185	40.6	180	39.9	173	38.0	166	36.2	152	32.7	
15.0	13.7	195	40.3	194	41.1	180	37.6	173	35.9	166	34.2	152	31.0	
110% 148.50 kW	-19.8	-20.0	87.2	24.8	86.9	26.7	86.5	28.7	86.3	29.6	86.2	30.6	85.8	32.6
	-18.8	-19.0	88.8	25.3	88.4	27.2	88.1	29.1	87.9	30.1	87.7	31.0	87.4	33.0
	-16.7	-17.0	92.2	26.4	91.8	28.3	91.5	30.1	91.3	31.0	91.1	32.0	90.8	33.8
	-13.7	-15.0	96.0	27.6	95.6	29.4	95.3	31.1	95.1	32.0	94.9	32.9	94.6	34.7
	-11.8	-13.0	100.2	28.8	99.8	30.5	99.5	32.1	99.3	33.0	99.2	33.8	98.8	35.5
	-9.8	-11.0	105	30.0	104	31.6	104	33.2	104	34.0	104	34.8	103	36.4
	-9.5	-10.0	107	30.5	107	32.1	107	33.7	106	34.5	106	35.2	106	36.8
	-8.5	-9.1	110	31.1	109	32.6	109	34.1	109	34.9	108	35.7	108	37.2
	-7.0	-7.6	114	31.9	113	33.4	113	34.9	113	35.6	112	36.3	112	37.8
	-5.0	-5.6	119	33.0	119	34.4	118	35.8	118	36.5	118	37.2	118	38.6
	-3.0	-3.7	125	34.0	125	35.4	124	36.7	124	37.4	124	38.1	124	39.4
	0.0	-0.7	135	35.6	134	36.8	134	38.1	134	38.7	134	39.3	133	40.5
	3.0	2.2	145	37.0	145	38.1	144	39.3	144	39.8	144	40.4	140	39.7
	5.0	4.1	152	37.8	152	38.9	152	40.0	151	40.5	151	41.1	140	37.4
	7.0	6.0	160	38.6	160	39.7	159	40.7	159	41.1	152	39.1	140	35.3
	9.0	7.9	168	39.4	167	40.4	165	40.6	159	38.7	152	36.9	140	33.3
11.0	9.8	176	40.1	176	41.1	165	38.2	159	36.5	152	34.8	140	31.4	
13.0	11.8	185	40.8	178	39.3	165	35.9	159	34.3	152	32.7	140	29.6	
15.0	13.7	190	40.2	178	37.0	165	33.9	159	32.4	152	31.0	140	28.1	
100% 135.00 kW	-19.8	-20.0	86.7	27.4	86.4	29.2	86.1	31.0	85.9	31.8	85.8	32.7	85.5	34.5
	-18.8	-19.0	88.3	27.9	88.0	29.7	87.7	31.4	87.5	32.3	87.3	33.1	87.0	34.9
	-16.7	-17.0	91.7	28.9	91.4	30.6	91.1	32.3	90.9	33.1	90.8	34.0	90.4	35.6
	-13.7	-15.0	95.5	30.0	95.2	31.6	94.9	33.2	94.7	34.0	94.6	34.8	94.3	36.4
	-11.8	-13.0	99.7	31.1	99.4	32.6	99.1	34.1	98.9	34.9	98.8	35.7	98.5	37.2
	-9.8	-11.0	104	32.1	104	33.6	104	35.1	104	35.8	103	36.5	103	38.0
	-9.5	-10.0	107	32.7	106	34.1	106	35.5	106	36.2	106	37.0	106	38.4
	-8.5	-9.1	109	33.1	109	34.5	108	35.9	108	36.6	108	37.3	108	38.7
	-7.0	-7.6	113	33.9	113	35.3	112	36.6	112	37.3	112	38.0	112	39.3
	-5.0	-5.6	119	34.9	118	36.2	118	37.5	118	38.1	118	38.8	117	40.1
	-3.0	-3.7	124	35.9	124	37.1	124	38.3	124	38.9	124	39.5	123	40.7
	0.0	-0.7	134	37.3	134	38.4	134	39.5	133	40.1	133	40.6	127	38.8
	3.0	2.2	145	38.5	144	39.6	144	40.6	144	41.1	138	39.3	127	35.5
	5.0	4.1	152	39.3	151	40.3	150	40.8	144	38.9	138	37.0	127	33.5
	7.0	6.0	159	40.0	159	41.0	150	38.4	144	36.6	138	34.9	127	31.6
	9.0	7.9	167	40.7	162	39.5	150	36.2	144	34.6	138	33.0	127	29.8
11.0	9.8	173	40.5	162	37.3	150	34.2	144	32.6	138	31.1	127	28.2	
13.0	11.8	173	38.0	162	35.1	150	32.2	144	30.8	138	29.4	127	26.7	
15.0	13.7	173	35.9	162	33.1	150	30.4	144	29.1	138	27.8	127	25.3	

NOTES - ANMERKUNGEN - Σημειώσεις - NOTAS - REMARQUES - NOTE - OPMERKINGEN - примечания - NOTLAR

1. [] is shown as reference. When selecting the unit models, avoid the Outdoor air temperature range shown by [].
 dient als Verweis. Vermeiden Sie bei der Auswahl der Gerätemodelle den als markierten Temperaturbereich der Außenluft.
 Η [] είναι ενδεικτική, κατά την επιλογή των μοντέλων των μονάδων, αποφεύγετε το εύρος θερμοκρασίας εξωτερικού αέρα που υποδεικνύεται [].
 se muestra como referencia. Cuando seleccione los modelos de unidad, evite el intervalo de temperaturas del aire exterior indicado mediante [].
 est montré comme référence. Lors du choix des modèles d'unités, évitez la plage de températures de l'air extérieur illustré par [].
 valori riportati unicamente come riferimento. Nel selezionare i modelli delle unità, non considerare i valori di temperatura dell'aria esterna indicati con il colore [].
 is als referentie getoond. Wanneer modellen van eenheden worden gekozen, vermijd dan het bereik van buitenluchttemperaturen geïllustreerd door [].

2. The above table shows the average value of conditions which may occur.
 Die obige Tabelle zeigt den Durchschnittswert der Bedingungen, die auftreten können.
 Στον παραπάνω πίνακα αναγράφεται η μέση τιμή για συνθήκες που μπορεί να προκύψουν.
 La tabla de arriba muestra el valor medio de condiciones que pueden ocurrir.
 Le tableau ci-dessus donne la valeur moyenne pour des conditions qui peuvent survenir.
 La tabella in alto mostra il valore delle condizioni medie che si possono riscontrare.
 De tabel hierboven geeft de gemiddelde waarde aan van situaties die kunnen voorvallen.
 Таблица расположенная выше показывает среднее значение условий, которые могут наступить.
 Yukarıdaki tablo meydana gelebilecek koşulların ortalama değerini göstermektedir.

5 Таблицы производительности

5 - 2 Таблицы теплопроизводительностей

5

RXYQ48T														
Indoor air temp. °CDB														
Combination(%) (Capacity index)	Outdoor air temp.		16.0		18.0		20.0		21.0		22.0		24.0	
			TC	PI	TC	PI	TC	PI	TC	PI	TC	PI	TC	PI
	(°CDB)	(°CWB)	KW	KW	KW	KW	KW	KW	KW	KW	KW	KW	KW	KW
90% 121.50 kW	-19.8	-20.0	86.3	30.1	86.0	31.7	85.7	33.3	85.6	34.1	85.4	34.9	85.1	36.5
	-18.8	-19.0	87.8	30.5	87.5	32.1	87.3	33.7	87.1	34.4	87.0	35.2	86.7	36.8
	-16.7	-17.0	91.2	31.5	90.9	33.0	90.7	34.5	90.5	35.2	90.4	36.0	90.1	37.5
	-13.7	-15.0	95.0	32.4	94.8	33.9	94.5	35.3	94.3	36.0	94.2	36.7	93.9	38.2
	-11.8	-13.0	99.2	33.4	99.0	34.8	98.7	36.1	98.5	36.8	98.4	37.5	98.1	38.9
	-9.8	-11.0	104	34.3	104	35.7	103	37.0	103	37.6	103	38.3	103	39.6
	-9.5	-10.0	106	34.8	106	36.1	106	37.4	106	38.0	105	38.7	105	40.0
	-8.5	-9.1	109	35.2	108	36.5	108	37.8	108	38.4	108	39.0	107	40.3
	-7.0	-7.6	113	35.9	112	37.2	112	38.4	112	39.0	112	39.6	111	40.8
	-5.0	-5.6	118	36.9	118	38.0	118	39.2	118	39.7	117	40.3	114	39.9
	-3.0	-3.7	124	37.7	124	38.8	123	39.9	123	40.4	123	41.0	114	37.6
	0.0	-0.7	134	39.0	134	40.0	133	41.0	130	39.9	125	38.0	114	34.3
	3.0	2.2	144	40.1	144	41.0	135	38.2	130	36.4	125	34.7	114	31.4
	5.0	4.1	151	40.8	145	39.3	135	36.0	130	34.3	125	32.8	114	29.7
	7.0	6.0	156	40.2	145	37.0	135	33.9	130	32.4	125	30.9	114	28.0
	9.0	7.9	156	37.8	145	34.9	135	32.0	130	30.6	125	29.2	114	26.5
	11.0	9.8	156	35.7	145	32.9	135	30.3	130	28.9	125	27.7	114	25.1
13.0	11.8	156	33.6	145	31.0	135	28.5	130	27.3	125	26.1	114	23.8	
15.0	13.7	156	31.8	145	29.4	135	27.0	130	25.9	125	24.8	114	22.6	
80% 108.00 kW	-19.8	-20.0	85.8	32.7	85.5	34.2	85.3	35.6	85.2	36.3	85.0	37.0	84.8	38.4
	-18.8	-19.0	87.3	33.1	87.1	34.5	86.8	35.9	86.7	36.6	86.6	37.3	86.3	38.7
	-16.7	-17.0	90.8	34.0	90.5	35.3	90.3	36.6	90.1	37.3	90.0	38.0	89.7	39.3
	-13.7	-15.0	94.6	34.8	94.3	36.1	94.1	37.4	93.9	38.0	93.8	38.7	93.6	39.9
	-11.8	-13.0	98.8	35.7	98.5	36.9	98.3	38.1	98.1	38.7	98.0	39.4	97.8	40.6
	-9.8	-11.0	103	36.5	103	37.7	103	38.9	103	39.5	103	40.0	102	40.7
	-9.5	-10.0	106	37.0	106	38.1	105	39.2	105	39.8	105	40.4	102	39.5
	-8.5	-9.1	108	37.3	108	38.5	108	39.6	107	40.1	107	40.7	102	38.5
	-7.0	-7.6	112	38.0	112	39.0	112	40.1	111	40.6	111	40.9	102	36.8
	-5.0	-5.6	118	38.8	118	39.8	117	40.8	115	40.4	111	38.4	102	34.7
	-3.0	-3.7	124	39.5	123	40.5	120	39.9	115	38.1	111	36.3	102	32.8
	0.0	-0.7	133	40.6	129	39.7	120	36.3	115	34.7	111	33.1	102	29.9
	3.0	2.2	138	39.3	129	36.2	120	33.2	115	31.8	111	30.3	102	27.5
	5.0	4.1	138	37.0	129	34.2	120	31.4	115	30.0	111	28.6	102	26.0
	7.0	6.0	138	34.9	129	32.2	120	29.6	115	28.3	111	27.1	102	24.6
	9.0	7.9	138	33.0	129	30.5	120	28.0	115	26.8	111	25.6	102	23.4
	11.0	9.8	138	31.1	129	28.8	120	26.5	115	25.4	111	24.3	102	22.2
13.0	11.8	138	29.4	129	27.2	120	25.1	115	24.0	111	23.0	102	21.0	
15.0	13.7	138	27.8	129	25.8	120	23.8	115	22.8	111	21.8	102	20.0	
70% 94.50 kW	-19.8	-20.0	85.3	35.4	85.1	36.6	84.9	37.9	84.8	38.5	84.7	39.1	84.4	40.4
	-18.8	-19.0	86.9	35.7	86.7	37.0	86.4	38.2	86.3	38.8	86.2	39.4	86.0	40.6
	-16.7	-17.0	90.3	36.5	90.1	37.6	89.8	38.8	89.7	39.4	89.6	40.0	88.8	40.8
	-13.7	-15.0	94.1	37.2	93.9	38.3	93.7	39.5	93.5	40.0	93.4	40.6	88.8	38.7
	-11.8	-13.0	98.3	38.0	98.1	39.0	97.9	40.1	97.7	40.7	96.9	40.7	88.8	36.7
	-9.8	-11.0	103	38.7	103	39.7	102	40.8	101	40.4	96.9	38.5	88.8	34.7
	-9.5	-10.0	105	39.1	105	40.1	105	41.1	101	39.3	96.9	37.4	88.8	33.7
	-8.5	-9.1	108	39.4	107	40.4	105	40.1	101	38.2	96.9	36.4	88.8	32.9
	-7.0	-7.6	112	40.0	111	40.9	105	38.3	101	36.6	96.9	34.8	88.8	31.5
	-5.0	-5.6	117	40.7	113	39.4	105	36.1	101	34.4	96.9	32.8	88.8	29.7
	-3.0	-3.7	121	40.4	113	37.2	105	34.1	101	32.5	96.9	31.1	88.8	28.1
	0.0	-0.7	121	36.7	113	33.9	105	31.1	101	29.8	96.9	28.4	88.8	25.8
	3.0	2.2	121	33.6	113	31.0	105	28.5	101	27.3	96.9	26.1	88.8	23.8
	5.0	4.1	121	31.7	113	29.3	105	27.0	101	25.8	96.9	24.7	88.8	22.5
	7.0	6.0	121	29.9	113	27.7	105	25.5	101	24.5	96.9	23.4	88.8	21.4
	9.0	7.9	121	28.3	113	26.2	105	24.2	101	23.2	96.9	22.2	88.8	20.3
	11.0	9.8	121	26.8	113	24.9	105	23.0	101	22.0	96.9	21.1	88.8	19.3
13.0	11.8	121	25.3	113	23.5	105	21.7	101	20.9	96.9	20.0	88.8	18.3	
15.0	13.7	121	24.0	113	22.3	105	20.7	101	19.9	96.9	19.0	88.8	17.5	
60% 81.00 kW	-19.8	-20.0	84.8	38.1	84.7	39.1	84.5	40.2	84.4	40.7	83.1	40.3	76.2	36.3
	-18.8	-19.0	86.4	38.4	86.2	39.4	86.0	40.4	85.9	41.0	83.1	39.4	76.2	35.6
	-16.7	-17.0	89.8	39.0	89.6	40.0	89.4	41.0	86.5	39.5	83.1	37.6	76.2	33.9
	-13.7	-15.0	93.6	39.6	93.4	40.6	90.0	39.3	86.5	37.5	83.1	35.7	76.2	32.3
	-11.8	-13.0	97.8	40.3	96.9	40.7	90.0	37.3	86.5	35.6	83.1	33.9	76.2	30.7
	-9.8	-11.0	102	40.9	96.9	38.5	90.0	35.2	86.5	33.7	83.1	32.1	76.2	29.1
	-9.5	-10.0	104	40.6	96.9	37.4	90.0	34.3	86.5	32.7	83.1	31.2	76.2	28.3
	-8.5	-9.1	104	39.5	96.9	36.4	90.0	33.4	86.5	31.9	83.1	30.5	76.2	27.6
	-7.0	-7.6	104	37.8	96.9	34.8	90.0	32.0	86.5	30.6	83.1	29.2	76.2	26.5
	-5.0	-5.6	104	35.6	96.9	32.8	90.0	30.2	86.5	28.9	83.1	27.6	76.2	25.1
	-3.0	-3.7	104	33.6	96.9	31.1	90.0	28.6	86.5	27.3	83.1	26.1	76.2	23.8
	0.0	-0.7	104	30.7	96.9	28.4	90.0	26.2	86.5	25.1	83.1	24.0	76.2	21.9
	3.0	2.2	104	28.2	96.9	26.1	90.0	24.1	86.5	23.1	83.1	22.1	76.2	20.2
	5.0	4.1	104	26.7	96.9	24.7	90.0	22.8	86.5	21.9	83.1	21.0	76.2	19.2
	7.0	6.0	104	25.2	96.9	23.4	90.0	21.7	86.5	20.8	83.1	19.9	76.2	18.3
	9.0	7.9	104	23.9	96.9	22.2	90.0	20.6	86.5	19.8	83.1	19.0	76.2	17.4
	11.0	9.8	104	22.7	96.9	21.1	90.0	19.6	86.5	18.8	83.1	18.0	76.2	16.6
13.0	11.8	104	21.5	96.9	20.0	90.0	18.6	86.5	17.9	83.1	17.1	76.2	15.8	
15.0	13.7	104	20.4	96.9	19.0	90.0	17.7	86.5	17.0	83.1	16.4	76.2	15.1	
50% 67.50 kW	-19.8	-20.0	84.4	40.7	80.8	39.0	75.0	35.7	72.1	34.1	69.2	32.5	63.5	29.4
	-18.8	-19.0	85.9	41.0	80.8	38.1	75.0	34.9	72.1	33.4	69.2	31.8	63.5	28.8
	-16.7	-17.0	86.5	39.5	80.8	36.4	75.0	33.3	72.1	31.9	69.2	30.4	63.5	27.6
	-13.7	-15.0	86.5	37.5	80.8	34.6	75.0	31.7	72.1	30.3	69.2	29.0	63.5	26.3
	-11.8	-13.0	86.5	35.6	80.8	32.8	75.0	30.1	72.1	28.8	69.2	27.6	63.5	25.0
	-9.8	-11.0	86.5	33.7	80.8	31.1	75.0	28.6	72.1	27.4	69.2	26.2	63.5	23.8
	-9.5	-10.0	86.5	32.7	80.8	30.2	75.0	27.8	72.1	26.6	69.2	25.5	63.5	23.2
	-8.5	-9.1	86.5	31.9	80.8	29.5	75.0	27.2	72.1	26.0	69.2	24.9	63.5	22.7
	-7.0	-7.6	86.5	30.6	80.8	28.3	75.0	26.1	72.1	25.0	69.2	23.9	63.5	21.8
	-5.0	-5.6	86.5	28.9	80.8	26.7	75.0	24.7	72.1	23.6	69.2	22.6	63.5	20.7
	-3.0	-3.7	86.5	27.3	80.8	25.3	75.0	23.4	72.1	22.4	69.2	21.5	63.5	19.7
	0.0	-0.7	86.5	25.1	80.8	23.3	75.0	21.5	72.1	20.7	69.2	19.8	63.5	18.2
	3.0	2.2	86.5	23.1	80.8	21.5	75.0	19.9	72.1	19.1	69.2	18.4	63.5	16.8
	5.0	4.1	86.5	21.9										

5 Таблицы производительности

5 - 2 Таблицы теплопроизводительностей

RXYQ50T		Indoor air temp. °CDB												
Combination(%) (Capacity index)	Outdoor air temp.		16.0		18.0		20.0		21.0		22.0		24.0	
	(°CDB)	(°CWB)	TC	PI	TC	PI	TC	PI	TC	PI	TC	PI	TC	PI
			KW	KW	KW	KW	KW	KW	KW	KW	KW	KW	KW	KW
130% 182.00 kW	-19.8	-20.0	91.6	20.2	91.2	22.6	90.8	24.9	90.6	26.1	90.3	27.3	89.9	29.7
	-18.8	-19.0	93.3	20.8	92.8	23.2	92.4	25.5	92.2	26.7	92.0	27.9	91.5	30.2
	-16.7	-17.0	96.8	22.2	96.4	24.5	96.0	26.8	95.8	27.9	95.5	29.0	95.1	31.3
	-13.7	-15.0	100.8	23.7	100.4	25.8	100.0	28.0	99.7	29.1	99.5	30.2	99.1	32.3
	-11.8	-13.0	105.2	25.1	104.8	27.2	104.3	29.3	104.1	30.3	103.9	31.3	103.5	33.4
	-9.8	-11.0	110	26.6	110	28.5	109	30.5	109	31.5	109	32.5	108	34.5
	-9.5	-10.0	113	27.3	112	29.2	112	31.1	111	32.1	111	33.1	111	35.0
	-8.5	-9.1	115	27.9	114	29.8	114	31.7	114	32.6	114	33.6	113	35.4
	-7.0	-7.6	119	29.0	119	30.8	118	32.6	118	33.5	118	34.4	117	36.2
	-5.0	-5.6	125	30.3	124	32.0	124	33.8	124	34.6	124	35.5	123	37.2
	-3.0	-3.7	131	31.6	130	33.2	130	34.8	130	35.7	130	36.5	129	38.1
	0.0	-0.7	141	33.4	141	34.9	140	36.5	140	37.2	140	38.0	139	39.5
	3.0	2.2	152	35.1	151	36.5	151	37.9	151	38.6	150	39.3	150	40.8
	5.0	4.1	159	36.2	159	37.5	158	38.8	158	39.5	158	40.2	157	41.5
	7.0	6.0	167	37.1	166	38.4	166	39.7	166	40.3	166	41.0	165	42.2
	9.0	7.9	175	38.1	175	39.3	174	40.5	174	41.1	174	41.7	172	42.3
	11.0	9.8	184	39.0	183	40.1	183	41.3	183	41.9	182	42.4	172	39.8
13.0	11.8	193	39.8	193	40.9	192	42.0	192	42.6	187	41.6	172	37.5	
15.0	13.7	202	40.6	202	41.7	201	42.7	195	41.2	187	39.2	172	35.4	
120% 168.00 kW	-19.8	-20.0	91.1	22.9	90.7	25.1	90.3	27.3	90.1	28.5	89.9	29.6	89.5	31.8
	-18.8	-19.0	92.8	23.5	92.4	25.7	92.0	27.9	91.8	29.0	91.6	30.1	91.2	32.2
	-16.7	-17.0	96.3	24.8	95.9	26.9	95.5	29.0	95.4	30.1	95.2	31.1	94.8	33.2
	-13.7	-15.0	100.3	26.2	99.9	28.2	99.5	30.2	99.3	31.2	99.1	32.2	98.7	34.2
	-11.8	-13.0	104.7	27.5	104.3	29.4	103.9	31.3	103.7	32.3	103.5	33.2	103.1	35.1
	-9.8	-11.0	109	28.8	109	30.7	109	32.5	108	33.4	108	34.3	108	36.1
	-9.5	-10.0	112	29.5	112	31.3	111	33.1	111	33.9	111	34.8	110	36.6
	-8.5	-9.1	114	30.1	114	31.8	114	33.6	113	34.4	113	35.3	113	37.0
	-7.0	-7.6	119	31.0	118	32.7	118	34.4	118	35.2	117	36.1	117	37.8
	-5.0	-5.6	124	32.3	124	33.9	124	35.5	123	36.3	123	37.1	123	38.7
	-3.0	-3.7	130	33.5	130	35.0	130	36.5	129	37.2	129	38.0	129	39.5
	0.0	-0.7	140	35.2	140	36.6	140	38.0	140	38.7	139	39.4	139	40.8
	3.0	2.2	151	36.7	151	38.0	150	39.3	150	40.0	150	40.6	150	41.9
	5.0	4.1	159	37.7	158	38.9	158	40.2	158	40.8	157	41.4	157	42.7
	7.0	6.0	166	38.6	166	39.8	166	41.0	165	41.6	165	42.2	158	40.7
	9.0	7.9	175	39.5	174	40.6	174	41.7	174	42.3	173	42.6	158	38.4
	11.0	9.8	183	40.3	183	41.4	182	42.4	180	42.2	173	40.2	158	36.2
13.0	11.8	192	41.1	192	42.1	187	41.6	180	39.7	173	37.8	158	34.1	
15.0	13.7	202	41.8	201	42.8	187	39.2	180	37.5	173	35.7	158	32.3	
110% 154.00 kW	-19.8	-20.0	90.6	25.7	90.3	27.7	89.9	29.7	89.7	30.8	89.5	31.8	89.2	33.8
	-18.8	-19.0	92.3	26.3	91.9	28.3	91.5	30.2	91.4	31.2	91.2	32.2	90.8	34.2
	-16.7	-17.0	95.8	27.5	95.5	29.4	95.1	31.3	94.9	32.2	94.8	33.2	94.4	35.1
	-13.7	-15.0	99.8	28.7	99.5	30.5	99.1	32.3	98.9	33.2	98.7	34.2	98.4	36.0
	-11.8	-13.0	104.2	29.9	103.8	31.6	103.5	33.4	103.3	34.3	103.1	35.1	102.8	36.9
	-9.8	-11.0	109	31.1	109	32.8	108	34.5	108	35.3	108	36.1	108	37.8
	-9.5	-10.0	112	31.7	111	33.4	111	35.0	111	35.8	110	36.6	110	38.2
	-8.5	-9.1	114	32.3	114	33.9	113	35.4	113	36.2	113	37.0	112	38.6
	-7.0	-7.6	118	33.1	118	34.7	117	36.2	117	37.0	117	37.8	117	39.3
	-5.0	-5.6	124	34.3	124	35.8	123	37.2	123	37.9	123	38.7	122	40.1
	-3.0	-3.7	130	35.4	130	36.7	129	38.1	129	38.8	129	39.5	128	40.9
	0.0	-0.7	140	36.9	140	38.2	139	39.5	139	40.2	139	40.8	139	42.1
	3.0	2.2	151	38.4	150	39.6	150	40.8	150	41.4	150	41.9	145	41.3
	5.0	4.1	158	39.3	158	40.4	157	41.5	157	42.1	157	42.7	145	39.0
	7.0	6.0	166	40.1	166	41.2	165	42.2	165	42.8	165	43.4	145	36.7
	9.0	7.9	174	40.9	174	41.9	172	42.3	165	40.3	158	38.4	145	34.7
	11.0	9.8	183	41.6	182	42.6	172	39.8	165	38.0	158	36.2	145	32.8
13.0	11.8	192	42.4	185	40.9	172	37.5	165	35.8	158	34.1	145	30.9	
15.0	13.7	198	42.0	185	38.6	172	35.4	165	33.8	158	32.3	145	29.3	
100% 140.00 kW	-19.8	-20.0	90.1	28.5	89.8	30.3	89.5	32.1	89.3	33.1	89.2	34.0	88.8	35.8
	-18.8	-19.0	91.8	29.0	91.4	30.8	91.1	32.6	91.0	33.5	90.8	34.4	90.5	36.2
	-16.7	-17.0	95.4	30.1	95.0	31.8	94.7	33.5	94.5	34.4	94.4	35.3	94.0	37.0
	-13.7	-15.0	99.3	31.2	99.0	32.8	98.7	34.5	98.5	35.3	98.3	36.2	98.0	37.8
	-11.8	-13.0	103.7	32.3	103.4	33.9	103.1	35.5	102.9	36.3	102.7	37.1	102.4	38.7
	-9.8	-11.0	108	33.4	108	34.9	108	36.4	108	37.2	108	38.0	107	39.5
	-9.5	-10.0	111	33.9	111	35.4	110	36.9	110	37.7	110	38.4	110	39.9
	-8.5	-9.1	113	34.4	113	35.9	113	37.3	113	38.1	112	38.8	112	40.2
	-7.0	-7.6	118	35.2	117	36.6	117	38.0	117	38.7	117	39.4	116	40.8
	-5.0	-5.6	123	36.3	123	37.6	123	38.9	123	39.6	122	40.3	122	41.6
	-3.0	-3.7	129	37.2	129	38.5	129	39.8	129	40.4	128	41.0	128	42.3
	0.0	-0.7	140	38.7	139	39.9	139	41.0	139	41.6	139	42.2	132	40.4
	3.0	2.2	150	40.0	150	41.1	150	42.2	149	42.7	144	40.9	132	36.9
	5.0	4.1	158	40.8	157	41.8	156	42.5	150	40.5	144	38.6	132	34.8
	7.0	6.0	165	41.6	165	42.5	156	40.0	150	38.2	144	36.4	132	32.9
	9.0	7.9	174	42.3	168	41.2	156	37.7	150	36.0	144	34.3	132	31.1
	11.0	9.8	180	42.2	168	38.8	156	35.6	150	34.0	144	32.5	132	29.4
13.0	11.8	180	39.7	168	36.6	156	33.5	150	32.1	144	30.6	132	27.8	
15.0	13.7	180	37.5	168	34.6	156	31.7	150	30.4	144	29.0	132	26.4	

NOTES - ANMERKUNGEN - Σημειώσεις - NOTAS - REMARQUES - NOTE - OPMERKINGEN - примечания - NOTLAR

1. [] is shown as reference. When selecting the unit models, avoid the Outdoor air temperature range shown by [].
 dient als Verweis. Vermeiden Sie bei der Auswahl der Gerätemodelle den als markierten Temperaturbereich der Außenluft.
 Η [] είναι ενδεικτική, κατά την επιλογή των μοντέλων των μονάδων, αποφύγετε το εύρος θερμοκρασίας εξωτερικού αέρα που υποδεικνύεται [].
 se muestra como referencia. Cuando seleccione los modelos de unidad, evite el intervalo de temperaturas de aire exterior indicado mediante [].
 est montré comme référence. Lors du choix des modèles d'unités, évitez la plage de températures de l'air extérieur illustré par [].
 valori riportati unicamente come riferimento. Nel selezionare i modelli delle unità, non considerare i valori di temperatura dell'aria esterna indicati con il colore [].
 is als referentie getoond. Wanneer modellen van eenheden worden gekozen, vermijd dan het bereik van buitenluchttemperaturen geïllustreerd door [].

2. The above table shows the average value of conditions which may occur.
 Die obige Tabelle zeigt den Durchschnittswert der Bedingungen, die auftreten können.
 Στον παραπάνω πίνακα αναγράφεται η μέση τιμή για συνθήκες που μπορεί να προκύψουν.
 La tabla de arriba muestra el valor medio de condiciones que pueden ocurrir.
 Le tableau ci-dessus donne la valeur moyenne pour des conditions qui peuvent survenir.
 La tabella in alto mostra il valore delle condizioni medie che si possono riscontrare.
 De tabel hierboven geeft de gemiddelde waarde aan van situaties die kunnen voorvallen.
 Таблица расположенная выше показывает среднее значение условий, которые могут наступить.
 Yukarıdaki tablo meydana gelebilecek koşulların ortalama değerini göstermektedir.

5 Таблицы производительности

5 - 2 Таблицы теплопроизводительностей

5

RXYQ50T														
Indoor air temp. °CDB														
Combination (%) (Capacity index)	Outdoor air temp.		16.0		18.0		20.0		21.0		22.0		24.0	
			TC	PI	TC	PI	TC	PI	TC	PI	TC	PI	TC	PI
	(°CDB)	(°CWB)	KW	KW	KW	KW	KW	KW	KW	KW	KW	KW	KW	KW
90% 126.00 kW	-19.8	-20.0	89.6	31.2	89.4	32.9	89.1	34.5	88.9	35.4	88.8	36.2	88.5	37.9
	-18.8	-19.0	91.3	31.7	91.0	33.3	90.7	35.0	90.5	35.8	90.4	36.6	90.1	38.2
	-16.7	-17.0	94.9	32.7	94.6	34.2	94.3	35.8	94.1	36.6	94.0	37.4	93.7	38.9
	-13.7	-15.0	98.8	33.7	98.5	35.2	98.2	36.7	98.1	37.4	98.0	38.2	97.7	39.7
	-11.8	-13.0	103.2	34.7	102.9	36.1	102.6	37.5	102.5	38.3	102.3	39.0	102.0	40.4
	-9.8	-11.0	108	35.7	108	37.0	107	38.4	107	39.1	107	39.8	107	41.1
	-9.5	-10.0	111	36.2	110	37.5	110	38.8	110	39.5	110	40.2	109	41.5
	-8.5	-9.1	113	36.6	113	37.9	112	39.2	112	39.9	112	40.5	112	41.8
	-7.0	-7.6	117	37.3	117	38.6	116	39.9	116	40.5	116	41.1	116	42.4
	-5.0	-5.6	123	38.3	123	39.5	122	40.7	122	41.3	122	41.9	119	41.4
	-3.0	-3.7	129	39.1	129	40.3	128	41.4	128	42.0	128	42.6	119	39.1
	0.0	-0.7	139	40.4	139	41.5	138	42.6	135	41.5	130	39.5	119	35.7
	3.0	2.2	150	41.6	149	42.6	140	39.7	135	37.9	130	36.1	119	32.7
	5.0	4.1	157	42.3	151	40.9	140	37.4	135	35.8	130	34.1	119	30.9
	7.0	6.0	162	41.9	151	38.5	140	35.3	135	33.8	130	32.2	119	29.2
	9.0	7.9	162	39.4	151	36.4	140	33.4	135	31.9	130	30.5	119	27.6
	11.0	9.8	162	37.2	151	34.3	140	31.5	135	30.2	130	28.8	119	26.2
13.0	11.8	162	35.0	151	32.4	140	29.8	135	28.5	130	27.2	119	24.8	
15.0	13.7	162	33.1	151	30.6	140	28.2	135	27.0	130	25.8	119	23.5	
80% 112.00 kW	-19.8	-20.0	89.2	34.0	88.9	35.5	88.6	36.9	88.5	37.7	88.4	38.4	88.1	39.9
	-18.8	-19.0	90.8	34.4	90.5	35.9	90.3	37.3	90.1	38.0	90.0	38.8	89.7	40.2
	-16.7	-17.0	94.4	35.3	94.1	36.7	93.8	38.1	93.7	38.8	93.6	39.4	93.3	40.8
	-13.7	-15.0	98.3	36.2	98.1	37.5	97.8	38.8	97.7	39.5	97.6	40.2	97.3	41.5
	-11.8	-13.0	102.7	37.1	102.5	38.3	102.2	39.6	102.1	40.2	101.9	40.9	101.7	42.2
	-9.8	-11.0	108	38.0	107	39.2	107	40.4	107	41.0	107	41.6	106	42.3
	-9.5	-10.0	110	38.4	110	39.6	110	40.8	109	41.4	109	42.0	106	41.1
	-8.5	-9.1	112	38.8	112	39.9	112	41.1	112	41.7	112	42.3	106	40.0
	-7.0	-7.6	117	39.4	116	40.6	116	41.7	116	42.2	115	42.5	106	38.3
	-5.0	-5.6	122	40.3	122	41.3	122	42.4	120	42.0	115	39.9	106	36.0
	-3.0	-3.7	128	41.0	128	42.1	125	41.5	120	39.6	115	37.7	106	34.1
	0.0	-0.7	139	42.2	134	41.3	125	37.8	120	36.1	115	34.4	106	31.2
	3.0	2.2	144	40.9	134	37.7	125	34.6	120	33.1	115	31.5	106	28.6
	5.0	4.1	144	38.6	134	35.6	125	32.7	120	31.2	115	29.8	106	27.1
	7.0	6.0	144	36.4	134	33.6	125	30.9	120	29.5	115	28.2	106	25.7
	9.0	7.9	144	34.3	134	31.7	125	29.2	120	28.0	115	26.7	106	24.3
	11.0	9.8	144	32.5	134	30.0	125	27.6	120	26.5	115	25.3	106	23.1
13.0	11.8	144	30.6	134	28.4	125	26.1	120	25.1	115	24.0	106	21.9	
15.0	13.7	144	29.0	134	26.9	125	24.8	120	23.8	115	22.8	106	20.8	
70% 98.00 kW	-19.8	-20.0	88.7	36.8	88.4	38.0	88.2	39.3	88.1	40.0	88.0	40.6	87.7	41.9
	-18.8	-19.0	90.3	37.1	90.1	38.4	89.8	39.7	89.7	40.3	89.6	40.9	89.4	42.2
	-16.7	-17.0	93.9	37.9	93.6	39.1	93.4	40.3	93.3	40.9	93.2	41.5	92.4	42.4
	-13.7	-15.0	97.9	38.7	97.6	39.8	97.4	41.0	97.3	41.6	97.2	42.2	92.4	40.2
	-11.8	-13.0	102.2	39.4	102.0	40.6	101.8	41.7	101.7	42.2	100.8	42.3	92.4	38.1
	-9.8	-11.0	107	40.2	107	41.3	107	42.4	105	42.0	100.8	40.0	92.4	36.1
	-9.5	-10.0	110	40.6	109	41.7	109	42.7	105	40.8	100.8	38.8	92.4	35.1
	-8.5	-9.1	112	41.0	112	42.0	109	41.6	105	39.7	100.8	37.8	92.4	34.2
	-7.0	-7.6	116	41.5	116	42.5	109	39.8	105	38.0	100.8	36.2	92.4	32.7
	-5.0	-5.6	122	42.3	118	40.9	109	37.5	105	35.8	100.8	34.1	92.4	30.9
	-3.0	-3.7	126	42.0	118	38.6	109	35.4	105	33.8	100.8	32.3	92.4	29.3
	0.0	-0.7	126	38.2	118	35.2	109	32.4	105	31.0	100.8	29.6	92.4	26.9
	3.0	2.2	126	35.0	118	32.3	109	29.7	105	28.4	100.8	27.2	92.4	24.7
	5.0	4.1	126	33.0	118	30.5	109	28.1	105	26.9	100.8	25.7	92.4	23.5
	7.0	6.0	126	31.2	118	28.9	109	26.6	105	25.5	100.8	24.4	92.4	22.3
	9.0	7.9	126	29.5	118	27.3	109	25.2	105	24.2	100.8	23.2	92.4	21.2
	11.0	9.8	126	27.9	118	25.9	109	23.9	105	23.0	100.8	22.0	92.4	20.1
13.0	11.8	126	26.4	118	24.5	109	22.7	105	21.8	100.8	20.9	92.4	19.1	
15.0	13.7	126	25.1	118	23.3	109	21.6	105	20.7	100.8	19.9	92.4	18.2	
60% 84.00 kW	-19.8	-20.0	88.2	39.5	88.0	40.6	87.8	41.7	87.7	42.3	86.4	41.9	79.2	37.8
	-18.8	-19.0	89.8	39.8	89.6	40.9	89.4	42.0	89.3	42.6	86.4	41.0	79.2	37.0
	-16.7	-17.0	93.4	40.5	93.2	41.5	93.0	42.6	90.0	41.0	86.4	39.1	79.2	35.3
	-13.7	-15.0	97.4	41.2	97.2	42.2	93.6	40.9	90.0	39.0	86.4	37.1	79.2	33.6
	-11.8	-13.0	101.7	41.8	100.8	42.3	93.6	38.7	90.0	37.0	86.4	35.2	79.2	31.9
	-9.8	-11.0	107	42.5	100.8	40.0	93.6	36.6	90.0	35.0	86.4	33.4	79.2	30.2
	-9.5	-10.0	108	42.2	100.8	38.8	93.6	35.6	90.0	34.0	86.4	32.5	79.2	29.4
	-8.5	-9.1	108	41.1	100.8	37.8	93.6	34.7	90.0	33.2	86.4	31.6	79.2	28.7
	-7.0	-7.6	108	39.3	100.8	36.2	93.6	33.2	90.0	31.8	86.4	30.3	79.2	27.5
	-5.0	-5.6	108	37.0	100.8	34.1	93.6	31.4	90.0	30.0	86.4	28.7	79.2	26.1
	-3.0	-3.7	108	35.0	100.8	32.3	93.6	29.7	90.0	28.4	86.4	27.2	79.2	24.7
	0.0	-0.7	108	32.0	100.8	29.6	93.6	27.2	90.0	26.1	86.4	25.0	79.2	22.8
	3.0	2.2	108	29.3	100.8	27.2	93.6	25.1	90.0	24.0	86.4	23.0	79.2	21.0
	5.0	4.1	108	27.8	100.8	25.7	93.6	23.8	90.0	22.8	86.4	21.9	79.2	20.0
	7.0	6.0	108	26.3	100.8	24.4	93.6	22.6	90.0	21.7	86.4	20.8	79.2	19.0
	9.0	7.9	108	24.9	100.8	23.2	93.6	21.4	90.0	20.6	86.4	19.8	79.2	18.1
	11.0	9.8	108	23.7	100.8	22.0	93.6	20.4	90.0	19.6	86.4	18.8	79.2	17.3
13.0	11.8	108	22.4	100.8	20.9	93.6	19.4	90.0	18.6	86.4	17.9	79.2	16.4	
15.0	13.7	108	21.3	100.8	19.9	93.6	18.5	90.0	17.8	86.4	17.1	79.2	15.7	
50% 70.00 kW	-19.8	-20.0	87.7	42.3	84.0	40.5	78.0	37.1	75.0	35.5	72.0	33.8	66.0	30.6
	-18.8	-19.0	89.3	42.6	84.0	39.6	78.0	36.3	75.0	34.7	72.0	33.1	66.0	30.0
	-16.7	-17.0	90.0	41.0	84.0	37.8	78.0	34.7	75.0	33.1	72.0	31.6	66.0	28.7
	-13.7	-15.0	90.0	39.0	84.0	35.9	78.0	33.0	75.0	31.5	72.0	30.1	66.0	27.3
	-11.8	-13.0	90.0	37.0	84.0	34.1	78.0	31.3	75.0	30.0	72.0	28.6	66.0	26.0
	-9.8	-11.0	90.0	35.0	84.0	32.3	78.0	29.7	75.0	28.4	72.0	27.2	66.0	24.7
	-9.5	-10.0	90.0	34.0	84.0	31.4	78.0	28.9	75.0	27.7	72.0	26.5	66.0	24.1
	-8.5	-9.1	90.0	33.2	84.0	30.7	78.0	28.2	75.0	27.0	72.0	25.9	66.0	23.6
	-7.0	-7.6	90.0	31.8	84.0	29.4	78.0	27.1	75.0	26.0	72.0	24.8	66.0	22.6
	-5.0	-5.6	90.0	30.0	84.0	27.8	78.0	25.6	75.0	24.6	72.0	23.5	66.0	21.5
	-3.0	-3.7	90.0	28.4	84.0	26.3	78.0	24.3	75.0	23.3	72.0	22.4	66.0	20.4
	0.0	-0.7	90.0	26.1	84.0	24.2	78.0	22.4	75.0	21.5	72.0	20.6	66.0	18.9
	3.0	2.2	90.0	24.0	84.0	22.4	78.0	20.7	75.0	19.9	72.0	19.1	66.0	17.5

5 Таблицы производительности

5 - 2 Таблицы теплопроизводительностей

RXYQ52T		Indoor air temp. °CDB												
Combination(%) (Capacity index)	Outdoor air temp.		16.0		18.0		20.0		21.0		22.0		24.0	
	(°CDB)	(°CWB)	TC	PI	TC	PI	TC	PI	TC	PI	TC	PI	TC	PI
130% 188.50 kW	-19.8	-20.0	95.0	20.8	94.5	23.3	94.1	25.8	93.9	27.1	93.6	28.3	93.2	30.8
	-18.8	-19.0	96.7	21.5	96.2	24.0	95.8	26.4	95.6	27.6	95.3	28.9	94.9	31.3
	-16.7	-17.0	100.4	23.0	99.9	25.3	99.5	27.7	99.3	28.9	99.0	30.0	98.6	32.4
	-13.7	-15.0	104.5	24.5	104.0	26.7	103.6	29.0	103.4	30.1	103.2	31.2	102.7	33.5
	-11.8	-13.0	109.0	26.0	108.6	28.1	108.1	30.3	107.9	31.4	107.7	32.4	107.3	34.6
	-9.8	-11.0	114	27.5	114	29.5	113	31.6	113	32.6	113	33.6	112	35.7
	-9.5	-10.0	117	28.2	116	30.2	116	32.2	116	33.2	115	34.2	115	36.2
	-8.5	-9.1	119	28.9	119	30.8	118	32.8	118	33.8	118	34.8	117	36.7
	-7.0	-7.6	123	30.0	123	31.9	122	33.8	122	34.7	122	35.6	122	37.5
	-5.0	-5.6	129	31.4	129	33.2	129	35.0	128	35.9	128	36.8	128	38.6
	-3.0	-3.7	136	32.7	135	34.4	135	36.1	135	37.0	134	37.8	134	39.5
	0.0	-0.7	146	34.6	146	36.2	145	37.8	145	38.6	145	39.4	144	41.0
	3.0	2.2	157	36.4	157	37.8	156	39.3	156	40.0	156	40.8	155	42.2
	5.0	4.1	165	37.5	164	38.9	164	40.3	164	41.0	164	41.6	163	43.0
	7.0	6.0	173	38.5	173	39.8	172	41.1	172	41.8	172	42.5	171	43.8
	9.0	7.9	181	39.5	181	40.7	181	42.0	180	42.6	180	43.3	178	44.0
11.0	9.8	190	40.4	190	41.6	189	42.8	189	43.4	189	44.0	178	44.4	
13.0	11.8	200	41.3	200	42.4	199	43.6	199	44.2	194	43.2	178	39.0	
15.0	13.7	210	42.1	209	43.2	209	44.3	203	42.9	194	40.8	178	36.8	
120% 174.00 kW	-19.8	-20.0	94.5	23.7	94.0	26.0	93.6	28.3	93.4	29.5	93.2	30.6	92.8	32.9
	-18.8	-19.0	96.1	24.4	95.7	26.6	95.3	28.9	95.1	30.0	94.9	31.1	94.5	33.4
	-16.7	-17.0	99.9	25.7	99.4	27.9	99.0	30.0	98.8	31.1	98.6	32.2	98.2	34.4
	-13.7	-15.0	104.0	27.1	103.6	29.2	103.2	31.2	103.0	32.3	102.7	33.3	102.3	35.4
	-11.8	-13.0	108.5	28.5	108.1	30.5	107.7	32.4	107.5	33.4	107.3	34.4	106.9	36.4
	-9.8	-11.0	113	29.9	113	31.7	113	33.6	112	34.6	112	35.5	112	37.4
	-9.5	-10.0	116	30.5	116	32.4	115	34.2	115	35.2	115	36.1	114	37.9
	-8.5	-9.1	119	31.1	118	33.0	118	34.8	118	35.7	117	36.6	117	38.4
	-7.0	-7.6	123	32.2	122	33.9	122	35.6	122	36.5	122	37.4	121	39.1
	-5.0	-5.6	129	33.5	129	35.1	128	36.8	128	37.6	128	38.4	127	40.1
	-3.0	-3.7	135	34.7	135	36.2	134	37.8	134	38.6	134	39.4	133	41.0
	0.0	-0.7	146	36.5	145	37.9	145	39.4	145	40.1	144	40.8	144	42.3
	3.0	2.2	157	38.1	156	39.4	156	40.8	156	41.5	155	42.1	155	43.5
	5.0	4.1	164	39.1	164	40.4	164	41.6	163	42.3	163	42.9	163	44.2
	7.0	6.0	172	40.0	172	41.2	172	42.5	171	43.1	171	43.7	164	42.4
	9.0	7.9	181	40.9	181	42.1	180	43.3	180	43.8	179	44.3	164	39.9
11.0	9.8	190	41.8	189	42.9	189	44.0	187	43.9	179	41.8	164	37.7	
13.0	11.8	199	42.6	199	43.7	194	43.2	187	41.3	179	39.3	164	35.5	
15.0	13.7	209	43.4	209	44.4	194	40.8	187	39.0	179	37.1	164	33.6	
110% 159.50 kW	-19.8	-20.0	93.9	26.6	93.6	28.7	93.2	30.8	93.0	31.9	92.8	32.9	92.4	35.0
	-18.8	-19.0	95.6	27.2	95.3	29.2	94.9	31.3	94.7	32.4	94.5	33.4	94.1	35.5
	-16.7	-17.0	99.3	28.4	99.0	30.4	98.6	32.4	98.4	33.4	98.2	34.4	97.8	36.4
	-13.7	-15.0	103.5	29.7	103.1	31.6	102.7	33.5	102.5	34.4	102.3	35.4	102.0	37.3
	-11.8	-13.0	108.0	31.0	107.6	32.8	107.3	34.6	107.1	35.5	106.9	36.4	106.5	38.2
	-9.8	-11.0	113	32.2	113	34.0	112	35.7	112	36.6	112	37.4	111	39.2
	-9.5	-10.0	116	32.9	115	34.5	115	36.2	115	37.1	114	37.9	114	39.6
	-8.5	-9.1	118	33.4	118	35.1	117	36.7	117	37.6	117	38.4	117	40.1
	-7.0	-7.6	122	34.3	122	35.9	122	37.5	121	38.3	121	39.1	121	40.7
	-5.0	-5.6	128	35.5	128	37.0	128	38.6	127	39.3	127	40.1	127	41.6
	-3.0	-3.7	135	36.6	134	38.1	134	39.5	134	40.2	133	41.0	133	42.4
	0.0	-0.7	145	38.3	145	39.6	144	41.0	144	41.6	144	42.3	144	43.6
	3.0	2.2	156	39.8	156	41.0	155	42.2	155	42.9	155	43.5	151	43.0
	5.0	4.1	164	40.7	163	41.9	163	43.0	163	43.6	163	44.2	151	40.5
	7.0	6.0	172	41.6	172	42.7	171	43.8	171	44.4	164	42.4	151	38.2
	9.0	7.9	180	42.4	180	43.5	178	44.0	171	41.9	164	39.9	151	36.1
11.0	9.8	189	43.2	189	44.2	178	41.4	171	39.5	164	37.7	151	34.1	
13.0	11.8	199	43.9	192	42.6	178	39.0	171	37.2	164	35.5	151	32.1	
15.0	13.7	206	43.7	192	40.2	178	36.8	171	35.2	164	33.6	151	30.5	
100% 145.00 kW	-19.8	-20.0	93.4	29.5	93.1	31.4	92.7	33.3	92.6	34.2	92.4	35.2	92.1	37.1
	-18.8	-19.0	95.1	30.0	94.8	31.9	94.4	33.8	94.3	34.7	94.1	35.6	93.8	37.5
	-16.7	-17.0	98.8	31.1	98.5	32.9	98.1	34.7	98.0	35.6	97.8	36.5	97.5	38.4
	-13.7	-15.0	103.0	32.3	102.6	34.0	102.3	35.7	102.1	36.6	101.9	37.5	101.6	39.2
	-11.8	-13.0	107.5	33.4	107.2	35.1	106.8	36.7	106.6	37.6	106.5	38.4	106.1	40.1
	-9.8	-11.0	112	34.6	112	36.2	112	37.8	112	38.5	111	39.3	111	40.9
	-9.5	-10.0	115	35.2	115	36.7	114	38.2	114	39.0	114	39.8	114	41.3
	-8.5	-9.1	118	35.7	117	37.2	117	38.7	117	39.4	117	40.2	116	41.7
	-7.0	-7.6	122	36.5	121	38.0	121	39.4	121	40.1	121	40.9	120	42.3
	-5.0	-5.6	128	37.6	128	39.0	127	40.4	127	41.1	127	41.7	127	43.1
	-3.0	-3.7	134	38.6	134	39.9	133	41.2	133	41.9	133	42.6	133	43.9
	0.0	-0.7	145	40.1	144	41.3	144	42.5	144	43.1	144	43.8	137	42.0
	3.0	2.2	156	41.5	155	42.6	155	43.7	155	44.3	150	42.6	137	38.4
	5.0	4.1	163	42.3	163	43.4	162	44.2	156	42.1	150	40.1	137	36.2
	7.0	6.0	171	43.1	171	44.1	162	41.6	156	39.7	150	37.8	137	34.2
	9.0	7.9	180	43.8	174	42.8	162	39.2	156	37.5	150	35.7	137	32.3
11.0	9.8	187	43.9	174	40.4	162	37.0	156	35.4	150	33.8	137	30.6	
13.0	11.8	187	41.3	174	38.0	162	34.9	156	33.4	150	31.9	137	28.9	
15.0	13.7	187	39.0	174	35.9	162	33.0	156	31.6	150	30.2	137	27.4	

NOTES - ANMERKUNGEN - Σημειώσεις - NOTAS - REMARQUES - NOTE - OPMERKINGEN - примечания - NOTLAR

1. [] is shown as reference. When selecting the unit models, avoid the Outdoor air temperature range shown by [].
 dient als Verweis. Vermeiden Sie bei der Auswahl der Gerätemodelle den als markierten Temperaturbereich der Außenluft.
 Η [] είναι ενδεικτική, κατά την επιλογή των μοντέλων των μονάδων, αποφεύγετε το εύρος θερμοκρασίας εξωτερικού αέρα που υποδεικνύεται [].
 se muestra como referencia. Cuando seleccione los modelos de unidad, evite el intervalo de temperaturas del aire exterior indicado mediante [].
 est montré comme référence. Lors du choix des modèles d'unités, évitez la plage de températures de l'air extérieur illustré par [].
 valori riportati unicamente come riferimento. Nel selezionare i modelli delle unità, non considerare i valori di temperatura dell'aria esterna indicati con il colore [].
 is als referentie getoond. Wanneer modellen van eenheden worden gekozen, vermijd dan het bereik van buitenluchttemperaturen geïllustreerd door [].

2. The above table shows the average value of conditions which may occur.
 Die obige Tabelle zeigt den Durchschnittswert der Bedingungen, die auftreten können.
 Στον παραπάνω πίνακα αναγράφεται η μέση τιμή για συνθήκες που μπορεί να προκύψουν.
 La tabla de arriba muestra el valor medio de condiciones que pueden ocurrir.
 Le tableau ci-dessus donne la valeur moyenne pour des conditions qui peuvent survenir.
 La tabella in alto mostra il valore delle condizioni medie che si possono riscontrare.
 De tabel hierboven geeft de gemiddelde waarde aan van situaties die kunnen voorvallen.
 Таблица расположенная выше показывает среднее значение условий, которые могут наступить.
 Yukarıdaki tablo meydana gelebilecek koşulların ortalama değerini göstermektedir.

5 Таблицы производительности

5 - 2 Таблицы теплопроизводительностей

5

RXYQ52T														
Indoor air temp. °CDB														
Combination (%) (Capacity index)	Outdoor air temp.		16.0		18.0		20.0		21.0		22.0		24.0	
			TC	PI	TC	PI	TC	PI	TC	PI	TC	PI	TC	PI
	(°CDB)	(°CWB)	KW	KW	KW	KW	KW	KW	KW	KW	KW	KW	KW	KW
90% 130.50 kW	-19.8	-20.0	92.9	32.3	92.6	34.1	92.3	35.8	92.1	36.6	92.0	37.5	91.7	39.2
	-18.8	-19.0	94.6	32.8	94.3	34.5	94.0	36.2	93.8	37.1	93.7	37.9	93.4	39.6
	-16.7	-17.0	98.3	33.8	98.0	35.5	97.7	37.1	97.6	37.9	97.4	38.7	97.1	40.3
	-13.7	-15.0	102.4	34.9	102.1	36.4	101.8	38.0	101.7	38.8	101.5	39.6	101.2	41.1
	-11.8	-13.0	107.0	35.9	106.7	37.4	106.4	38.9	106.2	39.6	106.1	40.4	105.8	41.9
	-9.8	-11.0	112	37.0	112	38.4	111	39.8	111	40.5	111	41.2	111	42.7
	-9.5	-10.0	115	37.5	114	38.9	114	40.3	114	40.9	114	41.6	113	43.0
	-8.5	-9.1	117	37.9	117	39.3	116	40.7	116	41.3	116	42.0	116	43.4
	-7.0	-7.6	121	38.7	121	40.0	121	41.3	121	42.0	120	42.6	120	43.9
	-5.0	-5.6	127	39.7	127	40.9	127	42.2	127	42.8	126	43.4	123	43.1
	-3.0	-3.7	134	40.6	133	41.8	133	42.9	133	43.5	133	44.1	123	40.7
	0.0	-0.7	144	41.9	144	43.0	143	44.1	140	43.2	135	41.1	123	37.1
	3.0	2.2	155	43.2	155	44.2	146	41.3	140	39.4	135	37.6	123	34.0
	5.0	4.1	163	43.9	157	42.5	146	38.9	140	37.2	135	35.5	123	32.1
	7.0	6.0	168	43.5	157	40.1	146	36.7	140	35.1	135	33.5	123	30.4
	9.0	7.9	168	41.0	157	37.8	146	34.7	140	33.2	135	31.7	123	28.8
	11.0	9.8	168	38.7	157	35.7	146	32.8	140	31.4	135	30.0	123	27.2
13.0	11.8	168	36.4	157	33.7	146	31.0	140	29.6	135	28.3	123	25.8	
15.0	13.7	168	34.5	157	31.9	146	29.3	140	28.1	135	26.9	123	24.5	
80% 116.00 kW	-19.8	-20.0	92.4	35.2	92.1	36.7	91.9	38.3	91.7	39.0	91.6	39.8	91.3	41.3
	-18.8	-19.0	94.1	35.6	93.8	37.2	93.6	38.7	93.4	39.4	93.3	40.2	93.0	41.7
	-16.7	-17.0	97.8	36.5	97.5	38.0	97.3	39.4	97.1	40.2	97.0	40.9	96.7	42.3
	-13.7	-15.0	101.9	37.5	101.7	38.9	101.4	40.2	101.2	40.9	101.1	41.6	100.8	43.0
	-11.8	-13.0	106.5	38.4	106.2	39.7	105.9	41.1	105.8	41.7	105.7	42.4	105.4	43.7
	-9.8	-11.0	111	39.3	111	40.6	111	41.9	111	42.5	111	43.1	110	44.0
	-9.5	-10.0	114	39.8	114	41.0	114	42.3	113	42.9	113	43.5	110	42.7
	-8.5	-9.1	117	40.2	116	41.4	116	42.6	116	43.2	116	43.8	110	41.6
	-7.0	-7.6	121	40.9	121	42.0	120	43.2	120	43.8	120	44.2	110	39.8
	-5.0	-5.6	127	41.7	127	42.9	126	44.0	125	43.6	120	41.5	110	37.5
	-3.0	-3.7	133	42.6	133	43.6	130	43.1	125	41.2	120	39.2	110	35.4
	0.0	-0.7	144	43.8	140	42.9	130	39.3	125	37.5	120	35.8	110	32.4
	3.0	2.2	150	42.6	140	39.2	130	36.0	125	34.4	120	32.8	110	29.8
	5.0	4.1	150	40.1	140	37.0	130	34.0	125	32.5	120	31.0	110	28.2
	7.0	6.0	150	37.8	140	34.9	130	32.1	125	30.7	120	29.3	110	26.7
	9.0	7.9	150	35.7	140	33.0	130	30.4	125	29.1	120	27.8	110	25.3
	11.0	9.8	150	33.8	140	31.2	130	28.8	125	27.5	120	26.4	110	24.0
13.0	11.8	150	31.9	140	29.5	130	27.2	125	26.1	120	24.9	110	22.8	
15.0	13.7	150	30.2	140	28.0	130	25.8	125	24.7	120	23.7	110	21.7	
70% 101.50 kW	-19.8	-20.0	91.9	38.1	91.7	39.4	91.4	40.8	91.3	41.4	91.2	42.1	90.9	43.5
	-18.8	-19.0	93.6	38.5	93.4	39.8	93.1	41.1	93.0	41.8	92.9	42.4	92.6	43.7
	-16.7	-17.0	97.3	39.3	97.1	40.5	96.8	41.8	96.7	42.4	96.6	43.1	96.0	44.0
	-13.7	-15.0	101.4	40.1	101.2	41.3	100.9	42.5	100.8	43.1	100.7	43.7	96.0	41.8
	-11.8	-13.0	106.0	40.9	105.7	42.0	105.5	43.2	105.4	43.8	104.7	44.0	96.0	39.6
	-9.8	-11.0	111	41.7	111	42.8	110	43.9	109	43.7	104.7	41.6	96.0	37.5
	-9.5	-10.0	114	42.1	113	43.2	113	44.3	109	42.4	104.7	40.4	96.0	36.5
	-8.5	-9.1	116	42.5	116	43.5	113	43.3	109	41.3	104.7	39.4	96.0	35.5
	-7.0	-7.6	120	43.1	120	44.1	113	41.4	109	39.5	104.7	37.7	96.0	34.1
	-5.0	-5.6	126	43.8	122	42.6	113	39.0	109	37.2	104.7	35.5	96.0	32.1
	-3.0	-3.7	131	43.6	122	40.2	113	36.8	109	35.2	104.7	33.6	96.0	30.4
	0.0	-0.7	131	39.7	122	36.7	113	33.7	109	32.2	104.7	30.7	96.0	27.9
	3.0	2.2	131	36.4	122	33.6	113	30.9	109	29.6	104.7	28.3	96.0	25.7
	5.0	4.1	131	34.3	122	31.7	113	29.2	109	28.0	104.7	26.8	96.0	24.4
	7.0	6.0	131	32.4	122	30.0	113	27.7	109	26.5	104.7	25.4	96.0	23.2
	9.0	7.9	131	30.7	122	28.4	113	26.2	109	25.2	104.7	24.1	96.0	22.0
	11.0	9.8	131	29.1	122	26.9	113	24.9	109	23.9	104.7	22.9	96.0	20.9
13.0	11.8	131	27.5	122	25.5	113	23.6	109	22.6	104.7	21.7	96.0	19.9	
15.0	13.7	131	26.1	122	24.2	113	22.4	109	21.5	104.7	20.7	96.0	18.9	
60% 87.00 kW	-19.8	-20.0	91.4	41.0	91.2	42.1	91.0	43.3	90.9	43.8	89.7	43.6	82.2	39.3
	-18.8	-19.0	93.1	41.3	92.9	42.4	92.7	43.6	92.6	44.1	89.7	42.6	82.2	38.4
	-16.7	-17.0	96.8	42.0	96.6	43.1	96.4	44.1	93.5	42.7	89.7	40.6	82.2	36.7
	-13.7	-15.0	100.9	42.7	100.7	43.7	97.2	42.5	93.5	40.5	89.7	38.6	82.2	34.9
	-11.8	-13.0	105.4	43.4	104.7	44.0	97.2	40.3	93.5	38.4	89.7	36.6	82.2	33.1
	-9.8	-11.0	110	44.1	104.7	41.6	97.2	38.1	93.5	36.4	89.7	34.7	82.2	31.4
	-9.5	-10.0	112	43.9	104.7	40.4	97.2	37.0	93.5	35.4	89.7	33.8	82.2	30.6
	-8.5	-9.1	112	42.7	104.7	39.4	97.2	36.1	93.5	34.5	89.7	32.9	82.2	29.8
	-7.0	-7.6	112	40.9	104.7	37.7	97.2	34.6	93.5	33.0	89.7	31.6	82.2	28.6
	-5.0	-5.6	112	38.5	104.7	35.5	97.2	32.6	93.5	31.2	89.7	29.8	82.2	27.1
	-3.0	-3.7	112	36.4	104.7	33.6	97.2	30.9	93.5	29.6	89.7	28.3	82.2	25.7
	0.0	-0.7	112	33.2	104.7	30.7	97.2	28.3	93.5	27.1	89.7	26.0	82.2	23.7
	3.0	2.2	112	30.5	104.7	28.3	97.2	26.1	93.5	25.0	89.7	24.0	82.2	21.9
	5.0	4.1	112	28.9	104.7	26.8	97.2	24.7	93.5	23.7	89.7	22.7	82.2	20.8
	7.0	6.0	112	27.3	104.7	25.4	97.2	23.5	93.5	22.5	89.7	21.6	82.2	19.8
	9.0	7.9	112	25.9	104.7	24.1	97.2	22.3	93.5	21.4	89.7	20.6	82.2	18.8
	11.0	9.8	112	24.6	104.7	22.9	97.2	21.2	93.5	20.4	89.7	19.6	82.2	18.0
13.0	11.8	112	23.3	104.7	21.7	97.2	20.1	93.5	19.4	89.7	18.6	82.2	17.1	
15.0	13.7	112	22.2	104.7	20.7	97.2	19.2	93.5	18.5	89.7	17.7	82.2	16.3	
50% 72.50 kW	-19.8	-20.0	90.9	43.8	87.2	42.2	81.0	38.6	77.9	36.9	74.8	35.2	68.5	31.8
	-18.8	-19.0	92.6	44.1	87.2	41.2	81.0	37.8	77.9	36.1	74.8	34.4	68.5	31.2
	-16.7	-17.0	93.5	42.7	87.2	39.3	81.0	36.0	77.9	34.4	74.8	32.9	68.5	29.8
	-13.7	-15.0	93.5	40.5	87.2	37.4	81.0	34.3	77.9	32.8	74.8	31.3	68.5	28.4
	-11.8	-13.0	93.5	38.4	87.2	35.5	81.0	32.6	77.9	31.2	74.8	29.8	68.5	27.1
	-9.8	-11.0	93.5	36.4	87.2	33.6	81.0	30.9	77.9	29.6	74.8	28.3	68.5	25.7
	-9.5	-10.0	93.5	35.4	87.2	32.7	81.0	30.1	77.9	28.8	74.8	27.5	68.5	25.1
	-8.5	-9.1	93.5	34.5	87.2	31.9	81.0	29.3	77.9	28.1	74.8	26.9	68.5	24.5
	-7.0	-7.6	93.5	33.0	87.2	30.6	81.0	28.2	77.9	27.0	74.8	25.8	68.5	23.6
	-5.0	-5.6	93.5	31.2	87.2	28.9	81.0	26.7	77.9	25.6	74.8	24.5	68.5	22.3
	-3.0	-3.7	93.5	29.6	87.2	27.4	81.0	25.3	77.9	24.3	74.8	23.2	68.5	21.3
	0.0	-0.7	93.5	27.1	87.2	25.2	81.0	23.3	77.9	22.4	74.8	21.5	68.5	19.7
	3.0	2.2	93.5	25.0	87.2	23.3	81.0	21.5	77.9	20.7	74.8	19.9		

5 Таблицы производительности

5 - 2 Таблицы теплопроизводительностей

RXYQ54T		Indoor air temp. °CDB												TC: Total capacity (kW); PI: Power Input (kW) (Comp. + Outdoor fan motor)	
Combination(%) (Capacity index)	Outdoor air temp.		16.0		18.0		20.0		21.0		22.0		24.0		
	(°CDB)	(°CWB)	TC KW	PI KW	TC KW	PI KW	TC KW	PI KW	TC KW	PI KW	TC KW	PI KW	TC KW	PI KW	
130% 195.00 kW	-19.8	-20.0	98.3	21.5	97.8	24.1	97.4	26.7	97.2	28.0	96.9	29.3	96.5	31.8	
	-18.8	-19.0	100.1	22.2	99.6	24.8	99.1	27.3	98.9	28.6	98.7	29.8	98.2	32.4	
	-16.7	-17.0	103.9	23.7	103.4	26.2	103.0	28.6	102.8	29.8	102.5	31.1	102.1	33.5	
	-13.7	-15.0	108.2	25.3	107.7	27.6	107.2	30.0	107.0	31.1	106.8	32.3	106.3	34.6	
	-11.8	-13.0	112.9	26.9	112.4	29.1	111.9	31.3	111.7	32.4	111.5	33.6	111.0	35.8	
	-9.8	-11.0	118	28.4	118	30.5	117	32.7	117	33.7	117	34.8	116	36.9	
	-9.5	-10.0	121	29.2	120	31.3	120	33.3	120	34.4	119	35.4	119	37.5	
	-8.5	-9.1	123	29.9	123	31.9	122	33.9	122	35.0	122	36.0	121	38.0	
	-7.0	-7.6	128	31.0	127	33.0	127	34.9	127	35.9	126	36.9	126	38.8	
	-5.0	-5.6	134	32.5	134	34.3	133	36.2	133	37.1	133	38.1	132	39.9	
	-3.0	-3.7	140	33.8	140	35.6	139	37.4	139	38.2	139	39.1	139	40.9	
	0.0	-0.7	151	35.8	151	37.5	150	39.1	150	39.9	150	40.8	149	42.4	
	3.0	2.2	163	37.6	162	39.2	162	40.7	162	41.5	161	42.2	161	43.7	
	5.0	4.1	171	38.8	170	40.2	170	41.7	170	42.4	169	43.1	169	44.6	
	7.0	6.0	179	39.8	179	41.2	178	42.6	178	43.3	178	44.0	177	45.4	
	9.0	7.9	188	40.8	187	42.2	187	43.5	187	44.1	186	44.8	185	45.6	
11.0	9.8	197	41.8	197	43.1	196	44.3	196	44.9	196	45.6	195	46.0		
13.0	11.8	207	42.8	207	43.9	206	45.1	206	45.7	202	44.9	185	40.5		
15.0	13.7	217	43.6	217	44.7	216	45.9	210	44.5	202	42.4	185	38.3		
120% 180.00 kW	-19.8	-20.0	97.8	24.5	97.4	26.9	96.9	29.3	96.7	30.5	96.5	31.7	96.1	34.0	
	-18.8	-19.0	99.5	25.2	99.1	27.5	98.7	29.8	98.5	31.0	98.3	32.2	97.8	34.5	
	-16.7	-17.0	103.4	26.6	102.9	28.8	102.5	31.1	102.3	32.2	102.1	33.3	101.7	35.6	
	-13.7	-15.0	107.6	28.0	107.2	30.1	106.8	32.3	106.6	33.4	106.4	34.5	105.9	36.6	
	-11.8	-13.0	112.3	29.4	111.9	31.5	111.5	33.6	111.3	34.6	111.1	35.6	110.6	37.7	
	-9.8	-11.0	117	30.9	117	32.8	117	34.8	116	35.8	116	36.8	116	38.7	
	-9.5	-10.0	120	31.6	120	33.5	119	35.4	119	36.4	119	37.3	118	39.3	
	-8.5	-9.1	123	32.2	122	34.1	122	36.0	122	36.9	121	37.9	121	39.7	
	-7.0	-7.6	127	33.3	127	35.1	126	36.9	126	37.8	126	38.7	125	40.5	
	-5.0	-5.6	133	34.6	133	36.3	133	38.1	132	38.9	132	39.8	132	41.5	
	-3.0	-3.7	140	35.9	139	37.5	139	39.1	139	40.0	139	40.8	138	42.4	
	0.0	-0.7	151	37.7	150	39.2	150	40.8	150	41.5	149	42.3	149	43.8	
	3.0	2.2	162	39.4	162	40.8	161	42.2	161	42.9	161	43.6	160	45.0	
	5.0	4.1	170	40.4	170	41.8	169	43.1	169	43.8	169	44.5	168	45.8	
	7.0	6.0	179	41.4	178	42.7	178	44.0	177	44.6	177	45.2	171	44.0	
	9.0	7.9	187	42.4	187	43.6	186	44.8	186	45.4	186	46.0	171	41.5	
11.0	9.8	196	43.2	196	44.4	196	45.6	194	45.6	186	43.4	171	39.1		
13.0	11.8	206	44.1	206	45.2	202	44.9	194	42.8	186	40.8	171	36.9		
15.0	13.7	216	44.9	216	46.0	202	42.4	194	40.5	186	38.6	171	34.9		
110% 165.00 kW	-19.8	-20.0	97.2	27.5	96.9	29.7	96.5	31.8	96.3	32.9	96.1	34.0	95.7	36.2	
	-18.8	-19.0	99.0	28.1	98.6	30.2	98.2	32.4	98.0	33.5	97.8	34.5	97.4	36.7	
	-16.7	-17.0	102.8	29.4	102.4	31.4	102.1	33.5	101.9	34.5	101.7	35.6	101.3	37.6	
	-13.7	-15.0	107.1	30.7	106.7	32.7	106.3	34.6	106.1	35.6	105.9	36.6	105.5	38.6	
	-11.8	-13.0	111.8	32.0	111.4	33.9	111.0	35.8	110.8	36.7	110.6	37.7	110.2	39.6	
	-9.8	-11.0	117	33.3	117	35.1	116	36.9	116	37.8	116	38.7	115	40.5	
	-9.5	-10.0	120	34.0	119	35.7	119	37.5	119	38.4	118	39.3	118	41.0	
	-8.5	-9.1	122	34.6	122	36.3	121	38.0	121	38.9	121	39.7	121	41.5	
	-7.0	-7.6	127	35.5	126	37.2	126	38.8	126	39.7	125	40.5	125	42.2	
	-5.0	-5.6	133	36.8	133	38.3	132	39.9	132	40.7	132	41.5	131	43.1	
	-3.0	-3.7	139	37.9	139	39.4	139	40.9	138	41.7	138	42.4	138	43.9	
	0.0	-0.7	150	39.6	150	41.0	149	42.4	149	43.1	149	43.8	149	45.2	
	3.0	2.2	162	41.2	161	42.5	161	43.7	161	44.4	160	45.0	156	44.7	
	5.0	4.1	170	42.1	169	43.3	169	44.6	169	45.2	168	45.8	156	42.1	
	7.0	6.0	178	43.0	178	44.2	177	45.4	177	45.9	171	44.0	156	39.7	
	9.0	7.9	187	43.9	186	45.0	185	45.6	178	43.5	171	41.5	156	37.5	
11.0	9.8	196	44.7	196	45.7	185	43.0	178	41.1	171	39.1	156	35.4		
13.0	11.8	206	45.5	199	44.2	185	40.5	178	38.7	171	36.9	156	33.4		
15.0	13.7	213	45.3	199	41.7	185	38.3	178	36.6	171	34.9	156	31.6		
100% 150.00 kW	-19.8	-20.0	96.7	30.5	96.4	32.4	96.0	34.4	95.8	35.4	95.7	36.4	95.3	38.4	
	-18.8	-19.0	98.5	31.0	98.1	33.0	97.8	34.9	97.6	35.9	97.4	36.9	97.1	38.8	
	-16.7	-17.0	102.3	32.2	102.0	34.1	101.6	35.9	101.4	36.9	101.2	37.8	100.9	39.7	
	-13.7	-15.0	106.6	33.4	106.2	35.2	105.9	37.0	105.7	37.9	105.5	38.8	105.2	40.6	
	-11.8	-13.0	111.3	34.6	110.9	36.3	110.6	38.0	110.4	38.9	110.2	39.7	109.9	41.5	
	-9.8	-11.0	116	35.8	116	37.4	116	39.1	116	39.9	115	40.7	115	42.4	
	-9.5	-10.0	119	36.4	119	38.0	118	39.6	118	40.4	118	41.2	118	42.8	
	-8.5	-9.1	122	36.9	121	38.5	121	40.0	121	40.8	121	41.6	120	43.2	
	-7.0	-7.6	126	37.8	126	39.3	125	40.8	125	41.6	125	42.3	125	43.8	
	-5.0	-5.6	132	38.9	132	40.4	132	41.8	132	42.5	131	43.2	131	44.7	
	-3.0	-3.7	139	40.0	138	41.3	138	42.7	138	43.4	138	44.1	137	45.4	
	0.0	-0.7	150	41.5	149	42.8	149	44.0	149	44.7	149	45.3	142	43.6	
	3.0	2.2	161	42.9	161	44.1	160	45.3	160	45.9	155	44.2	142	39.9	
	5.0	4.1	169	43.8	169	44.9	168	45.9	162	43.7	155	41.7	142	37.6	
	7.0	6.0	177	44.6	177	45.7	168	43.2	162	41.2	155	39.3	142	35.5	
	9.0	7.9	186	45.4	181	44.5	168	40.7	162	38.9	155	37.1	142	33.6	
11.0	9.8	194	45.6	181	42.0	168	38.5	162	36.7	155	35.1	142	31.8		
13.0	11.8	194	42.8	181	39.5	168	36.2	162	34.6	155	33.1	142	30.0		
15.0	13.7	194	40.5	181	37.3	168	34.3	162	32.8	155	31.3	142	28.5		

NOTES - ANMERKUNGEN - Σημειώσεις - NOTAS - REMARQUES - NOTE - OPMERKINGEN - примечания - NOTLAR

- █ is shown as reference. When selecting the unit models, avoid the Outdoor air temperature range shown by █.
 dient als Verweis. Vermeiden Sie bei der Auswahl der Gerätemodelle den als markierten Temperaturbereich der Außenluft.
 Η █ είναι ενδεικτική, κατά την επιλογή των μοντέλων των μονάδων, αποφεύγετε το εύρος θερμοκρασίας εξωτερικού αέρα που υποδεικνύεται.
 █ se muestra como referencia. Cuando seleccione los modelos de unidad, evite el intervalo de temperaturas del aire exterior indicado mediante █.
 █ est montré comme référence. Lors du choix des modèles d'unités, évitez la plage de températures de l'air extérieur illustré par █.
 █ valori riportati unicamente come riferimento. Nel selezionare i modelli delle unità, non considerare i valori di temperatura dell'aria esterna indicati con il colore █.
 █ is als referentie getoond. Wanneer modellen van eenheden worden gekozen, vermijd dan het bereik van buitenluchttemperaturen geïllustreerd door █.
- █ показан как. При выборе модели устройства избегайте внешнюю температуру воздуха, указанную в █.
 █ referans olarak gösterilmektedir. Ünite modellerini seçerken, belirtilen dış hava sıcaklığı aralığından kaçınınız.
 The above table shows the average value of conditions which may occur.
 Die obige Tabelle zeigt den Durchschnittswert der Bedingungen, die auftreten können.
 Στον παραπάνω πίνακα αναγράφεται η μέση τιμή για συνθήκες που μπορεί να προκύψουν.
 La tabla de arriba muestra el valor medio de condiciones que pueden ocurrir.
 Le tableau ci-dessus donne la valeur moyenne pour des conditions qui peuvent survenir.
 La tabella in alto mostra il valore delle condizioni medie che si possono riscontrare.
 De tabel hierboven geeft de gemiddelde waarde aan van situaties die kunnen voorvallen.
 Таблица расположенная выше показывает среднее значение условий, которые могут наступить.
 Yukarıdaki tablo meydana gelebilecek koşulların ortalama değerini göstermektedir.

3D079549

5 Таблицы производительности

5 - 2 Таблицы теплопроизводительностей

5

RXYQ54T														
Indoor air temp. °CDB														
Combination (%) (Capacity index)	Outdoor air temp.		16.0		18.0		20.0		21.0		22.0		24.0	
			TC	PI	TC	PI	TC	PI	TC	PI	TC	PI	TC	PI
	(°CDB)	(°CWB)	KW	KW	KW	KW	KW	KW	KW	KW	KW	KW	KW	KW
90% 135.00 kW	-19.8	-20.0	96.2	33.4	95.9	35.2	95.5	37.0	95.4	37.9	95.2	38.8	94.9	40.6
	-18.8	-19.0	97.9	34.0	97.6	35.7	97.3	37.5	97.1	38.4	97.0	39.2	96.7	41.0
	-16.7	-17.0	101.8	35.0	101.5	36.7	101.1	38.4	101.0	39.2	100.8	40.1	100.5	41.8
	-13.7	-15.0	106.0	36.1	105.7	37.7	105.4	39.3	105.2	40.1	105.1	40.9	104.8	42.6
	-11.8	-13.0	110.7	37.2	110.4	38.7	110.1	40.3	109.9	41.0	109.8	41.8	109.5	43.4
	-9.8	-11.0	116	38.3	116	39.7	115	41.2	115	41.9	115	42.7	115	44.2
	-9.5	-10.0	119	38.8	118	40.2	118	41.7	118	42.4	118	43.1	117	44.6
	-8.5	-9.1	121	39.3	121	40.7	121	42.1	120	42.8	120	43.5	120	44.9
	-7.0	-7.6	126	40.0	125	41.4	125	42.8	125	43.4	125	44.1	124	45.5
	-5.0	-5.6	132	41.1	132	42.4	131	43.7	131	44.3	131	44.9	128	44.8
	-3.0	-3.7	138	42.0	138	43.2	138	44.5	137	45.1	137	45.7	128	42.2
	0.0	-0.7	149	43.4	149	44.5	149	45.7	145	44.8	140	42.7	128	38.5
	3.0	2.2	161	44.7	160	45.7	151	42.9	145	40.9	140	39.0	128	35.3
	5.0	4.1	169	45.5	163	44.2	151	40.4	145	38.6	140	36.8	128	33.3
	7.0	6.0	174	45.2	163	41.6	151	38.1	145	36.5	140	34.8	128	31.5
	9.0	7.9	174	42.6	163	39.3	151	36.0	145	34.4	140	32.9	128	29.9
11.0	9.8	174	40.2	163	37.1	151	34.1	145	32.6	140	31.1	128	28.3	
13.0	11.8	174	37.8	163	35.0	151	32.1	145	30.8	140	29.4	128	26.8	
15.0	13.7	174	35.8	163	33.1	151	30.5	145	29.2	140	27.9	128	25.4	
80% 120.00 kW	-19.8	-20.0	95.7	36.4	95.4	38.0	95.1	39.6	94.9	40.4	94.8	41.2	94.5	42.8
	-18.8	-19.0	97.4	36.9	97.1	38.5	96.8	40.0	96.7	40.8	96.6	41.6	96.3	43.1
	-16.7	-17.0	101.2	37.8	101.0	39.3	100.7	40.8	100.5	41.6	100.4	42.3	100.1	43.8
	-13.7	-15.0	105.5	38.8	105.2	40.2	104.9	41.7	104.8	42.4	104.7	43.1	104.4	44.5
	-11.8	-13.0	110.2	39.7	109.9	41.1	109.6	42.5	109.5	43.2	109.4	43.9	109.1	45.3
	-9.8	-11.0	115	40.7	115	42.0	115	43.3	115	44.0	114	44.7	114	45.7
	-9.5	-10.0	118	41.2	118	42.5	118	43.8	117	44.4	117	45.0	114	44.3
	-8.5	-9.1	121	41.6	120	42.9	120	44.1	120	44.7	120	45.4	114	43.2
	-7.0	-7.6	125	42.3	125	43.5	124	44.7	124	45.3	124	45.9	114	41.3
	-5.0	-5.6	131	43.2	131	44.4	131	45.5	129	45.3	124	43.1	114	38.9
	-3.0	-3.7	138	44.1	137	45.1	134	44.8	129	42.7	124	40.7	114	36.8
	0.0	-0.7	149	45.3	145	44.6	134	40.8	129	39.0	124	37.2	114	33.6
	3.0	2.2	155	44.2	145	40.7	134	37.3	129	35.7	124	34.1	114	30.9
	5.0	4.1	155	41.7	145	38.4	134	35.3	129	33.7	124	32.2	114	29.2
	7.0	6.0	155	39.3	145	36.3	134	33.3	129	31.9	124	30.5	114	27.7
	9.0	7.9	155	37.1	145	34.3	134	31.5	129	30.2	124	28.9	114	26.3
11.0	9.8	155	35.1	145	32.4	134	29.9	129	28.6	124	27.4	114	24.9	
13.0	11.8	155	33.1	145	30.6	134	28.2	129	27.1	124	25.9	114	23.6	
15.0	13.7	155	31.3	145	29.0	134	26.8	129	25.7	124	24.6	114	22.5	
70% 105.00 kW	-19.8	-20.0	95.1	39.4	94.9	40.8	94.6	42.2	94.5	42.9	94.4	43.6	94.1	45.0
	-18.8	-19.0	96.9	39.8	96.6	41.2	96.4	42.6	96.3	43.2	96.1	43.9	95.9	45.3
	-16.7	-17.0	100.7	40.6	100.5	42.0	100.2	43.3	100.1	43.9	100.0	44.6	99.5	45.7
	-13.7	-15.0	105.0	41.5	104.7	42.7	104.5	44.0	104.4	44.6	104.2	45.3	99.5	43.4
	-11.8	-13.0	109.7	42.3	109.4	43.5	109.2	44.7	109.1	45.3	108.6	45.7	99.5	41.2
	-9.8	-11.0	115	43.2	115	44.3	114	45.5	113	45.3	108.6	43.2	99.5	39.0
	-9.5	-10.0	118	43.6	117	44.7	117	45.8	113	44.0	108.6	41.9	99.5	37.9
	-8.5	-9.1	120	44.0	120	45.1	118	45.0	113	42.9	108.6	40.9	99.5	36.9
	-7.0	-7.6	125	44.6	124	45.6	118	43.0	113	41.0	108.6	39.1	99.5	35.4
	-5.0	-5.6	131	45.4	127	44.2	118	40.5	113	38.7	108.6	36.9	99.5	33.4
	-3.0	-3.7	136	45.3	127	41.7	118	38.2	113	36.5	108.6	34.9	99.5	31.6
	0.0	-0.7	136	41.3	127	38.1	118	35.0	113	33.4	108.6	31.9	99.5	29.0
	3.0	2.2	136	37.8	127	34.9	118	32.1	113	30.7	108.6	29.4	99.5	26.7
	5.0	4.1	136	35.7	127	33.0	118	30.3	113	29.1	108.6	27.8	99.5	25.3
	7.0	6.0	136	33.7	127	31.2	118	28.7	113	27.5	108.6	26.4	99.5	24.0
	9.0	7.9	136	31.9	127	29.5	118	27.2	113	26.1	108.6	25.0	99.5	22.9
11.0	9.8	136	30.2	127	28.0	118	25.8	113	24.8	108.6	23.8	99.5	21.7	
13.0	11.8	136	28.5	127	26.5	118	24.5	113	23.5	108.6	22.5	99.5	20.6	
15.0	13.7	136	27.1	127	25.2	118	23.3	113	22.4	108.6	21.5	99.5	19.7	
60% 90.00 kW	-19.8	-20.0	94.6	42.4	94.4	43.6	94.2	44.8	94.1	45.4	93.0	45.3	85.3	40.8
	-18.8	-19.0	96.3	42.8	96.1	43.9	95.9	45.1	95.8	45.7	93.0	44.3	85.3	39.9
	-16.7	-17.0	100.2	43.5	100.0	44.6	99.8	45.7	99.9	44.3	93.0	42.2	85.3	38.1
	-13.7	-15.0	104.5	44.2	104.2	45.3	100.8	44.1	96.9	42.1	93.0	40.1	85.3	36.2
	-11.8	-13.0	109.2	44.9	108.6	45.7	100.8	41.8	96.9	39.9	93.0	38.0	85.3	34.4
	-9.8	-11.0	114	45.6	108.6	43.2	100.8	39.5	96.9	37.8	93.0	36.0	85.3	32.6
	-9.5	-10.0	116	45.6	108.6	41.9	100.8	38.4	96.9	36.7	93.0	35.0	85.3	31.8
	-8.5	-9.1	116	44.4	108.6	40.9	100.8	37.5	96.9	35.8	93.0	34.2	85.3	31.0
	-7.0	-7.6	116	42.4	108.6	39.1	100.8	35.9	96.9	34.3	93.0	32.8	85.3	29.7
	-5.0	-5.6	116	40.0	108.6	36.9	100.8	33.9	96.9	32.4	93.0	31.0	85.3	28.1
	-3.0	-3.7	116	37.8	108.6	34.9	100.8	32.1	96.9	30.7	93.0	29.3	85.3	26.7
	0.0	-0.7	116	34.5	108.6	31.9	100.8	29.4	96.9	28.2	93.0	27.0	85.3	24.6
	3.0	2.2	116	31.7	108.6	29.4	100.8	27.1	96.9	26.0	93.0	24.9	85.3	22.7
	5.0	4.1	116	30.0	108.6	27.8	100.8	25.7	96.9	24.6	93.0	23.6	85.3	21.6
	7.0	6.0	116	28.4	108.6	26.4	100.8	24.4	96.9	23.4	93.0	22.4	85.3	20.6
	9.0	7.9	116	26.9	108.6	25.0	100.8	23.2	96.9	22.2	93.0	21.3	85.3	19.6
11.0	9.8	116	25.5	108.6	23.8	100.8	22.0	96.9	21.2	93.0	20.3	85.3	18.7	
13.0	11.8	116	24.2	108.6	22.5	100.8	20.9	96.9	20.1	93.0	19.3	85.3	17.8	
15.0	13.7	116	23.0	108.6	21.5	100.8	19.9	96.9	19.2	93.0	18.4	85.3	17.0	
50% 75.00 kW	-19.8	-20.0	94.1	45.4	90.5	43.8	84.0	40.1	80.8	38.3	77.5	36.5	71.1	33.1
	-18.8	-19.0	95.8	45.7	90.5	42.8	84.0	39.2	80.8	37.5	77.5	35.7	71.1	32.4
	-16.7	-17.0	96.9	44.3	90.5	40.8	84.0	37.4	80.8	35.8	77.5	34.1	71.1	31.0
	-13.7	-15.0	96.9	42.1	90.5	38.8	84.0	35.6	80.8	34.1	77.5	32.5	71.1	29.5
	-11.8	-13.0	96.9	39.9	90.5	36.8	84.0	33.8	80.8	32.4	77.5	30.9	71.1	28.1
	-9.8	-11.0	96.9	37.8	90.5	34.9	84.0	32.1	80.8	30.7	77.5	29.4	71.1	26.7
	-9.5	-10.0	96.9	36.7	90.5	33.9	84.0	31.2	80.8	29.9	77.5	28.6	71.1	26.0
	-8.5	-9.1	96.9	35.8	90.5	33.1	84.0	30.5	80.8	29.2	77.5	27.9	71.1	25.4
	-7.0	-7.6	96.9	34.3	90.5	31.8	84.0	29.3	80.8	28.0	77.5	26.8	71.1	24.5
	-5.0	-5.6	96.9	32.4	90.5	30.0	84.0	27.7	80.8	26.5	77.5	25.4	71.1	23.2
	-3.0	-3.7	96.9	30.7	90.5	28.5	84.0	26.3	80.8	25.2	77.5	24.1	71.1	22.1
	0.0	-0.7	96.9	28.2	90.5	26.2	84.0	24.2	80.8	23.2	77.5	22.3	71.1	20.4
	3.0	2.2	96.9	26.0	90.5	24.2	84.0	22.4	80.8	21.5	77.5	20.6		

5 Таблицы производительности

5 - 3 Поправочный коэффициент для общей теплопроизводительности

RXYQ-T

Таблицы производительности по отоплению не принимают во внимание снижение производительности при накоплении льда или в процессе размораживания.

Значения производительности, учитывающие данные факторы, другими словами, интегрированные значения нагревания можно рассчитать следующим образом:

Формула:

Коэффициент интегрированной теплоэффективности = A

Значение по таблице производительности по отоплению - B

Интегрированный поправочный коэффициент на накопление заморозения (кВт) = C

$A = B \cdot C$

Температура воздуха на входе теплообменника

[°C сух.т./°C вл.т.]	-7/-7,6	-5/-5,6	-3/-3,7	0/0,7	3/2,2	5/4,1	7/6
8 HP	0,95	0,93	0,88	0,84	0,85	0,90	1,00
10 HP	0,95	0,93	0,87	0,79	0,80	0,88	1,00
12 HP	0,95	0,92	0,87	0,75	0,76	0,85	1,00
14 HP	0,95	0,92	0,86	0,72	0,73	0,84	1,00
16 HP	0,95	0,92	0,86	0,72	0,72	0,83	1,00
18 HP	0,95	0,93	0,88	0,84	0,85	0,90	1,00
20 HP	0,95	0,93	0,88	0,84	0,85	0,90	1,00
22 HP	0,95	0,92	0,87	0,77	0,78	0,86	1,00
24 HP	0,95	0,92	0,87	0,75	0,76	0,85	1,00
26 HP	0,95	0,92	0,86	0,73	0,74	0,84	1,00
28 HP	0,95	0,92	0,86	0,73	0,74	0,84	1,00
30 HP	0,95	0,93	0,87	0,80	0,81	0,88	1,00
32 HP	0,95	0,92	0,86	0,71	0,72	0,83	1,00
34 HP	0,95	0,92	0,87	0,78	0,79	0,87	1,00
36 HP	0,95	0,92	0,87	0,78	0,79	0,87	1,00
38 HP	0,95	0,93	0,88	0,83	0,84	0,89	1,00
40 HP	0,95	0,93	0,87	0,80	0,81	0,88	1,00
42 HP	0,95	0,92	0,86	0,73	0,74	0,84	1,00
44 HP	0,95	0,92	0,86	0,72	0,73	0,84	1,00
46 HP	0,95	0,92	0,86	0,72	0,72	0,83	1,00
48 HP	0,95	0,92	0,86	0,71	0,72	0,83	1,00
50 HP	0,95	0,92	0,87	0,76	0,77	0,86	1,00
52 HP	0,95	0,93	0,87	0,80	0,81	0,88	1,00
54 HP	0,95	0,93	0,88	0,84	0,85	0,90	1,00

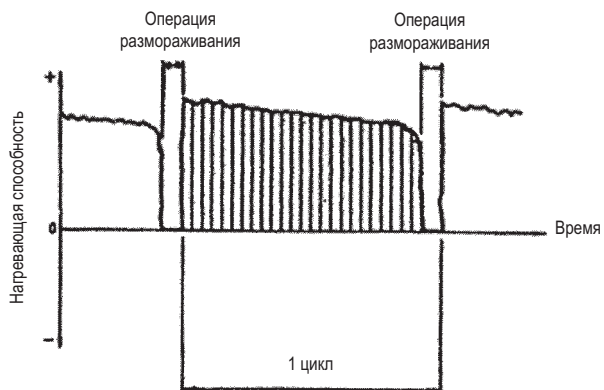

ПРИМЕЧАНИЯ

1. На чертеже показано, что интегрированная теплопроизводительность выражается как интегрированная мощность для одного блока (от операции размораживания до операции размораживания) как функция времени.
2. Обратите внимание на то, при накоплении снега на внешней поверхности теплообменника внешнего блока, наблюдается временное снижение производительности, хотя этот показатель будет зависеть от других факторов, например, температуры вне помещения (°C сух.т.), относительной влажности (RH) и количества наблюдаемого заморозения.
3. Данные мультисочетания (22-54HP) соответствуют стандартному мультисочетанию, указанному в 30079534

5 Таблицы производительности

5 - 4 Поправочный коэффициент для производительности

RXYQ8T

Поправочный коэффициент для производительности по охлаждению

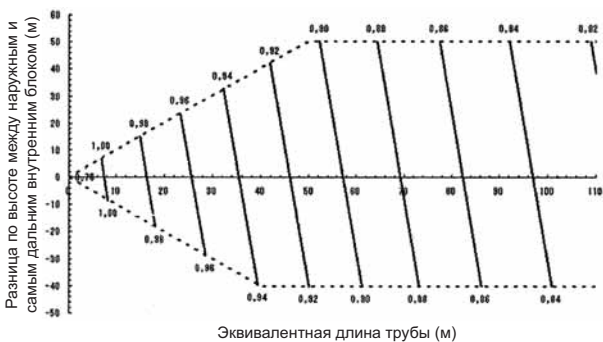

Поправочный коэффициент для производительности по отоплению

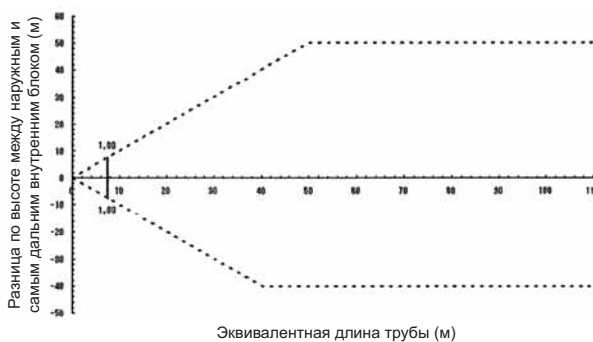

3D079897

ПРИМЕЧАНИЯ

- Эти графики показывают поправочный коэффициент на длину трубы для стандартной системы внутреннего блока при максимальной нагрузке (с установленным на максимум термостатом) при стандартных условиях. Более того, в условиях частичной нагрузки наблюдается лишь незначительное отклонение от поправочного коэффициента производительности, указанного на приведенных выше графиках.
- В этом наружном блоке осуществляется постоянное управление давлением испарения при охлаждении и давлением конденсации - при отоплении.
- Способ расчета производительности наружных блоков

Максимальная производительность системы будет равна или общей производительности внутренних блоков, или максимальной производительности наружных блоков (как указано ниже), в зависимости от того, какая величина меньше.

Условие: Отношение подключения внутренних блоков не превышает 100%.

$$\text{Максимальная производительность наружных блоков} = \text{Производительность наружных блоков на основании таблицы с данными для отношения подключения 100\%} \times \text{Поправочный коэффициент для труб до самого дальнего внутреннего блока}$$

Условие: Отношение подключения внутренних блоков превышает 100%.

$$\text{Максимальная производительность наружных блоков} = \text{Производительность наружных блоков на основании таблицы с данными для соотношений установок} \times \text{Поправочный коэффициент для труб до самого дальнего внутреннего блока}$$

- Если разность уровней равна 50 м или больше (см. руководство по установке и документацию к 3D079540 / 3D079543), и эквивалентная длина трубы составляет 90 м или больше, диаметр основных труб для газа и жидкости (наружный блок - разветвительные участки) необходимо увеличить.

Новые значения диаметров указаны ниже.

Модель	Газ	Жидкость
8 п.с.	22,2	12,7

- Если длина трубы после первого набора ответвления для хладагента превышает 40 м, размер трубы между первым и последним наборами ответвления должен быть увеличен (только для внутренних блоков VRV DX; подробная информация приведена в руководстве по установке).

*Допустимые варианты конфигурации системы и правила выполнения различных подключений внутренних блоков приведены в Руководстве по установке системы.

Диаметр основных труб (стандартный размер)

Модель	Газ	Жидкость
8 п.с.	19,1	9,5

- Эквивалентная длина на приведенных выше графиках основана на следующей эквивалентной длине

$$\text{Эквивалентная длина трубы} = \text{Эквивалентная длина основной трубы} \times \text{Поправочный коэффициент} + \text{Эквивалентная длина труб ответвлений}$$

Найдите поправочный коэффициент по следующей таблице. При расчете производительности по охлаждению: размер трубы для газа При расчете производительности по отоплению: размер трубы для жидкости

	Поправочный коэффициент	
	Стандартный размер	Увеличение размера
Охлаждение (трубка для газа)	1,0	0,5
Нагрев (трубка для жидкости)	1,0	0,5

Пример

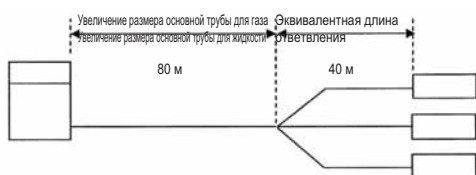

В приведенном выше случае (Охлаждение) Общая эквивалентная длина = 80 м x 0,5 + 40 м = 80 м

(Отопление) Общая эквивалентная длина = 80 м x 0,5 + 40 м = 80 м

Скорость изменения производительности по охлаждению при перепаде высоты = 0 м, таким образом, приблизительно равна 0,86

производительности по отоплению при перепаде высоты = 0 м, таким образом, приблизительно равна 1,0

5 Таблицы производительности

5 - 4 Поправочный коэффициент для производительности

RXYQ10T

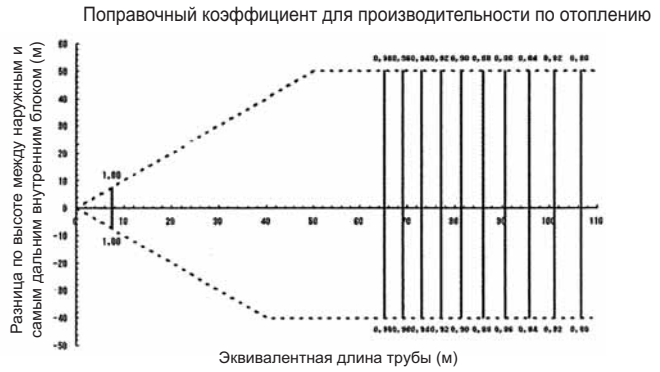
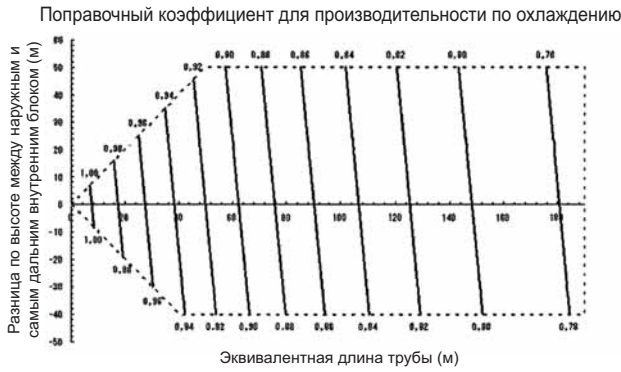

3D079897

ПРИМЕЧАНИЯ

1. Эти графики показывают поправочный коэффициент на длину трубы для стандартной системы внутреннего блока при максимальной нагрузке (с установленным на максимум термостатом) при стандартных условиях. Более того, в условиях частичной нагрузки наблюдается лишь незначительное отклонение от поправочного коэффициента производительности, указанного на приведенных выше графиках.

2. В этом наружном блоке осуществляется постоянное управление давлением испарения при охлаждении и давлением конденсации - при отоплении.

Способ расчета производительности наружных блоков

Максимальная производительность системы будет равна или общей производительности внутренних блоков, или максимальной производительности наружных блоков (как указано ниже), в зависимости от того, какая величина меньше.

Условие: Отношение подключения внутренних блоков не превышает 100%.

$$\text{Максимальная производительность наружных блоков} = \text{Производительность наружных блоков на основании таблицы с данными для отношения подключения 100\%} \times \text{Поправочный коэффициент для труб до самого дальнего внутреннего блока}$$

Условие: Отношение подключения внутренних блоков превышает 100%.

$$\text{Максимальная производительность наружных блоков} = \text{Производительность наружных блоков на основании таблицы с данными для соотношений установок} \times \text{Поправочный коэффициент для труб до самого дальнего внутреннего блока}$$

4. Если разность уровней равна 50 м или больше (см. руководство по установке и документацию к 3D079540 / 3D079543), и эквивалентная длина трубы составляет 90 м или больше, диаметр основных труб для газа и жидкости (наружный блок - разветвительные участки) необходимо увеличить. Новые значения диаметров указаны ниже.

Модель	Газ	Жидкость
RXYQ10P	25,4*	12,7

*Если нет на месте, не увеличивайте. При отсутствии увеличения необходимо применить поправочный коэффициент к эквивалентной длине (см. примечание 6).

5. Если длина трубы после первого набора ответвления для хладагента превышает 40 м, размер трубы между первым и последним наборами ответвления должен быть увеличен (только для внутренних блоков VRV DX; подробная информация приведена в руководстве по установке).

*Допустимые варианты конфигурации системы и правила выполнения различных подключений внутренних блоков приведены в Руководстве по установке системы.

Диаметр основных труб (стандартный размер)

Модель	Газ	Жидкость
10 HP	22,2	9,5

6. Эквивалентная длина на приведенных выше графиках основана на следующей эквивалентной длине

$$\text{Эквивалентная длина трубы} = \text{Эквивалентная длина основной трубы} \times \text{Поправочный коэффициент} + \text{Эквивалентная длина трубок ответвлений}$$

Найдите поправочный коэффициент по следующей таблице. При расчете производительности по охлаждению: размер трубы для газа При расчете производительности по отоплению: размер трубы для жидкости

	Поправочный коэффициент	
	Стандартный размер	Увеличение размера
Охлаждение (трубка для газа)	1.0	0,5
Нагрев (трубка для жидкости)	1.0	0,5

Пример

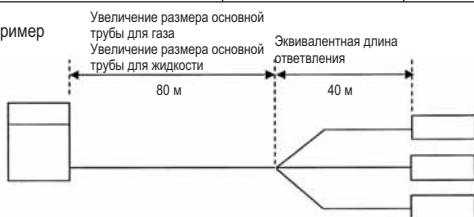

В приведенном выше случае (Охлаждение) Общая эквивалентная длина = 80 м x 0,5 + 40 м = 80 м
 (Отопление) Общая эквивалентная длина = 80 м x 0,5 + 40 м = 80 м
 Скорость изменения производительности по охлаждению при перепаде высоты = 0 м, таким образом, приблизительно равна 0,77
 производительности по отоплению при перепаде высоты = 0 м, таким образом, приблизительно равна 0,90

5 Таблицы производительности

5 - 4 Поправочный коэффициент для производительности

RXYQ12,14,24,36T

Поправочный коэффициент для производительности по охлаждению



Поправочный коэффициент для производительности по отоплению

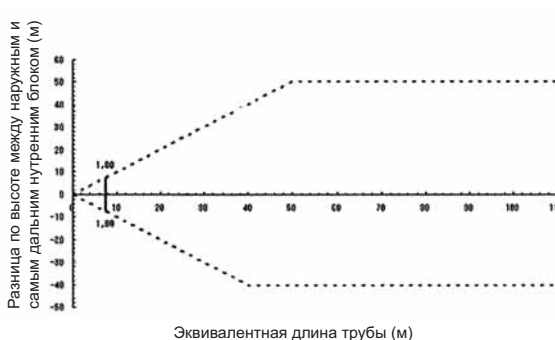

3D079897

ПРИМЕЧАНИЯ

1. Эти графики показывают поправочный коэффициент на длину трубы для стандартной системы внутреннего блока при максимальной нагрузке (с установленным на максимум термостатом) при стандартных условиях. Более того, в условиях частичной нагрузки наблюдается лишь незначительное отклонение от поправочного коэффициента производительности, указанного на приведенных выше графиках.
2. В этом наружном блоке осуществляется постоянное управление давлением испарения при охлаждении и давлением конденсации - при отоплении.

Способ расчета производительности наружных блоков

Максимальная производительность системы будет равна или общей производительности внутренних блоков, или максимальной производительности наружных блоков (как указано ниже), в зависимости от того, какая величина меньше.

Условие: Отношение подключения внутренних блоков не превышает 100%.

$$\text{Максимальная производительность наружных блоков} = \text{Производительность наружных блоков на основании таблицы с данными для отношения подключения 100\%} \times \text{Поправочный коэффициент для труб до самого дальнего внутреннего блока}$$

Условие: Отношение подключения внутренних блоков превышает 100%.

$$\text{Максимальная производительность наружных блоков} = \text{Производительность наружных блоков на основании таблицы с данными для соотношений установок} \times \text{Поправочный коэффициент для труб до самого дальнего внутреннего блока}$$

4. Если разность уровней равна 50 м или больше (см. руководство по установке и документацию к 3D079540 / 3D079543), и эквивалентная длина трубы составляет 90 м или больше, диаметр основных труб для газа и жидкости (наружный блок - разветвительные участки) необходимо увеличить. Новые значения диаметров указаны ниже.

Модель	Газ	Жидкость
12 HP	28,6	15,9
14 HP	28,6	15,9
24 HP	34,9	19,1
36 HP	41,3	22,2

5. Если длина трубы после первого набора ответвления для хладагента превышает 40 м, размер трубы между первым и последним наборами ответвления должен быть увеличен (только для внутренних блоков VRV DX; подробная информация приведена в руководстве по установке).

*Допустимые варианты конфигурации системы и правила выполнения различных подключений внутренних блоков приведены в Руководстве по установке системы.

Диаметр основных труб (стандартный размер)

Модель	Газ	Жидкость
12 HP	28,6	12,7
14 HP	28,6	12,7
24 HP	34,9	15,9
36 HP	41,3	19,1

6. Эквивалентная длина на приведенных выше графиках основана на следующей эквивалентной длине

$$\text{Эквивалентная длина трубы} = \text{Эквивалентная длина основной трубы} \times \text{Поправочный коэффициент} + \text{Эквивалентная длина труб ответвлений}$$

Найдите поправочный коэффициент по следующей таблице. При расчете производительности по охлаждению: размер трубы для газа При расчете производительности по отоплению: размер трубы для жидкости

	Поправочный коэффициент	
	Стандартный размер	Увеличение размера
Охлаждение (трубка для газа)	1,0	0,5
Нагрев (трубка для жидкости)	1,0	0,5

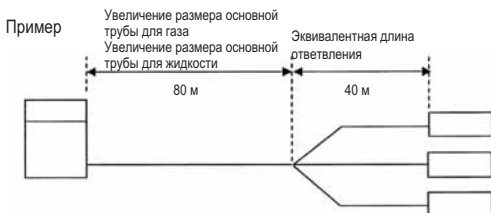

В приведенном выше случае (Охлаждение) Общая эквивалентная длина = 80 м x 1,0 + 40 м = 120 м
 (Отопление) Общая эквивалентная длина = 80 м x 0,5 + 40 м = 80 м
 Скорость изменения производительности по охлаждению при перепаде высоты = 0 м, таким образом, приблизительно равна 0,89
 производительности по отоплению при перепаде высоты = 0 м, таким образом, приблизительно равна 1,0

5 Таблицы производительности

5 - 4 Поправочный коэффициент для производительности

RXYQ16T

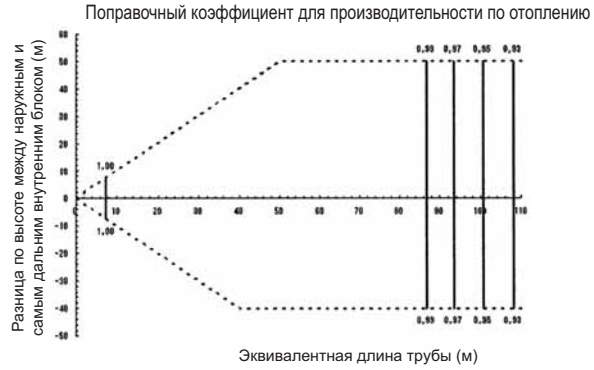
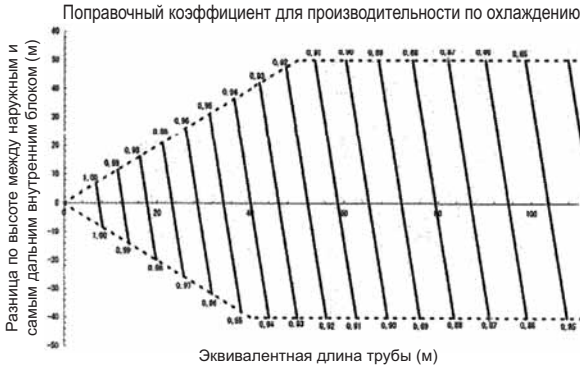

3D079897

ПРИМЕЧАНИЯ

1. Эти графики показывают поправочный коэффициент на длину трубы для стандартной системы внутреннего блока при максимальной нагрузке (с установленным на максимум термостатом) при стандартных условиях. Более того, в условиях частичной нагрузки наблюдается лишь незначительное отклонение от поправочного коэффициента производительности, указанного на приведенных выше графиках.

2. В этом наружном блоке осуществляется постоянное управление давлением испарения при охлаждении и давлением конденсации - при отоплении.

Способ расчета производительности наружных блоков

Максимальная производительность системы будет равна или общей производительности внутренних блоков, или максимальной производительности наружных блоков (как указано ниже), в зависимости от того, какая величина меньше.

Условие: Отношение подключения внутренних блоков не превышает 100%.

$$\text{Максимальная производительность наружных блоков} = \text{Производительность наружных блоков на основании таблицы с данными для отношения подключения 100\%} \times \text{Поправочный коэффициент для труб до самого дальнего внутреннего блока}$$

Условие: Отношение подключения внутренних блоков превышает 100%.

$$\text{Максимальная производительность наружных блоков} = \text{Производительность наружных блоков на основании таблицы с данными для соотношений установок} \times \text{Поправочный коэффициент для труб до самого дальнего внутреннего блока}$$

4. Если разность уровней равна 50 м или больше (см. руководство по установке и документацию к 3D079540 / 3D079543), и эквивалентная длина трубы составляет 90 м или больше, диаметр основных труб для газа и жидкости (наружный блок - разветвительные участки) необходимо увеличить. Новые значения диаметров указаны ниже.

Модель	Газ	Жидкость
16 HP	31,8*	15,9

*Если нет на месте, не увеличивайте. При отсутствии увеличения необходимо применить поправочный коэффициент к эквивалентной длине (см. примечание 6).

5. Если длина трубы после первого набора ответвления для хладагента превышает 40 м, размер трубы между первым и последним наборами ответвления должен быть увеличен (только для внутренних блоков VRV DX; подробная информация приведена в руководстве по установке).

*Допустимые варианты конфигурации системы и правила выполнения различных подключений внутренних блоков приведены в Руководстве по установке системы.

Диаметр основных труб (стандартный размер)

Модель	Газ	Жидкость
16 HP	28,6	12,7

6. Эквивалентная длина на приведенных выше графиках основана на следующей эквивалентной длине

$$\text{Эквивалентная длина трубы} = \text{Эквивалентная длина основной трубы} \times \text{Поправочный коэффициент} + \text{Эквивалентная длина трубок ответвлений}$$

Найдите поправочный коэффициент по следующей таблице. При расчете производительности по охлаждению: размер трубы для газа При расчете производительности по отоплению: размер трубы для жидкости

	Поправочный коэффициент	
	Стандартный размер	Увеличение размера
Охлаждение (трубка для газа)	1,0	0,5
Нагрев (трубка для жидкости)	1,0	0,5

Пример

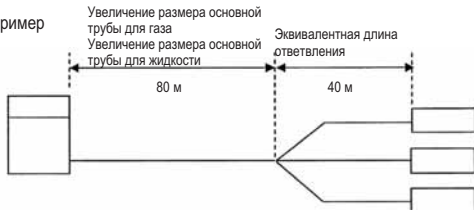

В приведенном выше случае (Охлаждение) Общая эквивалентная длина = 80 м x 1,0 + 40 м = 80 м
(Отопление) Общая эквивалентная длина = 80 м x 0,5 + 40 м = 80 м
Скорость изменения производительности по охлаждению при перепаде высоты = 0 м, таким образом, приблизительно равна 0,88
производительности по отоплению при перепаде высоты = 0 м, таким образом, приблизительно равна 0,99

5 Таблицы производительности

5 - 4 Поправочный коэффициент для производительности

RXYQ18,26,28,30,38,40,42,44T

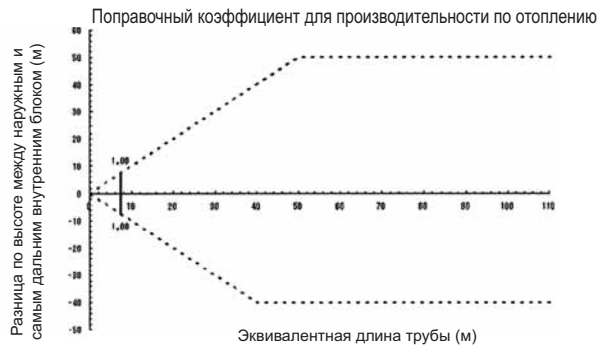

3D079897

ПРИМЕЧАНИЯ

- Эти графики показывают поправочный коэффициент на длину трубы для стандартной системы внутреннего блока при максимальной нагрузке (с установленным на максимум термостатом) при стандартных условиях. Более того, в условиях частичной нагрузки наблюдается лишь незначительное отклонение от поправочного коэффициента производительности, указанного на приведенных выше графиках.
- В этом наружном блоке осуществляется постоянное управление давлением испарения при охлаждении и давлением конденсации - при отоплении.

Способ расчета производительности наружных блоков

Максимальная производительность системы будет равна или общей производительности внутренних блоков, или максимальной производительности наружных блоков (как указано ниже), в зависимости от того, какая величина меньше.

Условие: Отношение подключения внутренних блоков не превышает 100%.

$$\text{Максимальная производительность наружных блоков} = \text{Производительность наружных блоков на основании таблицы с данными для отношения подключения 100\%} \times \text{Поправочный коэффициент для трубок до самого дальнего внутреннего блока}$$

Условие: Отношение подключения внутренних блоков превышает 100%.

$$\text{Максимальная производительность наружных блоков} = \text{Производительность наружных блоков на основании таблицы с данными для соотношений установок} \times \text{Поправочный коэффициент для трубок до самого дальнего внутреннего блока}$$

- Если разность уровней равна 50 м или больше (см. руководство по установке и документацию к 3D079540 / 3D079543), и эквивалентная длина трубы составляет 90 м или больше, диаметр основных трубок для газа и жидкости (наружный блок - разветвительные участки) необходимо увеличить.

Новые значения диаметров указаны ниже.

Модель	Газ	Жидкость
18 HP	31,8*	19,1
26~30 HP	38,1*	22,2
38~44 HP	41,3	22,2

*Если нет на месте, не увеличивайте. При отсутствии увеличения необходимо применить поправочный коэффициент к эквивалентной длине (см. примечание 6).

- Если длина трубы после первого набора ответвления для хладагента превышает 40 м, размер трубы между первым и последним наборами ответвления должен быть увеличен (только для внутренних блоков VRV DX; подробная информация приведена в руководстве по установке).

*Допустимые варианты конфигурации системы и правила выполнения различных подключений внутренних блоков приведены в Руководстве по установке системы.

Диаметр основных трубок (стандартный размер)

Модель	Газ	Жидкость
18 HP	28,6	15,9
26~30 HP	34,9	19,1
38~44 HP	41,3	19,1

- Эквивалентная длина на приведенных выше графиках основана на следующей эквивалентной длине

$$\text{Эквивалентная длина трубы} = \text{Эквивалентная длина основной трубы} \times \text{Поправочный коэффициент} + \text{Эквивалентная длина трубок ответвлений}$$

Найдите поправочный коэффициент по следующей таблице. При расчете производительности по охлаждению: размер трубы для газа При расчете производительности по отоплению: размер трубы для жидкости

	Поправочный коэффициент	
	Стандартный размер	Увеличение размера
Охлаждение (трубка для газа)	1,0	0,5
Нагрев (трубка для жидкости)	1,0	0,5



В приведенном выше случае (для RXYQ38-44) (Охлаждение) Общая эквивалентная длина = 80 м x 1,0 + 40 м = 120 м

(Отопление) Общая эквивалентная длина = 80 м x 0,5 + 40 м = 80 м

Скорость изменения производительности по охлаждению при перепаде высоты = 0 м, таким образом, приблизительно равна 0,83
производительности по отоплению при перепаде высоты = 0 м, таким образом, приблизительно равна 1,0

5 Таблицы производительности

5 - 4 Поправочный коэффициент для производительности

RXYQ20,32,34T

Поправочный коэффициент для производительности по охлаждению

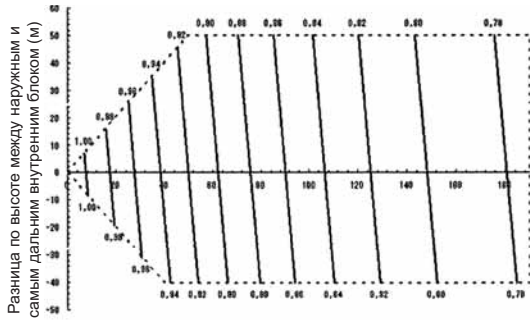

Эквивалентная длина трубы (м)

Поправочный коэффициент для производительности по отоплению

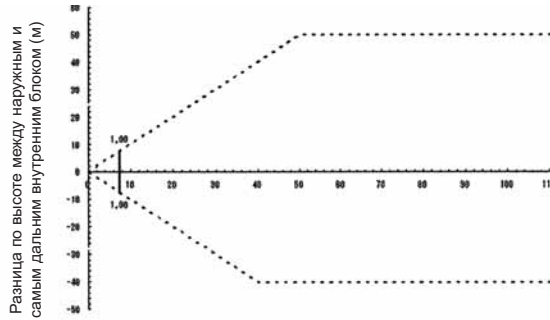

Эквивалентная длина трубы (м)

3D079897

ПРИМЕЧАНИЯ

- Эти графики показывают поправочный коэффициент на длину трубы для стандартной системы внутреннего блока при максимальной нагрузке (с установленным на максимум термостатом) при стандартных условиях. Более того, в условиях частичной нагрузки наблюдается лишь незначительное отклонение от поправочного коэффициента производительности, указанного на приведенных выше графиках.
- В этом наружном блоке осуществляется постоянное управление давлением испарения при охлаждении и давлением конденсации - при отоплении.

Способ расчета производительности наружных блоков

Максимальная производительность системы будет равна или общей производительности внутренних блоков, или максимальной производительности наружных блоков (как указано ниже), в зависимости от того, какая величина меньше.

Условие: Отношение подключения внутренних блоков не превышает 100%.

$$\text{Максимальная производительность наружных блоков} = \text{Производительность наружных блоков на основании таблицы с данными для отношения подключения 100\%} \times \text{Поправочный коэффициент для труб до самого дальнего внутреннего блока}$$

Условие: Отношение подключения внутренних блоков превышает 100%.

$$\text{Максимальная производительность наружных блоков} = \text{Производительность наружных блоков на основании таблицы с данными для соотношений установок} \times \text{Поправочный коэффициент для труб до самого дальнего внутреннего блока}$$

- Если разность уровней равна 50 м или больше (см. руководство по установке и документацию к 3D079540 / 3D079543), и эквивалентная длина трубы составляет 90 м или больше, диаметр основных трубок для газа и жидкости (наружный блок - разветвительные участки) необходимо увеличить. Новые значения диаметров указаны ниже.

Модель	Газ	Жидкость
20 HP	31,8*	19,1
32/34 HP	38,1*	22,2

*Если нет на месте, не увеличивайте. При отсутствии увеличения необходимо применить поправочный коэффициент к эквивалентной длине (см. примечание 6).

- Если длина трубы после первого набора ответвления для хладагента превышает 40 м, размер трубы между первым и последним наборами ответвления должен быть увеличен (только для внутренних блоков VRV DX; подробная информация приведена в руководстве по установке).

*Допустимые варианты конфигурации системы и правила выполнения различных подключений внутренних блоков приведены в Руководстве по установке системы.

Диаметр основных трубок (стандартный размер)

Модель	Газ	Жидкость
20 HP	28,6	15,9
32/34 HP	34,9	19,1

- Эквивалентная длина на приведенных выше графиках основана на следующей эквивалентной длине

$$\text{Эквивалентная длина трубы} = \text{Эквивалентная длина основной трубы} \times \text{Поправочный коэффициент} + \text{Эквивалентная длина трубок ответвлений}$$

Найдите поправочный коэффициент по следующей таблице. При расчете производительности по охлаждению: размер трубы для газа При расчете производительности по отоплению: размер трубы для жидкости

	Поправочный коэффициент	
	Стандартный размер	Увеличение размера
Охлаждение (трубка для газа)	1.0	0,5
Нагрев (трубка для жидкости)	1.0	0,5

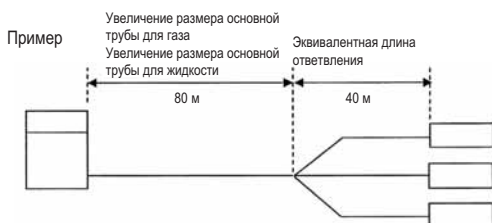

В приведенном выше случае (Охлаждение) Общая эквивалентная длина = 80 м x 0,5 + 40 м = 80 м

(Отопление) Общая эквивалентная длина = 80 м x 0,5 + 40 м = 80 м

Скорость изменения производительности по охлаждению при перепаде высоты = 0 м, таким образом, приблизительно равна 0,88
производительности по отоплению при перепаде высоты = 0 м, таким образом, приблизительно равна 1,0

5 Таблицы производительности

5 - 4 Поправочный коэффициент для производительности

5

RXYQ22T

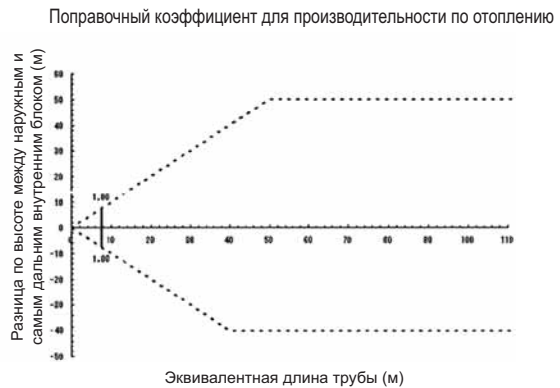
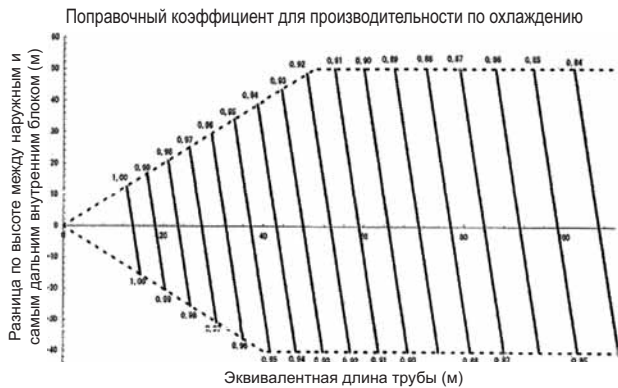

3D079897

ПРИМЕЧАНИЯ

- Эти графики показывают поправочный коэффициент на длину трубы для стандартной системы внутреннего блока при максимальной нагрузке (с установленным на максимум термостатом) при стандартных условиях. Более того, в условиях частичной нагрузки наблюдается лишь незначительное отклонение от поправочного коэффициента производительности, указанного на приведенных выше графиках.
- В этом наружном блоке осуществляется постоянное управление давлением испарения при охлаждении и давлением конденсации - при отоплении.

Способ расчета производительности наружных блоков

Максимальная производительность системы будет равна или общей производительности внутренних блоков, или максимальной производительности наружных блоков (как указано ниже), в зависимости от того, какая величина меньше.

Условие: Отношение подключения внутренних блоков не превышает 100%.

$$\text{Максимальная производительность наружных блоков} = \frac{\text{Производительность наружных блоков на основании таблицы с данными для отношения подключения 100\%}}{\text{Поправочный коэффициент для труб до самого дальнего внутреннего блока}}$$

Условие: Отношение подключения внутренних блоков превышает 100%.

$$\text{Максимальная производительность наружных блоков} = \frac{\text{Производительность наружных блоков на основании таблицы с данными для соотношений установок}}{\text{Поправочный коэффициент для труб до самого дальнего внутреннего блока}}$$

- Если разность уровней равна 50 м или больше (см. руководство по установке и документацию к 3D079540 / 3D079543), и эквивалентная длина трубы составляет 90 м или больше, диаметр основных труб для газа и жидкости (наружный блок - разветвительные участки) необходимо увеличить. Новые значения диаметров указаны ниже.

Модель	Газ	Жидкость
22 HP	31,8*	19,1

* Если нет на месте, не увеличивайте. При отсутствии увеличения нет необходимости в применении поправочного коэффициента к эквивалентной длине (см. примечание 6).

- Если длина трубы после первого набора ответвления для хладагента превышает 40 м, размер трубы между первым и последним наборами ответвления должен быть увеличен (только для внутренних блоков VRV DX; подробная информация приведена в руководстве по установке).

*Допустимые варианты конфигурации системы и правила выполнения различных подключений внутренних блоков приведены в Руководстве по установке системы.

Диаметр основных труб (стандартный размер)

Модель	Газ	Жидкость
22 HP	28,6	15,9

- Эквивалентная длина на приведенных выше графиках основана на следующей эквивалентной длине

$$\text{Общая эквивалентная длина} = \text{Эквивалентная длина основной трубы} \times \text{Поправочный коэффициент} + \text{Эквивалентная длина трубок ответвлений}$$

Найдите поправочный коэффициент по следующей таблице. При расчете производительности по охлаждению: размер трубы для газа При расчете производительности по отоплению: размер трубы для жидкости

	Поправочный коэффициент	
	Стандартный размер	Увеличение размера
Охлаждение (трубка для газа)	1,0	0,5
Нагрев (трубка для жидкости)	1,0	0,5

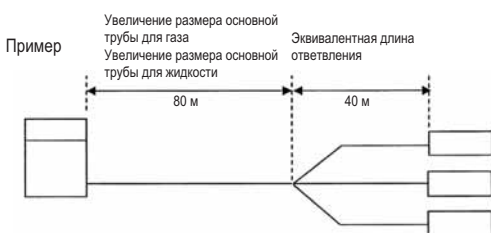

В приведенном выше случае (Охлаждение) Общая эквивалентная длина = 80 м x 0,5 + 40 м = 80 м
(Отопление) Общая эквивалентная длина = 80 м x 0,5 + 40 м = 80 м

Скорость изменения производительности по охлаждению при перепаде высоты = 0 м, таким образом, приблизительно равна 0,88
производительности по отоплению при перепаде высоты = 0 м, таким образом, приблизительно равна 1,0

5 Таблицы производительности

5 - 4 Поправочный коэффициент для производительности

RXYQ46T

Поправочный коэффициент для производительности по охлаждению

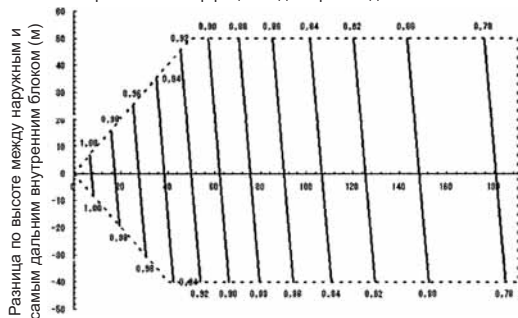

Эквивалентная длина трубы (м)

Поправочный коэффициент для производительности по отоплению

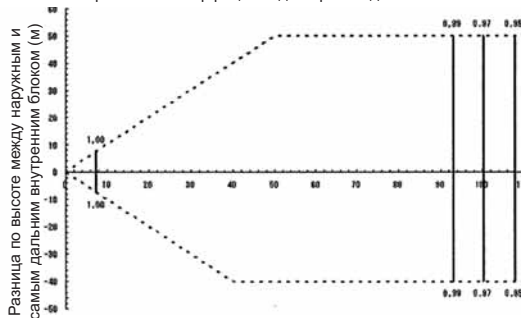

Эквивалентная длина трубы (м)

3D079897

ПРИМЕЧАНИЯ

- Эти графики показывают поправочный коэффициент на длину трубы для стандартной системы внутреннего блока при максимальной нагрузке (с установленным на максимум термостатом) при стандартных условиях. Более того, в условиях частичной нагрузки наблюдается лишь незначительное отклонение от поправочного коэффициента производительности, указанного на приведенных выше графиках.
- В этом наружном блоке осуществляется постоянное управление давлением испарения при охлаждении и давлением конденсации - при отоплении.

Способ расчета производительности наружных блоков

Максимальная производительность системы будет равна или общей производительности внутренних блоков, или максимальной производительности наружных блоков (как указано ниже), в зависимости от того, какая величина меньше.

Условие: Отношение подключения внутренних блоков не превышает 100%.

$$\text{Максимальная производительность наружных блоков} = \frac{\text{Производительность наружных блоков на основании таблицы с данными для отношения подключения 100\%}}{\text{Поправочный коэффициент для труб до самого дальнего внутреннего блока}}$$

Условие: Отношение подключения внутренних блоков превышает 100%.

$$\text{Максимальная производительность наружных блоков} = \frac{\text{Производительность наружных блоков на основании таблицы с данными для соотношений установок}}{\text{Поправочный коэффициент для труб до самого дальнего внутреннего блока}}$$

- Если разность уровней равна 50 м или больше (см. руководство по установке и документацию к 3D079540 / 3D079543), и эквивалентная длина трубы составляет 90 м или больше, диаметр основных труб для газа и жидкости (наружный блок - разветвительные участки) необходимо увеличить. Новые значения диаметров указаны ниже.

Модель	Газ	Жидкость
46 HP	41,3	22,2

- Если длина трубы после первого набора ответвления для хладагента превышает 40 м, размер трубы между первым и последним наборами ответвления должен быть увеличен (только для внутренних блоков VRV DX; подробная информация приведена в руководстве по установке).

*Допустимые варианты конфигурации системы и правила выполнения различных подключений внутренних блоков приведены в Руководстве по установке системы.

Диаметр основных труб (стандартный размер)

Модель	Газ	Жидкость
46 HP	41,3	19,1

- Эквивалентная длина на приведенных выше графиках основана на следующей эквивалентной длине

$$\text{Эквивалентная длина трубы} = \text{Эквивалентная длина основной трубы} \times \text{Поправочный коэффициент} + \text{Эквивалентная длина трубок ответвлений}$$

Найдите поправочный коэффициент по следующей таблице. При расчете производительности по охлаждению: размер трубы для газа При расчете производительности по отоплению: размер трубы для жидкости

	Поправочный коэффициент	
	Стандартный размер	Увеличение размера
Охлаждение (трубка для газа)	1,0	
Нагрев (трубка для жидкости)	1,0	0,5

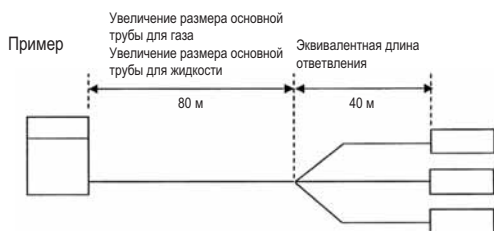

В приведенном выше случае (Охлаждение) Общая эквивалентная длина = 80 м x 1,0 + 40 м = 120 м
(Отопление) Общая эквивалентная длина = 80 м x 0,5 + 40 м = 80 м

Скорость изменения производительности по охлаждению при перепаде высоты = 0 м, таким образом, приблизительно равна 0,83
производительности по отоплению при перепаде высоты = 0 м, таким образом, приблизительно равна 1,0

5 Таблицы производительности

5 - 4 Поправочный коэффициент для производительности

5

RXYQ48T

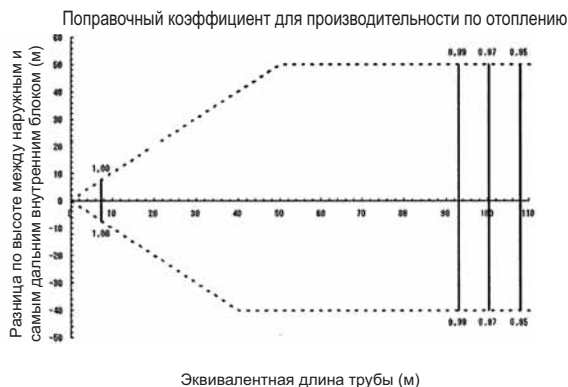
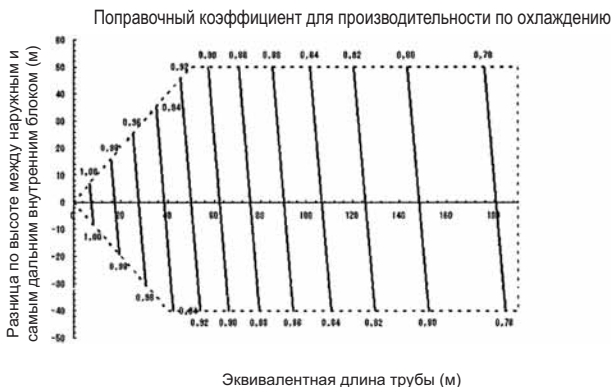

3D079897

ПРИМЕЧАНИЯ

- Эти графики показывают поправочный коэффициент на длину трубы для стандартной системы внутреннего блока при максимальной нагрузке (с установленным на максимум термостатом) при стандартных условиях. Более того, в условиях частичной нагрузки наблюдается лишь незначительное отклонение от поправочного коэффициента производительности, указанного на приведенных выше графиках.
- В этом наружном блоке осуществляется постоянное управление давлением испарения при охлаждении и давлением конденсации - при отоплении.
- Способ расчета производительности наружных блоков**
Максимальная производительность системы будет равна или общей производительности внутренних блоков, или максимальной производительности наружных блоков (как указано ниже), в зависимости от того, какая величина меньше.

Условие: Отношение подключения внутренних блоков не превышает 100%.

$$\text{Максимальная производительность наружных блоков} = \frac{\text{Производительность наружных блоков на основании таблицы с данными для отношения подключения 100\%}}{\text{Поправочный коэффициент для труб до самого дальнего внутреннего блока}}$$

Условие: Отношение подключения внутренних блоков превышает 100%.

$$\text{Максимальная производительность наружных блоков} = \frac{\text{Производительность наружных блоков на основании таблицы с данными для соотношений установок}}{\text{Поправочный коэффициент для труб до самого дальнего внутреннего блока}}$$

- Если разность уровней равна 50 м или больше (см. руководство по установке и документацию к 3D079540 / 3D079543), и эквивалентная длина трубы составляет 90 м или больше, диаметр основных труб для газа и жидкости (наружный блок - разветвительные участки) необходимо увеличить. Новые значения диаметров указаны ниже.

Модель	Газ	Жидкость
48 HP	41,3	22,2

- Если длина трубы после первого набора ответвления для хладагента превышает 40 м, размер трубы между первым и последним наборами ответвления должен быть увеличен (только для внутренних блоков VRV DX; подробная информация приведена в руководстве по установке).
*Допустимые варианты конфигурации системы и правила выполнения различных подключений внутренних блоков приведены в Руководстве по установке системы. Диаметр основных труб (стандартный размер)

Модель	Газ	Жидкость
48 HP	41,3	19,1

- Эквивалентная длина на приведенных выше графиках основана на следующей эквивалентной длине

$$\text{Эквивалентная длина трубы} = \text{Эквивалентная длина основной трубы} \times \text{Поправочный коэффициент} + \text{Эквивалентная длина труб ответвлений}$$

Найдите поправочный коэффициент по следующей таблице. При расчете производительности по охлаждению: размер трубы для газа При расчете производительности по отоплению: размер трубы для жидкости

	Поправочный коэффициент	
	Стандартный размер	Увеличение размера
Охлаждение (трубка для газа)	1,0	0,5
Нагрев (трубка для жидкости)	1,0	0,5

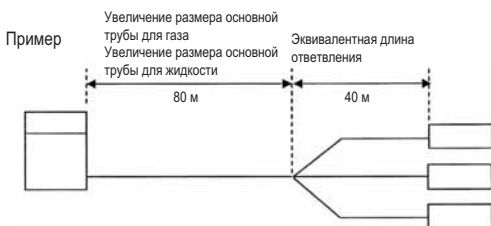

В приведенном выше случае (Охлаждение) Общая эквивалентная длина = 80 м x 1,0 + 40 м = 120 м
(Отопление) Общая эквивалентная длина = 80 м x 0,5 + 40 м = 80 м

Скорость изменения производительности по охлаждению при перепаде высоты = 0 м, таким образом, приблизительно равна 0,83
производительности по отоплению при перепаде высоты = 0 м, таким образом, приблизительно равна 0,97

5 Таблицы производительности

5 - 4 Поправочный коэффициент для производительности

RXYQ50T

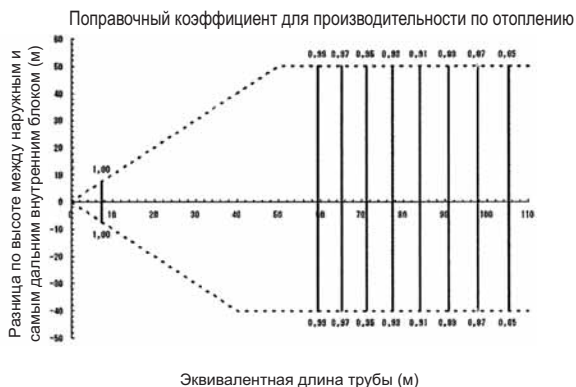

3D079897

ПРИМЕЧАНИЯ

- Эти графики показывают поправочный коэффициент на длину трубы для стандартной системы внутреннего блока при максимальной нагрузке (с установленным на максимум термостатом) при стандартных условиях. Более того, в условиях частичной нагрузки наблюдается лишь незначительное отклонение от поправочного коэффициента производительности, указанного на приведенных выше графиках.

- В этом наружном блоке осуществляется постоянное управление давлением испарения при охлаждении и давлением конденсации - при отоплении.

- Способ расчета производительности наружных блоков

Максимальная производительность системы будет равна или общей производительности внутренних блоков, или максимальной производительности наружных блоков (как указано ниже), в зависимости от того, какая величина меньше.

Условие: Отношение подключения внутренних блоков не превышает 100%.

$$\text{Максимальная производительность наружных блоков} = \text{Производительность наружных блоков на основании таблицы с данными для отношения подключения 100\%} \times \text{Поправочный коэффициент для труб до самого дальнего внутреннего блока}$$

Условие: Отношение подключения внутренних блоков превышает 100%.

$$\text{Максимальная производительность наружных блоков} = \text{Производительность наружных блоков на основании таблицы с данными для соотношений установок} \times \text{Поправочный коэффициент для труб до самого дальнего внутреннего блока}$$

- Если разность уровней равна 50 м или больше (см. руководство по установке и документацию к 3D079540 / 3D079543), и эквивалентная длина трубы составляет 90 м или больше, диаметр основных трубок для газа и жидкости (наружный блок - разветвительные участки) необходимо увеличить. Новые значения диаметров указаны ниже.

Модель	Газ	Жидкость
50 HP	41,3	22,2

- Если длина трубы после первого набора ответвления для хладагента превышает 40 м, размер трубы между первым и последним наборами ответвления должен быть увеличен (только для внутренних блоков VRV DX; подробная информация приведена в руководстве по установке).

*Допустимые варианты конфигурации системы и правила выполнения различных подключений внутренних блоков приведены в Руководстве по установке системы.

Диаметр основных трубок (стандартный размер)

Модель	Газ	Жидкость
50 HP	41,3	19,1

- Эквивалентная длина на приведенных выше графиках основана на следующей эквивалентной длине

$$\text{Эквивалентная длина трубы} = \text{Эквивалентная длина основной трубы} \times \text{Поправочный коэффициент} + \text{Эквивалентная длина трубок ответвлений}$$

Найдите поправочный коэффициент по следующей таблице. При расчете производительности по охлаждению: размер трубы для газа При расчете производительности по отоплению: размер трубы для жидкости

	Поправочный коэффициент	
	Стандартный размер	Увеличение размера
Охлаждение (трубка для газа)	1,0	0,5
Нагрев (трубка для жидкости)	1,0	0,5

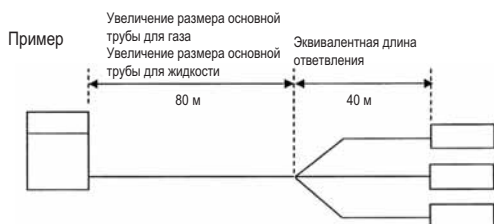

В приведенном выше случае (Охлаждение) Общая эквивалентная длина = 80 м x 1,0 + 40 м = 120 м

(Отопление) Общая эквивалентная длина = 80 м x 0,5 + 40 м = 80 м

Скорость изменения производительности по охлаждению при перепаде высоты = 0 м, таким образом, приблизительно равна 0,83

производительности по отоплению при перепаде высоты = 0 м, таким образом, приблизительно равна 0,92

5 Таблицы производительности

5 - 4 Поправочный коэффициент для производительности

5

RXYQ52

Поправочный коэффициент для производительности по охлаждению



Поправочный коэффициент для производительности по отоплению

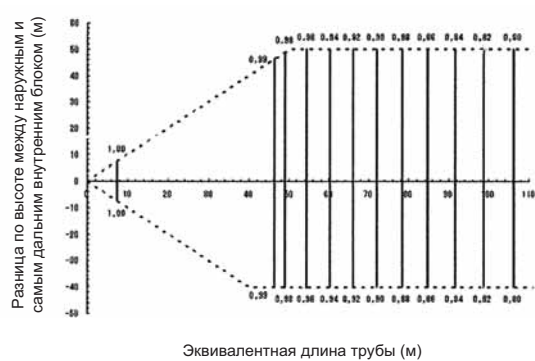

3D079897

ПРИМЕЧАНИЯ

- Эти графики показывают поправочный коэффициент на длину трубы для стандартной системы внутреннего блока при максимальной нагрузке (с установленным на максимум термостатом) при стандартных условиях. Более того, в условиях частичной нагрузки наблюдается лишь незначительное отклонение от поправочного коэффициента производительности, указанного на приведенных выше графиках.
- В этом наружном блоке осуществляется постоянное управление давлением испарения при охлаждении и давлением конденсации - при отоплении.
- Способ расчета производительности наружных блоков**
Максимальная производительность системы будет равна или общей производительности внутренних блоков, или максимальной производительности наружных блоков (как указано ниже), в зависимости от того, какая величина меньше.

Условие: Отношение подключения внутренних блоков не превышает 100%.

$$\text{Максимальная производительность наружных блоков} = \frac{\text{Производительность наружных блоков на основании таблицы с данными для отношения подключения 100\%}}{\text{Поправочный коэффициент для труб до самого дальнего внутреннего блока}}$$

Условие: Отношение подключения внутренних блоков превышает 100%.

$$\text{Максимальная производительность наружных блоков} = \frac{\text{Производительность наружных блоков на основании таблицы с данными для соотношений установок}}{\text{Поправочный коэффициент для труб до самого дальнего внутреннего блока}}$$

- Если разность уровней равна 50 м или больше (см. руководство по установке и документацию к 3D079540 / 3D079543), и эквивалентная длина трубы составляет 90 м или больше, диаметр основных труб для газа и жидкости (наружный блок - разветвительные участки) необходимо увеличить. Новые значения диаметров указаны ниже.

Модель	Газ	Жидкость
52 HP	41,3	22,2

- Если длина трубы после первого набора ответвления для хладагента превышает 40 м, размер трубы между первым и последним наборами ответвления должен быть увеличен (только для внутренних блоков VRV DX; подробная информация приведена в руководстве по установке).

*Допустимые варианты конфигурации системы и правила выполнения различных подключений внутренних блоков приведены в Руководстве по установке системы. Диаметр основных труб (стандартный размер)

Модель	Газ	Жидкость
52 HP	41,3	19,1

- Эквивалентная длина на приведенных выше графиках основана на следующей эквивалентной длине

$$\text{Эквивалентная длина трубы} = \frac{\text{Эквивалентная длина основной трубы}}{\text{Поправочный коэффициент}} + \text{Эквивалентная длина трубок ответвлений}$$

Найдите поправочный коэффициент по следующей таблице. При расчете производительности по охлаждению: размер трубы для газа При расчете производительности по отоплению: размер трубы для жидкости

	Поправочный коэффициент	
	Стандартный размер	Увеличение размера
Охлаждение (трубка для газа)	1,0	0,5
Нагрев (трубка для жидкости)	1,0	

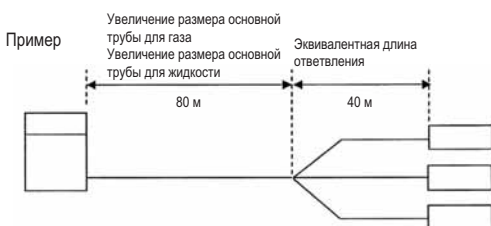

В приведенном выше случае (Охлаждение) Общая эквивалентная длина = 80 м x 1,0 + 40 м = 120 м
(Отопление) Общая эквивалентная длина = 80 м x 0,5 + 40 м = 80 м

Скорость изменения производительности по охлаждению при перепаде высоты = 0 м, таким образом, приблизительно равна 0,83
производительности по отоплению при перепаде высоты = 0 м, таким образом, приблизительно равна 0,88

5 Таблицы производительности

5 - 4 Поправочный коэффициент для производительности

RXYQ54T



Эквивалентная длина трубы (м)

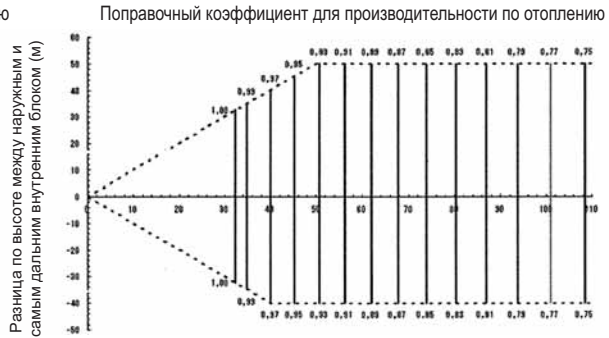

Эквивалентная длина трубы (м)

3D079897

ПРИМЕЧАНИЯ

- Эти графики показывают поправочный коэффициент на длину трубы для стандартной системы внутреннего блока при максимальной нагрузке (с установленным на максимум термостатом) при стандартных условиях. Более того, в условиях частичной нагрузки наблюдается лишь незначительное отклонение от поправочного коэффициента производительности, указанного на приведенных выше графиках.
- В этом наружном блоке осуществляется постоянное управление давлением испарения при охлаждении и давлением конденсации - при отоплении.

Способ расчета производительности наружных блоков

Максимальная производительность системы будет равна или общей производительности внутренних блоков, или максимальной производительности наружных блоков (как указано ниже), в зависимости от того, какая величина меньше.

Условие: Отношение подключения внутренних блоков не превышает 100%.

$$\text{Максимальная производительность наружных блоков} = \frac{\text{Производительность наружных блоков на основании таблицы с данными для отношения подключения 100\%}}{\text{Поправочный коэффициент для труб до самого дальнего внутреннего блока}}$$

Условие: Отношение подключения внутренних блоков превышает 100%.

$$\text{Максимальная производительность наружных блоков} = \frac{\text{Производительность наружных блоков на основании таблицы с данными для соотношений установок}}{\text{Поправочный коэффициент для труб до самого дальнего внутреннего блока}}$$

- Если разность уровней равна 50 м или больше (см. руководство по установке и документацию к 3D079540 / 3D079543), и эквивалентная длина трубы составляет 90 м или больше, диаметр основных трубок для газа и жидкости (наружный блок - разветвительные участки) необходимо увеличить. Новые значения диаметров указаны ниже.

Модель	Газ	Жидкость
54 HP	41,3	22,2

- Если длина трубы после первого набора ответвления для хладагента превышает 40 м, размер трубы между первым и последним наборами ответвления должен быть увеличен (только для внутренних блоков VRV DX; подробная информация приведена в руководстве по установке).

*Допустимые варианты конфигурации системы и правила выполнения различных подключений внутренних блоков приведены в Руководстве по установке системы.

Диаметр основных трубок (стандартный размер)

Модель	Газ	Жидкость
54 HP	41,3	19,1

- Эквивалентная длина на приведенных выше графиках основана на следующей эквивалентной длине

$$\text{Эквивалентная длина трубы} = \frac{\text{Эквивалентная длина основной трубы}}{\text{Поправочный коэффициент}} + \text{Эквивалентная длина трубок ответвлений}$$

Найдите поправочный коэффициент по следующей таблице. При расчете производительности по охлаждению: размер трубы для газа При расчете производительности по отоплению: размер трубы для жидкости

	Поправочный коэффициент	
	Стандартный размер	Увеличение размера
Охлаждение (трубка для газа)	1,0	0,5
Нагрев (трубка для жидкости)	1,0	0,5

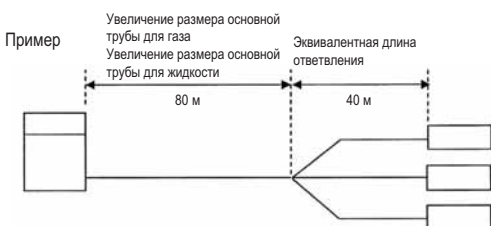

В приведенном выше случае (Охлаждение) Общая эквивалентная длина = 80 м x 1,0 + 40 м = 120 м
(Отопление) Общая эквивалентная длина = 80 м x 0,5 + 40 м = 80 м

Скорость изменения производительности по охлаждению при перепаде высоты = 0 м, таким образом, приблизительно равна 0,83
производительности по отоплению при перепаде высоты = 0 м, таким образом, приблизительно равна 0,83

6 Размерные чертежи

6 - 1 Размерные чертежи

6

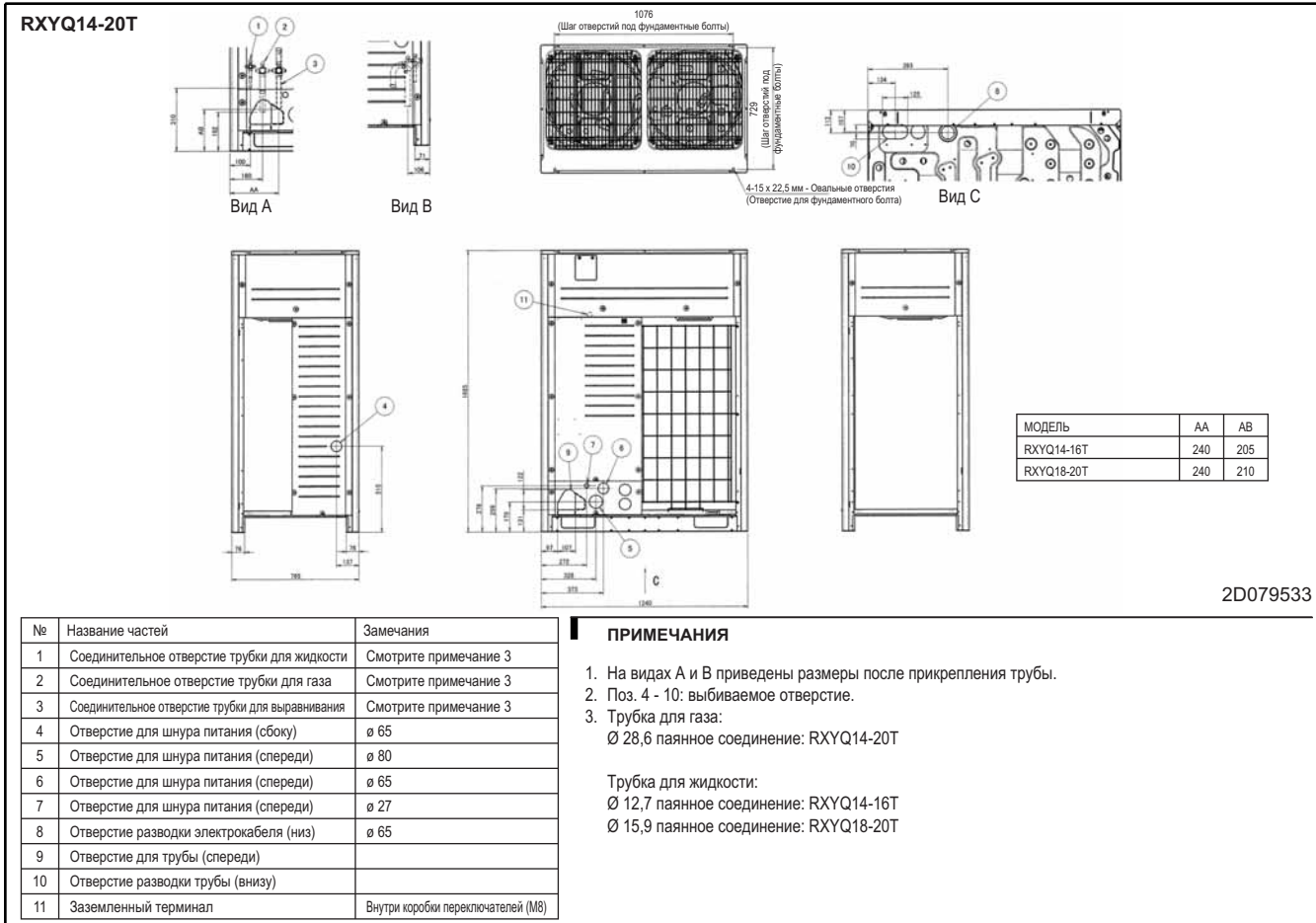
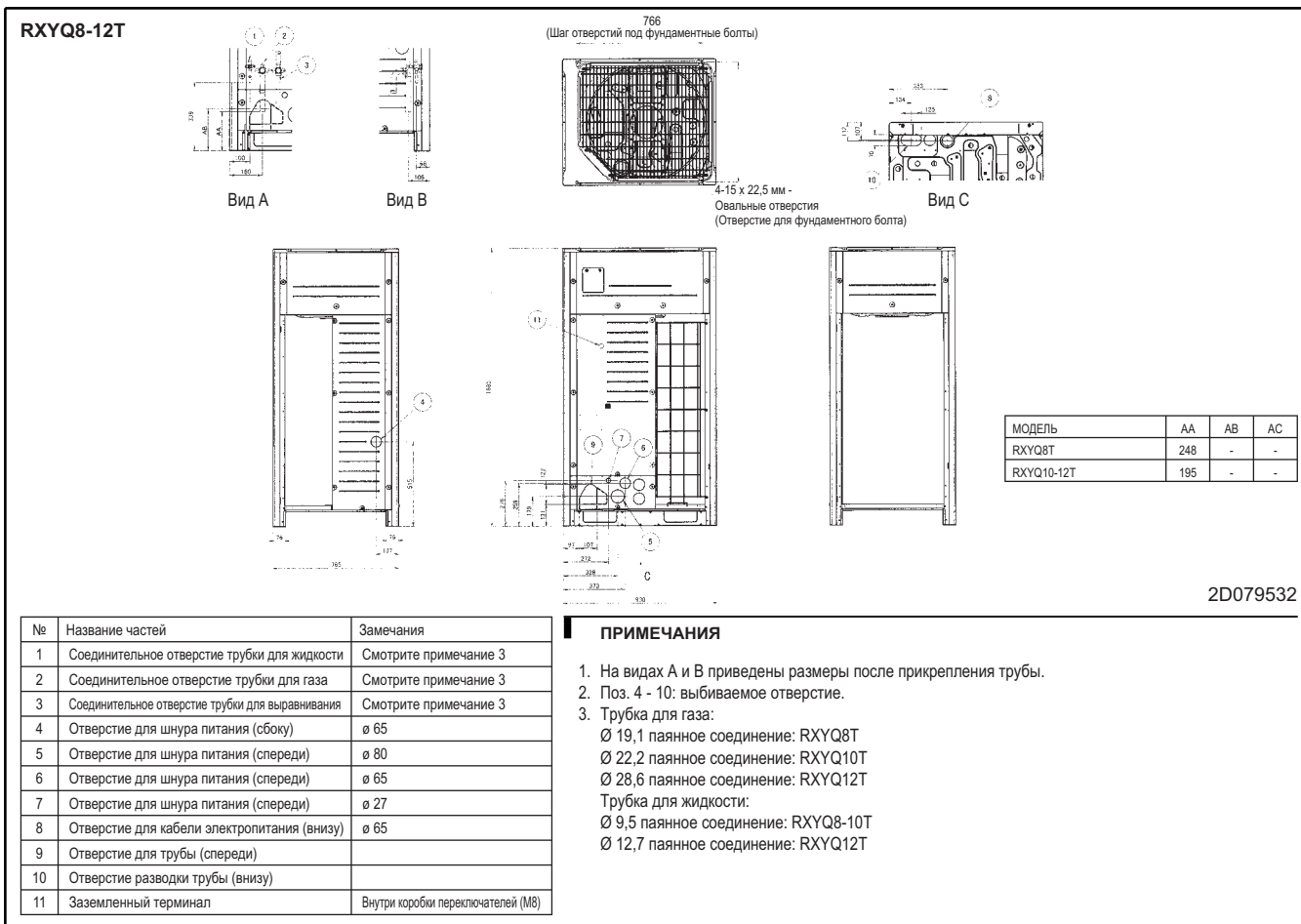

7 Центр тяжести

7 - 1 Центр тяжести

RXYQ8-12T

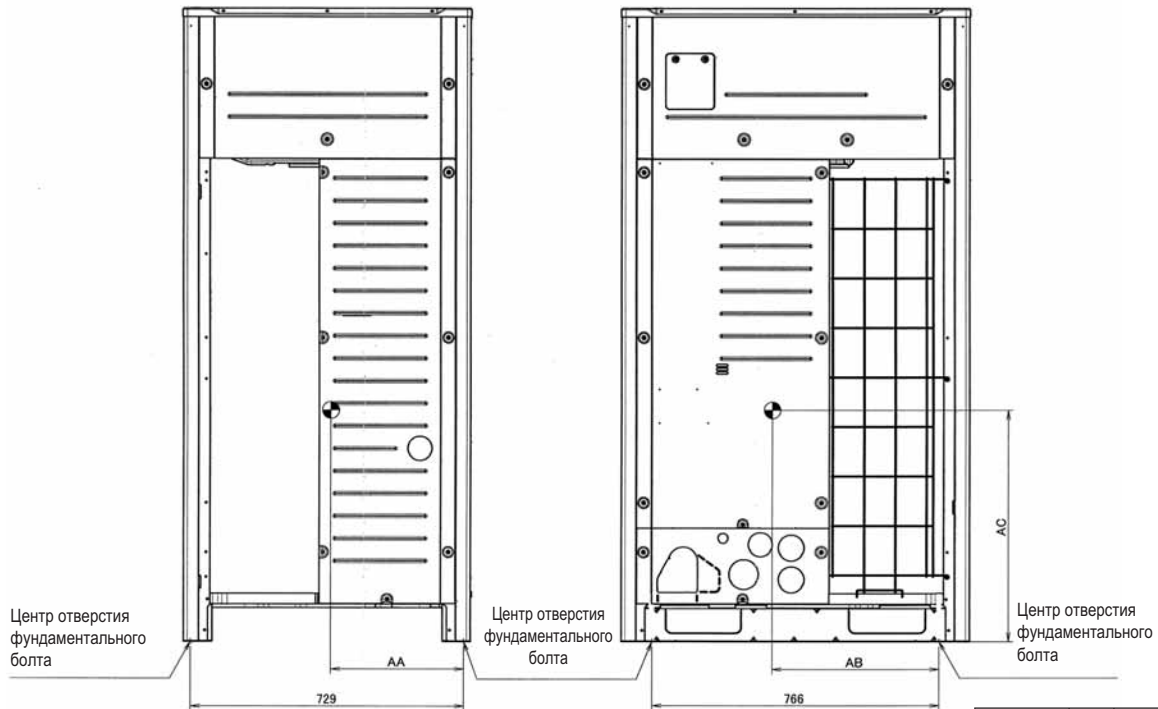

Блок	AA	AB	AC
RXYQ8-12T	339	448	565

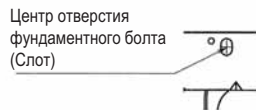

3D079582

RXYQ14-20T

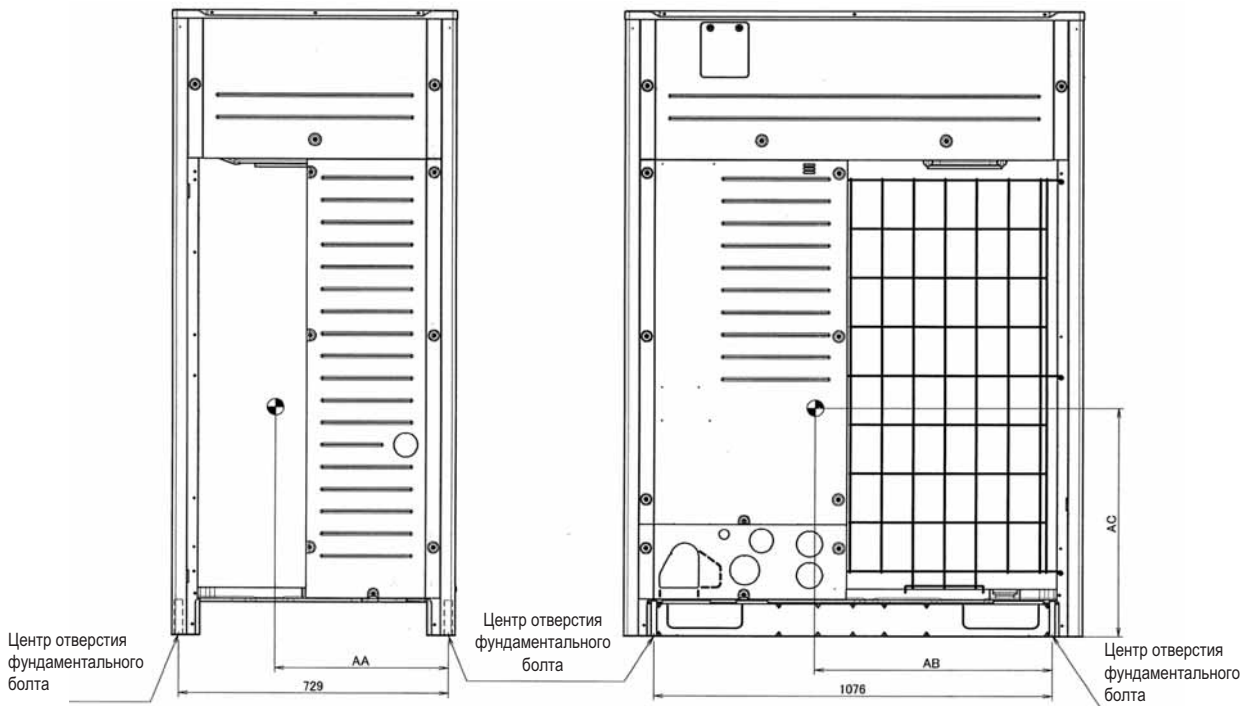

Блок	AA	AB	AC
RXYQ14-16T	TCB	TCB	TCB
RXYQ18-20T	TCB	TCB	TCB

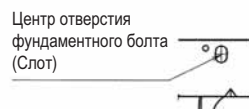
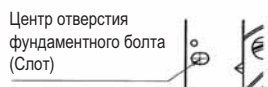

3D079583

8 Схемы трубопроводов

8 - 1 Схемы трубопроводов

RXYQ8-12T

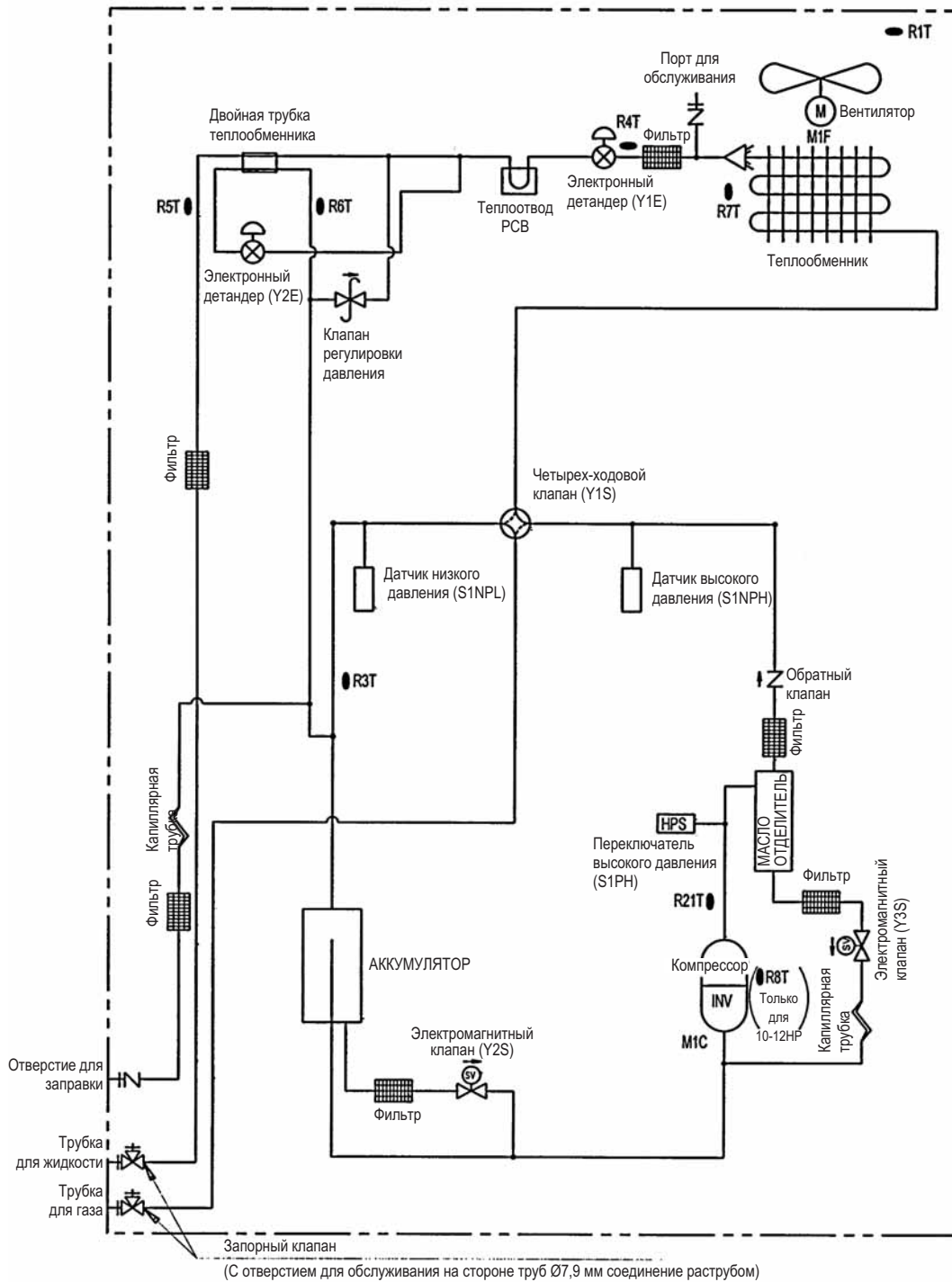

3D079556

8 Схемы трубопроводов

8 - 1 Схемы трубопроводов

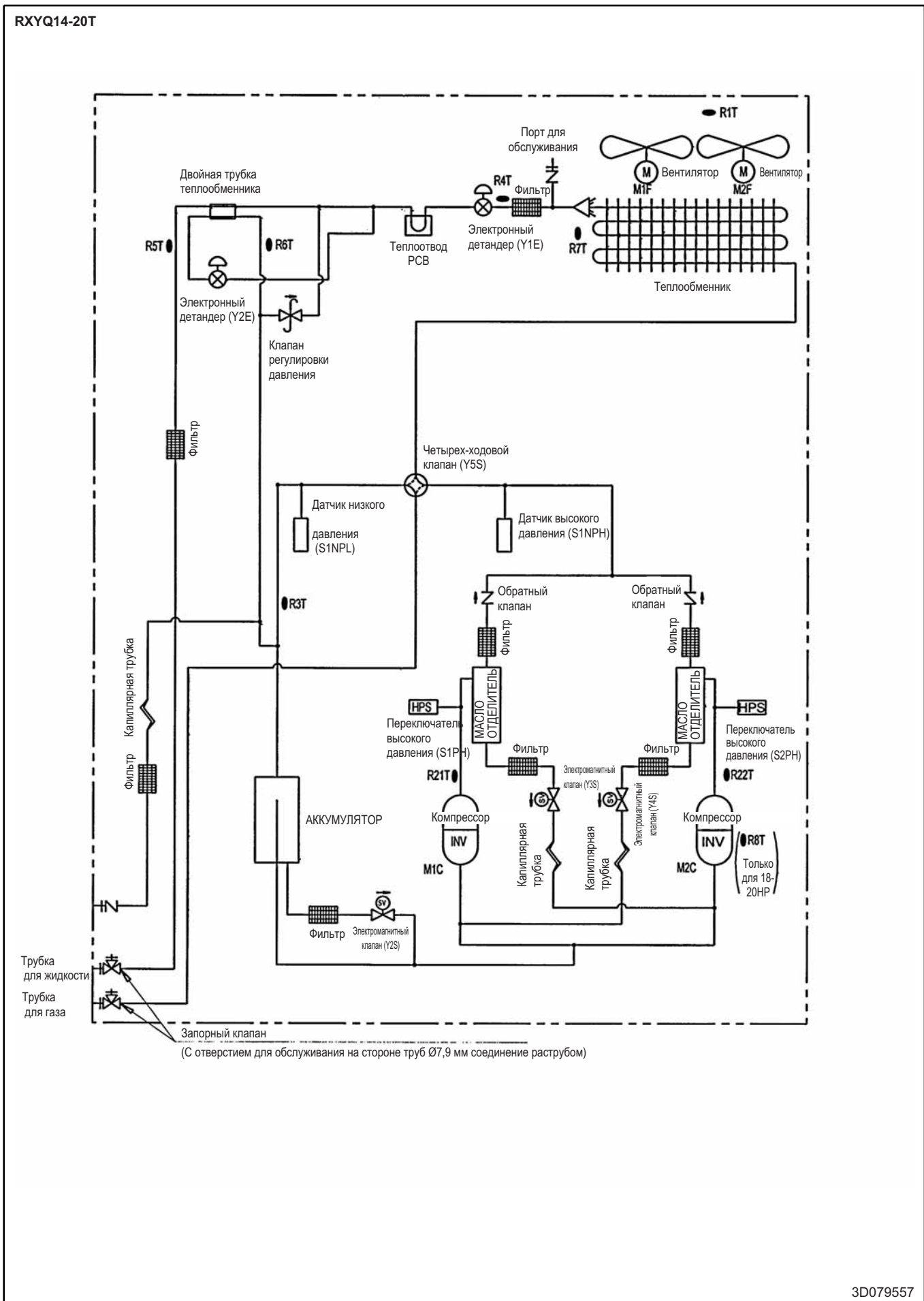

9 Монтажные схемы

9 - 1 Монтажные схемы - Три фазы

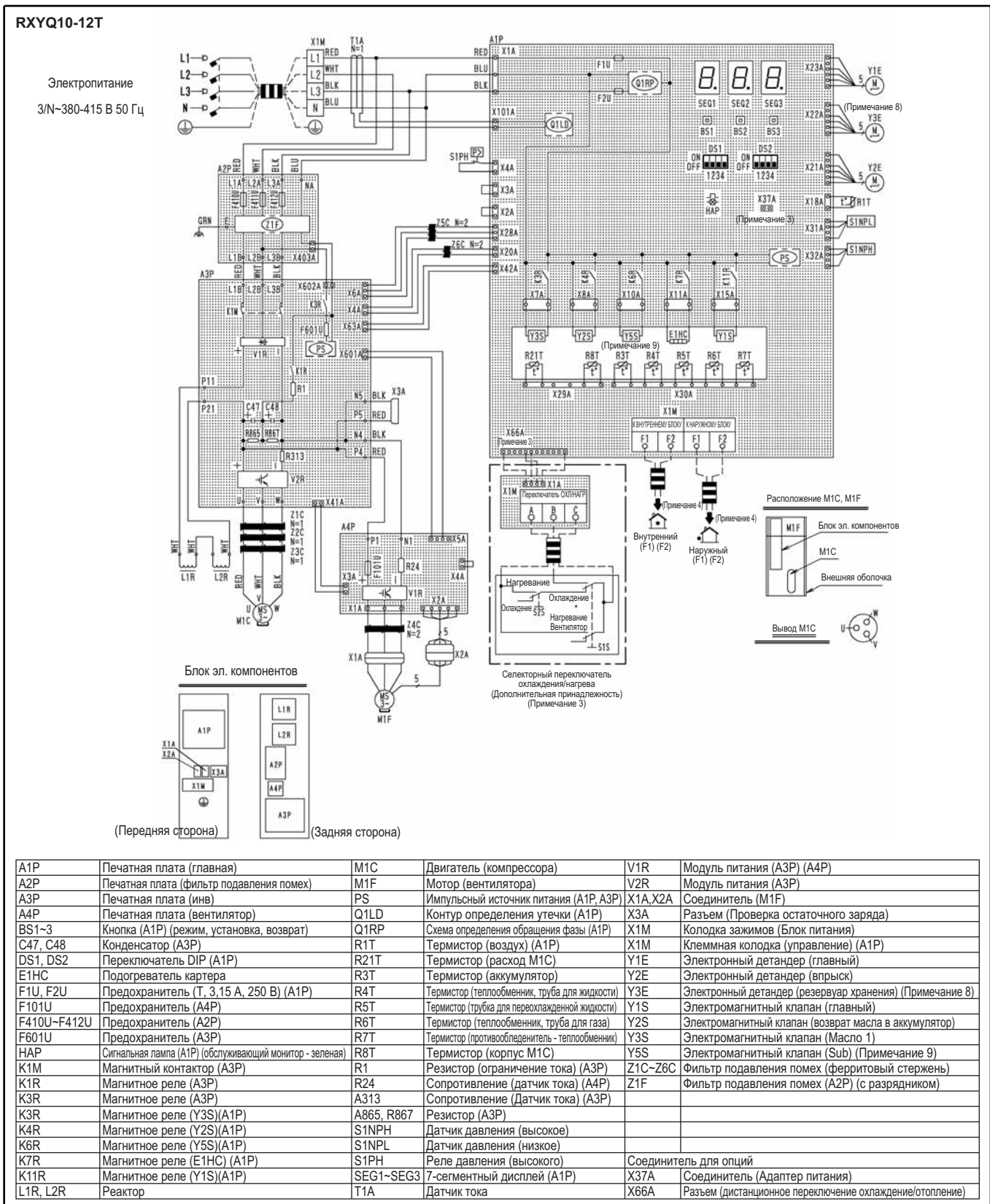

ПРИМЕЧАНИЯ

- Эта схема электропроводки относится к наружному блоку
- : проводка на месте □□□□: колодка зажимов □□□□: соединитель —●—: клемма ⊕: защитное заземление (винт)
- При использовании дополнительного адаптера обратитесь к руководству по его установке.
- Обратитесь к руководству по установке для получения информации о схеме проводки внутренне-наружной передачи F1 - F2, наружно-наружной передачи F1 • F2.
- Порядок использования переключателя B1S-3 указан на табличке "меры предосторожности при обслуживании" на крышке блока эл. комп.
- При работе не замыкайте защитное устройство (S1PH).
- Цвета BLK: Черный, RED: Красный, BLU: Синий, WHT: Белый, GRN: Зеленый.
- Только для модели RYYQ
- Только для модели RYYQ/RYMQ.

3D079048D

9 Монтажные схемы

9 - 1 Монтажные схемы - Три фазы

RXYQ14-16T

Электропитание
3/N-380-415 В 50 Гц

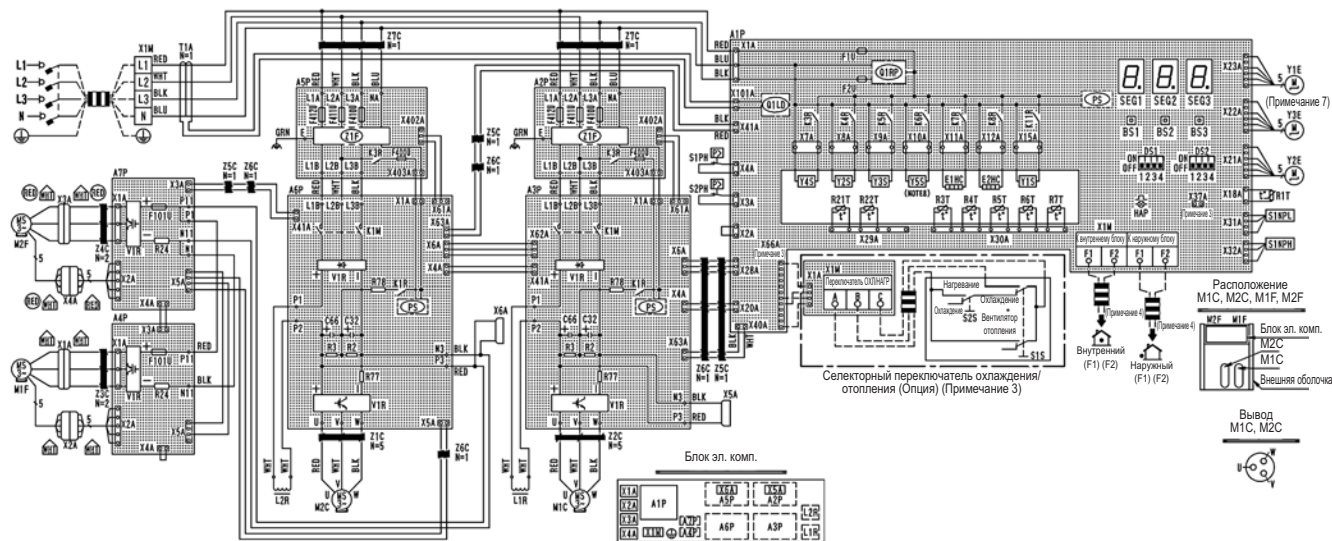

(Цвета) RED: Красный, WHT: Белый, BLK: Черный, BLU: Синий, GRN: Зеленый
 ● : * - цвет соединителя для компонента.
 ● : * Цвет соединителя для провода компонента.

A1P	Печатная плата (главная)	K11R	Магнитное реле (Y1S)(A1P)	T1A	Датчик тока
A2P, A5P	Печатная плата (Фильтр подавления помех)	L1R, L2R	Реактор	V1R	Модуль питания (A3P, A6P)
A3P, A6P	Печатная плата (инв)	M1C, M2C	Двигатель (компрессора)	V1R	Модуль питания (A4P, A7P)
A4P, A7P	Печатная плата (вентилятор)	M1F, M2F	Мотор (вентилятора)	X1A-4A	Соединитель (M1F, M2F)
BS1-3	Кнопка (A1P) (режим, установка, возврат)	PS	Импульсный источник питания (A1P, A3P, A6P)	X5A, X6A	Разъем (Проверка остаточного заряда)
C32, C66	Конденсатор (A3P, A6P)	Q1LD	Контур определения утечки (A1P)	X1M	Колодка зажимов (Блок питания)
DS1, DS2	Переключатель DIP (A1P)	Q1RP	Схема определения обращения фазы (A1P)	X1M	Клемная колодка (управление) (A1P)
E1HC, E2HC	Подогреватель картера	R2, R3	Резистор (A3P, A6P)	Y1E	Электронный детандер (главный)
F1U, F2U	Предохранитель (Т, 3, 15 А, 250 В) (A1P)	R24	Резистор (Датчик тока) (A4P, A7P)	Y2E	Электронный детандер (впрыск)
F101U	Предохранитель (A4P, A7P)	R77	Резистор (Датчик тока) (A3P, A6P)	Y3E	Электронный детандер (резервуар хранения) (Примечание 7)
F400U	Предохранитель (A2P, A5P)	R78	Резистор (Ограничение тока) (A3P, A6P)	Y1S	Электромагнитный клапан (Главный)
F410U-F412U	Предохранитель (A2P, A5P)	R1T	Термистор (Воздух) (A1P)	Y2S	Электромагнитный клапан (Возврат масла в аккумулятор)
HAP	Сигнальная лампа (A1P) (обслуживающий монитор - зеленая)	R21T, R22T	Термистор (расход M1C, M2C)	Y3S	Электромагнитный клапан (Масло 1)
K1M	Магнитный контактор (A3P, A6P)	R3T	Термистор (Аккумулятор)	Y4S	Электромагнитный клапан (Масло 2)
K1R	Магнитное реле (A3P, A6P)	R4T	Термистор (Теплообменник, труба для жидкости)	Y5S	Электромагнитный клапан (Sub) (Примечание 8)
K3R	Магнитное реле (A2P, A5P)	R5T	Термистор (Трубка для переохлажденной жидкости)	Z1C-Z7C	Фильтр подавления помех (ферритовый стержень)
K3R	Магнитное реле (Y3S)(A1P)	R6T	Термистор (Теплообменник, труба для газа)	Z1F	Фильтр подавления помех (A2P, A5P) (С разрядником)
K4R	Магнитное реле (Y2S)(A1P)	R7T	Термистор (противообледенитель - теплообменник)		
K5R	Магнитное реле (Y4S) (A1P)	S1NPH	Датчик давления (высокое)		
K6R	Магнитное реле (Y5S)(A1P)	S1NPL	Датчик давления (низкое)		
K7R	Магнитное реле (E1HC) (A1P)	S1PH, S2PH	Реле давления (высокого)		Соединитель для опций
K8R	Магнитное реле (E2HC) (A1P)	SEG1-SEG3	7-сегментный дисплей (A1P)	X37A	Соединитель (Адаптер питания)
				X66A	Разъем (дистанционное переключение охлаждения/отопление)

ПРИМЕЧАНИЯ

- Эта схема электропроводки относится только к наружному блоку
- : проводка на месте □ □ □ □ : колодка зажимов □ □ □ : соединитель — ● : клемма ⊕ : защитное заземление (винт),
- При использовании дополнительного адаптера обратитесь к руководству по его установке.
- Обратитесь к руководству по установке для получения информации о схеме проводки внутренне-наружной передачи F1 ● F2, наружно-наружной передачи F1 ● F2.
- Порядок использования переключателя B1S-3 указан на табличке "меры предосторожности при обслуживании" на крышке блока эл. комп.
- При работе не замыкайте защитное устройство (S1PH, S2PH).
- Только для модели RYYQ
- Только для модели RYYQ/RYMQ.

9 Монтажные схемы

9 - 1 Монтажные схемы - Три фазы

RXYQ18-20T

Электропитание

3/N-380-415 В 50 Гц

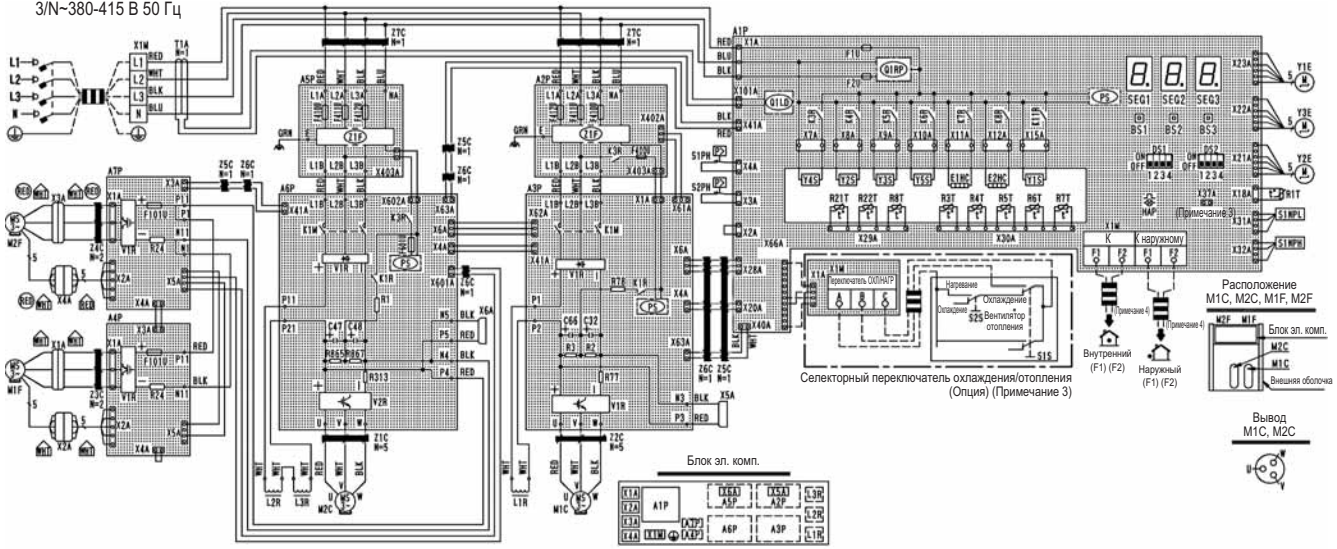

(Цвета) RED: Красный, WHT: Белый, BLK: Черный, BLU: Синий, GRN: Зеленый;
 * - цвет соединителя для компонента.
 * - цвет соединителя для провода компонента.

A1P	Печатная плата (главная)	L1R-L3R	Реактор	T1A	Датчик тока
A2P, A5P	Печатная плата (Фильтр подавления помех)	M1C, M2C	Двигатель (компрессора)	V1R	Модуль питания (A3P, A6P)
A3P, A6P	Печатная плата (инв)	M1F, M2F	Мотор (вентилятора)	V1R	Модуль питания (A4P, A7P)
A4P, A7P	Печатная плата (вентилятор)	PS	Импульсный источник питания (A1P, A3P, A6P)	V2R	Модуль питания (A6P)
BS1-3	Кнопка (A1P) (режим, установка, возврат)	Q1LD	Контур определения утечки (A1P)	X1A-4A	Соединитель (M1F, M2F)
C32, C66	Конденсатор (A3P)	R1RP	Схема определения обращения фазы (A1P)	X5A, X6A	Разъем (Проверка остаточного заряда)
C47, C48	Конденсатор (A6P)	R1	Резистор (Ограничение тока) (A6P)	X1M	Колодка зажимов (Блок питания)
DS1, DS2	Переключатель DIP (A1P)	R2, R3	Резистор (A3P)	X1M	Клеммная колодка (Управление) (A1P)
E1HC, E2HC	Подогреватель картера	R24	Резистор (Датчик тока) (A4P, A7P)	Y1E	Электронный детандер (главный)
F1U, F2U	Предохранитель (Т, 3, 15 А, 250 В) (A1P)	R77	Соппротивление (Датчик тока) (A3P)	Y2E	Электронный детандер (впрыск)
F101U	Предохранитель (A4P, A7P)	R78	Резистор (ограничение тока) (A3P)	Y3E	Электронный детандер (резервуар хранения) (Примечание 7)
F400U	Предохранитель (A2P)	R313	Резистор (Датчик тока) (A6P)	Y1S	Электромагнитный клапан (Главный)
F410U-F412U	Предохранитель (A2P, A5P)	R865, R867	Резистор (A6P)	Y2S	Электромагнитный клапан (Возврат масла в аккумулятор)
F601U	Предохранитель (A6P)	R1T	Термистор (Воздух) (A1P)	Y3S	Электромагнитный клапан (Масло 1)
HAP	Сигнальная лампа (A1P) (обслуживающий монитор - зеленая)	R21T, R22T	Термистор (расход M1C, M2C)	Y4S	Электромагнитный клапан (Масло 2)
K1M	Магнитный контактор (A3P, A6P)	R3T	Термистор (Аккумулятор)	Y5S	Электромагнитный клапан (Sub) (Примечание 8)
K1R	Магнитное реле (A3P, A6P)	R4T	Термистор (Теплообменник, труба для жидкости)	Z1C-Z7C	Фильтр подавления помех (ферритовый стержень)
K3R	Магнитное реле (A2P, A6P)	R5T	Термистор (Труба для переохлажденной жидкости)	Z1F	Фильтр подавления помех (A2P, A5P) (С разрядником)
K3R	Магнитное реле (Y3S)(A1P)	R6T	Термистор (Теплообменник, труба для газа)		
K4R	Магнитное реле (Y2S)(A1P)	R7T	Термистор (противообледенитель - теплообменник)		
K5R	Магнитное реле (Y4S) (A1P)	R8T	Термистор (корпус M2C)		
K6R	Магнитное реле (Y5S)(A1P)	S1NPH	Датчик давления (высокое)		
K7R	Магнитное реле (E1HC) (A1P)	S1NPL	Датчик давления (низкое)		Соединитель для опций
K8R	Магнитное реле (E2HC) (A1P)	S1PH, S2PH	Реле давления (высокого)	X37A	Соединитель (Адаптер питания)
K11R	Магнитное реле (Y1S)(A1P)	SEG1-SEG3	7-сегментный дисплей (A1P)	X66A	Разъем (Дистанционное переключение охлаждение/отопление)

ПРИМЕЧАНИЯ

- Эта схема электропроводки относится только к наружному блоку.
- : проводка на месте □ □ □ □ : колодка зажимов □ □ □ □ : соединитель — ● — : клемма ⊕ : защитное заземление (винт),
- При использовании дополнительного адаптера обратитесь к руководству по его установке.
- Обратитесь к руководству по установке для получения информации о схеме проводки внутренне-наружной передачи F1 ● F2, наружно-наружной передачи F1 ● F2.
- Порядок использования переключателя B1S-3 указан на табличке "меры предосторожности при обслуживании" на крышке блока эл. комп.
- При работе не замыкайте защитное устройство (S1PH, S2PH).
- Только для модели RYYQ.
- Только для модели RYYQ/RYMQ.

10 Схемы внешних соединений

10 - 1 Схемы внешних соединений

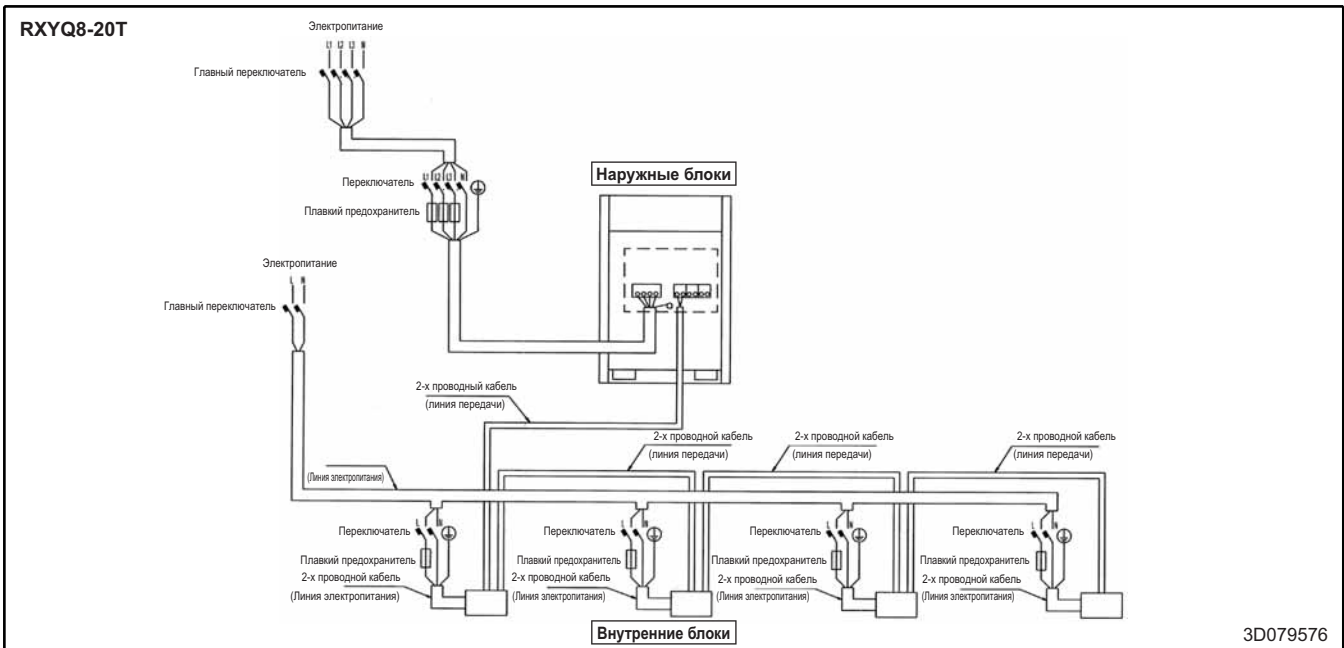

3D079576

ПРИМЕЧАНИЯ

1. Вся проводка, компоненты и материалы, которые используются, должны удовлетворять национальным и местным стандартам.
2. Используйте только медные проводники.
3. Подробные сведения указаны на схеме электропроводки.
4. В качестве предосторожности установить прерыватель контура.
5. Вся внешняя проводка и компоненты должны быть выполнены специально обученным электриком.
6. Блок должен быть заземлен в соответствии с применяемыми местными и национальными правилами.
7. В электропроводке показаны основные точки соединения, а не все детали данной установки.
8. Убедитесь, что переключатель и предохранитель установлены в линии электропитания каждого компонента оборудования.
9. Установите основной выключатель, который мог бы прервать подачу электроэнергии от всех источников питания, так как в системе имеются несколько источников питания.
10. Если имеется возможность возникновения обратной фазы, потерянной фазы, нарушения подачи электроэнергии при работе продукта, надо подключить контур локальной защиты от обратной связи. Запуск продукта с обратной фазой может нарушить работу компрессора и других частей.
11. Необходимо установить прерыватель в цепи утечки на землю.

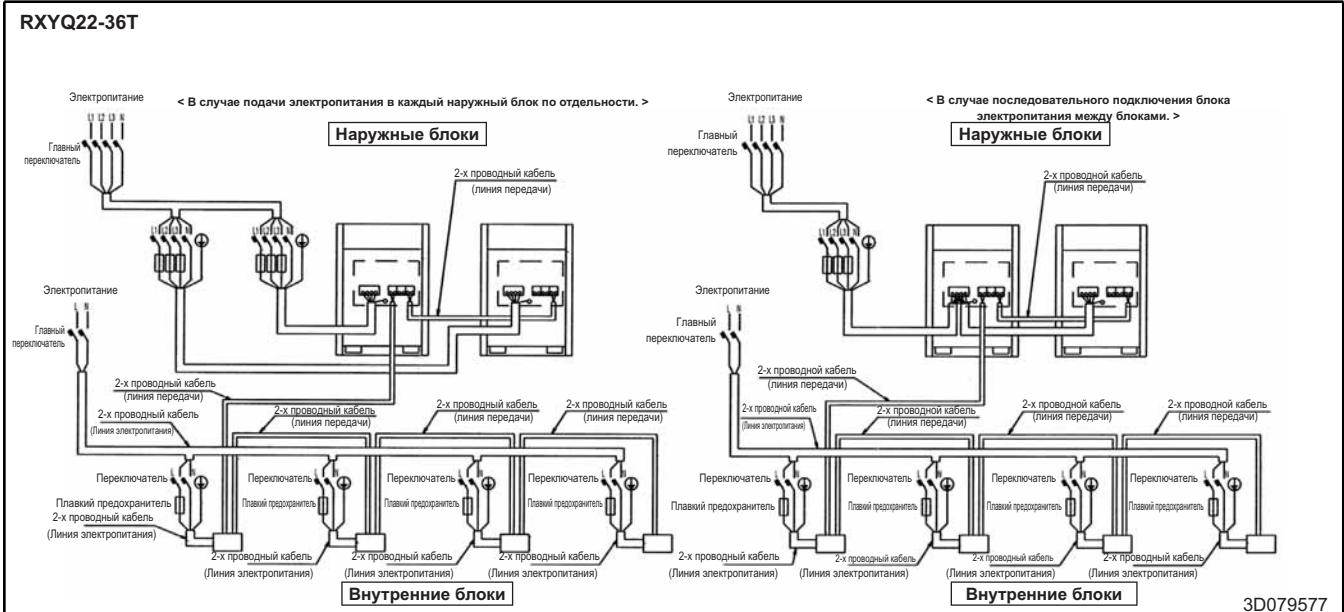

3D079577

ПРИМЕЧАНИЯ

1. Вся проводка, компоненты и материалы, которые используются, должны удовлетворять национальным и местным стандартам.
2. Используйте только медные проводники.
3. Подробные сведения указаны на схеме электропроводки.
4. В качестве предосторожности установить прерыватель контура.
5. Вся внешняя проводка и компоненты должны быть выполнены специально обученным электриком.
6. Блок должен быть заземлен в соответствии с применяемыми местными и национальными правилами.
7. В электропроводке показаны основные точки соединения, а не все детали данной установки.
8. Убедитесь, что переключатель и предохранитель установлены в линии электропитания каждого компонента оборудования.
9. Установите основной выключатель, который мог бы прервать подачу электроэнергии от всех источников питания, так как в системе имеются несколько источников питания.
10. При последовательном подключении источника питания между блоками производительность БЛОКА 1 должна быть выше производительности БЛОКА 2.
11. Если имеется возможность возникновения обратной фазы, потерянной фазы, нарушения подачи электроэнергии при работе продукта, надо подключить контур локальной защиты от обратной связи. Запуск продукта с обратной фазой может нарушить работу компрессора и других частей.
12. Необходимо установить прерыватель в цепи утечки на землю.

10 Схемы внешних соединений

10 - 1 Схемы внешних соединений

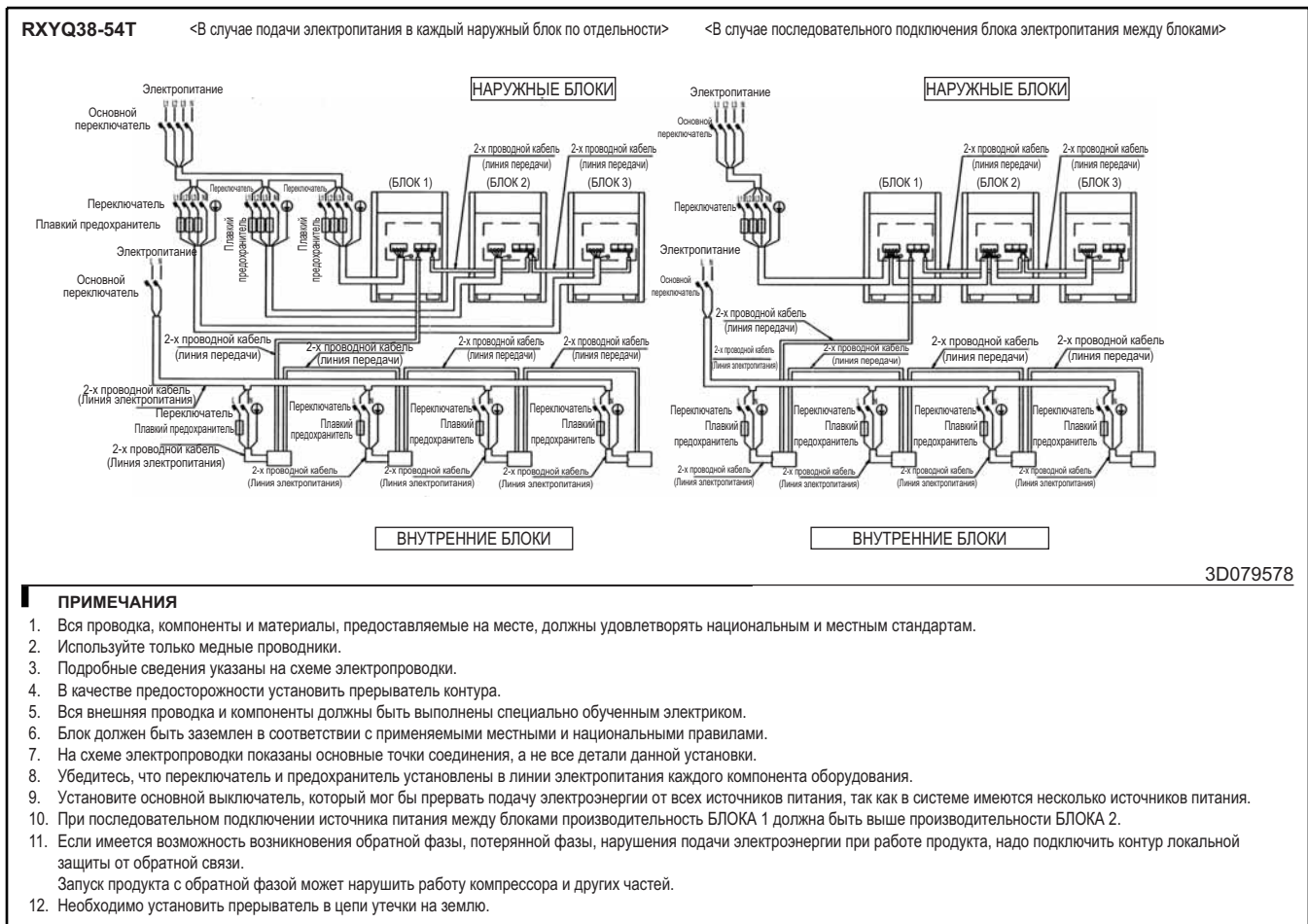

11 Данные об уровне шума

11 - 1 Спектр звуковой мощности

11

RXYQ8T

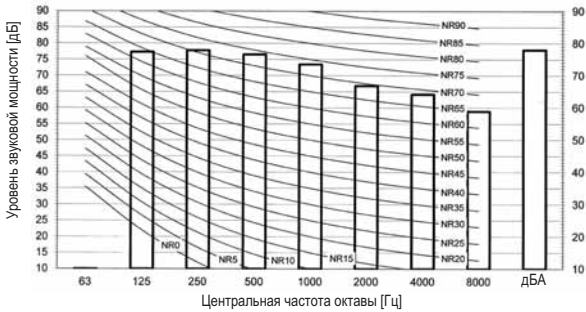

3D079537

ПРИМЕЧАНИЯ

1. дБА = A-взвешенный уровень мощности звука (шкала A согласно IEC)
2. Базовая интенсивность звука 0 дБ = 10E-6 мкВт/м²
3. Измерено согласно ISO 3744

RXYQ10T

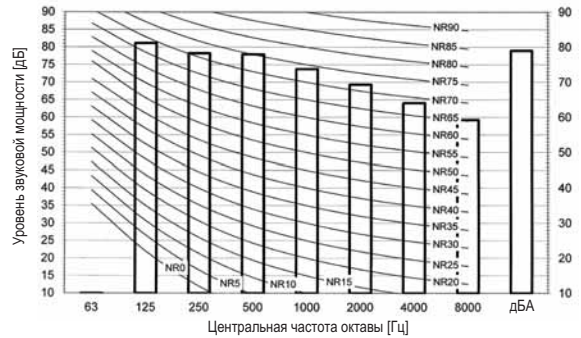

3D079908

ПРИМЕЧАНИЯ

1. дБА = A-взвешенный уровень мощности звука (шкала A согласно IEC)
2. Базовая интенсивность звука 0 дБ = 10E-6 мкВт/м²
3. Измерено согласно ISO 3744

RXYQ12T

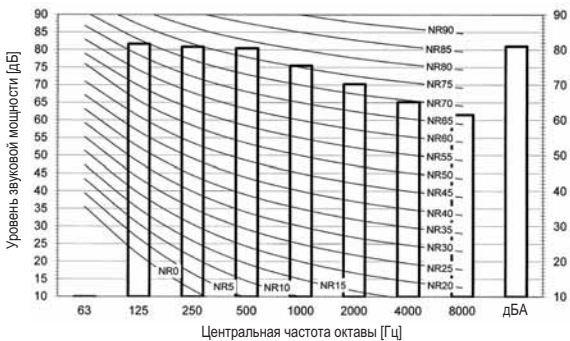

3D079909

ПРИМЕЧАНИЯ

1. дБА = A-взвешенный уровень мощности звука (шкала A согласно IEC)
2. Базовая интенсивность звука 0 дБ = 10E-6 мкВт/м²
3. Измерено согласно ISO 3744

RXYQ14T

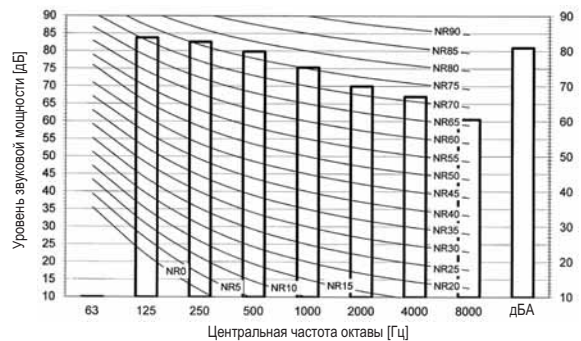

3D079910

ПРИМЕЧАНИЯ

1. дБА = A-взвешенный уровень мощности звука (шкала A согласно IEC)
2. Базовая интенсивность звука 0 дБ = 10E-6 мкВт/м²
3. Измерено согласно ISO 3744

11 Данные об уровне шума

11 - 1 Спектр звуковой мощности

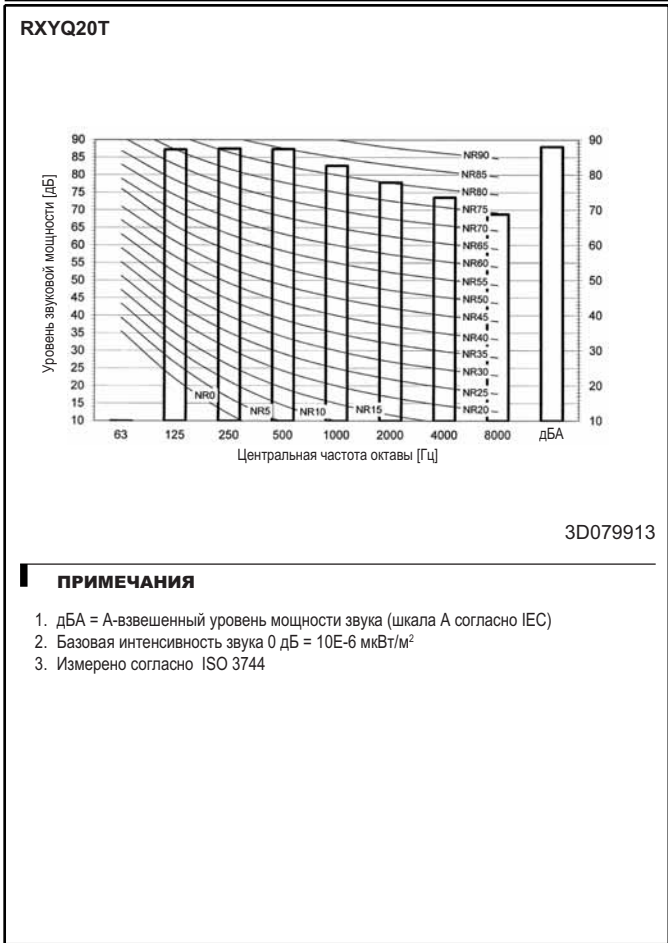
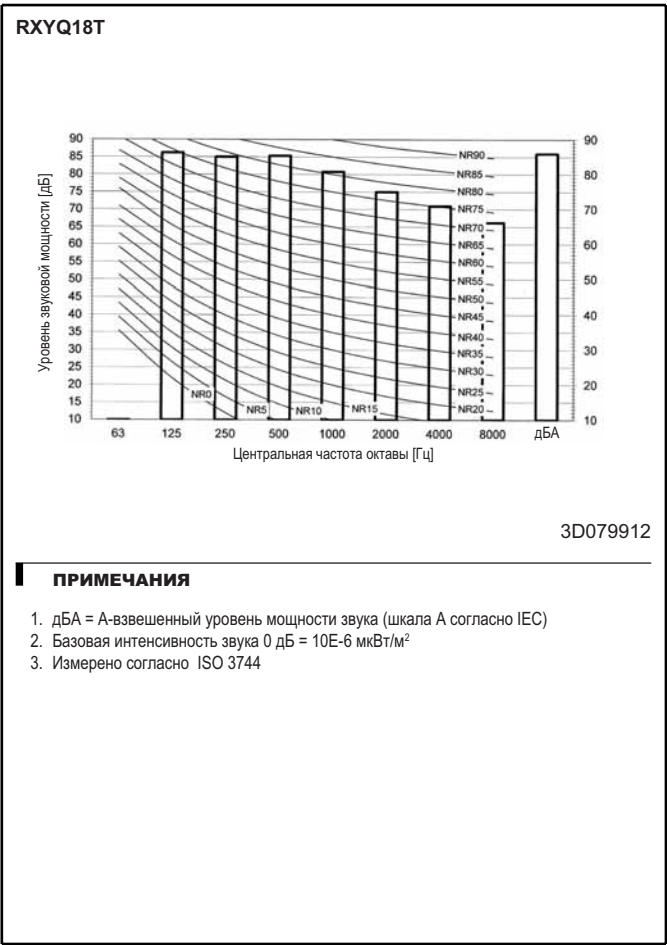
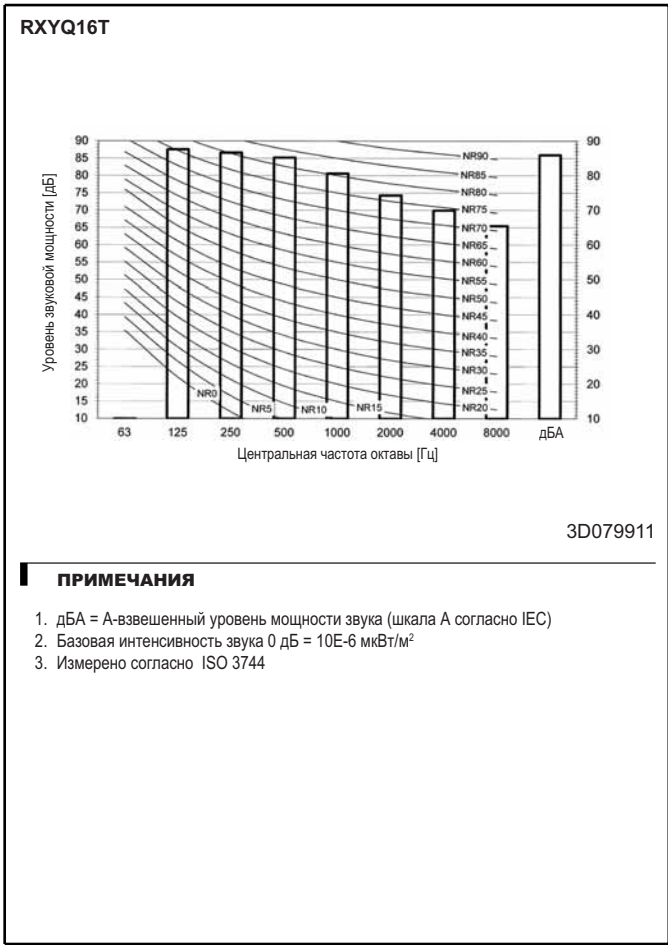

11 Данные об уровне шума

11 - 2 Спектр звукового давления

11

RXYQ8T

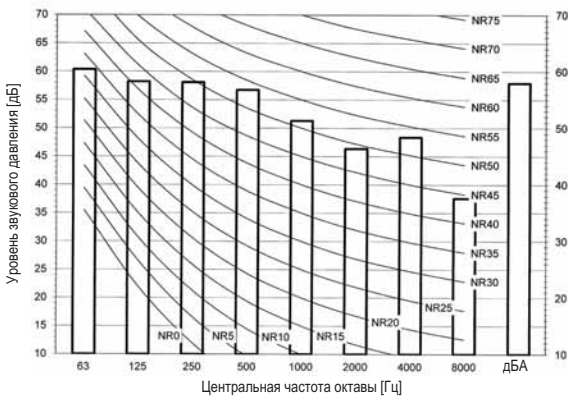

3D079536

ПРИМЕЧАНИЯ

1. Данные верны при свободных полевых условиях
2. Данные верны при номинальных условиях эксплуатации
3. дБА = A-взвешенный уровень давления звука (шкала A согласно IEC)
4. Базовое звуковое давление 0 дБ = 20 мкПа
5. Позиция измерения.

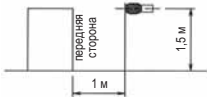

RXYQ10T

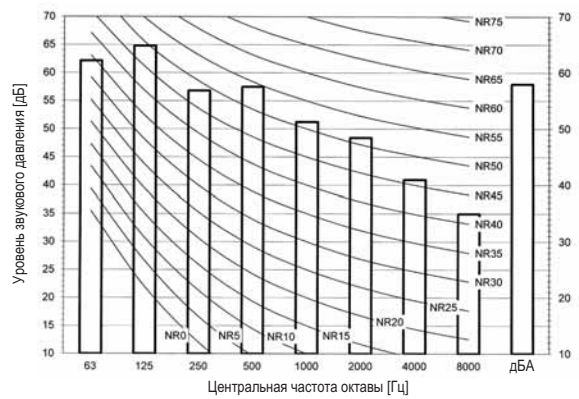

3D079902

ПРИМЕЧАНИЯ

1. Данные верны при свободных полевых условиях
2. Данные верны при номинальных условиях эксплуатации
3. дБА = A-взвешенный уровень давления звука (шкала A согласно IEC)
4. Базовое звуковое давление 0 дБ = 20 мкПа
5. Позиция измерения.

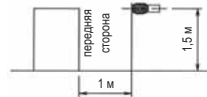

RXYQ12T

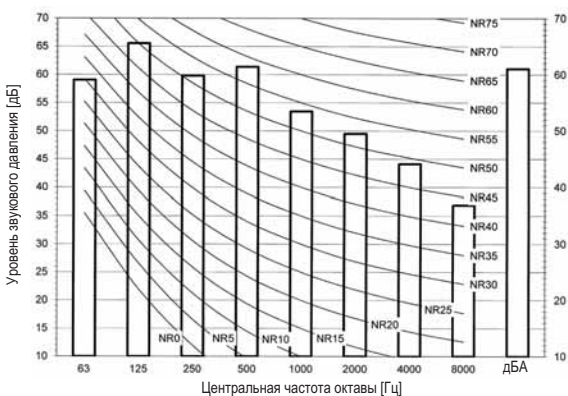

3D079903

ПРИМЕЧАНИЯ

1. Данные верны при свободных полевых условиях
2. Данные верны при номинальных условиях эксплуатации
3. дБА = A-взвешенный уровень давления звука (шкала A согласно IEC)
4. Базовое звуковое давление 0 дБ = 20 мкПа
5. Позиция измерения.

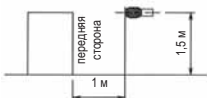

RXYQ14T

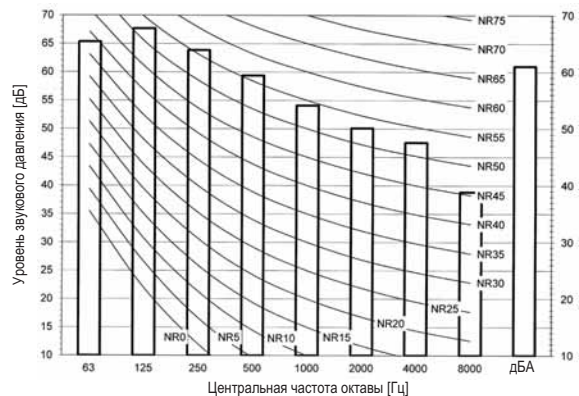

3D079904

ПРИМЕЧАНИЯ

1. Данные верны при свободных полевых условиях
2. Данные верны при номинальных условиях эксплуатации
3. дБА = A-взвешенный уровень давления звука (шкала A согласно IEC)
4. Базовое звуковое давление 0 дБ = 20 мкПа
5. Позиция измерения.

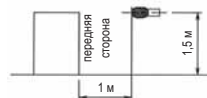

11 Данные об уровне шума

11 - 2 Спектр звукового давления

RXYQ16T

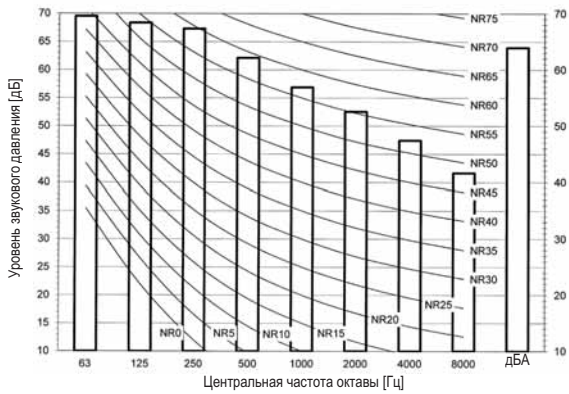

3D079905

ПРИМЕЧАНИЯ

1. Данные верны при свободных полевых условиях
2. Данные верны при номинальных условиях эксплуатации
3. дБА = A-взвешенный уровень давления звука (шкала A согласно IEC)
4. Базовое звуковое давление 0 дБ = 20 мкПа
5. Позиция измерения.

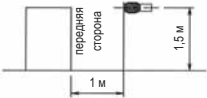

RXYQ18T

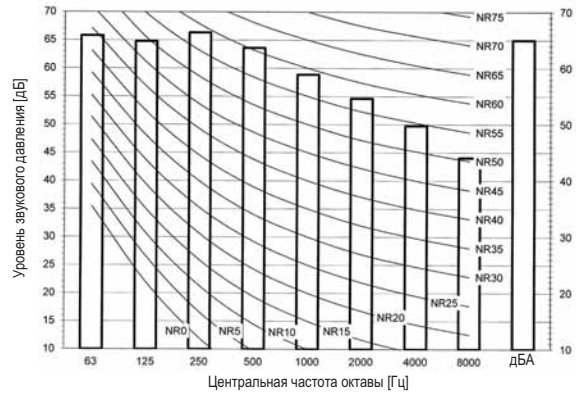

3D079906

ПРИМЕЧАНИЯ

1. Данные верны при свободных полевых условиях
2. Данные верны при номинальных условиях эксплуатации
3. дБА = A-взвешенный уровень давления звука (шкала A согласно IEC)
4. Базовое звуковое давление 0 дБ = 20 мкПа
5. Позиция измерения.

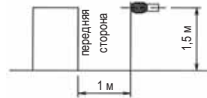

RXYQ20T

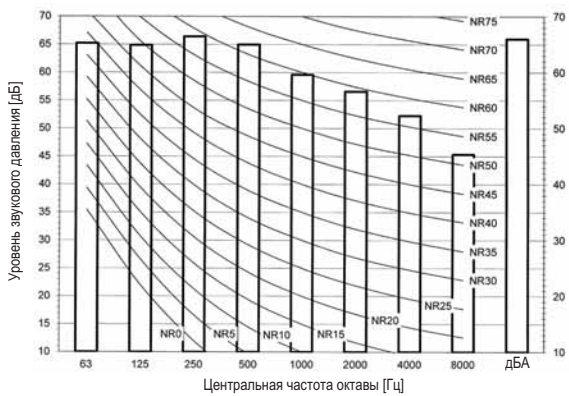

3D079907

ПРИМЕЧАНИЯ

1. Данные верны при свободных полевых условиях
2. Данные верны при номинальных условиях эксплуатации
3. дБА = A-взвешенный уровень давления звука (шкала A согласно IEC)
4. Базовое звуковое давление 0 дБ = 20 мкПа
5. Позиция измерения.

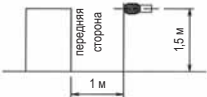

12 Установка

12 - 1 Способ монтажа

RXYQ-T

Установка одного блока

Установка рядами

План расположения централизованной группы

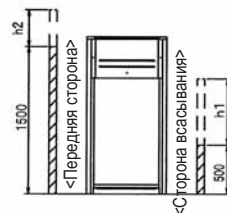
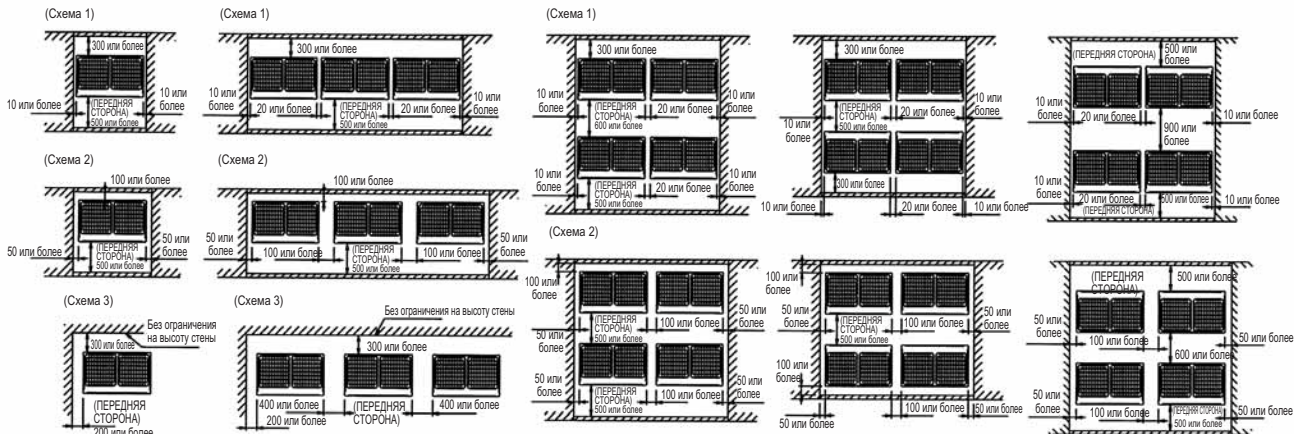

ПРИМЕЧАНИЯ

1. Высота стенок для вариантов 1 и 2:
Передняя сторона: 1500 мм
Сторона всасывания: 500 мм
Сторона: Высота не ограничена
Место установки, показанное на чертеже, рассчитано для работы по охлаждению при температуре снаружи 35°.
Если наружная температура превышает 35° или нагрузка превышает максимум из-за генерирования значительного количества тепла внешним блоком, область всасывания должна быть шире, чем пространство, указанное на чертеже.
2. При превышении высоты (см. выше) стен $h2/2$ и $h1/2$ следует добавить к области спереди и сбоку для обслуживания отверстия всасывания, соответственно, как показано на рисунке справа.
3. При установке блоков следует выбирать наиболее подходящую конфигурацию из указанных выше, чтобы получить наилучшее размещение в пространстве. Всегда оставляйте достаточно места для того, чтобы человек мог пройти между блоками, а также для свободной циркуляции воздуха.
(Если нужно установить большее число блоков, чем предусмотрено в приведенных выше схемах, общее расположение должно учитывать возможные краткие замыкания).
4. Блоки следует устанавливать так, чтобы оставить достаточно места с передней стороны, чтобы можно было удобно проводить работы со стороны рубок охладителя.

3D079542

12 Установка

12 - 2 Крепление и фундаменты блоков

RXYQ-T

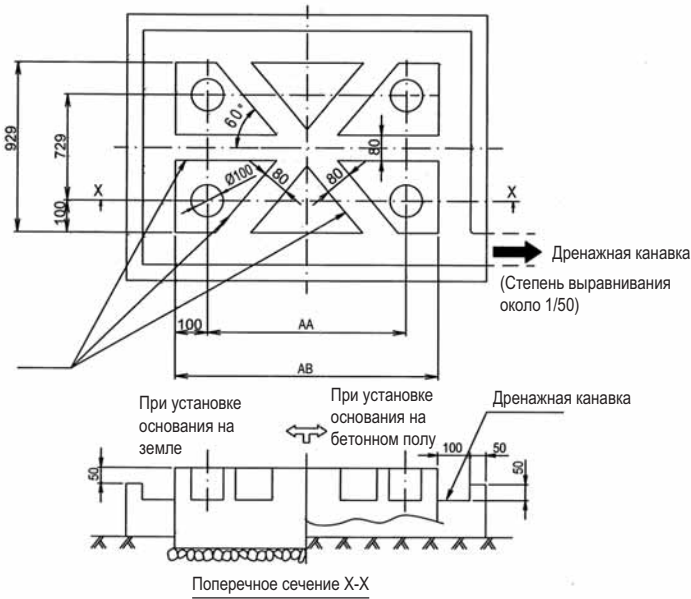

При установке нескольких соединенных блоков

Модель	AA	AB
RXYQ8-12T	766	697
RXYQ14-20T	1076	1302

ПРИМЕЧАНИЯ

1. Соотношение цемент: песок: гравий для бетона должно быть 1:2:4, а диаметр арматуры - 10 мм (прибл. интервалы 300 мм).
2. Поверхность должна быть укреплена известковым раствором. Кромки углов должны быть стесаны.
3. Когда основание устанавливается на бетонном полу, нет необходимости в каменной кладке. Однако, поверхность секции на которой установлено основание должна быть подвергнута черновой обработке.
4. Вокруг основания должна быть сделана дренажная канавка, через которую отводится вода из места установки оборудования.
5. При установке оборудования на крыше должна быть проверена прочность этажа и сделаны измерения на водонепроницаемость.

3D079547

12 Установка

12 - 3 Выбор труб с хладагентом

12

RXYQ-T

Справочный чертеж см. на следующей странице	Максимальная длина трубы			Максимальная разница по высоте			Общая длина труб
	Самая длинная труба (A+[B,G,E,J]) Фактическая / (Эквивалент)	После первого ответвления (B, G, E, J) Фактическая	После первого ответвления для наружного мультиблока (D) Фактическая / (Эквивалент)	От внутреннего до наружного ⁽²⁾ (H1)	От внутреннего до внутреннего ⁽²⁾ (H2)	От наружного до наружного ⁽³⁾ (H3)	
Стандарт Подключен только внутренний блок VRV DX Стандартное мультисочетание	165/(190) м	40 м ⁽¹⁾	10/(13) м	50/40 м ⁽³⁾	30 м	5 м	1000 м
Свободное мультисочетание (=все, кроме стандартного мультисочетания)	135/(160) м	40 м ⁽¹⁾	10/(13) м	50/(40) м (3)	30 м	5 м	500 м
Подключение гидроблока	135/(160) м	40 м	10/(13) м	50/40 м	15 м	5 м	300-500 м ⁽⁵⁾
Подключение RA	100/(120) м	50 м ⁽²⁾	-	50/40 м	15 м	-	250 м
Подключение АНУ	Пара	50/(55) м ⁽⁴⁾	-	40/40 м	-	-	-
	Мульти	165/(190) м	40 м	10/13 м	40/40 м	15 м	1000 м
	Смешанное сочетание ⁽⁶⁾	165/(190) м	40 м	10/13 м	40/40 м	15 м	1000 м

ПРИМЕЧАНИЯ

Для стандартных мультисочетаний; см. 3D079534

- (1) Расширение возможно, если все указанные ниже условия соблюдаются (ограничение может быть распространено до 90 м)
 - a. Длина трубы между всеми внутренними блоками и ближайшим набором ответвления ≤ 40 м.
 - b. Необходимо увеличить размер трубы для жидкости и газа, если длина трубы между первым набором ответвления и конечным набором ответвления превышает 40 м.
Если увеличенный размер трубы больше размера основной трубы, последний следует также увеличить.
 - c. В случае увеличения размера трубы (b) длину трубопровода следует учитывать в двойном размере. Общая длина трубопроводов должна быть в пределах ограничений (см. таблицу выше).
 - d. Разница длины трубопровода между ближайшим внутренним блоком от первого ответвления до наружного блока и самым дальним внутренним блоком до наружного блока составляет ≤ 40 м.
- (2) Если длина трубок между первым ответвлением и коробкой ВР или внутренним блоком VRV превышает 20 м, необходимо увеличить размер трубы для газа и жидкости между первым ответвлением и коробкой ВР или внутренним блоком VRV.
- (3) Расширение вплоть до 90 м возможно без дополнительного комплекта опции.
 - В случае, если место расположения наружного блока выше внутреннего: расширение возможно вплоть до 90 м при следующих условиях:
 - Увеличенный размер трубы для жидкости (подробности см. в руководстве по установке).
 - Необходима специальная настройка в наружном блоке (подробности см. в руководстве по установке).
 - В случае, если место расположения наружного блока ниже внутреннего: расширение возможно вплоть до 90 м при следующих условиях:
 - 40~60 м: минимальное отношение подключения: 80%.
 - 60~65 м: минимальное отношение подключения: 90%.
 - 65~80 м: минимальное отношение подключения: 100%.
 - 80~90 м: минимальное отношение подключения: 110%.
 - +
 - Увеличенный размер трубы для жидкости (подробности см. в руководстве по установке).
 - Необходима специальная настройка в наружном блоке (подробности см. в руководстве по установке).
- (4) Допустимая минимальная длина 5 м.
- (5) В случае мультиподключения.
- (6) Сочетание АНУ и внутреннего блока VRV DX

3D079540

12 Установка

12 - 3 Выбор труб с хладагентом

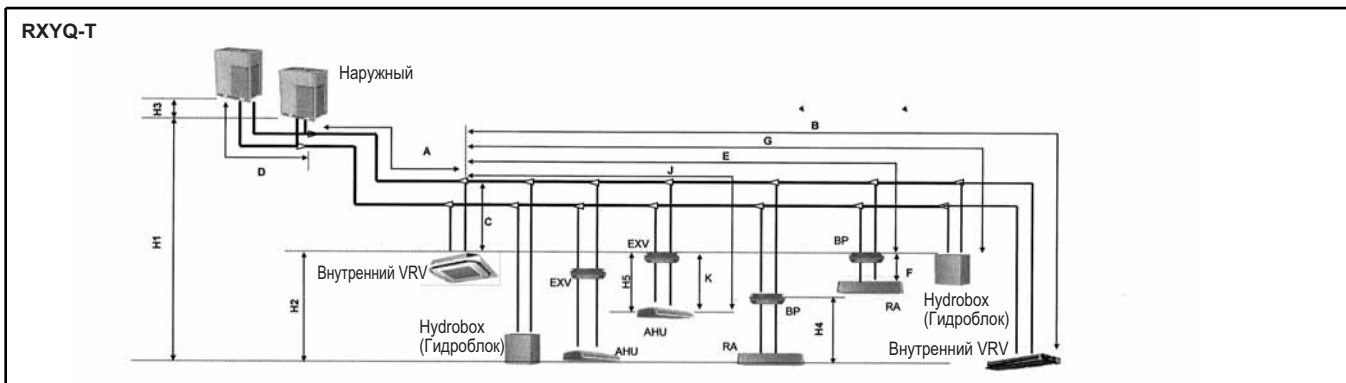

ЗАМЕЧАНИЯ

- Схематическое обозначение: изображение на иллюстрации может отличаться от реального внешнего вида блока.
- Изображенная система предназначена только для иллюстрации ограничений по длине трубопровода. Сочетание изображенных типов внутренних блоков не допускаются. Допустимые сочетания приведены в 3D079543.

		Допустимая длина трубки		Максимальная разница по высоте	
		BP - RA (F)	EXV - AHU (K)	BP - RA (H4)	EXV - AHU (H5)
Подключение RA		2~15 м	-	5 м	-
Подключение AHU	Пара	-	≤5 м	-	5 м
	Мульти (1)	-	≤5 м	-	5 м
	Смешанное сочетание	-	≤5 м	-	5 м

ЗАМЕЧАНИЯ

- Сочетание AHU и внутреннего блока VRV DX

3D079540

RXYQ-T

Схема системы Допустимое отношение подключения (CR). * Другие сочетания не разрешены.	Всего		Допустимая производительность			
	производительность	Количество внутренних блоков (VRV, RA, AHU, Hydrobox) (исключая коробки BP и комплекты EXV)	Внутренний VRV	Внутренний RA	Hydrobox (Гидроблок)	AHU
Только внутренний VRV	50~130%	Макс. 64	-	-	-	-
Внутренний VRV + внутренний RA	80~130%	Макс. 32 ⁽²⁾	0~130%	0~130%	-	-
Только внутренний RA	80~130%	Макс. 32 ⁽²⁾	80~130%	-	-	-
Внутренний VRV + LT hydro	50~130%	Макс. 32 ⁽²⁾	50~130%	-	0~80%	-
Внутренний VRV + AHU	50~110% ⁽⁴⁾	Макс. 64 ⁽³⁾	50~110%	-	-	0~110%
Только AHU	90~110% ⁽⁴⁾	Макс. 64 ⁽³⁾	-	-	-	90~110%

ПРИМЕЧАНИЯ

- Ограничений на количество подключаемых коробок BP нет.
- При использовании соединения AHU: рассматривайте комплект EKEXV как внутренний блок при подсчете общего количества внутренних блоков
- Ограничения, связанные с производительностью блока обработки воздуха

3D079540

12 Установка

12 - 3 Выбор труб с хладагентом

12

RXYQ-T

1. Выбор размера трубы

Определить правильный размер на данным, приведенным в таблицах и схемах.

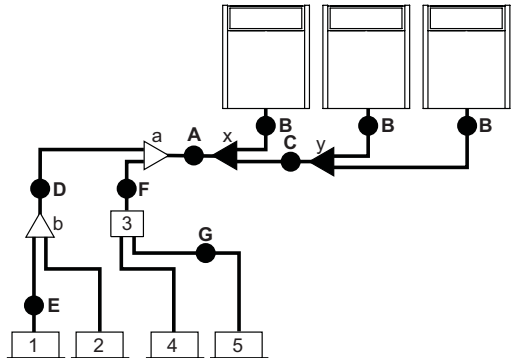

- 1,2 Внутренний блок VRV DX
- 3 Коробка BP
- 4,5 RA DX внутренний блок
- a,b Комплект ответвлений для внутреннего блока
- x, y Комплект для мультиподключения наружного блока

1.1. Трубки между наружным блоком и (первым) набором ответвления для хладагента: A, B, C

Выберите из следующей таблицы в соответствии с типом общей производительности наружных блоков, подключенных ниже по потоку.

Тип производительности наружного блока (HP/л.с.)	Внешний диаметр трубки (мм)	
	Трубка для газа	Трубка для жидкости
8	19,1	9,5
10	22,2	
12~16	28,6	12,7
18~22		15,9
24	34,9	19,1
26~34		
36~54	41,3	

1.2. Система трубопроводов между наборами ответвлений для хладагента: Г

Выберите из следующей таблицы в соответствии с типом общей производительности внутренних блоков, подключенных ниже по потоку. Не допускайте того, чтобы размер соединительной трубки превышал размер трубки для хладагента, определенный в соответствии с наименованием модели.

Показатель производительности внутренних блоков	Внешний диаметр трубки (мм)	
	Трубка для газа	Трубка для жидкости
<150	15,9	9,5
150 ≤ x < 200	19,1	
200 ≤ x < 290	22,2	12,7
290 ≤ x < 420	28,6	
420 ≤ x < 640	34,9	15,9
640 ≤ x < 920		19,1
>920	41,3	19,1

Пример:

Производительность следующих блоков для E = показатель производительности блока 1
 Производительность следующих блоков для D = показатель производительности блока 1 + показатель производительности блока 2

1.3. Трубки между ответвлением для хладагента и блоком BP: F

Размер трубы для прямого подключения на блоке BP должен определяться на основании общей производительности подключенных внутренних блоков (только в случае подключения внутренних блоков RA DX).

Общий показатель производительности подключенных внутренних блоков	Трубка для газа (мм)	Трубка для жидкости (мм)
20 - 62	12,7	6,4
63 - 149	15,9	9,5
150 - 208	19,1	

Пример:

Производительность следующих блоков для F = показатель производительности блока 4 + показатель производительности блока 5

1.4. Трубки между блоком BP и внутренним блоком RA DX: G

Только в случае подключения внутренних блоков RA DX.

Показатель производительности внутренних блоков	Трубка для газа (мм)	Трубка для жидкости (мм)
20, 25, 30	9,5	6,4
50		12,7
60	15,9	9,5
71		

1.5. Трубки между ответвлением для хладагента и внутренним блоком: E

Размер труб для прямого подключения к внутреннему блоку должен быть таким же, как и размер соединений внутреннего блока (в случае, если внутренний блок - VRV DX или Hydrobox (Гидроблок)).

Показатель производительности внутренних блоков	Внешний диаметр трубки (мм)	
	Трубка для газа	Трубка для жидкости
15, 20, 25, 32, 40, 50	12,7	6,4
63, 80, 100, 125	15,9	9,5
200	19,1	
250	22,2	

- Если эквивалентная длина трубки между наружным и внутренним блоками составляет 90 м или более, размер основных трубок (и со стороны газа, и со стороны жидкости) необходимо увеличить. В зависимости от длины трубы производительность может уменьшиться, но даже в этом случае можно увеличить размер основных трубок.

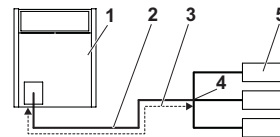

- 1 Наружный блок
- 2 Главные трубки
- 3 Увеличить
- 4 Первый набор ответвления для хладагента
- 5 Внутренний блок

Класс HP/л.с.	Увеличение размера	
	Сторона газа (мм)	Сторона жидкости (мм)
8	19,1 → 22,2	9,5 → 12,7
10	22,2 → 25,4 ^(a)	
12+14	28,6 ^(b)	12,7 → 15,9
16	28,6 → 31,8 ^(a)	
18~22	28,6 → 31,8 ^(a)	15,9 → 19,1
24	34,9 ^(b)	
26~34	34,9 → 38,1 ^(a)	15,9 → 19,1
36~54	41,3 ^(b)	

- (a) Если размер недоступен, увеличение не допускается.
- (b) Увеличение не допускается.

- Толщина труб в контуре хладагента должна соответствовать требованиям действующего законодательства. Минимальная толщина труб для хладагента R410A должна соответствовать данным в приведенной ниже таблице.

Ø трубы (мм)	Минимальная толщина t (мм)
6,4	0,80
9,5	
12,7	
15,9	0,99
19,1	0,80
22,2	
28,6	0,99
34,9	1,21
41,3	1,43

- В случае отсутствия труб необходимых размеров (размеры в дюймах) можно использовать трубы других диаметров (размеры в мм), учитывая следующее:
 - Выберите размер трубы, ближайший к требуемому размеру.
 - Используйте подходящие адаптеры для перехода от системы дюймов к мм (приобретаются на месте).
 В этом случае необходимо скорректировать расчет дополнительного хладагента (см. инструкцию по монтажу).

4P327115-1(1)

12 Установка

12 - 3 Выбор труб с хладагентом

RXYQ-T

2. Выбор комплектов ответвлений для хладагента

Ответвления refnets для хладагента

Примеры расположения трубопроводов приведены в Руководстве по установке, раздел "9.3. Выбор размера трубы" на стр. 11 .

- При использовании соединений refnet в первом разветвителе от стороны наружного блока выберите из следующей таблицы в соответствии с типом мощности наружной системы (пример: соединение refnet a).

Тип производительности наружного блока (HP/л.с.)	2 трубки
8-10	KHRQ22M29T9
12-22	KHRQ22M64T
24-54	KHRQ22M75T

- Для соединений refnet, отличных от первого ответвления (например, refnet b), выберите соответствующую модель набора для ответвления, исходя из общего показателя производительности всех внутренних блоков, подключенных ниже ответвления для хладагента.

Показатель производительности внутренних блоков	2 трубки
<200	KHRQ22M20T
200 ≤ x < 290	KHRQ22M29T9
290 ≤ x < 640	KHRQ22M64T
≤ 640	KHRQ22M75T

- Выберите насадку refnet из приведенной ниже таблицы в соответствии с общим показателем производительности всех внутренних блоков, подключенных ниже насадки refnet.

Показатель производительности внутренних блоков	2 трубки
<200	KHRQ22M29H
200 ≤ x < 290	KHRQ22M29H
290 ≤ x < 640	KHRQ22M64H ^(a)
≤ 640	KHRQ22M75H

(a) Если размер трубы над насадкой REFNET составляет ≤ 34,9 или более, необходим KHRQ22M75H.

ИНФОРМАЦИЯ

К насадке можно подключить максимум 8 ответвлений.

- Выбор набора трубок для мультисоединения наружных блоков (необходимо в случае, если тип наружного блока по производительности - 22HP или выше). Выберите из следующей таблицы в соответствии с количеством наружных блоков.

Количество наружных блоков	Наименование набора ответвителя
2	BHFQ22P1007
3	BHFQ22P1517

Для моделей RYYQ22~54, состоящих из двух или трех модулей RYMQ, требуется 3-трубопроводная система. Для этих модулей предусмотрена дополнительная труба для выравнивания (наряду с обычными трубами для газа и жидкости). Труба для выравнивания не предусмотрена для блоков RYYQ8~20 или RYXQ8~54.

Соединения для выравнивающей трубы для различных модулей RYMQ указаны в приведенной ниже таблице.

RYMQ	Труба для выравнивания Ø (мм)
8	19,1
10	
12	
14	
16	22,2
18	
20	
	28,6

Выбор диаметра трубы для выравнивания:

- В случае мультисоединения 3 блоков: необходимо оставить неизменным диаметр соединения - тройника и наружного блока.
- В случае мультисоединения 2 блоков: соединительная трубка должна иметь самый большой диаметр.

Соединения трубы для выравнивания с внутренними блоками отсутствуют.

Пример (свободное мультисоединение): RYMQ8+RYMQ12+RYMQ18. Самое большое соединение - Ø28,6 (RYMQ18); Ø22,2 (RYMQ12) и Ø19,1 (RYMQ8). На рисунке ниже изображена только выравнивающая трубка.

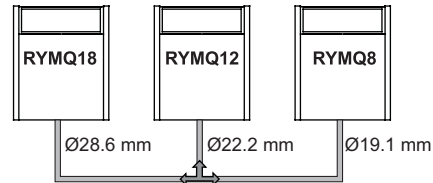

ИНФОРМАЦИЯ

Редукторы и тройники поставляются на месте.



ПРИМЕЧАНИЕ

Наборы ответвлений для хладагента могут использоваться только с R410A.



ИНФОРМАЦИЯ

Выравнивающая трубка для RYMQ должны быть подключена между наружными модулями моделей "мульти" для непрерывного отопления: RYYQ22~54 состоит из 2 или 3 модулей RYMQ8~20. Выравнивающая трубка никогда не подключается в внутреннему блоку.

3. Ограничения (длины) трубопроводов системы

3.1. Ограничения длины трубок

Установите трубопроводы в пределах максимально допустимой длины труб, разницы уровней и допустимой длины после ответвления, как указано ниже. Рассмотрим три варианта, включая внутренние блоки VRV DX в сочетании с блоками Hydrobox или внутренними блоками RA DX.

Определения

Фактическая длина трубы: длина трубы между наружным⁽¹⁾ и внутренним блоками.

Эквивалентная длина трубы⁽²⁾: длина трубы между наружным⁽¹⁾ и внутренним блоками.

Общая длина труб: общая длина трубы от наружного блока⁽¹⁾ до всех внутренних блоков.

Разница по высоте между наружным и внутренним блоками: H1.

Разница по высоте между внутренним и внутренним блоками: H2.

Разница по высоте между наружным и наружным блоками: H3.

Разница по высоте между наружным и ВР блоками: H4.

Разница по высоте между ВР и ВР блоками: H5.

Разница по высоте между блоком ВР и DX внутренним блоком: H6.

(1) Если производительность системы > 20 HP/л.с., повторно изучите раздел "первое наружное ответвление, считая от внутреннего блока".

(2) Предположим, что эквивалентная длина трубы соединения refnet = 0,5 м и насадок refnet = 1 м (для целей расчета).

12 Установка

12 - 3 Выбор труб с хладагентом

RXYQ-T

3.2. Система, содержащая только внутренние блоки VRV DX

Настройка системы

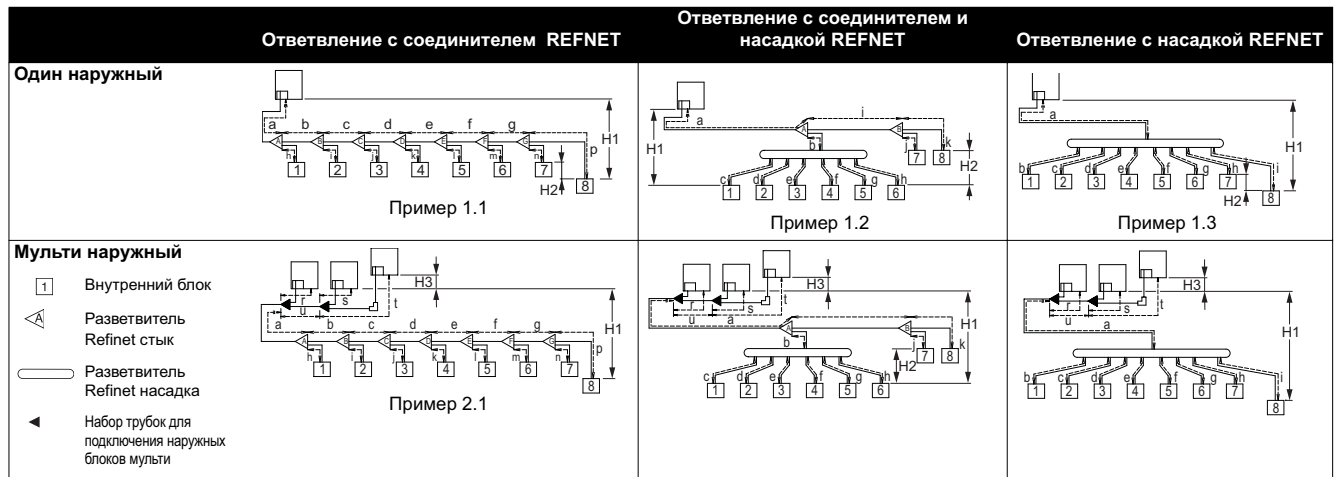

Пример 3: со стандартным мультисочетанием

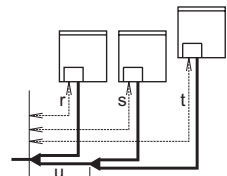

Максимальная допустимая длина

■ Между наружным и внутренним блоками (стандартные мульти / свободные мультисочетания)

Фактическая длина трубы	165 м/135 м	Пример 1.1 блок 8: $a+b+c+d+e+f+g+p \leq 165$ м Пример 2.1 блок 8: $a+b+c+d+e+f+g+p \leq 135$ м	Пример 1.2 блок 6: $a+b+h \leq 165$ м блок 8: $a+i+k \leq 165$ м	Пример 1.3 блок 8: $a+i \leq 165$ м
Эквивалентная длина ⁽²⁾	190 м/160 м	—	—	—
Общая длина труб	1000 м/500 м	Пример 1.1 $a+b+c+d+e+f+g+h+i+j+k+l+m+n+p \leq 1000$ м Пример 2.1 $a+b+c+d+e+f+g+h+i+j+k+l+m+n+p \leq 500$ м	—	—

■ Между наружным ответвлением и наружным блоком (только в случае >20НР)

Фактическая длина трубы	10 м	Пример 3 $r, s, t \leq 10$ м; $u \leq 5$ м
Эквивалентная длина	13 м	—

Пример 1.3: блок 8: $i \leq 40$ м

Однако расширение возможно, если выполняются все указанные ниже условия. В этом случае ограничение может быть продлено до 90 м.

Максимальная допустимая разница по высоте

H1	≤ 50 м (40 м) ⁽³⁾ (если наружный расположен ниже внутренних блоков)
H2	≤ 30 м
H3	≤ 5 м

(а) Условное расширение до 90 м возможно без дополнительного комплекта опции:

В случае, если место расположения наружного блока выше внутреннего: расширение возможно до 90 м при выполнении следующих 2 условий: Увеличение размера трубы для жидкости (см. таблицу "Увеличение размера" на стр. 1).

Необходима специальная установка на наружном блоке (см. руководство по обслуживанию; обратитесь за советом к дилеру).

В случае, если место расположения наружного блока ниже внутреннего: расширение возможно до 90 м при выполнении следующих 6 условий: 40-60 м: минимальное отношение подключения: 80%. 60-65 м: минимальное отношение подключения: 90%. 65-80 м: минимальное отношение подключения: 100%. 80-90 м: минимальное отношение подключения: 110%.

Увеличение размера трубы для жидкости (см. таблицу "Увеличение размера" на стр. 1).

Необходима специальная установка на наружном блоке (см. руководство по обслуживанию; обратитесь за советом к дилеру).

Максимальная допустимая длина после ответвления

Длина трубы от первого набора ответвления для хладагента до внутреннего блока ≤ 40 м.

Пример 1.1: блок 8: $b+c+d+e+f+g+p \leq 40$ м

Пример 1.2: блок 6: $b+h \leq 40$ м, блок 8: $i+k \leq 40$ м

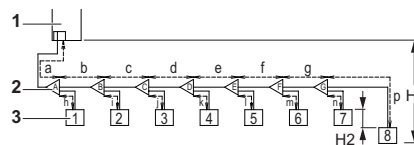

- 1 Наружные блоки
- 2 Соединения Refinet (A-G)
- 3 Внутренний блок (1-8)

- a. Длина трубы между всеми внутренними блоками и ближайшим набором ответвления ≤ 40 м.
Пример: $h, l, j \dots p \leq 40$ м
- b. Необходимо увеличить размер трубы для жидкости и газа, если длина трубы между первым набором ответвления и конечным набором ответвления превышает 40 м. Если увеличенный размер трубы больше размера основной трубы, последний следует также увеличить.
Увеличьте размер трубы следующим образом:
 $9,5 \rightarrow 12,7$; $12,7 \rightarrow 15,9$; $15,9 \rightarrow 19,1$; $19,1 \rightarrow 22,2$; $22,2 \rightarrow 25,4^{(3)}$; $28,6 \rightarrow 31,8^{(3)}$; $34,9 \rightarrow 38,1^{(3)}$
Пример: блок 8: $b+c+d+e+f+g+p \leq 90$ м; увеличьте размер трубы b, c, d, e, f, g.
- c. В случае увеличения размера трубы (стадия b) длину трубопровода следует считать в двойном размере (за исключением основной трубы и труб, размер которых не увеличивали). Общая длина трубопроводов должна быть в пределах ограничений (см. таблицу выше).
Пример: $a+b^2+c^2+d^2+e^2+f^2+g^2+h+i+j+k+l+m+n+p \leq 1000$ м (500 м).
- d. Разница длины трубопровода между ближайшим внутренним блоком от первого ответвления до наружного блока и самым дальним внутренним блоком до наружного блока составляет ≤ 40 м.
Пример: Самый дальний внутренний блок 8. Ближайший внутренний блок 1 $\rightarrow (a+b+c+d+e+f+g+p)-(a+h) \leq 40$ м.

(3) Если имеется на месте. В противном случае, его нельзя увеличить.

12 Установка

12 - 3 Выбор труб с хладагентом

RXYQ-T

3.3. Система, содержащая внутренние блоки VRV DX и Hydrobox

Настройка системы

Пример 1: Ответвление с соединителем refnet.

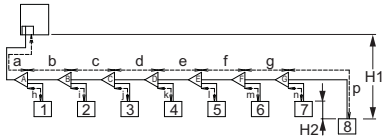

Пример 2: Ответвление с соединителем и насадкой refnet.

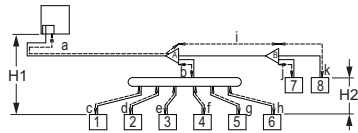

Пример 3: Ответвление с насадкой REFNET

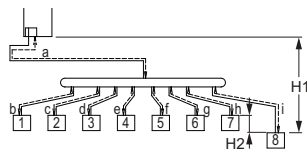

1-7 Внутренние блоки VRV DX
8 Гидроблок Hydrobox (HXY*)

Максимальная допустимая длина

Между наружным и внутренним блоками.

Фактическая длина трубы	135 м	Пример 1: $a+b+c+d+e+f+g+p \leq 135$ м $a+b+c+d+k \leq 135$ м
		Пример 2: $a+i+k \leq 135$ м $a+b+e \leq 135$ м
		Пример 3: $a+i \leq 135$ м $a+d \leq 135$ м
Эквивалентная длина ^(а)	160 м	—
Общая длина труб	300 м	Пример 3: $a+b+c+d+e+f+g+h+i \leq 300$ м

(а) Предположим, что эквивалентная длина трубы соединения refnet = 0,5 м и насадок refnet = 1 м (для целей расчета).

Максимальная допустимая разность уровней (для внутреннего блока Hydrobox)

H1	≤ 50 м (40 м) (если наружный расположен ниже внутренних блоков)
H2	≤ 15 м

Максимальная допустимая длина после ответвления

Длина трубы от первого набора ответвления для хладагента до внутреннего блока ≤ 40 м.

Пример 1: блок 8: $b+c+d+e+f+g+p \leq 40$ м

Пример 2: блок 6: $b+h \leq 40$ м, блок 8: $i+k \leq 40$ м

Пример 3: блок 8: $i \leq 40$ м, блок 2: $c \leq 40$ м

3.4. Система, содержащая внутренние блоки VRV DX и внутренние блоки RA DX

Настройка системы

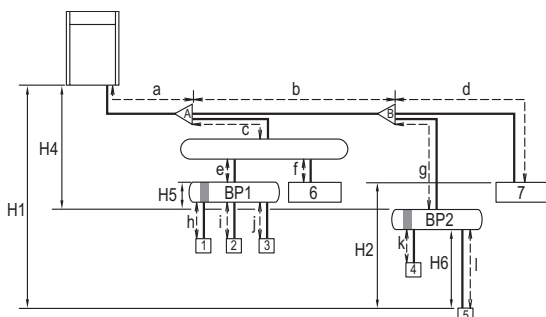

Верхний трубопровод
Коробка BP

1-5 RA DX Внутренние блоки
6,7 Внутренние блоки VRV DX

Максимальная допустимая длина

■ Между наружным блоком и внутренним блоком.

Фактическая длина трубы	100 м	Пример: $a+b+g+l \leq 100$ м
Эквивалентная длина ^(а)	120 м	—
Общая длина труб	250 м	Пример: $a+b+d+g+l+k+c+e+f+h+i+j \leq 250$ м

(а) Предположим, что эквивалентная длина трубы соединения refnet = 0,5 м и насадок refnet = 1 м (для целей расчета).

■ Между блоком BP и внутренним блоком.

Показатель производительности внутренних блоков	Длина трубы
<60	2~15 м
60	2~12 м
71	2~8 м

Примечание:

Минимальная допустимая длина между наружным блоком и набором первого ответвления хладагента > 5 м (возможна передача шума, создаваемого хладагентом в наружном блоке).

Пример: $a > 5$ м

Максимальная допустимая разница по высоте

H1	≤ 50 м (40 м) (если наружный расположен ниже внутренних блоков)
H2	≤ 15 м
H4	≤ 40 м
H5	≤ 15 м
H6	≤ 5 м

Максимальная допустимая длина после ответвления

Длина трубы от первого набора ответвления для хладагента до внутреннего блока ≤ 50 м.

Пример: $b+g+l \leq 50$ м

Если длина трубок между первым ответвлением и блоком BP или внутренним блоком VRV DX превышает 20 м, необходимо увеличить размер трубы для газа и жидкости между первым ответвлением и блоком BP или внутренним блоком VRV DX. Если диаметр труб в трубопроводе увеличенного размера превышает диаметр трубопровода до первого комплекта ответвления, для последнего также требуется увеличение размеров труб для газа и жидкости.



ПРИМЕЧАНИЕ

Существуют ограничения на порядок соединений труб для хладагента между наружными блоками в процессе установки системы мульти наружных блоков. Установите в соответствии со следующими ограничениями. Производительности наружных блоков А, В и С должны соответствовать следующим ограничениям: $A \leq B \leq C$.

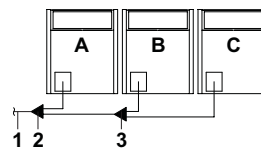

- 1 К внутренним блокам
- 2 Набор трубок для подключения наружных блоков мульти (первое ответвление)
- 3 Набор трубок для подключения наружных блоков мульти (второе ответвление)

4P327115-1(4)

13 Рабочий диапазон

13 - 1 Рабочий диапазон

13

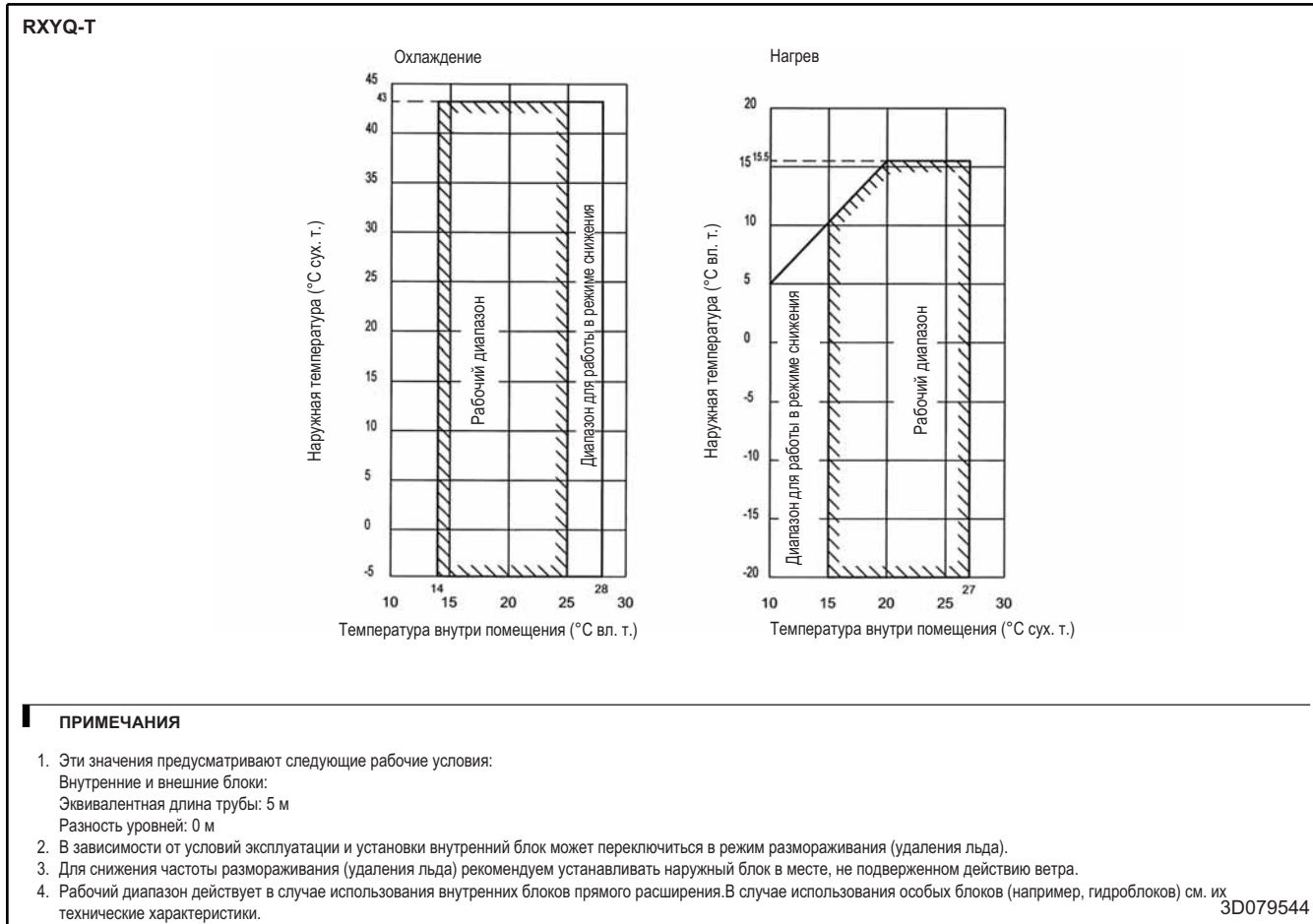



Компания Daikin занимает уникальное положение в области производства оборудования для кондиционирования воздуха, компрессоров и хладагентов. Это стало причиной ее активного участия в решении экологических проблем. В течение нескольких лет деятельность компании Daikin была направлена на то, чтобы достичь лидирующего положения по поставкам продукции, которая в минимальной степени оказывает воздействие на окружающую среду. Эта задача требует, чтобы разработка и проектирование широкого спектра продукции и систем управления выполнялись с учетом экологических требований и были направлены на сохранение энергии и снижение объема отходов.



Данные продукты не входят в объем программы сертификации Eurovent

Настоящий буклет составлен только для справочных целей и не является предложением, обязательным для выполнения компанией Daikin Europe N.V. Его содержание составлено компанией Daikin Europe N.V. на основании сведений, которыми она располагает. Компания не дает прямую или связанную гарантию относительно полноты, точности, надежности или соответствия конкретной цели ее содержания, а также продуктов и услуг, представленных в нем. Технические характеристики и могут быть изменены без предварительного уведомления. Компания Daikin Europe N.V. отказывается от какой-либо ответственности за прямые или косвенные убытки, понимаемые в самом широком смысле, вытекающие из прямого или косвенного использования и/или трактовки данного буклета. На все содержание распространяется австрийское право Daikin Europe N.V.

BARCODE

Daikin products are distributed by:

