

**DAIKIN**

# INSTALLATION MANUAL

## R410A Split Series

**INVERTER**

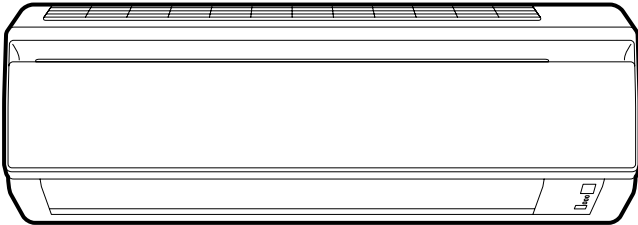

### Models

**ATX20GV1B**

**ATX25GV1B**

**ATX35GV1B**

Installation manual R410A Split series	<b>English</b>
Installationsanleitung Split-Baureihe R410A	<b>Deutsch</b>
Manuel d'installation Série split R410A	<b>Français</b>
Montagehandleiding R410A Split-systeem	<b>Nederlands</b>
Manual de instalación Serie Split R410A	<b>Español</b>
Manuale d'installazione Serie Multiambienti R410A	<b>Italiano</b>
Εγχειρίδιο εγκατάστασης διαιρούμενης σειράς R410A	<b>Ελληνικά</b>
Manual de Instalação Série split R410A	<b>Portugues</b>

CE - DECLARACION-DE-CONFORMIDAD  
CE - KONFORMITÄTSERKLÄRUNG  
CE - DICHIARAZIONE-DE-CONFORMITÀ  
CE - DECLARATION-DE-CONFORMITE  
CE - CONFORMITEITSVERKLARING

CE - DECLARACION-DE-CONFORMIDAD  
CE - ЗАЯВЛЕНИЕ-О-СОПОБЕТВЛИИ  
CE - OPIYDISESEKHLERUNG  
CE - ΠΡΟΗΛΑΣΗΝ-Ο-ΣΗΘΕ

CE - DECLARACAO-DE-CONFORMIDADE  
CE - ЗАЯВЛЕНИЕ-О-СОПОБЕТВЛИИ  
CE - OPIYDISESEKHLERUNG  
CE - FORSAKRAN-OM-OVERENSTEMMELSE

CE - ERKLERING-OM-SAMSVAR  
CE - ИЛМОИТУС-ҲИДЕМНИКАУСИСУДЕСТА  
CE - DEKLARACIJA-ZAGODNOSTI  
CE - ПРОИЈАШЕЊЕ-О-ШОДЕ

CE - IZJAVA-O-USKLAĐENOSTI  
CE - MEGFELELŐSÉGI-NYILATKOZAT  
CE - DEKLARACIJA-ZAGODNOSTI  
CE - DECLARAȚIE-DE-CONFORMITATE

CE - IZJAVA O SKLADNOSTI  
CE - VASTAVUSDEKLARACIJA  
CE - ATBILSTĪBAS-DEKLARĀCIJA  
CE - VYHLÁSENIE-ZHODY  
CE - UYUMLULUK-BİLDİRİSİ

## DAIKIN INDUSTRIES, LTD.

- 01 00 declares under its sole responsibility that the air conditioning models to which this declaration relates;
- 02 01 erklärt auf seine alleinige Verantwortung daß die Modelle der Klimaanlage für die diese Erklärung bestimmt ist;
- 03 02 déclare sous sa seule responsabilité que les appareils d'air conditionné visés par la présente déclaration;
- 04 03 verklaart hierbij op eigen exclusieve verantwoordelijkheid dat de airconditioning units waarop deze verklaring betrekking heeft;
- 05 04 dichiara bajo su única responsabilidad que los modelos de aire acondicionado a los cuales hace referencia la declaración;
- 06 05 dichiara sotto sua responsabilità che i condizionatori modello a cui è riferita questa dichiarazione;
- 07 06 δηλώνει με αποκλειστική της ευθύνη ότι το προϊόν της κλιματιστικού οποιουδήποτε από ορισμένα μοντέλα;
- 08 07 δηλώνει με την αποκλειστική της ευθύνη ότι τα προϊόντα της κλιματιστικού οποιουδήποτε από ορισμένα μοντέλα;
- 09 08 заявляет исключительно под свое ответственность, что модели кондиционеров воздуха, к которым относится настоящее заявление;

## ATX20GV1B, ATX25GV1B, ATX35GV1B

- 01 are in conformity with the following standard(s) or other normative document(s), provided that these are used in accordance with our instructions;
- 02 werden folgenden Normen(en) oder einem anderen Normdokument oder Dokumenten entsprechend, unter der Voraussetzung, daß sie gemäß unseren Anweisungen eingesetzt werden;
- 03 sont conformes à la(s) norme(s) ou autre(s) document(s) normatif(s), pour autant qu'ils soient utilisés conformément à nos instructions;
- 04 conform de volgende norm(en) of één of meer andere bindende documenten zijn, op voorwaarde dat ze worden gebruikt overeenkomstig onze instructies;
- 05 están en conformidad con la(s) siguiente(s) norma(s) u otros(s) documento(s) normativo(s), siempre que sean utilizados de acuerdo con nuestras instrucciones;
- 06 sono conformi all(i) seguente(i) standard(i) o altro(i) documento(i) a carattere normativo, a patto che vengano usati in conformità alle nostre istruzioni;
- 07 είναι σύμφωνα με το(α) ακόλουθο(α) πρότυπο(α) ή άλλο(α) έγγραφο(α) κανονιστικό, υπό την προϋπόθεση ότι χρησιμοποιείται σύμφωνα με τις οδηγίες μας;

## EN60335-2-40,

- 01 following the provisions of:
- 02 gemäß den Vorschriften der:
- 03 conformément aux stipulations des:
- 04 overeenkomstig de bepalingen van:
- 05 segundo las disposiciones de:
- 06 secondo le prescrizioni per:
- 07 με την προϋπόθεση των διατάξεων των:
- 08 de acordo com o previsto em:
- 09 в соответствии с положениями:

- 01 Note \* as set out in Daikin.TCF.015 and judged positively by KEIMA according to the Certificate 74736-KROEIMC97-4857.
- 02 Hinweis \* wie in der Daikin.TCF.015 aufgeführt und von KEIMA positiv beurteilt gemäß Zertifikat 74736-KROEIMC97-4857.
- 03 Remarque \* tel que défini dans Daikin.TCF.015 et évalué positivement par KEIMA conformément au Certificat 74736-KROEIMC97-4857.
- 04 Bemerk \* zoals vermeld in Daikin.TCF.015 en in positief beoordeeld door KEIMA overeenkomstig Zertificaat 74736-KROEIMC97-4857.
- 05 Nota \* tal como se establece en Daikin.TCF.015 y es valorado positivamente por KEIMA de acuerdo con el Certificado 74736-KROEIMC97-4857.
- 06 Nota \* delimitat în Daikin.TCF.015 și judecat pozitivamente de KEIMA secundr il Certificat 74736-KROEIMC97-4857.
- 07 Σημείωση \* όπως καθορίζεται στο Daikin.TCF.015 και κρίνεται θετικά από το KEIMA σύμφωνα με το Πρωτόκολλο 74736-KROEIMC97-4857.
- 08 Nota \* tal como estabelecido em Daikin.TCF.015 e com o parecer positivo de KEIMA de acordo com o Certificado 74736-KROEIMC97-4857.
- 09 Примечание \* как указано в Daikin.TCF.015 и в соответствии с положительным решением KEIMA согласно Сертификату 74736-KROEIMC97-4857.

- 10 00 erklærer under enensvar, at klimaanlægsmødelerne, som denne deklaration vedrører;
- 11 01 deklarerer egenligvis at hvedningsværg, at luftkonditioneringsmodellerne som berøres af denne deklaration inderbær att;
- 12 02 erklærer et fuldstændigt ansvar for at de luftkonditioneringsmodeller som berøres af denne deklaration inderbær att;
- 13 03 ilmoittaa yksinomaan omalla vastuullaan, että tämän ilmoituksen tarkoituksena on ilmoittautua ilmoittamitteltäiden mallit;
- 14 04 prohlášeje ve své plné odpovědnosti, že modely klimatizace, k nimž se toto prohlášení vztahuje;
- 15 05 izjavljue pod skljivo odgovornostjo, da modely klimatizacije, k nimž se ova izjava odnosi;
- 16 06 teljes felelősséggel tudatában kijelentem, hogy a klímaberendezés modellek, melyekre e nyilatkozat vonatkozik;
- 17 07 deklarije na vlastnu i odgovornost, da modely klimatizaciov, ktorých dotyczu nihslejšia deklarácia;
- 18 08 deklarije pe proprie răspundere că aparatele de aer condiționat la care se referă această declarare;

- 09 estão em conformidade com a(s) seguinte(s) norma(s) ou outro(s) documento(s) normativo(s), desde que estes sejam utilizados de acordo com as nossas instruções;
- 09 соответствуют следующим стандартам или другим нормативным документам, при условии их использования согласно нашим инструкциям;
- 10 overholder følgende standard(er) eller andet/andre retningsgivende dokument(er), forudsat at disse anvendes i henhold til vore instrukser;
- 11 respectivelc anstning är utförd i överensstämmelse med och följer följande standard(er) eller andra normgivande dokument, under förutsättning att användning sker i överensstämmelse med våra instruktioner;
- 12 respectivelc usety er i overensstemmelse med følgende standard(er) eller andre normgivende dokument(er), under forudsætning at disse bruges i henhold til våre instruksjer;
- 13 vastaaat seuraavat standardit ja niiden ohjeelliset dokumentit vaatuuksissa edellyttein, että niitä käytetään ohjeidemme mukaisesti;
- 14 za predokladu, že jsou využívány v souladu s našimi pokyny, odpovídají následujícími normám nebo normativním dokumentům;
- 15 v skladu sa silješčim standardom(im) ili drugim normativnim dokumentom(im), za uvjet da se oni koriste u skladu s našim uputama;

- 01 Directives, as amended.
- 02 Direktiven, genåändrad.
- 03 Directives, telles que modifiées.
- 04 Richtlijnen, zoals geamendard.
- 05 Directivas, según lo emmendado.
- 06 Direktive, come da modifica.
- 07 Önyük, omuz çyüv çpönmöçleri.
- 08 Directivas, conforme alteraçao em.
- 09 Директиви, со везами поправаками.

## Low Voltage 2006/95/EC Machinery Safety 98/37/EC Electromagnetic Compatibility 2004/108/EC \*

- 10 Bemerk \* som angiver Daikin.TCF.015 og positivt vurderet af KEIMA i henhold til Certificat 74736-KROEIMC97-4857.
- 11 Information \* enligt Daikin.TCF.015 och godkänns av KEIMA enligt Certifikat 74736-KROEIMC97-4857.
- 12 Merk \* som det fremkommer i den Daikin.TCF.015 og gennem positiv bedømmelse av KEIMA i lge.
- 13 Huom \* jotka on esitetty asiakirjassa Daikin.TCF.015 ja jotka KEIMA on hyväksynyt.
- 14 Poznámka \* jak bylo uvedeno v Daikin.TCF.015 a pozitivně zjišeno KEIMA v souladu s osvědčením 74736-KROEIMC97-4857.
- 15 Napomena \* kako je izloženo u Dodatku o tehničkoj konstrukciji Daikin.TCF.015 pozitivno ocijenjeno od strane KEIMA prema Certifikatu 74736-KROEIMC97-4857.
- 16 Megjegyzés \* a(z) Daikin.TCF.015 műszaki konstrukciós dokumentáció alapján, a(z) KEIMA gazdálta a megjelölt a(z) 74736-KROEIMC97-4857 tanúsítvány szerint.
- 17 Uwaga \* zgodnie z dokumentacją Daikin.TCF.015 pozytywną opinią KEIMA i świadectwem 74736-KROEIMC97-4857.
- 18 Nota \* se cum este stabilit în Daikin.TCF.015 și apreciate pozitiv de KEIMA în conformitate cu Certificatul 74736-KROEIMC97-4857.

Noboru Murata  
Manager Quality Control Department  
Shiga, 1st of Dec. 2007

3SB64117-3B

**DAIKIN INDUSTRIES, LTD.**  
Umeda Center Bldg., 2-4-12, Nakazaki-Nishi,  
Kita-ku, Osaka, 530-8323 Japan

- 19 00 z vsvo odgovornostjo izjavlja, da so modeli klimatistiñ naprav, na katere se izjava nanaša;
- 20 01 knmblet oma täieliku vastutuse, et klassseava deklaratsioonidele kuuluvad kliimasüsteemide mudelid;
- 21 02 deklariira na svoa otvovodnost, et klassseava klimatitšna instalatsija, za kormo se otnaša tazi deklaratsija;
- 22 03 visšie saro atsakomybe stebieba, kad oro kondicionavimo prietaisų modeliai, kuriems yra taikoma ši deklaracija;
- 23 04 ar plinu atbildību apliecinu, ka tālāk uzskaitīto modeļu gaisa kondicionēšanai, uz kurām attiecas šī deklarācija;
- 24 05 vyhlášeje na vlastnu zodpovednost, že tieto klimatizačné modely, na ktoré sa vzťahuje toto vyhlásenie;
- 25 06 lamamen kendi sorumluluğunda olnak üzere bu bildirimli ilgili diğer klima modellerinin aşağıdaki gibi olduğunu beyan eder;

- 16 megjelönek az alábbi szabványok/nyak vagy egyéb iránymóó dokumentum(ok)nak, ha azokat előírás szerinti használatuk;
- 17 sponjaša, wymogi następujących norm i innych dokumentów normalizacyjnych, pod warunkiem że używane są zgodnie z naszymi instrukcjami;
- 18 sunt în conformitate cu următorii (următoare)le standarde (sau alte) documente (normative), cu condiția ca acestea să fie utilizate în conformitate cu instrucțiunile noastre;
- 19 skladi z naslednjih standardi in drugim normativi, pod pogojem, da se uporabljajo v skladu z našimi navodili;
- 20 on vastavauss järgmis(t)le standard(ide)ga või teisete normaliseerise dokumentidega, kui need kasutatakse vastavalt meie juhenditele;
- 21 соответствует на следующие стандарты или други нормативны документи, при условии, че се използват съгласно нашите инструкции;
- 22 atitinka žemiau nurodytus standartus ir (arba) kitus norminius dokumentus su sąlyga, kad yra naudojami pagal mūsų nurodymus;
- 23 tad, ja teičiti atbilstošī roztaģā norādījumiem, abilsti sekosēšiem standartiem un citiem normatīviem dokumentiem;
- 24 sū v zbrode s nasledovno(y)mi normo(ami) alebo nym(i) normatívnym(i) dokumentom(ami), za predpokladu, že sa používajú v súlade s našimi návodmi;
- 25 jūrinu, laimatarlamza gōre kulinarlamza kosuljuje aģuđādātī standartlar ve norm beliten beğaderle uyumludur;

- 10 Direktive, med senere ændringer.
- 11 Direktiv, med foretagne ændringer.
- 12 Direktive, telles que modifiées.
- 13 Direktive, med foretagne ændringer.
- 14 v päitnem zneni.
- 15 Srijemice, kako je izmjenjeno.
- 16 irányelv(ek) és módosítás(ok) rendelkezéssel.
- 17 z późniejszymi poprawkami.
- 18 Directivelor, cu amendamentele respective.

- 19 Opomba \* kot je doobeno v Daikin.TCF.015 in odobreno s strani KEIMA v skladu s certifikatom 74736-KROEIMC97-4857.
- 20 Märkus \* nagu on määratud dokumentis Daikin.TCF.015 ja heaks kiidetud KEIMA järgi vastavalt sertifikaadile 74736-KROEIMC97-4857.
- 21 Zabeleška \* kako je usvojeno v Daikin.TCF.015 in odušeno potokirano ot KEIMA sklasno Certifikat 74736-KROEIMC97-4857.
- 22 Pastaba \* kaip nustatyta Daikin.TCF.015 ir kaip legaliai nuspresta KEIMA pagal Sertifikat 74736-KROEIMC97-4857.
- 23 Poznámka \* ká nález Daikin.TCF.015 un ablistiš KEIMA pozitivajam věřijumam sskládn ar ssertifikat 74736-KROEIMC97-4857.
- 24 Poznámka \* ako bolo uvedené v Daikin.TCF.015 a pozitivne zistené KEIMA v súlade s osvedčením 74736-KROEIMC97-4857.
- 25 Not \* Daikin.TCF.015 da beiriditji gijb ve 74736-KROEIMC97-4857 sertifikatsine göre KEIMA tarafından olumlu olarak değerlendirildiği gibi.



# Safety Precautions

- Read these Safety Precautions carefully to ensure correct installation.
- This manual classifies the precautions into WARNING and CAUTION.  
Be sure to follow all the precautions below: they are all important for ensuring safety.





 **WARNING**.....Failure to follow any of WARNING is likely to result in such grave consequences as death or serious injury.



 **CAUTION**.....Failure to follow any of CAUTION may result in grave consequences in some cases.

- The following safety symbols are used throughout this manual:

 Be sure to observe this instruction.	 Be sure to establish an earth connection.	 Never attempt.
--	---	--

- After completing installation, test the unit to check for installation errors. Give the user adequate instructions concerning the use and cleaning of the unit according to the Operation Manual.

 <b>WARNING</b>	
• Installation should be left to the dealer or another professional. Improper installation may cause water leakage, electrical shock, or fire.	
• Install the air conditioner according to the instructions given in this manual. Incomplete installation may cause water leakage, electrical shock, or fire.	
• Be sure to use the supplied or specified installation parts. Use of other parts may cause the unit to come to lose, water leakage, electrical shock, or fire.	
• Install the air conditioner on a solid base that can support the weight of the unit. An inadequate base or incomplete installation may cause injury in the event the unit falls off the base.	
• Electrical work should be carried out in accordance with the installation manual and the national electrical wiring rules or code of practice. Insufficient capacity or incomplete electrical work may cause electrical shock or fire.	
• Be sure to use a dedicated power circuit. Never use a power supply shared by another appliance.	
• For wiring, use a cable length enough to cover the entire distance with no connection. Do not use an extension cord. Do not put other loads on the power supply, use a dedicated power circuit. (Failure to do so may cause abnormal heat, electric shock or fire.)	
• Use the specified types of wires for electrical connections between the indoor and outdoor units. Firmly clamp the interconnecting wires so their terminals receive no external stresses. Incomplete connections or clamping may cause terminal overheating or fire.	
• After connecting interconnecting and supply wiring be sure to shape the cables so that they do not put undue force on the electrical covers or panels. Install covers over the wires. Incomplete cover installation may cause terminal overheating, electrical shock, or fire.	
• If any refrigerant has leaked out during the installation work, ventilate the room. (The refrigerant produces a toxic gas if exposed to flames.)	
• After all installation is complete, check to make sure that no refrigerant is leaking out. (The refrigerant produces a toxic gas if exposed to flames.)	
• When installing or relocating the system, be sure to keep the refrigerant circuit free from substances other than the specified refrigerant (R410A), such as air. (Any presence of air or other foreign substance in the refrigerant circuit causes an abnormal pressure rise or rupture, resulting in injury.)	
• During pump-down, stop the compressor before removing the refrigerant piping. If the compressor is still running and the stop valve is open during pump-down, air will be sucked in when the refrigerant piping is removed, causing abnormal pressure in the freezer cycle which will lead to breakage and even injury.	
• During installation, attach the refrigerant piping securely before running the compressor. If the compressor is not attached and the stop valve is open during pump-down, air will be sucked in when the compressor is run, causing abnormal pressure in the freezer cycle which will lead to breakage and even injury.	
• Be sure to establish an earth. Do not earth the unit to a utility pipe, arrester, or telephone earth. Incomplete earth may cause electrical shock, or fire. A high surge current from lightning or other sources may cause damage to the air conditioner.	
• Be sure to install an earth leakage breaker. Failure to install an earth leakage breaker may result in electric shocks, or fire.	

 <b>CAUTION</b>	
• Do not install the air conditioner in a place where there is danger of exposure to inflammable gas leakage. If the gas leaks and builds up around the unit, it may catch fire.	
• Establish drain piping according to the instructions of this manual. Inadequate piping may cause flooding.	
• Tighten the flare nut according to the specified method such as with a torque wrench. If the flare nut is tightened too hard, the flare nut may crack after a long time and cause refrigerant leakage.	

# Accessories

**Indoor unit** (A) – (L),

(A) Mounting plate	1	(E) Remote controller holder	1	(K) Operation manual	1
(B) Titanium Apatite Photocatalytic Air-Purifying Filter	2	(G) AAA dry-cell batteries	2	(L) Installation manual	1
(D) Wireless remote controller	1	(H) Indoor unit fixing screws (M4 × 12L)	2		

## Choosing an Installation Site

- Before choosing the installation site, obtain user approval.

### 1. Indoor unit.

- The indoor unit should be sited in a place where:
  - 1) the restrictions on installation specified in the indoor unit installation drawings are met,
  - 2) both air intake and exhaust have clear paths met,
  - 3) the unit is not in the path of direct sunlight,
  - 4) the unit is away from the source of heat or steam,
  - 5) there is no source of machine oil vapour (this may shorten indoor unit life),
  - 6) cool (warm) air is circulated throughout the room,
  - 7) the unit is away from electronic ignition type fluorescent lamps (inverter or rapid start type) as they may shorten the remote control range,
  - 8) the unit is at least 1 metre away from any television or radio set (unit may cause interference with the picture or sound),
  - 9) install at the recommended height (1.8m).

### 2. Wireless remote controller.

- 1) Turn on all the fluorescent lamps in the room, if any, and find the site where remote control signals are properly received by the indoor unit (within 7 metres).

# Installation Tips

## 1. Removing and installing front panel.

### • Removal method

- 1) Place your fingers in the indentations on the main unit (one each on the left and right sides), and open the panel until it stops.
- 2) Continue to open the front panel further while sliding the panel to the right and pulling it toward you in order to disengage the rotating shaft on the left side. To disengage the rotating shaft on the right side, slide the panel to the left while pulling it toward you.

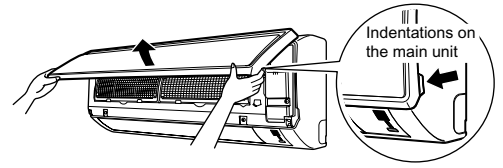

### • Installation method

Align the tabs of the front panel with the grooves, and push all the way in. Then close slowly. Push the center of the lower surface of the panel firmly to engage the tabs.

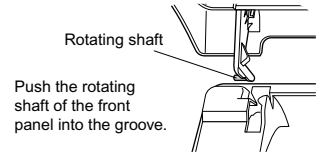

## 2. Removing and installing front grille.

### • Removal method

- 1) Remove front panel to remove the air filter.
- 2) Remove the screws (2) from the front grille.
- 3) In front of the ○○○ mark of the front grille, there are 3 upper hooks. Lightly pull the front grille toward you with one hand, and push down on the hooks with the fingers of your other hand.

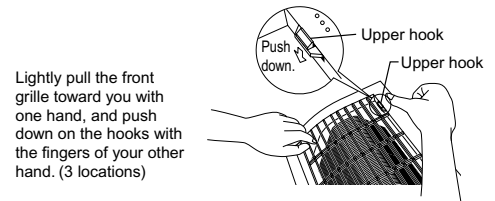
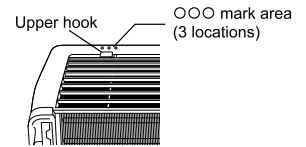

## When there is no work space because the unit is close to ceiling

### ⚠ CAUTION

Be sure to wear protection gloves.

Place both hands under the center of the front grille, and while pushing up, pull it toward you.

### • Installation method

- 1) Install the front grille and firmly engage the upper hooks (3 locations).
- 2) Install 2 screws of the front grille.
- 3) Install the air filter and then mount the front panel.

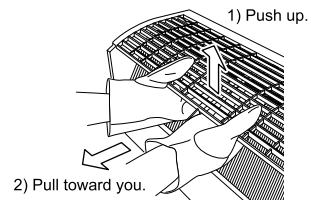

## 3. How to set the different addresses.

When two indoor units are installed in one room, the two wireless remote controllers can be set for different addresses.

- 1) In the same way as when connecting to an HA system, remove the metal plate electrical wiring cover.
- 2) Cut the address jumper (JA) on the printed circuit board.
- 3) Cut the address jumper (J4) in the remote controller.

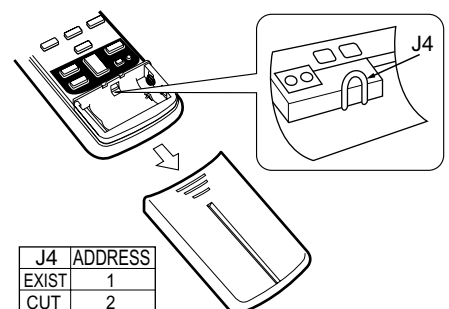
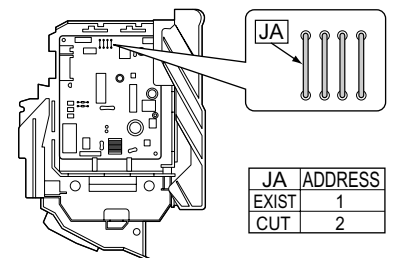

# Indoor Unit Installation Drawings

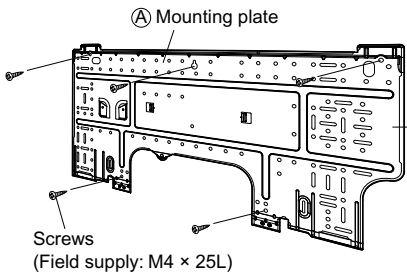

The mounting plate should be installed on a wall which can support the weight of the indoor unit.

## ■ How to attach the indoor unit.

Hook the claws of the bottom frame to the mounting plate.  
If the claws are difficult to hook, remove the front grille.

## ■ How to remove the indoor unit.

Push up the marked area (at the lower part of the front grille) to release the claws. If it is difficult to release, remove the front grille.

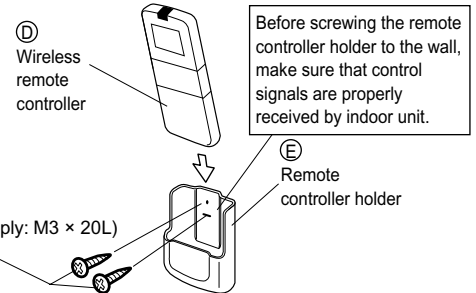
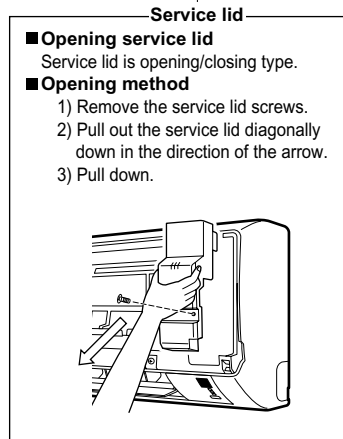
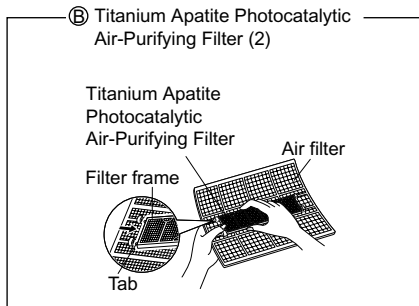
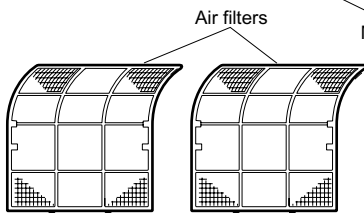
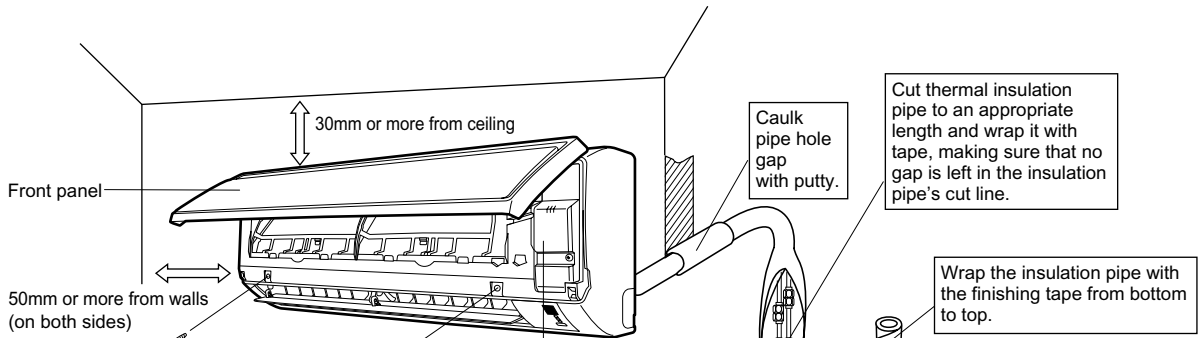
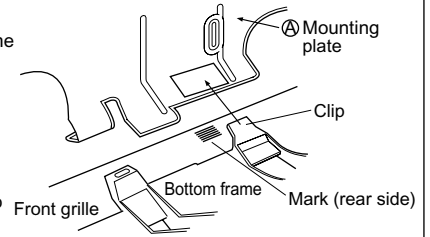

# Indoor Unit Installation

## 1. Installing the mounting plate.

- The mounting plate should be installed on a wall which can support the weight of the indoor unit.
  - 1) Temporarily secure the mounting plate to the wall, make sure that the panel is completely level, and mark the boring points on the wall.
  - 2) Secure the mounting plate to the wall with screws.

### Recommended mounting-plate retention spots and Dimensions

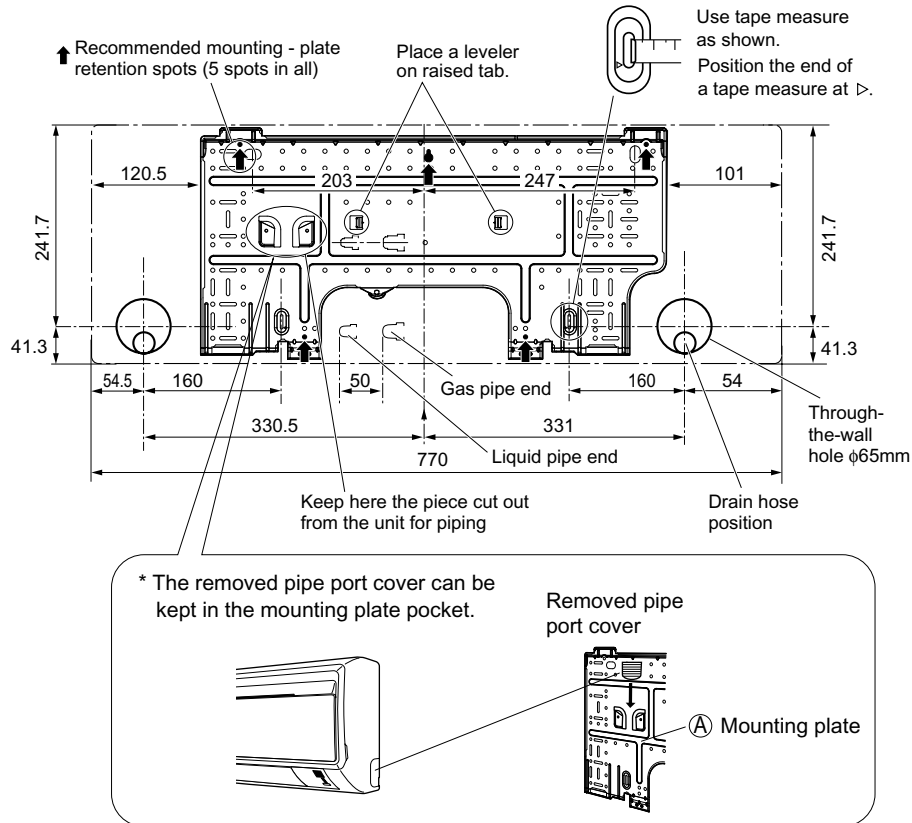

## 2. Boring a wall hole and installing wall embedded pipe.

- For walls containing metal frame or metal board, be sure to use a wall embedded pipe and wall cover in the feed-through hole to prevent possible heat, electrical shock, or fire.
- Be sure to caulk the gaps around the pipes with caulking material to prevent water leakage.
  - 1) Bore a feed-through hole of 65mm in the wall so it has a down slope toward the outside.
  - 2) Insert a wall pipe into the hole.
  - 3) Insert a wall cover into wall pipe.
  - 4) After completing refrigerant piping, wiring, and drain piping, caulk pipe hole gap with putty.

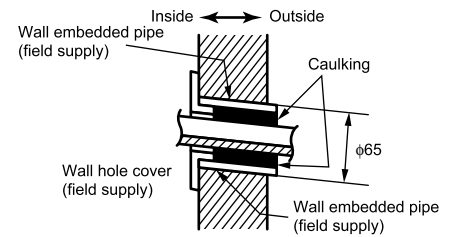

## 3. Installing indoor unit.

- In the case of bending or curing refrigerant pipes, keep the following precautions in mind. Abnormal sound may be generated if improper work is conducted.
  - 1) Do not strongly press the refrigerant pipes onto the bottom frame.
  - 2) Do not strongly press the refrigerant pipes on the front grille, either.

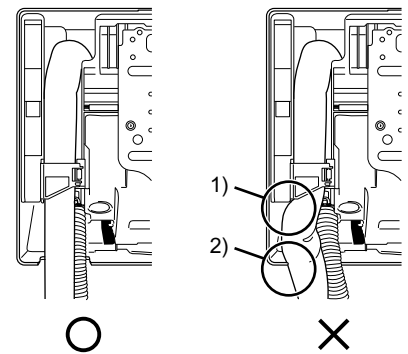

### 3-1. Right-side, right-back, or right-bottom piping.

- 1) Attach the drain hose to the underside of the refrigerant pipes with an adhesive vinyl tape.
- 2) Wrap the refrigerant pipes and drain hose together with an insulation tape.

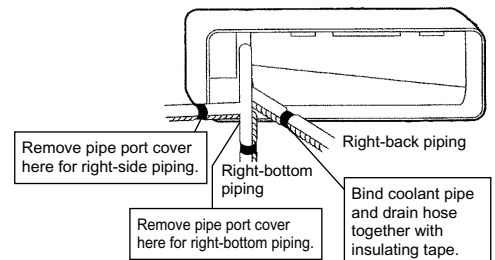

- 3) Pass the drain hose and refrigerant pipes through the wall hole, then set the indoor unit on the mounting plate hooks by using the  $\Delta$  markings at the top of the indoor unit as a guide.

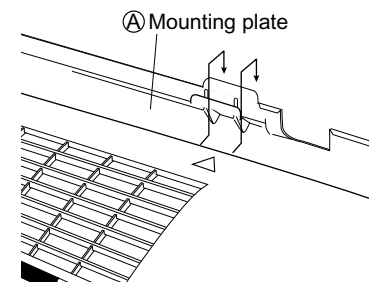

- 4) Open the front panel, then open the service lid. (Refer to Installation tips.)
- 5) Pass the interconnecting wires from the outdoor unit through the feed-through wall hole and then through the back of the indoor unit. Pull them through the front side. Bend the ends of tie wires upward for easier work in advance. (If the interconnecting wire ends are to be stripped first, bundle wire ends with adhesive tape.)
- 6) Press the bottom frame of the indoor unit with both hands to set it on the mounting plate hooks. Make sure the wires do not catch on the edge of the indoor unit.

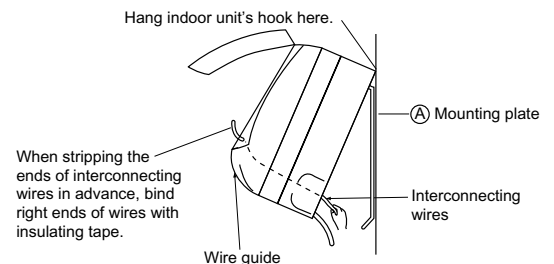



# Indoor Unit Installation

## 3-2. Left-side, left-back, or left-bottom piping.

### How to replace the drain plug and drain hose.

#### • Replacing onto the left side

- 1) Remove the insulation fixing screws on the right to remove the drain hose.
- 2) Reattach the insulation fixing screw on the right as it was.  
\* (Forgetting to attach this may cause water leakages.)
- 3) Remove the drain plug on the left side and attach it to the right side.
- 4) Insert the drain hose and tighten with included indoor unit fixing screw.

#### Drain hose attachment position

\* The drain hose is on the back of the unit.

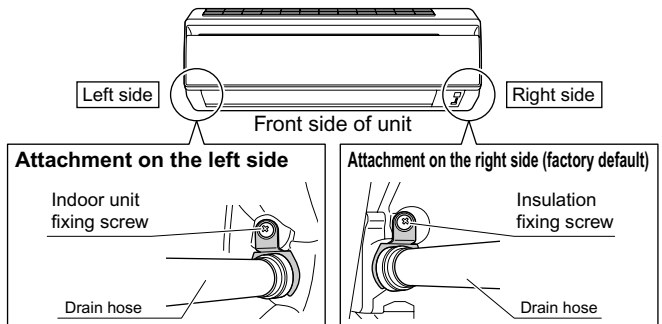

- 1) Attach the drain hose to the underside of the refrigerant pipes with adhesive vinyl tape.

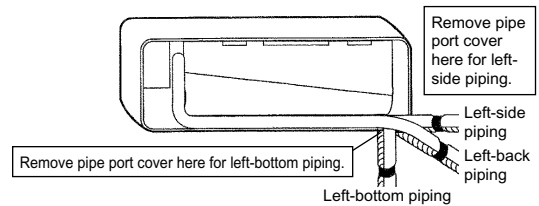

- 2) Be sure to connect the drain hose to the drain port in place of a drain plug.

#### How to set drain plug.

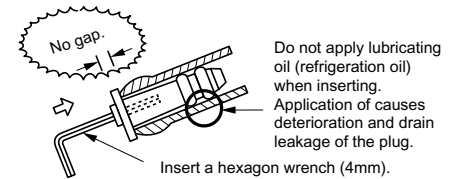

- 3) Shape the refrigerant pipe along the pipe path marking on the mounting plate.
- 4) Pass drain hose and refrigerant pipes through the wall hole, then set the indoor unit on mounting plate hooks, using the  $\Delta$  markings at the top of indoor unit as a guide.
- 5) Pull in the interconnecting wires.
- 6) Connect the inter-unit piping.
- 7) Wrap the refrigerant pipes and drain hose together with insulation tape as right figure, in case of setting the drain hose through the back of the indoor unit.
- 8) While exercising care so that the interconnecting wires do not catch indoor unit, press the bottom edge of indoor unit with both hands until it is firmly caught by the mounting plate hooks. Secure indoor unit to the mounting plate with screws (M4  $\times$  12L).

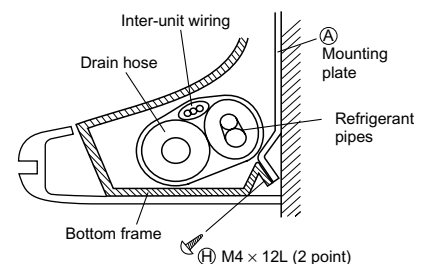
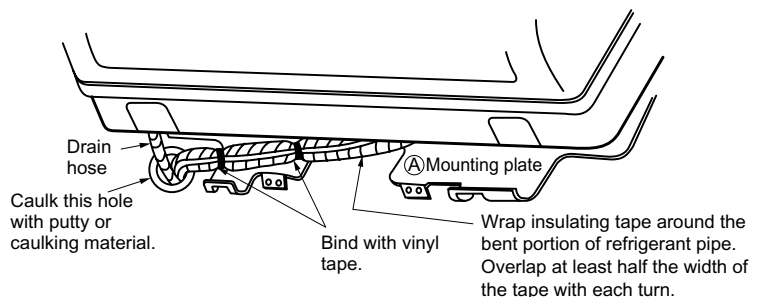

## 3-3. Wall embedded piping.

Follow the instructions given under

### Left-side, left-back, or left-bottom piping

- 1) Insert the drain hose to this depth so it won't be pulled out of the drain pipe.

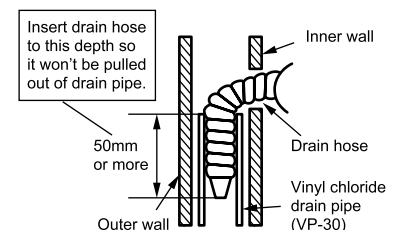

## 4. Wiring.

- 1) Strip wire ends (15mm).
- 2) Match wire colours with terminal numbers on indoor and outdoor unit's terminal blocks and firmly screw wires to the corresponding terminals.
- 3) Connect the earth wires to the corresponding terminals.
- 4) Pull wires to make sure that they are securely latched up, then retain wires with wire retainer.
- 5) In case of connecting to an adapter system. Run the remote control cable and attach the S21. (Refer to 5. When connecting to a wired remote controller.)
- 6) Shape the wires so that the service lid fits securely, then close service lid.

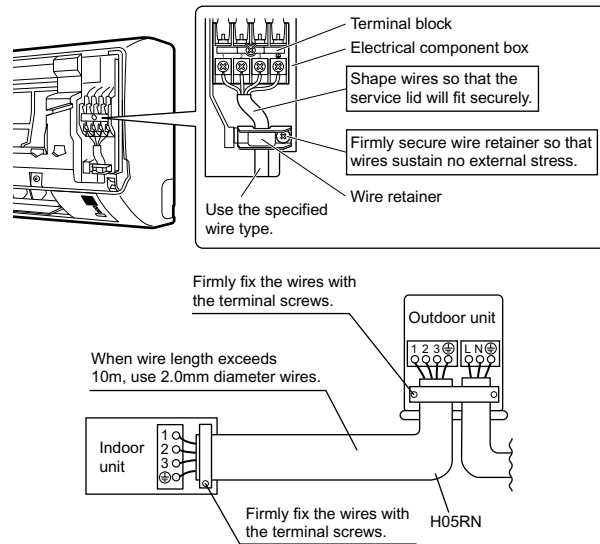

### **⚠ WARNING**

- 1) Do not use tapped wires, strand wires, extensioncords, or starburst connections, as they may cause overheating, electrical shock, or fire.
- 2) Do not use locally purchased electrical parts inside the product. (Do not branch the power for the drain pump, etc., from the terminal block.) Doing so may cause electric shock or fire.

## 5. When connecting to a wired remote controller.

- \* If work space is available on the right side of the indoor unit, the work can be performed with the electrical component box attached. Omit the steps involved with removing and installing the electrical component box in order to perform the work more efficiently.

**5-1. Remove the front grille (2 screws).**

**5-2. Remove the service lid (1 screw).**

**5-3. Remove the cover from the indoor unit electrical component box [Figure 1].**

- \* **5-4. Remove the indoor unit electrical component box.**

- 1) Remove the flap.
- 2) Disconnect the communication wiring.
- 3) Disconnect the connector (S200).
- 4) Remove the thermistor from the heat exchanger.
- 5) Remove the electrical component box installation screw (1 screw).

**Figure 1: Removing the cover from the indoor unit electrical component box**

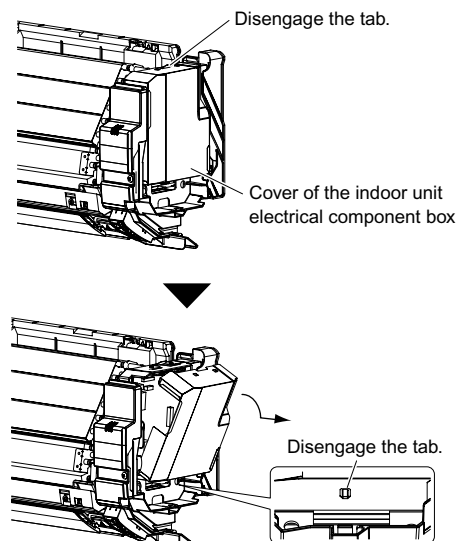

# Indoor Unit Installation

## 5-5. Prepare the accessory (separate product) [Figure 2].

- 1) Remove the cover from the accessory (separate product).
- 2) Insert the connection cord into connector "S21" (white) in the accessory (separate product).
- 3) Route each of the connection cords through the cut-outs in the accessory, then reinstall the accessory cover in its original position.
- 4) Insert the accessory (separate product) connector into connector "S403" in the indoor unit electrical component box. Then route the connection cord through the cut-out in the indoor unit electrical component box.

## 5-6. Install the cover of the electrical component box in its original position [Figure 3].

## 5-7. Install the accessory (separate product) [Figure 3].

- 1) Install the accessory (separate product) into the indoor unit electrical component box.
- 2) Route the connection cord as shown in [Figure 3].

## \* 5-8. Install the indoor unit electrical component box in its original position.

- 1) Install the flap.
- 2) Install the electrical component box (1 screw).
- 3) Install the thermistor in its original position on the heat exchanger.
- 4) Install the connector (S200) in its original position.
- 5) Connect the communication wiring in its original position.

## 5-9. Install the front grille in its original position (2 screws).

## 5-10. Install the service lid (1 screw).

Figure 2: Preparing the accessory

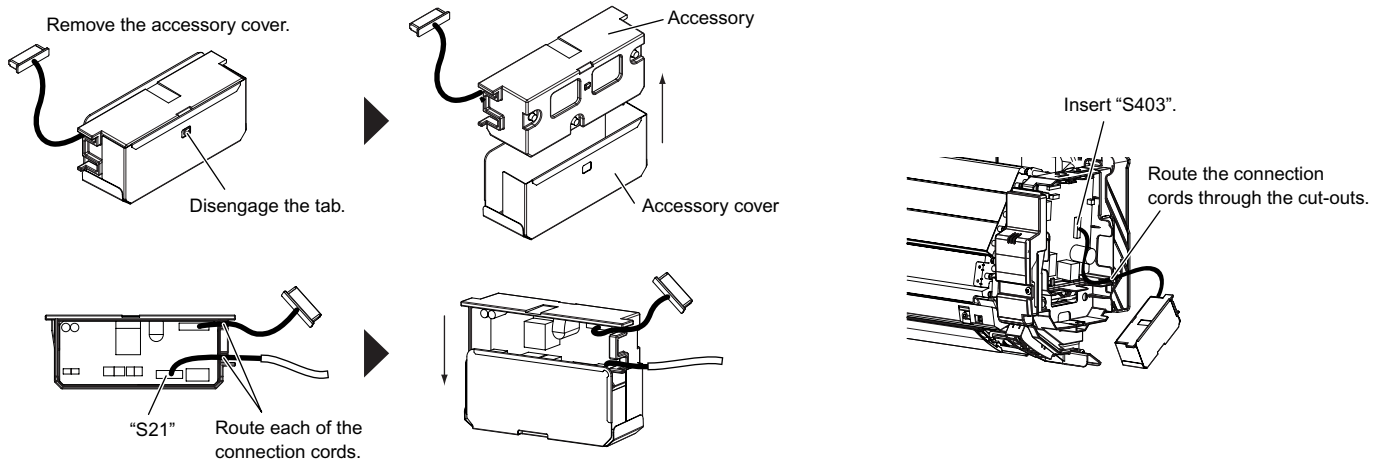
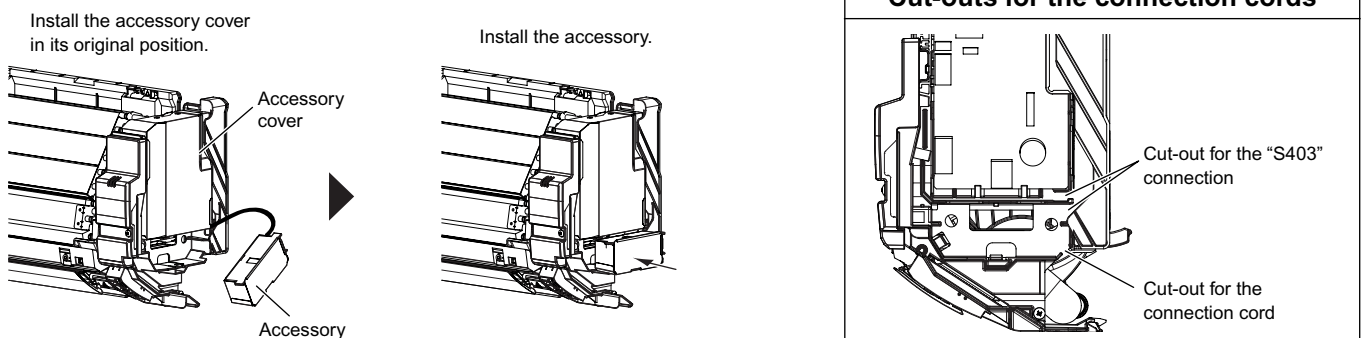
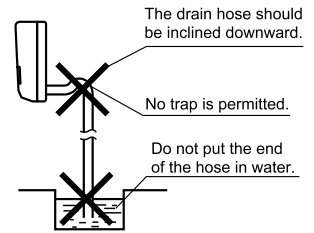

Figure 3: Installing the accessory



## 6. Drain piping.

1) Connect the drain hose, as described right.



2) Remove the air filters and pour some water into the drain pan to check the water flows smoothly.

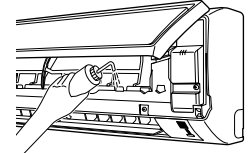

3) If drain hose extension or embedded drain piping is required, use appropriate parts that match the hose front end.

[Figure of Hose Front End]

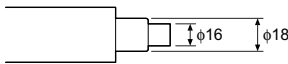

4) When extending the drain hose, use a commercially available extension hose with an inner diameter of 16 mm. Be sure to thermally insulate the indoor section of the extension hose.

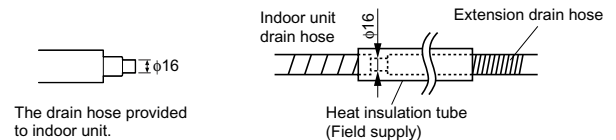

5) When connecting a rigid polyvinyl chloride pipe (nominal diameter 13mm) directly to the drain hose attached to the indoor unit as with embedded piping work, use any commercially available drain socket (nominal diameter 13mm) as a joint.

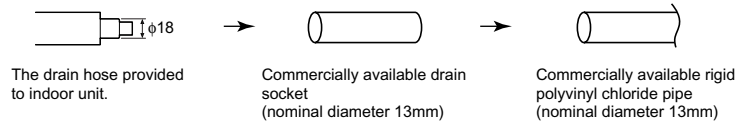

# Refrigerant Piping Work

## 1. Flaring the pipe end.

- 1) Cut the pipe end with a pipe cutter.
- 2) Remove burrs with the cut surface facing downward so that the chips do not enter the pipe.
- 3) Put the flare nut on the pipe.
- 4) Flare the pipe.
- 5) Check that the flaring is properly made.

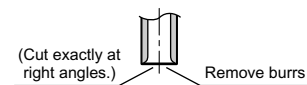

Flaring

Set exactly at the position shown below.

Die	Flare tool for R410A		
	Clutch-type	Clutch-type (Rigid-type)	Wing-nut type (Imperial-type)
A	0-0.5mm	1.0-1.5mm	1.5-2.0mm

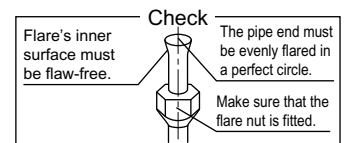

### ⚠ WARNING

- 1) Do not use mineral oil on flared part.
- 2) Prevent mineral oil from getting into the system as this would reduce the lifetime of the units.
- 3) Never use piping which has been used for previous installations. Only use parts which are delivered with the unit.
- 4) Do never install a drier to this R410A unit in order to guarantee its lifetime.
- 5) The drying material may dissolve and damage the system.
- 6) Incomplete flaring may cause refrigerant gas leakage.

# Refrigerant Piping Work

## 2. Refrigerant piping.

### ⚠ CAUTION

- 1) Use the flare nut fixed to the main unit. (To prevent cracking of the flare nut by aged deterioration.)
- 2) To prevent gas leakage, apply refrigeration oil only to the inner surface of the flare. (Use refrigeration oil for R410A.)
- 3) Use torque wrenches when tightening the flare nuts to prevent damage to the flare nuts and gas leakage.

Align the centres of both flares and tighten the flare nuts 3 or 4 turns by hand. Then tighten them fully with the torque wrenches.

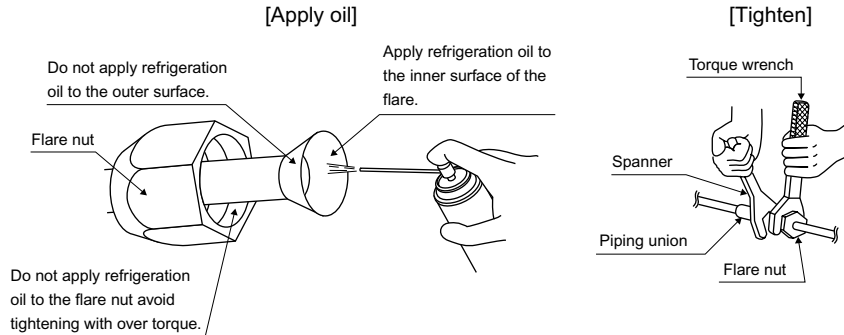

Flare nut tightening torque	
Gas side	Liquid side
3/8 inch	1/4 inch
32.7-39.9N • m (330-407kgf • cm)	14.2-17.2N • m (144-175kgf • cm)

### 2-1. Caution on piping handling.

- 1) Protect the open end of the pipe against dust and moisture.
- 2) All pipe bends should be as gentle as possible. Use a pipe bender for bending.  
(Bending radius should be 30 to 40mm or larger.)



### 2-2. Selection of copper and heat insulation materials.

- When using commercial copper pipes and fittings, observe the following:

- 1) Insulation material: Polyethylene foam  
Heat transfer rate: 0.041 to 0.052W/mK (0.035 to 0.045 kcal/(mh•°C))  
Refrigerant gas pipe's surface temperature reaches 110°C max.  
Choose heat insulation materials that will withstand this temperature.

- 2) Be sure to insulate both the gas and liquid piping and to provide insulation dimensions as below.

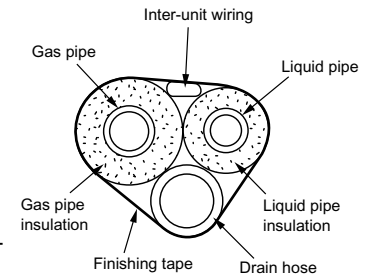

Gas side	Liquid side	Gas pipe thermal insulation	Liquid pipe thermal insulation
O.D. 9.5mm	O.D. 6.4mm	I.D. 12-15mm	I.D. 8-10mm
Thickness 0.8mm		Thickness 10mm Min.	

- 3) Use separate thermal insulation pipes for gas and liquid refrigerant pipes.

# Trial Operation and Testing

## 1. Trial operation and testing.

1-1 Measure the supply voltage and make sure that it falls in the specified range.

1-2 Trial operation should be carried out in either cooling or heating mode.

- In cooling mode, select the lowest programmable temperature; in heating mode, select the highest programmable temperature.
  - 1) Trial operation may be disabled in either mode depending on the room temperature. Use the remote controller for trial operation as described below.
  - 2) After trial operation is complete, set the temperature to a normal level (26°C to 28°C in cooling mode, 20°C to 24°C in heating mode).
  - 3) For protection, the system disables restart operation for 3 minutes after it is turned off.

1-3 Carry out the test operation in accordance with the Operation Manual to ensure that all functions and parts, such as louver movement, are working properly.

- The air conditioner requires a small amount of power in its standby mode. If the system is not to be used for some time after installation, shut off the circuit breaker to eliminate unnecessary power consumption.
- If the circuit breaker trips to shut off the power to the air conditioner, the system will restore the original operation mode when the circuit breaker is opened again.

### Trial operation from remote controller

- 1) Press ON/OFF button to turn on the system.
- 2) Simultaneously press centre of TEMP button and MODE button.
- 3) Press MODE button twice.  
(“7” will appear on the display to indicate that Trial Operation mode is selected.)
- 4) Trial run mode terminates in approx. 30 minutes and switches into normal mode. To quit a trial operation, press ON/OFF button.

## 2. Test items.

Test items	Symptom (diagnostic display on RC)	Check
Indoor and outdoor units are installed properly on solid bases.	Fall, vibration, noise	
No refrigerant gas leaks.	Incomplete cooling/heating function	
Refrigerant gas and liquid pipes and indoor drain hose extension are thermally insulated.	Water leakage	
Draining line is properly installed.	Water leakage	
System is properly earthed.	Electrical leakage	
The specified wires are used for interconnecting wire connections.	Inoperative or burn damage	
Indoor or outdoor unit's air intake or exhaust has clear path of air. Stop valves are opened.	Incomplete cooling/heating function	
Indoor unit properly receives remote controller commands.	Inoperative	

**DAIKIN INDUSTRIES, LTD.**

Head office:  
Umeda Center Bldg., 2-4-12, Nakazaki-Nishi,  
Kita-ku, Osaka, 530-8323 Japan

Tokyo office:  
JR Shinagawa East Bldg., 2-18-1, Konan,  
Minato-ku, Tokyo, 108-0075 Japan  
[http://www.daikin.com/global\\_ac/](http://www.daikin.com/global_ac/)

**DAIKIN EUROPE NV**

Zandvoordestraat 300, B-8400 Oostende, Belgium



Two-dimensional bar code is a code for manufacturing.

3P207973-2B

M07B063A (0712) HT