

**DAIKIN**

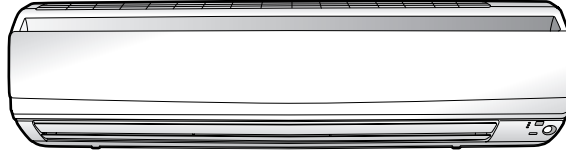

DAIKIN ROOM AIR CONDITIONER  
**INSTALLATION MANUAL**  
R410A Split Series

**INVERTER**

Installation manual  
Installationsanleitung  
Manuel d'installation  
Montagehandleiding  
Manual de instalación  
Manuale d'installazione  
Εγχειρίδιο εγκατάστασης  
Manual de Instalação  
Руководство по монтажу  
Montaj kılavuzları

**MODELS**

---

FTXS60GV1B

FTXS71GV1B

English

Deutsch

Français

Nederlands

Español

Italiano

Ελληνικά

Portugues

Русский

Türkçe

CE - DECLARATION-OF-COMFORMITY  
 CE - KONFORMITÄTSEKHLÄRUNG  
 CE - DECLARATION-DE-CONFORMITE  
 CE - CONFORMITEITSVERKLARING

CE - DECLARACION-DE-CONFORMIDAD  
 CE - DICHIARAZIONE-DI-CONFORMITA  
 CE - ΔΗΛΩΣΗ ΣΥΜΜΟΡΦΩΣΗΣ

CE - DECLARAÇÃO-DE-CONFORMIDADE  
 CE - ЗАРЯБЛЕННЕ-О-СОТВЕТСТВИИ  
 CE - ÖPFFYLDELSESEKHLÄRUNG  
 CE - FÖRSÄKRAN-OM-ÖVERENSTÄMMELSE

CE - ERKLÄRUNG OM-SÄMVAR  
 CE - ILMUOTUS-YHDENMUKAISUDESTA  
 CE - DEKLARACJA-ZGODNOSC  
 CE - DECLARAȚIE-DE-CONFORTITATE

CE - IZJAVA O USKLADENOSTI  
 CE - MEGFELELŐSÉGI-NYILATKOZAT  
 CE - DEKLARACJA-ZGODNOSC  
 CE - DECLARAȚIE-DE-CONFORTITATE

CE - IZJAVA O SKLADNOSTI  
 CE - ATBILSTIBAS-DEKLARACIJA  
 CE - VYHLÁSENIE-ZHODY  
 CE - UYUMLULUK-BILDIRISI

CE - ATTIKTIKIES-DEKLARACIJA  
 CE - ATBILSTIBAS-DEKLARACIJA  
 CE - VYHLÁSENIE-ZHODY  
 CE - UYUMLULUK-BILDIRISI

**DAIKIN INDUSTRIES, LTD.**

- 01 00 declares under its sole responsibility that the air conditioning models to which this declaration relates:
- 02 01 erklärt auf seine alleinige Verantwortung daß die Modelle der Klimaanlage für die diese Erklärung bestimmt ist:
- 03 01 déclare sous sa seule responsabilité que les appareils d'air conditionné visés par la présente déclaration:
- 04 00 verklaart hierbij op eigen exclusieve verantwoordelijkheid dat de airconditioning units waarop deze verklaring betrekking heeft:
- 05 01 dichiara bajo su única responsabilidad que los modelos de aire acondicionado a los cuales hace referencia la declaración:
- 06 01 dichiara sotto sua responsabilità che i condizionatori modello a cui è riferita questa dichiarazione:
- 07 01 δηλώνει με αποκλειστική της ευθύνη ότι τα μοντέλα των κλιματιστικών συσκευών στα οποία αναφέρεται η παρούσα δήλωση:
- 08 01 declara sob sua exclusiva responsabilidade que os modelos de ar condicionado a que esta declaração se refere:
- 09 00 заявляет, исключительнo под своим ответствеиенством, что модели кондиционеров воздуха, к которым относится настоящее заявление:

**FTXS60GV1B, FTXS71GV1B**

- 01 are in conformity with the following standard(s) or other normative document(s), provided that these are used in accordance with our instructions:
- 02 werden folgenden Norm(en) oder einen anderen Normdokument oder -dokumenten entsprechend/entsprechend, unter der Voraussetzung, daß sie gemäß unseren Anweisungen eingesetzt werden:
- 03 sont conformes à la(s) norm(e)(s) ou autre(s) document(s) normatif(s), pour autant qu'ils soient utilisés conformément à nos instructions:
- 04 conform de volgende norm(en) of één of meer andere bindende documenten zijn, op voorwaarde dat ze worden gebruikt overeenkomstig onze instructies:
- 05 están en conformidad con la(s) siguiente(s) norma(s) u otro(s) documento(s) normativo(s), siempre que sean utilizados de acuerdo con nuestras instrucciones:
- 06 sono conformi all(i) seguente(i) standard(i) o altro(i) documento(i) a carattere normativo, a patto che vengano usati in conformità alle nostre istruzioni:
- 07 είναι σύμφωνα με το(ι) ακόλουθο(ι) πρότυπο(ι) ή άλλο(α) έγγραφο(ι) κανονισμών, υπό την προϋπόθεση ότι χρησιμοποιούνται σύμφωνα με τις οδηγίες μας:

**EN60335-2-40,**

- 10 under iagttagelse af bestemmelserne i:
- 11 enligt vilkoren i:
- 12 gilt i henhold til bestemmelserne i:
- 13 noudatteen määrätysissä:
- 14 za obrzeten ustanoveni predpisu:
- 15 prema odredbama:
- 16 követeli az(i):
- 17 zgodnie z postanowieniami Dyrektywy:
- 18 in urma prevederilor:

- 01 Note \* as set out in <B> and judged positively by <B> according to the Certificate <B>.
- 02 Hinweis \* wie in der <B> aufgeführt und von <B> positiv beurteilt gemäß Zertifikat <B>.
- 03 Remarque \* tel que défini dans <B> et jugé positivement par <B> conformément au Certificat <B>.
- 04 Bemerk \* zoals vermeld in <B> en positief beoordeeld door <B> overeenkomstig Certificat <B>.
- 05 Nota \* como se establece en <B> y es valorado positivamente por <B> de acuerdo con el Certificado <B>.
- 06 Nota \* delimitat nel <B> e giudicato positivamente da <B> secondo il Certificat <B>.
- 07 Σημείωση \* όπως καθορίζεται στο <B> και κρίνεται θετικά από το <B> σύμφωνα με το Πρωτόκολλο <B>.
- 08 Nota \* tal como estabelecido em <B> e com o parecer positivo de <B> de acordo com o Certificado <B>.
- 09 Πμνησание \* как указано в <B> и в соответствии с полнительным решением <B> согласно Сертификату <B>.
- 10 Bemærk \* som anført i <B> og positivt vurderet af <B> i henhold til Certificat <B>.



Shinri Sada

Shinri Sada  
 Manager Quality Control Department  
 1st. of Sep. 2009

3SB64526-10B

- 10 00 erklærer under eneansvar, at klimaanlægmodelerne, som denne deklaration vedrører:
- 11 01 deklarerer i egen skap av hurtdataer, att luftkonditioneringsmodellerna som berörs av denna deklaration innebär att:
- 12 01 erklærer et fulførendig ansvar for at de luftkonditioneringsmodeller som berøres av denne deklarasjon innebærer at:
- 13 00 ilmoittaa yksinomaan omvat vastuullaan, että tämän ilmoituksen tarkoituksena on ilmoittaa ilmasoitteilaitteen mallit:
- 14 00 prohlásuje ve své plné odpovědnosti, že modely klimatizace, k nimž se tato prohlášení vztahuje:
- 15 00 izjavljuje pod isključivo vlastitom odgovornostjo da su modeli klima uređaja na koje se ova izjava odnosi:
- 16 01 teljes felelősséggel tudatában kijelenti, hogy a klímaberendezés modellek, melyekre e nyilatkozat vonatkozik:
- 17 01 deklarije na vlastoj izvjačajnoj odgovornosti, da modelle klimatizatorov, kojih dotiču ovaj imenik, zadovoljavaju zahtjeve propisane u ovom uvjetnom deklaraciji.
- 18 00 deklará de proprie răspunde că aparaturile de aer condiționat la care se referă această declarație:

- 08 estão em conformidade com a(s) seguinte(s) norma(s) ou outro(s) documento(s) normativo(s), desde que estes sejam utilizados de acordo com as nossas instruções:
- 09 соответствуют следующим стандартам или другим нормативным документам, при условии их использования согласно нашим инструкциям:
- 10 overholder følgende standard(er) eller ændringsstandard(er) dokument(er), brudtset at disse anvendes i henhold til vore instrukser:
- 11 respektive utrustning är utförd i överensstämmelse med och följer följande standard(er) eller andra normgivande dokument, under förutsättning att användning sker i överensstämmelse med våra instruktioner:
- 12 инспекции устй еri übereinstimmelse med folgende standard(er) eller andere normierende dokument(er), unter forutsætting av at disse brukes i henhold til våre instruksjoner:
- 13 vastaa seuraavien standardien ja muiden ohjeellisten dokumenttien vaatimukset edellyttäen, että niitä käytetään ohjeidemme mukaisesti:
- 14 se předpokládá, že jsou využívány v souladu s našimi pokyny, odpovídají následujícím normám nebo normativním dokumentům:
- 15 v skladu sa sledjućim standardom(ima) ili drugim normativnim dokumentom(ima), uz uvjet da se oni koriste u skladu s našim uputama:

**Low Voltage 2006/95/EC \*  
 Electromagnetic Compatibility 2004/108/EC \***

- 11 Information \* enligt <B> och godkännt av <B> enligt Certificat <B>.
- 12 Merk \* som det fremkommer i <B> og gennem positiv bedømmelse av <B> ifølge Serifikat <B>.
- 13 Huom \* jotta on esitetty asiantuntija <B> ja jotta <B> on hyväksynyt Serifikatin <B> mukaisesti.
- 14 Poznámka \* jak bylo uvedeno v <B> a pozitivně zjišeno <B> v souladu s ověřeními <B>.
- 15 Napomena \* kako je izloženo u <B> i pozitivno ocijenjeno od strane <B> prema Certificatu <B>.
- 16 Megjegyzás \* a(z) <B> alapján, a(z) <B> igazolta a megfelelőséget, a(z) <B> tanúsítvány szerint.
- 17 Uwaga \* zgodnie z dokumentacją <B>, pozytywną opinią <B> i świadectwem <B>.
- 18 Nota \* așa cum este stabilit în <B> și aprobat pozitiv în <B> în conformitate cu Certificatul <B>.
- 19 Opomba \* kot je obloženo v <B> in odobreno s strani <B> v skladu s ovrednitvami <B>.
- 20 Märkus \* nagu on näidatud dokumentis <B> ja heaks kiidetud <B> järgi vastavalt sertifitseeritule <B>.

- 01 Directives, as amended.
- 02 Direktiven, gemäß Änderung.
- 03 Directives, telles que modifiées.
- 04 Richtlijnen, zoals geamendeeerd.
- 05 Directivas, según lo emendado.
- 06 Direktive, come da modifica.
- 07 Ohjuid, jotka on muutettu.
- 08 Direktivas, conforme alteraçao em.
- 09 Direktive, av vesam popravakami.
- 20 Direktiver, med senere ændringer.
- 21 Direktiv med foretagne ændringer.
- 22 Direktive, med foretagne ændringer.
- 23 Direktive, seläsita kun ne ovat muutettuna.
- 24 Direktivas un to papildinajumos.
- 25 Snemnice, kako je izmijenjeno.
- 26 Snemnice, v platnom zneni.
- 27 Degjistrimijs hallerlye Yonetmeliker.
- 18 Direktive, av amendamentele respective.

- 21 Zabeleška \* kartu e razoveno s <B> v ojeleho porokromeno ot <B> certifikatno
- 22 Pastaba \* kopijustava <B> ir kapt leigama inspesta <B> pagal Serifikat <B>.
- 23 Píiznámus \* ka nosūtīts <B> un atbilstoš <B> pozitīvajam vērtējamam šķērsam s <B> s pozitīvu ziēšē <B> v šķērsā s ovērdēšan <B>.
- 24 Poznámka \* ako bolo ověřeno v <B> s potvrzujícím ověřeními <B>.
- 25 Not \* göre <B> aralarında omluiri olarak degerlendirildiği gibi.

<A>	DAIKIN; TCF.015 MT11/08-2009
<B>	KEMA Quality B.V.
<C>	74736-KRO/EIMC97-4957

**DAIKIN INDUSTRIES, LTD.**  
 Umeda Center Bldg., 2-4-12, Nakazaki-Nishi,  
 Kita-ku, Osaka, 530-8323 Japan



# Safety Precautions

- The precautions described herein are classified as WARNING and CAUTION. They both contain important information regarding safety. Be sure to observe all precautions without fail.
- Meaning of WARNING and CAUTION notices





 **WARNING .... Failure to follow these instructions properly may result in personal injury or loss of life.**



 **CAUTION ..... Failure to observe these instructions properly may result in property damage or personal injury, which may be serious depending on the circumstances.**

- The safety marks shown in this manual have the following meanings:

 Be sure to follow the instructions.	 Be sure to establish an earth connection.	 Never attempt.
---	---	--

- After completing installation, conduct a trial operation to check for faults and explain to the customer how to operate the air conditioner and take care of it with the aid of the operation manual.

 <b>WARNING</b>	
• Ask your dealer or qualified personnel to carry out installation work. Do not attempt to install the air conditioner yourself. Improper installation may result in water leakage, electric shocks or fire.	
• Install the air conditioner in accordance with the instructions in this installation manual. Improper installation may result in water leakage, electric shocks or fire.	
• Be sure to use only the specified accessories and parts for installation work. Failure to use the specified parts may result in the unit falling, water leakage, electric shocks or fire.	
• Install the air conditioner on a foundation strong enough to withstand the weight of the unit. A foundation of insufficient strength may result in the equipment falling and causing injury.	
• Electrical work must be performed in accordance with relevant local and national regulations and with instructions in this installation manual. Be sure to use a dedicated power supply circuit only. Insufficiency of power circuit capacity and improper workmanship may result in electric shocks or fire.	
• Use a cable of suitable length. Do not use tapped wires or an extension lead, as this may cause overheating, electric shocks or fire.	
• Make sure that all wiring is secured, the specified wires are used, and that there is no strain on the terminal connections or wires. Improper connections or securing of wires may result in abnormal heat build-up or fire.	
• When wiring the power supply and connecting the wiring between the indoor and outdoor units, position the wires so that the control box lid can be securely fastened. Improper positioning of the control box lid may result in electric shocks, fire or over heating terminals.	
• If refrigerant gas leaks during installation, ventilate the area immediately. Toxic gas may be produced if the refrigerant comes into contact with fire.	
• After completing installation, check for refrigerant gas leakage. Toxic gas may be produced if the refrigerant gas leaks into the room and comes into contact with a source of fire, such as a fan heater, stove or cooker.	
• When installing or relocating the air conditioner, be sure to bleed the refrigerant circuit to ensure it is free of air, and use only the specified refrigerant (R410A). The presence of air or other foreign matter in the refrigerant circuit causes abnormal pressure rise, which may result in equipment damage and even injury.	
• During installation, attach the refrigerant piping securely before running the compressor. If the compressor is not attached and the stop valve is open when the compressor is run, air will be sucked in, causing abnormal pressure in the refrigeration cycle, which may result in equipment damage and even injury.	
• During pump-down, stop the compressor before removing the refrigerant piping. If the compressor is still running and the stop valve is open during pump-down, air will be sucked in when the refrigerant piping is removed, causing abnormal pressure in the refrigeration cycle, which may result in equipment damage and even injury.	
• Be sure to earth the air conditioner. Do not earth the unit to a utility pipe, lightning conductor or telephone earth lead. Imperfect earthing may result in electric shocks.	
• Be sure to install an earth leakage breaker. Failure to install an earth leakage breaker may result in electric shocks or fire.	

 <b>CAUTION</b>	
• Do not install the air conditioner at any place where there is a danger of flammable gas leakage. In the event of a gas leakage, build-up of gas near the air conditioner may cause a fire to break out.	
• While following the instructions in this installation manual, install drain piping to ensure proper drainage and insulate piping to prevent condensation. Improper drain piping may result in indoor water leakage and property damage.	
• Tighten the flare nut according to the specified method such as with a torque wrench. If the flare nut is too tight, it may crack after prolonged use, causing refrigerant leakage.	

# Accessories

**Indoor unit** (A) – (H),

(A) Mounting plate	1	(D) Remote controller holder	1	(G) Operation manual	1
(B) Titanium apatite photocatalytic air-purifying filter	2	(E) Dry battery AAA. LR03 (alkaline)	2	(H) Installation manual	1
(C) Wireless remote controller	1	(F) Indoor unit fixing screw (M4 × 12L)	2		

## Choosing an Installation Site

- Before choosing the installation site, obtain user approval.

### 1. Indoor unit

- The indoor unit should be sited in a place where:
  - 1) the restrictions on installation specified in the indoor unit installation drawings are met,
  - 2) both air inlet and air outlet have clear paths met,
  - 3) the unit is not in the path of direct sunlight,
  - 4) the unit is away from the source of heat or steam,
  - 5) there is no source of machine oil vapour (this may shorten indoor unit life),
  - 6) cool (warm) air is circulated throughout the room,
  - 7) the unit is away from electronic ignition type fluorescent lamps (inverter or rapid start type) as they may shorten the remote controller range,
  - 8) the unit is at least 1m away from any television or radio set (unit may cause interference with the picture or sound),
  - 9) install at the recommended height (1.8m).

### 2. Wireless remote controller

- 1) Turn on all the fluorescent lamps in the room, if any, and find the site where remote controller signals are properly received by the indoor unit (within 7m).
  - 2) Make the DIP switch settings. Set according to the type of unit purchased by the customer. The default settings are on the heat pump side.
- **For cooling only** (Outdoor unit model: RKS)  
Set the DIP switch on the cooling only side.

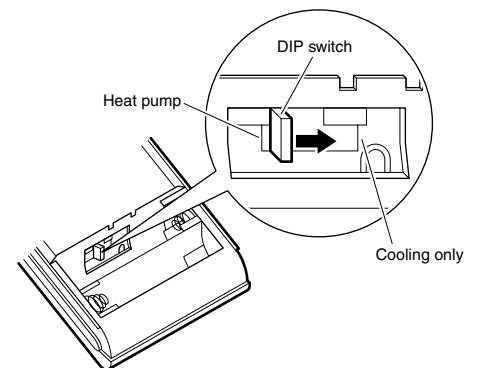

- **For heat pump** (Outdoor unit model: RXS)  
Check that the DIP switch are on the heat pump side.  
If they are set on the cooling only side, move them to the heat pump side.

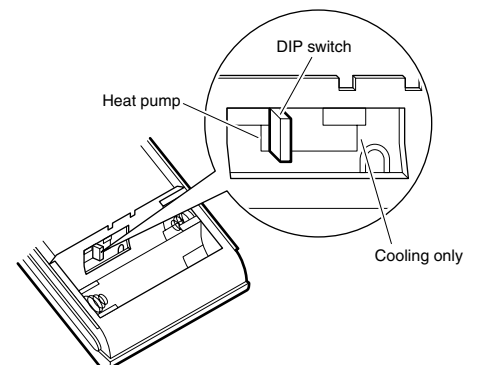

# Indoor Unit Installation Drawings

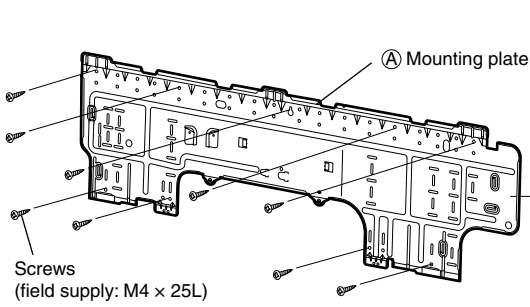

The mounting plate should be installed on a wall which can support the weight of the indoor unit.

- **How to attach the indoor unit**  
Hook the claws of the bottom frame to the mounting plate. If the claws are difficult to hook, remove the front grille.
- **How to remove the indoor unit**  
Push up the marked area (at the lower part of the front grille) to release the claws. If it is difficult to release, remove the front grille.

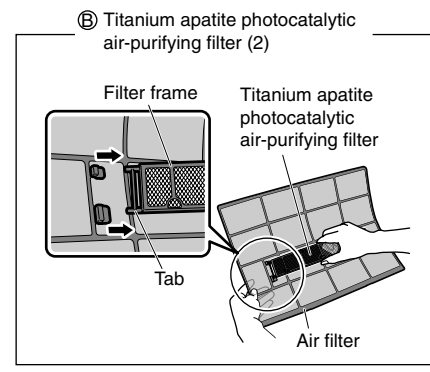
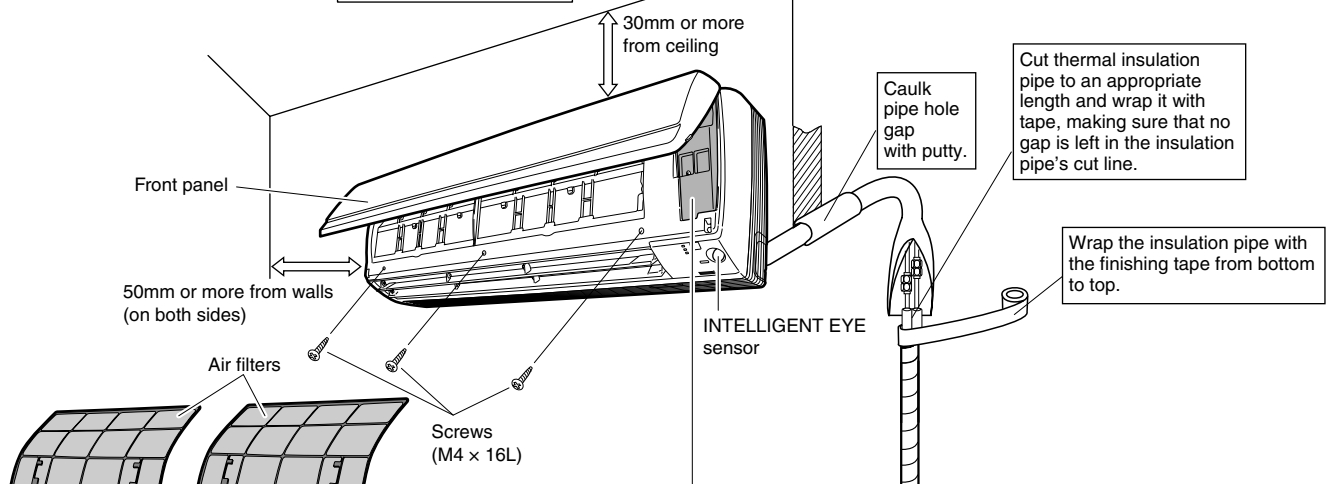
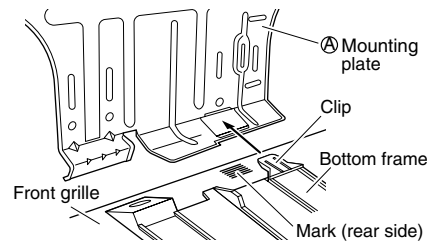

**Service lid**

- **Opening service lid**  
Service lid is opening/closing type.
- **Opening method**
  - 1) Remove the service lid screws.
  - 2) Pull out the service lid diagonally down in the direction of the arrow.
  - 3) Pull down.

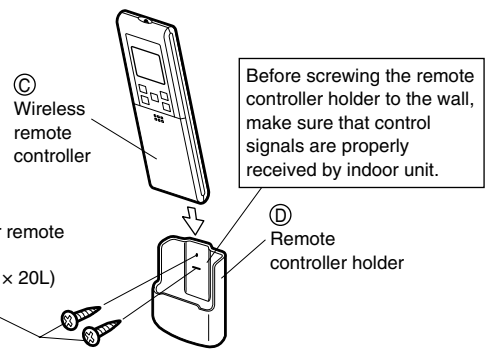

## INTELLIGENT EYE sensor

### ⚠ CAUTION

- Do not hit or violently push the INTELLIGENT EYE sensor. This can lead to damage and malfunction.
- Do not place large objects near the sensor. Also keep heating units or humidifiers outside the sensor's detection area.

# Preparation before Installation

## 1. Removing and installing front panel

### • Removal method

Hook fingers on the tabs on the left and right of the main body, and open until the panel stops. Slide the front panel sideways to disengage the rotating shaft. Then pull the front panel toward you to remove it.

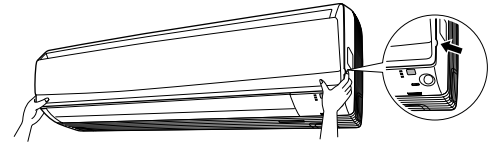

### • Installation method

Align the tabs of the front panel with the grooves, and push all the way in. Then close slowly. Push the center of the lower surface of the panel firmly to engage the tabs.

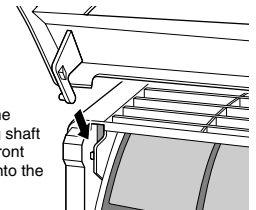
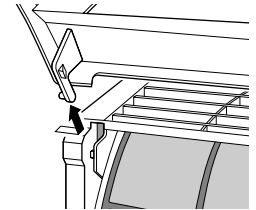

Push the rotating shaft of the front panel into the groove.

## 2. Removing and installing front grille

### • Removal method

- 1) Remove front panel to remove the air filter.
- 2) Remove 3 screws from the front grille.
- 3) In front of the ○○○ mark of the front grille, there are 3 upper hooks. Lightly pull the front grille toward you with one hand, and push down on the hooks with the fingers of your other hand.

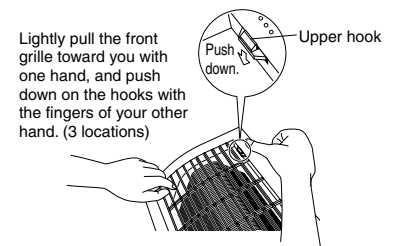
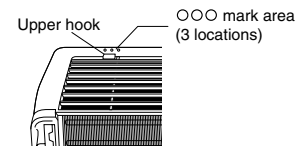

## When there is no work space because the unit is close to ceiling

### ⚠ CAUTION

- Be sure to wear protection gloves.

Place both hands under the center of the front grille, and while pushing up, pull it toward you.

### • Installation method

- 1) Install the front grille and firmly engage the upper hooks (3 locations).
- 2) Install 3 screws of the front grille.
- 3) Install the air filter and then mount the front panel.

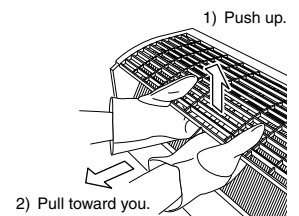

# Preparation before Installation

## 3. How to set the different addresses

When two indoor units are installed in one room, the two wireless remote controllers can be set for different addresses.

- 1) Remove the metal plate electrical wiring cover.  
(Refer to the **Removal/attachment methods of metal plate electrical wiring covers.**)
- 2) Cut the address jumper (JA) on the printed circuit board.
- 3) Cut the address jumper in the remote controller.

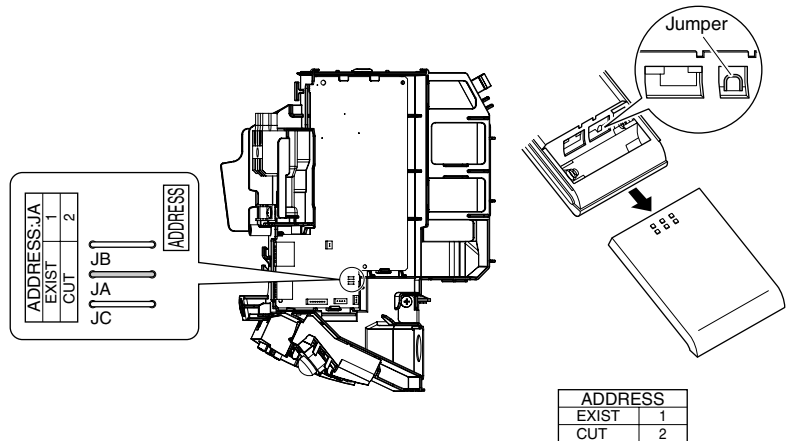

## 4. When connecting to an HA system (wired remote controller, central remote controller etc.)

- 1) Remove the metal plate electrical wiring cover.  
(Refer to the **Removal/attachment methods of metal plate electrical wiring covers.**)
- 2) Attach the connection cord to the S21 connector and pull the harness out through the notched part in the figure.
- 3) Replace the electrical wiring cover as it was, and pull the harness around, as shown in the figure.

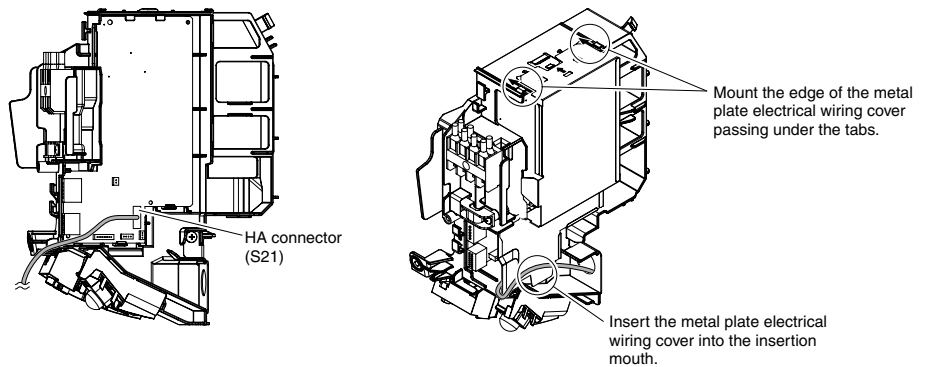

### • Removal methods of metal plate electrical wiring cover

- 1) Remove the front grille. (3 screws)
- 2) Remove the electrical wiring box. (1 screw)
- 3) Remove the 4 tabs, and pull and disconnect the metal plate electrical wiring cover from the single insertion mouth.

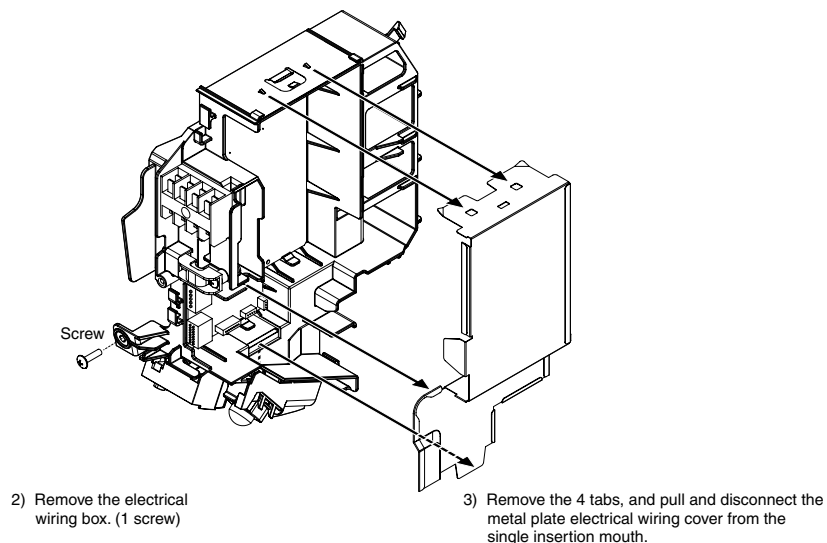

### • Attachment methods of metal plate electrical wiring cover

Attach the metal plate electrical wiring cover as shown below.

- 1) Lean the metal plate electrical wiring cover as shown in the figure and insert the tab on the lower side.
- 2) Push in the upper part of the metal plate electrical wiring cover and attach the 4 tabs.

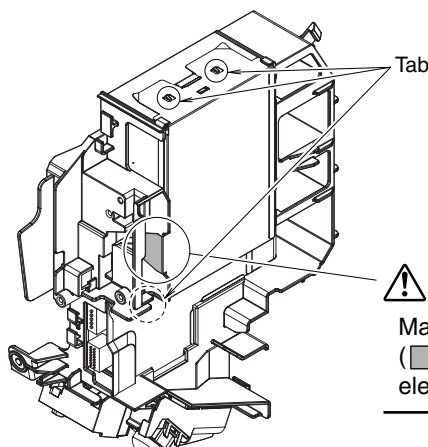
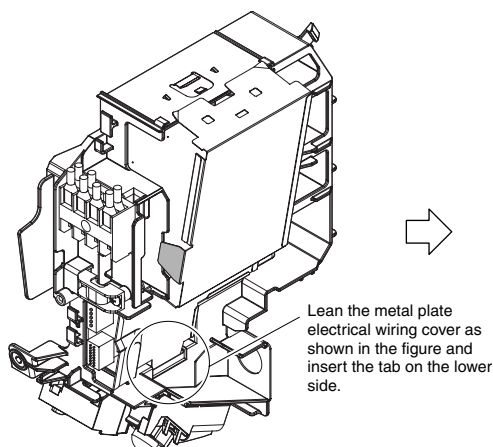

**CAUTION**  
Make sure that the shaded part ( ) will not go inside the electrical wiring box.

# Refrigerant Piping Work

**With a multi indoor unit**, install as described in the installation manual supplied with the multi outdoor unit.

## 1. Flaring the pipe end

- 1) Cut the pipe end with a pipe cutter.
- 2) Remove burrs with the cut surface facing downward so that the chips do not enter the pipe.
- 3) Put the flare nut on the pipe.
- 4) Flare the pipe.
- 5) Check that the flaring is properly made.

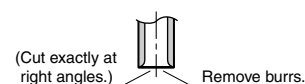

Flaring

Set exactly at the position shown below.

Flare tool for R410A	Conventional flare tool		
	Clutch-type	Clutch-type (Rigid-type)	Wing-nut type (Imperial-type)
A	0-0.5mm	1.0-1.5mm	1.5-2.0mm

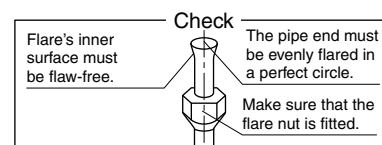

### **WARNING**

- Do not use mineral oil on flared part.
- Prevent mineral oil from getting into the system as this would reduce the lifetime of the units.
- Never use piping which has been used for previous installations. Only use parts which are delivered with the unit.
- Do never install a drier to this R410A unit in order to guarantee its lifetime.
- The drying material may dissolve and damage the system.
- Incomplete flaring may cause refrigerant gas leakage.



# Refrigerant Piping Work

## 2. Refrigerant piping

### ⚠ CAUTION

- Use the flare nut fixed to the main unit. (To prevent cracking of the flare nut by aged deterioration.)
- To prevent gas leakage, apply refrigeration oil only to the inner surface of the flare. (Use refrigeration oil for R410A.)
- Use torque wrenches when tightening the flare nuts to prevent damage to the flare nuts and gas leakage.

Align the centres of both flares and tighten the flare nuts 3 or 4 turns by hand. Then tighten them fully with the torque wrenches.

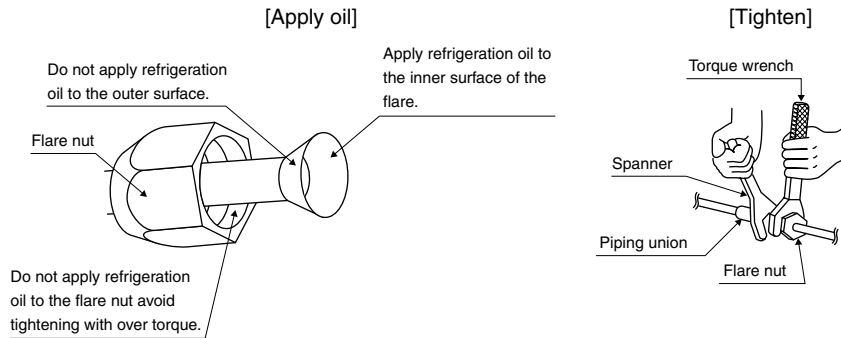

Flare nut tightening torque		
Gas side		Liquid side
1/2 inch	5/8 inch	1/4 inch
49.5-60.3N • m (505-615kgf • cm)	61.8-75.4N • m (630-770kgf • cm)	14.2-17.2N • m (144-175kgf • cm)

### 2-1. Caution on piping handling

- 1) Protect the open end of the pipe against dust and moisture.
- 2) All pipe bends should be as gentle as possible. Use a pipe bender for bending.

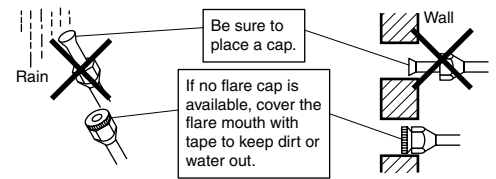

### 2-2. Selection of copper and heat insulation materials

- When using commercial copper pipes and fittings, observe the following:
  - 1) Insulation material: Polyethylene foam  
Heat transfer rate: 0.041 to 0.052W/mK (0.035 to 0.045kcal/mh°C)  
Refrigerant gas pipe's surface temperature reaches 110°C max.  
Choose heat insulation materials that will withstand this temperature.

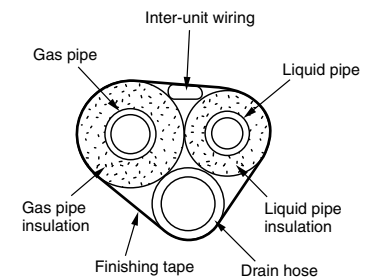

- 2) Be sure to insulate both the gas and liquid piping and to provide insulation dimensions as below.

Gas side		Liquid side	Gas pipe thermal insulation		Liquid pipe thermal insulation
60 class	71 class	O.D. 6.4mm	60 class	71 class	I.D. 8-10mm
O.D. 12.7mm	O.D. 15.9mm		I.D. 14-16mm	I.D. 16-20mm	
Minimum bend radius			Thickness 10mm Min.		
40mm or more	50mm or more	30mm or more			
Thickness 0.8mm (C1220T-O)	Thickness 1.0mm (C1220T-O)	Thickness 0.8mm (C1220T-O)			

- 3) Use separate thermal insulation pipes for gas and liquid refrigerant pipes.

# Indoor Unit Installation

## 1. Installing the mounting plate

- The mounting plate should be installed on a wall which can support the weight of the indoor unit.
  - Temporarily secure the mounting plate to the wall, make sure that the panel is completely level, and mark the boring points on the wall.
  - Secure the mounting plate to the wall with screws.

### Recommended mounting plate retention spots and dimensions

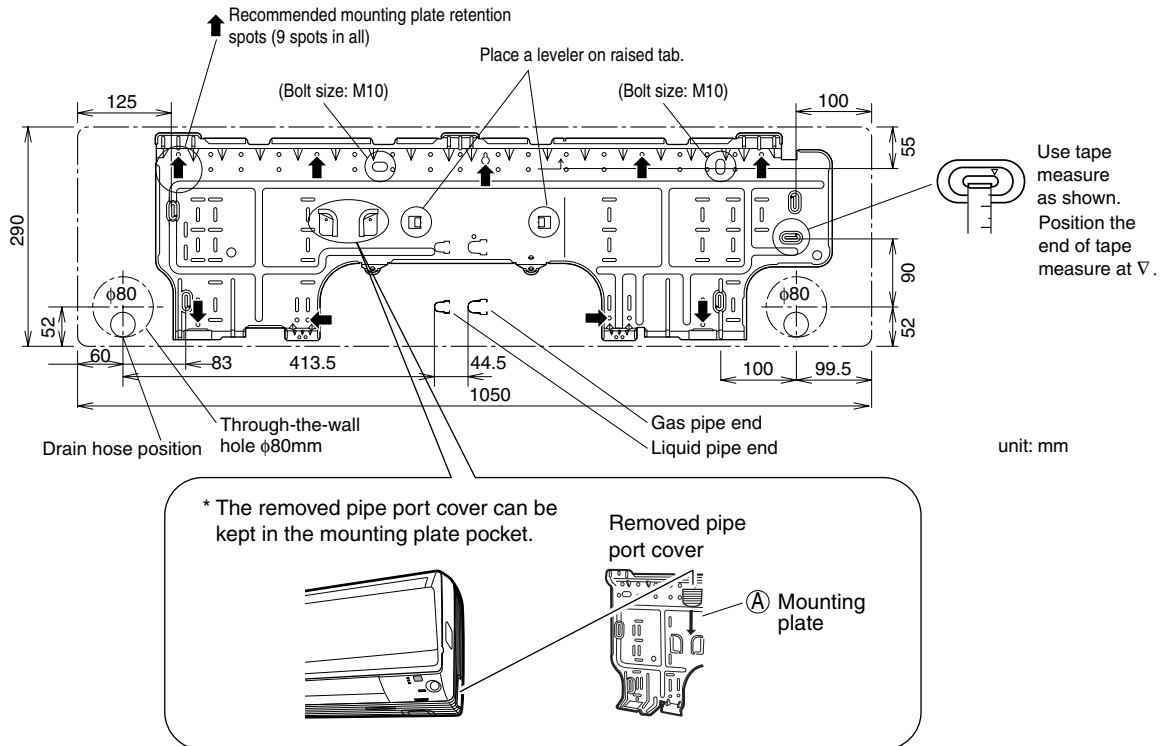

## 2. Boring a wall hole and installing wall embedded pipe

- For walls containing metal frame or metal board, be sure to use a wall embedded pipe and wall cover in the feed-through hole to prevent possible heat, electrical shock, or fire.
- Be sure to caulk the gaps around the pipes with caulking material to prevent water leakage.
  - Bore a feed-through hole of 80mm in the wall so it has a down slope toward the outside.
  - Insert a wall pipe into the hole.
  - Insert a wall cover into wall pipe.
  - After completing refrigerant piping, wiring, and drain piping, caulk pipe hole gap with putty.

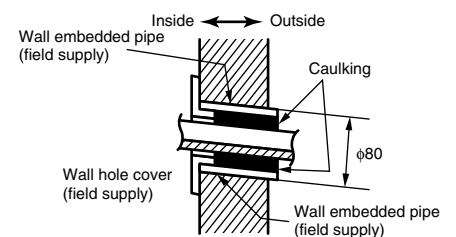

## 3. Inter-unit wiring

- Open the front panel, then remove the service lid.
- Pass the inter-unit wiring from the outdoor unit through the feed-through wall hole and then through the back of the indoor unit. Pull them through the front side. Bend the ends of tie wires upward for easier work in advance. (If the inter-unit wiring ends are to be stripped first, bundle wire ends with adhesive tape.)
- Press the bottom frame of the indoor unit with both hands to set it on the mounting plate hooks. Make sure the wires do not catch on the edge of the indoor unit.

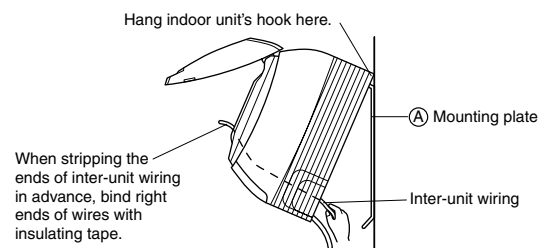

# Indoor Unit Installation

## 4. Laying piping, hoses, and wiring

### 4-1. Right-side, right-back, or right-bottom piping

- 1) Attach the drain hose to the underside of the refrigerant pipes with adhesive vinyl tape.
- 2) Wrap the refrigerant pipes and drain hose together with insulation tape.
- 3) Pass the drain hose and refrigerant pipes through the wall hole, then set the indoor unit on the mounting plate hooks by using the  $\Delta$  markings at the top of the indoor unit as a guide.

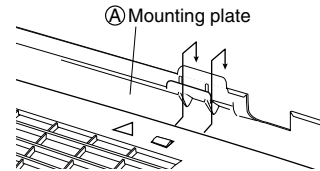
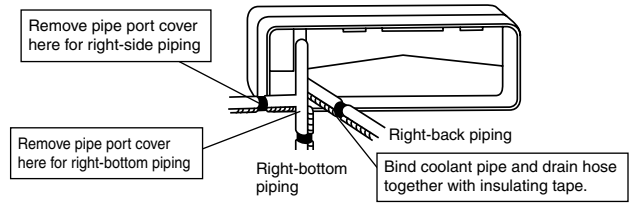

### 4-2. Left-side, left-back, or left-bottom piping

- 1) Replace the drain plug and drain hose.
- 2) Attach the drain hose to the underside of the refrigerant pipes with adhesive vinyl tape.
- 3) Be sure to connect the drain hose to the drain port in place of a drain plug.

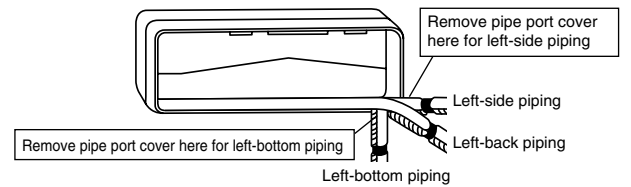

#### How to set drain plug

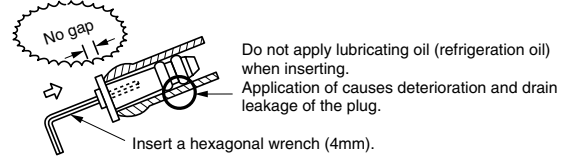

- 4) Shape the refrigerant pipe along the pipe path marking on the mounting plate.
- 5) Pass drain hose and refrigerant pipes through the wall hole, then set the indoor unit on mounting plate hooks, using the  $\Delta$  markings at the top of indoor unit as a guide.
- 6) Pull in the inter-unit wiring.
- 7) Connect the inter-unit piping.
- 8) Wrap the refrigerant pipes and drain hose together with insulation tape as right figure, in case of setting the drain hose through the back of the indoor unit.
- 9) While exercising care so that the inter-unit wiring do not catch indoor unit, press the bottom edge of indoor unit with both hands until it is firmly caught by the mounting plate hooks. Secure indoor unit to the mounting plate with indoor unit fixing screws (M4 × 12L).

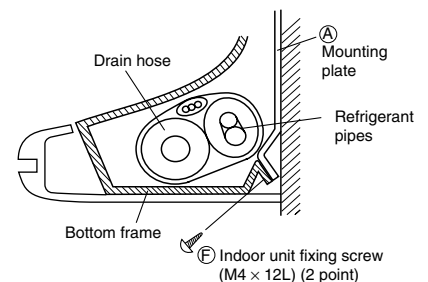
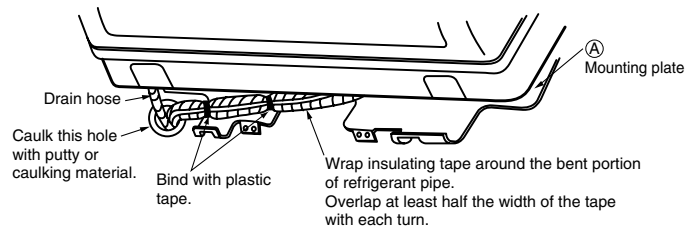

### 4-3. Wall embedded piping

Follow the instructions given under left-side, left-back, or left-bottom piping.  
Insert the drain hose to this depth so it won't be pulled out of the drain pipe.

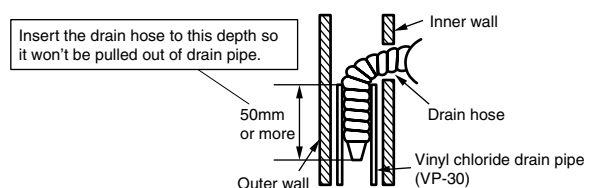

## 5. Wiring

**With a multi indoor unit** , install as described in the installation manual supplied with the multi outdoor unit.

- 1) Strip wire ends (15mm).
- 2) Match wire colours with terminal numbers on indoor and outdoor unit's terminal blocks and firmly screw wires to the corresponding terminals.
- 3) Connect the earth wires to the corresponding terminals.
- 4) Pull wires to make sure that they are securely latched up, then retain wires with wire retainer.
- 5) In case of connecting to an adapter system. Run the remote controller cable and attach the S21.
- 6) Shape the wires so that the service lid fits securely, then close service lid.

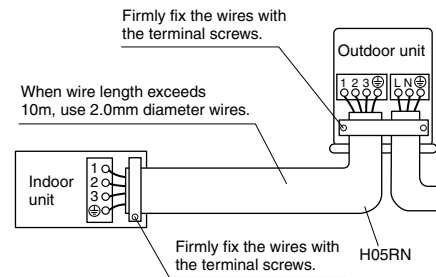
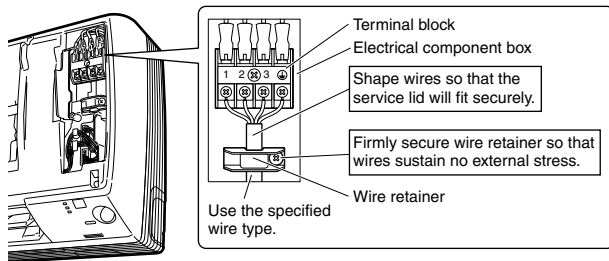

### ⚠ WARNING

- Do not use tapped wires, strand wires, extension cords, or starburst connections, as they may cause overheating, electrical shock, or fire.
- Do not use locally purchased electrical parts inside the product. (Do not branch the power for the drain pump, etc., from the terminal block.) Doing so may cause electric shock or fire.

## 6. Drain piping

- 1) Connect the drain hose, as described right.

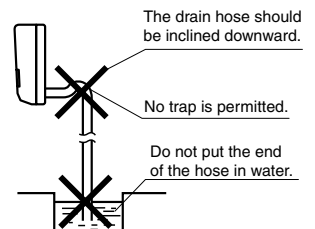

- 2) Remove the air filters and pour some water into the drain pan to check the water flows smoothly.

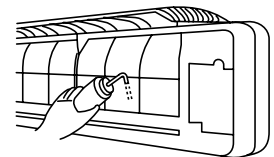

- 3) When drain hose requires extension, obtain an extension hose commercially available.  
Be sure to thermally insulate the indoor section of the extension hose.

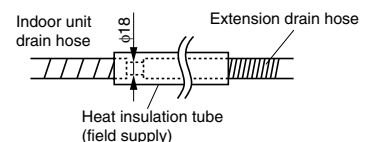

- 4) When connecting a rigid polyvinyl chloride pipe (nominal diameter 13mm) directly to the drain hose attached to the indoor unit as with embedded piping work, use any commercially available drain socket (nominal diameter 13mm) as a joint.

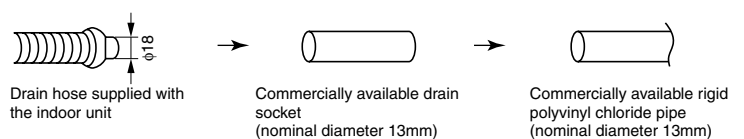

# Trial Operation and Testing

## 1. Trial operation and testing

1-1 Measure the supply voltage and make sure that it falls in the specified range.

1-2 Trial operation should be carried out in either cooling or heating mode.

- In cooling mode, select the lowest programmable temperature; in heating mode, select the highest programmable temperature.
    - 1) Trial operation may be disabled in either mode depending on the room temperature. Use the remote controller for trial operation as described below.
    - 2) After trial operation is complete, set the temperature to a normal level (26°C to 28°C in cooling mode, 20°C to 24°C in heating mode).
    - 3) For protection, the system disables restart operation for 3 minutes after it is turned off.
- 1-3 Carry out the test operation in accordance with the operation manual to ensure that all functions and parts, such as louver movement, are working properly.
- The air conditioner requires a small amount of power in its standby mode. If the system is not to be used for some time after installation, shut off the circuit breaker to eliminate unnecessary power consumption.
  - If the circuit breaker trips to shut off the power to the air conditioner, the system will restore the original operation mode when the circuit breaker is opened again.

### Trial operation from remote controller

- 1) Press "ON/OFF" button to turn on the system.
- 2) Press "TEMP" button (2 locations) and "MODE" button at the same time.
- 3) Press "TEMP" button and select "7".
- 4) Press "MODE" button.
- 5) Trial operation terminates in approx. 30 minutes and switches into normal mode. To quit a trial operation, press "ON/OFF" button.

## 2. Test items

Test Items	Symptom (diagnostic display on RC)	Check
Indoor and outdoor units are installed properly on solid bases.	Fall, vibration, noise	
No refrigerant gas leaks.	Incomplete cooling/heating function	
Refrigerant gas and liquid pipes and indoor drain hose extension are thermally insulated.	Water leakage	
Draining line is properly installed.	Water leakage	
System is properly earthed.	Electrical leakage	
The specified wires are used for inter-unit wiring connections.	Inoperative or burn damage	
Indoor or outdoor unit's air inlet or air outlet has clear path of air. Stop valves are opened.	Incomplete cooling/heating function	
Indoor unit properly receives remote control commands.	Inoperative	
The heat pump or cooling only mode is selectable with the DIP switch of the remote controller.	Remote controller malfunctioning	

**DAIKIN INDUSTRIES, LTD.**

Head office:  
Umeda Center Bldg., 2-4-12, Nakazaki-Nishi,  
Kita-ku, Osaka, 530-8323 Japan

Tokyo office:  
JR Shinagawa East Bldg., 2-18-1, Konan,  
Minato-ku, Tokyo, 108-0075 Japan  
[http://www.daikin.com/global\\_ac/](http://www.daikin.com/global_ac/)

**DAIKIN EUROPE NV**

Zandvoordestraat 300, B-8400 Oostende, Belgium



Two-dimensional bar code is a code for manufacturing.

3P248445-1

M08B303 (0911) HT