

Installation Manual of Room Air Conditioner







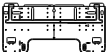

- Read this manual before installation
- Explain sufficiently the operating means to the user according to this manual.

Necessary Tools for Installation

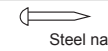
- | | | | |
|---------------------------|---------------------------------|----------------------------------------------------|-----------|
| 1.Driver | 5.Torque wrench(17mm,22mm,26mm) | 9.Nipper | 12.Reamer |
| 2.Hacksaw | 6.Pipe cutter | 10.Gas leakage detector or soap-and-water solution | |
| 3.Hole core drill | 7.Flaring tool | 11.Measuring tape | |
| 4.Spanner(17,19 and 26mm) | 8.Knife | | |

Drawing for the installation of indoor and outdoor units

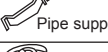
Accessory parts

No.	Accessory parts	Number of articles
①	Remote controller	1
②	 R-03 dry battery	2
③	 Mounting plate	1
④	 Drain hose	1
⑤	 $\phi 4 \times 50$ Steel nail, cement	6
⑥	 $\phi 4 \times 25$ Screw Plastic cap	4
⑦	 Cover	1
⑧	 Cushion	4
⑨	 Pipe supporting plate	1
⑩	 Drain-elbow	1

Optional parts for piping

Mark	Parts name
(A)	Non-adhesive tape
(B)	Adhesive tape
(C)	Saddle(L.S) with screws
(D)	Connecting electric cable for indoor and outdoor
(E)	Drain hose
(F)	Heating insulating material
(G)	Piping hole cover

Arrangement of piping directions

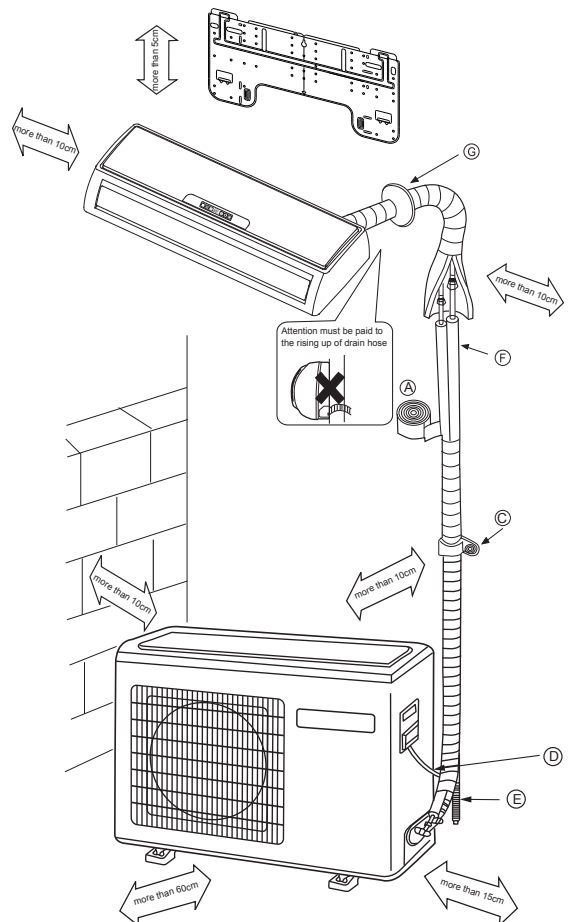
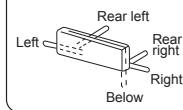

※ The marks from (A) to (G) in the figure are the parts numbers.

※ The distance between the indoor unit and the floor should be more than 2m.

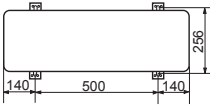

Floor fixing dimensions of the outdoor unit (Unit:mm)

HSU-07HEA03
HSU-09HEA03
HSU-12HEA03
HSU-18HEA03

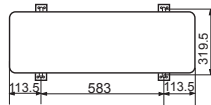
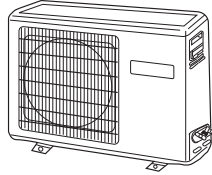

Floor fixing dimensions of the outdoor unit (Unit:mm)

HSU-22HEA03

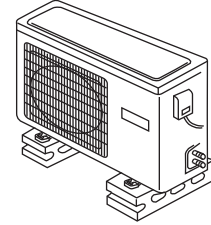

Fixing of outdoor unit

- Fix the unit to concrete or block with bolts(ϕ 10mm) and nuts firmly and horizontally.
- When fitting the unit to wall surface, roof or rooftop, fix a supporter surely with nails or wires in consideration of earthquake and strong wind.
- If vibration may affect the house, fix the unit by attaching a vibration-proof mat.

Indoor Unit

Selection of Installation Place

Outdoor Unit

- Place, robust not causing vibration, where the body can be supported sufficiently.
- Place, not affected by heat or steam generated in the vicinity, where inlet and outlet of the unit are not disturbed.
- Place, possible to drain easily, where piping can be connected with the outdoor unit.
- Place, where cold air can be spread in a room entirely.
- Place, nearby a power receptacle, with enough space around. (Refer to drawings).
- Place where the distance of more than 1m from televisions, radios, wireless apparatuses and fluorescent lamps can be left.
- In the case of fixing the remote controller on a wall, place where the indoor unit can receive signals when the fluorescent lamps in the room are lightened.
- Place, which is less affected by rain or direct sunlight and is sufficiently ventilated.
- Place, possible to bear the unit, where vibration and noise are not increased.
- Place, where discharged wind and noise do not cause a nuisance to the neighbors.
- Place, where a distance marked \Leftrightarrow is available as illustrated in the above figure.

Power Source

- Before inserting power plug into receptacle, check the voltage without fail. The power source is the same as the corresponding name plate.
- Install an exclusive branch circuit of the power.
- A receptacle shall be set up in a distance where the power cable can be reached. Do not extend the cable by cutting it.

Selection of pipe

- To this unit, both liquid and gas pipes shall be insulated as they become low temperature in operation.
- Use optional parts for piping set or pipes covered with equivalent insulation material.

	For 07 09	For 12 18	For 22
Liquid pipe (ϕ)	6.35mm(1/4")	6.35mm(1/4")	9.52mm(3/8")
Gas pipe (ϕ)	9.52mm(3/8")	12.7mm(1/2")	15.88mm(5/8")

Indoor unit

Indoor unit

1. Fitting of the Mounting Plate and Positioning of the wall Hole

When the mounting plate is first fixed

1. Carry out, based on the neighboring pillars or lintels, a proper leveling for the plate to be fixed against the wall, then temporarily fasten the plate with one steel nail.
2. Make sure once more the proper level of the plate, by hanging a thread with a weight from the central top of the plate, then fasten securely the plate with the attachment steel nail.
3. Find the wall hole location A using a measuring tape

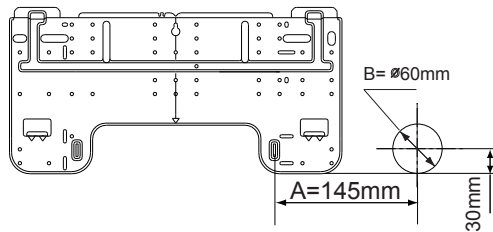

When the mounting plate is fixed side bar and lintel

- Fix to side bar and lintel a mounting bar, which is separately sold, and then fasten the plate to the fixed mounting bar.
- Refer to the previous article, " **When the mounting plate is first fixed** ", for the position of wall hole.

2. Making a Hole on the Wall and Fitting the Piping Hole Cover

- Make a hole of 60 mm in diameter, slightly descending to outside the wall.
- Install piping hole cover and seal it off with putty after installation

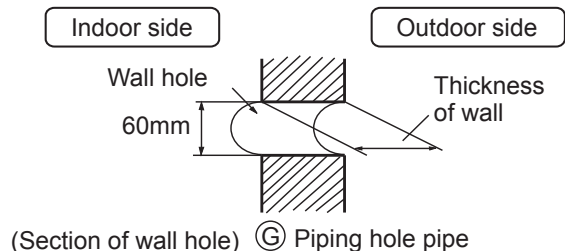

3. Installation of the Indoor Unit

Drawing of pipe

[Rear piping]

- Draw pipes and the drain hose, then fasten them with the adhesive tape

[Left • Left-rear piping]

- In case of left side piping, cut away, with a nipper, the lid for left piping.
- In case of left-rear piping, bend the pipes according to the piping direction to the mark of hole for left-rear piping which is marked on heat insulation materials.

Indoor unit

1. Insert the drain hose into the dent of heat insulation materials of indoor unit.
2. Insert the indoor/outdoor electric cable from backside of indoor unit, and pull it out on the front side, then connect them.
3. Coat the flaring seal face with refrigerant oil and connect pipes.
Cover the connection part with heat insulation materials closely, and make sure fixing with adhesive tape

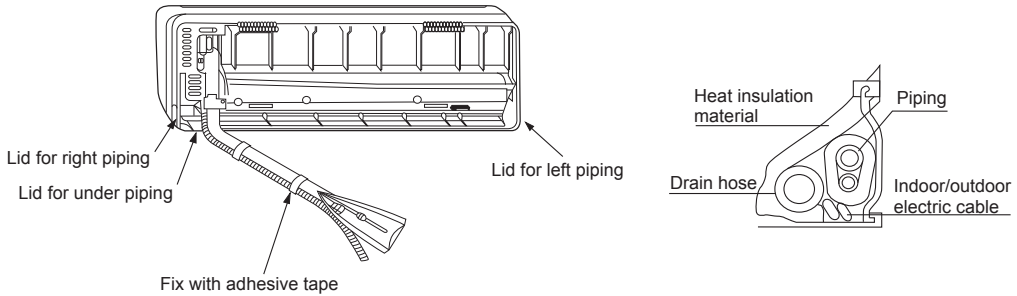

- Indoor/outdoor electric cable and drain hose must be bound with refrigerant piping by protecting tape.

[Other direction piping]

- Cut away, with a nipper, the lid for piping according to the piping direction and then bend the pipe according to the position of wall hole. When bending, be careful not to crash pipes.
- Connect beforehand the indoor/outdoor electric cable, and then pull out the connected to the heat insulation of connecting part specially.

Fixing the indoor unit body

- Hang surely the unit body onto the upper notches of the mounting plate. Move the body from side to side to verify its secure fixing.
- In order to fix the body onto the mounting plate, hold up the body aslant from the underside and then put it down perpendicularly.

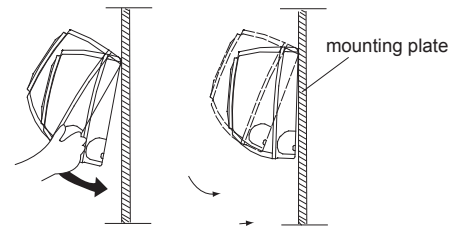

Unloading of indoor unit body

- When you unload the indoor unit, please use your hand to arise the body to leave agraffe, then lift the bottom of the body outward slightly and lift the unit aslant until it leaves the mounting plate.

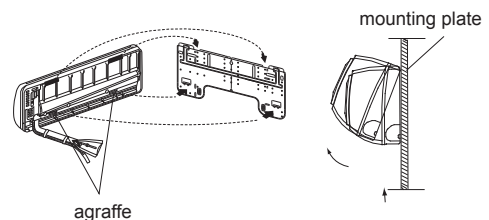

Easily-demount cleaning of indoor unit

Inlet grille can be taken down

Open the inlet grille, press the button of unlock in the left, then push it out of the socket and take out the inlet grille.

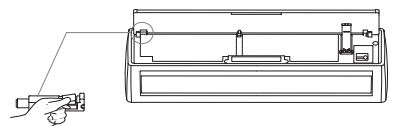

Outdoor unit

Outdoor unit

1. Installation of Outdoor Unit

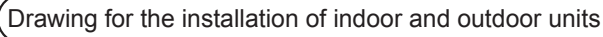
Install according to 

2. Connection of pipes

- To bend a pipe, give the roundness as large as possible not to crush the pipe
- Connecting the pipe of gas side first makes working easier.
- The max vertical distance between the indoor unit and the outdoor unit is 5 m.

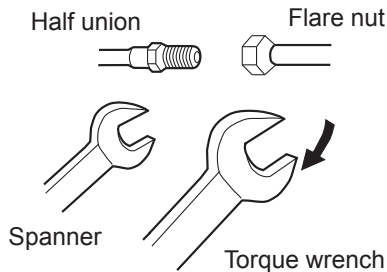

Forced fastening without careful centering may damage the threads and cause a leakage of gas.

Pipe Diameter (ϕ)	Fastening torque
Liquid side 6.35mm(1/4")	18N.m
Liquid side 9.52mm(3/8")	40N.m
Gas side 9.52mm(3/8")	42N.m
Gas side 12.7mm(1/2")	50N.m
Gas side 15.88mm(5/8")	60N.m

Be careful that matters, such as wastes of sands, etc. shall not enter the pipe.

3. Connection

- Use the same method on indoor unit. Loosen the screws on terminal block and insert the plugs fully into terminal block, then tighten the screws.
- Insert the cable according to terminal number in the same manner as the indoor unit.
- If wiring is not correct, proper operation can not be carried out and controller may be damaged.
- Fix the cable with a clamp.

4. Attaching Drain-Elbow

- If the drain-elbow is used, please attach it as figure. (Note: Only for heat pump unit.)

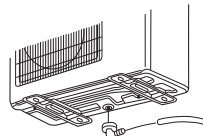

Outdoor unit

5.Purging Method:

Push the air out of the indoor unit and piping as follows:

- (1) Remove the valve cap on 2-way valve in outdoor unit.
- (2) Loosen by 1/2 turn the flare nut of gas pipe, which is conneted to 3-way valve.
- (3) Loosen 2-way valve by 90° using hexagon wrench, and after approx. 10 sec tighten it up. Gas comes out through flare nut on wide pipe. If no gas is discharged, tighten flare nut with specified torque.
- (4) Open 2-way and 3-way valves using specified torque.
- (5) Tighten the caps on the valves with specified torque.

	Tighten torque N.m
Valve rod	7-9
Valve cap	20-25

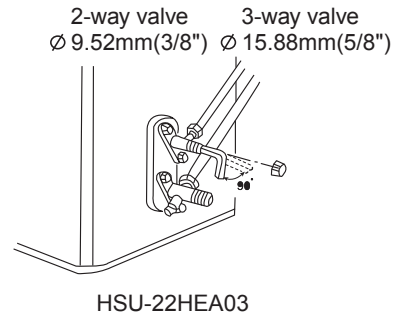
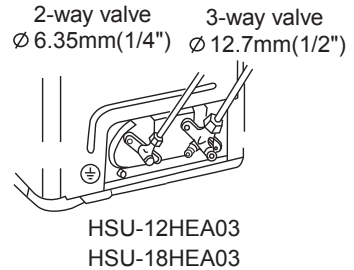
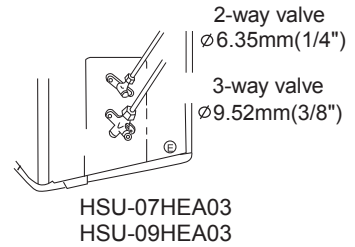

- When connecting pipe exceeds 5 meters, 20g or 60g(only for 22k) refrigerant shall be added per exceeding meter . Charge according to the following list.

	for 7k 9k 12k 18k		
Piping length	5m	7m	10m
Additional amount	No need	40g	100g

	for 22k		
Piping length	5m	7m	10m
Additional amount	No need	120g	300g

- Note: When extending piping, air inside piping shall be removed by using external refrigerant gas, charge according to the following list.

Brand new outdoor unit is charged 50g or 80g (only for 22k) more refrigerant than regulated weight. Only for first installation, this extra 50g or 80g (only for 22k) can be used to purge air in pipes.

- ★ 1 During this procedure, 50g or 80g (only for 22k)refrigerant will be discharged in piping.
(This must be strictly controlled within 90° and 10 sec.)

1. Power Source Installation

- The power source must be exclusively used for air conditioner. (Over 10A)
- In the case of installing an air conditioner in a moist place, please install an earth leakage breaker.
- For installation in other places, use a circuit breaker as far as possible.

2. Cutting and Flaring Work of Piping

- Pipe cutting is carried out with a pipe cutter and burs must be removed.
- After inserting the flare nut, flaring work is carried out.

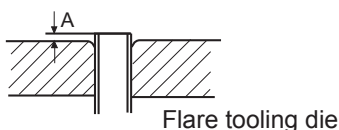

	Pipe diameter(ϕ)	Size A(mm)
Liquid side	6.35mm(1/4")	0.8~1.5
Liquid side	9.52mm(3/8")	1.0~1.8
Gas side	9.52mm(3/8")	1.0~1.8
Gas side	12.7mm(1/2")	1.2~2.0
Gas side	15.88mm(5/8")	1.4~2.2

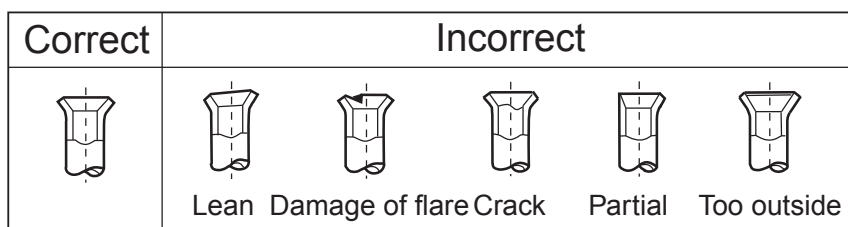

3. On Drainage

Please install the drain hose so as to be downward slope without fail.
Please don't do the drainage as shown below.

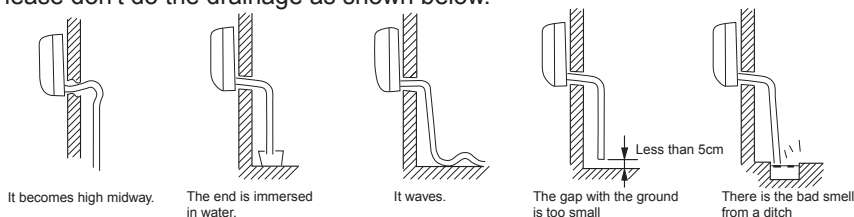

- Please pour water in the drain pan of the indoor unit, and confirm that drainage is carried out surely to outdoor.
- In case that the attached drain hose is in a room, please apply heat insulation to it without fail.

Check for Installation and Test Run

- Please kindly explain to our customers how to operate through the instruction manual.

Check Items for Test Run

- Put check mark \checkmark in boxes
- | | | |
|------------------------------------------------------------------------------------------------------------------|----------------------------------------------------------------------|------------------------------------------------------------------------------------------|
| <input type="checkbox"/> Gas leak from pipe connecting? | <input type="checkbox"/> Is drainage securely carried out? | <input type="checkbox"/> Is the lamp normally lighting? |
| <input type="checkbox"/> Heat insulation of pipe connecting? | <input type="checkbox"/> Is the earth line securely connected? | <input type="checkbox"/> Are cooling and heating (when in heat pump) performed normally? |
| <input type="checkbox"/> Are the connecting wirings of indoor and outdoor firmly inserted to the terminal block? | <input type="checkbox"/> Is the indoor unit securely fixed? | <input type="checkbox"/> Is the operation of room temperature regulator normal? |
| <input type="checkbox"/> Is the connecting wiring of indoor and outdoor firmly fixed? | <input type="checkbox"/> Is power source voltage abided by the code? | |
| | <input type="checkbox"/> Is there any noise? | |