



Domestic Air conditioner

TECHNICAL DATA

ON/OFF

Wall mounted Type ARC-Series

HSU-07C03



CAUTION

1. READ THIS MANUAL CAREFULLY TO
DIAGNOSE TROUBLE CORRECTLY
BEFORE OFFERING SERVICE.
2. THIS MANUAL IS USED BY QUALIFIED
APPLIANCE TECHNICIANS ONLY.
3. HAIER DOES NOT ASSUME ANY
RESPONSIBILITY FOR PROPERTY
DAMAGE OR PERSONAL INJURY FOR
IMPROPER
SERVICE PROCEDURES DONE BY ONE
UNQUALIFIED PERSON.

Table of Contents

1. Features	2
2. Specifications	3
3. Remote controller lists	6
4. Sensors lists	6
5. Dimensional drawings	7
6. Operation range	9
7. Piping diagrams	10
8. Wiring diagrams	11
9. Capacity diagrams and curves diagrams	13
10. Sound level	14
11. Accessories	15
12. Control systems	16
13. Center of gravity	18
14. Installations	19

1 Features



Anti-mold filter: Catches most small particles and remove unpleasant odors effectively .



Child lock: Avoid the child's wrong operation on the remote controller .



Auto mode: According to the fixed temperature "26C",the unit will adjust the operation mode automatically.



Auto restart: The function permits automatic return to previous peration conditions after asudden power blackout .



Sleep mode: The setting temperature and the indoor noise can be adjusted to a more comfortable level when you set the "sleep mode"during night sleep .



24Hour timer: Use the timer function to set on,or off,or from on to off,or from off to on .



4 Fan setting: Slect the fan speed LO,MED,HI,AUTO



Easy clean design: The panel is easy to wash and the airflow vents can be detached without any special tools for quick cleaning of the inside of the air conditioner .



2. Specifications

This information was not available at the time of publication .

NOMINAL CAPACITY and NOMINAL INPUT					
Model			HSU-07C03		
NOMINAL CAPACITY(3-4)	Cooling(1)	norm.	kw	2.10	
	Heating(2)	norm.	kw	-----	
NOMINAL INPUT	Cooling	norm	kw	0.72	
	Heating	norm.	kw	-----	
EER	Cooling			2.92	
COP	Heating			-----	
ENERGY LABEL(7-8)	Cooling			----	
	Heating			----	
ANNUAL ENERGY CONSUMPTION(9)	Cooling		kwh	307.5	

TECHNICAL SPECIFICATIONS						
INDOOR UNITS				HSU-07C03		
DIMENSIONS	Unit	H	mm	265		
		W	mm	795		
		D	mm	182		
WEIGHT	Unit		kg	7.2		
COLOR	Unit			white		
SOUND LEVEL	Sound pressure (cooling/heating)(5)	high	dB(A)	37		
		medium	dB(A)	35		
		low	dB(A)	30		
	Sound power(cooling/heating)(6)	high	dB(A)	37		
FAN	Air flow rate(cooling/heating)	high	m ³ /min	6.8		
		low	m ³ /min	6.0		
		super low	m ³ /min	5.2		
	Speed(cooling/heating)	steps		5steps,silent and auto		
		high	rpm	1150		
		medium	rpm	1100		
		low	rpm	920		
Type	Cross flow fan					
Motor output		W	16			
AIR FILTER	Removable/washable/mildew proof					
REMOTE CONTROLLER	YL-M05EN					
TEMPERATURE CONTROL	Microcomputer control					
PIPING CONNECTIONS(external diameter)	liquid	mm	Φ 6.35			
	gas	mm	Φ 9.52			
	drain	mm	Φ 16			
INSULATION MATERIAL	Heat insulation type				both liquid and gas pipes	
HEAT EXCHANGGER	TYPE				ML fin - Φ 9.52HI - XA tube	
	Row x stage x fin pinth			mm	2 x 8 x1.4	

TECHNICAL SPECIFICATIONS					
OUTDOOR UNITS				HSU-07C03	
NET DIMENSIONS (stop valve, and bottom support is not included)	Unit	H	mm	430	
		W	mm	695	
		D	mm	245	
WEIGHT	Unit		kg	22	
COLOR	Unit	white			
SOUND LEVEL	Sound pressure(cooling/heating)(5)	high	dB(A)	54	
	Sound power(cooling/heating)(6)	high	dB(A)	54	
FAN	Air flow rate(cooling/heating)	high	m ³ /min	21	
		low	m ³ /min	---	
	Speed(cooling/heating)	high	rpm	830	
		low	rpm	---	
	Type	Propeller fan			
	Motor output		W	60	
REFRIGERANT CIRCUIT	Refrigerant type	R22			
	Refrigerant charge		kg	0.54	
	Maximum allowable distance between indoor and outdoor		m	7	
	Maximum allowable level difference		m	5	
	Refrigerant control	-----			
COMPRESSOR	Type	rotary Compressor			
	Model	RECHI 44R193AE-FJS			
	Motor output		w	790	
	Oil type	SUNISO 4GSI			
	Oil charge volume		L	0.27	
PIPING CONNECTIONS	liquid		mm	Φ 6.35	
	gas		mm	Φ 9.52	
	drain		mm	Φ 18	
INSULATION MATERIAL	Heat insulation type			both liquid and gas pipes	
HEAT EXCHANGGER	TYPE			ML - Φ 9.52HI - XAbube	
	Row x stage x fin pinth		mm	2 x 8 x1.4	

ELECTRICAL SPECIFICATIONS					
For indoor units only:			HSU-07C03		
CURRENT	Nominal running current	cooling	A	0.15	
		heating	A	-----	
	Maximum running current	cooling	A	0.15	
		heating	A	-----	

For combination indoor units+ outdoor units:				HSU-07C03	
CURRENT	Nominal running current	cooling	A	3.4	
		heating	A	-----	
	Maximum running current	cooling	A	4.6	
		heating	A	-----	
	Starting current	cooling	A	18	
		heating	A	-----	

For indoor units only:				HSU-07C03	
POWER SUPPLY				VM	
NOMINAL DISTRIBUTION SYSTEM VOLTAGE	Phase		1PH		
	Frequency	Hz	50		
	Voltage	V	220V~		

NOTES

- 1 Nominal cooling capacities are based on: indoor temperature 27°CDB/19°CWB * outdoor temperature 35°CDB * refrigerant piping length: 5m * level difference: 0m.
- 2 Nominal heating capacities are based on: indoor temperature 20°CDB * outdoor temperature 7°CDB/6°CWB * refrigerant piping length 5m (horizontal) * level difference 0m.
- 3 Capacities are net, including a deduction for cooling (an addition for heating) for indoor fan motor heat.
- 4 Units should be selected on nominal capacity. Maximum capacity is limited to peak periods.
- 5 The sound pressure level is measured via a microphone at a certain distance from the unit. For measuring conditions: please refer to item 6 of this chapter.
- 6 The sound power level is an absolute value indicating the "power" which a sound source generates.
- 7 Energy label: scale from A (most efficient) to G (less efficient).
- 8 The energy label Directive 2002/31/EC will enter into force once the relevant measurement standard will be published in the European official Standard.
- 9 Annual energy consumption: based on average use of 500 running hours per year at full load (= nominal conditions)

3 Remote controller lists

Model	HSU-07C03	
YR-M05	Y	
YR-H10	Y	

4 Sensors lists

INDOOR UNIT		
type	Description	Qty
Room sensor	It's used for detecting room temperature	1
Pipe sensor	It's used for detecting temperature of evaporator	1

5 Dimensional drawings

Indoor unit

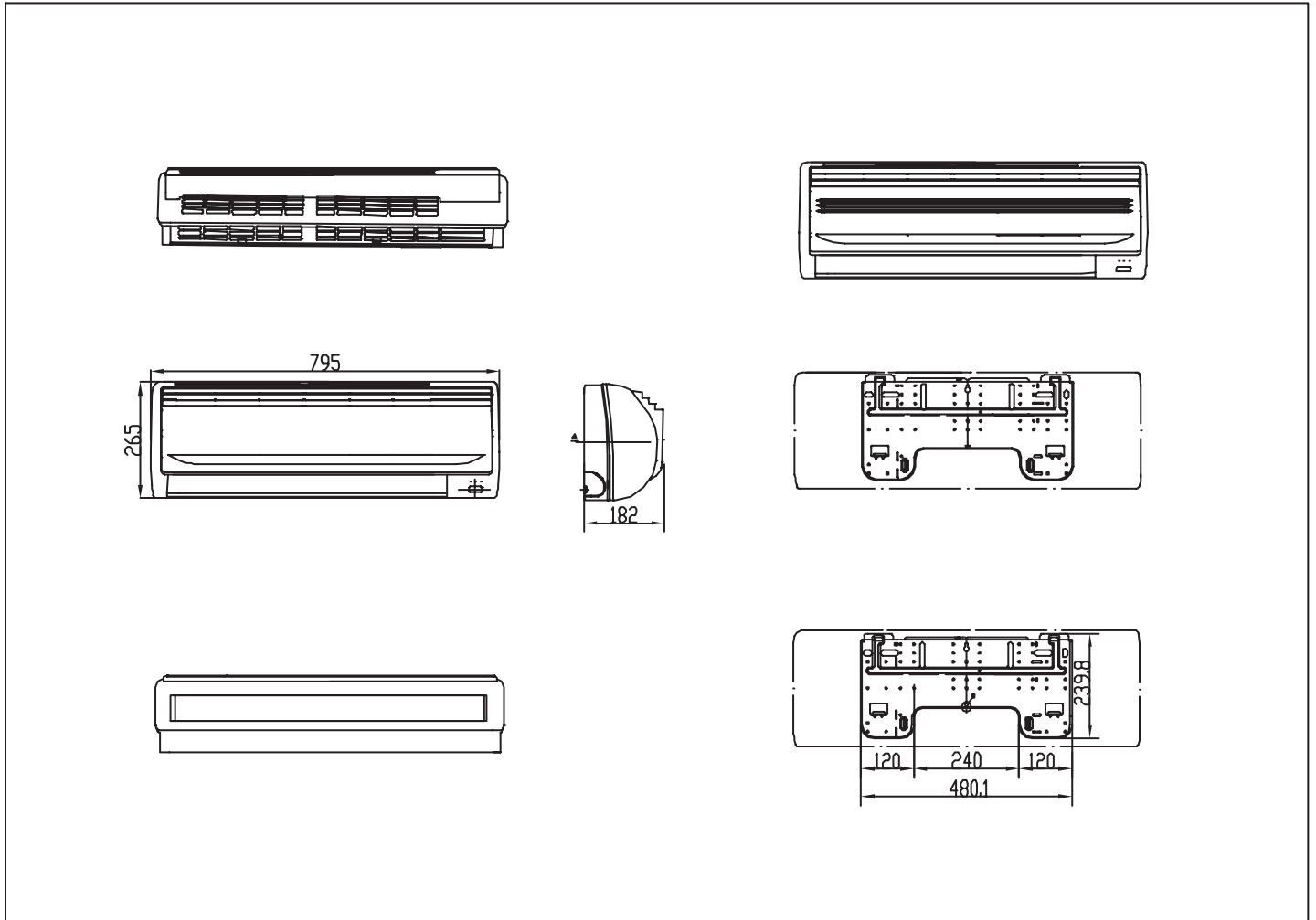

Outdoor unit

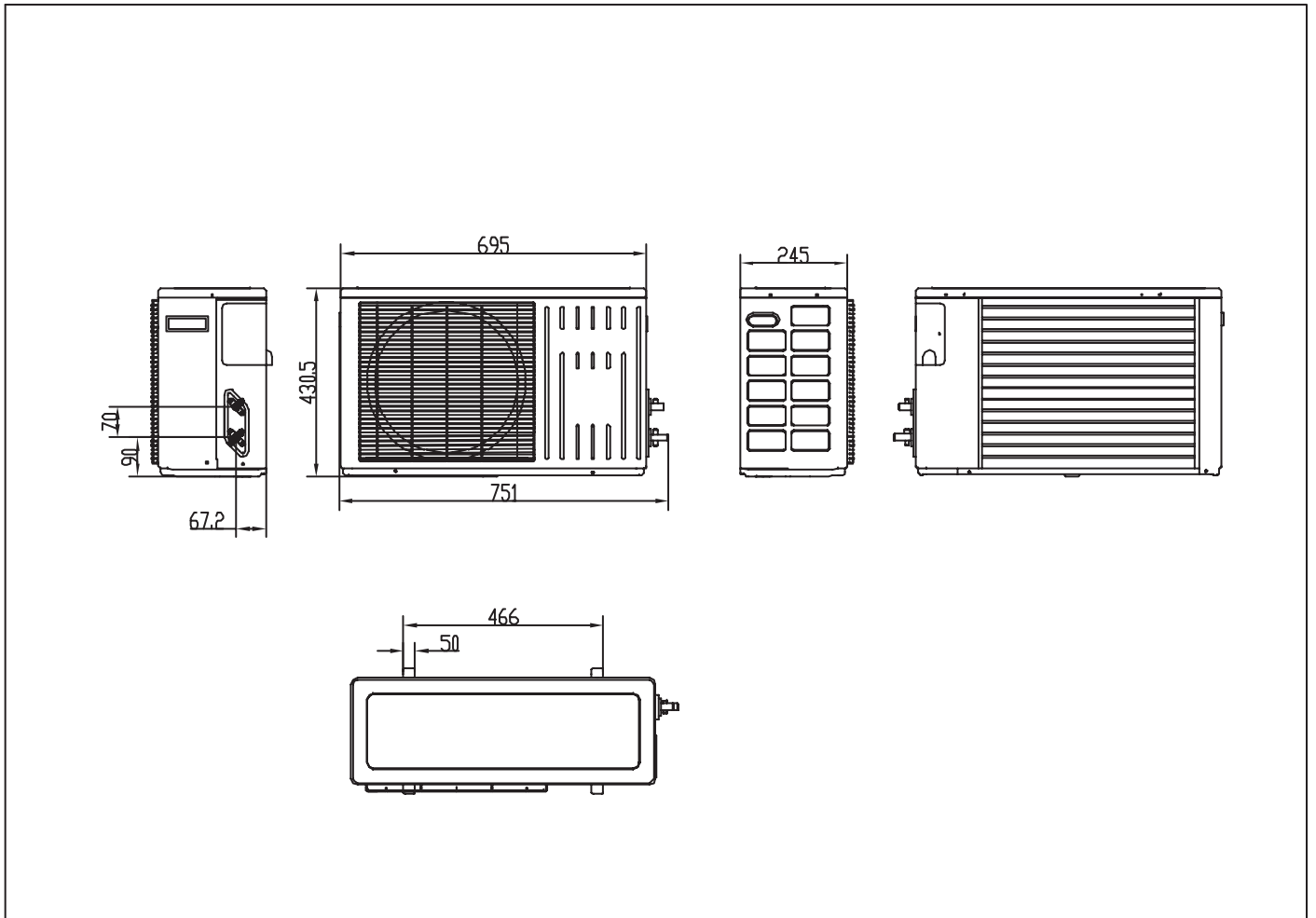

6 Operation range

The name of parts

Cooling

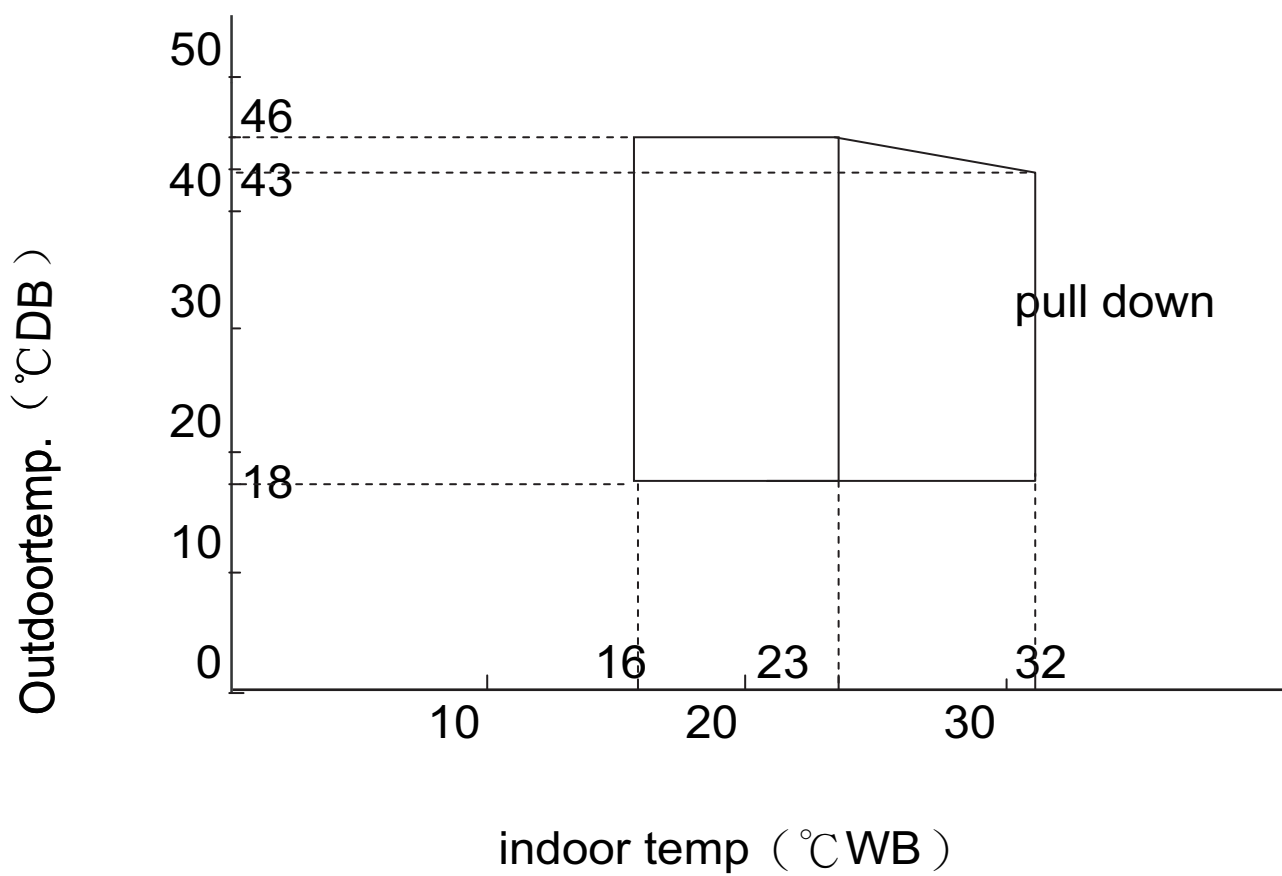

7 Piping diagrams

Cooling mode

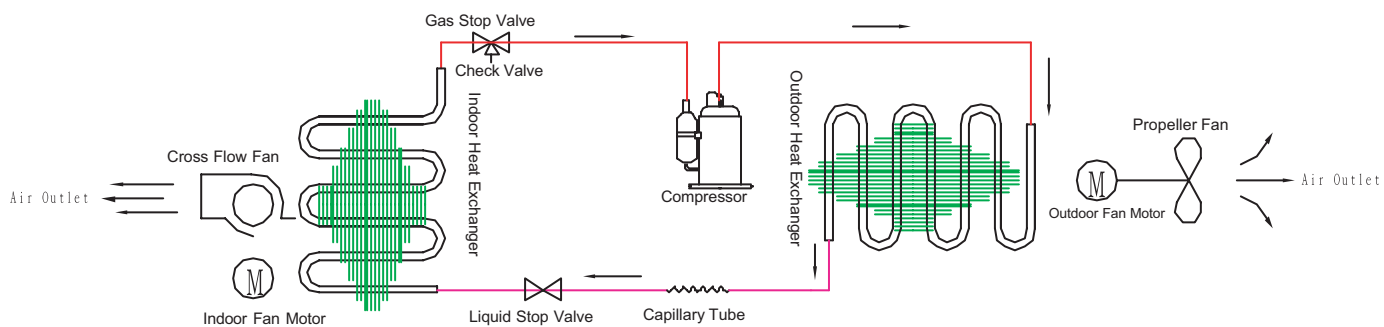

8 Wiring diagrams

Indoor unit

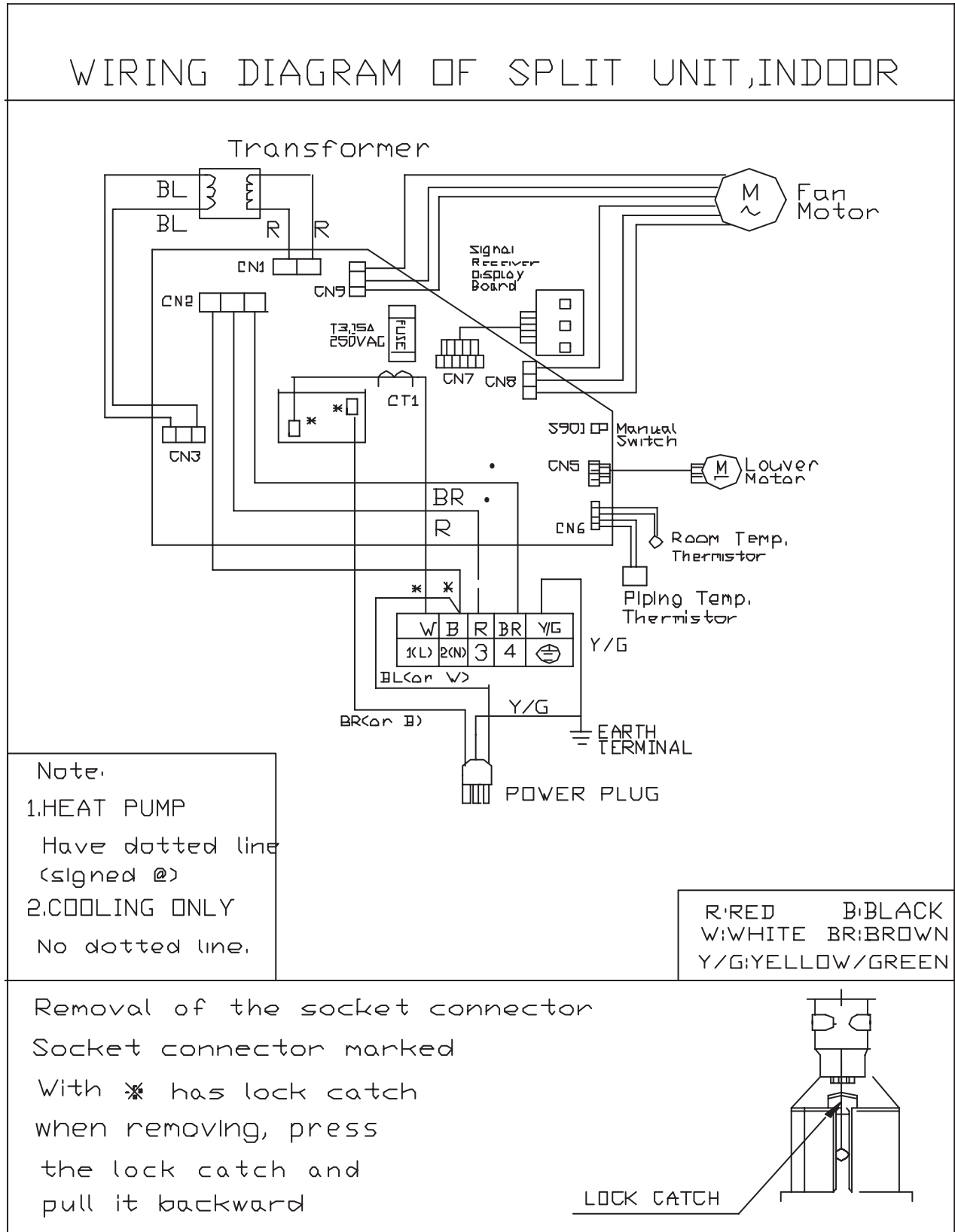

Outdoor unit

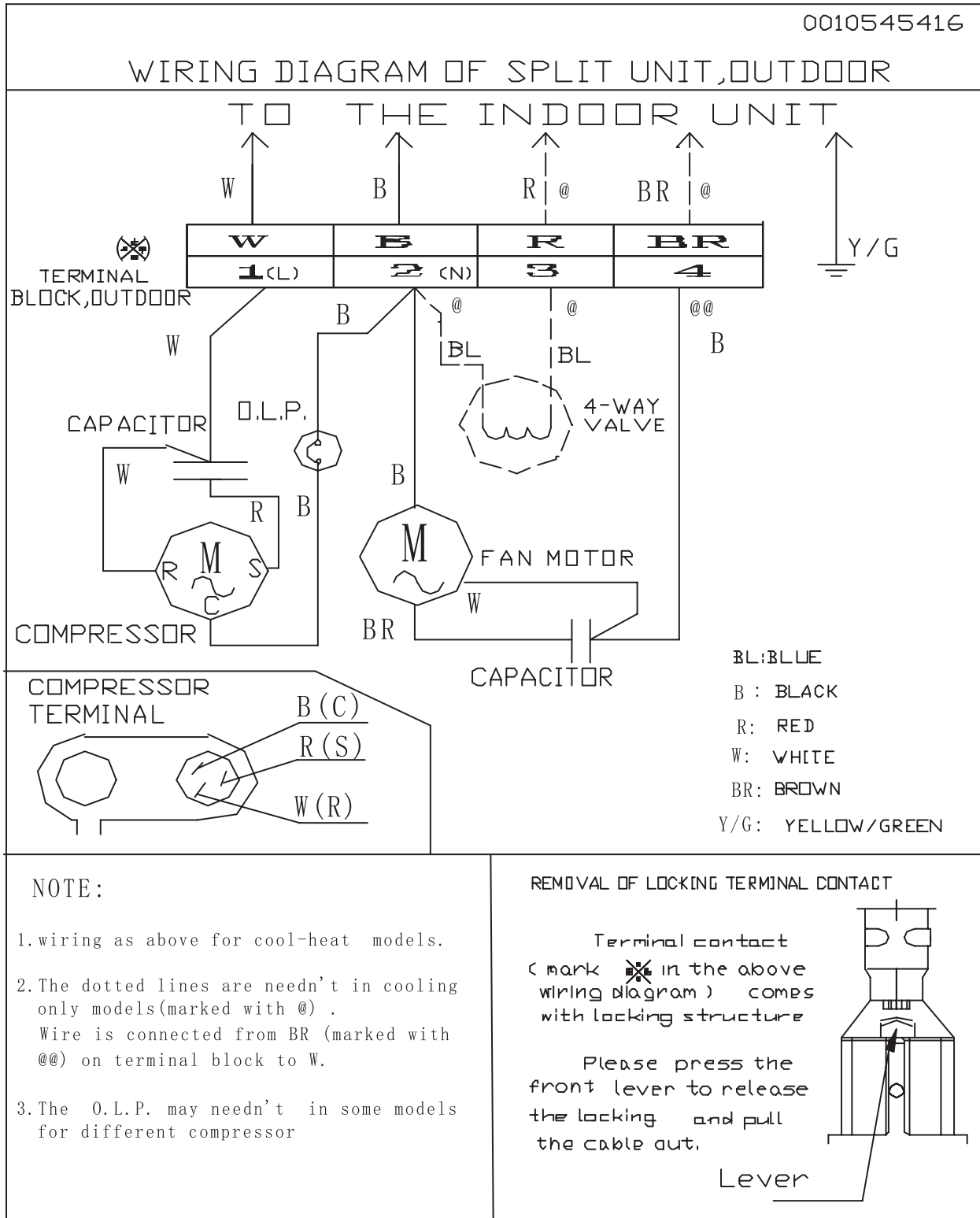

9 Capacity tables and curves diagrams

HSU-07C03 performance curves								
cooling capacity and indoor/outdoor temp.curves								
indoor temp.°C	outdoor temp. (humidity 46%)							
DB/WB	18	20	25	32	35	40	43	46
18/12	1441	1419	1386	1356	1218	1156	989	946
18/14	1556	1514	1471	1437	1269	1225	1050	1005
20/15	1604	1561	1520	1483	1342	1265	1081	1035
22/16	1687	1616	1579	1538	1375	1287	1118	1044
25/18	1750	1697	1636	1608	1448	1370	1171	1074
27/19	1859	1741	1680	1643	1436	1365	1205	1153
30/22	1960	1874	1798	1749	1590	1499	1279	1224
32/23	2047	1943	1887	1857	1678	1553	1344	1286
32/24	2117	2023	1967	1926	1742	1642	1400	1340

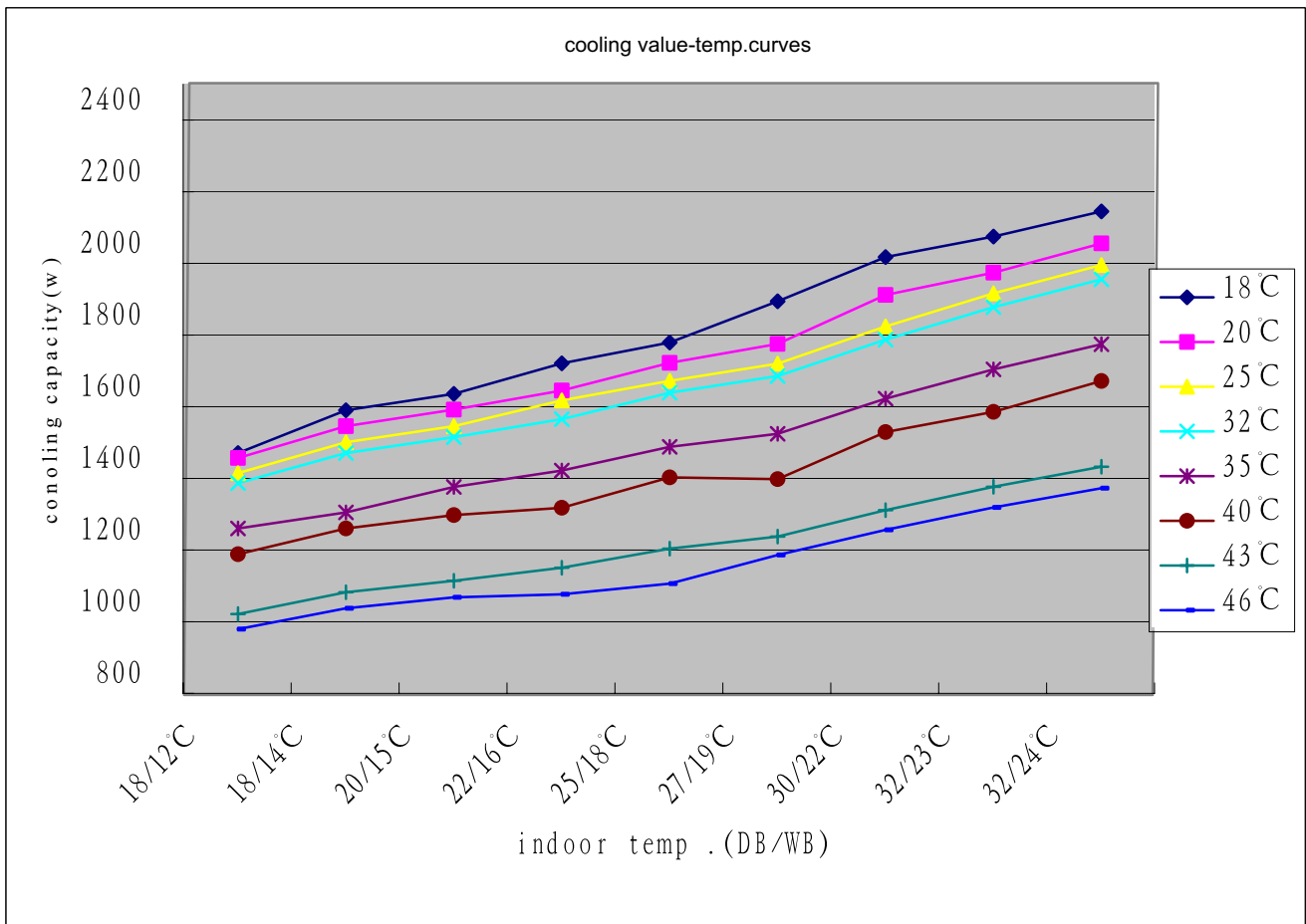

10 Sound level

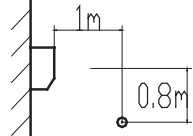
Model	Sound pressure level			Measuring location Location of microphone	sound power level
	220 ~ V,50Hz				
	Cooling				
	H	L	SL		
HSU-07C03	37	35	30		37

Sound level data

HSU-07C03	100Hz	125Hz	250Hz	500Hz	1000Hz	2000Hz	4000Hz	6000Hz	8000Hz
INDOOR	41.7	34.7	33.6	32.6	30.5	28.2	19.7	0.0	0.0
OUTDOOR	51.7	46.5	47.2	45.6	43.9	39.7	33.0	29.9	28.9

Sound pressure spectrum

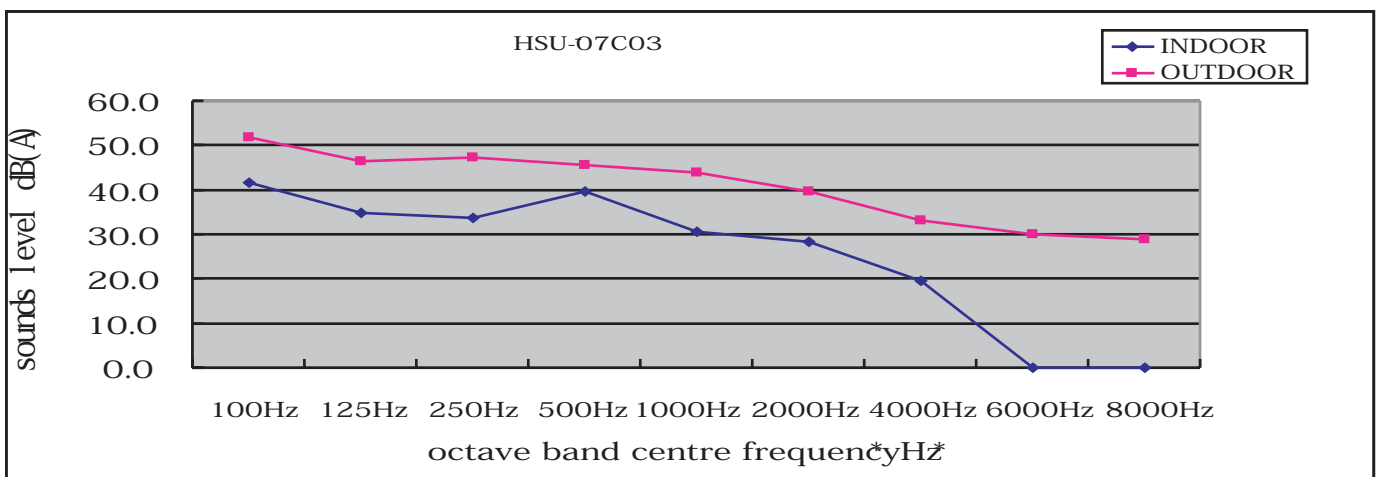

11 Accessories

Standard name	HSU-07C03	
Drain hose	1	
Plastic bag	1	
screw assembly	1	
Air purifier	2	
Battery	2	
Mounting plate	1	
Remote controller	1	
Installation manual	1	
Operation manual	1	

12 Control systems

Operation

Buttons and display of the remote controller.

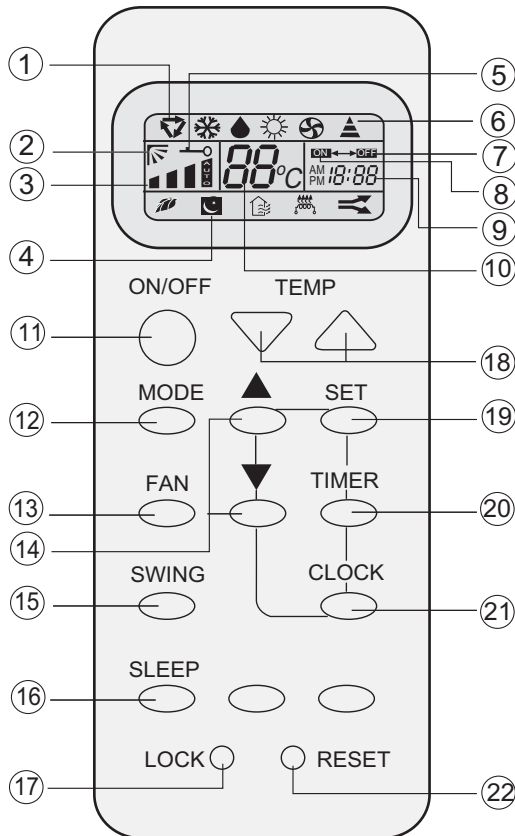

1. Mode display

AUTO

COOL

DRY

HEAT

FAN

2. SWING display



3. FAN SPEED display

4. SLEEP display

5. LOCK display

6. SIGNAL SENDING

7. TIMER OFF display

8. TIMER ON display

9. CLOCK display

10. TEMP display

11. POWER ON/OFF

Used for unit start and stop.

12. MODE

Used to select AUTO run, COOL, DRY, HEAT and FAN operation

13. FAN

Used to select fan speed LO, MED, HI, AUTO

14. HOUR

Used to set clock and timer setting.

15. SWING

Used to set auto fan direction.

16. SLEEP

Used to select sleep mode.

17. LOCK

Used to lock buttons and LCD display.

18. TEMP.

Used to select your desired temp.

19. SET

Used to confirm timer and clock settings.

20. TIMER

Used to select TIMER ON, TIMER OFF, TIMER ON-OFF

21. CLOCK

Used to set correct time

22. RESET

Used to reset the controller back to normal condition.

Clock set

When unit is started for the first time and after replacing batteries in remote controller, clock should be adjusted as follows:

Press CLOCK button, "AM" or "PM" flashes.

Press Δ or ∇ to set correct time. Each press will increase or decrease 1min. If the button is kept depressed, time will change quickly.

After time setting is confirmed, press SET, "AM" and "PM" stop flashing, while clock starts working.

NOTE: Cooling only unit do not have displays and functions related with heating

Hints









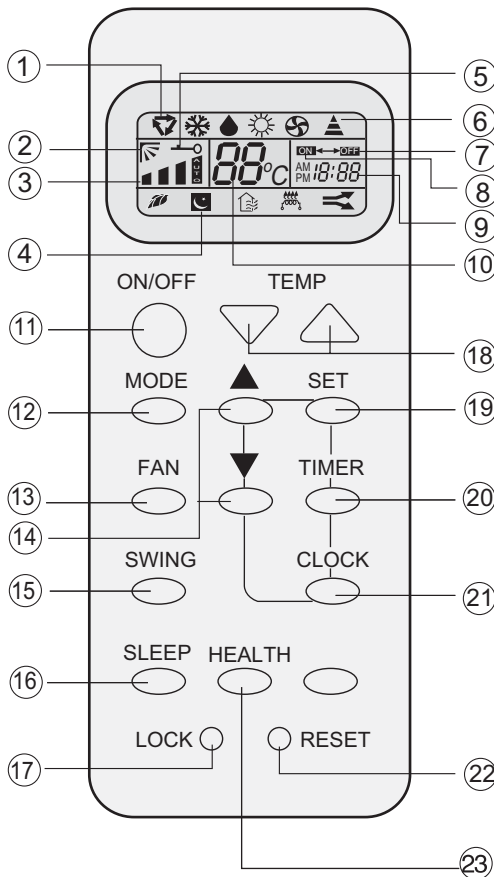





After replacing with new batteries, remote controller will conduct self-check, displaying all information on LCD. Then, it will become normal.

Operation

Buttons and display of the remote controller.

If the unit which you purchased has healthy function, Remote controller should like the following figure:



1. Mode display
 AUTO 
 COOL 
 DRY 
 HEAT 
 FAN 
2. SWING display 
3. FAN SPEED display 
4. SLEEP display 
5. LOCK display 
6. SIGNAL SENDING 
7. TIMER OFF display 
8. TIMER ON display 
9. CLOCK display 
10. TEMP display 
11. POWER ON/OFF
Used for unit start and stop.
12. MODE
Used to select AUTO run, COOL, DRY, HEAT and FAN operation
13. FAN
Used to select fan speed LO, MED, HI, AUTO
14. HOUR
Used to set clock and timer setting.
15. SWING
Used to set auto fan direction.
16. SLEEP
Used to select sleep mode.
17. LOCK
Used to lock buttons and LCD display.
18. TEMP.
Used to select your desired temp.
19. SET
Used to confirm timer and clock settings.
20. TIMER
Used to select TIMER ON, TIMER OFF, TIMER ON-OFF
21. CLOCK
Used to set correct time
22. RESET
Used to reset the controller back to normal condition.
23. HEALTH
Used to set healthy operation

BRIEF INTRODUCTION TO HEALTH OPERATION

The anion generator in the air conditioner can generate a lot of anion to effectively balance the quantity of positive and negative ions in the air and also to kill bacteria and speed up the dust sediment in the room and finally clean the air in the room.

NOTE: Cooling only unit do not have displays and functions related with heating

Hints

After replacing with new batteries, remote controller will conduct self-check, displaying all information on LCD. Then, it will become normal.

13 Center of gravity

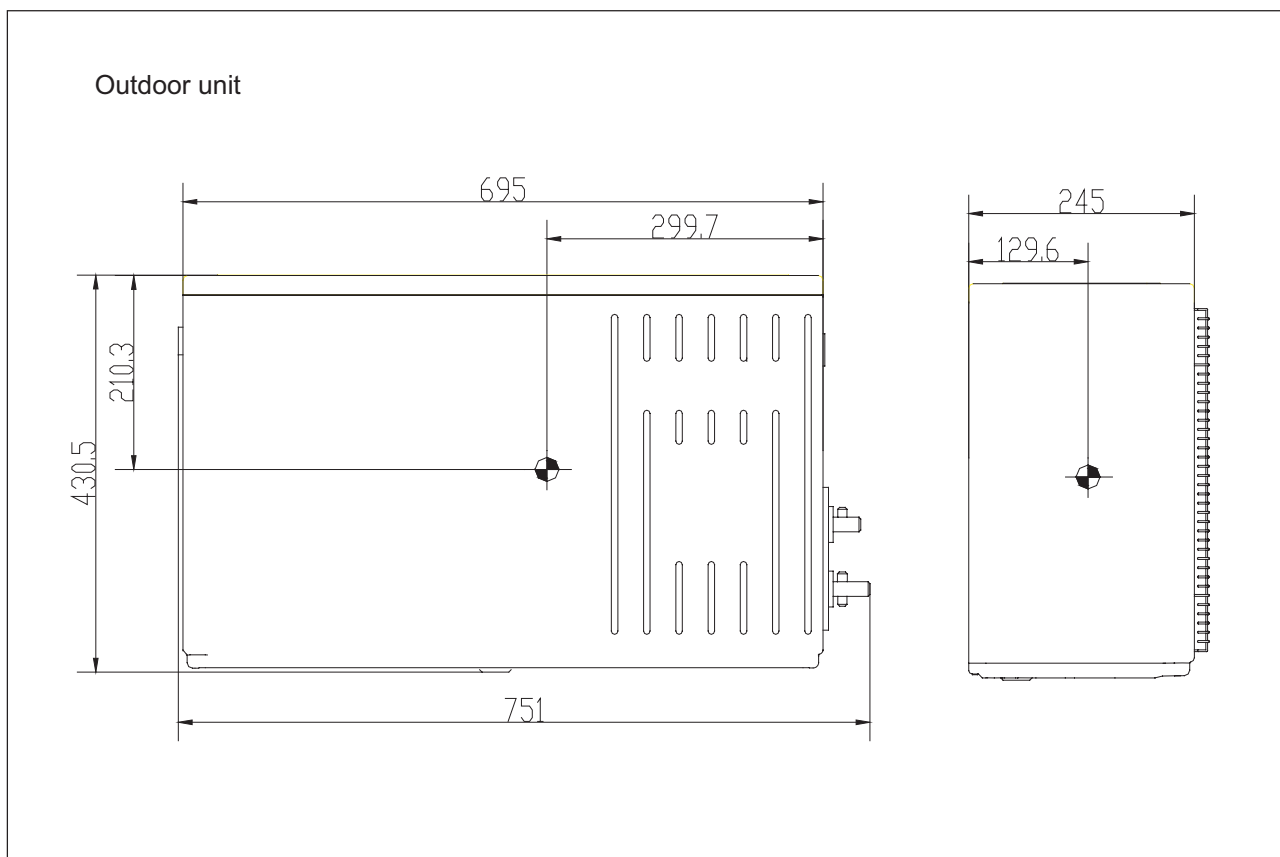
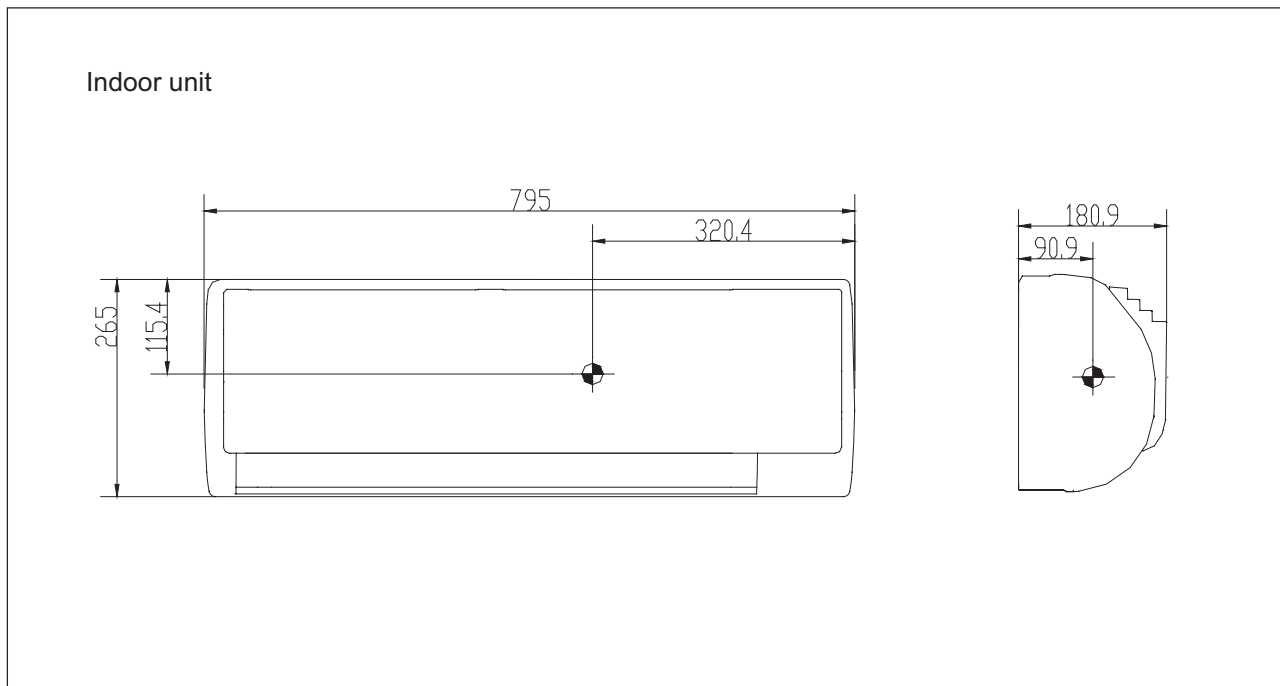

14 Installations

Indoor unit installation drawings

- How to attach the indoor unit.
Hook the claws of the bottom frame to the mounting plate.
If the claws are difficult to hook ,remove the front panel.
- How to remove the indoor unit.
Push up the marked area (at the lower part of the front panel) to release the the claws . If it is difficult to release ,remove the front panel .

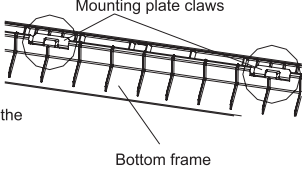

Mounting plate claws

Bottom frame

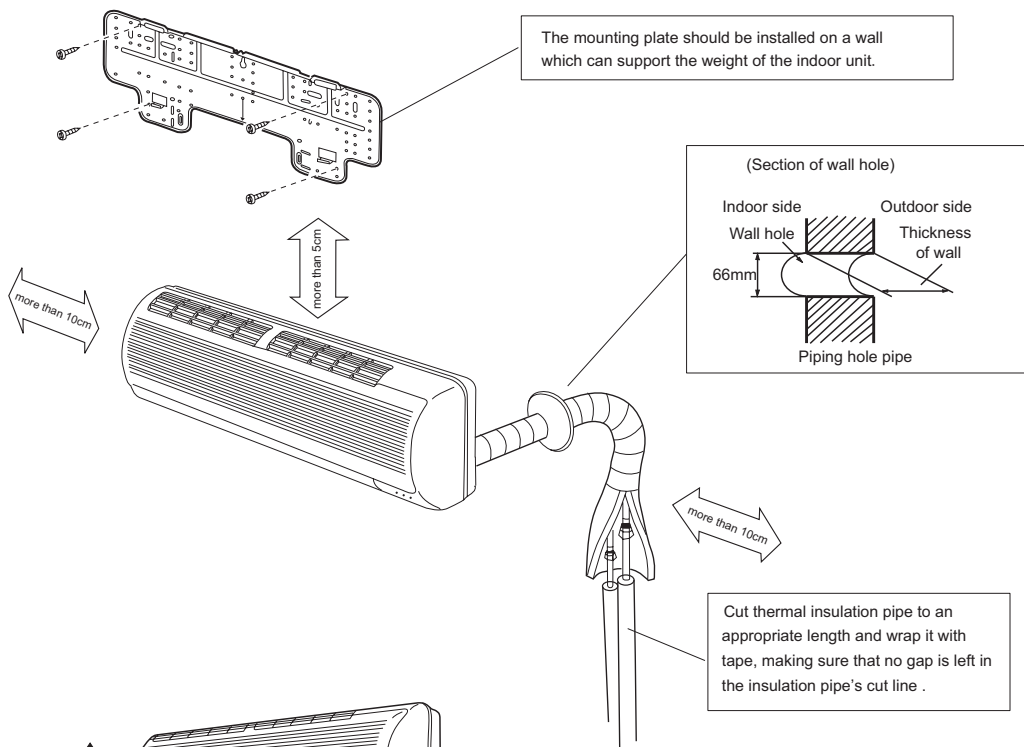

The mounting plate should be installed on a wall which can support the weight of the indoor unit.

(Section of wall hole)

Indoor side Outdoor side

Wall hole Thickness of wall

66mm

Piping hole pipe

more than 10cm

more than 5cm

more than 10cm

Cut thermal insulation pipe to an appropriate length and wrap it with tape, making sure that no gap is left in the insulation pipe's cut line .

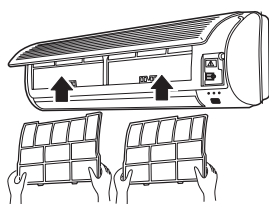
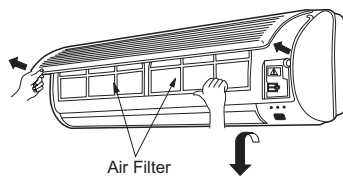
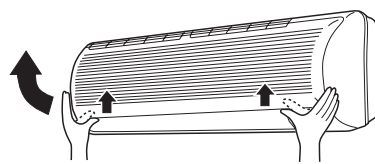

How to remove the air filter.

Open the inlet grille by pulling it upward.

Push up the filter's center tab slightly until it is released from the stopper, and remove the filter downward.

How to Attach the air filter.

Attach the filter correctly so that the "FRONT" indication is facing to the front. Make sure that the filter is completely fixed behind the stopper. If the right and left filters are not attached correctly, that may cause defects.

Close the inlet grille.

Outdoor unit installation drawings

HSU-07C03

Model	26/28 class
Max.allowable length	Cooling only : 7 m Heat pump : 7 m
Max.allowable height	5 m
Additional refrigerant required for refrigerant pipe exceeding 5m in length	16g/m
Gas pipe	O.D. 9.52/12.7
Liquid pipe	O.D. 6.35/9.52

*Be sure to add the proper amount of additional refrigerant. Failure to do so may result in reduced performance.

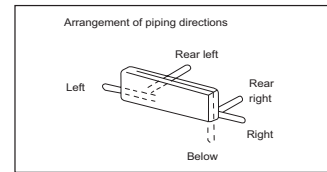

The distance between the indoor unit and the floor should be more than 2m.

Wrap the installation pipe with the finishing tape from bottom to top Model 25 / 35 class

Service lid

- How to remove the service lid. This service lid is an open/close type. Slide the lid downward to remove it.
- How to attach the service lid. Insert the upper part of the service lid into the outdoor unit to install. Tighten the screws.

Where there is a danger of the unit falling, use foot bolts, or wires.

- Fix the unit to concrete or block with bolts (Φ10mm) and nuts firmly and horizontally.
- When fitting the unit to wall surface, roof or rooftop, fix a supporter surely with nails or wires in consideration of earthquake and strong wind.
- If vibration may affect the house, fix the unit by attaching a vibration-proof mat.

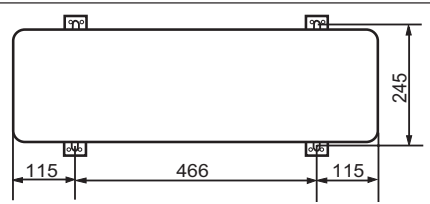

Sincere Forever



Haier Group

Haier Industrial Park, No.1, Haier Road

266101, Qingdao, China

E-mail: hractech@haier.com

Tel: +86 532 87636957

[Http://www.haier.com](http://www.haier.com)

Edited by: Zhao Jicheng

Signed by: Yang Bifei

Approved by: Zhu Zhenxue