



Domestic Air conditioner

TECHNICAL DATA

ON/OFF

Wall mounted Type V-Series

HSU-18C03/V(ZXF)
HSU-22C03/V(ZXF)



CAUTION

1. READ THIS MANUAL CAREFULLY TO
DIAGNOSE TROUBLE CORRECTLY
BEFORE OFFERING SERVICE.
2. THIS MANUAL IS USED BY QUALIFIED
APPLIANCE TECHNICIANS ONLY.
3. HAIER DOES NOT ASSUME ANY
RESPONSIBILITY FOR PROPERTY
DAMAGE OR PERSONAL INJURY FOR
IMPROPER
SERVICE PROCEDURES DONE BY ONE
UNQUALIFIED PERSON.

Table of Contents

- 1. Features.....2
- 2. Specifications.....3
- 3. Remote controller lists.....6
- 4. Sensors lists.....6
- 5. Dimensional drawings.....7
- 6. Operation range.....9
- 7. Piping diagrams.....10
- 8. Wiring diagrams.....11
- 9. Capacity diagrams and curves diagrams.....13
- 10. Sound level.....15
- 11. Accessories.....16
- 12. Control systems.....17
- 13. Center of gravity.....18
- 14. Installations.....19

1 Features



O2 fresh: It can bring the fresh air in when the machine is running in O2 fresh mode.



Healthy UV ray: UV ray generator can eliminate and prevent bacteria in air effectively



DRY function: Make dehumidifying in the room when the unit is working in the "DRY" mode .



Intelligent air:With twin-blade technology ,the airflow can be adjusted not to blow directly to human body , so preventing people from the air conditioner symptom .



Photocatalyst filter: Eliminates the air of a wide variety of odor-causing substances from cigarette smoke particles to chemical vapors



Bacteria-killing medium: 3-in-1 effect:Anti-Allergen , Anti-Bacteria



3D air flow: The 3D airflow is able to deliver the airflow horizontally and vertically



Auto mode: According to the fixed temperature "26°C",the unit will adjust the operation mode automatically.



Sleep mode: The setting temperature and the indoor noise can be adjusted to a more comfortable level when you set the "sleep mode"during night sleep .



24Hour timer: Use the timer function to set on,or off,or from on to off,or from off to on .



4 Fan setting: Slect the fan speed LO,MED,HI,AUTO



Easy clean design: The panel is easy to wash and the airflow vents can be detached without any special tools for quick cleaning of the inside of the air conditioner .



Left&right flow: With specialized motor and flaps,the airflow can be adjusted



Child lock: Avoid the child's wrong operation on the remote controller .



2.Specifications

This information was not available at the time of publication

NOMINAL CAPACITY and NOMINAL INPUT					
Model				HSU-18C03V(ZXF)	HSU-22C03V(ZXF)
NOMINAL CAPACITY(3-4)	Cooling(1)	norm.	kw	5.00	5.95
	Heating(2)	norm.	kw	-----	-----
NOMINAL INPUT	Cooling	norm	kw	1.85	2.25
	Heating	norm.	kw	-----	-----
EER	Cooling			2.70	2.64
COP	Heating			-----	-----
ENERGY LABEL(7-8)	Cooling			----	----
	Heating			----	----
ANNUAL ENERGY CONSUMPTION(9)	Cooling		kwh	795	970

TECHNICAL SPECIFICATIONS						
INDOOR UNITS				HSU-18C03V(ZXF)	HSU-22C03V(ZXF)	
DIMENSIONS	Unit	H	mm	305		
		W	mm	850		
		D	mm	230		
WEIGHT	Unit		kg	12		
COLOR	Unit			white		
SOUND LEVEL	Sound pressure (cooling/heating)(5)	high	dB(A)	45	45	
		medium	dB(A)	43	43	
		low	dB(A)	40	40	
	Sound power(cooling/heating)(6)	high	dB(A)	45	45	
FAN	Air flow rate(cooling/heating)	high	m ³ /min	13.6	17.5	
		low	m ³ /min	12.5	16.7	
		super low	m ³ /min	11.3	15.2	
	Speed(cooling/heating)	steps		5steps,silent and auto		
		high	rpm	1350	1350	
		medium	rpm	1180	1200	
		low	rpm	1050	1050	
Type	Cross flow fan					
Motor output		W	16	16		
AIR FILTER	Removable/washable/mildew proof					
REMOTE CONTROLLER	YL-H68EN					
TEMPERATURE CONTROL	Microcomputer control					
PIPING CONNECTIONS(external diameter)	liquid	mm	Φ 6.35	Φ 9.52		
	gas	mm	Φ12.7	Φ15.88		
	drain	mm	Φ16	Φ16		
INSULATION MATERIAL	Heat insulation type			both liquid and gas pipes		
HEAT EXCHANGGER	TYPE		ML fin - Φ9.52HI - XA tube			
	Row x stage x fin pinth		mm	2 x 8 x1.4		

TECHNICAL SPECIFICATIONS					
OUTDOOR UNITS				HSU-18C03/V(ZXF)	HSU-22C03/V(ZXF)
NET DIMENSIONS (stop valve, and bottom support is not included)	Unit	H	mm	540	680
		W	mm	780	837
		D	mm	245	312
WEIGHT	Unit		kg	36	58
COLOR	Unit	white			
SOUND LEVEL	Sound pressure(cooling/heating)(5)	high	dB(A)	56	56
	Sound power(cooling/heating)(6)	high	dB(A)	-----	-----
FAN	Air flow rate(cooling/heating)	high	m ³ /min	25	30
		low	m ³ /min	---	---
	Speed(cooling/heating)	high	rpm	880	880
		low	rpm	---	---
	Type	Propeller fan			
	Motor output		W	19	30
REFRIGERANT CIRCUIT	Refrigerant type	R22			
	Refrigerant charge		kg	1.10	1.40
	Maximum allowable distance between indoor and outdoor		m	15	
	Maximum allowable level difference		m	5	
	Refrigerant control	-----			
COMPRESSOR	Type	rotary Compressor			
	Model			TH338VEEC	PH420X3CS-8KUC1
	Motor output		w	1800	2100
	Oil type			SUNISO 4GSI	SUNISO 4GSI
	Oil charge volume		L	0.27	0.52
PIPING CONNECTIONS	liquid		mm	Φ 6.35/ Φ9.52	
	gas		mm	Φ 12.7/ Φ 15.88	
	drain		mm	Φ 18	
INSULATION MATERIAL	Heat insulation type			both liquid and gas pipes	
HEAT EXCHANGGER	TYPE			ML - Φ9.52HI - XAbube	
	Row x stage x fin pinth		mm	2 x 8 x1.4	

ELECTRICAL SPECIFICATIONS					
For indoor units only:				HSU-18C03/V(ZXF)	HSU-22C03/V(ZXF)
CURRENT	Nominal running current	cooling	A	0.16	0.16
		heating	A	-----	-----
	Maximum running current	cooling	A	0.16	0.16
		heating	A	-----	-----

For combination indoor units+ outdoor units:				HSU-18C03/V(ZXF)	HSU-22C03/V(ZXF)
CURRENT	Nominal running current	cooling	A	8.5	10.3
		heating	A	-----	-----
	Maximum running current	cooling	A	11.8	16.0
		heating	A	-----	-----
	Starting current	cooling	A	30	42
		heating	A	-----	-----

For indoor units only:				HSU-18C03/V(ZXF)	HSU-22C03/V(ZXF)
POWER SUPPLY				VM	VM
NOMINAL DISTRIBUTION SYSTEM VOLTAGE	Phase			1PH	1PH
	Frequency	Hz		50	50
	Voltage	V		220V~	220V~

NOTES

- 1 Nominal cooling capacities are based on: indoor temperature 27°CDB/19°CWB * outdoor temperature 35°CDB * refrigerant piping length: 5m * level difference: 0m.
- 2 Nominal heating capacities are based on: indoor temperature 20°CDB * outdoor temperature 7°CDB/6°CWB * refrigerant piping length 5m (horizontal) * level difference 0m.
- 3 Capacities are net, including a deduction for cooling (an addition for heating) for indoor fan motor heat.
- 4 Units should be selected on nominal capacity. Maximum capacity is limited to peak periods.
- 5 The sound pressure level is measured via a microphone at a certain distance from the unit. For measuring conditions: please refer to item 6 of this chapter.
- 6 The sound power level is an absolute value indicating the "power" which a sound source generates.
- 7 Energy label: scale from A (most efficient) to G (less efficient).
- 8 The energy label Directive 2002/31/EC will enter into force once the relevant measurement standard will be published in the European official Standard.
- 9 Annual energy consumption: based on average use of 500 running hours per year at full load (= nominal conditions)

3 Remote controller lists

Model	HSU-18C03/V(ZXF)	HSU-22C03/V(ZXF)
YR-H68	Y	Y
-----	----	----

4 Sensors lists

INDOOR UNIT		
type	Description	Qty
Room sensor	It's used for detecting room temperature	1
Pipe sensor	It's used for detecting temperature of evaporator	1

5 Dimensional drawings

Indoor unit

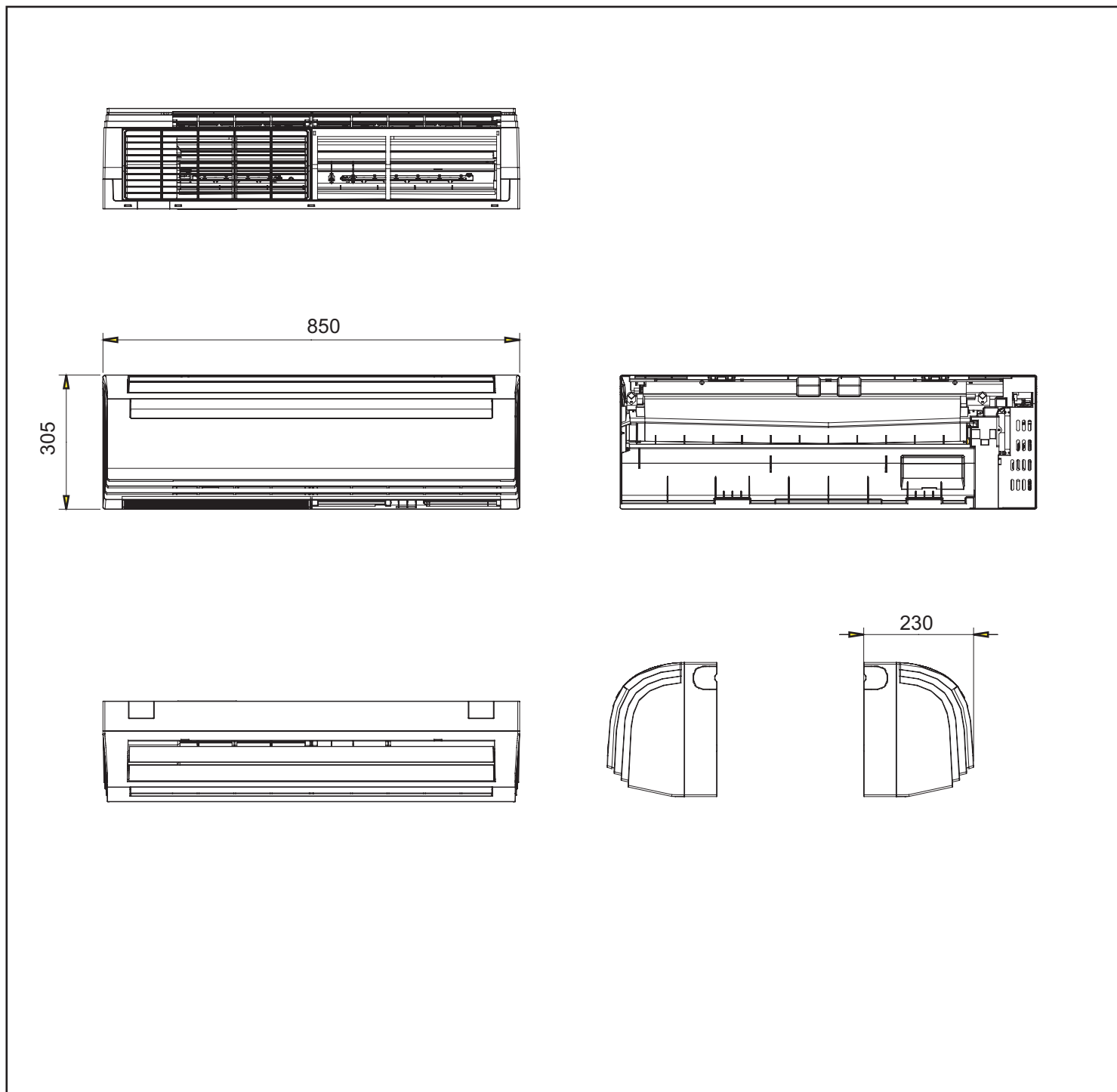

Outdoor unit

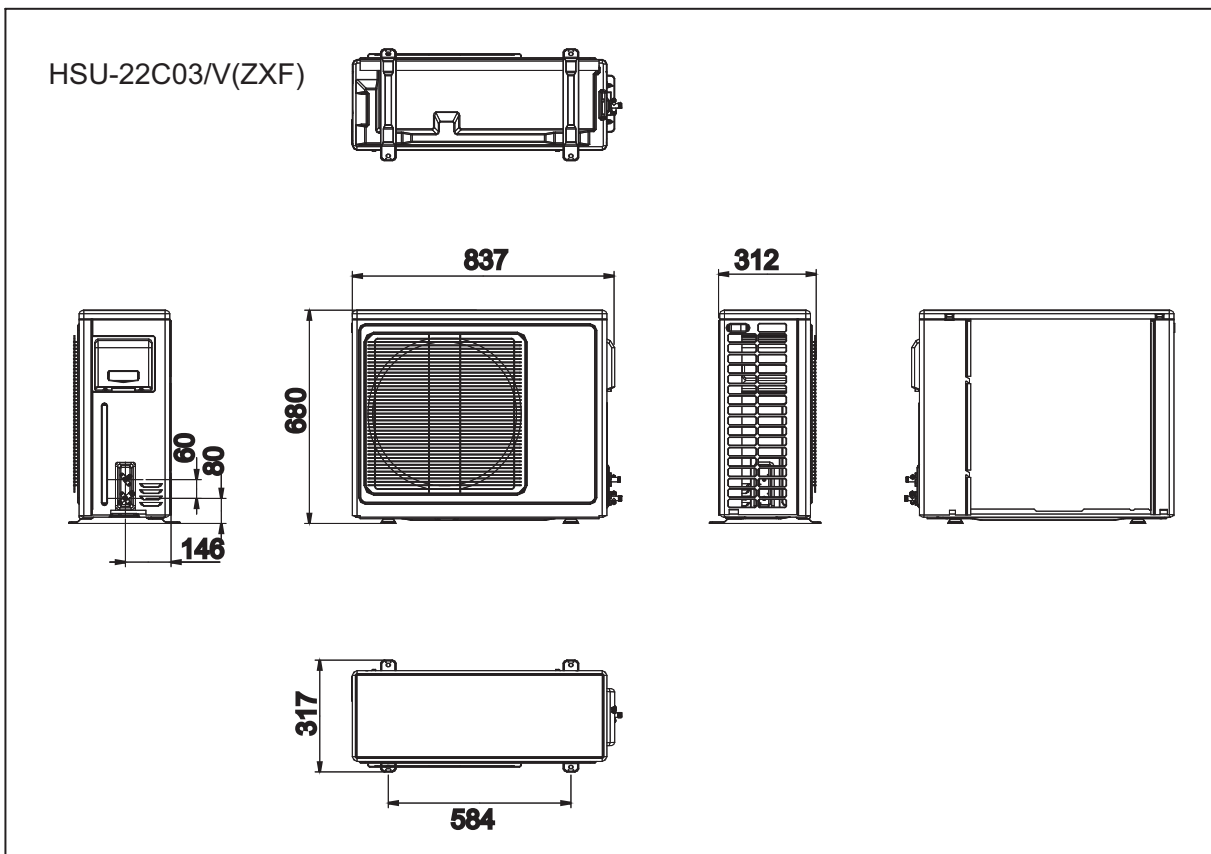
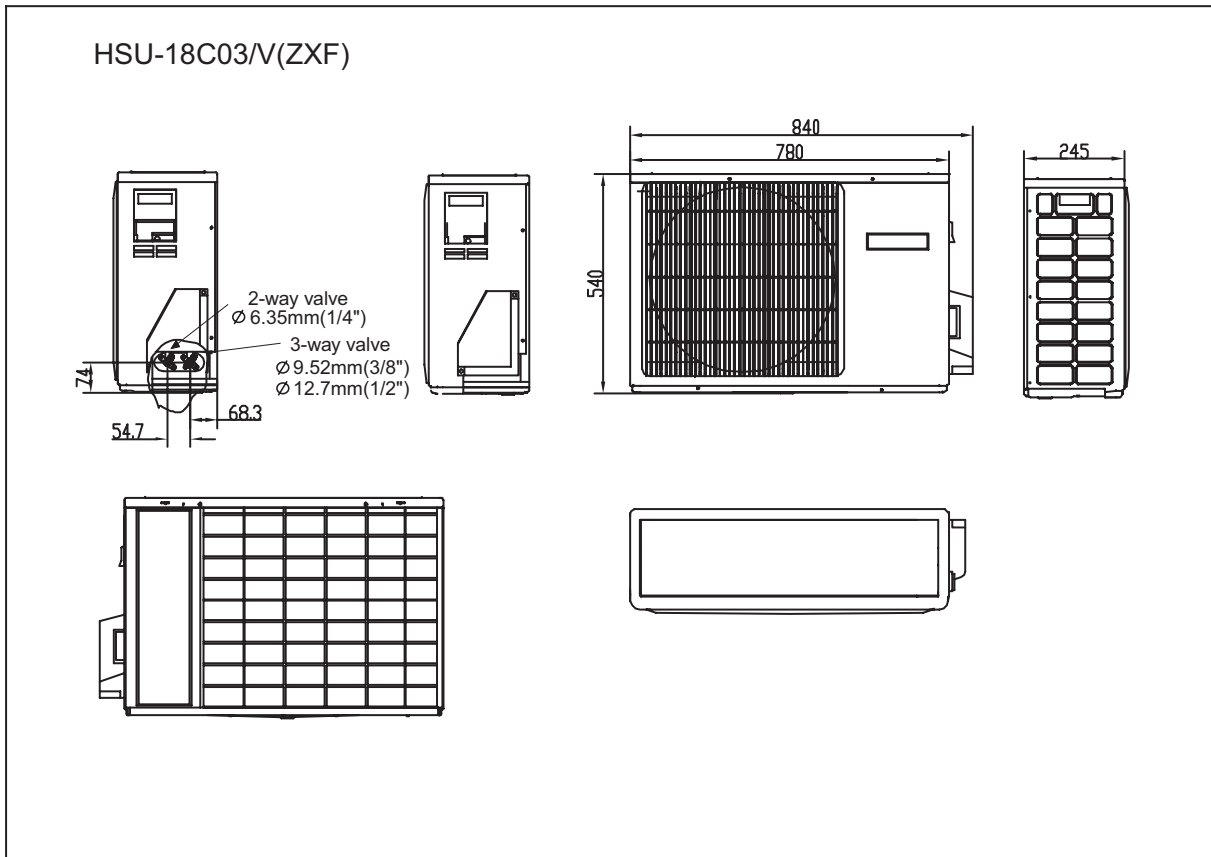

6 Operation range

The name of parts

Cooling

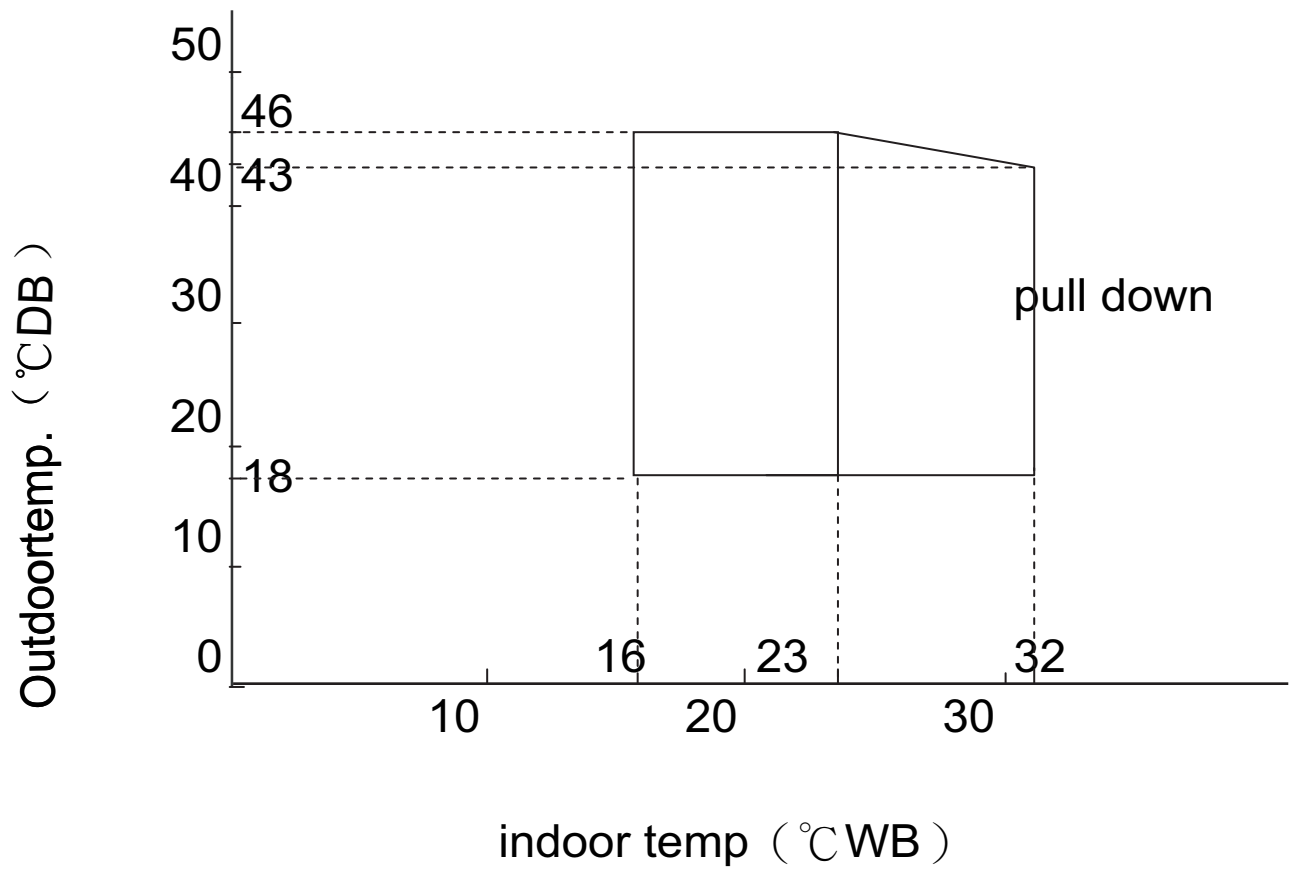

7 Piping diagrams

Cooling mode

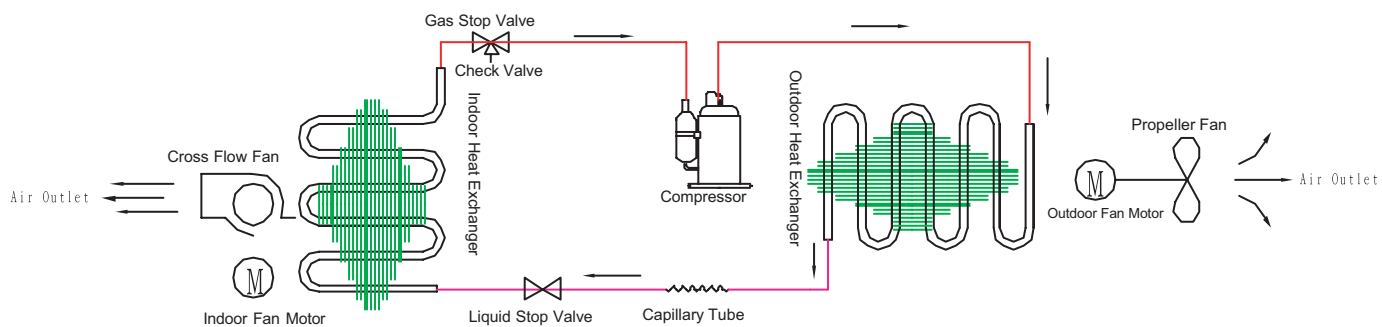

8 Wiring diagrams

Indoor unit

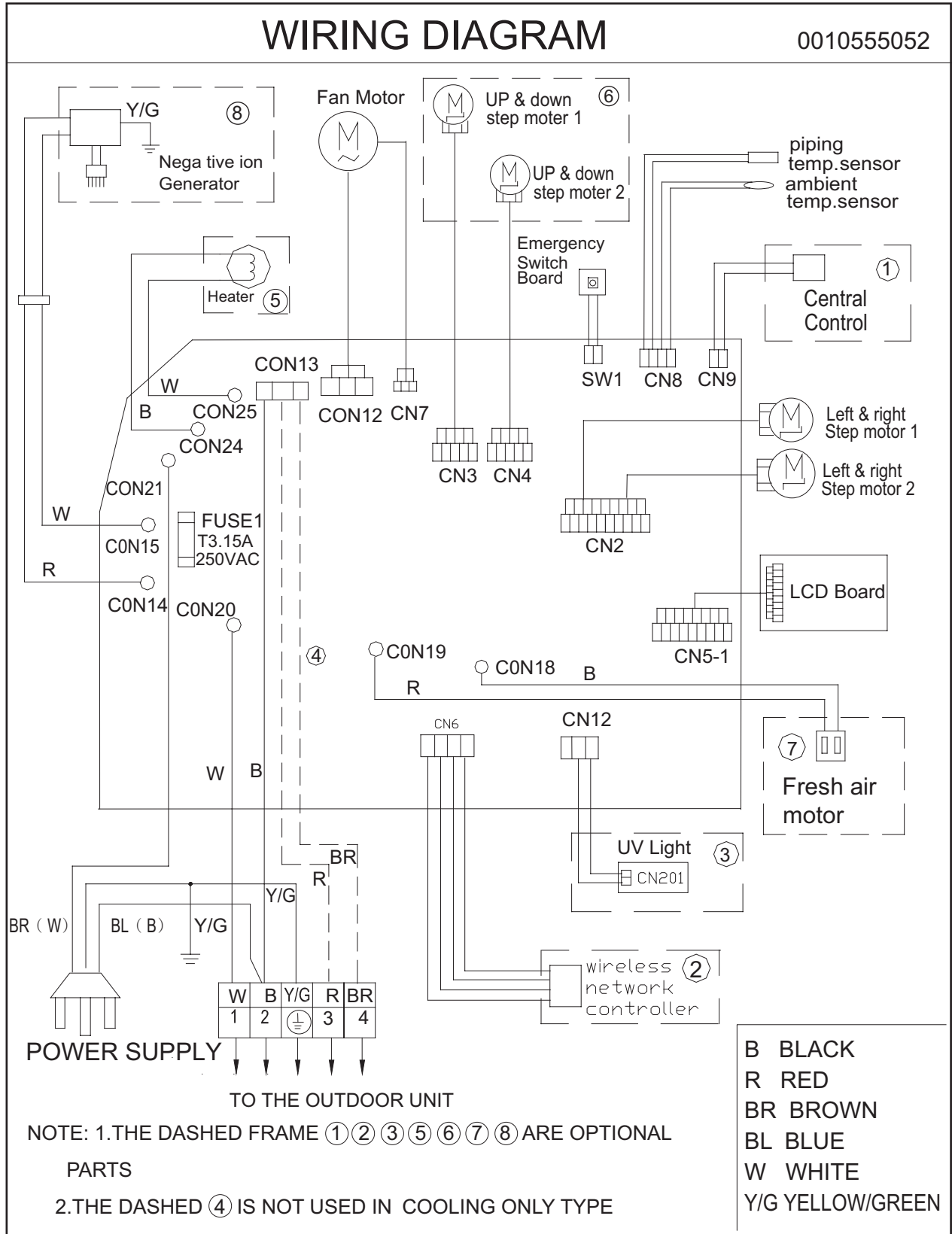

Outdoor unit

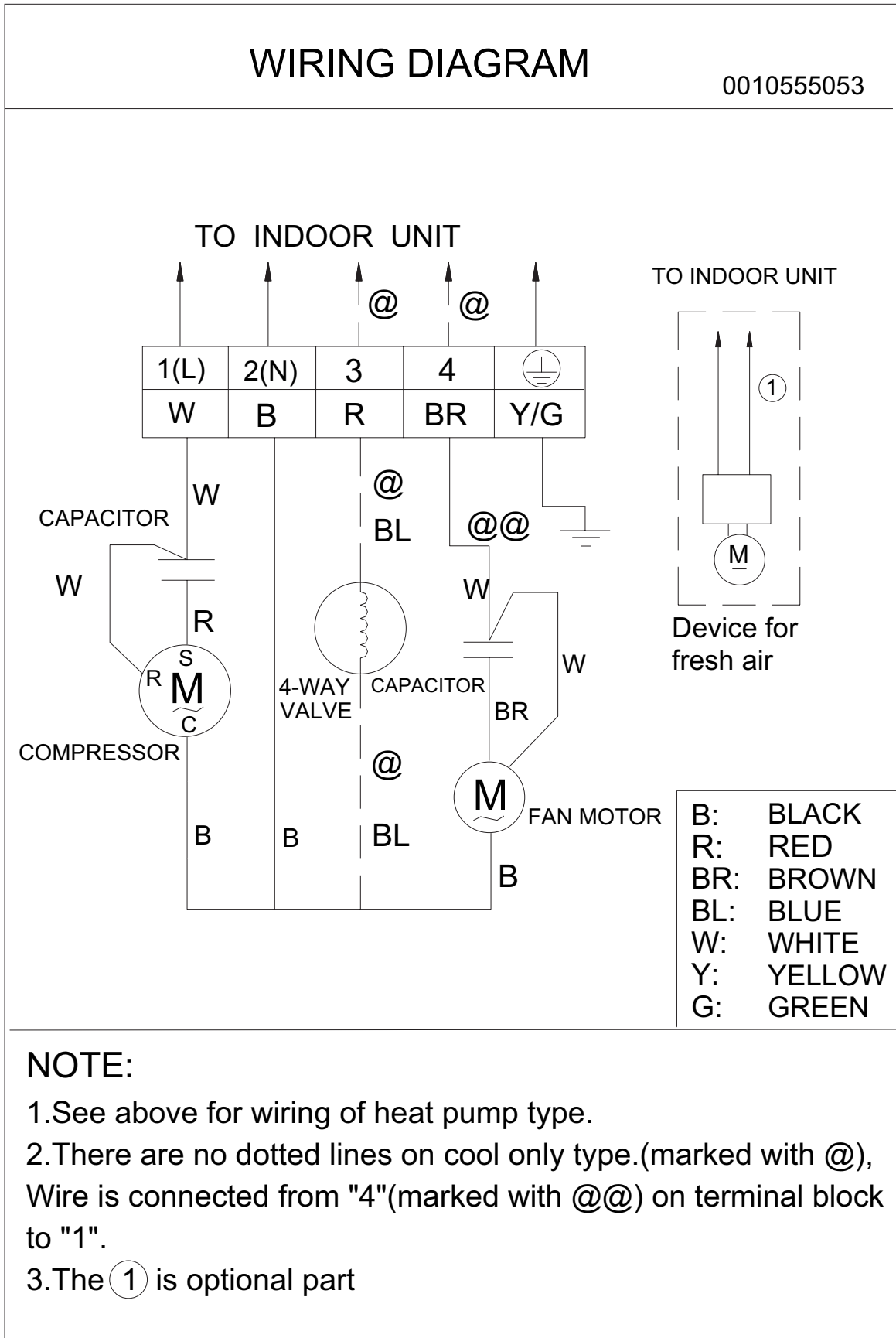

9 Capacity tables and curves diagrams

HSU-18C03/V(ZXF) performance curves								
cooling capacity and indoor/outdoor temp.curves								
indoor temp.	outdoor temp.(humidity 46%)							
DB/WB	18 C	20 C	25 C	32 C	35 C	40 C	43 C	46 C
18/12 C	3397	3362	3263	3196	2898	2587	2334	2234
18/14 C	3673	3572	3466	3395	3003	2769	2478	2372
20/15 C	3787	3681	3572	3499	3172	2907	2553	2444
22/16 C	4029	3806	3742	3618	3279	3035	2639	2464
25/18 C	4251	3989	3871	3792	3436	3235	2764	2535
27/19 C	4490	4114	3984	3902	3659	3500	3111	2722
30/22 C	4780	4493	4229	4143	3877	3692	3283	2889
32/23 C	4826	4653	4447	4356	3947	3666	3340	3036
32/24 C	4985	4722	4504	4391	3922	3637	3397	3181

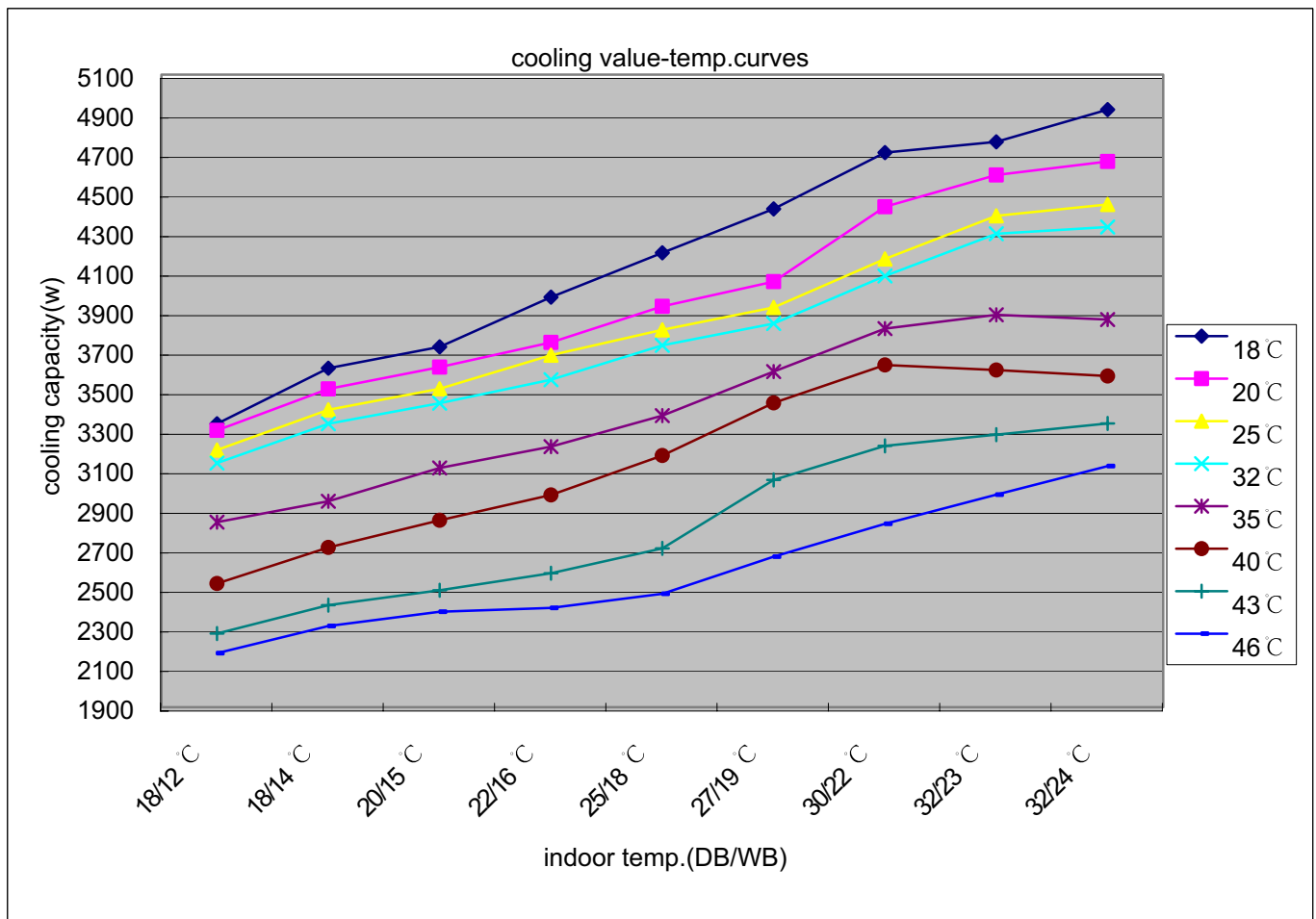

HSU-22C03/V(ZXF) performance curves								
cooling capacity and indoor/outdoor temp.curves								
indoor temp.	outdoor temp.(humidity 46%)							
DB/WB	18 C	20 C	25 C	32 C	35 C	40 C	43 C	46 C
18/12 C	4395	4358	4263	4196	3898	3587	3334	3234
18/14 C	4676	4572	4445	4395	4003	3769	3478	3372
20/15 C	4784	4682	4572	4496	4172	3907	3553	3444
22/16 C	5034	4806	4742	4618	4279	4035	3639	3464
25/18 C	5260	4985	4869	4745	4436	4235	3764	3535
27/19 C	5482	5114	4984	4902	4659	4523	4111	3722
30/22 C	5759	5489	5229	5143	4877	4689	4283	3889
32/23 C	5819	5653	5444	5356	4947	4666	4340	4036
32/24 C	5987	5722	5504	5391	4922	4637	4397	4181

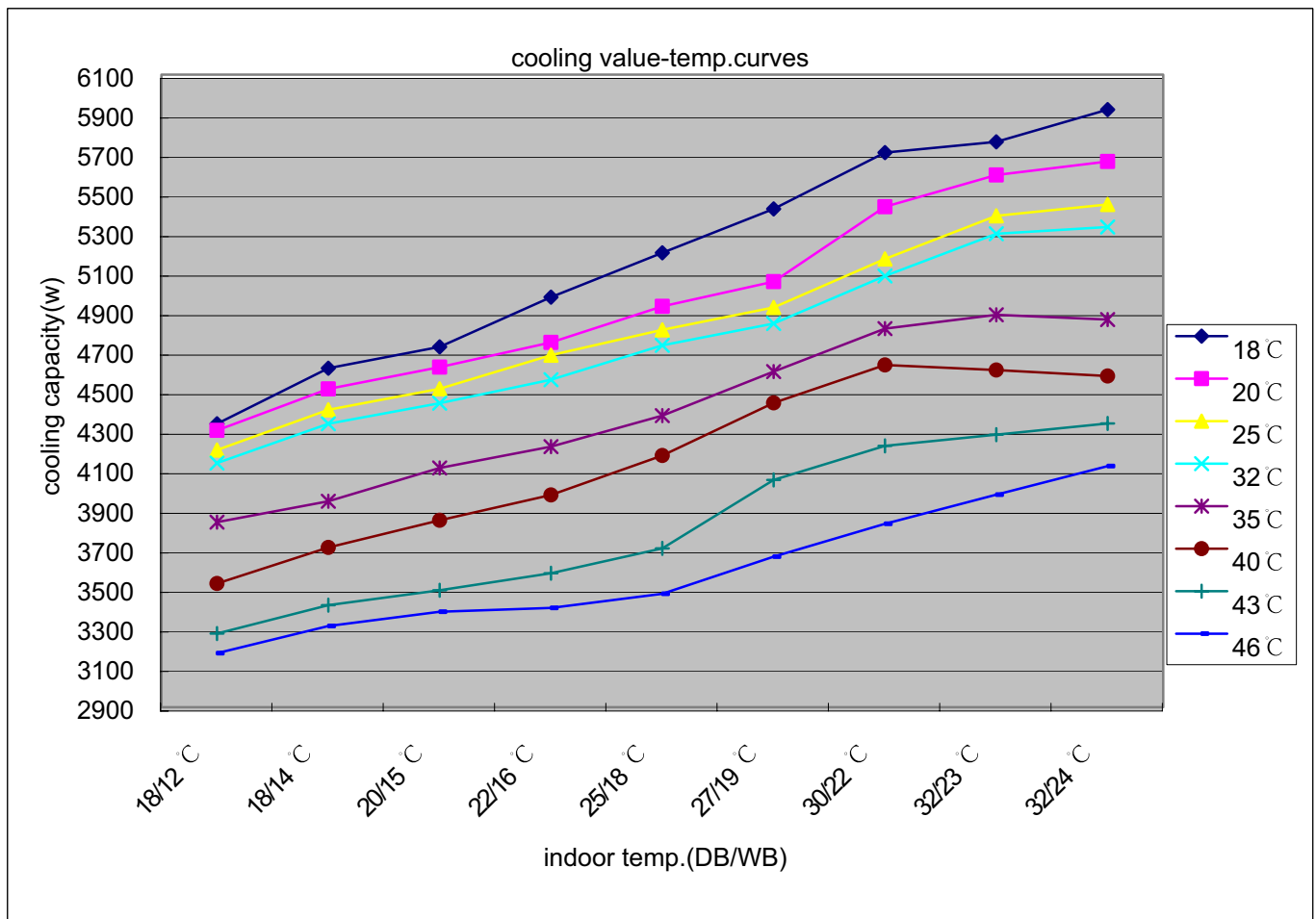

10 Sound level

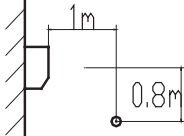
Model	Sound pressure level			Measuring location Location of microphone 	sound power level
	220 ~ V,50Hz				
	Cooling				
	H	L	SL		
HSU-18C03/V(ZXF)	45	43	40	45	
HSU-22C03/V(ZXF)	45	43	40		

Sound level data

HSU-18C03/V(ZXF)	100Hz	125Hz	250Hz	500Hz	1000Hz	2000Hz	4000Hz	6000Hz	8000Hz
INDOOR	47.7	39.7	38.6	41.6	34.5	31.2	23.7	0.0	0.0
OUTDOOR	58.7	52.5	49.2	47.6	47.9	43.7	38.0	34.9	33.9

HSU-22C03/V(ZXF)	100Hz	125Hz	250Hz	500Hz	1000Hz	2000Hz	4000Hz	6000Hz	8000Hz
INDOOR	41.7	34.7	33.6	39.6	30.5	28.2	19.7	0.0	0.0
OUTDOOR	61.4	56.7	56.7	53.9	51.8	47.8	41.7	39.7	35.6

Sound pressure spectrum

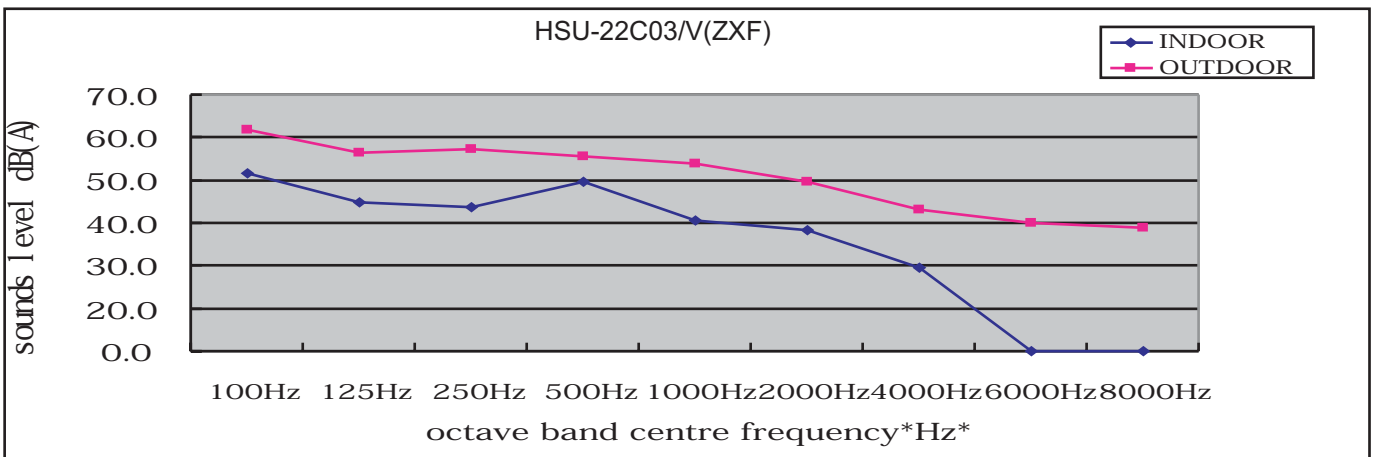
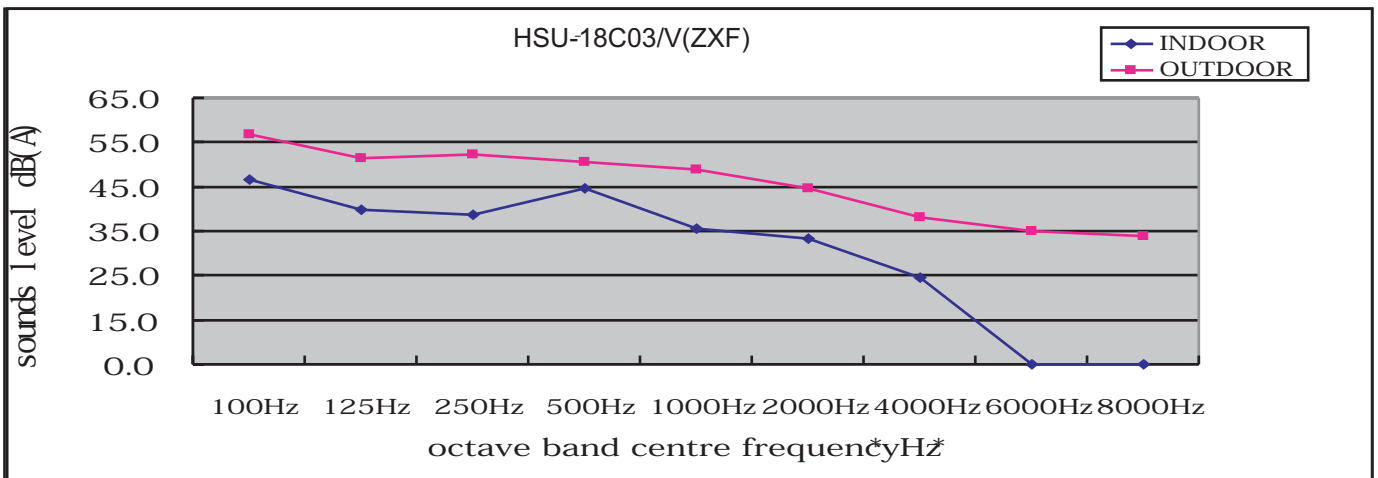

11 Accessories

Standard name	HSU-18C03/V(ZXF)	HSU-22C03/V(ZXF)
Drain hose	1	1
Plastic bag	1	1
screw assembly	1	1
Air purifier	2	2
Change for fresh airtube(suit)	1	1
Mounting plate	1	1
Remote controller	1	1
Installation manual	1	1
Operation manual	1	1

12 Control systems

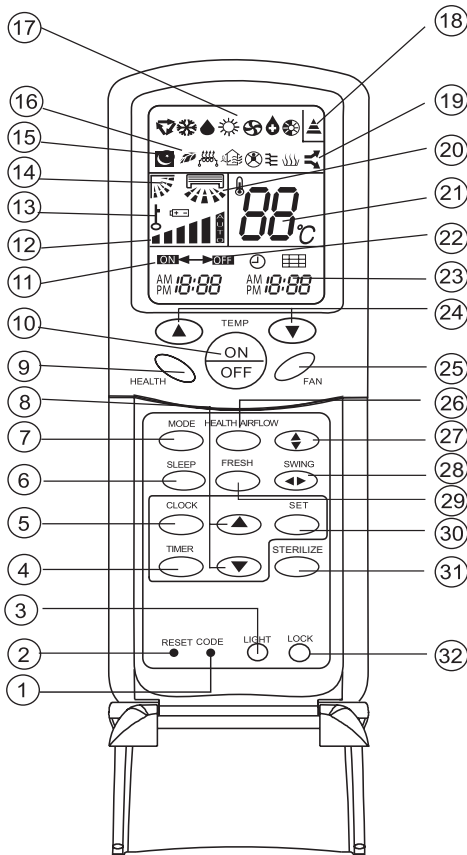

1.CODE

Used to select CODE A or B with a press,A or B will be displayed on LCD.
Please select A without special explanation.

2.RESET

When the remote controller appears abnormal, use a sharp pointed article to press this button to reset the remote controller normal.

3.LIGHT button

Control the lightening and extinguishing of the indoor LCD display board.

4. TIMER button

Used to select TIMER ON, TIMER OFF, TIMER ON-OFF.

5. CLOCK button

Used to set correct time.

6. SLEEP button

Used to select sleep mode.

7. MODE button



8. HOUR button

Used to set clock and timer setting.

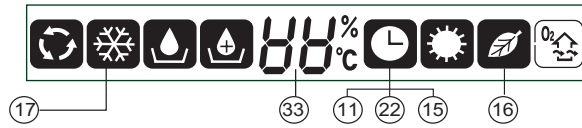

9. HEALTH button

Used to set healthy operation.

10. ON/OFF button

Used for unit start and stop.

11. TIMER ON display

12. FAN SPEED display



13. LOCK display

14. SWING UP/DOWN display

15. SLEEP display

16. HEALTH display

17. Operation mode display

Operation mode	AUTO	COOL	DRY	FAN
Remote controller				
Display board				

18.Singal sending display

19. UV light degerming function display

20. Left/right air flow display

21. TEMP display

Remote controller: to display the TEMP. setting.

22. TIMER OFF display

23. CLOCK display

24. TEMP button

Used to select your desired temperature.

25. FAN button

Used to select fan speed: LOW, MED, HI, AUTO.

26. HEALTH AIRFLOW button

Used to set the health airflow mode.

27. SWING UP/DOWN button

Used to select up or down air sending direction.

28. SWING LEFT/RIGHT button

Used to select left/right air flow.

29. FRESH button

Use to set fresh air function.

30. SET button

Used to confirm timer and clock settings.

31. STERILIZE button

Use to set UV light degerming function.

32. LOCK

Used to lock buttons and LCD display. If pressed, the other buttons will be disabled and the lock condition display appears. Press it once again, lock will be canceled and lock condition display disappears.

33. Ambient temp.display

When receiving the remote control signal, display the set temperature and in the rest time the room temperature is displayed and this room temperature is only for reference.

NOTE:(1) The following functions and related displays are not available: 29

(2) Cooling only unit do not have functions and displays related with heating.

13 Center of gravity

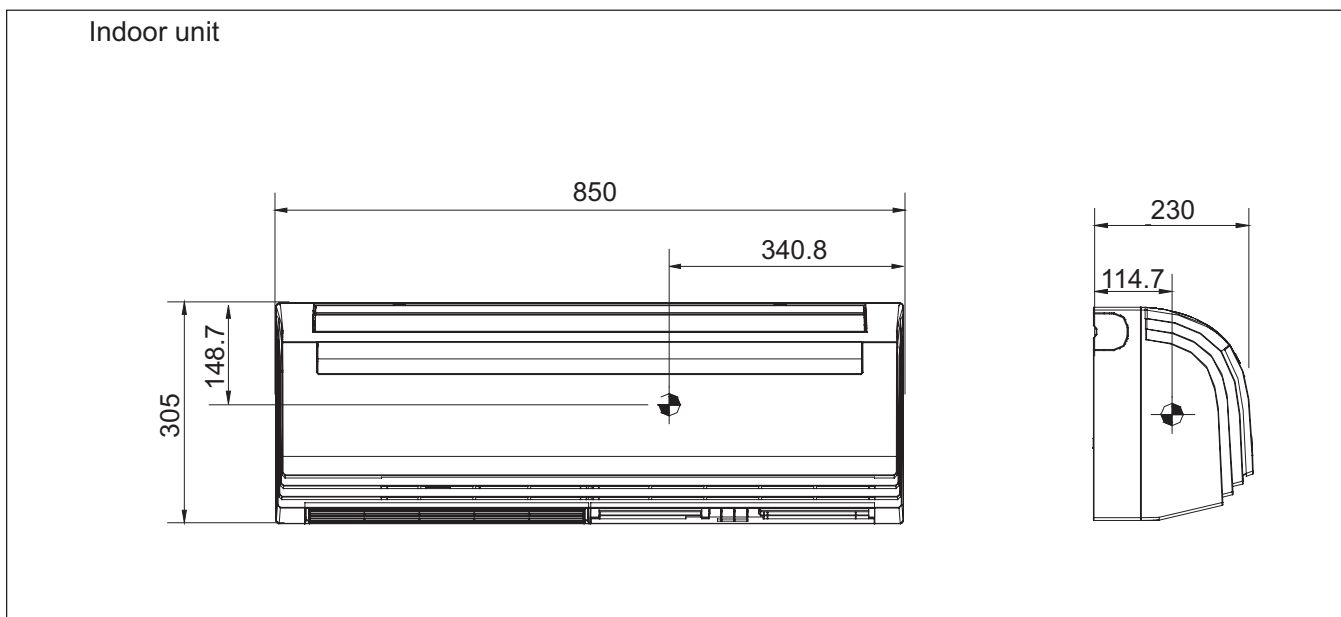

HSU-18C03/V(ZXF)

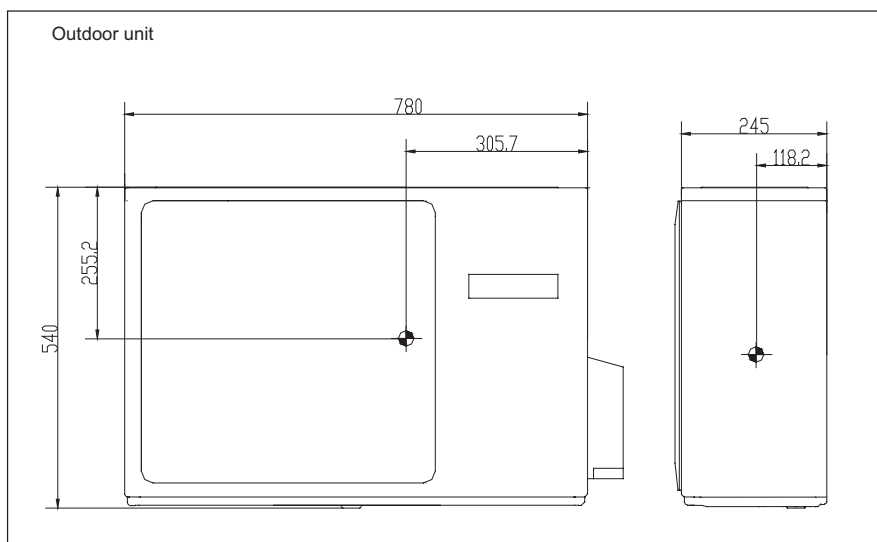

HSU-22C03/V(ZXF)

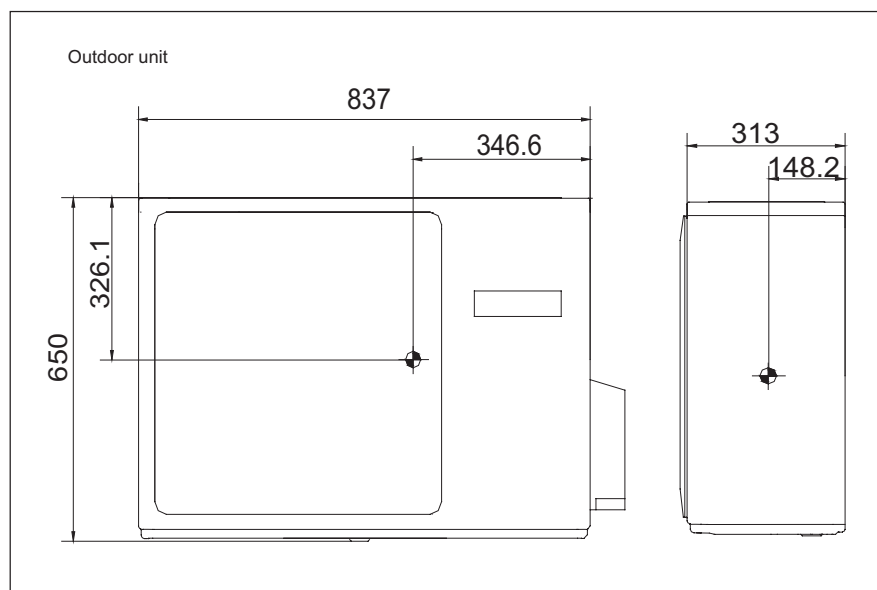

14 Installations

Indoor unit installation drawings

- How to attach the indoor unit.
Hook the claws of the bottom frame to the mounting plate.
If the claws are difficult to hook ,remove the front panel.
- How to remove the indoor unit.
Push up the marked area (at the lower part of the front panel) to release the the claws . If it is difficult to release ,remove the front panel .

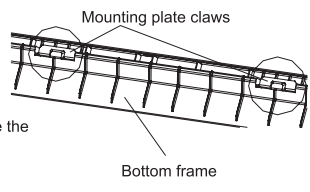

Mounting plate claws
Bottom frame

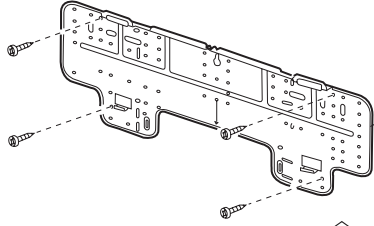

The mounting plate should be installed on a wall which can support the weight of the indoor unit.

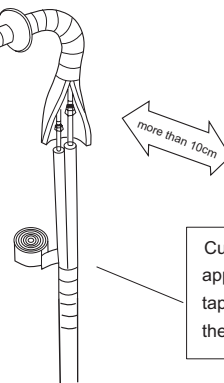
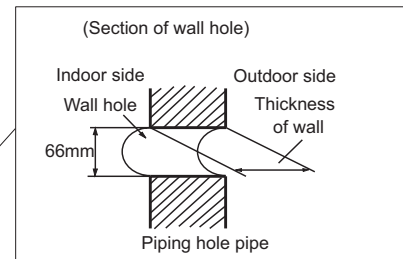
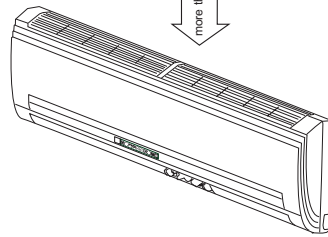
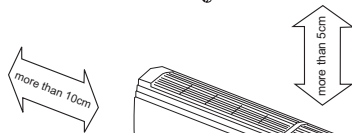

Cut thermal insulation pipe to an appropriate length and wrap it with tape, making sure that no gap is left in the insulation pipe's cut line .

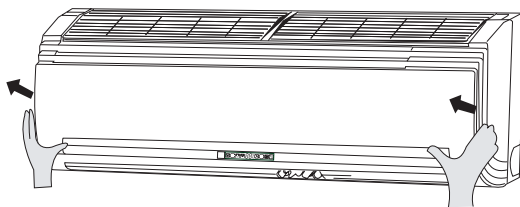

How to remove the air filter.

Open the inlet grille by pulling it upward.

Push up the filter's center tab slightly until it is released from the stopper, and remove the filter downward.

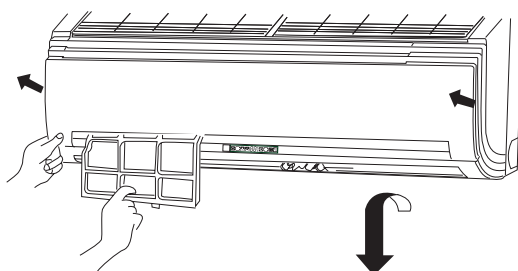

How to Attach the air filter.

Attach the filter correctly so that the "FRONT" indication is facing to the front.Make sure that the filter is completely fixed behind the stopper.If the right and left filters are not attached correctly, that may cause defects.

Close the inlet grille.

Outdoor unit installation drawings

HSU-18,22C03/V(ZXF)

Outdoor

Model	26/28 class
Max.allowable length	Cooling only: 15m Heat pump: 15m
Max.allowable height	5m
Additional refrigerant required for refrigerant pipe exceeding 5m in length	16g/m
Gas pipe	O. D. 6.35/12.7
Liquid pipe	O. D. 9.52/15.88

*Be sure to add the proper amount of additional refrigerant. Failure to do so may result in reduced performance.

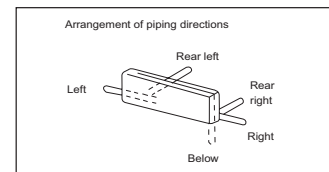

Wrap the installation pipe with the finishing tape from bottom to top Model 25 / 35 class

The distance between the indoor unit and the floor should be more than 2m.

Service lid

- How to remove the service lid. This service lid is an open/close type. Slide the lid downward to remove it.
- How to attach the service lid. Insert the upper part of the service lid into the outdoor unit to install. Tighten the screws.

Where there is a danger of the unit falling, use foot bolts, or wires.

- Fix the unit to concrete or block with bolts (φ10mm) and nuts firmly and horizontally.
- When fitting the unit to wall surface, roof or rooftop, fix a supporter surely with nails or wires in consideration of earthquake and strong wind.
- If vibration may affect the house, fix the unit by attaching a vibration-proof mat.

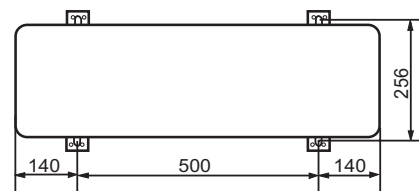

Sincere Forever



Haier Group

Haier Industrial Park, No.1, Haier Road
266101, Qingdao, China

E-mail: hractech@haier.com

Tel: +86 532 87636957

[Http://www.haier.com](http://www.haier.com)

Edited by: Zhao Jicheng

Signed by: Yang Bifei

Approved by: Zhu Zhenxue