

CASSETTE TYPE AIR CONDITIONER

Indoor unit Operation & Installation Manual

Contents

Cautions	1-2
Main Points of Operation.....	3-4
Name of Each Part	5
Safety Cautions.....	6-7
Maintenance	8-9
When Trouble Happens	10
Customer Need-to-know	11
Installation Procedures	12-16
Trouble Shooting.....	17-18
Installation Procedures,Check and Test Run	19

No. 0010575379 

- Please read this operation manual before using the air conditioner.
- Please keep this manual carefully and safely.

HAIER GROUP

Qingdao Haier Air Conditioner Electric Co., Ltd.

Address: Haier Garden, Qianwangang Road, Economic Development Zone,
Qingdao, Shandong 266500, P.R.China

Web Site: <http://www.haier.com>

■ Cautions

Disposal of the old air conditioner

Before disposing an old air conditioner that goes out of use, please make sure it's inoperative and safe. Unplug the air conditioner in order to avoid the risk of child entrapment.

It must be noticed that air conditioner system contains refrigerants, which require specialized waste disposal. The valuable materials contained in a air conditioner can be recycled. Contact your local waste disposal center for proper disposal of an old air conditioner and contact your local authority or your dealer if you have any question. Please ensure that the pipework of your air conditioner does not get damaged prior to being picked up by the relevant waste disposal center, and contribute to environmental awareness by insisting on an appropriate, anti-pollution method of disposal.

Disposal of the packaging of your new air conditioner

All the packaging materials employed in the package of your new air conditioner may be disposed without any danger to the environment.

The cardboard box may be broken or cut into smaller pieces and given to a waste paper disposal service. The wrapping bag made of polyethylene and the polyethylene foam pads contain no fluorochloric hydrocarbon.

All these valuable materials may be taken to a waste collecting center and used again after adequate recycling.

Consult your local authorities for the name and address of the waste materials collecting centers and waste paper disposal services nearest to your house.

Safety Instructions and Warnings

Before starting the air conditioner, read the information given in the User's Guide carefully. The User's Guide contains very important observations relating to the assembly, operation and maintenance of the air conditioner.

The manufacturer does not accept responsibility for any damages that may arise due to non-observation of the following instruction.

- Damaged air conditioners are not to be put into operation. In case of doubt, consult your supplier.
- Use of the air conditioner is to be carried out in strict compliance with the relative instructions set forth in the User's Guide.
- Installation shall be done by professional people, don't install unit by yourself.
- For the purpose of safety, the air conditioner must be properly grounded in accordance with specifications.
- Always remember to unplug the air conditioner before opening inlet grill. Never unplug your air conditioner by pulling on the power cord. Always grip plug firmly and pull straight out from the outlet.
- The air breaker should be all-pole switch, and the distance between it's two connectors should be no less than 3mm.

Cautions

- All electrical repairs must be carried out by qualified electricians. Inadequate repairs may result in a major source of danger for the user of the air conditioner.
 - Do not damage any parts of the air conditioner that carry refrigerant by piercing or perforating the air conditioner's tubes with sharp or pointed items, crushing or twisting any tubes, or scraping the coatings off the surfaces. If the refrigerant spurts out and gets into eyes, it may result in serious eye injuries.
 - Do not obstruct or cover the ventilation grille of the air conditioner. Do not put fingers or any other things into the inlet/outlet and swing louver.
 - Do not allow children to play with the air conditioner. In no case should children be allowed to sit on the outdoor unit.
- If the supply cord is damaged, it must be replaced by the manufacturer or its service agent or a similar qualified person.
 - If the fuse on PC board is broken please change it with the type of T3.15A/250VAC.
 - The wiring method should be in line with the local wiring standard.
 - Use copper wire only. The connecting cable should be H05RN-F 4G 0.75mm². The power cable should be H05RN-F 3G 2.5mm². All the cables shall have got the European authentication certificate.
 - The waste battery shall be disposed properly.
 - The indoor unit installation height is at least 2.5m.
 - The appliance must be installation that the plug should be easily accessible after installation.
 - The power plug should be self-provided and it should have got the Local authentication certificate.

Specifications

The refrigerating circuit is leak-proof.

The machine is adaptive in following situation

1. Applicable ambient temperature range:

		Rated	Maximum	Minimum	
Cooling	Indoor	DB °C	27	32	18
		WB °C	19	23	14
	outdoor	DB °C	35	43	-5
		WB °C	24	26	--
Heating	Indoor	DB °C	20	27	15
		WB °C	14.5	--	--
	outdoor	DB °C	7	21	-15
		WB °C	6	15	--

Installation Procedures, Check and Test Run

Other Instructions

1. Configuration of power supply

- Air conditioner must use special power supply system (above 20A), and qualified electrician makes wiring and fixing according to wiring regulations specified in national standard.
- In socket, exactly distinguish earth wire with neutral wire and it is wrong to connect them together.
- A leakage breaker must be installed.
- Parameters of power supply: H07RN-F 3G 2.0mm²
- Connection method is Y-connection. If the power cord is damaged, it must be replaced by professional people of manufacturer or its maintenance department or similar to avoid dangers.

2. Pipe cutting and expanding

Must remove burrs if cut pipes with pipe cutter.
Expand flare after insert the pipe expander.

	Diameter of pipe	Dimension A (mm)
Liquid pipe	∅ 6.35mm (1/4")	1.0~1.2
Gas pipe	∅ 12.7mm (1/2")	1.4~2.2

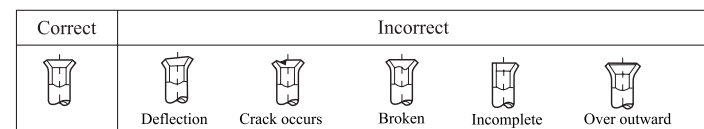
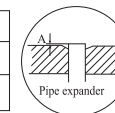

Installation check and test run

Require customers to use air conditioner according to the operation manual.
The items checked during test run, please mark ✓ in

- No gas leakage on the pipe joint ?
- How about the thermal insulation of the pipe joint:
- Is the electrical wiring between indoor and outdoor unit connected to the terminal block firmly?
- Is the wiring of indoor and outdoor unit secured firmly?
- Is the drainage hose arranged correct?
- Is the earthing wire connected firmly?
- Is the power supply voltage conformed to the electrical regulation?
- Any noise?
- Is the display on the control board (LCD) correct?
- Cooling normal?
- Does the indoor temperature regulator work normally?
- For the power supply
 - L shall be connected to the live wire.
 - N shall be connected to the neutral wire.
 - ⊕ Shall be connected to the earth wire.

Trial Operation

The person who has completed this installation shall be requested to conduct a test operation for check:



- Is the temperature adjuster working normally?
- Does the location for installation conform to requirements?

Winding up with Protective Plastic Tape

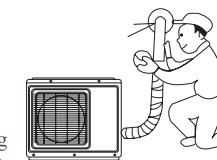
- The connection pipes, drain pipe, and the connection wires shall be wound up with PVC tape.
- Notes: The connection pipes shall also be wound up with insulating material to preserve the temperature. The airing direction shall be from bottom to top.



Trouble Shooting

<p>Air does not blow or the fan speed cannot be changed during drying.</p>	<p>In DRY mode, when room temperature becomes 2°C higher than temperature setting, unit will run intermittently at LO speed regardless of FAN setting</p>
<p>Water or vapor generated from the outdoor unit during heating.</p> 	<p>This happens when the frost accumulated on the outdoor unit is removed (during defrosting operation).</p> <p>Defrosting operation</p> 
<p>During heating, indoor fan is still running even unit is stopped.</p>	<p>To get rid of the excess heat, indoor fan will continue running for a while after unit automatically stops.</p>

Please check the following things about your air conditioner before making a service call.

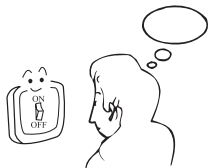
Unit fails to start.		
<p>Is the power supply switch on ?</p>  <p>Power supply switch is not in ON position.</p>	<p>Is city supply power normal ?</p> 	<p>Is the earth leakage breaker in action ?</p> <p>Be sure to turn off the power supply switch immediately and contact the sales dealer.</p>

Main points of Operation

Operation of Air Conditioner

When the environmental humidity is great, water may be dripped from the air outlet in cooling or drying mode.

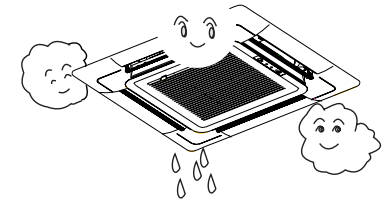

3-minute Protection Function

If restart the unit immediately after stopping, the compressor will start only 3 minutes later to protect the machine.

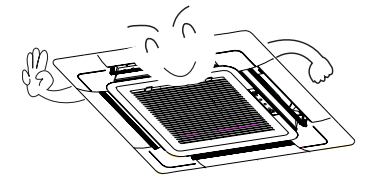

Variation of Fan Speed

If fan speed in auto mode, it will automatically lower when the room temperature close to the setting temperature in cooling mode.

In heating mode, the compressor stops when the room temperature at setting temperature and fan turns into low speed or stops.

In Dry mode, fan speed will be automatically varied.

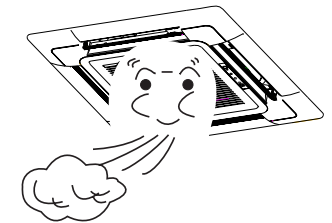

Remote Control:

There is a telecommunication interface for remote control on the control panel of the indoor unit. After the peripheral equipment have been installed in accordance with the instruction manual of the selected remote control detector, the air conditioner will be computerized and controlled from a far-away place.

Main points of Operation

Prevent Cool Air Blowing Off

In heating mode, the indoor fan will not run immediately after the unit starts to prevent the cool air blowing off.



Defrosting Function

In heating mode, when frost formed on the outdoor heat exchanger, the air conditioner will automatically defrost a few minutes. During defrosting, both indoor and outdoor fan will stop running. When defrosting finished, air conditioner will automatically back to running.

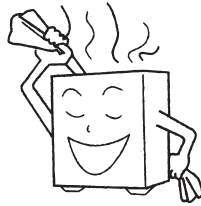

Defrosting Running

Hints

The air conditioner absorbs heat from outside and releases inside when in heating mode, therefore the outside environmental temperature will affect heating effects.

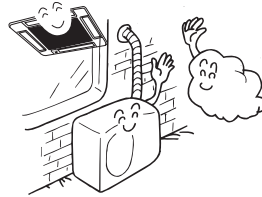

Power Failure Compensation(to be applied for a necessary situation):

After the power failure compensation is set, if power failure suddenly occurs while the air conditioner is working, it will resume the previous working state when the power is supplied again.

Setting Method: When the remote controller is on (excluding timer mode and fan mode), press the "sleep" button on the remote controller 10 times within 5 seconds, and after the buzzer rings 4 times, the air conditioner will enter the state of power failure compensation.





Cancel Method: Press the "sleep" button on the remote controller 10 times within 5 seconds, and after the buzzer rings 2 times, the power failure compensation mode will be cancelled.

Note: When a power failure suddenly occurs during the air conditioner is working after the power failure compensation is set, if the air conditioner will not be used for a long time, please cut off the power supply to prevent its operation from being resumed after the power is supplied again, or press the "Switch On/Off" button after the power comes again.

Note: Series remote controller units please press the remote controller button "CODE" to choose the program of code "B" in function of code B, set and cancel Auto restart function by using of "SWING" button.

Trouble Shooting

The followings are not malfunction

<p>Water flowing sound is heard</p> 	<p>When the air conditioner is started, when the compressor starts or stops during operation or when the air conditioner is stopped, it sometimes sounds "Bi- Bi-" or "Godo-Godo". It is the flowing sound of the refrigerant, not a malfunction.</p>
<p>Cracking sound is heard</p>	<p>This is caused by heat expansion or contraction of plastics</p>
<p>It smells.</p>	<p>Air blown out from the indoor unit sometimes smells. The smell results from smells of furniture, paint, tobacco absorbed by indoor unit.</p>
<p>During operation, white fog comes out of indoor unit.</p> 	<p>When in COOL or DRY mode, a thin water fog can be seen blown out of unit, this is the condensed fog because the suddenly cooled indoor air is blown out.</p>
<p>Automatically switch into FAN mode during cooling.</p>	<p>To prevent frost from being accumulated on the indoor unit heat exchanger, it sometimes automatically switched into the FAN mode, but it will soon back to the cooling mode.</p>
<p>The air conditioner cannot be restarted soon after it stops. Air conditioner does not start?</p> 	<p>This is because of the self-protection function of the system, therefore, it cannot be restarted for about three minutes after it stops.</p>  <p>Please wait for three minutes</p>

Installation Procedures

Piping Connection

(1) Dimension of connecting pipe

Gas pipe	Ø 12.7mm
Liquid pipe	Ø 6.35mm

- Fit the nut on and fasten

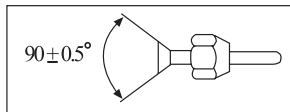

(2) The maximum length and drop height of connecting pipe

- The maximum length is 20m
- The maximum drop height is 10m.
- To ensure the efficiency, Pipes shall be as short as possible.

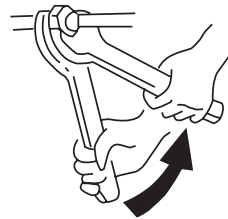
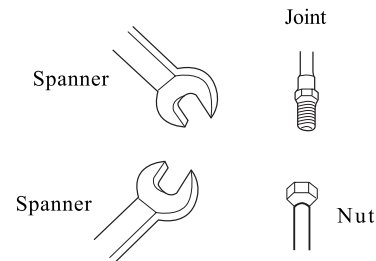

Cautions for piping connection

- Do not twist or deform the connecting pipe.
- Do not mix dusts.
- The bending radius shall be as large as possible.
- Both gas pipe and liquid pipe shall be heat insulation.
- No leakage in the flare.

(3) Piping connection

- Connecting method

Smear refrigerant oil on the joints of piping and flare. The bending radius shall be as large as possible. Align the pipe center when fastening, and tighten the nut, as shown in the figure. Pay attention to not mix foreign matters such as sands in.

Diameter of Pipe	Tighten Torque (N.m)
Liquid Pipe 6.35mm	11.8
Gas Pipe 12.7mm	49.0

If not aligned, tighten the nut by force will damage the nut that result in gas leakage

Name of Each Part

Indoor unit

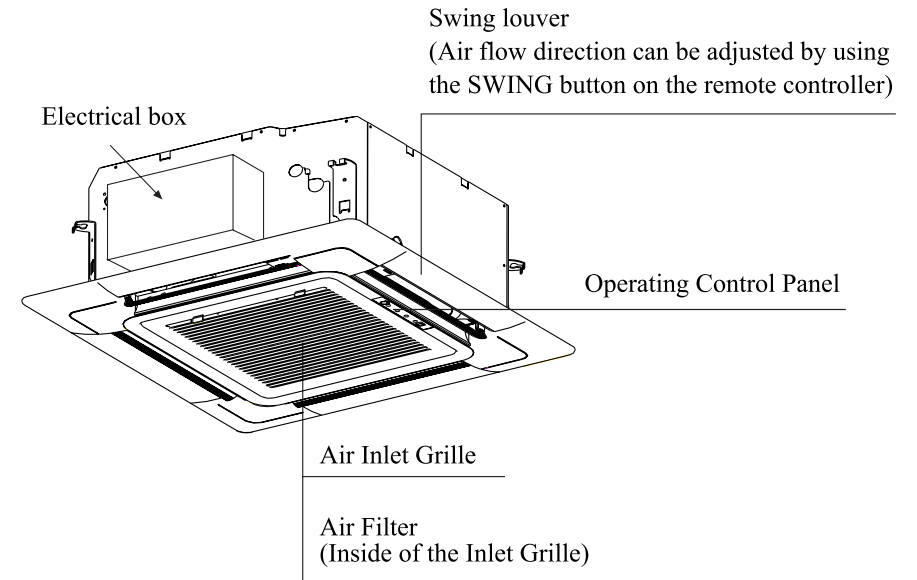

Swing louver
(Air flow direction can be adjusted by using the SWING button on the remote controller)

Electrical box

Operating Control Panel

Air Inlet Grille

Air Filter
(Inside of the Inlet Grille)

Safety Cautions

Carefully read the following information in order to operate the air conditioner correctly.

Below are listed four kinds of Safety Cautions and Suggestions:

WARNING: Incorrect operations may result in severe consequences of death or serious injuries.

CAUTION : Incorrect operations may result in injuries or machine damages; in some cases may cause serious consequences.





⊘ : It must be strictly prohibited where marked with “ Prohibited ”, otherwise may result in machine damages or endanger the user’s personal safety.

INSTRUCTION: This information can ensure the correct operation of the machine.

Be sure to conform with the following important Safety Cautions.

The Safety Cautions should be at hand so that they can be checked at any time when needed.

If the air conditioner is transferred to the new user, this manual should be as well transferred to the new user.

⚠ WARNING	
<p>● If any abnormal phenomena are found (e.g. smell of firing), please cut off the power supply immediately, and contact the dealer to find out’ the handling method.</p> <p>In such case, to continue using the air conditioner will damage the conditioner, and may cause electrical shock or fire hazard.</p> 	<p>● Call the dealer to take measures to prevent the refrigerant from leaking.</p> <p>The leaked refrigerant over certain density may cause oxygen deficient. If the air conditioner is installed in a small room be sure to take measure in order to prevent suffocation accident even in case of refrigerant leakage</p>
<p>● When need maintenance and repair, call dealer to handle it.</p> <p>Incorrect maintenance and repair may cause water leak, electrical shock and fire hazard.</p> 	<p>● When air conditioner is removed and reinstalled dealer should be responsible for them.</p> <p>Incorrect installation may cause water leaking, electrical shock and fire hazard.</p>
<p>● Don’t put figures or any other things into the inlet/outlet and swing louver while the conditioner is in operation</p> <p>Because the high-speed fan is very dangerous and may cause injuries.</p> 	<p>● Don’t dismantle the outlet of the outdoor unit.</p> <p>The exposure of fan is very dangerous which may harm human beings.</p> 
	<p>● After a long time use of air conditioner the base should be checked for any damages.</p> <p>If the damaged base is not repaired, the unit may fall down and cause accidents.</p> 

Installation Procedures

6. Installation of Ornament Panel

Install ornament panel on indoor unit

- (1) Check whether indoor unit is horizontal with leveler or polythene pipe filled with water , and check that the dimension of the ceiling opening is correct. Take off the lever gauge before install the ornament panel.
- (2) Fasten the screws to make the height difference between the two sides of indoor unit less than 5mm.
- (3) First fix it with screws temporarily.
- (4) Fasten the two temporarily fixing screws and other two, and tighten the four screws.
- (5) Connect the wires of synchro-motor.
- (6) Connect the wire of signal.
- (7) If no response of remote controller, check whether the wiring is correct, restart remote controller 10 seconds after shut off power supply.

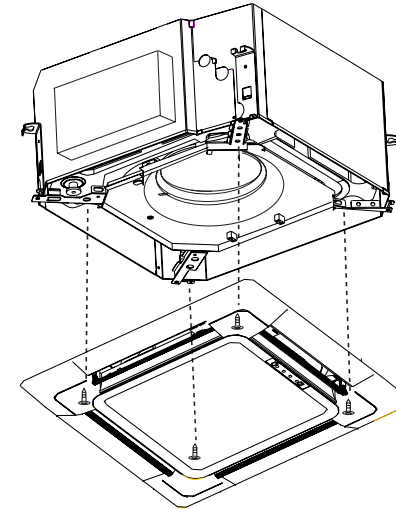

Limits of panel board installation

- (1) Install the panel board in the direction shown in the figure.
- (2) The incorrect direction will result in water leakage, meanwhile swing and signal receiving are displayed that cannot be connected.

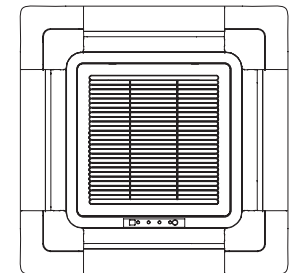

Installation Procedures

4. Installation of water drainage pipe

(1) Install water drainage pipe

- Pipe diameter shall be equal or larger than that of connecting pipe (Pipe of polythene; size: 25mm; O.D.: 32mm)
- Drainpipe should be short, with a downward slope at least 1/100 to prevent air bag from forming.
- If downward slope of drainpipe cannot be made, lifting pipe shall be installed.
- Keep a distance of 1-1.5m between suspending bolts, to make water hose straight.

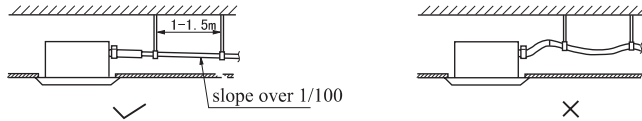

- Use the drainage hose and clip provided with unit.
Insert water pipe into water plug until it reaches the white tape.
Tighten the clip until head of the screw is less than 4mm from hose.
- Wind the drainage hose to the clip using seal pad for heat insulation.
- Insulate drainage hose in the room.

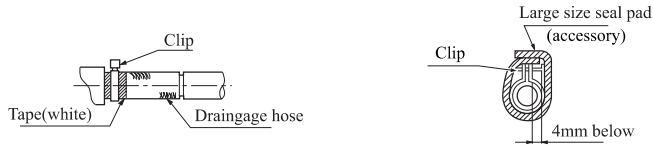

5. Cautions for the water drainage lifting pipe

- Installation height of water drainage lifting pipe shall be less than 280mm
- There should be a right angle with unit ,300mm from unit.

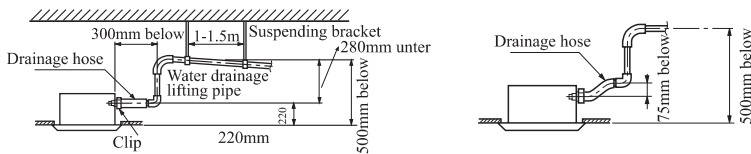

< Note >

- The slope of water drainage hose shall be within 75mm , make the drainage plug not to bear excessive force.
- If several water hoses join together, of as per following procedures.

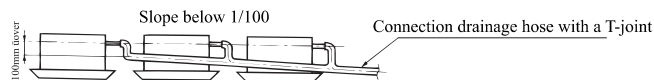

Specifications of the selected drainage hoses shall meet the requirements for the unit running

Safety Cautions

⚠ WARNING

- **No goods or nobody is permitted to be placed on or stand on outdoor unit.**

The falling of goods and people may cause accidents.



- **Don't operate the air conditioner with damp hands.**

Otherwise will be shocked.



- **Only use correct type fuse.**

May not use wire or any other materials replacing fuse, otherwise may cause faults or fire accidents.



- **Don't place any burning unit in the airflow of air conditioner, which may cause incomplete combustion**



- **No inflammable spray fluid should be permitted to be placed or used near to air conditioner, otherwise may cause fire accident.**



- **Air conditioner should be cleaned only after power supply is cut off to keep from shock or hurt.**



- **Don't clean air conditioner with water.**

Otherwise may cause shock.

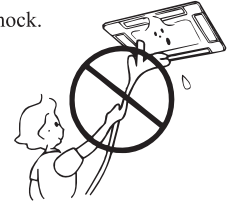

- **Connect earthing wire.**

Earthing wire should not be connected to the gas pipe, water pipe, lightning rod or phone line, incorrect earthing may cause shock.



- **Use discharge pipe correctly to ensure efficient discharge.**

In correct pipe usage may cause water leaking.

- **Air conditioner can't be installed in the environment with inflammable gases.**

The inflammable gases near to air conditioner may cause fire hazard.

- **Installed electrical-leaking circuit breaker.**

It easily causes electrical shock without circuit breaker.

- **When use the fumigating insecticide don't operate air conditioner.**

Otherwise the poisonous chemicals may settle in air conditioner, which harm the health of chemical-allergic people.



Maintenance

Clean the unit

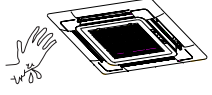
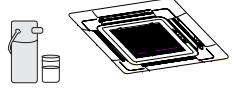
Turn off the power supply switch	Do not touch with wet hand.	Do not use hot water or volatile liquid
		

Button the 2 fixing fastener as shown in the figure by arrow, till the air inlet grille be pulled off.

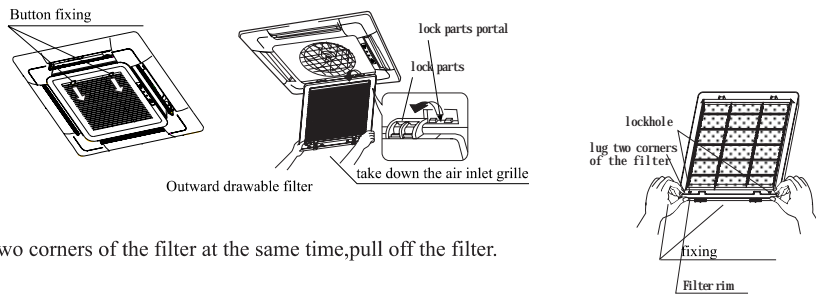

Lug two corners of the filter at the same time, pull off the filter.

Clean the air filter

Clean the air filter with water or vacuum cleaner. Use the detergent or neutral soapy water if the air filter is too dirty. Then rinse the air filter with water, and reinstall after drying.

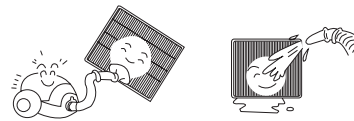

Caution:

Do not clean the air filter with hot water over 40°C, otherwise may damage the filter. Sweep the filter carefully.

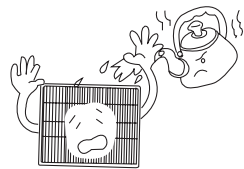

Clean indoor unit

Clean with hot wet cloth and neutral detergent, then wipe with dry cloth. Do not use too hot water (over 40°C) which may result in fading and deforming. Do not use insecticide and chemical washing agent.

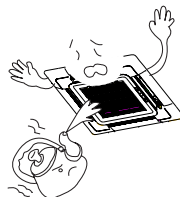

Installation Procedures

(3) Install a suspending bolt

To support the unit weight, anchor bolt should be used in the case of already exists ceiling. For new ceiling, use flush-in type bolt, built-in type bolt or parts prepared in the field. Before going on installing, adjust space to ceiling.

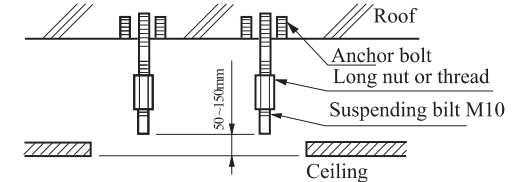

Note: All the above mentioned parts shall be prepared in field, the diameter of suspending bolt is M10

3. Installation of indoor unit

<Installation Example>

In case of no ceiling
Install unit temporarily

Put suspending bracket on the suspending bolt to hang the unit up. Be sure to use nut and washer at both end of the bracket to secure firmly.

After installation on the ceiling

- (1) Adjust unit to its right position (Refer to preparation for installation-(1))
- (2) Check that unit is horizontal.

Water pump and floating switch is installed inside indoor unit, check four corners of the unit for its level using horizontal comparator or PVC tube with water. (If unit is tilting against the direction of water drainage, problem may occur on floating water leakage.)

In the case of ceiling already exists

- (1) Install unit temporarily
Put suspending bracket on the suspending bolt to hang the unit up. Be sure to use nut and washer at both end of the bracket to secure it firmly.
- (2) Adjust the height and position of the unit.
- (3) Proceed with procedure (4) of " In the case of no ceiling "

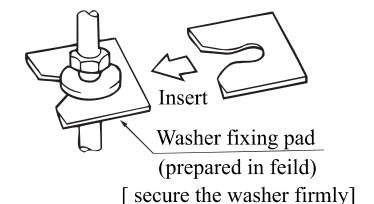
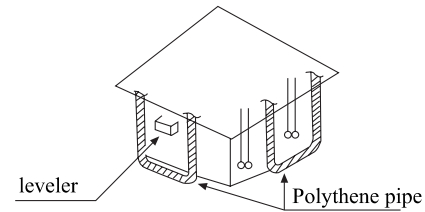
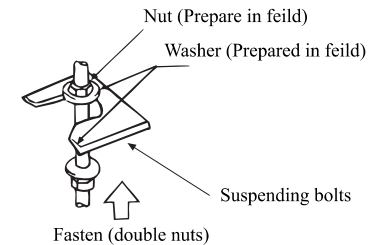

Installation Procedures

1. Selection of Installation Place

- (1) Place above the ceiling where have enough space to arrange the unit.
- (2) Place where the drainage pipe can be arranged well.
- (3) Place where inlet and outlet air of indoor and outdoor unit will not be blocked.
- (4) Do not expose the unit to the place with heavy oil or moisture (e.g.kitchen and workshop).
- (5) Do not set the unit in the place where destructive gas (such as sulfuric acid gas) or pungent gas (thinner and gasoline) concentrates and retains.
- (6) Place strong enough to support the unit weight.
- (7) No expensive articles such as television and piano below indoor unit.
- (8) Enough space for maintenance.
- (9) Place more than 1m away from television and radio to avoid disturbing television and radio.
- (10) Easy for maintenance.

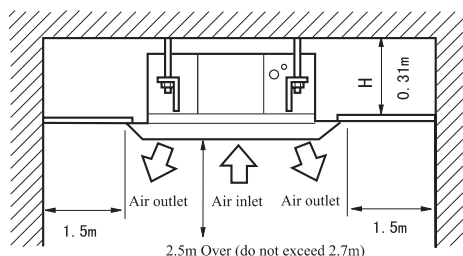

2. Installation Preparation

- (1) Position of ceiling opening between unit and suspending bolt (front view of unit).

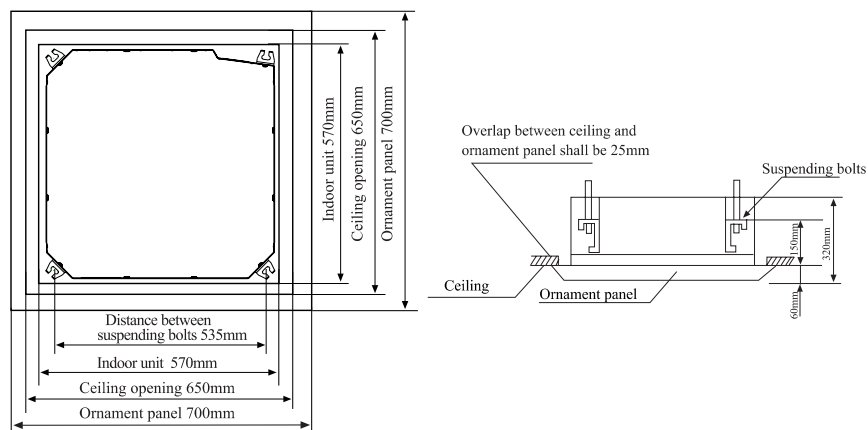

- (2) Prepare all piping (refrigerant,water drainage)and wires (connection wire of remote controller, indoor unit connection wires) to the indoor unit before installation in order to connect indoor unit immediately after installation.

Maintenance

Seasonal Reserve

Post-season Care

Operate the unit with FAN mode on a fair day for about half a day to dry the inside of the unit well.



Stop operation and turn off the power supply switch .Electric power is consumed even the air conditioner is in stop.

Clean the air filter, indoor unit and outdoor unit,and cover the unit with dustcoat.



Pre-season Care

See that there is no obstacle blocking the air inlet and air outlet of both indoor and outdoor unit to avoid reduce the working efficiency.

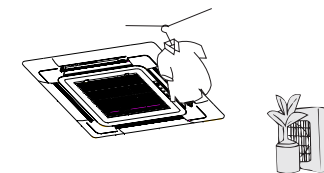



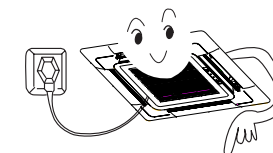

Be sure to install the air filter, ensure that the air filter is not dirty. Otherwise may result in machine damages or cause malfunction due th dust inside the unit

To protect compressor when start in HEAT mode, please cut in the power supply switch 12 hours before starting run,furthermore, always keep the power supply switch on during the using senson.



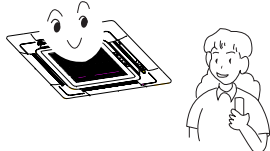
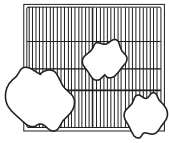

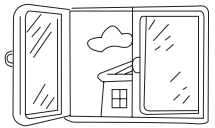
When Trouble Happens

Insufficient cooling or heating

<p>The operation controller adjusted as required</p> 	<p>Air filter too dirty ?</p> 	<p>Horizontal swing louver upward ? (in HEAT mode)</p> 
<p>Any obstacle exists at the air inlet or outlet?</p> 	<p>Door or window left opened ?</p> 	

Insufficient cooling

<p>Any other heat sources in the room?</p> 	<p>Sunlight direct into the room ?</p> 	<p>Too crowded in the room ?</p> 
---	---	---

Cooled air blown out (when heating)



	<p>When the air conditioner does not operate properly after you have checked the above-mentioned items or when following phenomenon is observed, stop the operation of the air conditioner and contact your sales dealer. The fuse or breaker often shuts down. Water drops off during cooling or drying operation. There is an irregularity in operation or abnormal sound that is audible.</p>
---	--

Customer Need-to-know

Customer Need-to-know

- Please install the air conditioner according to the requirements specified in this manual to ensure the air conditioner work well.
- Be careful not to scratch the surface of the case during moving the air conditioner.
- Please keep the installation manual for future reference when maintenance and changing installation place.
- After installation ,please use the air conditioner according to the specification in the operation manual.

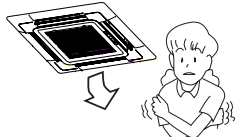
Using Directions

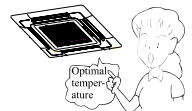
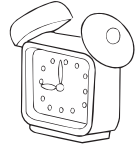
<p>Adjust suitable airflow direction</p> 	<p>Avoid direct sunlight and airflow</p> 
<p>Keep the proper indoor temperature. Too cool or hot is not good for your health. Furthermore, it will result in excessive consumption of electric power.</p> 	<p>Using TIMER mode, you can make the room temperature reach a suitable temperature when you wake up or back home. Effectively use timer.</p> 

ATTENTION: after finishing installation, please confirm no refrigerant leakage.

Installation tools

The installation tools listed in the following sheet can be used as required.

1. Screw driver
2. Hacksaw
3. Drill with a diameter of 60mm
4. Inner hexagon spanner, shifting spanner
5. Spanner (14, 17, 19, 24, 27mm)
6. Pipe cutter
7. Pipe expander
8. Knife
9. Pincers
10. Leakage detector or soapy water
11. Band tape
12. Scraper
13. Refrigerant oil

The following parts mentioned in this manual are the installation accessories we prepared.

Symbol	Parts Name
A	Adhesive tape
B	Pipe clamp
C	Connecting hose
D	Drainage hose
E	Non-hydroscopic heat insulating material
F	Gypsum powder