

Indoor Unit Operation & Installation Manual

AC092MCAHA

AC122MCAHA

AC162MCAHA

AC182MCAHA

AC242MCAHA

AC382MFAHA

AC482MFAHA

No.0150503869

- Please read this manual carefully before using
- Keep this operation manual for future reference

User Manual

The indoor unit, suspended to ceiling or standing on floor, renders considerable operating ease and flexibility.

With its ultra-thin design, dazzling exterior and space economy, the indoor unit fits in well with indoor scenarios.

Boasting superb power and fast temperature tuning, the indoor unit delivers undeniable comforts and pleasures whenever you feel like wanting the same.

Highly efficient silencing technology greatly reduces operating noises and delivers natural comforts.

In case of sudden blackout during operation, the indoor unit, with its Blackout Retrieval function preset, is capable of retrieving its operating status prior to the blackout when power supply is restored.

Integrated Control is available with the indoor unit (through integrated controller).

Multi-connected unit series features “uniform control mode”, i.e., all indoor units are restricted to run on heating or cooling mode at the same time.

For the protection of compressor, the air conditioning unit shall be powered for over 12 hours.

Contents

Parts and Functions	1-6
Safety Considerations	7-9
Operation instruction	10-17
Maintenance	18
Fault Checkup	19
Installation Procedures	20-27
Electrical Wiring	28-32
Functions of Wired Controller	33
Test Run & Fault Code	34-35

Operating Range of Air Conditioner

cooling dry	indoor	max.	DB: 32 °C	WB: 23 °C
		min.	DB: 18 °C	WB: 14 °C
	outdoor	max.	DB: 43 °C	WB: 26 °C
		min.	DB: -5 °C	
heating	indoor	max.	DB: 27 °C	
		min.	DB: 15 °C	
	outdoor	max.	DB: 21 °C	WB: 15 °C
		min.	DB: -15 °C	

Parts and Functions

Indoor Unit

Model AC092~242MCAHA

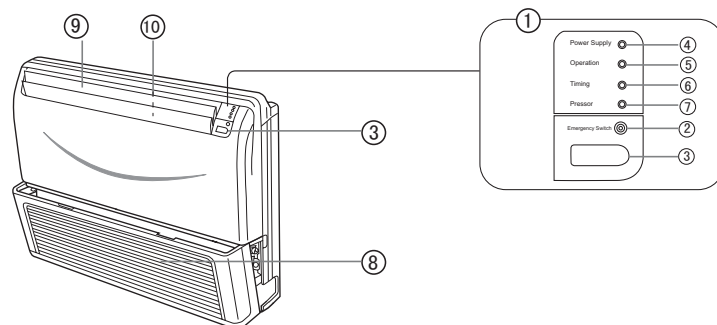

- ① Control Panel
- ② Emergency Operation Switch
- ③ Remote Control Signal Window Receiver
- ④ Power Indicator
- ⑤ Operation Indicator
- ⑥ Timing Indicator
- ⑦ Pressor Indicator
- ⑧ Air Inlet
- ⑨ Outlet Guide Plate
- ⑩ Outlet Flap

Model AC382~482MFAHA

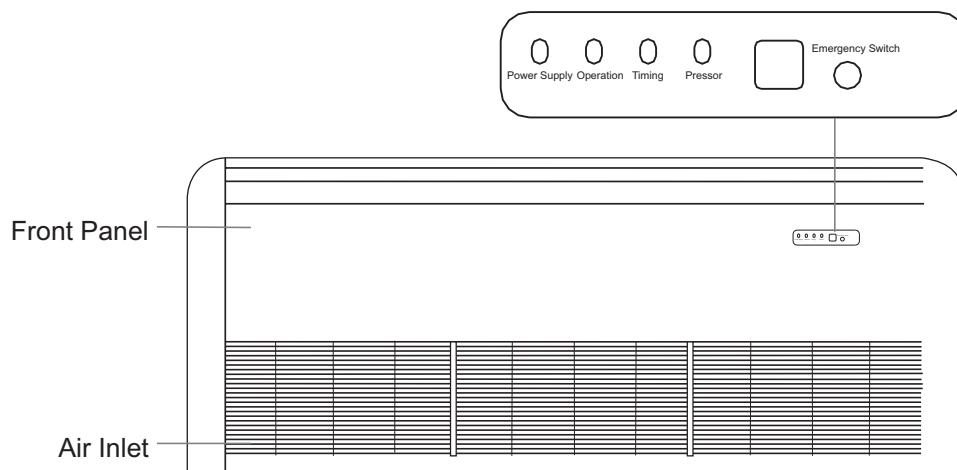

Parts and Functions

Wind Direction Regulation

Model AC092~242MCAHA

Auto Airflow

Press the Wind Direction button, outlet guide plate changes posture as shown below.

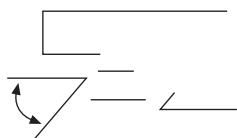

Model AC382~482MFAHA

Auto Airflow

Press Up/Down Airflow button, outlet guide plate changes posture as follows

COOL/DRY/FAN:



HEAT:

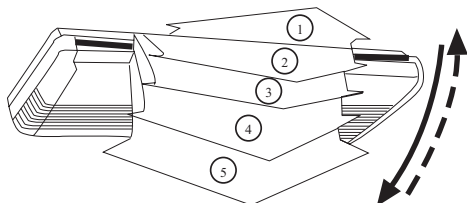

Recommended angles at which swinging guide plate stops

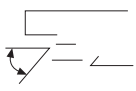
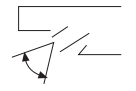
Cooling and Drying	 Air Delivery along Horizontal Direction
Heating	 Downward Air Delivery

Upper/Lower Guide Plates Swing Range:

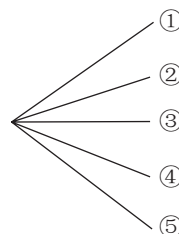

Air Guide Plate Positioning	Swing Range
①	① → ③
②	① → ③
③	② → ④
④	③ → ⑤
⑤	① → ⑤ (All Covered)

Fixing Outlet Direction

Decide upon a proper angle when guide plates move in auto airflow mode and press Wind Direction button to fix wind direction.

Upper/lower flaps commanding airflow directions shall be positioned as follow when fixing wind directions:

Upward in cooling and drying mode

Downward in heating mode

- Make sure that outlet plates or flaps are adjusted only and always through the Wind Direction button on remote control; manual adjusting may cause malfunction.
- Outlet guide plates constantly positioned downwards are prohibited when cooling and drying modes are activated as vapor close to outlet grille may condense and resultant water may drip down from the unit.
- Please pay close attention to temperature regulation values when operating the unit in places where infants, children, old people and patients are to be found.

Parts and Functions

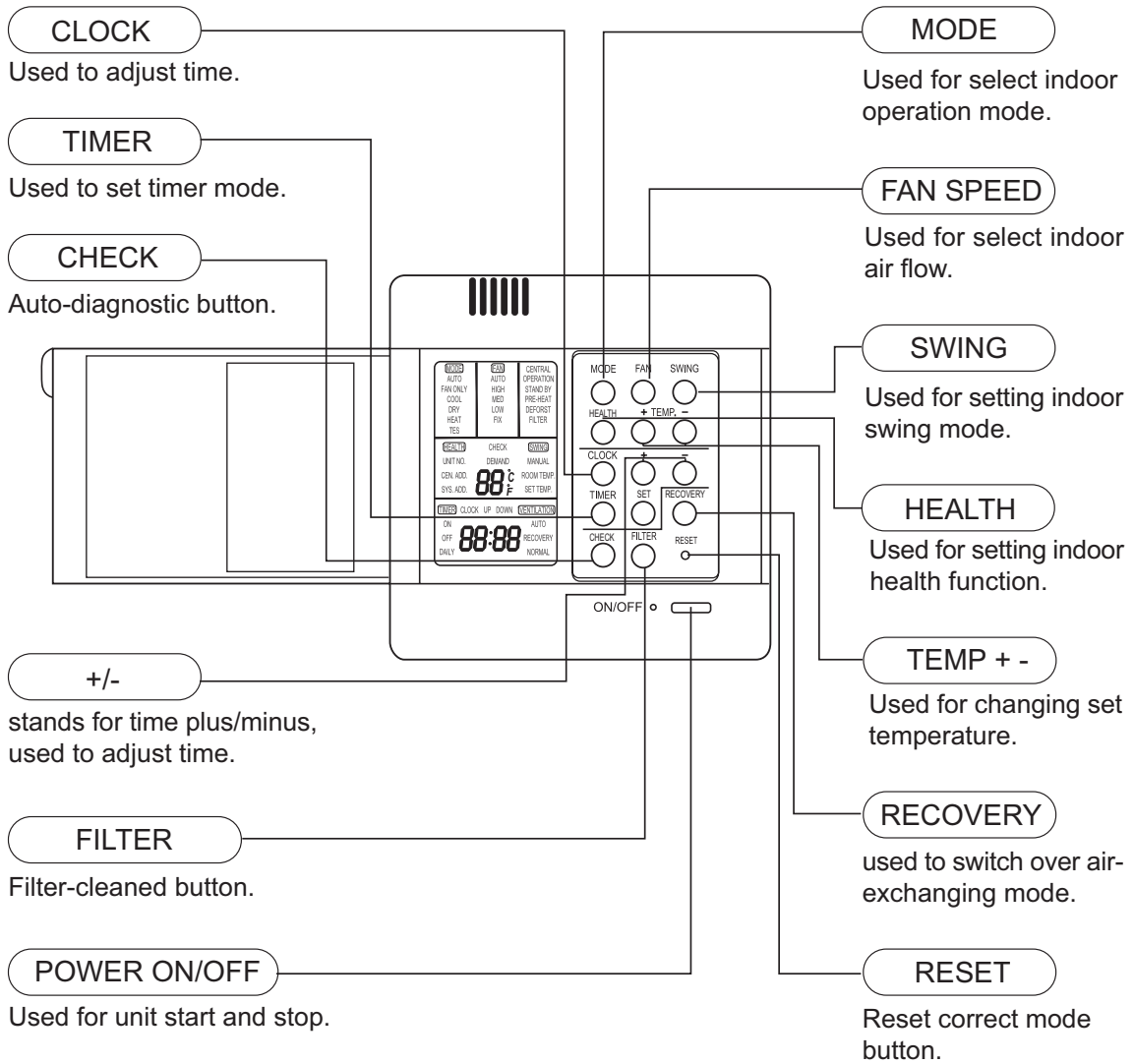

Cautions:
On cooling only unit, heating mode is not available.

Note:
The above information is the explanation of the displayed information therefore varies with those displayed in actual operation.

Parts and Functions

[MODE]

- [AUTO]:Auto operation mode.
- [FAN ONLY]:air-throwing mode.
- [COOL]:Cooling operation mode.
- [DRY]:Dehumidification mode.
- [HEAT]:Heating operation mode.

[FAN]

- [AUTO]:Auto fan running.
- [HIGH]:High fan speed.
- [MED]:Medium fan speed.
- [LOW]:Low fan speed.
- [FIX]: Fixed fan speed, it will display only when fixed fan speed is requested to main indoor unit.

[CENTRAL]:Central control mode.

[OPERATION]:Running mode.

[STAND BY]: Waiting mode.

[PRE-HEAT]: Pre-heating mode.

[DEFROST]: Defrosting mode.

[FILTER]: Request of filter to be cleaned.

[HEALTH]:Health function.

[CEN.ADD]:Central control address, the address number will display on "88".

[SYS.ADD.]:System address, the address number will display on "88".

[CHECK]:Auto-diagnostic, trouble shooting.

[DEMAND]:Compulsory operation function, when it works, [CENTRAL] will flash.

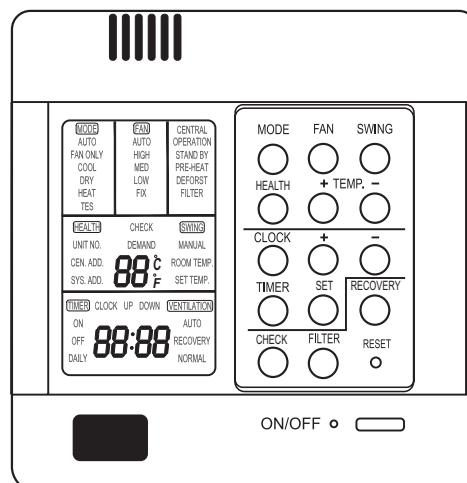

[SWING][MANUAL]:Swing mode.

[ROOM TEMP.]:Indoor ambient temperature.

[SET TEMP.]:Set admired temperature.

[TIMER]

[ON]:Timer function is on.

[OFF] :Timer function is off.

[ON][OFF] :Timer function ON-OFF.

[ON][OFF][DAILY]:Timer ON-OFF will switch over in turn daily

[CLOCK]:Clock display, the displaying time is the current time of the clock.

[UP],[DOWN]:Indicator of filter elevating.

[VENTILATION]

[AUTO]:Auto ventilation mode.

[NORMAL]:Normal ventilation mode.

Parts and Functions

Remote controller

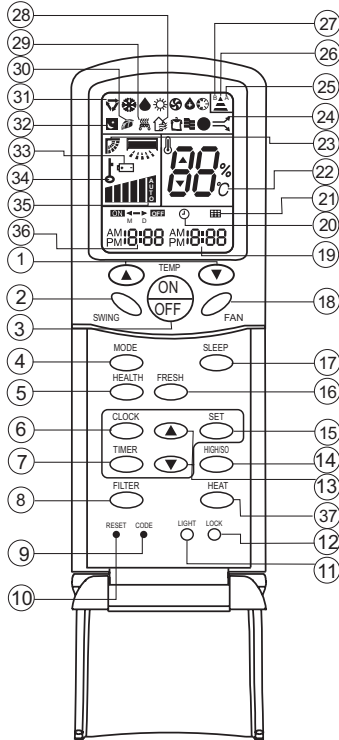

1. TEMP Setting Button

(Used to set temperature. Setting ranges: 16°C to 30°C)

In Up/Down function of filter, for controlling up and down filter.

2. SWING Button

If you press this button once, auto swing will be activated.

If you press this button again, the louver will fix in the present position.

3. Power ON/OFF Button

Used for unit start or stop

After power on, the LCD of remote controller will display the previous operation state (except for TIMER, SLEEP and SWING state).

4. Operation MODE

Used to select operation mode.

Every time you press MODE button, operation mode changes according to following sequence:

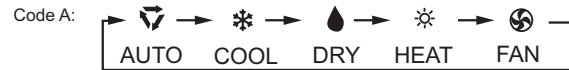

5. HEALTH Button

6. CLOCK Button

Used to set correct time.

7. TIMER Button

Used to select TIMER mode: TIMER ON, TIMER OFF, TIMER ON/OFF.

(Note: if time of TIMER ON is the same as TIMER OFF, TIMER ON/OFF cannot be set)

8. FILTER Button

Used to set up/down function of filter.

9. CODE Button

Used to select Code A or B, Normally at Code A.

As you can't control the indoor unit, please change the Code to B.

10. RESET Button

Press this button by using a sharp article to resume the correct operation of the remote controller in case of need, i.e. for example in case of malfunctions due to electromagnetic disturbance.

11. LIGHT Button

Used to light the control panel

12. LOCK Button

Used to lock operation button and LCD display contents: by pressing this button, other buttons comes out of function and lock state display appears; if you press it again, lock state will be no more active and lock state display will disappear.

13. HOUR Adjustment

Used to set clock and timer setting

14. HIGH/SO Button

Used to select HIGH or SOFT operation.

15. SET Button

Used to confirm TIMER and CLOCK settings.

16. FRESH Button

Used to set fresh mode, the unit will draw in fresh air.

NOTE: 1. Models in this manual have no functions ⑤ ⑧ ⑪ ⑭ ⑯ ⑰ ⑲ ⑳ ㉓ ㉔ ㉕ ㉖ ㉗ ㉘ ㉙ ㉚ ㉛

2. HIGH/SO button

This button is active in Cooling/Heating mode, the fan speed is in AUTO mode after pressing it and " high functon " will be automatically cancelled after 15 minutes running.

Parts and Functions

17. SLEEP Button

(The clock must be corrected before setting sleep function)

Used to set sleep mode.

18. FAN Button

Used to select fan speed: LOW, MID, HIGH, AUTO.

19. TIME Display

20. TIMER Display

21. FILTER Display

When the filter need be cleaned, you can press the FILTER button for 3s, to up/down function.

22. TEMPERATURE Display

23. AUTO SWING Display

24. HIGN/SO Run Display

25. Code A of controller's state

Code A is used for this unit

26. SIGNAL SENDING Display

27. Code B of controller's state

28. Fresh Display

29. Auxiliary ELECTRICAL HEATING Display

30. HEALTH Display

Displays when healthy run function is set.

31. Operation MODE Display

AUTO RUN	COOL RUN	DRY RUN	HEAT RUN	FAN RUN

32. SLEEP State Display

33. BATTERY Energy Display

Notify the user when it is time to change the batteries.

34. LOCK State Display

35. FAN SPEED Display



36. TIMER ON Display

37. HEAT Button

Used to select auxiliary heater.

Remote Controller Operation

- When in use, direct signal transmission head to the receiver placed on the indoor unit

- The distance between the remote controller and the receiver should be max 7m and there should be no obstacle between them.
- Do not throw the remote controller; prevent it from being damaged.
- When operating the remote controller in an area where electronically controlled lights are installed or wireless handsets are used, please move closer to the indoor unit as the function of the remote controller might be affected by signals emitted by the above mentioned equipments.

Battery loading

Battery loading

Batteries are fitted as follows:

Remove the battery compartment lid. Slightly press and disengage the battery compartment lid marked with "▲" and then hold the remote controller by the upper section and then remove the battery compartment lid by pressing in the direction of the arrow as shown in the figure above.

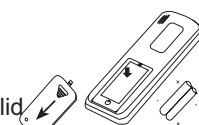

Loading the battery

Ensure that batteries are correctly placed in the compartment as required for positive and negative terminals.

Replacing the battery compartment lid

The battery compartment lid is reinstalled in the reverse sequence.

Display review

Press the button to see if batteries are properly fitted. If no display appears, refit the batteries.

Confirmation indicator

If no indication is displayed after press ON/OFF button, reload the batteries.

Caution:

If the remote controller does not operate as designed after fitting new batteries of the same type, press the Reset button (marked) with a pointed article.

Note:

It is recommended that the batteries be removed from the compartment if the remote controller is not used for an extended period.

The remote controller is programmed for automatic test of operation mode after the batteries are replaced. When the test is conducted, all icons will appear on the screen and then disappear if the batteries are properly fitted.

When throw away the waste batteries, please perform in accordance with the local regulation.

Clock Set



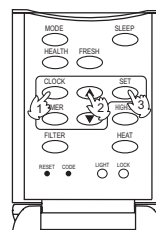

When unit is started for the first time and after replacing batteries in remote controller, clock should be adjusted as follows:

- Press CLOCK button, clock indication of " AM " or " PM " flashes.
- Press " ▲ " or " ▼ " to set correct time. Each press will increase or decrease 1 min. If the button is kept pressed, time will increase or decrease quickly.
- After time setting is confirmed, press "SET" : AM or PM stop flashing, while clock starts working.

Note: AM means morning and PM means afternoon.



Safety Considerations

- If the air conditioner is transferred to a new user, this manual shall be transferred to the user, together with the conditioner.
- Before installation, be sure to read Safety Considerations in this manual for proper installation.
- The safety considerations stated below is divided into “ Warning” and “ Attention”. The matters on severe accidents caused from wrong installation, which is likely to lead to death or serious injury, are listed in “ Warning”. However, the matters listed in “ Attention” are also likely cause the severe accidents. In general, both of them are the important items related to the security, which should be strictly abided by.
- After the installation, perform test run to make sure everything is in normal conditions, and then operate and maintain the air conditioner in accordance with the User Manual. The User Manual should be delivered to the user for proper keeping.



Warning

- Please ask the special maintenance station for installation and repair. Water leakage, electric shocks or fire accidents might be caused from improper installation if you conduct the installation by your own.
- The installation should be conducted properly according to this manual. Water leakage, electric shocks or fire accidents might be caused from improper installation.
Please make sure to install the air conditioner on the place where can bear the weight of the air conditioner.
- The air conditioner can't be installed on the grids such as the non-special metal burglar-proof net. The place with insufficient support strength might cause the dropdown of the machine, which may lead to personal injuries.
- The installation should be ensured against typhoons and earthquakes, etc. The installation uncomformable to the requirements will lead to accidents due to the turnover of the machine.
- Specific cables should be used for reliable connections of the wirings. Please fix the terminal connections reliably to avoid the outside force applied on the cables from being impressed on the cables. Improper connections and fixings might lead to such accidents as heating or fire accidents.
- Correct shapes of wirings should be kept while the embossed shape is not allowed. The wirings should be reliably connected to avoid the cover and the plate of the electrical cabinet lipping the wiring. Improper installation might cause such accidents as heating or fire accidents.
- While placing or reinstalling the air conditioner, except the specific refrigerant (R22), don't let the air go into the refrigeration cycle system. The air in the refrigeration cycle system might lead to the cracking or personal injuries due to abnormal high pressure of the refrigeration cycle system.
- During installation, please use the accompanied spare parts or specific parts. If not, water leakage, electric shocks, fire accidents or refrigerant leakage might be caused.
- Don't drain the water from the drainpipe to the waterspout where may exist harmful gases such as sulfureted gas to avoid the harmful gases entering into the room.
- During installation, if refrigerant leakage occurs, ventilation measures should be taken, for the refrigerant gas might generate harmful gases upon contacting the flame.
- After installation, check if any refrigerant leakage exists. If the refrigerant gas leaks in the room, such things as air blowing heaters and stoves, etc. may generate harmful gases.
- Don't install the air conditioner at the places where the flammable gases may leak. In case the gas leakage occurs around the machine, such accidents as fire disasters may be caused.
- The drainpipe should be properly mounted according to this manual as to ensure the smooth drainage. In addition, heat preservation should be taken to avoid condensation. Improper drainpipe mounting might cause water leakage, which will get the articles at home wet.
- The refrigerant gas pipe and liquid pipe should be heat insulated to preserve heat. For inappropriate heat insulation, the water caused from the condensation will drop to get the article at home wet.

Attention

- The air conditioner should be effectively grounded. Electric shocks may occur if the air conditioner is ungrounded or inappropriately grounded. The wire for earthing shouldn't be connected to the connections on the gas pipe, water pipe, lightning rod or telephone.
- The breaker for electricity leakage should be mounted. If not, accidents such as electric shocks may happen.
- The installed air conditioner should be checked for electricity leakage by being powered.

Safety Considerations

	<p>Items with this warning sign concerning the product's safety and the personal security must be performed strictly.</p>
	<p>Items with this forbidding sign refer to absolutely forbidden behaviors. If not, they may cause machine damage or endanger operator's personal safety.</p>

Clean the filter regularly.
Cooling or heating performance will be degraded if the filter is blocked, resulting in large power consumption, failure, and water dripping at freezing.

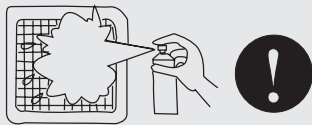

Don't touch the outlet while the flap is moving. Don't put anything in the grid in case danger may occur.

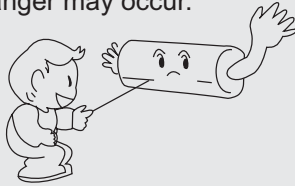

Avoid cold wind from blowing out.
During heating running, the fan of indoor units will not rotate immediately as to prevent cold wind from blowing out.

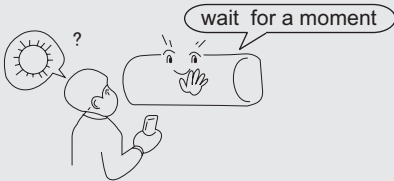

Changing Wind Speeds:
In the state of refrigerating, with automatic blowing mode, the wind speed automatically decreases when the room temperature approaches the setting.
In the state of heating, when the room temperature reaches the setting temperature the compressor stops working and the fan turns to low wind or stops. Wind speed changes automatically in the dehumidifying mode.

Regulating Wind Direction:
It is recommended not to make the wind deflector downwards for a long time to avoid condensation at air outlet port during refrigerating or dehumidifying.
Water dropping might appear at the air outlet port in refrigerating or dehumidifying mode.

Defrosting:
During heating running, the air conditioner would defrost automatically if there is frost on heat exchanger of outdoor units.
Do not rotate fans of both indoor units and outdoor units during defrosting.
After finishing defrosting, the air conditioner will resume running automatically.

The machine operation must be controlled by the control.



Hints:
As air conditioners absorb heat from the environment and release it to the room, heating effects will be influenced by the temperature in and out of the room.

Safety Considerations



Attention

Notices during Operation

- It is not allowed to put any heating apparatus under the indoor units, for the heat may cause distortion of the units.

- Pay attention to the aeration condition to avoid anoxic symptom.



- Flammable apparatus should not be placed in the place where the air conditioner wind could reach directly, or incomplete burning of the apparatus may be caused.



- Check the mount table of the air conditioner for damage for a long period of operation. If placed on the damaged table, the unit may drop down causing damage.



- Plants and animals should not be put to the place where wind of the air conditioner blows directly, otherwise damage to them may be caused.



- It cannot be used for the preservation of food, living creature, precise instrument and artworks, etc, otherwise damage may occur.



- Use the fuse with proper capacity. Metal wires and copper wires, etc., may cause fire or other faults.



- Do not use water heater or like next to the indoor unit and the wired controller. Water/power leakage or short circuit may happen if the steam generating apparatus is working next to machine.



- Defrosting during heating
To improve the heating effect, the outdoor unit will perform defrosting automatically when frost appears on the outdoor unit during heating (approximately 2-10 min). During defrosting, the fan of the indoor unit runs at a low speed or stops while that of the outdoor unit stops running.

- Power should be cut off when the air conditioner is left unused for a long period. Power will be consumed if the air conditioner is not powered off. The power switch of the outdoor unit switch should be powered on 12 hours in advance before operation to protect the unit after a long period of storage.

- 3-minute protection
To protect the unit, compressor can be actuated with at least 3-minute delay after stopping.

- Close the window to avoid outdoor air getting in. Curtains or window shutters can be put down to avoid the sunshine.



- Do not touch the switch with the wet hand to avoid power shock.



- Stop running and switch off the manual power switch when cleaning the unit.



- During the operation of the control unit, don't switch off the manual power switch and the controller can be used. Please do not press the liquid crystal zone of controller to prevent damage



- Cleaning the unit with water may cause electric shock.



- Do not put flammable spray close to the air conditioner. Don't inject flammable spray towards the air conditioner, which may cause fire.



- Stopping fan rotation
The unit which stops operating will actuate the fan for a 2-8 min swing every 30 – 60 minutes for protecting the unit while other indoor unit are in the operating state.

Operation instruction

FAN ONLY OPERATION:

- 1) Start up operation: press the button of ON/OFF, the system will start up, and will display on LCD.
- 2) Select MODE: press the MODE button, then you will see in the display section [MODE] switch over in below sequence: [FAN ONLY] → [COOL] → [DRY] → [HEAT] → [AUTO] → [FAN ONLY]. Select [FAN ONLY].
- 3) Select fan speed: press FAN button, then you see in the display section [FAN] switch over in below sequence: [HIGH] → [MID] → [LOW] → [HIGH]. Select proper fan speed.
- 4) Power off: press ON/OFF button, indoor unit will be powered off, there are only time and the ambient temperature in the screen.

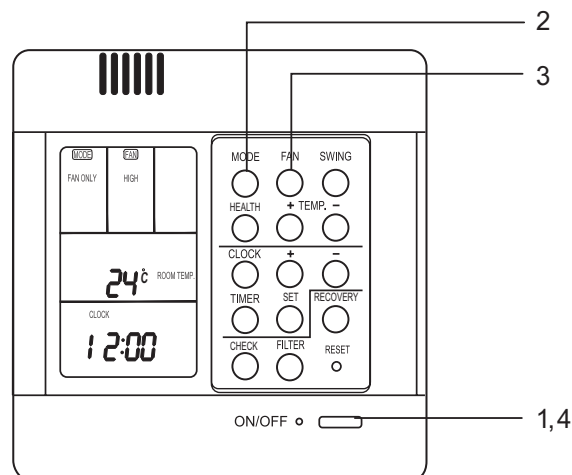

AUTO operation, COOLING, HEATING and DEHUMIDIFICATION operation

- 1) Start up operation: press the button of ON/OFF, the system will start up, and will display on LCD.
- 2) Select MODE: press the MODE button, then you will see in the display section [MODE] switch over in below sequence: [FAN ONLY] → [COOL] → [DRY] → [HEAT] → [AUTO] → [FAN ONLY].
- 3) Change set temperature: press TEMP + or - every time, [SET] will display, and set temperature will increase/reduce 1 °C (F).
- 4) Select fan speed: press FAN button, then you see in the display section [FAN] switch over in below sequence: [HIGH] → [MID] → [LOW] → [HIGH]. Select proper fan speed.
- 5) Select [SWING]: press [SWING] button, [SWING] will display, swing function is valid, press again, [SWING] will disappear, swing function is invalid.
- 6) Set [HEALTH]: used to set the indoor health function. Press it once, [HEALTH] will display in the display section, then indoor health function is valid. Press it again, [HEALTH] will disappear, then the health function is invalid. This function is valid only for the unit with health function.
- 7) Power off: press ON/OFF button, indoor unit is powered off. There are only time and the ambient temperature in the screen.

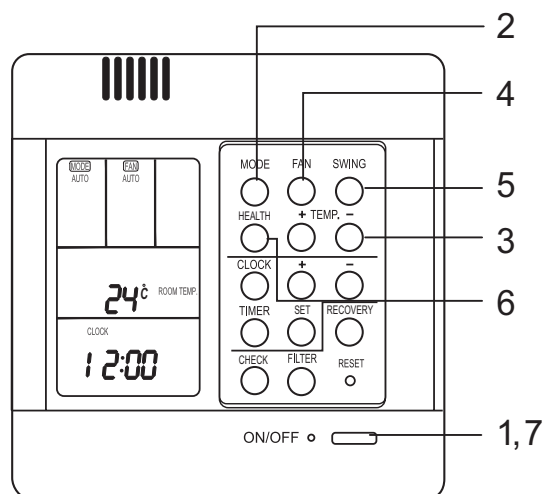

Operation instruction

Set TIMER operation:

Adjust clock: when powered on, for the first time to set timer function, the clock will be adjusted. Press "CLOCK" button, and set the current clock. Now, "CLOCK" will flash at the frequency of 2Hz every minute. Press the clock +/- button; the current clock can be adjusted. Until the proper time comes, press [SET].

TIMER ON operation:

Press TIMER button, and keep pressing it, in the display section [TIMER] will switch over in below sequence: [ON] → [OFF] → [ON][OFF] → [ON][OFF][DAILY] → []. Select [TIMER] [ON], then [TIMER] [ON] flashes, press the clock +/- button to adjust the time of TIMER ON, press [SET] button.

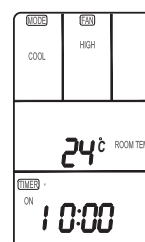

TIMER OFF operation:

Press TIMER button, and keep pressing it, in the display section [TIMER] will switch over in below sequence: [ON] → [OFF] → [ON][OFF] → [ON][OFF][DAILY] → []. Select [TIMER] [OFF], then [TIMER] [OFF] flashes, press the clock +/- button to adjust the time of TIMER OFF, press [SET] button.

TIMER ON-OFF operation:

Press TIMER button, and keep pressing it, in the display section [TIMER] will switch over in below sequence: [ON] → [OFF] → [ON][OFF] → [ON][OFF][DAILY] → []. Select [TIMER] [ON] [OFF]. Firstly, [TIMER][ON] flashes, press the clock +/- button to adjust the time of TIMER ON, press [SET]. [TIMER][ON] will be constant on. Then [TIMER] [OFF] flashes, press the clock +/- button to adjust the time of TIMER OFF, press [SET]. The time sequence of timer on and timer off will determine the mode is [TIMER] [ON] → [OFF] or [TIMER] [OFF] → [ON].

Note:

1. If the two times are the same, the unit will adjust the state after set time arrives according to the current state. If current state is in running mode, after set time arrives the unit will switch to "power off" state. If current state is in "power off" mode, after set time arrives, the unit will switch to running mode.
2. When in TIMER setting state, if you do not input any button in continuous 10 seconds, the unit will think [SET] pressed.

Cancel TIMER operation:

In the timer operation state, press [TIMER] button, the unit will quit from the current timer operation state, and the set data will be memorized, then enter the next timer mode.

After timer be set, press ON/OFF to cancel timer mode. When in running again, timer mode will be continuous (without timer).

[FILTER] function

When the wired controller receives the filter-cleaned signal from indoor unit, [FILTER] will display. After finishing clean, press [FILTER], the sign [FILTER] disappears, and the controller will send the filter reset signal to indoor unit.

When the sign [FILTER] not display, it is invalid to press [FILTER] in short time.

Operation instruction

FILTER ELEVATING function: (only for the unit with elevating function)

In power off state, press [FILTER] for 5 seconds to enter filter elevating set state. In this state, the sign [FILTER] will flash at the frequency of 2Hz. By pressing [+] TEMP [-], filter can go up or down. Press TEMP [+], in timer section [UP] will display, while press TEMP [-], in timer section [DOWN] will display. Press [FILTER] button to quit the mode. This function is invalid for the AB*2MCAHA models in this book.

DEMAND operation function:

In the stop state of cooling mode, press [ON/OFF] button for 5 seconds to enter [DEMAND] cooling operation state, the sign [DEMAND] will display. In the 7-segment liquid crystal screen of set temp. section, "0" will display in first position, which shows that No. 0 indoor unit has enter demand operation. In the second position, "L" will display, in the meantime, [COOL] will flash, [FAN][AUTO] is constant on. Press TEMP [+] [-] to set different indoor unit. Press [ON/OFF] to cancel [DEMAND] operation.

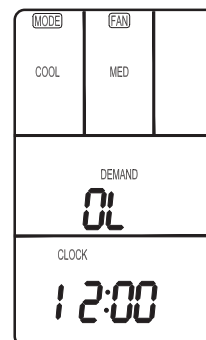

In the stop state of heating mode, press [ON/OFF] button for 5 seconds to enter [DEMAND] heating operation state, the sign [DEMAND] will display. In the 7-segment liquid crystal screen of set temp. section, "0" will display in first position, which shows that No. 0 indoor unit has enter demand operation. In the second position, "H" will display, in the meantime, [HEAT] will flash, [FAN][AUTO] is constant on. Press TEMP [+] [-] to set different indoor unit. Press [ON/OFF] to cancel [DEMAND] operation.

VENTILATION mode (only for the unit with fresh air function or heat recovery function)

Press [RECOVERY] button, then the unit will switch over the ventilation mode:

[] → [VENTILATION][AUTO] → [VENTILATION][RECOVERY] → [VENTILATION][NORMAL] → [], please select appropriate ventilation mode.

Query indoor malfunction history:

In the state of power on or power off, press [CHECK] button, enter the malfunction-querying mode of all indoor units in the group. Then [CHECK] and [UNIT NO.] will display, and the actual indoor numbers will be displayed in some sequence (unit number is in decimals). At the same time, in the time region, there will be the current malfunction and the latest time malfunction, the displaying format is [XX:YY], in which XX stands for the current malfunction, if normal, it will display "--"; YY stands for the latest time malfunction. The failure code of every unit will display for 3 seconds. After the failure codes of all indoor units in the whole group are displayed, the mode will quit automatically.

Clear abnormal state and malfunction history:

In normal state, press [CHECK] button for 5 seconds to clear abnormal states, at the same time, wired controller will send the data of "clear abnormal state", but the malfunction history still retains.

In normal state, press [CHECK] button for 15 seconds, except for malfunction states, the malfunction history in wired controller will be cleared.

Operation instruction

Query indoor performance state:

Under normal condition, press “Setting” button for 5 seconds until the temperature zone on the liquid crystal screen shows [XX], referring to the unit number of indoor units and select unit, and select unit number by “Temp. +/-” button. The time zone displays [YZZZ], in which, Y refers to the data type and ZZZ to the responding data. Select the data type by “Time +/-” button.

Y	ZZZ	System
A	Temperature of indoor unit transducer TA	Actual value, decimal system
B	Temperature of indoor unit transducer TC1	Actual value, decimal system
C	Temperature of indoor unit transducer TC2	Actual value, decimal system
D	PMV step of indoor units	Actual value/2. decimal system(e.g. indication of 50 with actual step of 100)
E	Communication address between indoor/outdoor units	Actual value, sexadecimal system
F	Central address	Actual value, sexadecimal system

Under the inquiring state, press “CHECK” button to quit the inquiring state and return to the normal operating state.

How to change the function switches?

No.	Type	State of switch	Function description
J03	Display of room temperature	Connected	Yes
		Cut off	No
SW01 ①	Changeover of master or slave controller	ON	Set as slave controller
		OFF	Set as master controller
SW01 ②	°C or °F	ON	°F
		OFF	°C
D1	Shorten time function	Connected	Indoor unit in shorted time function
		Cut off	Common control
D2	Compulsorily defrost	Connected	Send compulsorily defrost signal to indoor unit
		Cut off	Common control

Note: The switches in grey can be operated after opening the cover of wired

Operation instruction

AUTO, COOL , HEAT and DRY Operation

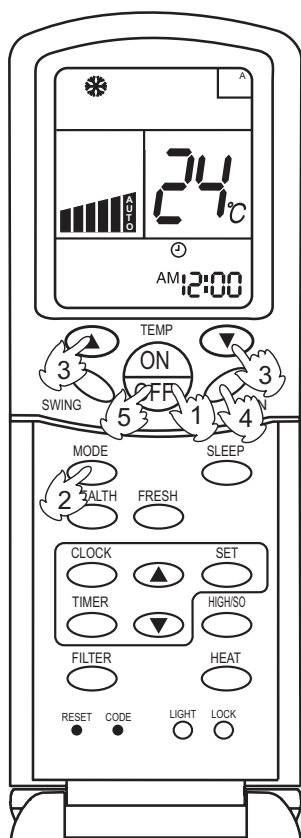

1. Unit start

Press ON/OFF button, unit starts.

Previous operation status appears on LCD (except for TIMER, SLEEP and SWING setting)

2. Select operation mode

Press MODE button. At each press, operation mode changes as follows:



Then or or or

3. Temperature setting

Press TEMP button.

▲ Every time the button is pressed, temp. setting increases 1 °C; if the button is kept pressed, temp. setting will increase quickly.

▼ Every time the button is pressed, temp. setting decreases 1 °C, if the button is kept pressed, temp. setting will decrease quickly.

Set proper temperature

4. Adjust FAN button

Press FAN button. At each press, fan speed changes as follows:



Air conditioner will run at the selected fan speed.

5. Unit stop

Press ON/OFF button, unit stops.

COOL operation starts when room temp. is higher than temp. setting.

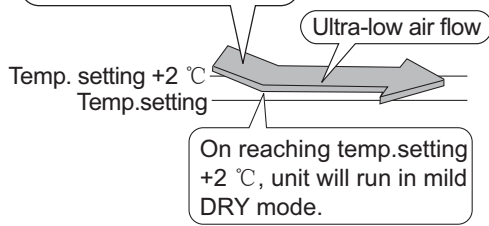

In FAN mode, the temperature setting is not displayed on LCD.

In DRY mode, when room temperature becomes 2 °C higher than temperature setting, unit will run intermittently at LOW speed regardless of FAN setting. When room temperature is lower than temperature setting, unit will only run FAN operation.

In HEAT mode, warm air will blow out after a short period of time due to cold-draft prevention function.

Operation instruction

Fan Operation (Only for Code A)

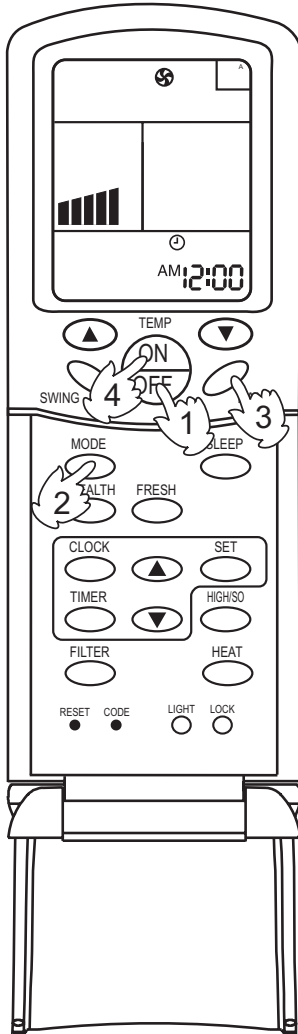

1. Unit start

Press ON/OFF button to start your air conditioner. Previous operation status appears on LCD (except for TIMER, SLEEP, and SWING setting).

2. Select operating mode

Press MODE button. At each press, operation mode changes as follows:



Then select FAN

3. Adjust fan speed

Press FAN button. At each press, fan speed changes as follows:



Air conditioner will run at the selected fan speed. When in AUTO mode, unit will adjust fan speed according to room temperature automatically.

4. Unit stop

Press ON/OFF button to stop unit.

About FAN mode

When the air conditioner runs in FAN mode, it is not possible to select AUTO FAN or to set temperature.

Operation instruction

Adjusting air flow direction

AUTO SWING

Press SWING button.

Up and down airflow varies upwards and downwards. Left and right airflow varies left and right sides.

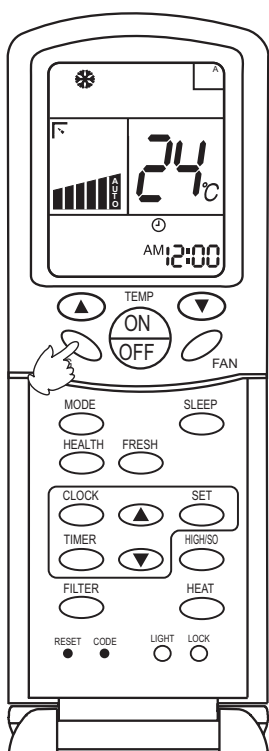

AUTO SWING

When the automatic swing louver moves to the proper angle, press SWING button can fix the airflow direction.

- Always use SWING button on the remote controller to adjust flaps. Adjusting them by hand may result in air conditioner's abnormally running.
- In COOL or DRY mode, do not leave the louver in downward position for a long time, as the water vapor close to the grille may condense and water may drop from the air conditioner.
- Please carefully set temperature when children, old or infirm people uses the air conditioner.
- If the vertical flaps are completely turned towards left or right, the louver will drop water.
- Never adjust the louver directly by hand, as this could make it work abnormally. If the louver work abnormally, stop unit, restart and adjust the louver by remote controller.

After unit stops:

Displays on the LCD disappear.

All indicators on the indoor unit go out.

Swing louver automatically close the air outlet.

Hints:

As in COOL mode air flows downwards, adjusting airflow horizontally will be much more helpful for a better air circulation

As in HEAT mode air flows upwards, adjusting airflow downward will be much more helpful for a better air circulation.

Be careful not to catch a cold when cold air blows downward directly.

Operation instruction

Timer ON/OFF Function

Set clock correctly before starting TIMER operation

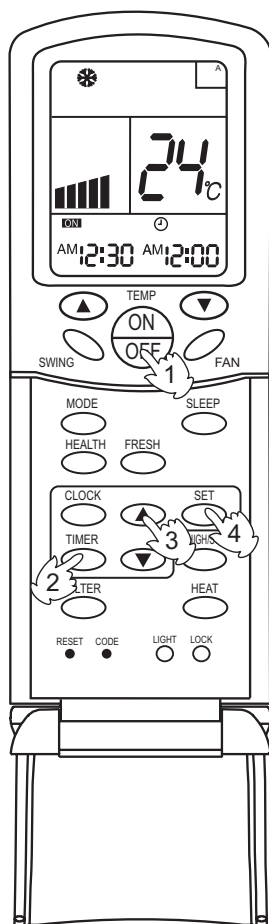

1. Unit start

After unit start, select your desired operation mode (operation mode will be displayed on LCD)

2. TIMER mode selection

Press TIMER button on the remote controller to change TIMER mode. Every time the button is pressed, display of TIMER mode changes as follows:



Then select TIMER mode as needed (TIMER ON or TIMER OFF).

Now **ON** or **OFF** will flash.

3. TIMER setting (press time adjust buttons \blacktriangle \blacktriangledown)

\blacktriangle Every time the button is pressed, time increases 1 minute.
If the button is kept pressed, time will change quickly.

\blacktriangledown Every time the button is pressed, time decreases 1 minute.
If the button is kept pressed, time will change quickly.
It can be adjusted within 24 hours at will.

4. Confirm setting

After setting correct time, press SET button to confirm time. Now

ON or **OFF** stop flashing.

Time displayed: unit starts or stops at X hour X min (TIMER ON or TIMER OFF)

5. Cancel TIMER mode

Just press TIMER button several times until TIMER mode disappears.

Hints:

After replacing batteries or if a power failure occurs, TIMER setting must be reset.

Remote controller has memory function. When you use TIMER mode next time, just press SET button after mode selection if timer setting is the same as the previous one.

Maintenance

※Only when the air cleaner is switched off and disconnected to the power supply can it be cleaned, or electric shock and injury may appear.

Cleaning the air outlet port and the shell:



Attention

- Don't use gasoline, benzene, diluents, polishing powder or liquid insecticide to clean them.
- Do not clean them with hot water of above 50°C to avoid fading or distorting.
- Wipe them with soft dry cloth.
- Water or neutral dry cleanser is recommended if the dust cannot be removed.
- The Wind Deflector can be dismantled to clean (as below).

Cleaning Wind Deflector:

- Do not wipe the wind deflector with water forcibly to avoid falling off.

Cleaning Air Cleaner:



Attention

- Don't rinse the air cleaner with hot water of above 50°C to avoid fading and distorting.
- Don't put the air cleaner on the fire to dry to avoid catching fire.

- Pull the air screen forward to the front side of the unit to remove it.
- Clean up air screens according to their different types. For more information, please make contact with after service staff.



- Wipe dust with water or dust collector.

(A) Wipe dust with dust collector.



(B) Clean it with soft brush in mild detergent if there is too much dust on it



(C) Throw off the water and airing it in the cool dry condition.

Maintenance before and after Operating Season

Before Operating Season:

1. Please make the following checkup. If abnormal condition occurs, consult the after-service personnel.
 - There is no blockage in inlet port and outlet port of outdoor and indoor units.
 - The ground line and the wiring are in the proper state
2. After cleaning, the air cleaner must be mounted.
3. Switch on to the power.

After Operating Season:

1. In sunny days, blowing operation can be performed for half a day to make the inside of machine dry.
2. Electrical power should be cut down to economize electricity, or the machine will still consume power. Air cleaner and shell must be mounted after cleaning.

Fault Checkup

Please check the following when consigning repair service:

	Symptoms	Reasons
All these are not problems	• Water flow sound	Water flow sound can be heard when starting operation, during operation or immediately after stopping operation. When it starts to work for 2-3 minutes, the sound may become louder, which is the flowing sound of refrigerant or the draining sound of condensed water.
	• Cracking sound	During operation, the air conditioner may make the cracking sound, which is caused from the temperature changes or the slight dilation of heat exchanger.
	• Terrible smell in outlet air	The terrible smell, caused from walls, carpet, furniture, clothing, cigarette and cosmetics, attaches on the conditioner.
	• Flashing operating indicator	When switching it on again after power failure, turn on the manual power switch and the operating indicator flashes.
	• Awaiting indication	It displays the awaiting indication as it fails to perform refrigerating operation while other indoor units are in heating operation. When the operator set it to the refrigerating or heating mode and the operation is opposite to the setting, it displays the awaiting indication.
	• Sound in shutdown indoor unit or white steam or cold air	To prevent oil and refrigerant from blocking the shutdown indoor units, refrigerant flows in the short time and make the sounds of refrigerant flowing. Otherwise, when other indoor units performs heating operation, white steam may occur; during refrigerating operation, cold air may appear.
	• Clicking sound when switching the air condition on	When the conditioner is powered on, the sound is made due to the resetting of the expansion valve.
Please make another check.	• Start or stop working automatically	Check if it is in the state of Timer-ON and Timer-OFF.
	• Failure to work 	Check if there is a power failure. Check if the manual power switch is turned off. Check if the supply fuse and breaker are disconnected. Check if the protective unit is working. Check if refrigerating and heating functions are selected simultaneously with the awaiting indication on line control.
	• Bad cooling & heating effects	Check if air intake port and air outlet port of outdoor units are blocked. Check if the door and windows are open. Check if the filtering screen of air cleaner is blocked with sludge or dust. Check if the setting of wind quantity is at low wind. Check if the setting of operation is at the Fan Operation state. Check if the temperature setting is proper.

Under the following circumstances, immediately stop the operation, disconnect the manual supply switch and contact the after-service personnel.

- When buttons are inflexible actuated;
- When fuse and breaker have been burnt over and over;
- When there are foreign objects and water in the refrigerator;
- When it cannot still be operated after removing the operation of protective unit;
- When other abnormal conditions occur.

Installation Procedures

This manual does not cover all user cases; please contact Haier marketing centers in local places to propose new requirements and clear new doubts and problems.

Standard installation tools are recommended according to installation requirements. For information about standard model series accessories, see packing list; other necessary parts to be installed shall be prepared by users as required by installation service network stations.

Decide upon places to install the indoor unit; places where even circulation of cool and warm air can be delivered shall be selected; and places below shall be avoided:

※ Places (in coastal areas) where salinity is high; where sulfurized gases are usual (areas where springs flourish and copper tube and braze easily get corroded); where oils (machinery oils) and steam are usual; where organic solvents are put to use; where machines radiating high frequency electromagnetic waves exist (which cause control system malfunctions); where contact with humid air near windows and doors is pervasive (making for easy condensation) and; where special sprayers are put to frequent use.

Installing Indoor Unit

1. The distance from air outlet to floor surface shall not exceed 2.7m.
2. Make sure that outlet airflow covers the whole room area; and arrange connecting tubes, wires and drain pipes to proper outdoor positions.
3. Make sure that ceiling structures are capable of bearing unit weight.
4. Connecting tubes, drain pipes and connecting wires can be put across walls to connect indoor unit and outdoor unit.
5. Connecting tubes and drain pipes between indoor and outdoor units shall be shorter for better.
6. Please refer to outdoor installation manual when refrigerant charging volume adjusting is necessary.
7. Joint flanges shall be prepared by users.
8. Valuables (e.g., TV sets, instruments, equipments, artworks, pianos, wireless devices) shall not be placed below the indoor unit lest condensed water drips upon the same.

Installing and Fixing

1. Drilling Wall Holes

Drill a wall hole (dia.70mm, see figure 1), slightly tilted downwards on the outside; fix guard ring to finalize before sealing the wall hole with gesso or putty.

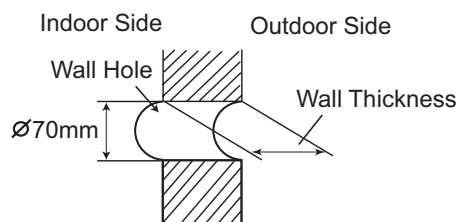

Figure 1 (Wall Hole in Section)

2. Preparation prior to Installing Indoor Unit

Open inlet grille according to figure 2 and figure 3.

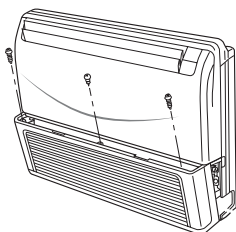

Figure 2 Model AC092~242MCAHA

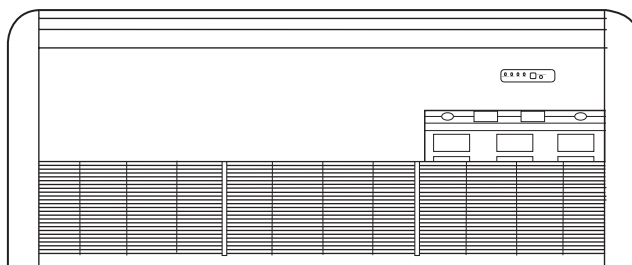

Figure 3 Model AC382~482MFAHA

Installation Procedures

3. Floor Type Installation

- ① Fix four rubber feet to the bottom of the unit with $\varnothing 4 \times 16$ bolts and $\varnothing 12$ spacers (applicable to floor type units only).
- ② According to figure on the right, choose a certain direction to lead out drain pipe; drain holes are available on both right and left sides; practical conditions shall be considered. After deciding upon the directions to lead out pipelines, wires and drain pipes, drill wall holes according to required drilling processes.

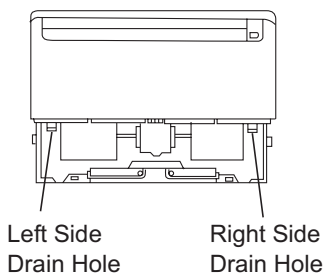
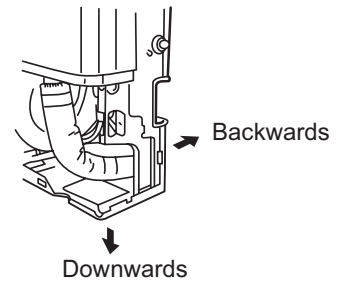

Figure 4 Model AC092~242MCAHA

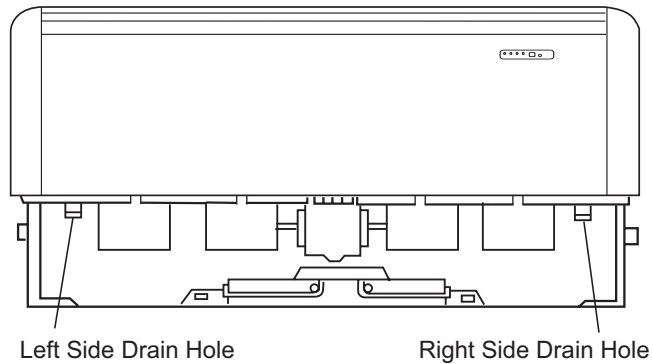
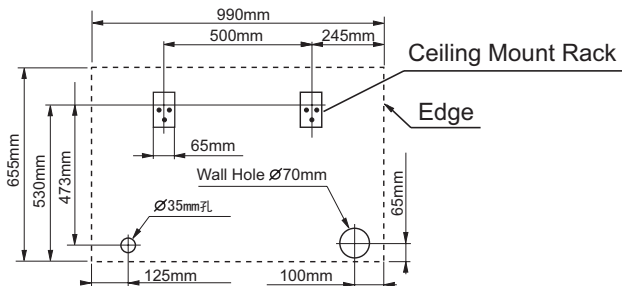
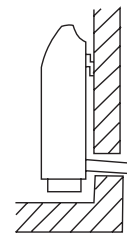

Figure 5 Model AC382~482MFAHA

- ③ Install wall mount rack according to figure below.



Model AC092~242MCAHA



- ④ Installing Drain Pipe

In case of model 22-140, fix drain pipes to drain holes on left and right sides (as shown in figure 4 and figure 5).

Install as follows (see figure below):

Plug drain pipe in water pan in the first place, as shown by figure, then, bind the two tight together and tie up junction area with heat insulant.

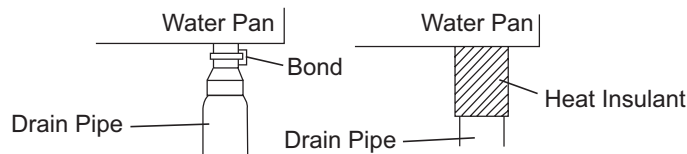

Installation Procedures

CAUTION: drain pipe leading-out direction shown with figure below.

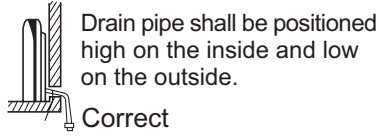

- Attention to distance from the unit to household usables or obstacles (as shown with figure).

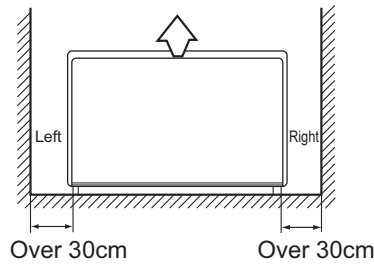

4. Ceiling Installation

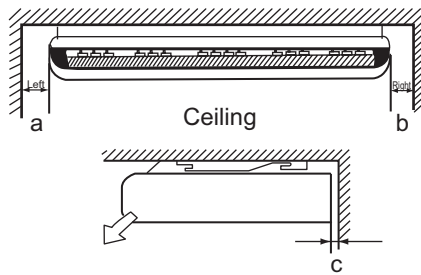

Model	a	b	c
AC092~242MCAHA	Over 30cm	Over 30cm	Over 2cm
AC382~482MFAHA	Over 80cm	Over 150cm	Over 10cm

Ceiling Installation

- ① Use $\varnothing 10$ hanger bolts, prepared on the site. Please refer to figure on the right when installing.

AC092~242MCAHA

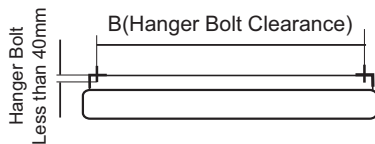

Hanger Bolt Mounting Position

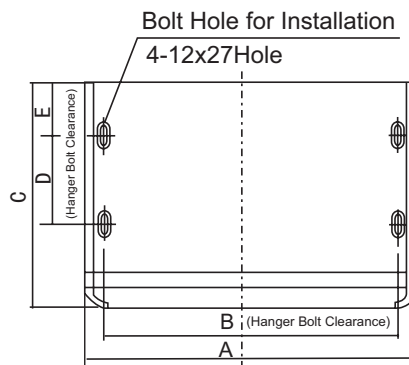

Model	A(mm)	B(mm)	C(mm)	D(mm)	E(mm)
AC092~242MCAHA	990	900	655	200	175

Installation Procedures

AC382~482MFAHA

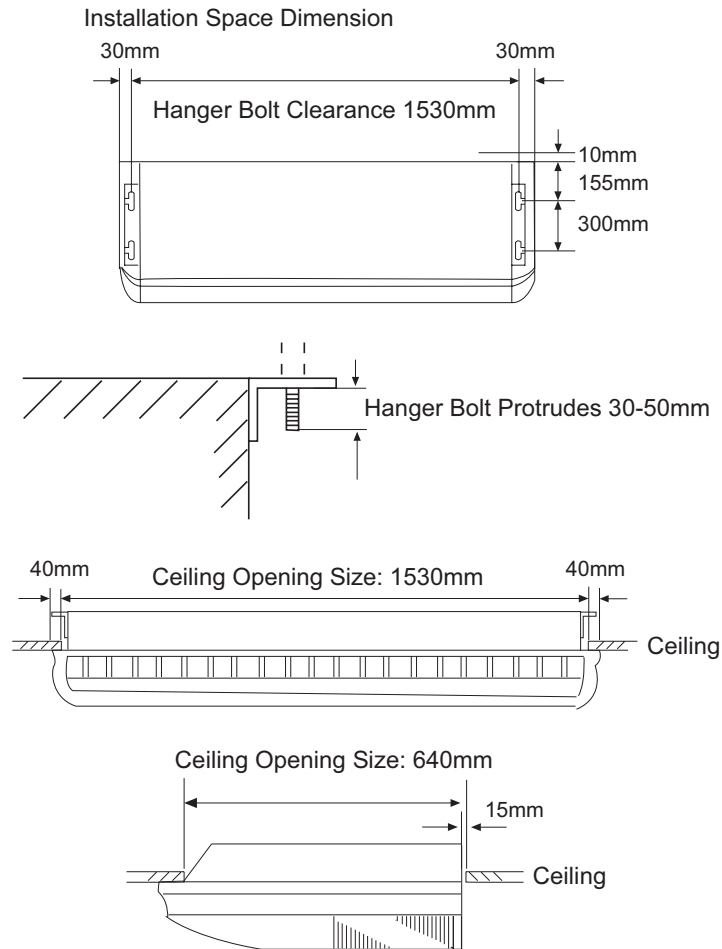

② Installing Hanger Bolt

Use M10 hanger bolt (prepared on the site) featuring 60mm hole depth, clearance fixed according to size proposed in the air conditioner external view; install according to different building structure specifications to guard against safety faults; and leveling instruments shall be available to ensure balanced installation.

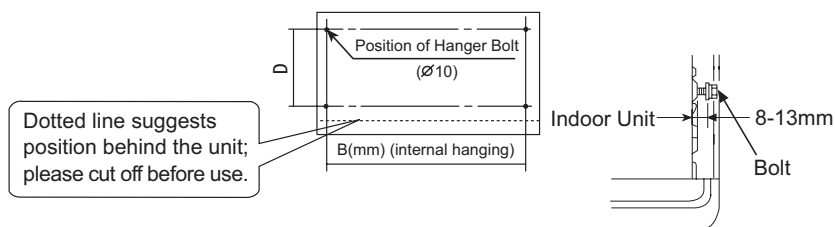

③ Please use hexagon bolts when installing

Installation Procedures

④ Air Conditioner Installation Diagram

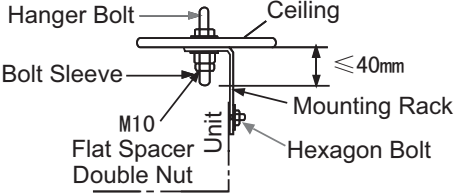
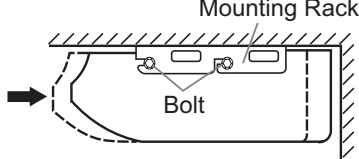
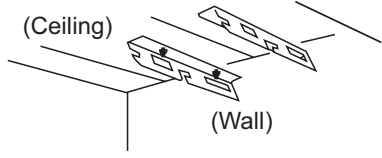
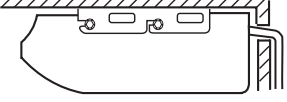
<p>① Hanger Chain Hook</p>	 <p>Hanger Bolt</p> <p>Ceiling</p> <p>Bolt Sleeve</p> <p>M10</p> <p>Flat Spacer Double Nut</p> <p>Unit</p> <p>Mounting Rack</p> <p>Hexagon Bolt</p> <p>≤40mm</p> <p>Hanger bolt is 40mm below ceiling.</p>	<p>③ Installing Air Conditioner</p>	 <p>Mounting Rack</p> <p>Bolt</p> <p>Insert hexagon bolt into slot</p> <p>Screw tight hexagon bolt to fix air conditioner</p>
<p>② Installing Status of Mounting Rack</p>	 <p>(Ceiling)</p> <p>(Wall)</p> <p>Leveling is forbidden after air conditioner is installed; please make adjustment according to diagram indication.</p>	<p>④ Drain Pipe Leading-out Direction</p>	 <p>CAUTION: drain pipe shall be positioned high inside and low outside.</p> <p>According to requirements on the site, drain pipes shall be prepared by users on their own resources and make sure that these are connected to drain pipes previously available with the unit (make sure that measures are taken to guard against water leakage in junction areas); heat preservation shall be available with certain indoor drain pipes through using heat insulant to prevent condensation.</p>

⑤ Installing Deco Plate and Inlet Grille (after pipeline laying and electric wiring are done).

Installation Procedures

⚠ Attention

- For normal drainage, the water drainage piping should be connected according to the installation manual. Heat insulation should be performed to avoid condensation. Improper pipe connection may cause water going into the machine.

Requirements:

- Heat insulating treatment should be made for the water drainpipes of the indoor units.
- Heat preservation should be made for the connection with the indoor units. Improper heat preservation may cause condensing.
- The drainpipe should be designed with a down gradient of 1/100. The midway of the elbow shouldn't be made in S shape. Or abnormal noise may be caused.
- The lateral length of the drainpipe should be kept within 20m. Under the condition of long pipe, a support should be provided every 1.52~2m to avoid unevenness.
- The central piping can be connected according the following figure.
- Don't apply external force to the connection of drainpipes.

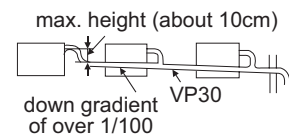
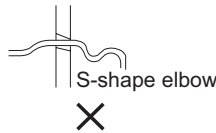
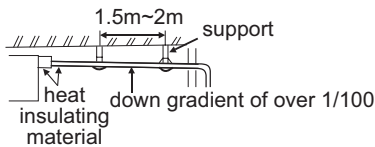

Piping Materials & Heat Insulating Materials

As to prevent condensation, heat insulating treatment should be performed. The heat insulating treatment for piping should be done respectively.

Piping Material	Hard PVC tube VP31.5mm (inner bore)
Heat Insulating Material	Vesicant polythene thickness: over 7mm

Hose

The drainage hose is made of \varnothing 19.05mm (3/4") PVC tube, which can adjust the eccentricity and the angle of the hard PVC tube.

- Stretch the hose directly to make connections as to avoid distortion. The soft end of the hose should be positioned with a clamp.
- The hose should be used in the horizon direction.

Heat Insulating Treatment:

- Wrap the connection between the clamp and the root segment of the indoor unit without any gap with heat insulating materials as shown in the drawing

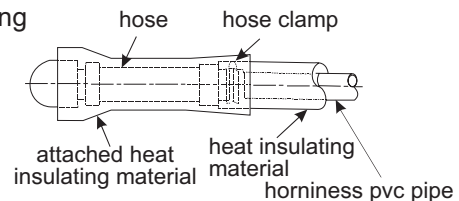

Confirming water drainage

During the test run, check the condition of water drainage and make sure that there is no leakage on the connection of piping, which should also be performed during the winter.

Installation Procedures

Tubing Permissible Length & Height Difference

Please refer to the attached manual of outdoor units.

Tubing Materials & Specifications

Model		AC092MCAHA	AC122~182MCAHA	AC242MCAHA AC382~482MFAHA
Tubing Size (mm)	Gas pipe	∅9.52	∅12.7	∅15.88
	Liquid pipe	∅6.35	∅6.35	∅9.52
Tubing Material		Phosphor deoxybronze seamless pipe (TP2) for air conditioner		

Refrigerant Filling Amount

Add the refrigerant according to the installation instruction of outdoor unit. The addition of R22 refrigerant must be performed with a measure gage to ensure the specified amount while compressor failure can be caused by filling too much or little refrigerant.

Connecting Procedures of Refrigerant Tubing

Proceed the flare tube connecting operation to connect all the refrigerant tubes.

- Dual wrenches must be used in the connection of indoor unit tubing.
- Mounting torque refers to the right table

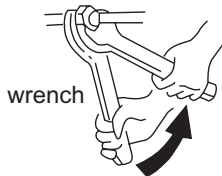

Outer Diameter of Tubing (mm)	Mounting Torque (N-m)	Increase mounting Torque (N-m)
∅6.35	11.8(1.2kgf-m)	13.7(1.4kgf-m)
∅9.52	24.5(2.5kgf-m)	29.4(3.0kgf-m)
∅12.7	49.0(5.0kgf-m)	53.9(5.5kgf-m)
∅15.88	78.4(8.0kgf-m)	98.0(10.0kgf-m)

Cutting and Enlarging

Cutting or enlarging pipes should be proceeded by installation personnel according to the operating criterion if the tube is too long or flare opening is broken.

Vacuumizing

Vacuumize from the stop valve of outdoor units with vacuum pump. Refrigerant sealed in indoor machine is not allowed to use for vacuumization.

Open All Valves

Open all the valves of outdoor units. [NB: oil balancing stop valve must be shut up completely when connected one main unit.]

Checkup for Air Leakage

Check if there is any leakage at the connecting part and bonnet with hydrophone or soapsuds.

Connecting

Connecting circular terminals:

1. Connecting circular terminals:
The connecting method of circular terminal is shown in the Fig. Take off the screw, connect it to the terminal tier after heading it through the ring at the end of the lead and then tighten it.

2. Connecting straight terminals:
The connection methods for the circular terminals are shown as follows: loosen the screw before putting the line terminal into the terminal tier, tighten the screw and confirm it has been clamped by pulling the line gently.

3. Pressing connecting line
After connecting line is completed, press the connecting line with clips which should press on the protective sleeve of the connecting line.

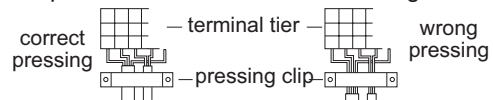

Installation Procedures

1. Remove the upper cover of wired controller.

(Do not damage the PC panel on the rear cover of line control when removing the upper cover).

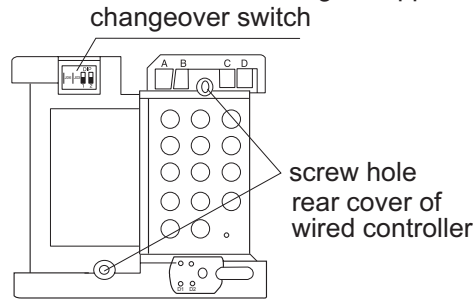
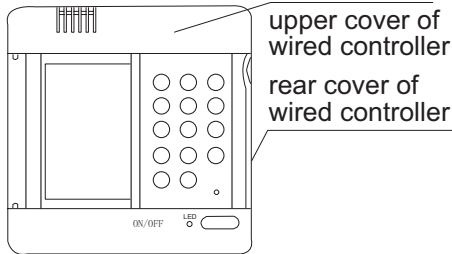

2. Install the wired controller.

Drill two holes on the wall according to the positions of two bolts on the rear cover of the line control, plug a peg into each hole, and fix the rear cover on the wall with the wood screws onto the holes.

Note:

Install the back cover of the wired controller on even wall surface and screw the wood bolt slightly in order not to damage the wired controller.

3. Changeover of the switch.

For details, please refer to the dialing code instruction of line control at page 32.

4. Wiring:

- One wired controller controls one indoor unit

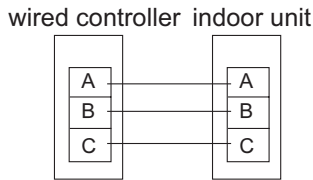

- Main & auxiliary wired controllers control one indoor unit

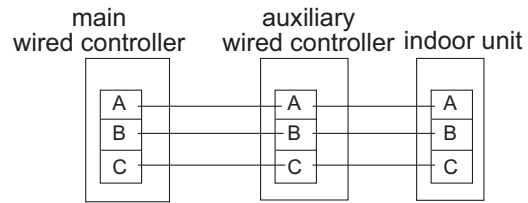

- One line controls multiple indoor units. Meanwhile, adjust the disc dialing code SW01 of indoor units (0 stands for the main unit, 1-15 stands for the other sub units in sequence)

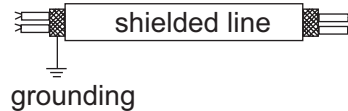
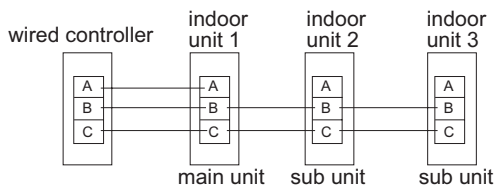



Note: Shielded lines must be used for the connection between indoor unit control panel and line control as well as the signal line connection between indoor units and outdoor units so that the shielded lays of signal lines of indoor & outdoor units are connected with each other and the shielded lay at the side of the signal line of outdoor unit are one-point grounded. Or disturbance will lead to abnormal operation of the machine. Make sure that the connection at terminals is so rigid as to avoid contacting the shielded lines.

5. Close the upper cover of line control without pressing the connection.

Note: 1. Electrical switches and signal lines are self-provided.
2. Don't touch the PC panel with your hands.

Electrical Wiring

⚠ Warning

- Electrical construction should be made with specific mains circuit by the qualified personnel according to the installation instruction. Electric shock and fire may be caused if the capacity of power supply is not sufficient. 
- During arranging the wiring layout, specified cables should be used as the mains line, which accords with the local regulations on wiring. Connecting and fastening should be performed reliably to avoid the external force of cables from transmitting to the terminals. Improper connection or fastness may lead to burning or fire accidents. 
- There must be the ground connection according to the criterion. Unreliable grounding may cause electrical shocks. Do not connect the grounding line to the gas pipe, water pipe, lightning rod and telephone line. 

⚠ Attention

- Only copper wire can be used. Breaker for electric leakage should be provided, or electric shock may occur.
- The wiring of the mains line is of Y type. The power plug L should be connected to the live wire and plug N connected to null wire while ⊕ should be connected to the ground wire. For the type with auxiliary electrically heating function, the live wire and the null wire should not be misconnected, or the surface of electrical heating body will be electrified. If the power line is damaged, replace it by the professional personnel of the manufacturer or service center.
- The power line of indoor units should be arranged according to the installation instruction of indoor units.
- The electrical wiring should be out of contact with the high-temperature sections of tubing as to avoid melting the insulating layer of cables, which may cause accidents.
- After connected to the terminal tier, the tubing should be curved into be a U-type elbow and fastened with the pressing clip. 
- Controller wiring and refrigerant tubing can be arranged and fixed together.
- The machine can't be powered on before electrical operation. Maintenance should be done while the power is shut down.
- Seal the thread hole with heat insulating materials to avoid condensation.
- Signal line and power line are separately independent, which can't share one line. [Note: the power line, signal line are provided by users. Parameters for power lines are shown as below: $3 \times (1.0-1.5) \text{ mm}^2$; parameters for signal line: $2 \times (0.75-1.25) \text{ mm}^2$ (shielded line)]
- 5 butt lines (1.5mm) are equipped in the machine before delivery, which are used in connection between the valve box and the electrical system of the machine. The detailed connection is displayed in the circuit diagram.

Supply Wiring Drawing

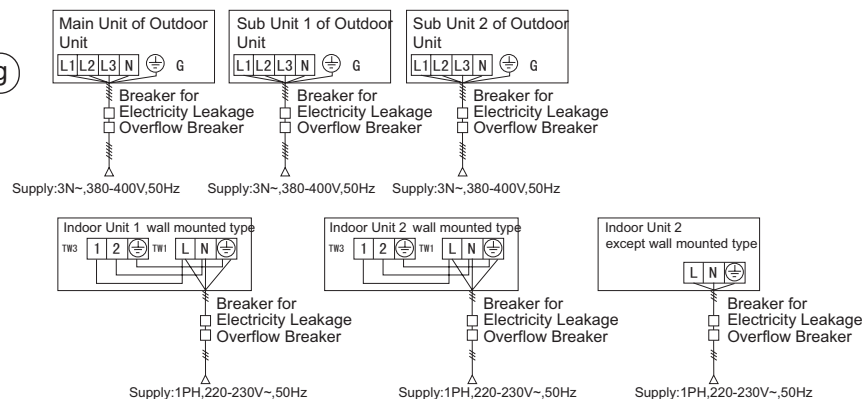

- Indoor units and outdoor units should be connected to the power source separately. Indoor units must share one single electrical source, but its capacity and specifications should be calculated. Indoor & outdoor units should be equipped with the power leakage breaker and the overflow breaker.

Electrical Wiring

Signal Wiring Drawing

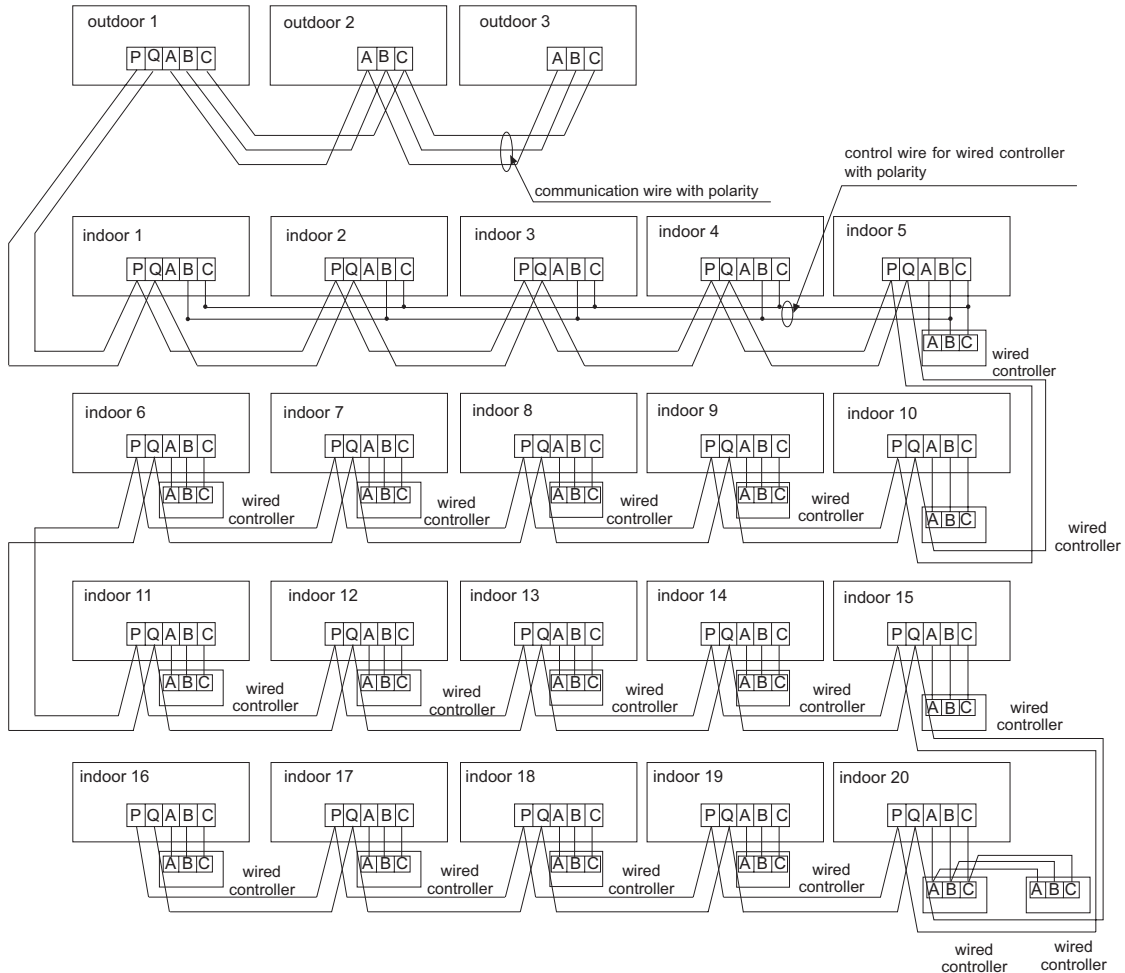

Outdoor units are of parallel connection via three lines with polarity. The main unit, central control and all indoor units are of parallel connection via two lines without polarity.

There are three connecting ways between line control and indoor units:

- One line control controls multiple units, i.e. 2-16 indoor units, as shown in the above figure, (1-5 indoor units). The indoor unit 5 is the line-controlled main unit and others are the line-controlled sub units. The remote control and the main unit (directly connected to the indoor unit of line control) are connected via three lines with polarity. Other indoor units and the main unit are connected via two lines with polarity. SW01 on the main unit of line control is set to 0 while SW01 on other sub units of line control are set to 1, 2, 3 and so on in turn. (Please refer to the code setting A at page 31)
- One line control controls one indoor unit, as shown in the above figure (indoor unit 6-19). The indoor unit and the line control are connected via three lines with polarity.
- Two line controls control one indoor unit, as shown in the figure (indoor unit 20). Either of the line controls can be set to be the master line control while the other is set to be the auxiliary line control. The master line control and indoor units, and the master and auxiliary line controls are connected via three lines with polarity.

When the indoor units are controlled by the remote control, switch over the modes by Switching Mode of Line-Controlled Main Unit/ Line-Controlled Sub Units/ Remote-Controlled Types. The signal terminals needn't to be equipped with wires and connected to the line control.

Electrical Wiring

The combination of multiple indoor units can be controlled by wired controller or remote controller.

※ Switching Mode of Line-Controlled Main Unit/ Line-Controlled Sub Units/ Remote-Controlled Types can be used for switching over ※

Control Mode Socket/Code	Line-Controlled Main Unit	Line-Controlled Sub Unit	Type Switching Mode of Remote Control
CN23	strapping	no strapping	no strapping
CN30	strapping	strapping	no strapping
CN21	null	null	connected to receiving plank of remote control
SW08-[6]	ON	ON	OFF
Signal Terminals	A,B,C are connected to wired controller	B,C are connected to wired controller	A,B,C are not connected to wired controller

Note:AC*AHA models are set to remote- controlled type before delivery

The wiring for the power line of indoor unit, the wiring between indoor and outdoor units as well as the wiring between indoor units:

Total Current of Indoor Units(A)	Items	Cross Section (mm ²)	Length (m)	Rated Current of Overflow Breaker(A)	Rated Current of Power Leakage Breaker (A) Leaking Current(mA) Operating Period (S)	Cross Sectional Area of Signal Line	
						Outdoor -indoor (mm ²)	Indoor -indoor (mm ²)
<10		2	20	20	20 A,30 mA,0.1S or below	2 cores×0.75-2.0 mm ² shielded line	
≥10 and <15		3.5	25	30	30 A,30 mA,0.1S or below		
≥15 and <22		5.5	30	40	40 A,30 mA,0.1S or below		
≥22 and <27		10	40	50	50 A,30 mA,0.1S or below		

- ※ The electrical power line and signal lines must be fastened tightly.
- ※ Every indoor unit must have the ground connection.
- ※ The power line should be enlarged if it exceeds the permissible length.
- ※ Shielded lays of all the indoor and outdoor units should be connected together, with the shielded lay at the side of signal lines of outdoor units grounded at one point.
- ※ It is not permissible if the whole length of signal line exceeds 1000m.

Signal Wiring of Wired controller

Length of Signal Line (m)	Wiring Dimensions	Length of Signal Line (m)	Wiring Dimensions
<100	0.3mm ² ×3 core shielding line	≥300 <400	1.25mm ² ×3 core shielding line
≥100 and <200	0.5mm ² ×3 core shielding line	≥400 <600	2mm ² ×3 core shielding line
≥200 and <300	0.75mm ² ×3 core shielding line		

- ※ The shielding lay of the signal line must be grounded at one end.
- ※ The total length of the signal line shall not be more than 600m.

Code Setting

- ※ The code is dialed to “ON” position with the overline at the state of strapping if the code or overline status is “1”; The code is dialed to “OFF” position with the overline at the state of disconnection if the code or overline status is “0”.
- ※ In the table below, the choice in the box “□” refers to the setting of the socket/overline before delivery.

Electrical Wiring

① Indoor Units PCB

A. With the indoor units controlled by the line control in groups, the address setting of indoor units: SW01 [1]-[4]

- ※ The setting of SW01 is performed by installation personnel during installation.
- ※ Switch SW01 of the matching indoor unit to “0” in one line control to one unit, double line controls to one unit and remote controlling conditions.

SW01				wired controller address
1	2	3	4	
0	0	0	0	0
0	0	0	1	1
0	0	1	0	2
0	0	1	1	3
0	1	0	0	4
0	1	0	1	5
-----				-----
1	1	0	0	12
1	1	0	1	13
1	1	1	0	14
1	1	1	1	15

Position of SW01 Main Unit	Position of SW01 Sub Unit
0	1-15 (The dialing codes of sub units in the same group should be different)

B. The central control address setting of indoor units: SW02

- ※ When controlled by line control in groups, the main unit needs to be set while it is unnecessary to set the sub units.
- ※ The setting of SW02 can be done by installation personnel during installation.

SW02								Switching Description
[1]	[2]	[3]	[4]	[5]	[6]	[7]	[8]	
--	0	0	0	0	0	0	0	Central control address = 1
--	0	0	0	0	0	0	1	Central control address = 2
-----								-----
--	1	1	1	1	1	1	0	Central control address = 127
--	1	1	1	1	1	1	1	Central control address = 128
0								Allowed wire controller address setting
1								Forbidden wire controller address setting

C. Communication Address Setting between Indoor Units and Outdoor Units: SW03

- ※ The setting of SW03 can be done by installation personnel during installation.

SW03								Switching Description
[1]	[2]	[3]	[4]	[5]	[6]	[7]	[8]	
—	—	0	0	0	0	0	0	Communication address of indoor units = 1
—	—	0	0	0	0	0	1	Communication address of indoor units = 2
-----								-----
—	—	1	1	1	1	1	0	Communication address of indoor units = 63
—	—	1	1	1	1	1	1	Communication address of indoor units = 64
—	0							Allowed wire controller address setting
—	1							Forbidden wire controller address setting
0								Automatic address setting
1								Manual address setting

- There are 1 ways of setting communication addresses between indoor units and outdoor units:

A. Manual: first, set SW03-[1] to “1”, and then set SW03-[8]-[3] according to requirements.
 B. Take one of the three ways while only one way is valid at the same time. The highest priority level is the Line Control way.

C. Line/Remote Control Option: set SW08-[6].

- ※ The setting of SW08-[6] can be done by installation personnel during installation.

Status of SW08-[5]	Controlling Method
ON	Room card available
OFF	unavailable

Electrical Wiring

Status of SW08-[6]	Controlling Method
<input type="checkbox"/> ON	Wired control(include one control to multiple units, two controls to one unit and one control to one unit)
<input type="checkbox"/> OFF	Remote control

② Wired Controller Code Settings

Serial No.	Type	Switch Status	Switchover Function
J03	Choice of room temp. indications	0	There is no indication for room temperature
		<input type="checkbox"/> 1	Automatic reset after power failure
SW01-[1]	Switchover of main & auxiliary wired controllers	<input type="checkbox"/> ON	Set to auxiliary wired controller
		<input type="checkbox"/> OFF	Set to main wired controller
SW01-[2]	Switchover of Centigrade & Fahrenheit	<input type="checkbox"/> ON	Indicating Fahrenheit
		<input type="checkbox"/> OFF	Indicating Centigrade
D1	Schedule compression function	<input type="checkbox"/> ON	Indoor units perform schedule compression
		<input type="checkbox"/> OFF	Normal control
D2	Compulsive defrosting	<input type="checkbox"/> ON	Sending "Compulsive Defrosting" signal to indoor units
		<input type="checkbox"/> OFF	Normal control

- D1 and D2 are diodes. Turn to "OFF" to disconnect holes of both sides while turn to "ON" to strap the holes of two sides with a guide line.
- The code/ overline/ diode in the gray frame indicates that safety operation can be done by opening the shell of remote control.
- Only when dual line controls control one indoor unit can one of the line control be set to auxiliary line control by setting SW01-[1] to "ON" while keeping the settings of others "OFF".

Difference between Main Wired Controller and Auxiliary Wired Controller

Comparison Items	Main wired controller	Auxiliary wired controller
Functions	All functions	It can only set shutdown, mode, air quantity, temperature and swinging.

Functions of Wired Controller

Operation of Wired/Remote Controllers

- ① Initialization process of line control:
During the initialization of line control after powered on, [8888]→[888]→[88]→[8] for the wired controllers and LED flash for about 30 seconds. At this time, all buttons are disabled.
- ② Descriptions of other components and operating methods refer to the related operating guide.
- ③ Special functions of wired control:
 - A Setting of central control address of indoor units:
When indoor unit code setting allows line control to set the address, continually press “Resetting Filtering Screen” for 10 seconds to enter into the mode of setting the central control addresses, and select the unit No. of the group by “Time +/-” button.
Indication of temperature displays:
[Central Control Address]+XX: Press “Temp. +/-” button. XX ranges from 0-7F with the initial value of 00. After finishing the setting, press “Setting” button to save the setting and quit. By pressing other buttons or without pressing within 15 seconds, it will automatically quit and keep the last setting.
 - B Setting of communication address between indoor units and outdoor units:
When indoor unit code setting allows line control to set the address, continually press “Resetting Filtering Screen” for 5 seconds to enter into the mode of setting the communication addresses, and select the unit No. of the group by “Time +/-” button.
Indication of temperature displays:
[System Address]+XX: Press “Temp. +/-” button. XX ranges from 0-3F with the initial value of 00. After finishing the setting, press “Setting” button to save the setting and quit. By pressing other buttons or without pressing within 15 seconds, it will automatically quit and keep the last setting.
 - C Inquiry of fault records of indoor units:
In the state of startup or shutdown, press “CHECK” button to go into the mode of inquiring faults of all indoor units in this group. The temperature zone indicates “CHECK” and “Unit No.,” which shows the unit number with the actual connection in sequence in the decimal system. Meanwhile, the time zone indicates the code of the current fault and the previous fault of the responding machine in the format of [XX:YY], in which, XX refers to the code of the current fault (if normal, it shows “- -”) and YY refers to the code of the previous fault. The indication of fault code of each machine lasts 3 seconds. After the indication of the whole group, it automatically quit.
Removing abnormal states & clearing fault records:
 - D Under normal conditions, continually press “CHECK” button for 5 seconds to clear fault records. Inquiring running state of indoor units of the group:
 - E Under normal condition, press “Setting” button for 5 seconds until the temperature zone on the liquid crystal screen shows [XX], referring to the unit number of indoor units and select unit, and select unit number by “Temp. +/-” button. The time zone displays [YZZZ], in which, Y refers to the data type and ZZZ to the responding data. Select the data type by “Time +/-” button.

Y	ZZZ	System
A	Temperature of indoor unit transducer TA	Actual value, decimal system
B	Temperature of indoor unit transducer TC1	Actual value, decimal system
C	Temperature of indoor unit transducer TC2	Actual value, decimal system
D	PMV step of indoor units	Actual value/2. decimal system(e.g. indication of 50 with actual step of 100)
E	Communication address between indoor/outdoor units	Actual value, sexadecimal system
F	Central address	Actual value, sexadecimal system

Under the inquiring state, press “CHECK” button to quit the inquiring state and return to the normal operating state.

Test Run & Fault Code

Before Test Run

- Before switching it on, test the supply terminal tier (L, N terminals) and grounding points with 500V megaohm meter and check if the resistance is above $1M\Omega$. It can't be operated if it is below $1M\Omega$.
- Connect it to the power supply of outdoor units to energize the heating belt of the compressor. To protect the compressor at startup, power it on 12 hours prior to the operation.

Check if the arrangements of the drainpipe and connection line are correct.

The drainpipe shall be placed at the lower part while the connection line placed at the upper part. Heat preservation measures should be taken such as winding the drainpipe esp. in the indoor units with heating insulating materials.

The drain pipe should be made a slope type to avoid protruding at the upper part and concaving at the lower part on the way.

Checkup of Installation

- check if the mains voltage is matching
- check if there is air leakage at the piping joints
- check if the connections of mains power and indoor & outdoor units are correct
- check if the serial numbers of terminals are matching
- check if the installation place meets the requirement
- check if there is too much noise
- check if the connecting line is fastened
- check if the connectors for tubing are heat insulated
- check if the water is drained to the outside
- check if the indoor units are positioned

Ways of Test Run

Do ask the installation personnel to make a test run. Take the testing procedures according to the manual and check if the temperature regulator works properly.

When the machine fails to start due to the room temperature, the following procedures can be taken to do the compulsive running. The function is not provided for the type with remote control.

- Set the wired controller to refrigerating/heating mode, press "ON/OFF" button for 5 seconds to enter into the compulsive refrigerating/heating mode. Re-press "ON/OFF" button to quit the compulsive running and stop the operation of the air conditioner.

Test Run & Fault Code

Fault Remedies

When any fault appears, refer to "Inquiry of fault records of indoor units" at page33, consult the fault code of line control or the flashing times for LED5 of computer panel of indoor units/health lamp of receiving window of remote control and find out the faults as shown in the following table to remove all faults.

Indoor Unit Faults

Wired Controller Fault Code	PCB LED5(Indoor Units)/ Receiving Window Health Lamp(Remote Controller)	Fault Descriptions
01	1	Fault of indoor unit ambient temp. transducer TA
02	2	Fault of indoor unit pipe temp. transducer TC1
03	3	Fault of indoor unit pipe temp. transducer TC2
04	4	Fault of indoor unit dual heat source temp. transducer
05	5	Fault of indoor unit EEPROM
06	6	Fault of communication between indoor & outdoor units
07	7	Fault of communication between indoor unit and wired control
08	8	Fault of indoor unit water drainage
09	9	Fault of duplicate indoor unit address
0A	10	Fault of duplicate central control address
Outdoor Unit Code	20	Corresponding faults of outdoor units

HAIER GROUP

Qingdao Haier Air Conditioner Electric Co., Ltd.

Address: Haier Garden ,Qianwangang Road , Economic Development Zone,
Qingdao ,Shandong 266500, P.R.China

Web Site: <http://www.haier.com>