

DUCT TYPE AIR CONDITIONER

Indoor Unit Operation & Installation

Manual

HDU-18CF03

HDU-18HF03

HDU-28CF03

HDU-28HF03

No. 0010576844A

- Please read this operation manual before using the air conditioner.
- Please keep this manual carefully and safely.

Table of Contents

Cautions	2
Safety Precautions	3-5
Parts and Functions	6-8
Operation	9-14
Malfunction	15-17
Care and Maintenance	18
For Preparation of Heating	19
Is The Unit Installed Correctly	20
Installation Manual For Wire Controller	21-22
Installation Manual For Indoor Unit	23-32

■ Cautions

Disposal of the old air conditioner

Before disposing an old air conditioner that goes out of use, please make sure it's inoperative and safe. Unplug the air conditioner in order to avoid the risk of child entrapment.

It must be noticed that air conditioner system contains refrigerants, which require specialized waste disposal. The valuable materials contained in a air conditioner can be recycled. Contact your local waste disposal center for proper disposal of an old air conditioner and contact your local authority or your dealer if you have any question. Please ensure that the pipework of your air conditioner does not get damaged prior to being picked up by the relevant waste disposal center, and contribute to environmental awareness by insisting on an appropriate, anti-pollution method of disposal.

Disposal of the packaging of your new air conditioner

All the packaging materials employed in the package of your new air conditioner may be disposed without any danger to the environment.

The cardboard box may be broken or cut into smaller pieces and given to a waste paper disposal service. The wrapping bag made of polyethylene and the polyethylene foam pads contain no fluorochloric hydrocarbon.

All these valuable materials may be taken to a waste collecting center and used again after adequate recycling.

Consult your local authorities for the name and address of the waste materials collecting centers and waste paper disposal services nearest to your house.

Safety Instructions and Warnings

Before starting the air conditioner, read the information given in the User's Guide carefully. The User's Guide contains very



important observations relating to the assembly, operation and maintenance of the air conditioner.

The manufacturer does not accept responsibility for any damages that may arise due to non-observation of the following instruction.

- Damaged air conditioners are not to be put into operation. In case of doubt, consult your supplier.
- Use of the air conditioner is to be carried out in strict compliance with the relative instructions set forth in the User's Guide.
- Installation shall be done by professional people, don't install unit by yourself.
- For the purpose of safety, the air conditioner must be properly grounded in accordance with specifications.
- Always remember to unplug the air conditioner before opening inlet grill. Never unplug your air conditioner by pulling on the power cord. Always grip plug firmly and pull straight out from the outlet.
- All electrical repairs must be carried out by qualified electricians. Inadequate repairs may result in a major source of danger for the user of the air conditioner.
- Do not damage any parts of the air conditioner that carry refrigerant by piercing or perforating the air conditioner's tubes with sharp or pointed items, crushing or twisting any tubes, or scraping the coatings off the surfaces. If the refrigerant spurts out and gets into eyes, it may result in serious eye injuries.
- Do not obstruct or cover the ventilation grille of the air conditioner. Do not put fingers or any other things into the inlet/outlet and swing louver.
- Do not allow children to play with the air conditioner. In no case should children be allowed to sit on the outdoor unit.

■ Safety Precautions



- Before starting to use the system, read carefully this "SAFETY PRECAUTIONS" to ensure a proper operation of the system.
- Safety precautions described here are classified to "⚠ WARNING" and "⚡ CAUTION". Precautions which are shown in the column of "⚠ WARNING" means that an improper handling could lead to a grave result like a death, serious injury, etc. However, even if precautions are shown in the column of "⚡ CAUTION", a very serious problem could occur depending on situation. Make sure to observe these safety precautions faithfully because they are very important information to ensure the safety.
- Symbols which appear frequently in the text have following meanings.

	Strictly prohibited.		Observe instructions faithfully.		Provide a positive grounding.
---	----------------------	---	----------------------------------	---	-------------------------------









- When you have read through the manual, keep it always at hand for read consultation. If the operator is replaced, make sure to hand over this manual to the new operator.

■ CAUTIONS FOR INSTALLATION

⚠ WARNING

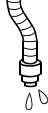



<p>The system should be applied to places as office, restaurant, residence and the like.</p>  <p>Application to inferior environment such as an engineering shop, could cause equipment malfunction and serious injury or death.</p>	<p>The system should be installed by your dealer or a professional installer.</p>  <p>Installation by yourself is not encouraged because it could cause such problems as water leakage, electrical shock or fire accident by some improper handling.</p>	<p>When you need some optional devices such as a humidifier, electric heater, etc., be sure to use the products which are recommended by us. These devices should be attached by a professional installer.</p>  <p>Installation by yourself is not encouraged because it could cause such problems as water leakage, electrical shock or fire accident by some improper handling.</p>
---	---	--

⚡ CAUTION



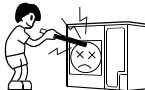

<p>Do not install nearby the place where may have leakage of flammable gas.</p>   <p>If the gas leaks and gathers around, it may cause the fire.</p>	<p>Depending on the place of installation, a circuit breaker may be necessary.</p>   <p>Unless the circuit breaker is installed, it could cause electrical shocks.</p>	<p>Drain pipe should be arranged to provide a positive draining.</p>   <p>If the pipe is arranged improperly, furniture or the likes may be damaged by leaked water.</p>
<p>Where strong winds may prevail, the system should be fixed securely to prevent a collapse.</p>  <p>Bodily injury could result by a collapse.</p>	<p>Install on the place where can endure the weight of air conditioner.</p>  <p>Bodily injury could result by a careless installation.</p>	<p>Make sure the system is grounded.</p>   <p>Grounding cable should never be connected to a gas pipe, city water pipe, lightning conductor rod or grounding cable of telephone. If the grounding cable is not set properly, it could cause electric shocks.</p>

■ CAUTIONS FOR OPERATION

⚠ WARNING

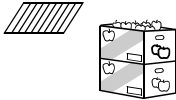
<p>You should refrain from exposing your body directly to cool wind for a long time.</p>   <p>It could affect your physical condition or cause some health problems.</p>	<p>Do not poke the air inlet or outlet with a bar, etc.</p>   <p>Since the internal fan is operating with a high speed, it could cause an injury.</p>	<p>When any abnormal condition (scorching smell or others) is found, stop the operation immediately and turn off the power switch. Then consult your dealer.</p>   <p>If you continue the operation without removing the cause, it could result in a trouble, electric shock or fire.</p>
--	---	---

⚡ CAUTION

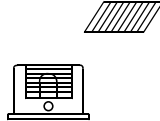
<p>The system should never be used for any other purposes than intended such as for preservation of food, flora and fauna, precision deices or work of art.</p>   <p>It could cause deterioration of food or other problems.</p>	<p>Do not handle switches with a wet hand.</p>   <p>It could cause electric shocks.</p>	<p>Combustion apparatus should not be placed allowing a direct exposure to wind of air conditioner.</p>   <p>Incomplete combustion could occur on the apparatus.</p>
--	---	--

■ Safety Precautions

⚠ CAUTION

Do not wash the air conditioner with water.



It could cause electric shocks.

Do not install the system where the air outlet reaches directly the flora and fauna.

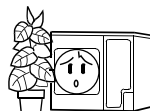

It will not be good for their health.

Make sure to use a fuse of proper electric rating.



Use of steel or copper wire in place of a fuse is strictly prohibited because it could result in a trouble or fire accident.

Neither stand on the air conditioner nor place something on it.

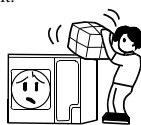

There are risks of falling or injury by collapsed object.

It is strictly prohibited to place a container of combustible gas or liquid near the air conditioner or to spray it directly with the gas or liquid.



It could cause a fire accident.

Do not operate the system while the air outlet grill is removed.

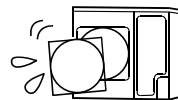

There is a risk of injury.

Do not use the power switch to turn on or off the system.

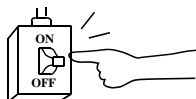

It could cause a fire or water leakage.

Do not touch the air outlet section while the swing louver is operating.



There is a risk of injury.

Do not use such equipment as a water heater, etc. around the indoor unit or the wire controller.



If the system is operated at the vicinity of such equipment which generates steam, condensed water may drip during cooling operation or it could cause a fault current or short-circuit.

When operating the system simultaneously with a combustion apparatus, indoor air must be ventilated frequently.



Insufficient ventilation could cause an oxygen deficiency accident.

Check occasionally the support structure of the unit for any damage after a use of long period of time.



If the structure is not repaired immediately, the unit could topple down to cause a personal injury.

When cleaning the system, stop the operation and turn off the power switch.



Cleaning should never be done while the internal fans are running with high speed.

Do not put water containers on the unit such as a flower vase, etc.



If the structure is not repaired immediately, the unit could topple down to cause a personal injury.

■ CAUTIONS FOR TRANSFER OR REPAIR

⚠ WARNING

Modification of the system is strictly prohibited. When the system needs a repair, consult your dealer.



Improper practice of repair could cause water leakage, electric shock or fire.

When the air conditioner is relocated, contact your dealer or a professional installer.



Improper practice of installation could cause water leakage, electric shock or fire.

■ Safety Precautions

The machine is adaptive in following situation

1. Applicable ambient temperature range:

			Rated	Maximum	Minimum
Cooling	Indoor	DB °C	27	32	18
		WB °C	19	23	14
	outdoor	DB °C	35	43	10
		WB °C	24	26	6
Heating	Indoor	DB °C	20	27	15
		WB °C	14.5	--	--
	outdoor	DB °C	7	24	-7
		WB °C	6	18	--

- If the supply cord is damaged, it must be replaced by the manufacturer or its service agent or a similar qualified person.
- If the fuse on PC board is broken please change it with the type of T 3.15A /250V.
- The wiring method should be in line with the local wiring standard.
- The power cable and connecting cable are self-provided. The power cable should be H07RN-F 3G 2.5mm² (For HDU-18CF03, HDU-18HF03), H07RN-F 3G 4.0mm² (For HDU-28CF03,HDU-28HF03).The connecting cable should be H05RN-F 0.75mm²x2+2.0mm²x3 (For HDU-18HF03), H05RN-F 2.0mm²x3 (For HDU-18CF03), and H05RN-F : 0.75mm²x6 (For HDU-28HF03); H05RN-F 0.75mm²x4 (For HDU-28CF03). During installation, when the connecting cables break off, it must be assured that the grounding wire is the last one to be broken off.
- The breaker of the air conditioner should be all-pole switch; and the distance between its two contacts should be no less 3mm.
- The indoor unit installation height is at least 2.5m.

■ Parts and Functions

Indoor unit

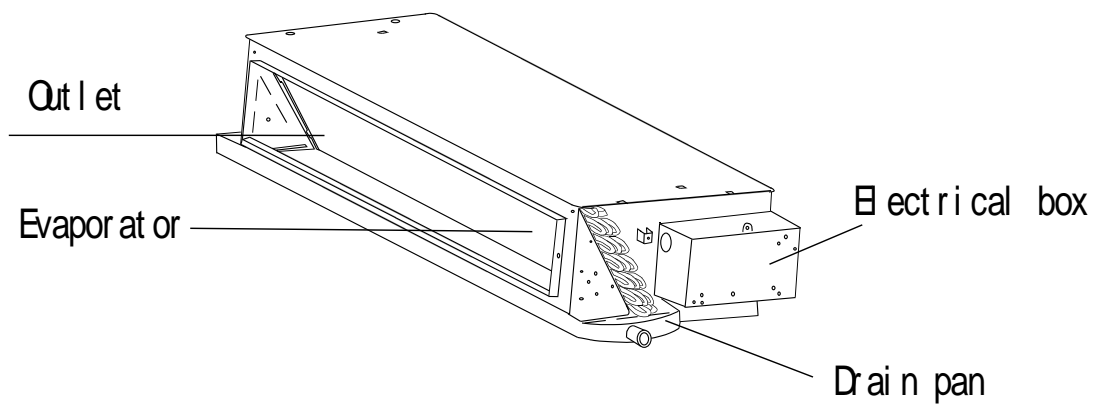

Wire controller

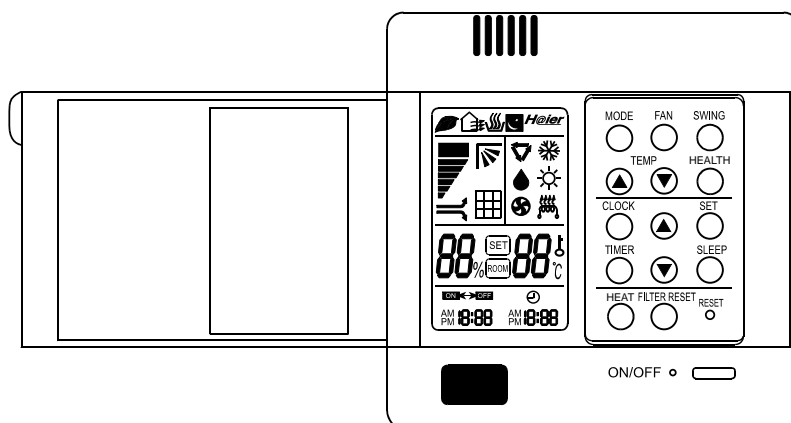

■ Parts and Functions

Operation

Buttons and display of the wire controller.

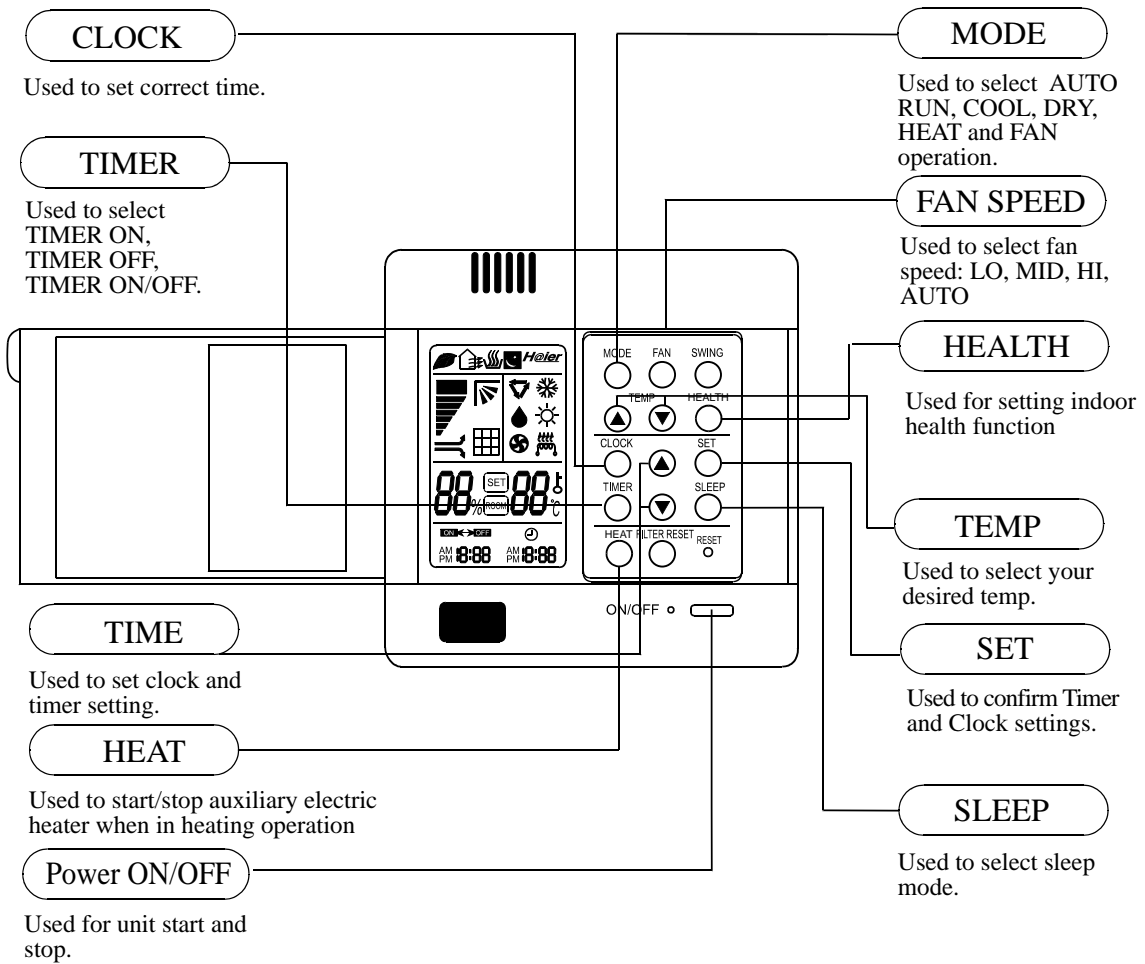

Cautions:
On cooling only unit, heating mode is not available; For this unit the "HEALTH" function is not available.

Note:
The above information is the explanation of the displayed information therefore varies with those displayed in actual operation.

■ Parts and Functions

Operation

Buttons and display of the wire controller.

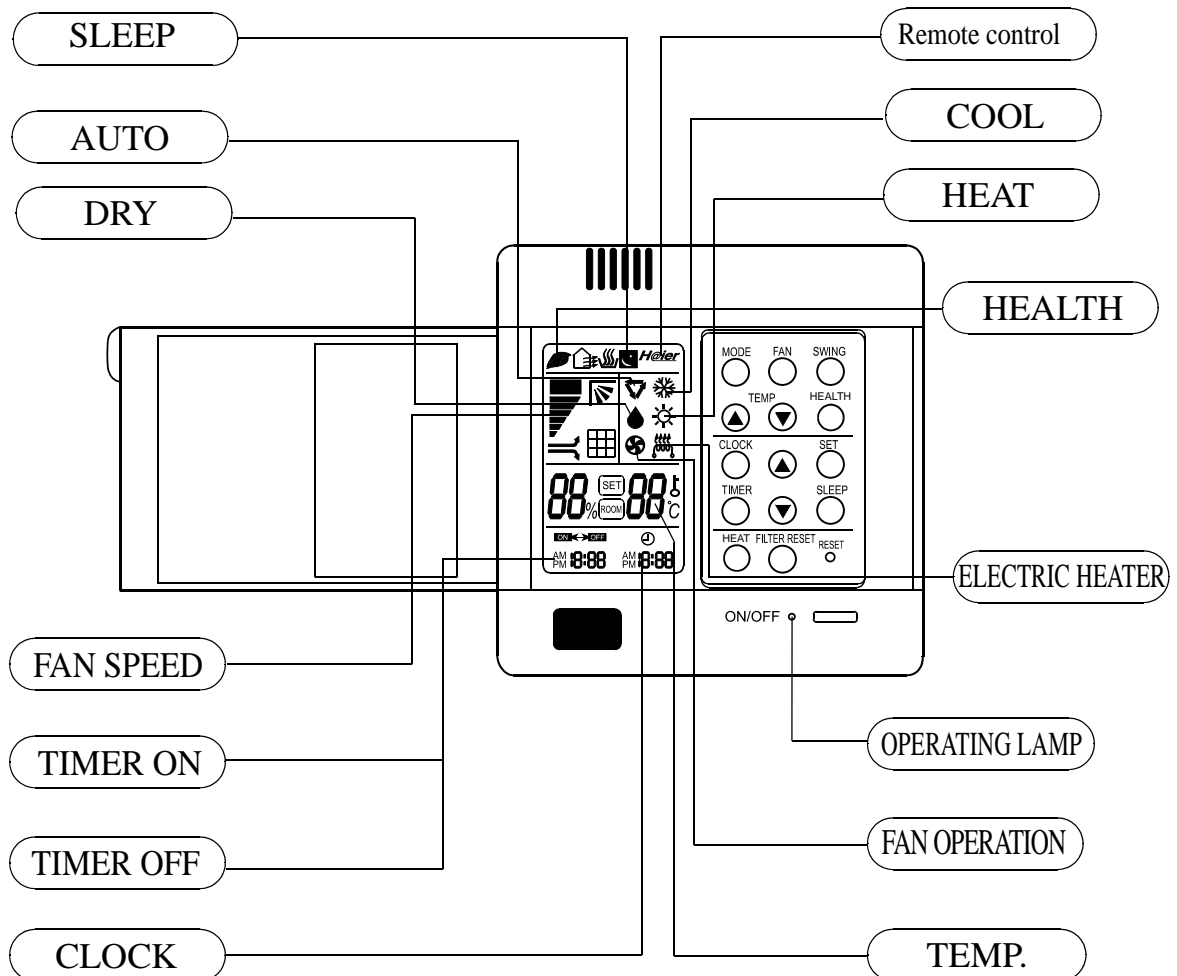

Clock set

When unit is started for the first time, clock should be adjusted as follows:

- Press CLOCK button, "AM" or "PM" flashes.
- Press ▲ or ▼ to set correct time. Each press will increase or decrease 1min. If the button is kept depressed, time will change quickly.
- After time setting is confirmed, press SET, "AM" and "PM" stop flashing, while clock starts working.

■ Operation

The air conditioner has the function of **POWER FAILURE RESUME**.

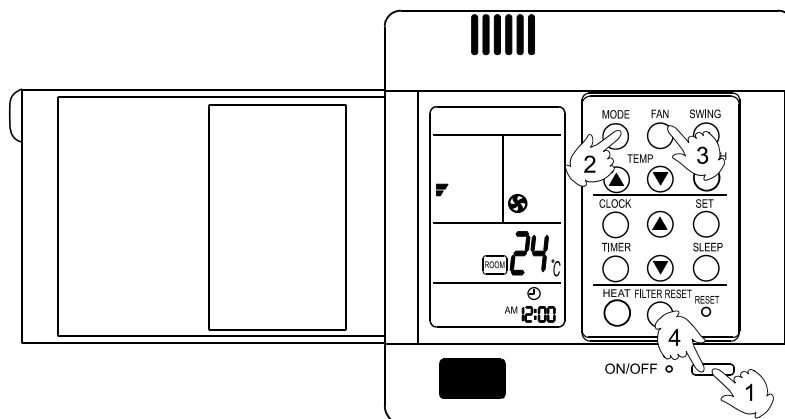

Fan operation

Enjoy yourself by just a gentle press.

(1) Unit start

Press ON/OFF button, unit starts.
 Previous operation status appears on display.
 (Not Timer setting)
 Power indicator lights up.

(2) Select operation mode

Press MODE button. For each press, operation mode changes as follows:

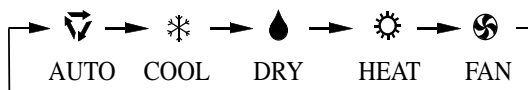

Unit will run in selected mode.
 stop display at " FAN ".

For cooling only type no " HEAT " function.

(3) Fan

Press FAN button. For each press, fan speed changes as follows:



Unit will run at selected fan speed.

(4) Unit stop

Press ON/OFF button.
 Only time and room temp remains on LCD.
 All indicators go out.
 Vertical flap closed automatically.

Hints

Wire controller can memorize settings in each operation mode. To run it next time just select the operation mode and it will start with the previous setting.
 No reselecting is needed.(TIMER ON/OFF needs reselecting)
 In FAN mode, temp. can't be set.

■ Operation

AUTO RUN, COOL, HEAT and DRY operation

Recommendations

- Use COOL in summer.
- Use HEAT in winter.
- Use DRY in spring, autumn and in damp climate.

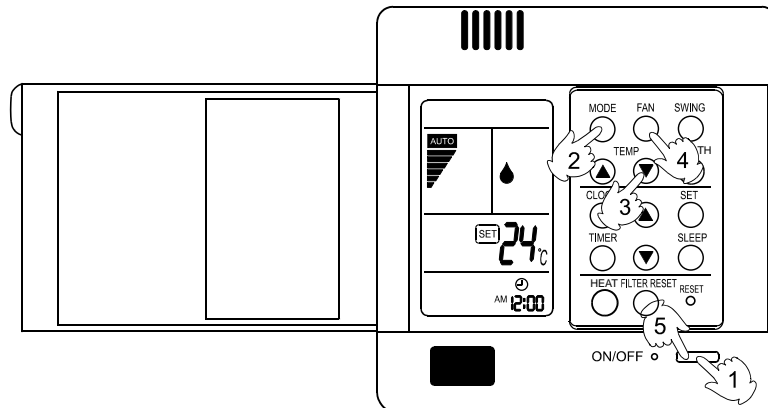

(1) Unit start

Press ON/OFF button, unit starts.
Previous operation status appears on display
(Not Timer setting). Power indicator lights up.

(2) Select operation mode

Press MODE button. For each press, operation mode changes as follows:

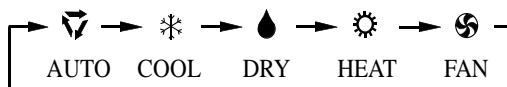

Unit will run in operation mode displayed on LCD.
Stop display at your desired mode.

(3) Select temp. setting

Press TEMP button

- ▲ Every time the button is pressed, temp. setting increases 1°C.
If button is kept depressed, temp. setting will increase quickly.
- ▼ Every time the button is pressed, temp. setting decreases 1°C.
If button is kept depressed, temp. setting will decrease quickly.

Unit will start running to reach the temp. setting on LCD.

(4) Fan speed selection

Press FAN button. For each press, fan speed changes as follows:

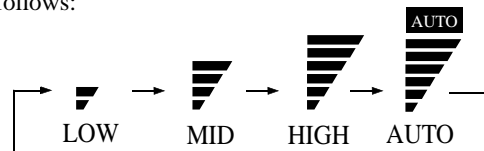

Unit runs at the speed displayed on LCD.

In HEAT mode, warm air will blow out after a short period of time due to cold-draft prevention function.
In DRY mode, when room temp. becomes 2°C higher than temp. setting, unit will run intermittently at LOW speed regardless of FAN setting.

(5) Unit stop

Press ON/OFF button.
Only time and room temp remains on LCD.
All indicators go out.
Vertical flap closes automatically.

Hints

Wire controller can memorize each operation status. When starting it next time, just press ON/OFF button and unit will run in previous status.

■ Operation

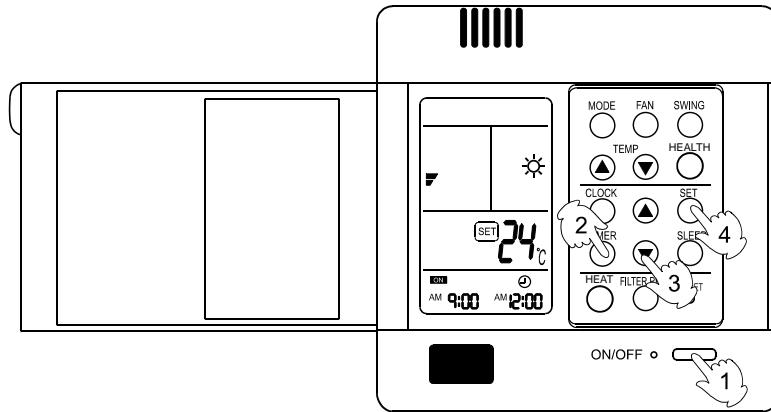

TIMER operation

Set Clock correctly before starting Timer operation.

You can let unit start or stop automatically at following time: Before you wake up in the morning, or get back from outside or after you fall asleep at night.

TIMER ON/OFF

(1) After unit start, select your desired operation mode.

Operation mode will be displayed on LCD.
Power indicator lights up.

(2) TIMER mode selection

Press TIMER button to change TIMER mode.
Every time the button is pressed, display changes as follows:

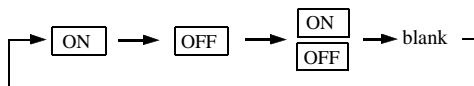

Select your desired TIMER mode (ON or OFF)

(3) Timer setting

Press TIME ▲ / ▼ button.

- ▲ Every time the button is pressed, time increases 10min.
If button is kept depressed, time will change quickly.
- ▼ Every time the button is pressed, time decreases 10min.
If button is kept depressed, time will change quickly.
Time will be shown on LCD. It can be adjusted within 24hours.

(4) Confirming your setting

After setting correct time, press SET button to confirm "ON" or "OFF" stops flashing.

Time displayed: Unit starts or stops at x hour x min (ON or OFF).

Timer mode indicator lights up.

To cancel TIMER mode

Just press TIMER button several times until TIMER mode disappears.

Hints

Wire controller possesses memory function, when use TIMER mode next time, just press SET button after mode selecting if timer setting is the same as previous one.

■ Operation

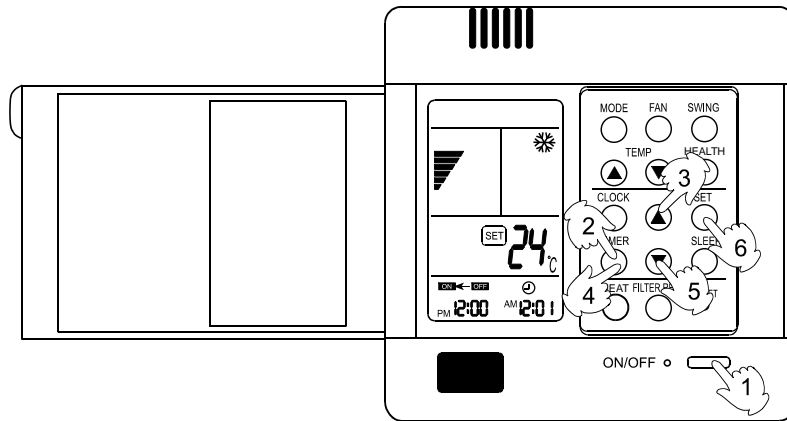

TIMER ON-OFF

(1) After unit start, select your desired operation mode

Operation mode will be displayed on LCD.
Power indicator lights up.

(2) Press TIMER button to change TIMER mode

Every time the button is pressed, display changes as follows:



Select ON/OFF.

(3) Time setting for TIMER ON

Press TIME button.

▲ Every time the button is pressed, time increases 10min.

If button is kept depressed, time will change quickly.

▼ Every time the button is pressed, time decreases 10min.

If button is kept depressed, time will change quickly.

Time will be shown on LCD.

It can be adjusted within 24hours.

AM refers to morning and PM to afternoon.

(4) Time confirming for TIMER ON

After time setting, press TIMER button to confirm.
"ON" stops blinking, While "OFF" starts blinking.

Time displayed: Unit starts at Xhour X min.

(5) Time setting for TIMER OFF

Follow the same procedures in "Time setting for TIMER ON".

(6) Time confirming for TIMER OFF

After time setting, press SET button to confirm
"OFF" stops flashing.

Time displayed: Unit stops at X hour X min.

To cancel TIMER mode

■ Just press TIMER button several times until TIMER mode disappears.

■ According to the Time setting sequence of TIMER ON or TIMER OFF, either Start-Stop or Stop-Start can be achieved.

■ Operation

Comfortable Sleep

At night, before going to bed you can press down the SLEEP button on the controller and the air-conditioner will run by the comfortable sleeping mode to make you sleep more comfortable.

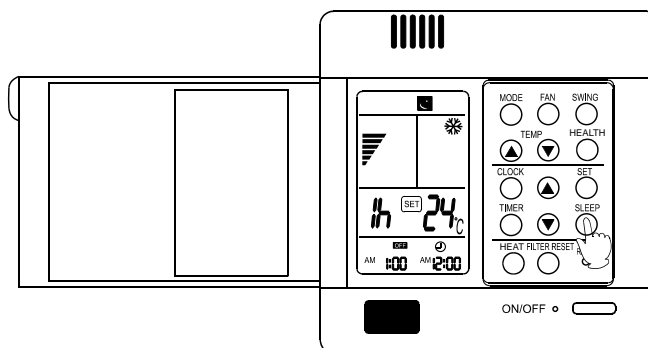

Press SLEEP button once to make the air conditioner have the previous-set sleep time (first power-on is "1h"), the sleep symbol will appear. Press time button ▲/▼, you can choose the time in 1~8 hours. Each press of▲/▼, the time increases/reduces 1 hour and "xh" appears in the humidity setting part, "OFF" appears in "TIMER OFF" display part and timer-off time; press SLEEP button again to cancel sleep function, the sleep symbol disappears.

In cooling, dehumidifying mode

One hour after sleeping operation start, the temp. is 1°C higher than the setting one. After another hour the temp. rises 1°C and then run continuously for another 6hrs' and then close. The actual temp. is higher than the setting one which is to prevent from being too cool to your sleep.

In heating mode

One hour after start up, the temp. decrease 2°C lower than the setting one. After another hour decrease by more 2°C.

The temperature will automatically rise by 1°C after another 3hrs' operation, and then automatically close after 3hrs' continuous operation. The actual temperature is lower than the setting one which is to prevent from being too hot to your sleep.

Note:

- In AUTO mode, unit will run in SLEEP function according to the operation mode.
- After setting SLEEP function, it is forbidden to calibrate clock.
- If the set sleep-time does not reach 8 hours, the unit will stop operation automatically after set time is complete.
- Set "TIMER-OFF" function first, then set SLEEP, and the sleep-set is performance; set TIMER-ON function first, the sleep function can only be set before TIMER-ON; if set the SLEEP function first, the TIMER function can not be set.

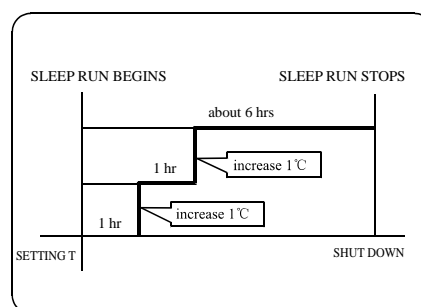
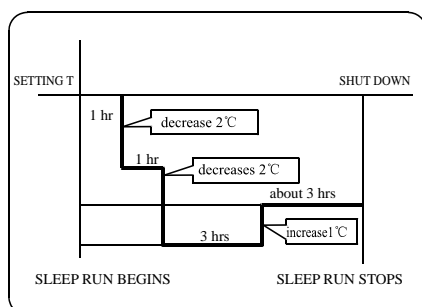

■ Operation

Power Failure Compensation (to be applied for a necessary situation)

After the power failure compensation is set, if power failure suddenly occurs while the air conditioner is working, it will resume the previous working state when the power is supplied again.

Setting Method: When the wire controller is on (excluding timer mode and fan mode), press the "Sleeping" button on the remote controller 10 times within 5 seconds, and after the buzzer rings 4 times, the air conditioner will enter the state of power failure compensation.

Cancel Method: Press the "Sleeping" button on the wire controller 10 times within 5 seconds, and after the buzzer rings 2 timer, the power failure compensation mode will be cancelled.

Notes: When a power failure suddenly occurs during the air conditioner is working after the power failure compensation is set, if the air conditioner will not be used for a long time, please cut off the power supply to prevent its operation from being resumed after the power is supplied again, or press the "Switch On/Off" button after the power comes again.

Change-over switch



Mark	ON	OFF
1	Fixed Frequency	Inverter
2	Have rise and drop	No rise and drop
3	Swing	Not Swing
4	The collection temperature of indoor unit	The collection temperature of wire controller.

In this series changeover switch is set:

1.ON 2.OFF 3.OFF 4.OFF

■ Malfunction

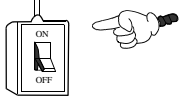
please check the following things about your air conditioner before making a service call.

Unit fails to start			
<p>Is the power source switch adjust cut in?</p>  <p>Power supply switch is not ON.</p>	<p>Is city supply power in normal?</p> 	<p>Isn't the signal receiving section exposed to the direct sunlight or strong illumination?</p>	<p>Isn't the earth leakage breaker in action?</p> <p>It is dangerous. Turn off the power supply switch immediately and contact the sales dealer.</p>
Cooling or heating is not sufficient			
<p>Is the thermostat adjust as required?</p>	<p>Isn't the air filter dirty?</p>	<p>Isn't any doors or windows left open?</p>	<p>Doesn't any obstacle exist at the air inlet or outlet?</p>
<p>Isn't the swing louver horizontal? (At HEATING mode) If swing louver is horizontal, the blow wind does not reach floor.</p>	Cooling is not sufficient		
	<p>Isn't sun-shine invading direct?</p>	<p>Isn't any unexpected heating load generated?</p>	<p>Isn't the room much crowded?</p>
<p>The wind does not blow during heating operation Isn't it warming up?</p>			

When the air conditioner does not operate properly after you have checked the above mentioned items or when the following phenomenon is observed, stop the operation of the air conditioner and contact your sales dealer.

- The fuse or breaker often shuts down.
- Water drops off during cooling operation.
- There is a irregularity in operation or abnormal sound is audible.



■ Malfunction

Error display

Failure description	Code on wired controller
Room temp. sensor abnormal	E1
Indoor coil temp. sensor abnormal	E2
Outdoor temp. sensor abnormal	E3
Outdoor coil temp. sensor abnormal	E4
Over-current malfunction	E5
High / Low pressure abnormal	E6
Communication malfunction between indoor PCB and panel	E8
Communication malfunction between indoor PCB and outdoor PCB	E9
The float switch malfunction	E0

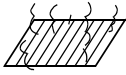

■ Malfunction

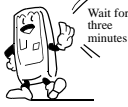
The followings are not malfunction

<p>Water flowing sound is heard.</p> 	<p>When the air conditioner is started, when the compressor starts or stops during operation or when the air conditioner is stopped, it sometimes sounds "shuru shuru" or "gobo gobo". It is the flowing sound of the refrigerant, and it is not a trouble.</p>
<p>Cracking sound is heard.</p>	<p>This is caused by heat expansion or contraction of plastics.</p>
<p>It smells.</p>	<p>Air which blows out from the indoor unit sometimes smells. The smell results from residents of tobacco smoke or cosmetics stuck inside of unit.</p>
<p>During operation, white fog comes out of indoor unit.</p> 	<p>When the air conditioner is used at restaurant etc. where dense edible oil fume is always exists, white fog sometimes blows out of air outlet during operation. In this case consult sales dealer for cleaning the heat exchanger.</p>
<p>It is switched into the FAN mode during cooling.</p>	<p>To prevent frost from being accumulated on the indoor unit heat exchanger, it is sometimes automatically switched to the FAN mode but it will soon return to the cooling mode.</p>
<p>The air conditioner can not be restarted soon after it stops.</p> 	<p>Even if the operation switch is turned on, cooling, dehumidifying or heating is not operable for three minutes after the conditioner is stopped. Because the protecting circuit is activated. (During this time air conditioner operates in fan mode.)</p> 
<p>Air does not blow or the fan speed can not be changed during dehumidifying</p>	<p>When it is excessively cooled during dehumidifying, the blower automatically repeats reducing and lowering the fan speed.</p>
<p>During operation, operation mode has changed over automatically.</p>	<p>Isn't the AUTO mode selected? In the case of AUTO mode, operation mode is changed automatically from cooling to heating or vise-versa according to the room temperature.</p>
<p>Water or steam generates from the outdoor unit during heating.</p>	<p>This results when frost accumulated on the outdoor unit is removed (during defrosting operation).</p>

Care and Maintenance

Points to observe

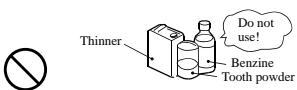
Turn off the power supply switch.	Do not touch with wet hand.	Do not use hot water or volatile liquid.
		

CAUTION

- Do not open the inlet grill until fan stops completely.
- Fan will continue rotating for a while by the law of inertia after operation is being stopped.

Cleaning

1. Clean the air filter by lightly tapping it or with the cleaner. It is more effective to clean the air filter with water.
If the air filter is very dirty, dissolve neutral detergent in the lukewarm water (approx. 30°C), rinse the air filter in the water, and thoroughly wash the air filter off the detergent in the plain water.
2. After drying the air filter, set it up on the air conditioner.



CAUTION

- Do not dry the air filter with fire.
- Do not run the air conditioner without the air filter.

Care and Cleaning of the unit

- Clean with soft and dry cloth.
- If it is very dirty, dissolve neutral detergent in the lukewarm water and make the cloth wet with the water. After wiping, clean off the detergent using clean water.

Post-Season Care

- Operate the unit with FAN mode on a fair day for about half a day to dry the inside of the unit well.
- Stop operation and turn off the power supply switch. Electric power is consumed even the air conditioner is in stop.
- Clean the air filter and set it in the place.

Pre-Season Care

See that there are no obstacles blocking the air inlet and air outlet of both indoor and outdoor units.

- Make sure that the air filter is not dirty.
- Cut in the power supply switch 12 hours before starting run.

■ For Preparation of Heating("Hot Keep")

"HOT KEEP" is operated in the following cases.

- When heating is started:
In order to prevent blowing out of cool wind, the indoor unit fan stopped according to the room temperature which heating operation is started. Wait for approx. 2 to 3 minute, and the operation will be automatically changed to the ordinary heating mode.
- Defrosting operation (in the heating mode):
When it is liable to frost. the heating operation is stopped automatically for 5 to 12 minutes once per approx. one hour, and defrosting is operated. After defrosting is completed, operation mode is automatically changed to ordinary heating operation.
- When the room thermostat is actuated:
When room temperature increases and room temperature controller actuates, the fan speed is automatically changed to stop under low temperature condition of indoor heat exchanger. When room temperature decreases, air conditioner automatically changes over to ordinary heating operation.





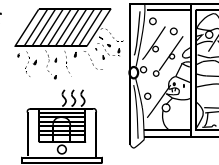

■ WARMING OPERATION

- Heat pump type warming
With the heat pump type warming, the mechanism of heat pump that concentrate heat of outdoor air with the help of refrigerant to warm the indoor space, is utilized.
- Defrosting operation
When a room is warmed with a heat pump type air conditioner, frost accumulates on the heat exchanger of outdoor unit along with the drop of indoor temperature. Since the accumulated frost reduces the effect of warming, it is necessary to automatically switch the operation to the defrosting mode. During the defrosting operation, heating operation is interrupted.
- Atmospheric temperature and warming capacity
Warming capacity of heat pump type air conditioner decreases along with the drop of outdoor temperature.
When the warming capacity is not sufficient, it is recommended to use another heating implement.
- Period of warm-up
Since the heat pump type air conditioner employs a method to circulate warm winds to warm the entire space of a room, it takes time before the room temperature rises.
It is recommendable to start the operation a little earlier in a very cold morning.

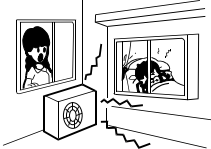

■ Is The Unit Installed Correctly

Confirm the following items for safe and comfortable use of air conditioner.
The installation work is to be burden on the sales dealer, and do not conduct it by yourself.

Installation place		
<p>Avoid installing the air conditioner near the place where possibility of inflammable gas leakage exists.</p>  <p>Explosion (Ignition) may occur.</p>	<p>Install the unit at well ventilated place.</p>  <p>If some obstacle exist, it may cause capacity reduction or noise increase.</p>	<p>Install the air conditioner firmly on the foundation that can fully support the weight of the unit.</p>  <p>If not, it may cause vibration or noise.</p>
<p>Select the place so as not to annoy neighbor with the hot air or noise.</p>  	<p>Snow protection work is necessary where outdoor unit is blocked up by snow.</p> <p>For details consult your sales dealer.</p>	<p>It is advisable not to install the air conditioner at the following special place. It may cause malfunction, consult the sales dealer when you have to install the unit on such a place.</p> <ul style="list-style-type: none"> ● The place where corrosive gas generates (Hot spring area etc.) ● The place where salt breeze blows (Seaside etc.) ● The place where dense soot smoke exists ● The place where humidity is extraordinarily high ● The place where near the machine which radiates the electromagnetic wave ● The place where voltage variation is considerably large

Electric work

The electric work must be burden on the authorized engineer with qualification for electric work and grounding work, and the work must be conducted in accordance with electric equipment technical standard.

- The power source for the unit is to be of exclusive use.
- An earth leakage breaker should be installed.(This is necessary to prevent electric shock.)
- The unit must be grounded.

When you change your address or the installation place

Special technology is required for removal or reinstallation of air conditioner, consult the sales dealer. Besides, construction expense is charged for removal or reinstallation.

For inspection and maintenance

The capacity of air conditioner will decrease by contamination of inside of unit when it is used for about three years although depending upon the circumstances under which it is used, and so in addition to the usual maintenance service, special inspection/maintenance service is necessary. It is recommended to make a maintenance contract (charged) by consulting your sales dealer.

■ Installation Manual For Wire Controller

1. Remove upper part of wire controller

Remove upper part of wire controller by press.

PCB is mounted on lower part of wire controller, be careful not to damage it.

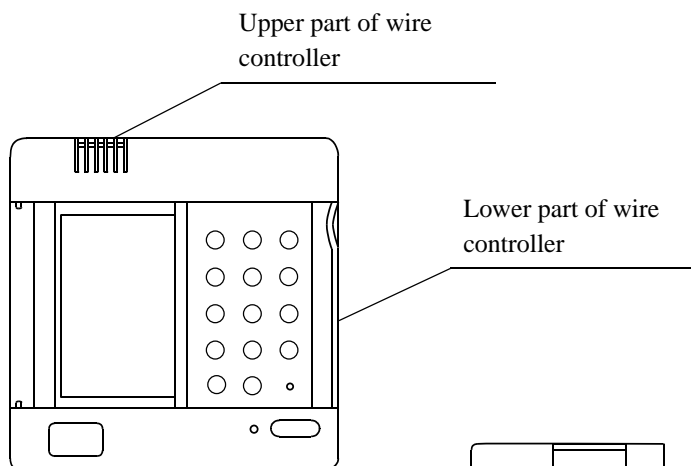

2. Install wire controller

- (1) For exposed installation, use 2 wood screws .
- (2) For recessed installation, use 2 wood screws .

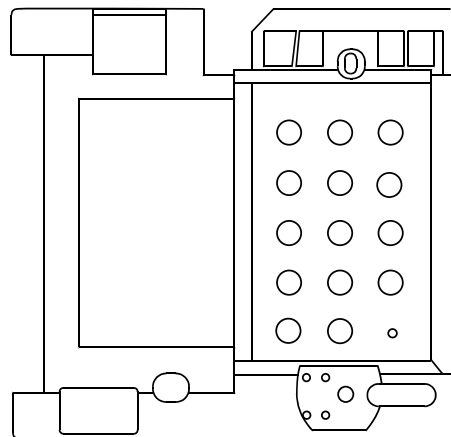

Note

Try as far as possible a flat surface for installation. Don't use excessive force when tightening screws, or lower part might get deformed.

■ Installation Manual For Wire Controller

3. Indoor unit wiring

Connect terminals (A,B,C,D) on lower part of wire controller to terminals (A, B,C,D) on PCB of indoor unit.

Hint

When make wiring, please keep a distance between wires and power supply cord.

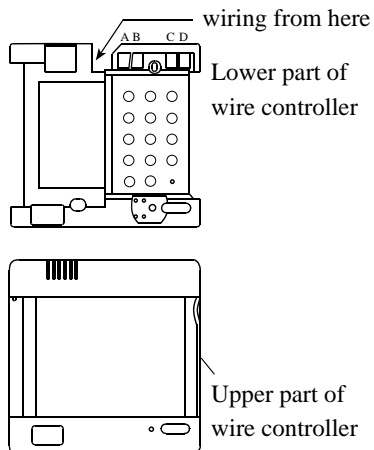

Wire size

Cord kind	Shield wire (4 core) (refer to Hint 3,4)
Size	0.33mm ²

- Use shielded wires for telecommunication between wire controller and indoor unit; indoor unit and outdoor unit. Ground the shield on one side. Otherwise misoperation because of noise may occur.
- Signal wire is self-provided.

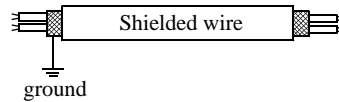

Hint

Tread surface of the terminal well so that shielding may not contact other part.

4. Replace the upper part of wire controller

Be careful not to press the wiring.

Hint

1. Switch box and cord for wiring are not supplied.
2. Don't touch PCB with hand.

■ Installation Manual For Indoor Unit

1. Safety precautions

- Please read these "Safety Precautions" first then accurately execute the installation work.
- Though the precautionary points indicated herein are divided under two headings, **⚠ WARNING** and **⚠ CAUTION**, those points which are related to the strong possibility of an installation done in error resulting in death or serious injury are listed in the **⚠ WARNING** section. However, there is also a possibility of serious consequences in relationship to the points listed in the **⚠ CAUTION** section as well. In either case, important safety related information is indicated, so by all means, properly observe all that is mentioned.
- After completing the installation, along with confirming that no abnormalities were seen from the operation tests, please explain operating methods as well as maintenance methods to the user (customer) of this equipment, based on the owner's manual.
Moreover, ask the customer to keep this sheet together with the owner's manual.

⚠ WARNING

- This system should be applied to places as office, restaurant, residence and the like. Application to inferior environment such as engineering shop could cause equipment malfunction.
- Please entrust installation to either the company which sold you the equipment or to a professional contractor. Defects from improper installations can be the cause of water leakage, electric shocks and fires.
- Execute the installation accurately, based on following the installation manual. Again, improper installations can result in water leakage, electric shocks and fires.
- When a large air-conditioning system is installed to a small room, it is necessary to have a prior planned countermeasure for the rare case of a refrigerant leakage, to prevent the exceeding of threshold concentration. In regards to preparing this countermeasure, consult with the company from which you purchased the equipment, and make the installation accordingly. In the rare event that a refrigerant leakage and exceeding of threshold concentration does occur, there is the danger of a resultant oxygen deficiency accident.
- For installation, confirm that the installation site can sufficiently support heavy weight. When strength is insufficient, injury can result from a falling of the unit.
- Execute the prescribed installation construction to prepare for earthquakes and the strong winds of typhoons and hurricanes, etc. Improper installations can result in accidents due to a violent falling over of the unit.
- For electrical work, please see that a licensed electrician executes the work while following the safety standards related to electrical equipment, and local regulations as well as the installation instructions, and that only exclusive use circuits are used.
Insufficient power source circuit capacity and defective installation execution can be the cause of electric shocks and fires.
- Accurately connect wiring using the proper cable, and insure that the external force of the cable is not conducted to the terminal connection part, through properly securing it. Improper connection or securing can result in heat generation or fire.
- Take care that wiring does not rise upward, and accurately install the lid/service panel. Its improper installation can also result in heat generation or fire.
- When setting up or moving the location of the air conditioner, do not mix air etc. or anything other than the designated refrigerant (R407C) within the refrigeration cycle.
Rupture and injury caused by abnormal high pressure can result from such mixing.
- Always use accessory parts and authorized parts for installation construction. Using parts not authorized by this company can result in water leakage, electric shock, fire and refrigerant leakage.

⚠ CAUTION

- Execute proper grounding. Do not connect the ground wire to a gas pipe, water pipe, lightning rod or a telephone ground wire. Improper placement of ground wires can result in electric shock.
- The installation of an earth leakage breaker is necessary depending on the established location of the unit. Not installing an earth leakage breaker may result in electric shock.
- Do not install the unit where there is a concern about leakage of combustible gas.
The rare event of leaked gas collecting around the unit could result in an outbreak of fire.
- For the drain pipe, follow the installation manual to insure that it allows proper drainage and thermally insulate it to prevent condensation. Inadequate plumbing can result in water leakage and water damage to interior items.

■ Installation Manual For Indoor Unit

⚠ Caution

- Please do not install the unit in places where flammable gases may be leaked. In case that gas is leaked and accumulated around the unit, it may cause dangers of fire etc.

The indoor unit shall be installed at locations where cold and hot air could evenly circulated. The following locations should be avoided:

- Places with rich saline matters (seaside regions).
- Places with plenty of gas sulfides (mainly in warm spring areas where the copper tube and braze weld is prone to corrosion).
- Locations with much oil (including mechanical oil) and steam.
- Locations using organic solvents.
- Places where there are machines generating HF electromagnetic waves.
- Positions adjacent to door or window in contact with high-humidity external air. (Easy to generate dew).
- Locations frequently using special aerosols.

Indoor unit

1. Select suitable places the outlet air can be sent to the entire room, and convenient to lay out the connection pipe, connection wire and the drainage pipe to outdoor.
2. The ceiling structure must be strong enough to support the unit weight.
3. The connecting pipe, drain pipe and connection wire shall be able to go though the building wall to connect between the indoor and outdoor units.
4. The connecting pipe between the indoor and outdoor units as well as the drain pipe shall be as short as possible. (See Figure 1)
5. If its necessary to adjust the filling amount of the refrigerant, please refer to the installation manual attached with the outdoor unit.
6. The connecting flange should be provided by the user himself.
7. The indoor unit has two water outlets one of which is obstructed at the factory (with a rubber cap). Only the outlet not obstructed (liquid inlet and outlet side) will be generally used during installation. If applicable, both the outlets should be used together.

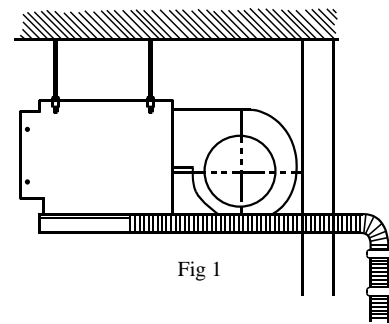

Important

- An access port must be provided during installation of indoor unit for maintenance.

■ Installation Manual For Indoor Unit

After selecting the unit installation location, proceed the following steps:

1. Drill a hole in the wall and insert the connecting pipe and wire through a PVC wall-through tube purchased locally. The wall hole shall be with a outward down slope of at least 1/100. (See Figure 2)
2. Before drilling check that there is no pipe or reinforcing bar just behind the drilling position.
Drilling shall avoid at positions with electric wire or pipe.
3. Mount the unit on a strong and horizontal building roof. If the base is not firm, it will cause noise, vibration or leakage.
4. Support the unit firmly.
5. Change the form of the connection pipe, connection wire and drain pipe so that they can go through the wall hole easily.

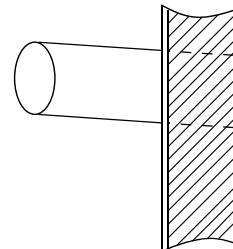
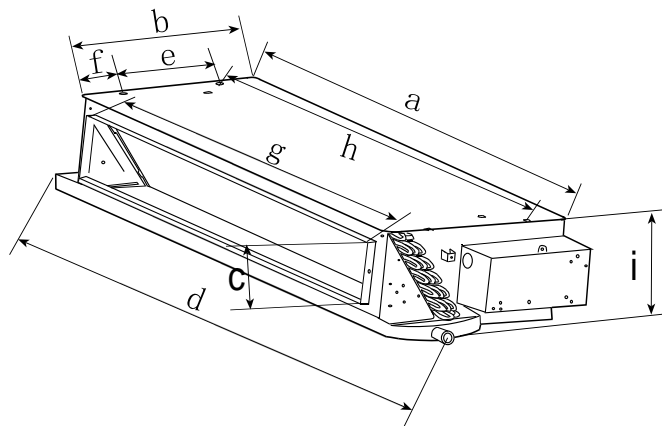

Fig 2

Installation dimension: (Unit: mm)

a	b	c	d	e	f	g	h	i
1002	483.5	131	1105	255	105	880	970	220



Installation Manual For Indoor Unit

- Each of the air sending duct and air return duct shall be fixed on the prefabricated panel of the floor by the iron bracket.
- The recommended distance between the edge of the air return duct and the wall is over 150mm.
- The gradient of the condensate water pipe shall keep over 1%.
- The condensate water pipe shall be thermal insulated.
- When installing the ceiling Concealed type indoor unit, the air return duct must be designed and installed (as figure shown).

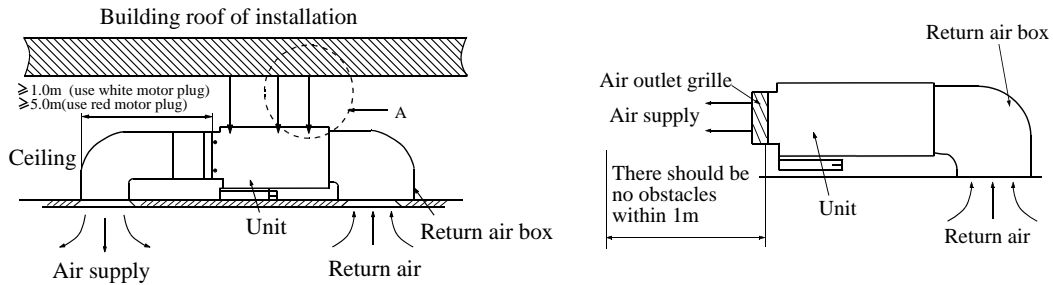

Note: When connecting the short ducts, use the low static terminals, which color is white.

The distance L from the air outlet of the duct to the air outlet of the air conditioner shall be no more than 1 m.

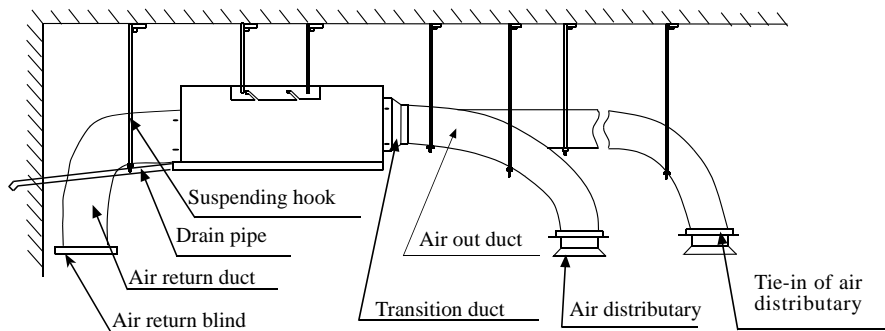

The sketch map of long duct

Note: When connecting the long ducts, use the middle static terminals, which color is red.

The distance L from the air outlet of the duct to the air outlet of the air conditioner shall be no more than 5 m.

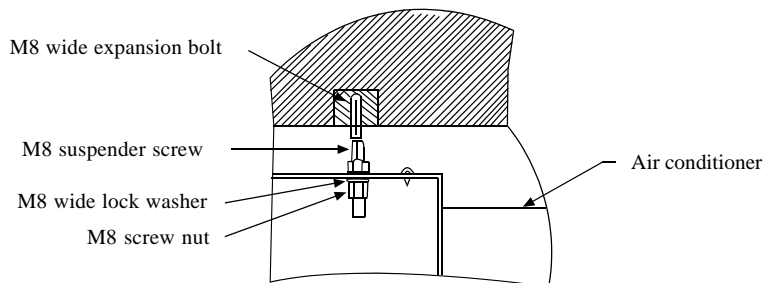

■ Installation Manual For Indoor Unit

Installation of indoor unit duct

1. Installation of air sending duct

- This unit uses rounded duct, the diameter of the duct is 180mm.
- The rounded duct needs to add a transition duct to connect with the air-sending duct of indoor unit, then connect with respective separator. As Fig. 1 shown, all the fan speed of any of the separator's air outlet shall be adjusted approximately the same to meet the requirement for the room air conditioner.

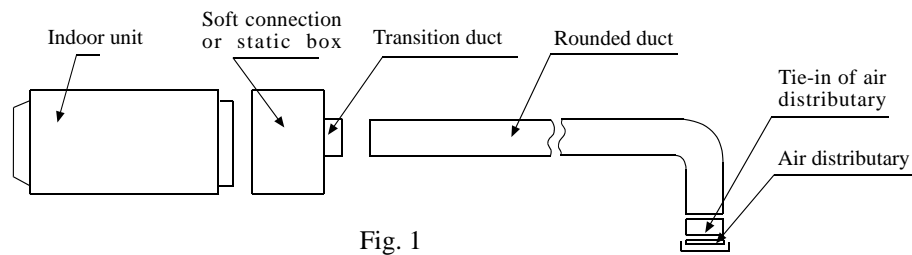

2. Installation of air return duct

- Use rivet to connect the air return duct on the air return inlet of the indoor unit, then connect the other end with the air return blind. As Fig. 2 shown.

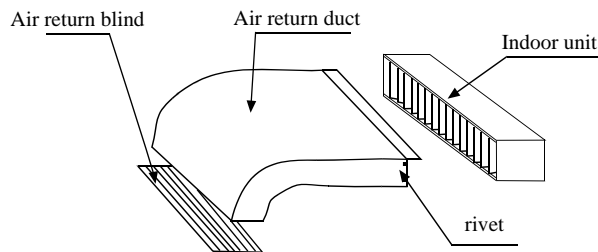

3 Thermal insulation of duct

- Air-sending duct and air return duct shall be thermally insulated. First stick the gluey nail on the duct, then attach the heat preservation cotton with a layer of tinfoil paper and use the gluey nail cap to fix. Finally use the tinfoil adhesive tape to seal the connected part. As Fig. 3 shown.

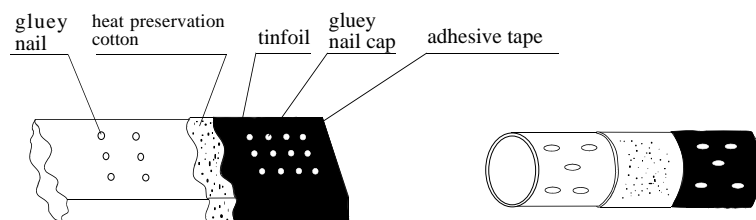

Fig. 3

■ Installation Manual For Indoor Unit

Installing the suspension screw:

Use M8 or M10 suspension screws (4, prepared in the field) (when the suspension screw height exceeds 0.9m, M10 size is the only choice). These screws shall be installed as follows with space adapting to air conditioner overall dimensions according to the original building structures.

Wooden structure

A square wood shall be supported by the beams and then set the suspension screws.

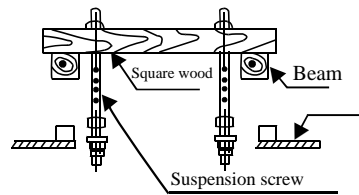

New concrete slab

To set with embedded parts, foundation bolts etc.



Knife embedded part



Guide plate embedded part

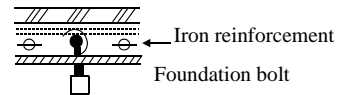

Pipe suspension foundation bolt

Original concrete slab

Use hole hinge, hole plunger or hole bolt.

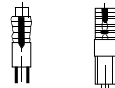

Steel reinforcement structure

Use steel angle or new support steel angle directly.

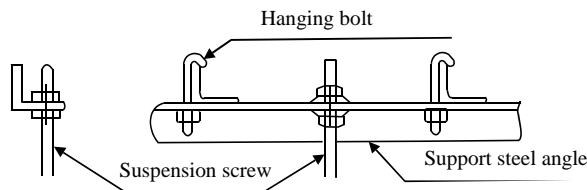

Hanging of the indoor unit

Fasten the nut on the suspension screw and then hang the suspension screw in the T slot of the suspension part of the unit.

Aided with a level meter, adjust level of the unit within 5mm²

Installation Manual For Indoor Unit

⚠ Caution

In order to drain water normally, the drain pipe shall be processed as specified in the installation manual and shall be thermal insulated to avoid dew generation. Improper hose connection may cause indoor water leakage.

Requirements

- The indoor drain pipe shall be thermal insulated.
- The connection part between the drain pipe and the indoor unit shall be insulated so as to prevent dew generation.
- The drain pipe shall be slant downwards (greater than 1/100). The middle part shall not be of S type elbow, otherwise abnormal sound will be produced.
- The horizontal length of the drain pipe shall be less than 20 m. In case of long pipe, supports shall be provided every 1.5 – 2m to prevent wavy form.
- Central piping shall be laid out according to the following figure.
- Take care not to apply external force onto the drain pipe connection part.

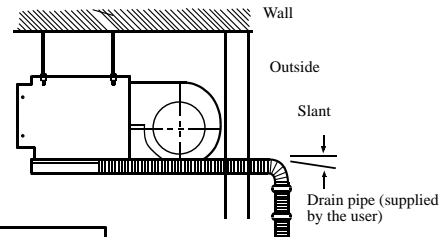
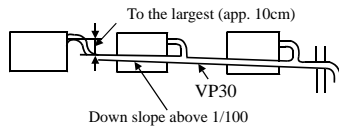
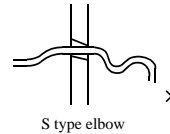
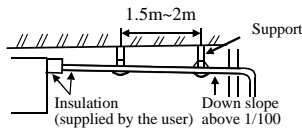

Pipe and insulation material

Pipe	Rigid PVC pipe VP31.5mm (internal diameter)
Insulation	Foamed PE with thickness above 7 mm

Hose

Drain pipe size: (3/4") PVC pipe

The hose is used for adjusting the off-center and angle of the rigid PVC pipe.

- Directly stretch the hose to install without making any deformation.
- The soft end of the hose must be fastened with a hose clamp.
- Please apply the hose on horizontal part

Insulation treatment:

- Wrap the hose and its clamp until to the indoor unit without any clearance with insulating material, as shown in the figure.

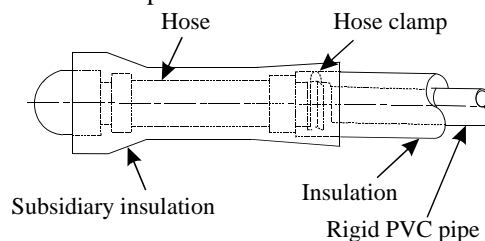

Drain confirmation

During trial run, check that there is no leakage at the pipe connection part during water draining even in winter.

■ Installation Manual For Indoor Unit

⚠ Caution

- In installation, if there is refrigerant gas leakage, please take ventilation measures immediately. The refrigerant gas will generate poisonous gas upon contacting fire.
- After installation, please verify that there is no refrigerant leakage. The leaked refrigerant gas will produce poisonous gas when meeting fire source such as heater and furnace etc.

Allowable pipe length and drop

These parameters differ according to the outdoor unit. See the instruction manual attached with the outdoor unit for details.

Pipe material and size

Pipe material	Phosphorus deoxidized copper seamless pipe (TP2) for air conditioner		
Pipe size (mm)	Gas side	? 12.70	HDU-18CF03
	Liquid side	? 6.35	HDU-18HF03
	Gas side	? 15.88	HDU-28CF03
	Liquid side	? 9.52	HDU-28HF03

Supplementary refrigerant

The refrigerant supplementation shall be as specified in the installation instructions attached with the outdoor unit R22

The adding procedure shall be aided with a measuring meter for a specified amount of supplemented refrigerant.

Requirement

- Overfilling or underfilling of refrigerant will cause compressor fault. The amount of the added refrigerant shall be as specified in the instructions.

Connection of refrigerant pipe

Conduct flared connection work to connect all refrigerant pipes.

- The connection of indoor unit pipes must use double spanners.
- The installing torque shall be as given in the following table.

Connecting pipe O.D.(mm)	Installing torque (N-m)
? 6.35	11.8 (1.2kgf-m)
? 12.70	49.0 (5.0 kgf-m)
? 9.52	24.5 (2.5kgf-m)
? 15.88	78.4 (8.0 kgf-m)

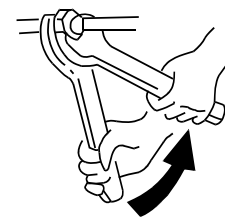

Double-spanner operation

■ Installation Manual For Indoor Unit

Vacuum pumping

With a vacuum pump, create vacuum from the stop valve of the outdoor unit. Emptying with refrigerant sealed in the outdoor unit is absolutely forbidden.

Open all valves

Open all the valves on the outdoor unit.

Gas leakage detection

Check with a leakage detector or soap water that if there is gas leakage at the pipe connections and bonnets.

Insulation treatment

Conduct insulation treatment on both the gas side and liquid side of pipes respectively. During cooling operation, both the liquid and gas sides are cold and thus shall be insulated so as to avoid dew generation.

- The insulating material at gas side shall be resistant to a temperature above 120°C
- The indoor unit pipe connection part shall be insulated.

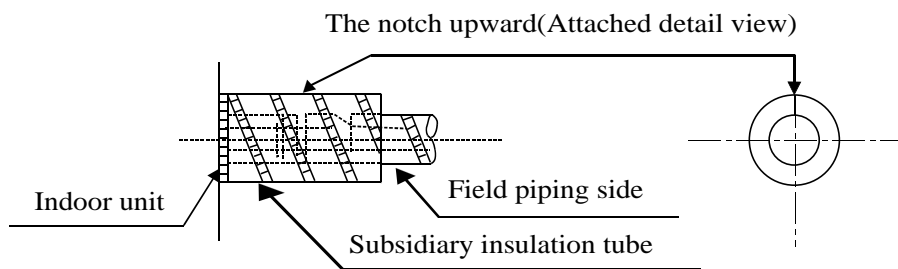

Installation Manual For Indoor Unit

Electric wiring

⚠ WARNING

DANGER OF BODILY INJURY OR DEATH
 TURN OFF ELECTRIC POWER AT CIRCUIT BREAKER OR POWER SOURCE BEFORE MAKING ANY ELECTRIC CONNECTIONS. GROUND CONNECTIONS MUST BE COMPLETED BEFORE MAKING LINE VOLTAGE CONNECTIONS.

(1) Selection of size of power supply and interconnecting wires.

Precautions for Electric wiring

- Electric wiring work should be conducted only by authorized personnel.
- Do not connect more than three wires to the terminal block. Always use round type crimped terminal lugs with insulated grip on the ends of the wires.
- Use copper conductor only.

Select wire sizes and circuit protection from table below. (This table shows 20 m length wires with less than 2% voltage drop.)

Item	Phase	Circuit breaker		Power source wire size (minimum)	Earth leakage breaker	
		Switch breaker (A)	Overcurrent protector rated capacity (A)		Switch breaker	Leak current
HDU-18CF03 HDU-18HF03	1	30	20	2.5mm ²	30	30mA
HDU-28CF03 HDU-28HF03	1	40	36	4.0mm ²	40	30mA

(2) Wiring connection

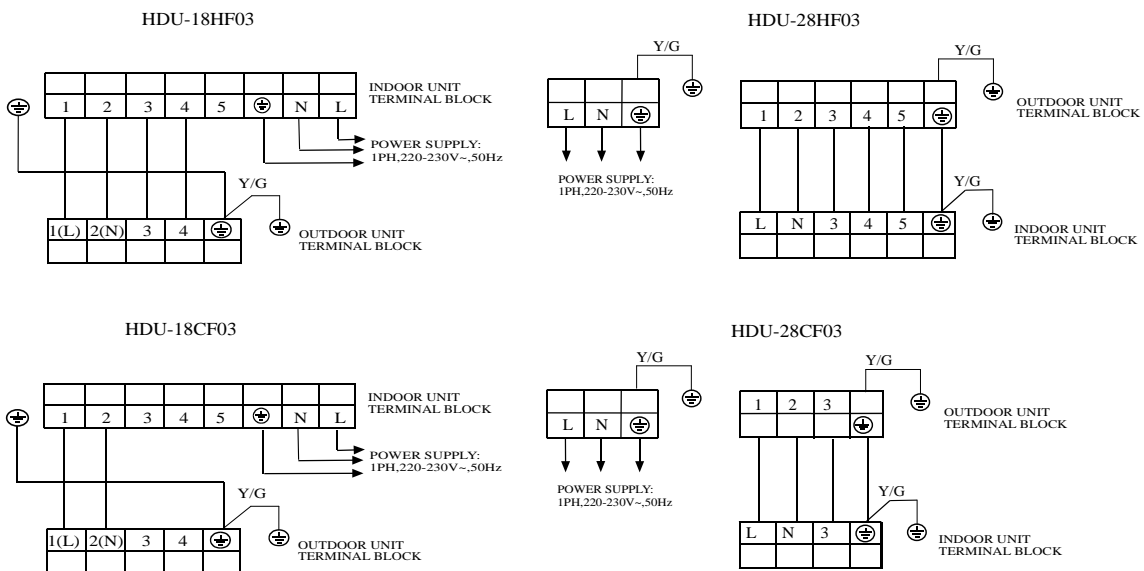

HAIER GROUP

Qingdao Haier Air Conditioner Electric Co., Ltd.

Address: Haier Garden ,Qianwangang Road , Economic Development Zone,
Qingdao ,Shandong 266500, P.R.C

Web Site: <http://www.haier.com>