

# Service Manual

# Air Cleaners

**MC401VE**

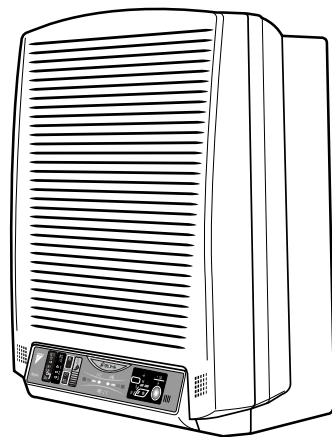

# Air Cleaners

1. Safety Cautions.....	iii
1.1 Cautions and Warnings .....	iii
1.2 Using Icons.....	v
1.3 Using Icons List.....	vi
<b>Part 1 Operation Manual .....</b>	<b>1</b>
1. Operating Manual.....	2
1.1 Names and Functions of Parts .....	4
1.2 Indicator Lamps and their Functions .....	4
1.3 Accessories .....	5
1.4 Tips for appropriate use.....	6
1.5 CAUTION .....	7
1.6 Names and Functions of The Operating Section.....	8
1.7 Names and Functions of The Indicator Lamps.....	9
1.8 Setup .....	10
1.9 Installation .....	11
1.10 How to Operate the Unit.....	12
1.11 How to Clean the Prefilter.....	13
1.12 How to Clean the Front Panel .....	13
1.13 How to Clean the Ionizer .....	14
1.14 How to Change the Ion Filter (Roll) .....	16
1.15 Optional Accessories.....	17
1.16 Specifications .....	17
<b>Part 2 Troubleshooting .....</b>	<b>19</b>
1. Troubleshooting .....	20
1.1 Equipment does not Operate.....	20
1.2 Indicator does not Change from "Dirty" to "Clean" .....	22
1.3 Remote Controller Fails to Operate Equipment.....	23
1.4 Photocatalytic Operation does not Activate.....	24
<b>Part 3 Removal Procedure .....</b>	<b>27</b>
1. Removal Procedure of MC401VE.....	28
1.1 Removal of External Accessories.....	28
1.2 Removal of Ionizing Wire.....	30
1.3 Removal of Electrical Parts (Inverter Lamp).....	31
1.4 Removal of PCB.....	34
1.5 Removal of Fan Motor .....	36
1.6 Removal of Safety Switch.....	37
<b>Part 4 Reference Data .....</b>	<b>39</b>
1. Wiring Diagram .....	40
1.1 MC401VE.....	40
2. Parts List .....	41

2.1 Parts Illustration..... 41  
2.2 Parts List..... 42

**Index ..... i**

**Drawings & Flow Charts .....iii**

# 1. Safety Cautions

## 1.1 Cautions and Warnings

Read the following warnings and cautions **BEFORE** operating the system and use it correctly.

- This manual classifies the precautions to the user into the following two categories. Each mention important cautions on safety, so be sure to keep them.

 **WARNING** Failure to follow a warning is very likely to result in such grave consequences as death or serious injury.

 **CAUTION** Failure to follow a caution may result in serious injury or property damage, and in certain conditions, may result in a grave consequence.

- The pictograms in the text show the following meanings.

 Absolutely prohibited

 Be sure to operate following instructions

 Be sure to unplug the power cable

- After reading, keep this manual in a place where the actual user can see it whenever necessary. And in case of changing user, be sure to hand it to the new user.

### Warning

**Do not disassemble, service or modify this equipment.**

Unwarranted tampering can lead to fire and/or malfunction.

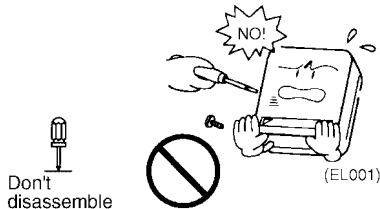

**Do not operate the equipment with wet hands.**

Otherwise electrical shock can result.



**Use only 220-240 VAC 50 Hz power supply.**

Otherwise fire and electrical shock can result.

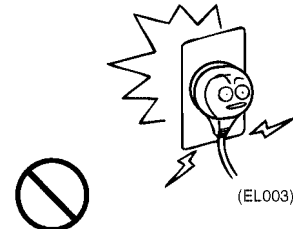

**Do not use the power cable if it is damaged.**

Using a damaged power cable is extremely hazardous; if the power cord becomes damaged, you must obtain a replacement from the manufacturer or from a properly-authorized service agent.

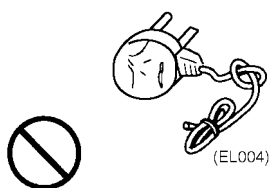

**Before changing filters, cleaning the equipment or moving it, turn it OFF and unplug the power cable.**

Working with power ON can lead to fire and/or electric shock.

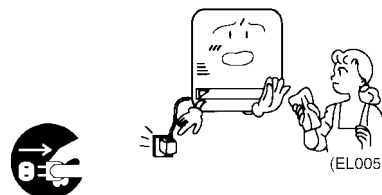

**Do not use the power cable if damaged or loose in the socket.**

Using the power cable in anything but proper working condition can lead to short-circuits and subsequently electric shock and/or fire.

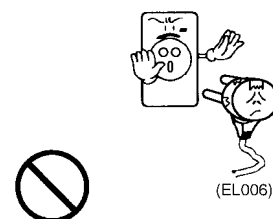

**⚠ Caution**

**Do not use the equipment in a place filled with oily smoke such as a kitchen or in a place filled with combustible gas, corrosive gas or metal dust.**

Otherwise fire and equipment malfunction can result.

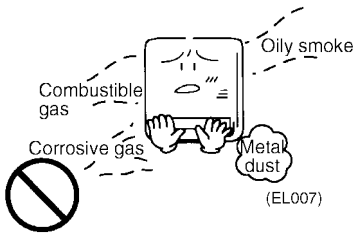

**Do not use in humid places or places which might be wet, such as bathrooms.**

Contact with water can lead to electric shock or damage the equipment.

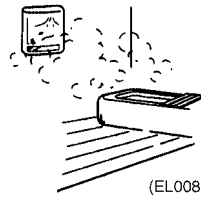

**Do not use the equipment near a lighting fixture (keep a distance of at least 1 m).**

Lighting equipment can cause poor reception of remote controller signals and equipment discoloration.

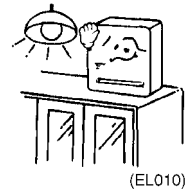

**Do not use outdoors or where exposed to direct sunlight.**

Direct sunlight can weaken remote control signal reception sensitivity and discolor the casing.



**Do not use near to sources of heat such as heaters.**

Heat can discolor and deform the casing.

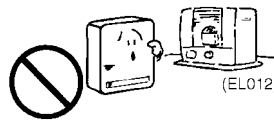

**Keep the unit and remote control minimum 1 m from lighting, TVs, radios, stereos and aerials.**

This unit can disturb TV pictures and generate interference. Illumination can weaken remote control signal reception sensitivity and discolor the casing.



**Keep the equipment 10 cm or more away from the wall when used on a table.**

Otherwise the wall can become dirty.

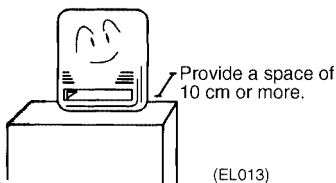

**Do not use in the place of kitchen fans or cooker hood fans.**

Adverse conditions of use can shorten service-life of the prefilter and ion filter, as well as lead to equipment damage.



**Prevent combustibles (hair sprays, etc.), sparks and incense from being drawn into the unit.**

Such substances can cause fire.

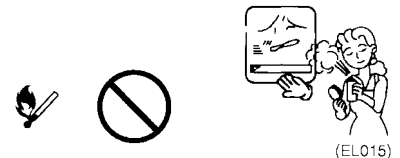

**Do not insert fingers or objects into the openings of the suction and discharge grilles.**

Otherwise electrical shock and equipment malfunction can result.

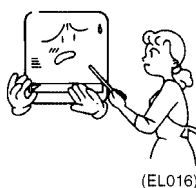

**When used in conjunction with a humidifier, keep mist from being directly drawn into the unit.**

Mists can lead to electric shock and/or equipment damage.



**Do not block the intake or outlet.**

Blocked openings can reduce capacity (air will not be cleaned throughout the entire room) and/or damage the equipment.



**⚠ Caution**

**Do not place water containers such as fish bowls and flower vases near the equipment.**

Water can cause electrical shock and equipment malfunction when it enters the equipment.

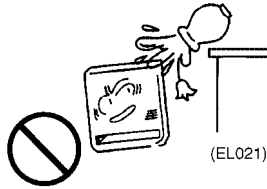

**Do not wipe with benzene or thinner, or spray with insecticide.**

Such substances can cause cracking, electric shock and/or fire.

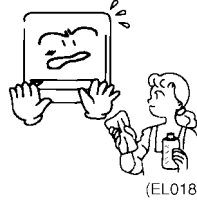

**If not using the unit for long periods of time, unplug the power cable.**

Dielectric breakdown can lead to leakage current and subsequently electric shock and/or fire.

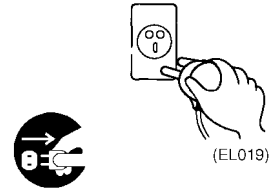

**Hold the plug to unplug the power cord from the AC outlet. Do not pull the cord to unplug.**

Otherwise electrical shock can result or sparks may be generated due to shorting.



**Do not operate the equipment without the prefilter or roll filter.**

Operating the equipment without the filter can result in equipment malfunction.



**Do not sit or stand on the equipment.**

Otherwise equipment malfunction can result.

**Do not position the equipment on its side or tilt it during use.**

Otherwise equipment malfunction can result.

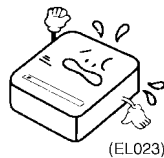

**Ventilate the room frequently when used together with a heating device.**



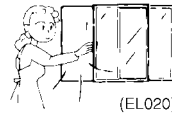

This product does not remove carbon monoxide. Insufficient ventilation can result in carbon monoxide poisoning.



## 1.2 Using Icons

Icons are used to attract the attention of the reader to specific information. The meaning of each icon is described in the table below:

## 1.3 Using Icons List

Icon	Type of Information	Description
 <b>Note:</b>	Note	A “note” provides information that is not indispensable, but may nevertheless be valuable to the reader, such as tips and tricks.
 <b>Caution</b>	Caution	A “caution” is used when there is danger that the reader, through incorrect manipulation, may damage equipment, lose data, get an unexpected result or has to restart (part of) a procedure.
 <b>Warning</b>	Warning	A “warning” is used when there is danger of personal injury.
	Reference	A “reference” guides the reader to other places in this binder or in this manual, where he/she will find additional information on a specific topic.

# Part 1

# Operation Manual

1. Operating Manual.....	2
1.1 Names and Functions of Parts .....	4
1.2 Indicator Lamps and their Functions .....	4
1.3 Accessories .....	5
1.4 Tips for appropriate use.....	6
1.5 CAUTION .....	7
1.6 Names and Functions of The Operating Section.....	8
1.7 Names and Functions of The Indicator Lamps.....	9
1.8 Setup .....	10
1.9 Installation .....	11
1.10 How to Operate the Unit.....	12
1.11 How to Clean the Prefilter.....	13
1.12 How to Clean the Front Panel .....	13
1.13 How to Clean the Ionizer .....	14
1.14 How to Change the Ion Filter (Roll) .....	16
1.15 Optional Accessories.....	17
1.16 Specifications .....	17



# 1. Operating Manual



## OPERATING MANUAL

MODEL  
MC401VE

## **DAIKIN** PHOTOCATALYTIC AIR CLEANER

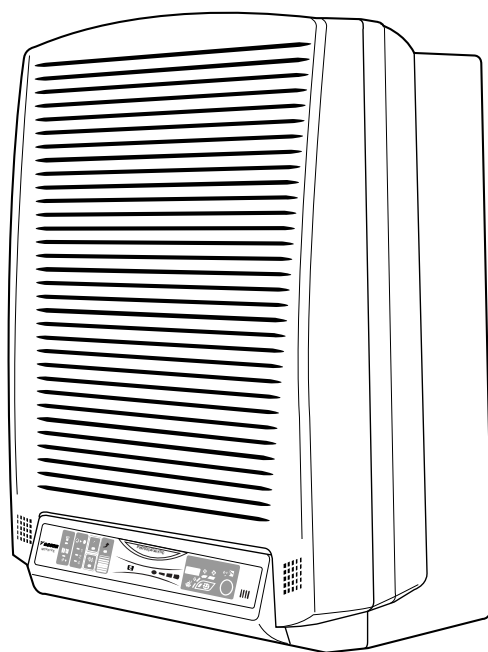

Thank you for purchasing this Daikin Air Cleaner.  
This instruction manual explains how to use the equipment and important safety precautions.  
**READ IT CAREFULLY BEFORE** using the equipment.  
Keep this manual handy for future reference.  
Your warranty is included in the product package. Check your warranty has been properly filled out by the place of purchase and keep it in a handy but safe place.

## 1.1 Names and Functions of Parts

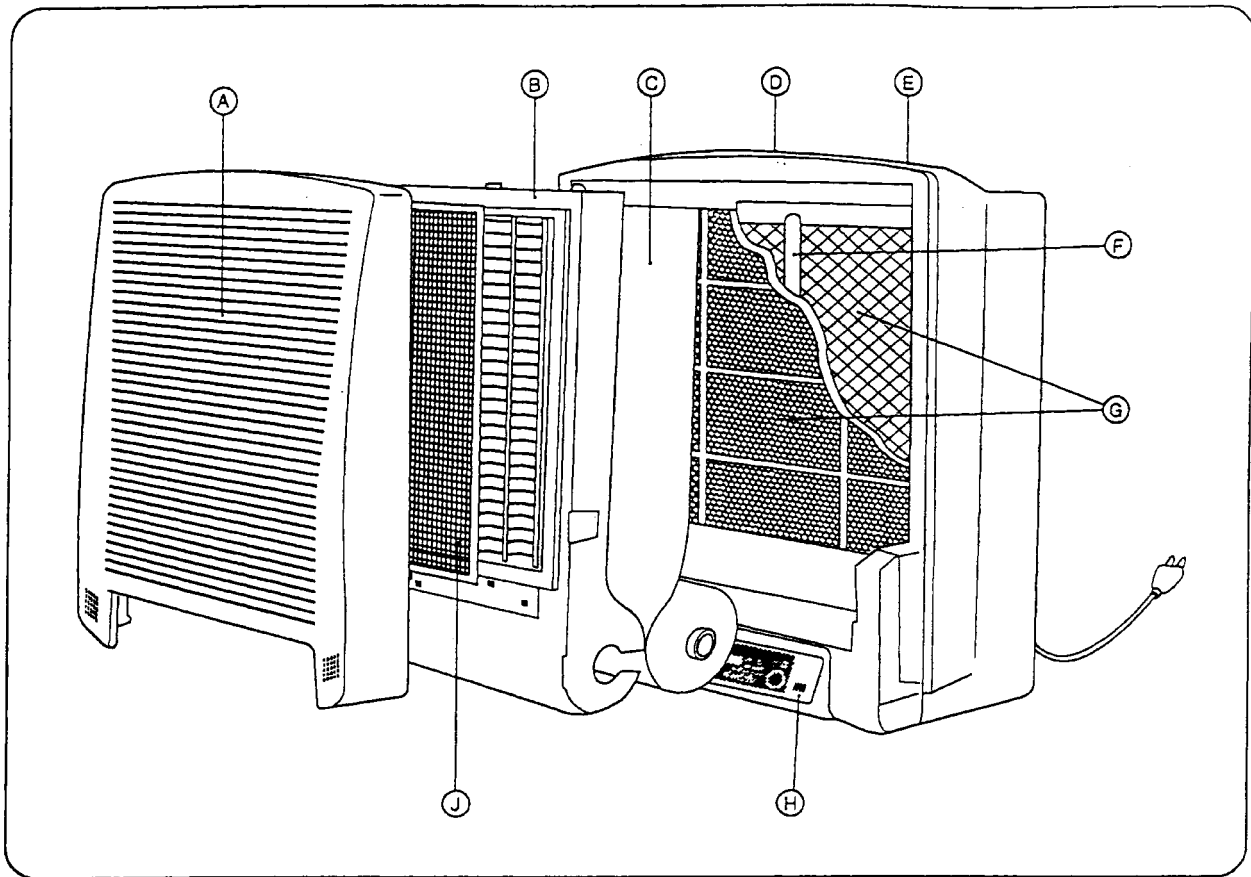

## 1.2 Indicator Lamps and their Functions

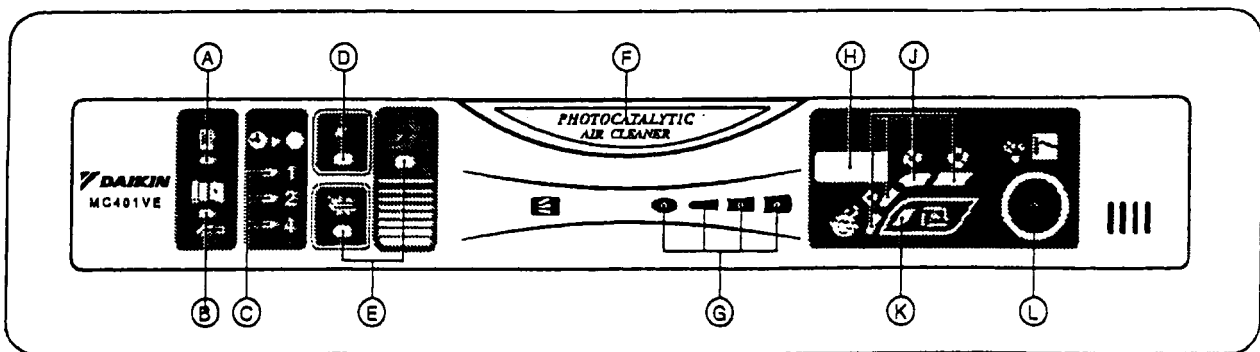

- |   |  |  |
|---|--|--|
| ① | <b>Photocatalytic deodorizing, bacteria removal and antiviral effect</b> | Eliminates odors 3 times faster than earlier models. |
| ② | <b>Plasma dust collection</b>  | Clears air of cigarette smoke and pollen.            |
| ③ | <b>7-year filter roll</b>  | Longer-lasting and less troublesome.                 |
| ④ | <b>Silent running</b>  | Just 34.5 dB in "High" mode. 16 dB in "Silent" mode. |
| ⑤ | <b>Energy-saving inverter</b>  | Great especially if you use it all day-long.         |

#### **Inverter lamp (Photocatalytic cleaning).**

The inverter lamp illuminates a photocatalyst which inactivates bacteria and viruses by high oxidation, thus minimizing the possibility of contamination. It also decomposes components which generate offensive odor in cigarette smoke, raw waste, exhaust gas (NOx), etc.

\* When used for the first time, the smell of the photocatalyst can be detected coming from the air outlet, but there is nothing wrong with the equipment. As the unit runs, the odor will be decomposed and eventually eliminated.

## 1.3 Accessories

Check the following accessories have been included in the product package.

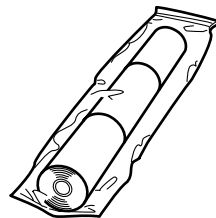

Filter roll  
(7 filters per roll)

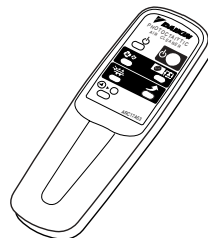

Wireless remote control

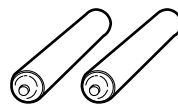

Batteries (AA × 2)

## 1.4 Tips for appropriate use

To remove house dust, set the unit near to the floor.

To remove cigarette smoke, install the unit high on a wall.

**Installing the air cleaner as shown below improves air circulation in the room.**

While heating or cooling the room, air can be cleaned and temperature fluctuation minimized.

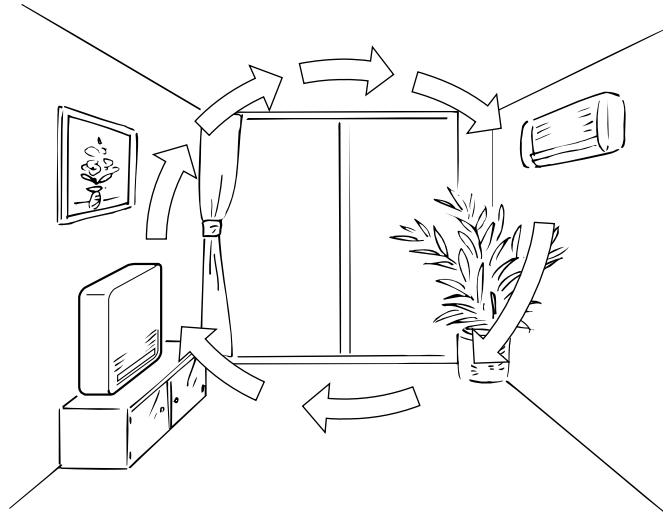

**Set operating mode as needed.**

**Auto** ..... Fan speed is controlled automatically depending on air quality. This mode ensures the most efficient operation.

**Manual (Fan speed)** ... Manual (Fan speed) - The unit runs independent of air quality. This mode is effective for regularly removing odors not readily detected by the odor sensor or quickly eliminating house dust in room air.

**Use the OFF timer appropriately to ensure the best room air quality when needed.**

If the OFF timer is set when leaving the room, the air is clean when you return. When cleaning the room, set fan speed to "High".

## 1.5 CAUTION

**Read this section carefully BEFORE using the equipment.**

**Do not use the power cable if it is damaged.**

Using a damaged power cable is extremely hazardous; if the power cord becomes damaged, you must obtain a replacement from the manufacturer or from a properly-authorized service agent.



**Do not use in humid places or places which might be wet, such as bathrooms.**

Contact with water can lead to electric shock or damage the equipment.



**Do not use outdoors or where exposed to direct sunlight.**

Direct sunlight can weaken remote control signal reception sensitivity and discolor the casing.



**Before changing filters, cleaning the equipment or moving it, turn it OFF and unplug the power cable.**

Working with power ON can lead to fire and/or electric shock.



**Do not disassemble, service or modify this equipment.**

Unwarranted tampering can lead to fire and/or malfunction.



**Do not wipe with benzene or thinner, or spray with insecticide.**

Such substances can cause cracking, electric shock and/or fire.



**Do not block the intake or outlet.**

Blocked openings can reduce capacity (air will not be cleaned throughout the entire room) and/or damage the equipment.



**Do not use near to sources of heat such as heaters.**

Heat can discolor and deform the casing.



**Do not use the power cable if damaged or loose in the socket.**

Using the power cable in anything but proper working condition can lead to short-circuits and subsequently electric shock and/or fire.



**Keep the unit and remote control minimum 2 m from lighting, TVs, radios, stereos and aerials.**

This unit can disturb TV pictures and generate interference. Illumination can weaken remote control signal reception sensitivity and discolor the casing.



**When used in conjunction with a humidifier, keep mist from being directly drawn into the unit.**

Mists can lead to electric shock and/or equipment damage.



**Do not use in the place of kitchen fans or cooker hood fans.**

Adverse conditions of use can shorten service-life of the prefilter and ion filter, as well as lead to equipment damage.



**Prevent combustibles (hair sprays, etc.), sparks and incense from being drawn into the unit.**

Such substances can cause fire.



**If not using the unit for long periods of time, unplug the power cable.**

Dielectric breakdown can lead to leakage current and subsequently electric shock and/or fire.



\* Keep this manual in a handy place so that anyone operating the equipment can refer to it quickly and easily. Ensure that anyone unfamiliar with the equipment reads this manual before handling the equipment.

## 1.6 Names and Functions of The Operating Section

**(A) Front panel**

**(B) Ion filter (roll) case**

Positively (+) charges minute dust particles not trapped by the prefilter.

**(C) Ion filter roll**

Working on the principle of electrostatic attraction, the negatively (-) charged filter catches and removes the positively (+) charged dust.

**(D) Air outlet**

**(E) Handle (on rear)**

**(F) Inverter lamp**

Activates the photocatalyst by illuminating it with light.

**(G) Photocatalyst**

Removes odors, bacteria and viruses when activated by the inverter lamp.

\* Do not subject the photocatalyst to excessive force. The inverter lamp located behind it will break.



**(H) Indicator lamps**

Display operating status. See page 9.

**(J) Prefilter**

Removes comparatively large dust particles.

## 1.7 Names and Functions of The Indicator Lamps

- (A) “Ionizer needs cleaning” lamp**  
Flashes when the ionizer is dirty. See page 14.
- (B) Time to cut filter lamp/Reset button**  
This lamp lights up when it is time to change the ion filter. After fitting a new filter, press  with ball-point pen, etc. See page 16.
- (C) Timer settings**  
The selected OFF timer setting is lit. As time elapses, the remaining time is displayed on the remote control. See page 12.
- (D) Auto power save lamp**  
The lamp lights up in the auto mode once air is clean. This mode is designed to cut electricity bills. See page 12.
- (E) Pollen/Turbo mode lamps**  
The corresponding lamp is lit when the unit is in either the pollen or Turbo mode. See pages 12.
- (F) Inverter lamp**  
Lit while the inverter lamp is ON. The lamp can be turned OFF from  on the remote control. See page 12.
- (G) Air Quality lamps**  
These lamps indicate how clean/dirty room air is.

Low odor intensity	Green
↓	Green Yellow
	Green Yellow Orange
High odor intensity	Green Yellow Orange Red

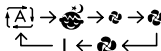
- Sharp fluctuations in temperature, humidity or odorless gases (carbon monoxide) can cause lamps to light up and go out.
  - In the following cases, the lowest odor intensity is indicated for 1 minute regardless of the true intensity. There is nothing wrong with the equipment.
    - Immediately after reattaching the front panel.
    - Immediately after plugging in the power cable.
- (H) Signal reception window**  
Signals from the remote controller are received through this window.
- (J) Fan speed lamp**  
The lamp under the set fan speed is lit. See page 12.
- (K) Auto mode lamp**  
Lit when the unit is in the auto mode. See page 12.
- (L) Mode selector (OFF) button**  
Every time the button is pressed, the mode switches as follows.
- 



# 1.8 Setup

## How to Fit the Ion Filter Roll.

### ⚠ CAUTION

**Always fit the prefilter and ion filter roll before use.**  
Use without filters can damage the equipment.

#### 1. Remove the front panel.

Hold the front panel by the sides, pull up and out.

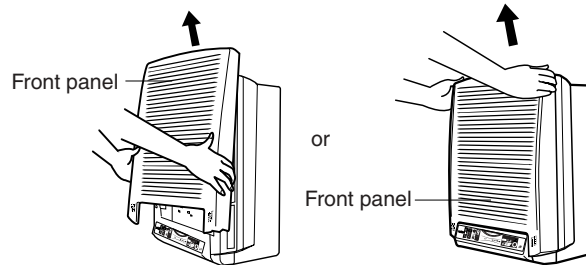

#### 2. Remove the ion filter (roll) case.

Hold the ion filter (roll) case by the left and right side handles, and lift upward and out.

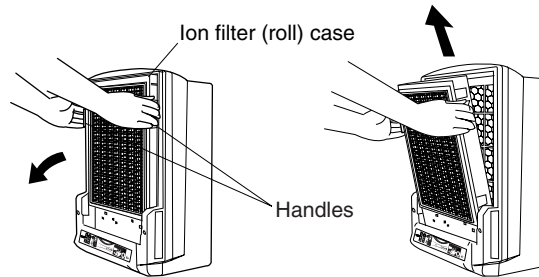

#### 3. Fit the filter roll.

① Face the ion filter (roll) case downwards as shown below and fit the filter roll in the cutouts for the filter spool.

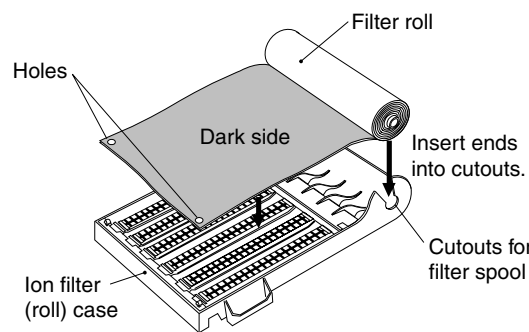

② Fit the holes on leading edge over the pegs on both sides of the case.

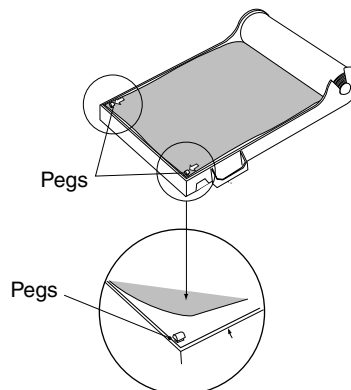

## 1.9 Installation

### Selecting an Installation Site.

The unit can be place on a flat surface such as a desk.

<To place on a desk>

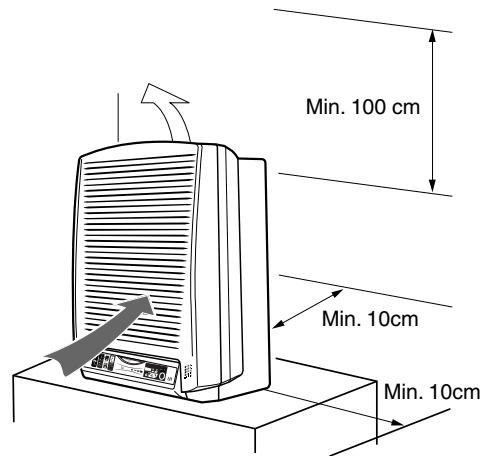

△Select a wall, shelf or floor that is sturdy enough to support the unit.

The unit weighs 6.9 kg.

△Select a location that blows air across the entire room.

For installation tips, see “Tips for appropriate use” page 6.

### How to Mount on Walls

1. Fit the power cable snugly in the cable rest. Also, bundle up any excess cable with a tie band.

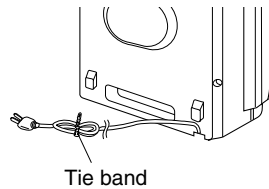

Tie band

2. To prevent falling in the event of an earthquake, the unit can be rigged with a safety wire as shown below.

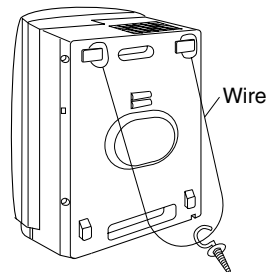

Wire

# 1.10 How to Operate the Unit









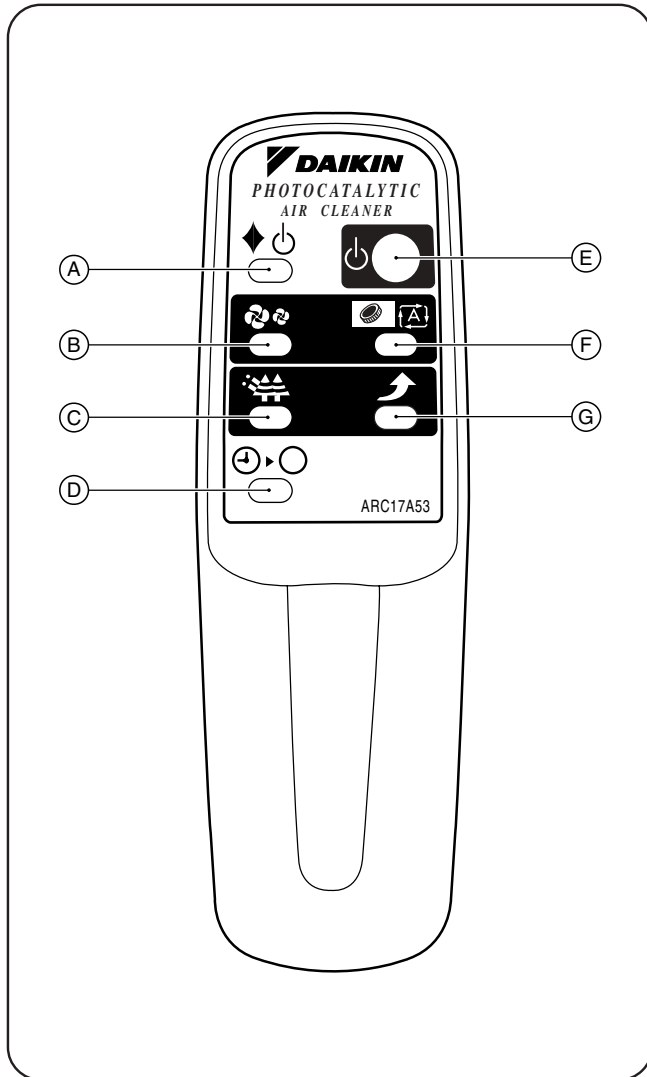

Before attempting to use the unit, plug the power cable into a single phase 220 – 240 V/220 V (50/60 Hz) socket.

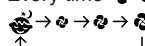
**Note**

For the first 2 seconds after the front panel has been reattached or the power cable plugged in, the unit does not respond to remote controller commands - not even the buttons in .

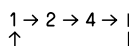
The buttons and their functions are explained below.



- (A) To turn the lamps ON/OFF**  
 Pressing  turns the inverter lamp ON and OFF. Turn the lamp OFF if light from the front panel is disturbing, for example at night. If left OFF, deodorizing and antiviral performance is reduced.
- (B) To set fan speed manually**  
 Every time  is pressed, fan speed changes as follows.  
  
 The fan starts at the last set fan speed.  
 When "" is selected, the fan turns slowly enough not to disturb people in their sleep.
- (C) To remove pollen**  
 Press  once to remove pollen from room air effectively. The unit will repeatedly switch between 5 minutes at normal speed and 5 minutes at low speed.  
 Press  again to turn the pollen mode OFF.
- (D) To set the OFF timer**  
 Every time  is pressed, the OFF timer setting changes as follows.  
  
 When the set time elapses, the unit shuts OFF automatically. The setting can be changed at any time even while the unit is running.
- (E) To start/stop the unit**  
 The first time  is pressed, the unit starts up. The next time, it turns OFF.
- (F) To set fan speed automatically**  
 Press . Fan speed is selected automatically - Quiet, Low, Normal, High - depending on air quality.
- (G) To remove cigarette odors and smoke effectively**  
 Press  once to remove cigarette odors and smoke from room air rapidly. The unit will run for 30 minutes at especially high speed and will then switch to auto fan speed control.  
 Press  again to turn OFF the turbo mode.
- (H) To turn OFF air quality lamps**  
 Turn the air cleaner OFF before pressing this button when you want to turn OFF the lamps.

**To operate the unit from the front panel**

The unit can be operated from the front panel instead of the remote control. Pressing the  selects operating mode and turns the unit OFF. See page 4.

**If the unit malfunctions**

If, during electrical storms or because of radio communications, the front panel lamps light irregularly, if the unit cannot be operated from the remote controller or if some other problem occurs, unplug the power cable for a moment, then plug it back in and restart the unit.

## 1.11 How to Clean the Prefilter

When to clean ... Once every 2 weeks or so.

### 1. Stop the unit and remove the power cable from its socket.

### 2. Remove the front panel.

Hold the front panel by the sides, pull up and out.

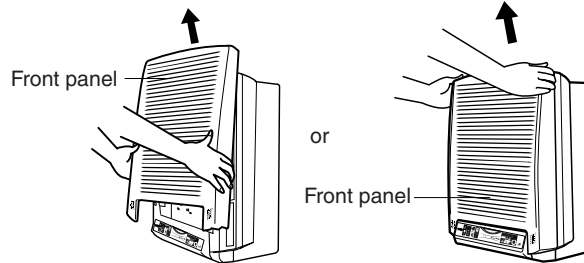

### 3. Remove the prefilter.

Take the prefilter by the top and pull up and out.

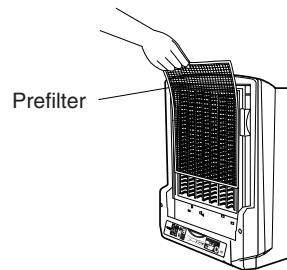

### 4. Clean the prefilter.

Remove dirt with a vacuum cleaner or by other means, and then rinse the filter under plain water.

For stubborn dirt,  
clean with a soft  
brush or neutral  
detergent.



Shake off water  
and dry in a dark  
place.

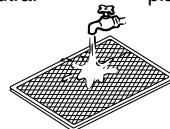

#### Note

Do not rinse in water 50°C or higher. Hot water will discolor and deform the filter beyond usable limits.

Keep away from fire and sources of heat. High temperatures will discolor and deform the filter beyond usable limits.

## 1.12 How to Clean the Front Panel

When to clean ... Whenever necessary If using the unit where the front panel is easily dirtied, clean the front panel more frequently.

Vacuum up dust with the small nozzle attachment of your vacuum cleaner.

For stubborn dirt, clean the front panel with a neutral household detergent. Thoroughly blot up all detergent and dry in a dark place.

#### Note

Do not use gasoline, benzene, thinner, polish, kerosene or other chemicals. Such chemicals can discolor or deform the front panel. Do not use metal wire brushes or other hard implements. Such implements can scratch the front panel.

## 1.13 How to Clean the Ionizer

If  (see page 4) on the front panel begins to flash, clean the ionizer.

- 1. Stop the unit and remove the power cable from its socket.**
- 2. Remove the front panel.**  
See step 2 on page 13.
- 3. Remove the ion filter (roll) case.**  
Hold the ion filter (roll) case by the left and right side handles, and lift upwards and out.

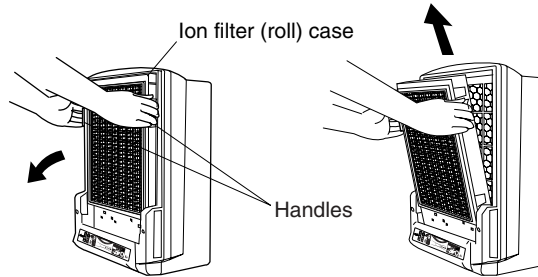

- 4. Remove the prefilter.**  
See step 3 on page 13.
- 5. Remove the ionizer.**  
Press the tabs as shown below until lifting the ionizer slightly, then pull towards you and out.

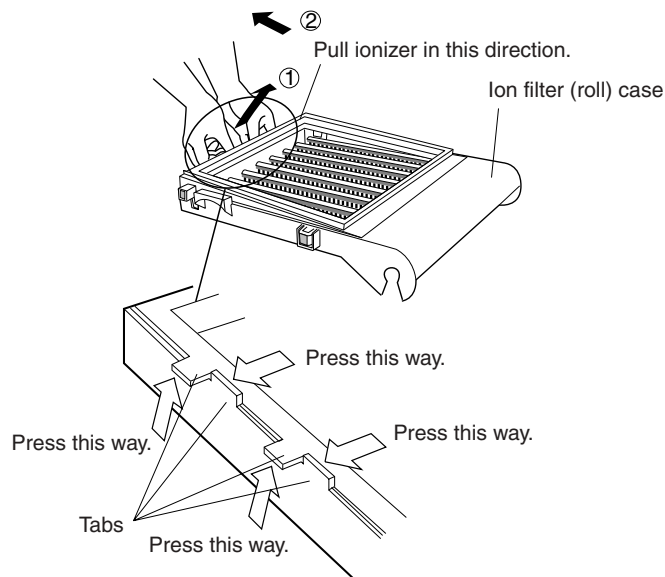

## 6. Remove the ion filter roll.

## 7. Clean the ionizer.

- How to clean the case  
Remove dirt with a vacuum cleaner or by other means, and then rinse the filter under plain water.

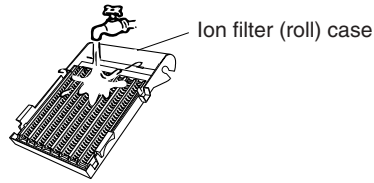

For stubborn dirt, wipe or soak in a neutral household detergent. Use a soft cloth or soft bristle brush. **Thoroughly rinse off all detergent and dry in a dark place.**

### Note

- Remove all lint after cleaning.
- Do not use acidic or alkaline detergent. Strong detergents can lead to rusting.

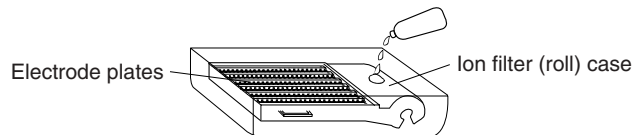

- How to clean the ionizer  
Wipe the electrode plates and nearby plastic parts with a soft cloth moistened with water or a wet tissue.

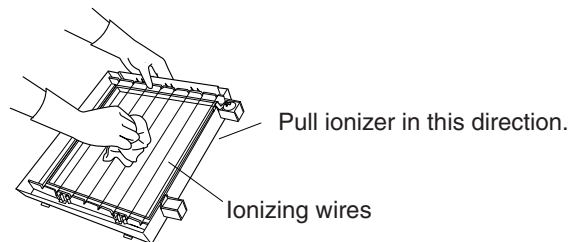

### Note

- When cleaning the ionizer, always wear rubber gloves to prevent cutting on the ionizing wires.
- Wipe ionizing wires from the backside of the ionizer. Wires can come loose if pulled on from the front.
- Be careful not to break the ionizing wires. If somehow broken, contact the place of purchase or Daikin's Customer Service Center for replacements. If the unit is used with broken ionizing wires, the Clean Ionizer lamp will flash.
- After cleaning, thoroughly dry the ionizer. Using the unit with the ionizer still wet can damage the unit.

**8. Reattach the ionizer to the ion filter (roll) case.**

- ① Insert the pegs on the ionizer into the holes on the ion filter (roll) case.
- ② Snap the ionizer onto the case.

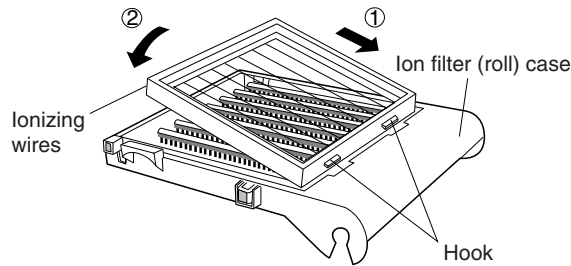

**Ionizer seen from backside**

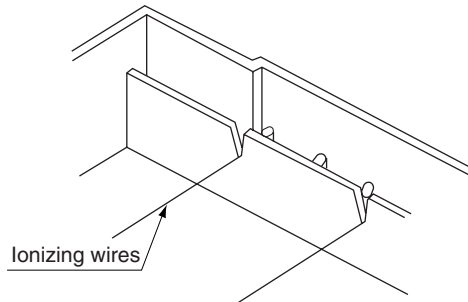

**Note**

- Check the ionizing wires are not loose or broken.

## 1.14 How to Change the Ion Filter (Roll)

If  (see page 4) on the front panel lights up, change the ion filter. When the ion filter needs to be changed will depend on the conditions of use.

If the unit is used where air is dirty, the ion filter will need changing more frequently. Consider changing the filter once a year.

- 1. Stop the unit and remove the power cable from its socket.**
- 2. Remove the front panel.**  
See step 2 on page 10.
- 3. Remove the ion filter (roll) case.**

Hold the ion filter (roll) case by the left and right side handles, and lift upwards and out.

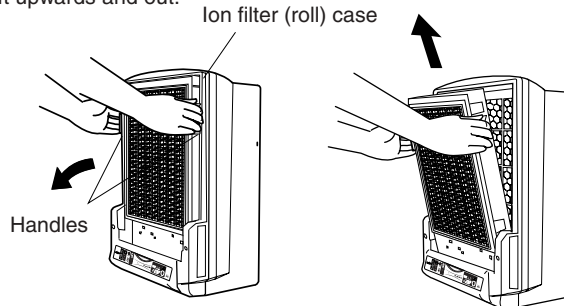

**4. Cut the ion filter.**

- Ⓐ Pull the ion filter off the 2 pegs on the case.

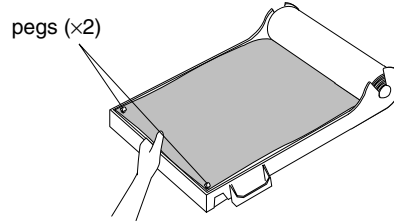

- Ⓑ Unroll the ion filter until the slits in the leading edge of the next filter sheet can be fitted over the pegs on the case.

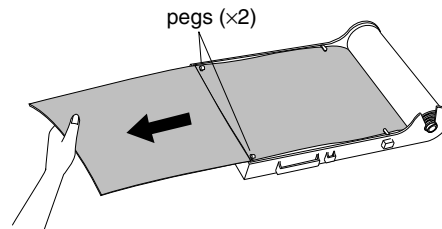

- Ⓒ Tear the old filter sheet off at the perforated line.

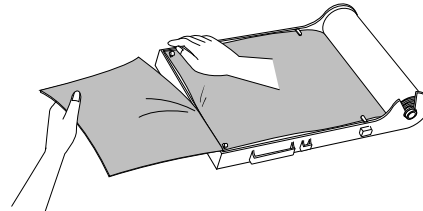
**5. Attach the ion filter (roll) case to the unit.**

See step 3.

**6. Replace the front panel on the unit.**

See step 2 on page 10.

**7. Plug the power cable into its socket.****8. Press the Reset button on the front panel.**

Use a ball-point pen or other pointed object. Check the Change Ion Filter lamp goes out. A short acoustic buzzer can be heard when the sensor is reset.

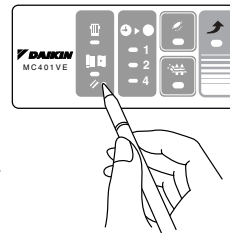

## 1.15 Optional Accessories

**Replacement ion filter rolls can be obtained from your supplier.**

Model	Model Number
MC401VE	KAC15A

## 1.16 Specifications

Model	MC401VE
Required power supply	220-240/220 50/60Hz
Outer dimensions	425 × 500 × 225
Rated power consumption (W)	41/41
Air blow rate (m <sup>3</sup> /min)	High speed 4.0 Normal speed 3.0 Quiet 0.6 Low speed 2.0
Applicable room area	~ 40m <sup>2</sup>
Weight	6.9





# Part 2

# Troubleshooting

1. Troubleshooting .....	20
1.1 Equipment does not Operate.....	20
1.2 Indicator does not Change from "Dirty" to "Clean" .....	22
1.3 Remote Controller Fails to Operate Equipment.....	23
1.4 Photocatalytic Operation does not Activate.....	24

# 1. Troubleshooting

## 1.1 Equipment does not Operate

**Method of Malfunction Detection**

**Malfunction Decision Conditions**

Equipment cannot be operated by remote controller or switch on main unit.

**Supposed Causes**

- Faulty door switch (safety switch assembly)
- Blown fuse
- Faulty printed circuit board (control PCB assembly, display PCB assembly)

**Troubleshooting**



**Caution**

Be sure to turn off power switch before connect or disconnect connector, or parts damage may be occurred.

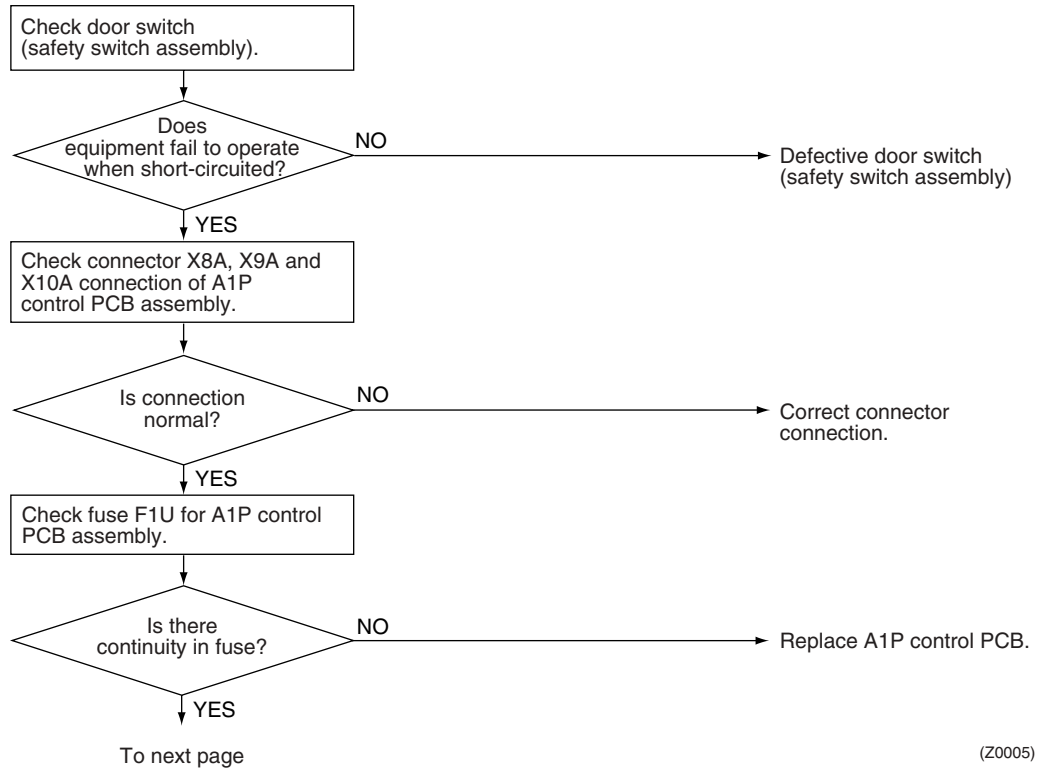

(Z0005)

## Troubleshooting

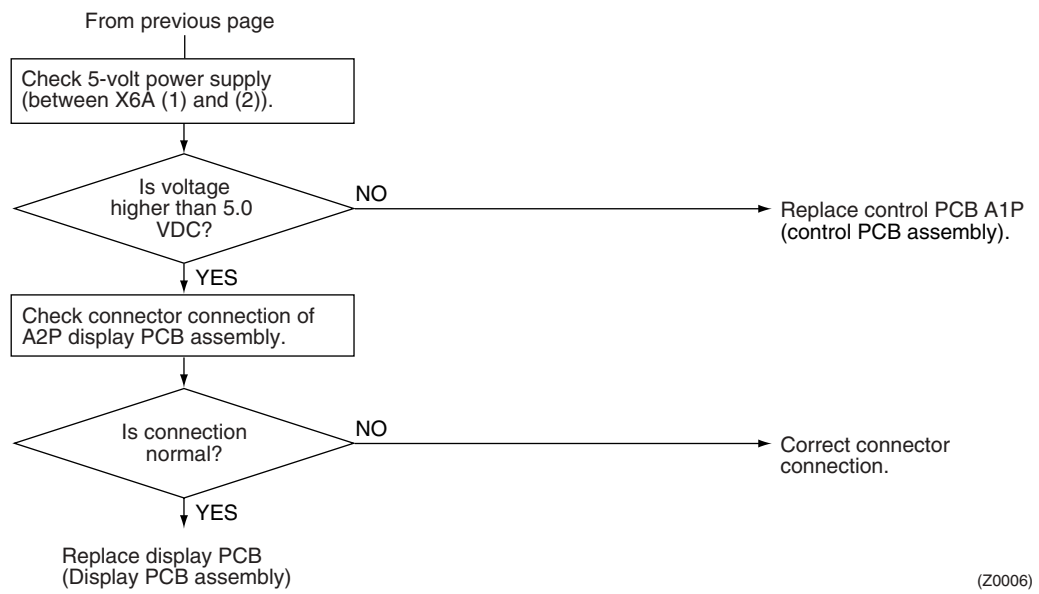

# 1.2 Indicator does not Change from "Dirty" to "Clean"

**Method of Malfunction Detection**

**Malfunction Decision Conditions**

Air contamination indicator does not change to "clean" even when equipment is operated in ventilated room for a whole day.

**Supposed Causes**

- Faulty harness
- Faulty sensor

**Troubleshooting**

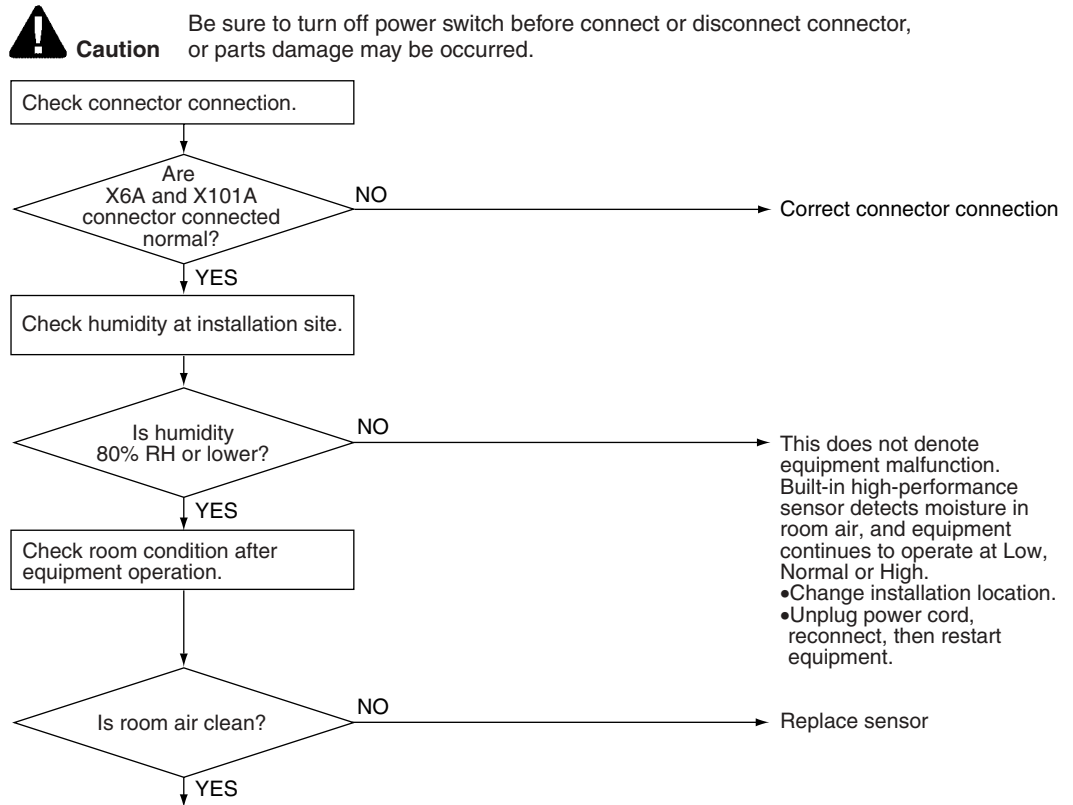

This does not denote equipment malfunction. When the room is too large for the unit's capacity, the indicator may still indicate "dirty" after smoke is removed. This is caused by the high-performance sensor detecting slight contamination in the room.

(Z0007)

## 1.3 Remote Controller Fails to Operate Equipment

### Method of Malfunction Detection

### Malfunction Decision Conditions

Switches on main unit work properly, but remote controller fails to operate equipment.

### Supposed Causes

- Noise generated by fluorescent lamps
- Faulty remote controller
- Faulty PCB

### Troubleshooting



#### Caution

Be sure to turn off power switch before connect or disconnect connector, or parts damage may be occurred.

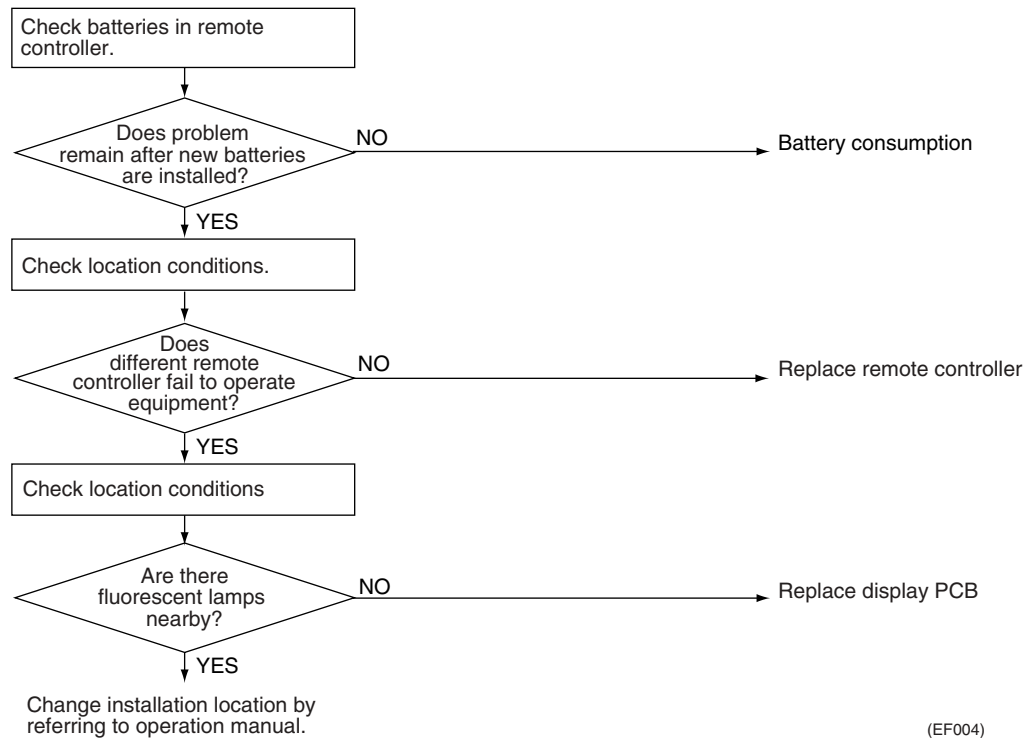

# 1.4 Photocatalytic Operation does not Activate

**Method of Malfunction Detection**

**Malfunction Decision Conditions**

Photocatalytic operation does not activate during equipment operation (lamp does not light).

**Supposed Causes**

- Faulty lamp
- Faulty transformer
- Faulty PCB

**Troubleshooting**

**! Caution** Be sure to turn off power switch before connect or disconnect connector, or parts damage may be occurred.

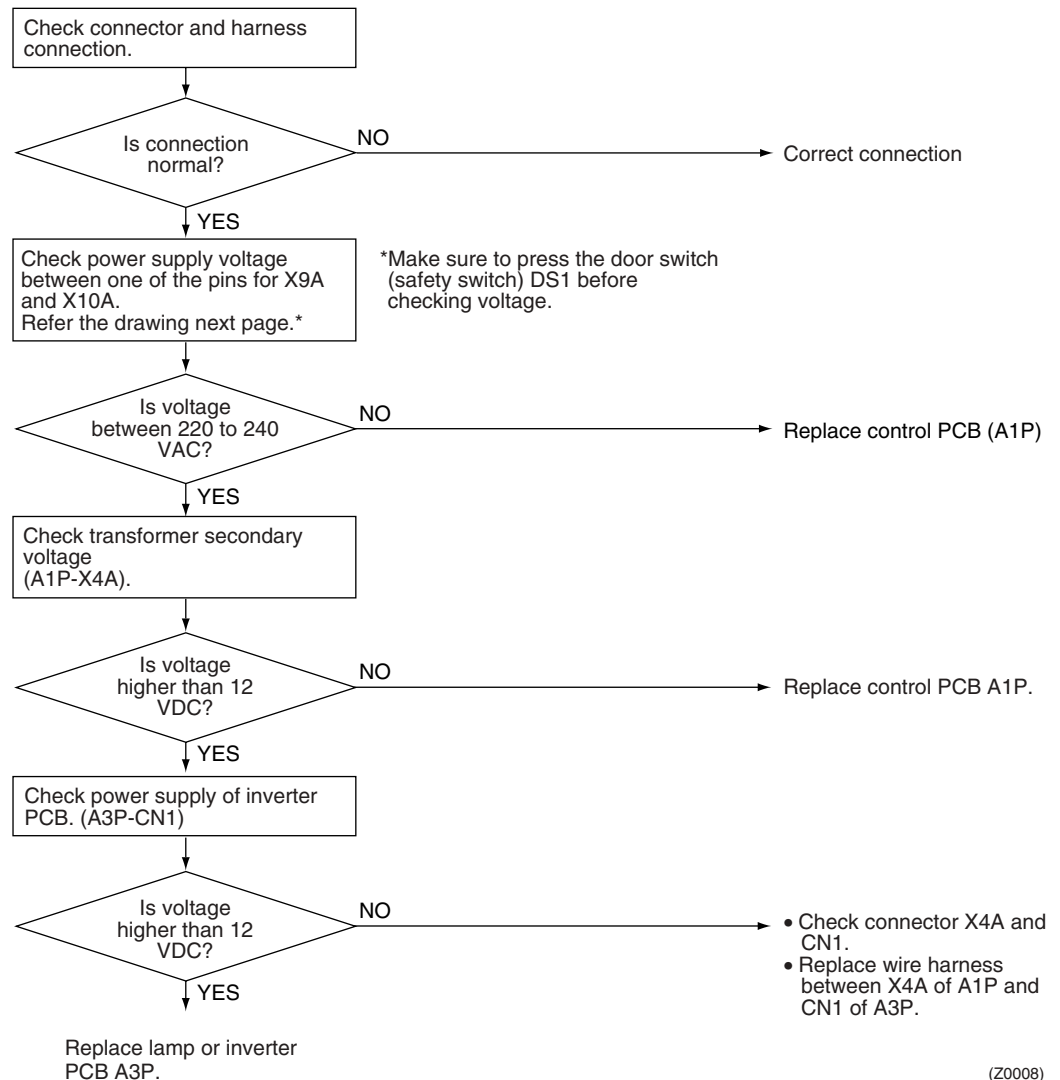

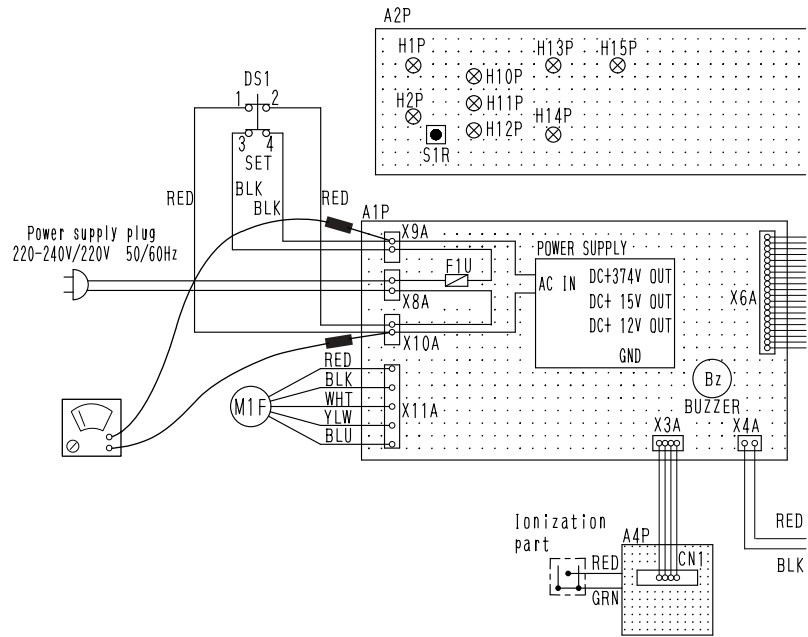

Power supply voltage check





# Part 3

## Removal Procedure

1. Removal Procedure of MC401VE .....	28
1.1 Removal of External Accessories.....	28
1.2 Removal of Ionizing Wire.....	30
1.3 Removal of Electrical Parts (Inverter Lamp).....	31
1.4 Removal of PCB.....	34
1.5 Removal of Fan Motor.....	36
1.6 Removal of Safety Switch.....	37

# 1. Removal Procedure of MC401VE

## 1.1 Removal of External Accessories

**Procedure**



**Warning**

Be sure to turn off all power supplies before disassembling work

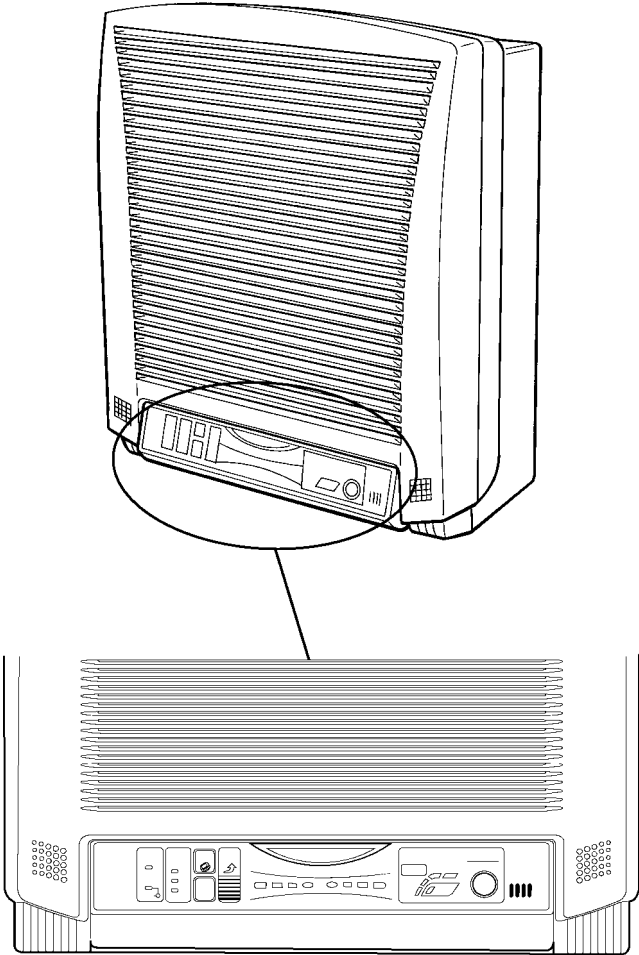
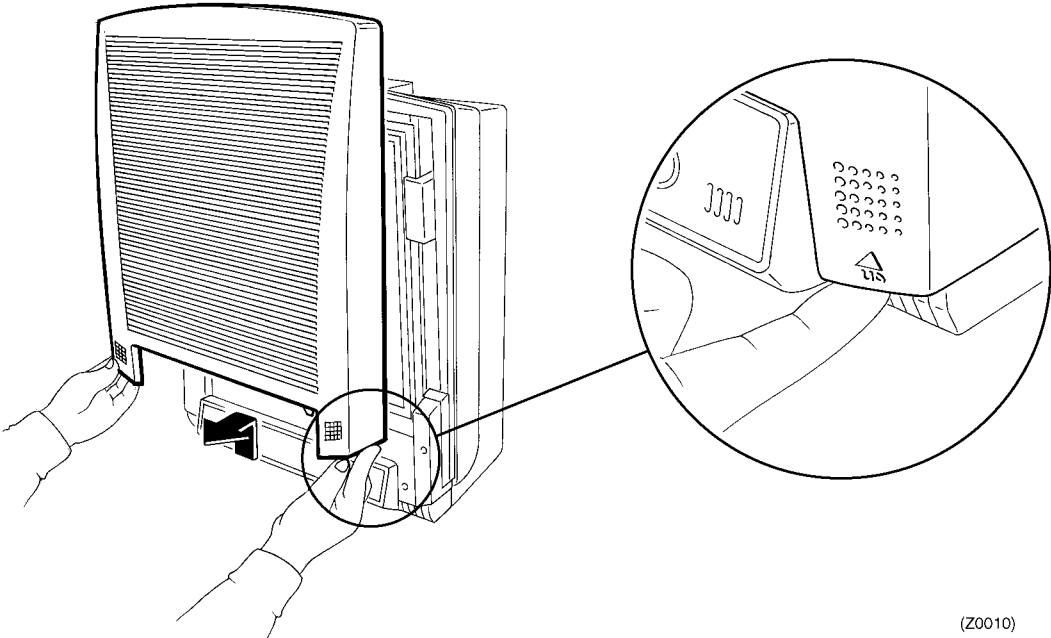
Step	Procedure	Procedure	Points
1	External appearance	 <p style="text-align: right;">(Z0009)</p>	
2	Remove front panel.	 <p style="text-align: right;">(Z0010)</p>	

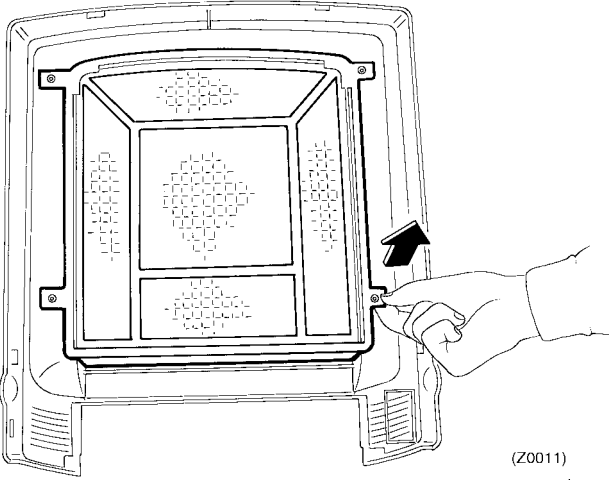
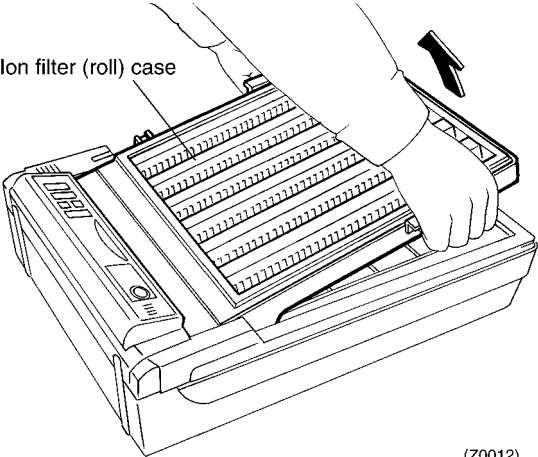
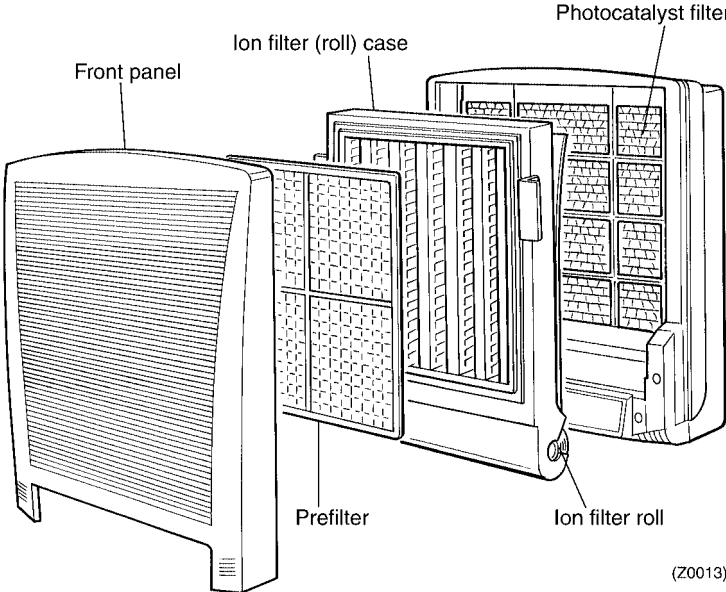
Step	Procedure	Points
3	<p>Disengage hooks located at four corners of the filter to remove prefilter located at rear side of the front panel.</p>  <p>(Z0011)</p>	
4	<p>Hold the ion filter (roll) case by the left and right side handles, and lift upward and out.</p>  <p>(Z0012)</p>	
5	<p>Main components</p>  <p>(Z0013)</p>	

## 1.2 Removal of Ionizing Wire

**Procedure**



**Warning**

Be sure to turn off all power supplies before disassembling work

Step	Procedure	Points
<p>1 Press the hook and lift the ionizing wire slightly upwards and pull it to remove.</p>	<p>(Z0014)</p>	
<p>2 Install the ionizing wire as shown on the right.</p>	<p>(Z0015)</p>	
<p>3 Remove the ionizing wire.</p>	<p>(Z0016)</p>	<p> <b>Caution</b> Be careful not cut your hands by the ionizing wire.</p>

## 1.3 Removal of Electrical Parts (Inverter Lamp)

### Procedure



### Warning

Be sure to turn off all power supplies before disassembling work

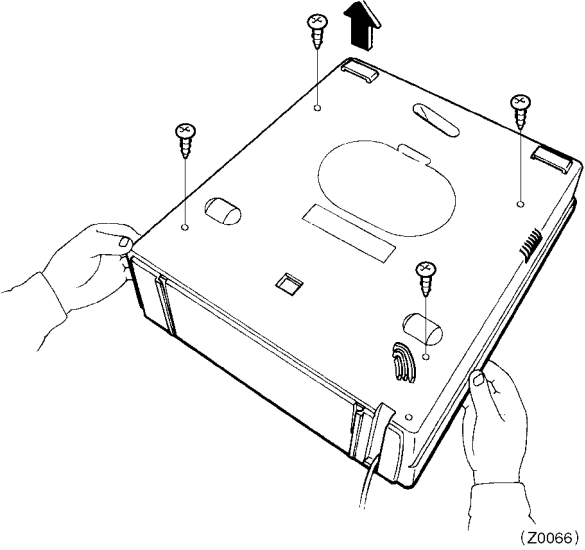
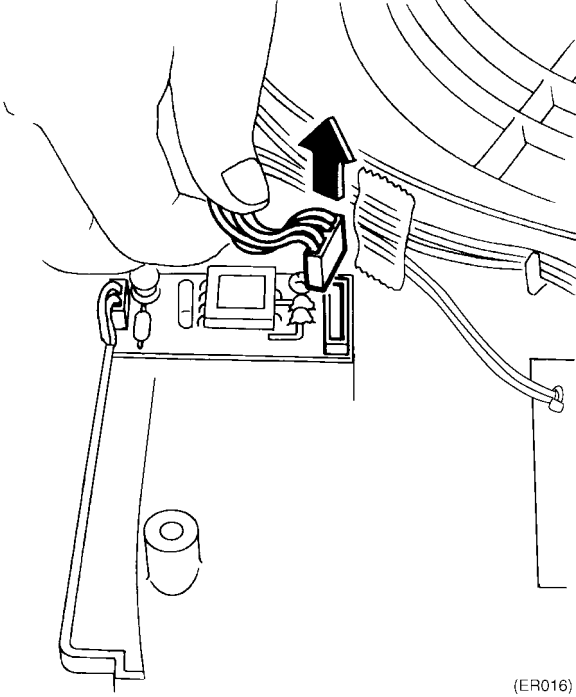
Step	Procedure	Procedure	Points
1	Turn main body over, then remove back panel.	 <p>(Z0066)</p>	
2	Disconnect CN12 connector located at bottom left of main body rear side.	 <p>(ER016)</p>	

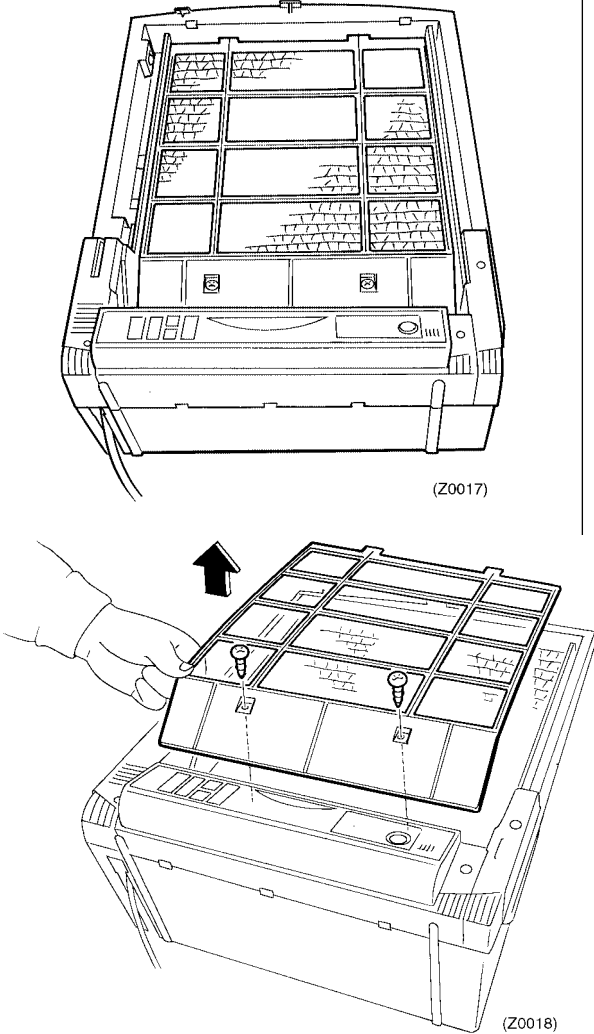
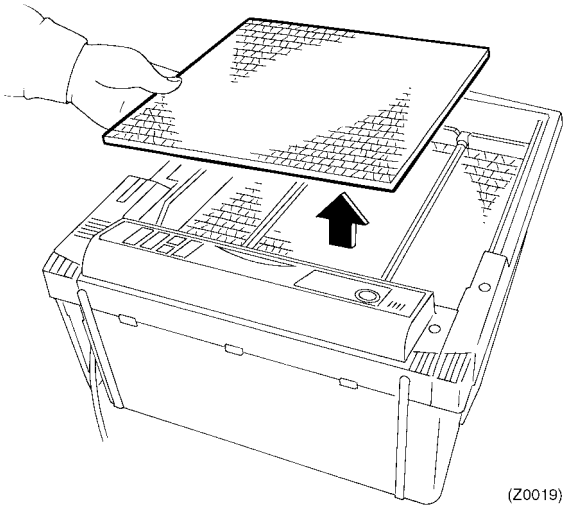
Step	Procedure	Points
<p>3 Remove the photocatalyst filter retainer by unscrewing two screws.</p>	 <p>(Z0017)</p> <p>(Z0018)</p>	
<p>4 Remove the photocatalyst filter.</p>	 <p>(Z0019)</p>	

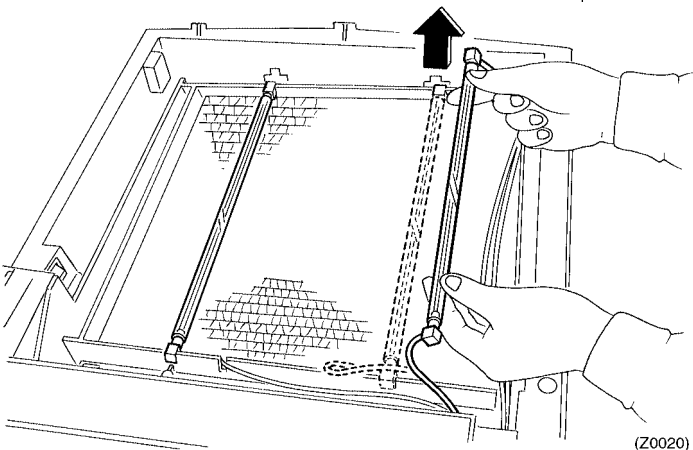
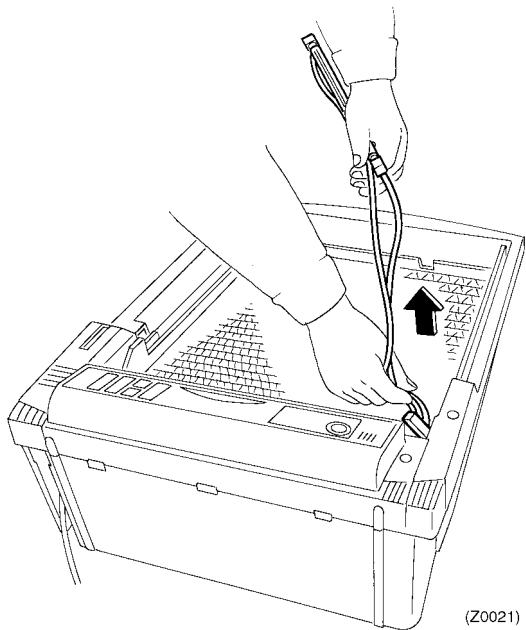
Step	Procedure	Points
5	<p>Remove inverter lamps.</p>  	



# 1.4 Removal of PCB

**Procedure**



**Warning**

**Be sure to turn off all power supplies before disassembling work**

Step	Procedure	Points
<p>1</p> <p>Unscrew two screws at the both side of the main body.</p> <p>Disengage 6 hooks.</p>	<p style="text-align: right;">(Z0022)</p>	
<p>2</p> <p>Disengage the 6 hooks to remove display PCB.</p>	<p style="text-align: right;">(Z0023)</p>	

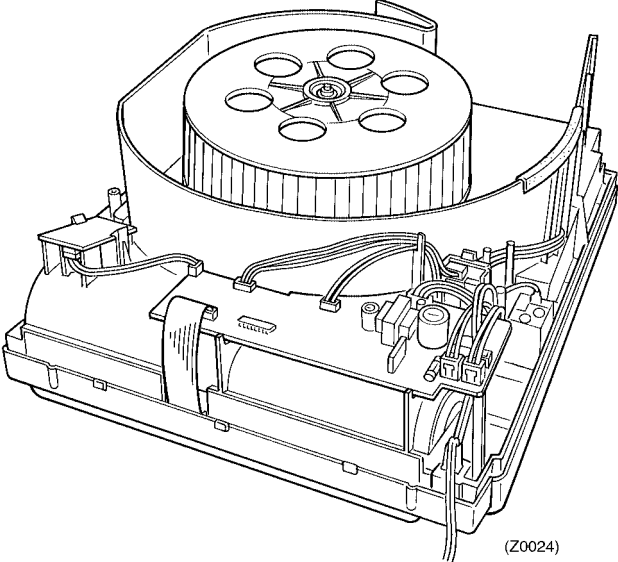
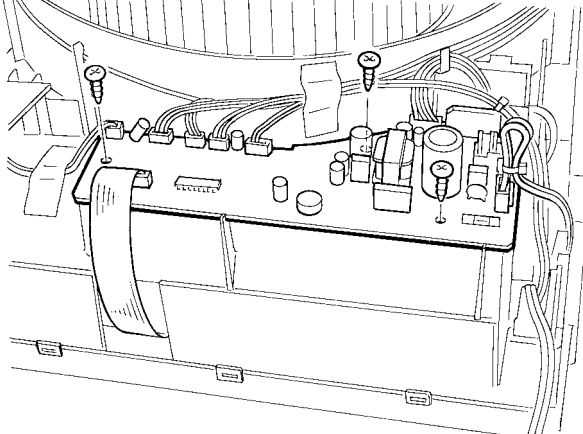
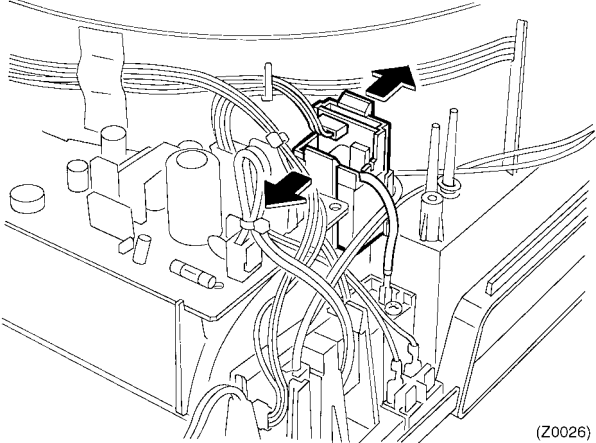
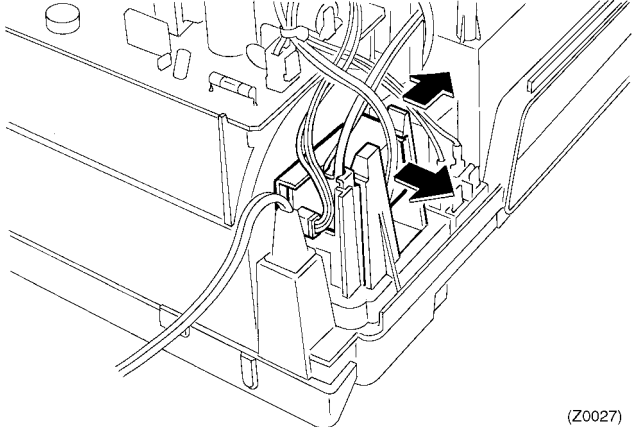
Step	Procedure	Points
<p>3</p>	<p>Remove the control PCB by unscrewing three screws.</p>    	

# 1.5 Removal of Fan Motor

**Procedure**



**Warning**

**Be sure to turn off all power supplies before disassembling work**

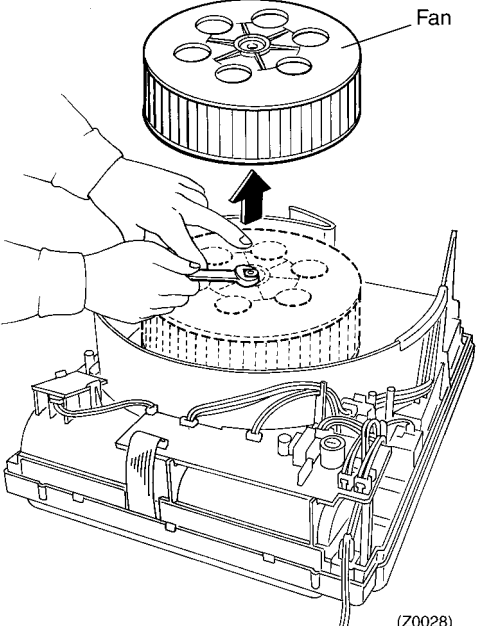
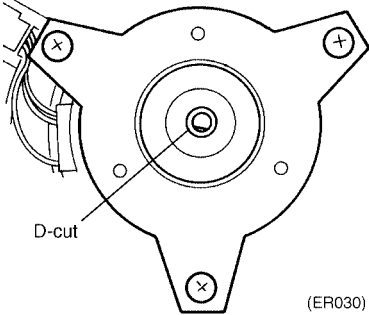
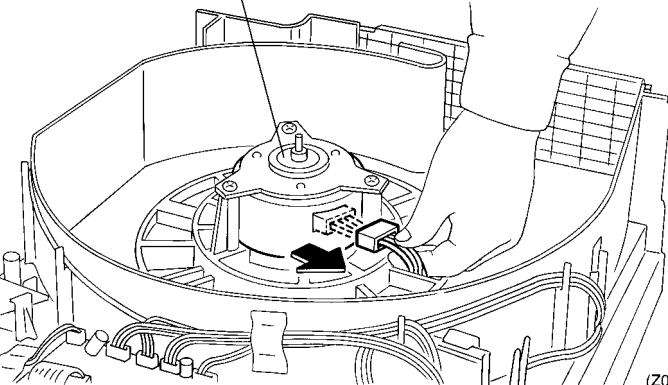
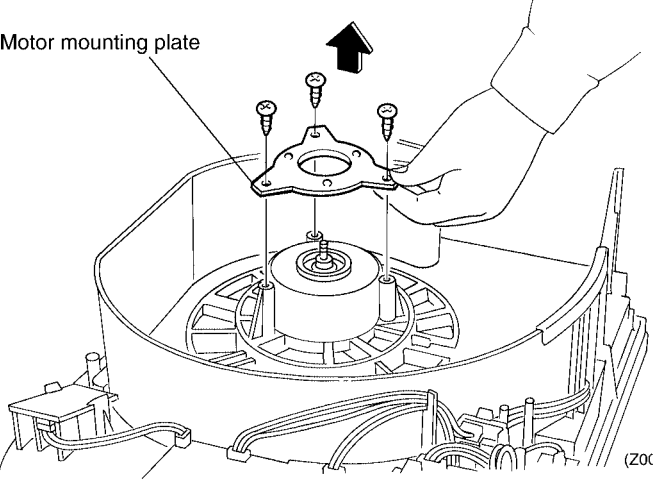
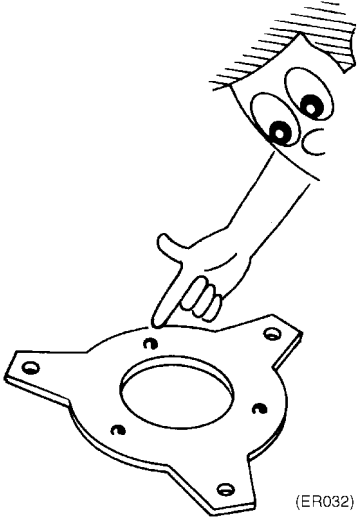
Step	Procedure	Procedure	Points
1	Remove back panel to remove fan securing nut.	 <p>(Z0028)</p>	<p><b>Caution</b> When reassembling fan, match the D-cut direction of fan and shaft.</p>  <p>(ER030)</p>
2	Disconnect connector.	 <p>(Z0029)</p>	
3	Remove three screws on motor mounting plate.	 <p>(Z0030)</p>	<p><b>Caution</b> When installing motor mounting plate, put the surface with protrusions up side.</p>  <p>(ER032)</p>

## 1.6 Removal of Safety Switch

### Procedure



### Warning

Be sure to turn off all power supplies before disassembling work

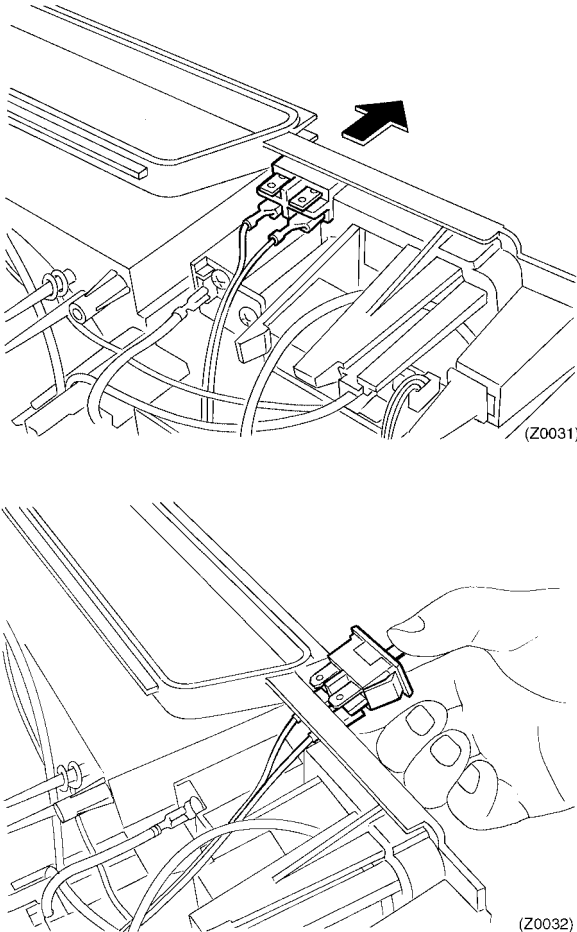
Step	Procedure	Procedure	Points
1	To remove safety switch, push it out from back side.	 <p>(Z0031)</p> <p>(Z0032)</p>	



# Part 4

## Reference Data

1. Wiring Diagram .....	40
1.1 MC401VE .....	40
2. Parts List .....	41
2.1 Parts Illustration.....	41
2.2 Parts List.....	42

# 1. Wiring Diagram

## 1.1 MC401VE

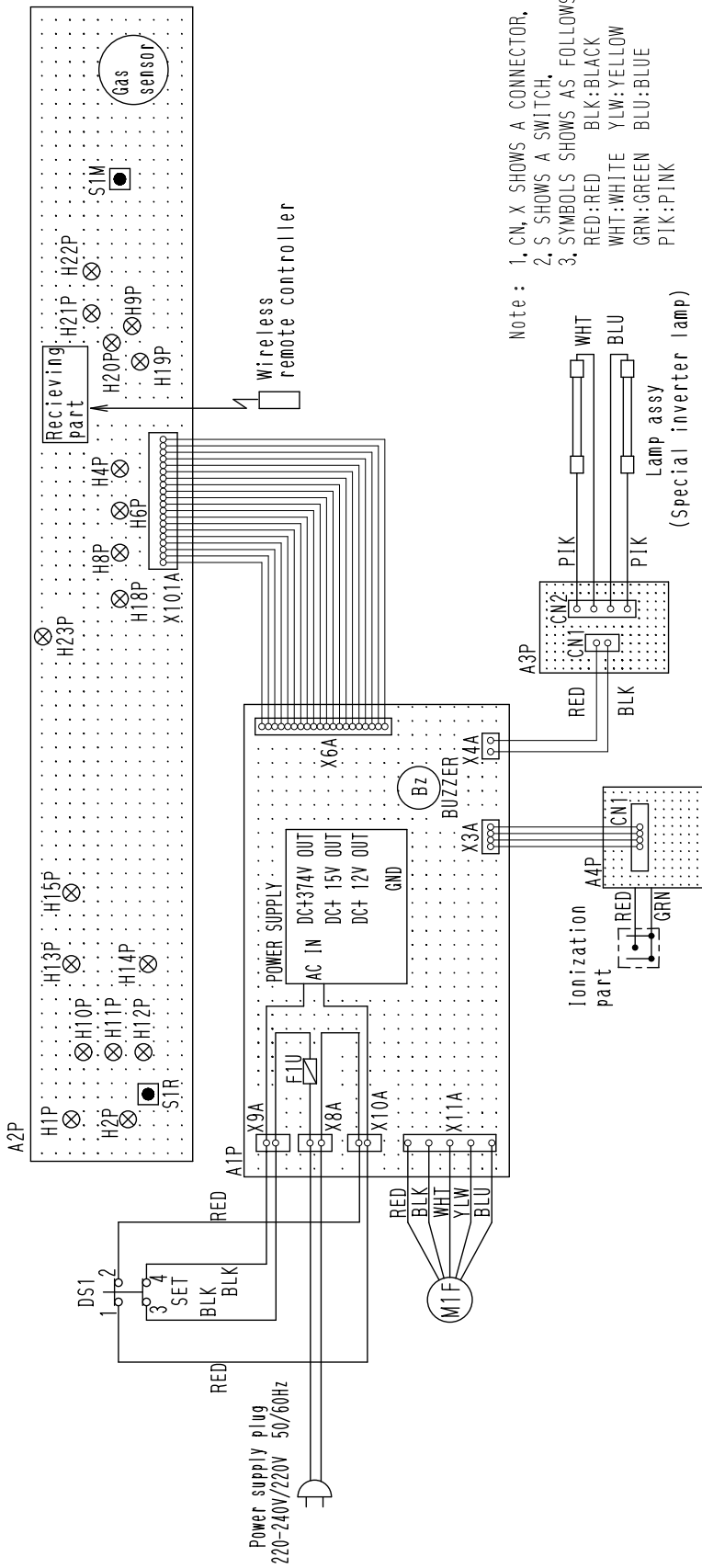

A1P	PRINTED CIRCUIT BOARD (FOR CONTROL)	H2P	LED(FILTER CUT OFF:RED)	H15P	LED(TURBO:GREEN)
A2P	PRINTED CIRCUIT BOARD (FOR INDICATION)	H4P	LED(AIR QUALITY:RED)	H18P	LED(AIR QUALITY:GREEN)
A3P	PRINTED CIRCUIT BOARD (FOR COLD CATHODE TUBE INVERTER)	H6P	LED(AIR QUALITY:ORANGE)	H19P~H22P	LED(AIR QUANTITY:GREEN)
A4P	PRINTED CIRCUIT BOARD (FOR HIGH VOLTAGE POWER SUPPLY UNIT)	H8P	LED(AIR QUALITY:YELLOW)	H23P	LED(PHOTO OPERATION LAMP:BLUE)
DS1	SAFETY SWITCH	H9P	LED(AUTO OPERATION:YELLOW)	M1F	FAN MOTOR
F1U	FUSE(250V, 3, 15A)	H10P~H12P	LED(CUT OFF TIMER:GREEN)	S1M	MAIN SWITCH
H1P	LED(CLEANING OF IONIZATION PART:RED)	H13P	LED(SAVING ENERGY:GREEN)	S1R	RESET SWITCH
		H14P	LED(POLLEN:GREEN)		

3D027638

# 2. Parts List

## 2.1 Parts Illustration

MC401VE

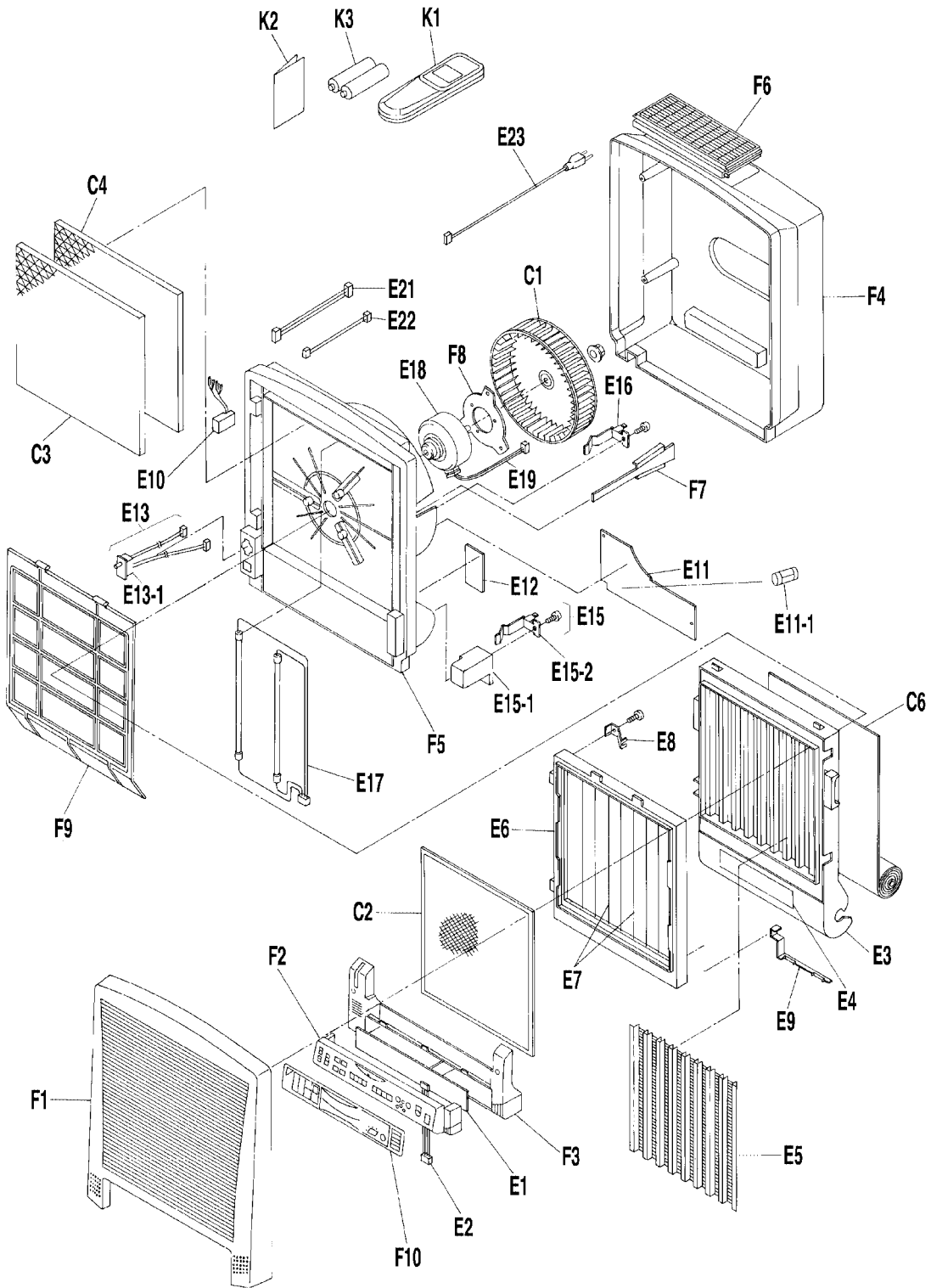



## 2.2 Parts List

### MC401VE

No.	Index	Parts No.	Parts Name	Drwg. No.	Parts Model	Specification	Q'ty/Unit	Wiring Symbol	Notes
							MC401VE		
C1		1127201	SIROCCO FAN ASS'Y	3P040480-2			1		
C2	A	1119541	PRE-FILTER	3P040468-1			1		
C3	A	1119565	AIR FILTER	3P037627-1			1		
C4	A	1119572	AIR FILTER	3P037627-2			1		
C6	A	1204038	ROLL FILTER ASS'Y	4P056567-2			1		
E1	A	1204184	PRINTED CIRCUIT BOARD (DISPLAY)	2P057722-1	EH0004		1	A2P	
E2		1127218	WIRE HARNESS (FOR DISPLAY)	4P041558-1			1		
E3		1127225	CASING, ROLL FILTER	1P040619-1			1		
E4		1083301	OPERATION PLATE	4P031138-1			1		
E5	A	1127249	ELECTRODE PLATE	3P041555-1			1		
E6		1127256	IONIZER WIRE SET FRAME	1P040616-1			1		
E7	A	1126479	IONIZER WIRE ASS'Y	4P042943-1			2		
E8	B	1127263	SPRING (GROUND WIRE)	4P041556-1			1		
E9	B	1127270	SET PLATE, IONIZER WIRE	3P041721-1			1		
E10	A	1101603	PRINT CIRCUIT (HIGH VOLTAGE)	3P041572-1	ECXC3018		1	A4P	
E11	A	1194559	PRINTED CIRCUIT (CONTROL)	2P057721-1	EH0003		1	A1P	
E11-1	A	0509002	FUSE	3EB82010-1		3.15A 250V D5.2XL20	1	F1U	
E12	A	1187359	PRINT CIRCUIT BOARD (INVERTER)	3P058359-1	EH0011		1	A3P	
E13		1127287	WIRE HARNESS (SAFETY SWITCH)	4P041606-1			1		
E13-1	B	0944357	SWITCH	4P008757-1			1	DS1	
E15	A	0948809	HIGH VOLTAGE CONTACT ASS'Y	4P010108-1			1		
E15-1		1021257	HIGH VOLTAGE CONTACT FRAME	3P009404-1			1		
E15-2		0948816	HIGH VOLTAGE CONTACT	4P010467-1			1		
E16	A	0948816	HIGH VOLTAGE CONTACT	4P010467-1			1		
E17	B	1204045	LAMP ASS'Y	3P064207-1			1		
E18	A	1194566	FAN MOTOR	3P063028-1	KFD-280-17-8A	8P 17W 280V	1	M1F	
E19		1127294	WIRE HARNESS (FOR FAN MOTOR)	4P041605-1			1		
E21		1188794	WIRE HARNESS (FOR HVU)	4P059255-1			1		
E22		1127326	WIRE HARNESS (INVERTER)	4P041607-1			1		
E23		1214352	POWER CORD	3P060210-1			1		
F1		1119510	FRONT PLATE	1P040502-1			1		
F2		1127333	CONTROL DISPLAY COVER (FRONT)	1P040421-1			1		
F3		1127340	CONTROL DISPLAY COVER (REAR)	1P040459-1			1		
F4		1204052	REAR PLATE	1P058586-1			1		
F5		1214369	CASING FRAME (MIDDLE)	1P058669-1			1		
F6		1119558	DISCHARGE GRILLE	2P040347-1			1		
F7		1127357	LEAD WIRE SUPPORT	3P040466-1			1		
F8		0948203	MOTOR MOUNTING PLATE	3P006693-1			1		
F9		1214376	SET PLATE	1P058499-1			1		
F10		1214383	DISPLAY NAME PLATE	1P063105-1			1		
F15			BOLTS AND NUTS LIST	3P064658-1			1		
K1	A	1194573	WIRELESS REMOTE CONTROLLER	3P026240-6	ARC17A53		1		
K2			OPERATION MANUAL	3P026236-21			1		
K3		1114003	BATTERY PACK	4PH14023-2			1		

# Index

<b>A</b>		
Accessories .....	5	
<b>C</b>		
Cautions and Warnings .....	iii	
<b>E</b>		
Equipment does not Operate .....	20	
<b>H</b>		
How to Change the Ion Filter (Roll) .....	16	
How to Clean the Front Panel .....	13	
How to Clean the Ionizer .....	14	
How to Clean the Prefilter .....	13	
How to Operate the Unit .....	12	
<b>I</b>		
Indicator does not Change from "Dirty" to "Clean" .....	22	
Indicator Lamps and their Functions .....	4	
Installation .....	11	
<b>N</b>		
Names and Functions of Parts .....	4	
Names and Functions of The Indicator Lamps .....	9	
Names and Functions of The Operating Section .....	8	
<b>O</b>		
Operating Manual .....	2	
Optional Accessories .....	17	
<b>P</b>		
Parts Illustration .....	41	
Parts List .....	42	
Photocatalytic Operation does not Activate .....	24	
<b>R</b>		
Remote Controller Fails to Operate Equipment ....	23	
Removal of Electrical Parts (Inverter Lamp) .....	31	
Removal of External Accessories .....	28	
Removal of Fan Motor .....	36	
Removal of Ionizing Wire .....	30	
Removal of PCB .....	34	
Removal of Safety Switch .....	37	
Removal Procedure .....	27	
<b>S</b>		
Setup .....	10	
Specifications .....	17	
<b>T</b>		
Tips for appropriate use .....	6	
Troubleshooting .....	20	
<b>W</b>		
Wiring Diagram		
MC401VE .....	40	



# Drawings & Flow Charts

<b>A</b>		<b>I</b>	
Accessories .....	5	If not using the unit for long periods of time, unplug the power cable .....	v
<b>B</b>		Indicator does not Change from "Dirty" to "Clean" .....	22
Before changing filters, cleaning the equipment or moving it, turn it OFF and unplug the power cable .....	iii	Indicator Lamps and their Functions .....	4
<b>D</b>		Installation .....	11
Do not block the intake or outlet .....	iv	<b>K</b>	
Do not disassemble, service or modify this equipment .....	iii	Keep the equipment 10 cm or more away from the wall when used on a table .....	iv
Do not insert fingers or objects into the openings of the suction and discharge grilles .....	iv	<b>N</b>	
Do not operate the equipment with wet hands .....	iii	Names and Functions of Parts .....	4
Do not place water containers such as fish bowls and flower vases near the equipment .....	v	Names and Functions of The Indicator Lamps .....	9
Do not position the equipment on its side or tilt it during use .....	v	<b>P</b>	
Do not use in humid places or places which might be wet, such as bathrooms .....	iv	Parts Illustration	
Do not use in the place of kitchen fans or cooker hood fans .....	iv	MC401VE .....	41
Do not use near to sources of heat such as heaters .....	iv	Photocatalytic Operation does not Activate .....	24
Do not use outdoors or where exposed to direct sunlight .....	iv	Prevent combustibles (hair sprays, etc.), sparks and incense from being drawn into the unit .....	iv
Do not use the equipment in a place filled with oily smoke .....	iv	<b>R</b>	
Do not use the equipment near a lighting fixture .....	iv	Remote Controller Fails to Operate Equipment ....	23
Do not use the power cable if damaged or loose in the socket .....	iii	Removal of Electrical Parts (Inverter Lamp) .....	31
Do not wipe with benzene or thinner, or spray with insecticide .....	v	Removal of External Accessories .....	28
<b>E</b>		Removal of Fan Motor .....	36
Equipment does not Operate .....	20	Removal of Ionizing Wire .....	30
<b>H</b>		Removal of PCB .....	34
Hold the plug to unplug the power cord from the AC outlet. Do not pull the cord to unplug ....	v	Removal of Safety Switch .....	37
How to Change the Ion Filter (Roll) .....	16	<b>S</b>	
How to Clean the Ionizer .....	14	Setup .....	10
How to Clean the Prefilter .....	13	<b>T</b>	
How to Operate the Unit .....	12	Tips for appropriate use .....	6
		<b>U</b>	
		Use only 220-240 VAC 50 Hz power supply .....	iii
		<b>V</b>	
		Ventilate the room frequently when used together with a heating device .....	v
		<b>W</b>	
		Wiring Diagram	
		MC401VE .....	40



Daikin Europe N.V. is approved by LRQA for its Quality Management System in accordance with the ISO9001 standard. ISO9001 pertains to quality assurance regarding design, development, manufacturing as well as to services related to the product.



Daikin units comply with the European regulations that guarantee the safety of the product.



ISO14001 assures an effective environmental management system in order to help protect human health and the environment from the potential impact of our activities, products and services and to assist in maintaining and improving the quality of the environment.



Daikin Europe N.V. is participating in the EUROVENT Certification Programme. Products are as listed in the EUROVENT Directory of Certified Products.

Specifications are subject to change without prior notice



**DAIKIN EUROPE N.V.**

Zandvoordestraat 300

B-8400 Ostend - Belgium

Internet: <http://www.daikineurope.com>