

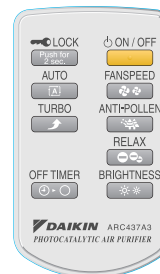

SiBE81 - 623A

# Service Manual

## Photocatalytic Air Purifiers



# Air Purifiers

**MC707VM-S**  
**MC707VM-W**

1.Introduction .....	2
2.Precautions for Use.....	8
2.1 Required Conditions .....	8
2.2 Applicable Room Area .....	8
3.Specifications .....	9
3.1 Specifications .....	9
3.2 Dimensions .....	10
3.3 Wiring Diagram .....	11
3.4 Packaging Drawing .....	12
4.Operation Manual.....	13
4.1 Safety Precautions .....	13
4.2 Names and Operation of each Part .....	14
4.3 Preparation before Operation .....	16
4.4 Care and Cleaning .....	19
4.5 Troubleshooting .....	27
5.Optional Accessories .....	28
5.1 Dimensions .....	28
6.Troubleshooting .....	29
6.1 Basic Inspection .....	29
6.2 Troubleshooting .....	30
7.Removal Procedure .....	35
7.1 Removal of the Front Panel / Filters .....	35
7.2 Removal of Streamer Electric Discharge Unit .....	44
7.3 Removal of Ionizing Wire .....	46
7.4 Removal of Fan Motor .....	48
7.5 Removal of Electrical Box / PCB .....	52

# 1. Introduction



Daikin's original electro-discharge streamer technology is used for powerful decomposition and removal efficiency in the flash streamer air purifiers we are marketing globally.

Totally differentiated from the competition, our technology and performance are available nowhere else.

World's first	<b>Flash streamer</b> <b>NEW</b>	➤	Allergen total removal
World's first	<b>Titanium Apatite Photocatalytic Filter</b>		Powerful deodorizing
World's first	<b>Bio-antibody filter</b> <b>NEW</b>		Powerful bacteria removal

Air purifier with renewed design for performance and beauty.

06CJG-3

Flash streamer is the electro-discharge used in our air purifier that decomposes (oxidizes) more than 1,000 times more than glow discharge\*.

**Streamer discharge**

Area high-speed electrons are generated

**What is Flash Streamer?**

Flash Streamer is a unique technology developed by Daikin.

The Flash Streamer releases streams of high-speed electrons with strong oxidation power.

\*Glow discharge: The most common type of plasma that is used by a plasma ionizer, etc., for electrostatic dust collection.

06CJG-4



Adjuvants are substances included in air pollutants such as exhaust gas that, when inhaled along with allergens, make one's allergy symptoms worsen.

**Allergens**  
Mites  
Pollen  
Mold  
and others

**Adjuvant**  
Diesel exhaust particles  
Exhaust gas (NOx, formaldehyde, etc.)  
VOC (toluene, xylene, etc.) and others

**Allergy symptoms worsen.**

Adjuvant  
Diesel exhaust(DPE)  
Allergens  
Pollen

**Only flash streamer removes adjuvants.**

06CJG-8

Powerfully breaks down odors in 3 stages! **95% deodorizing efficiency**

Plasma ionizer    Odor molecules    Electrostatic dust collection filter

Purified air

Flash streamer  
Flash streamer X Titanium Apatite Photocatalytic Filter  
Flash streamer X Streamer deodorizing catalyst

06CJG-9

**Disinfection**

Elapsed time (hrs.)	Flash streamer + Titanium Apatite Photocatalyst (%)	Titanium Apatite Photocatalyst (%)
0	0	0
2	~10	~10
4	~99.99	~10
6	~100	~10
24	~100	~100

Result with flash streamer: Over 99.99%<sup>\*1</sup> removed in 4 hours!

Approx. 6 times faster!

Almost all removed after 24 hrs.

The Flash Streamer further activates the photocatalyst!

flash streamer ONLY BY DAIKIN

\*Results exhibited for bacteria and mold spores collected on Titanium Apatite Photocatalytic Filter.  
\*1 Testing organization: Japan Food Research Laboratories. Evaluation method: antibacterial test.  
Test Result Certificate No. 203120769-001.

06CJG-10

**Bio-Antibody Filter** NEW

The Bio-Antibody filter works in the same way as the influenza vaccination. It removes viruses in about 1 minute.

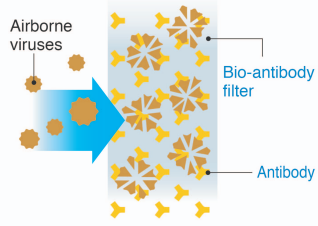

- The Bio-Antibody filter is usable for one year after opening.
- Replacement for subsequent years will be available.
- Operation will not be adversely affected if the Bio-Antibody filter is not used.
- Effective for 3 years from date of manufacture.

06CJG-11

**Catechin Pre-Filter**

The pre-filter not only catches large dust particles, pet hairs, etc., but also removes germs attached to them by means of the catechin component.

### What is Catechin?

**Catechin**

Catechin, a bitter-tasting component found in plants, is a type of polyphenol. Found in abundance in tea, it possesses antibacterial and antiviral properties. It is used in clothing such as underwear and in products such as masks and bedding.

06CJG-12

**Purifies with large air flow 420 m<sup>3</sup>/h. high-power suction!**

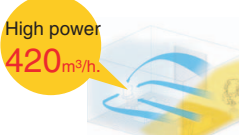

High power 420m<sup>3</sup>/h.

Powerful 4-directional suction is used to reach every corner of the room. Odors, dust, bacteria and formaldehyde are relentlessly sucked in from above, left, right, and front.

**Guideline purification times**

Area (m <sup>2</sup> )	Purification Time (min.)	Suction Time (min.)
7	Purified in 7 minutes	Suction of room air takes about 2.5 minutes.
9	Purified in 8 minutes	Suction of room air takes about 3 minutes.
13	Purified in 10 minutes	Suction of room air takes about 4 minutes.
23	Purified in 17 minutes	Suction of room air takes about 7.5 minutes.

(Results based on testing carried out in accordance with Japan Electrical Manufacturers Association JEM1467 standard.)

06CJG-13

**Designed to be quiet** A mere 31 dB even in M mode (standard mode). It's as quiet as a whisper.

Top-ranking silent operation is achieved by Daikin's original shroud fan and a low-pressure-loss filter.

**Operation sound and air flow**

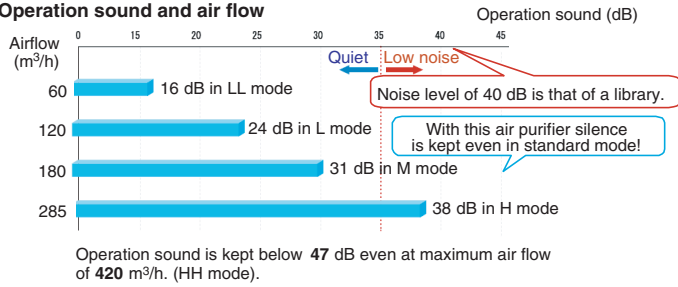

06CJG-14

**7-year pleated filter**



**Comes with 7 pleated filters**

Operation is economical since the air purifier comes with 7 filters. You won't need to buy filters for 7 years. Also, since the filter is replaced each year, filter efficiency will not drop.

**Easy filter storage!**

Unused filters can be stowed neatly inside the unit.



06CJG-15

**Control the numerous features with the easy-to-use remote controller.**



**Remote controller storage space**

The remote controller stores neatly in the top of the unit.



**Antitamper lock**

It prevents small children from mishandling.

**TURBO mode**

This convenient mode provides high-power operation.

**Off timer**

The remote controller can be set to turn off the unit after 1, 2 or 4 hours.

**Pollen mode**

By creating a gentle turbulence in the room air, pollen is caught before it lands on the floor.

**Negative ions**

The large air flow fills the entire room, corner to corner, with freshened air.

**Display adjustment**

The brightness of lamps on the indicator panel can be adjusted.

06CJG-16

**Flat panel blends with interiors and is easy to clean.**



#### **Quick-wipe panel**

Designed for easy maintenance, a single wipe with a wet cloth is all it takes to keep it clean.



06CJG-17



## 2. Precautions for Use

### 2.1 Required Conditions

#### ■Ambient Temperature/Humidity

Use this product under the following conditions.

Operating conditions	
Room temperature	0°C - 32°C
Room humidity	80% or less

Use under other conditions may cause malfunction.

#### ■Miscellaneous

- This product is for home use. Do not use for special purpose.
- This product is for indoor use only. Do not use in bathroom or outdoors as it is not water/condensation proof.
- Do not modify this product.

### 2.2 Applicable Room Area

	MC707VM-S MC707VM-W
House	less than 48m <sup>2</sup>

JEM1467

## 3. Specifications

### 3.1 Specifications

Model		MC707VM-S	MC707VM-W
Type		Photocatalytic air purifier	
Power supply		1φ 220-240 / 220-230V 50 / 60Hz	
Color		Sparkling silver + metallic ocean blue	White + Sparkling silver
Rated power consumption (HH/H/M/L/LL)	W	55 / 23 / 14 / 10 / 8	
Running current (HH/H/M/L/LL)	A	0.48 / 0.22 / 0.14 / 0.10 / 0.08	
Deodorizing Efficiency (JEM1467★1)	%	95	
Operating sound ★2 (HH/H/M/L/LL)	dBA	47 / 38 / 31 / 24 / 16	
Sound power ★2 (HH/H/M/L/LL)	dBA	62 / 52 / 40 / 39 / 31	
Fan	Type	Multi blade fan (Sirocco fan with shroud assembly)	
	Air flow rate (HH/H/M/L/LL)	m <sup>3</sup> /h	420 / 285 / 180 / 120 / 60
Dust collecting method		Plasma ionizer (Electrostatic dust collection) + Electrostatic dust collection filter	
Deodorizing method		Flash streamer + Titanium apatite photocatalytic filter + Deodorizing catalyst	
Bacteria filtering method		Bio-antibody filter + Flash streamer + Titanium apatite photocatalytic filter	
Safety device		Safety switch (Operation stops when the front panel is open.)	
Power cord	m	2.0	
Dimensions (H x W x D)	mm	533 x 425 x 213	
Package dimensions (H x W x D)	mm	587 x 478 x 263	
Product weight	kg	8.7	
Gross weight	kg	11.0	
Standard accessories		Operation manual (1), Wireless remote controller (1), Photocatalytic pleated filter (7), Bio-antibody filter (1)	
Drawing number		3D051236	3D051237

NOTE:

- ★1. Deodorizing efficiency means the combined removal rate of ammonia, acetaldehyde and acetic acid after burning five cigarettes in a 1m<sup>3</sup> airtight container and running the air purifier at rated air flow for one minute.
- ★2. Operating sound levels are the average of values measured at 1m away from the front, left, right and top of the unit. (This equal to the value in an anechoic chamber.)  
The values are measured without bio-antibody filter.

### 3.2 Dimensions

#### MC707VM-S, MC707VM-W

• Required installation space

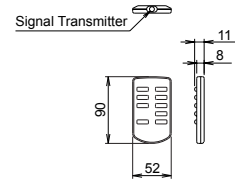
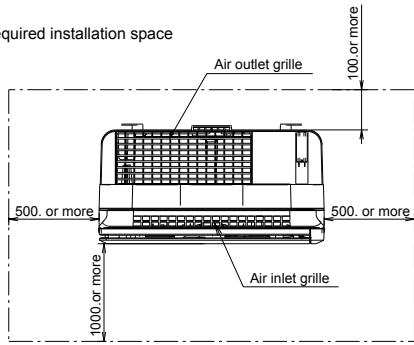

• Dimension of remote controller (ARC437A3)

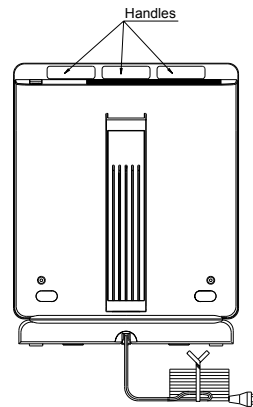
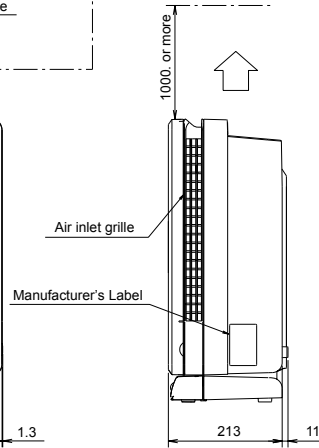
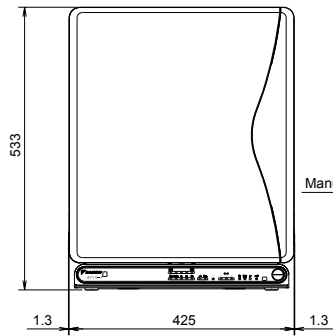

Power supply cord  
Approx. 2.0m

3D050511

### 3.3 Wiring Diagram

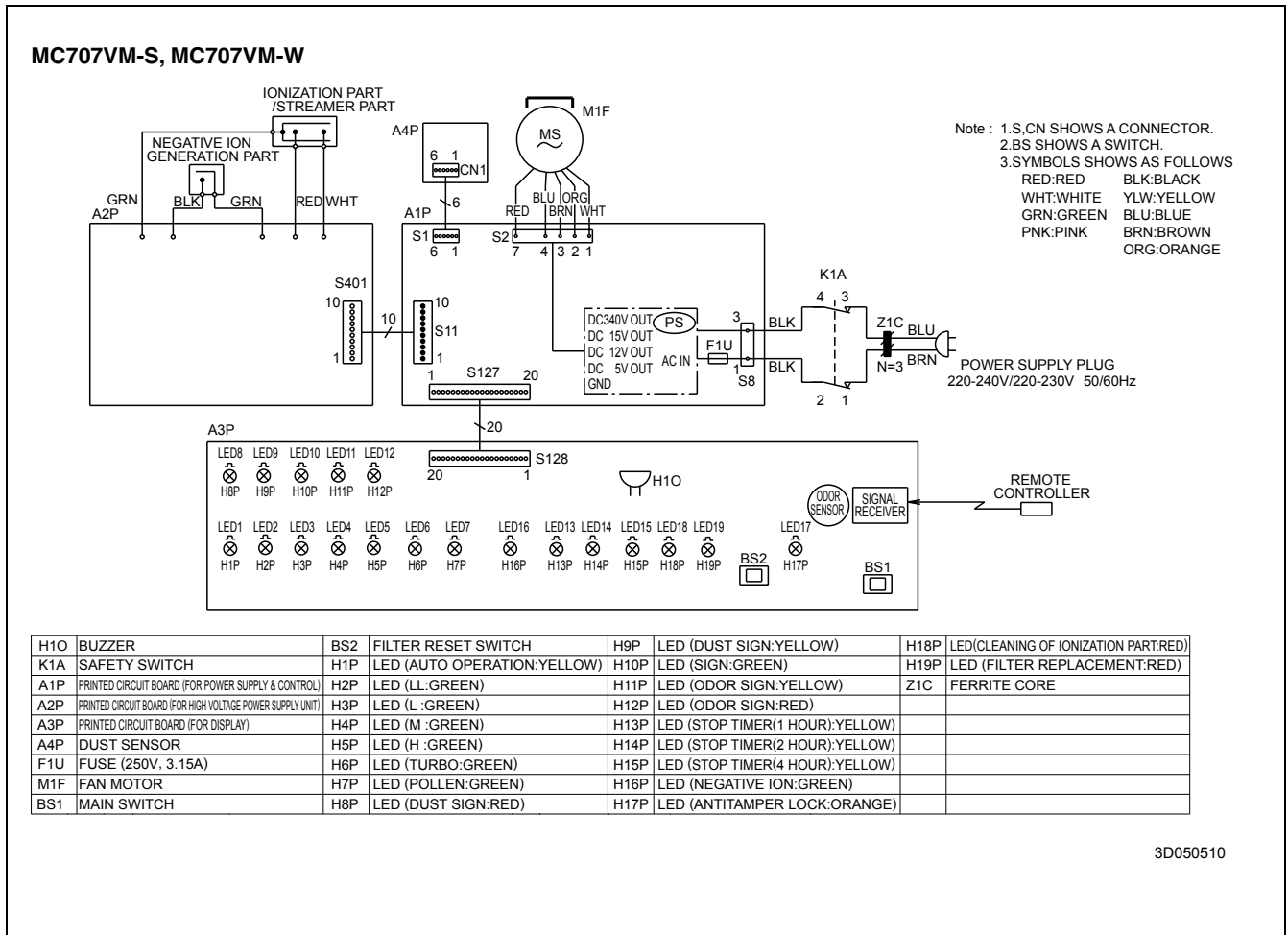

3D050510

### 3.4 Packaging Drawing

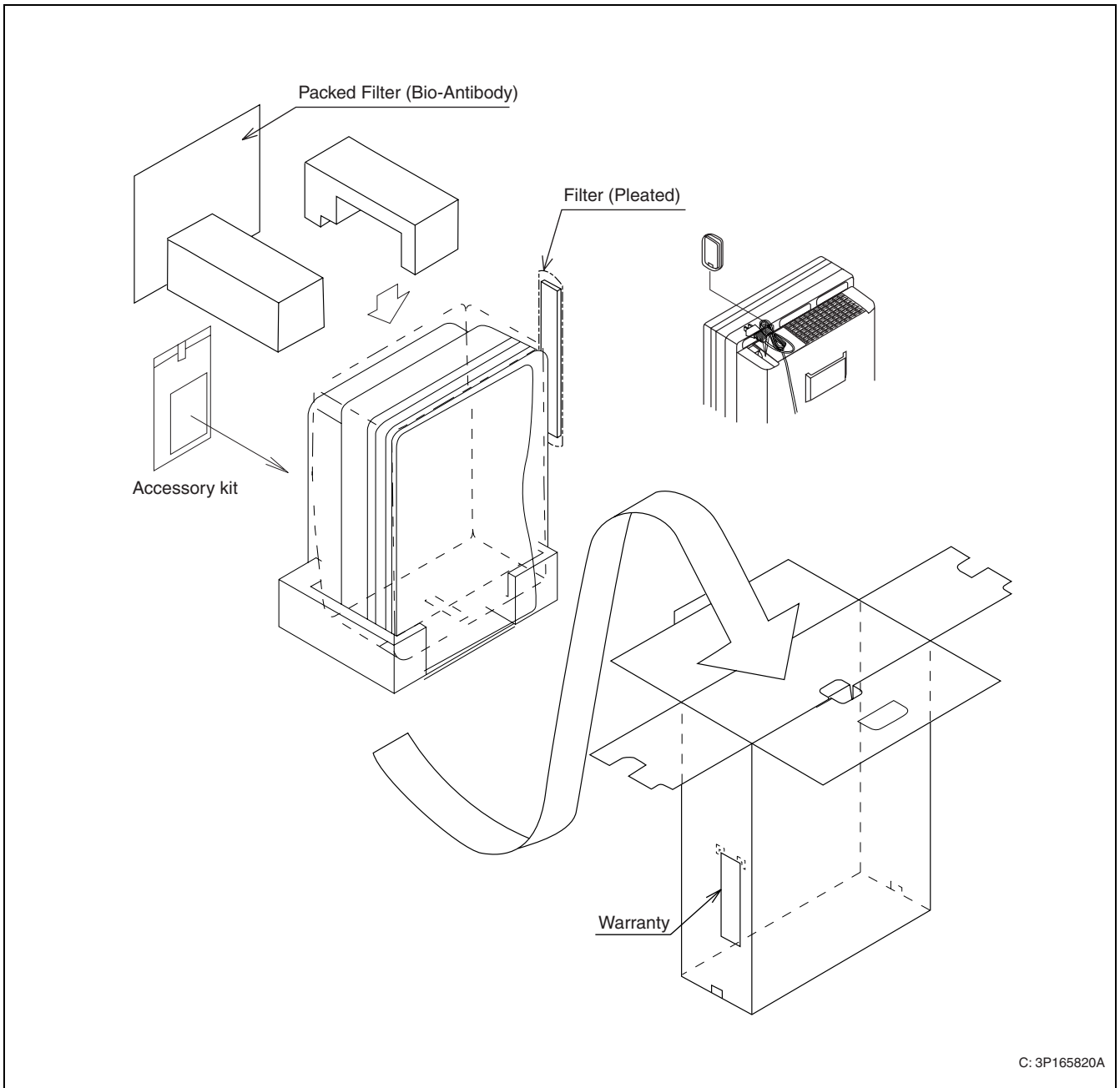

C: 3P165820A

## 4. Operation Manual

### 4.1 Safety Precautions

## Safety Precautions

- Keep this manual where the operator can easily find them.
- Read this manual attentively before starting up the unit.
- For the reason of safety the operator must read the following cautions carefully.
- This manual classifies precautions into WARNING and CAUTION. Be sure to follow all precautions below: they are all important for ensuring safety.

### WARNING











If you do not follow these instructions exactly, the unit may cause property damage, personal injury or loss of life.

### CAUTION

If you do not follow these instructions exactly, the unit may cause minor or moderate property damage or personal injury.























- |   |  |
|---|--|
|  Never do.   |  Be sure to follow the instructions.  |
|  Never touch the air purifier (including the remote controller) with a wet hand. |  Never cause the air purifier (including the remote controller) to get wet. |

### WARNING

- **Do not use the power cable if it is damaged.**  Using a damaged power cable is extremely hazardous; if the power cord becomes damaged, you must obtain a replacement from the manufacturer or from a properly-authorized service agent. Do not attempt replacement yourself.
- **Do not disassemble, remodel or attempt to service this equipment.**  Unwarranted tampering can lead to fire and/or malfunction.
- **Do not operate with wet hands.**  Electric shock may occur.
- **Do not use power supplies other than the rated supplies.**  Fire or electric shock may occur.
- **Do not damage the electrical power cord, construct anything, or forcibly bend, stretch or twist the cord. Do not set heavy items on the cord or place the cord between items.**  If the electrical power cord is damaged, fire or electric shock may occur.
- **Before changing filters, cleaning the equipment or moving it, turn it OFF and unplug the power cable.**  Working with power ON can lead to fire and/or electric shock.
- **Do not use the power cable if damaged or loose in the socket.**  Using the power cable in anything but proper working condition can lead to short-circuits and subsequently electric shock and/or fire.
- **Do not use in humid places or places which might be wet, such as bathrooms.**  Contact with water can lead to electric shock or damage the equipment.
- **Do not use where oil components, such as machine oil, are floating around.**  There is the danger of cracking, electric shock or combustion.
- **Do not wet the air outlet or the main unit.**  It may cause fire or electric shock.
- **Do not use in locations where there is a large amount of soot, such as a kitchen or locations where there combustible gas, corrosive gas or metallic dust is present.**  Fire or malfunction may occur.

### CAUTION

- **Do not use close to lighting equipment (within 1m).**  The reception sensitivity of the remote controller may be reduced and the color may change.

- **Do not use outdoors or where exposed to direct sunlight.**  Direct sunlight can weaken remote controller signal reception sensitivity and discolor the casing.
- **Do not use near to sources of heat such as heaters.**  Heat can discolor and deform the casing.
- **Keep the unit and remote control minimum 2m from lighting, TVs, radios, stereos and aeriels.**  This unit can disturb TV pictures and generate interference. Illumination can weaken remote controller signal reception sensitivity and discolor the casing.
- **Do not use in the place of kitchen fans or cooker hood fans.**  Adverse conditions of use can shorten service-life of the prefilter and ion filter, as well as lead to equipment damage.
- **Prevent combustibles (hair sprays, etc.), sparks and incense from being drawn into the unit.**  Such substances can cause fire.
- **Do not insert fingers or foreign objects into the inlet or outlet openings.**  Electric shock or damage may occur. There exists a danger of hands getting caught in the motor and causing injury.
- **The appliance is not intended for use by young children or pets without supervision.**  
- **Young children or pets should be supervised to ensure that they do not play with the appliance.**  
- **When using pesticides of an indoor fumigation type (fume release), stop the operation of the air purifier to none of the chemical is sucked inside the unit.**  The chemical components will accumulate inside the unit and depending on your physical condition, you may react to the irritation which is bad for your health.
- **When used in conjunction with a humidifier, keep mist from being directly drawn into the unit.**  Mists can lead to electric shock and/or equipment damage.
- **Do not block the intake or outlet.**  Blocked openings can reduce capacity (air will not be cleaned throughout the entire room) and/or damage the equipment.
- **Do not place any containers which hold water such as goldfish bowls or flower vases on or close to the unit.**  If water gets inside the unit, electric shock or malfunction may occur.
- **Do not wipe with benzine or thinner, or spray with insecticide.**  Such substances can cause cracking, electric shock and/or fire.
- **If not using the unit for long periods of time, unplug the power cable.**  Dielectric breakdown can lead to leakage current and subsequently electrical shock and or short-circuit may occur causing a fire.
- **If the power plug is unplugged, be sure to hold and pull out the end of the power plug without holding the power cord.**  There is a chance that an electrical short or short-circuit may occur causing a fire.
- **Do not operate with a pre-filter or filter removed.**  Malfunction may occur.
- **Do not sit on, stand on or shake the unit.**  Malfunction may occur.
- **Do not use when the unit is on its side or leaning.**  Malfunction may occur.
- **When using another burner at the same time, actively ventilate the area.**   This unit cannot remove carbon monoxide. If the ventilation is not sufficient, carbon monoxide poisoning may occur.

Toxic substances such as cigarettes (carbon monoxide) cannot be removed.

## 4.2 Names and Operation of each Part

### Names and Operation of each Part

#### ■ Main unit

##### Front

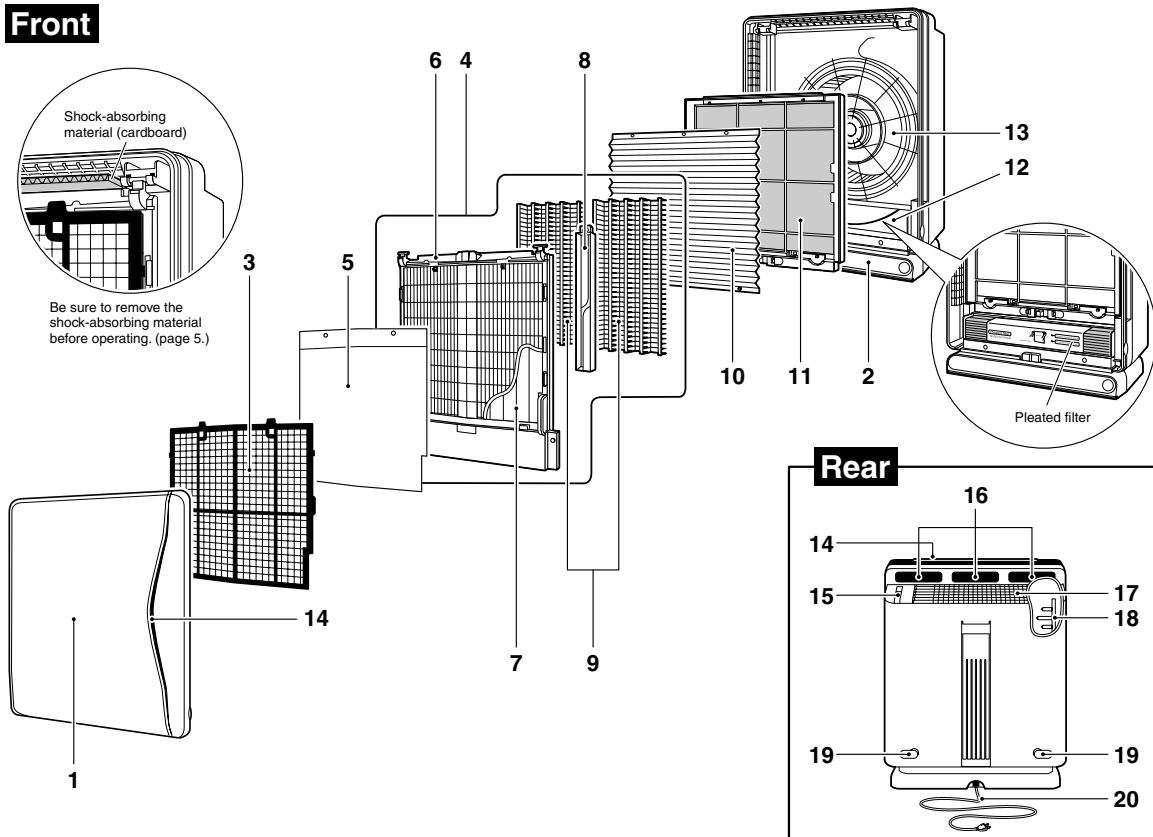

**1 Front panel**

**2 Main unit display** (page 4.)

Shows operation status.

**3 Pre-filter (green)**

Removes comparatively large material and dust.

**4 Plasma ionizer**

**5 Bio-antibody filter (white)**

Absorbs viruses.

**6 Ionizing frame**

**7 Ionized wire**

Small dust particles which are not captured by the pre-filter are positively charged so that they can be more easily absorbed by the negatively-charged pleated filter.

**8 Streamer discharger**

**9 Opposing pole plates**

**10 Pleated filter (front: white, back: blue)**

Absorbs dust particles using the principle of static electricity.

**11 Deodorizing catalyst (black)**

Absorbs and decomposes elements which could not be removed before returning the air back to the room.  
Note: cannot be washed with water.

**12 Filter container**

Six replacement pleated filters are included.

**13 Ventilation fan**

**14 Air inlet**

**15 Remote controller storage slot**

Stores the accessory remote controller.

**16 Handle**

Use when moving the main unit.

**17 Air outlet**

**18 Negative ionization assembly**

Generates negative ions. Functions to combine positively charged toxic substances in a room and neutralize and transform them.

- If static electricity is applied, the amount of negative ions generated will be temporarily reduced.

**19 Power supply cord hook**

Winds the power supply cord when storing the main unit.  
Do not wind the cord during operation.

**20 Power supply cord**

■ Main unit display

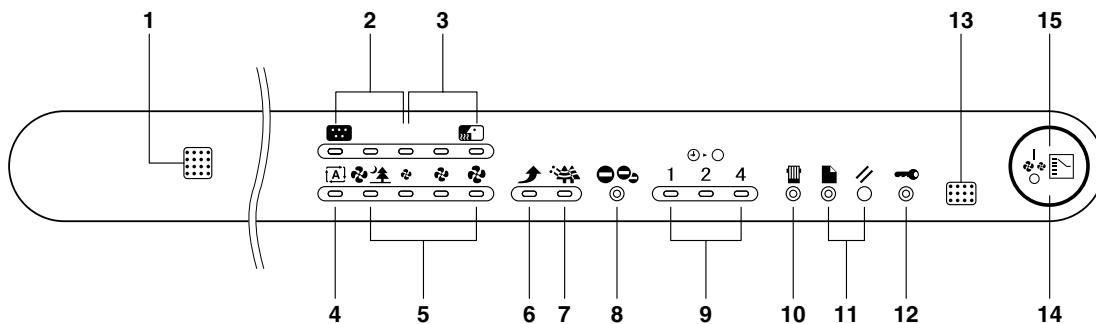

**1 Air intake for dust sensor**

Air is taken in from here and the dust sensor detects the dirty state of the air.

**2 Clean monitor (Dust)**

Detects the dirty state of the air and indicates the results.

Dust	Indicator	Off	On
Low ↓		<input type="checkbox"/>	<input checked="" type="checkbox"/> Green
		<input type="checkbox"/>	<input checked="" type="checkbox"/> Yellow <input checked="" type="checkbox"/> Green
High	Red	<input checked="" type="checkbox"/> Yellow	<input checked="" type="checkbox"/> Green

- In the following case, only the green light is on for the first 7 seconds regardless of pollution from the air.
  - Operation directly after setting the front panel or plasma ionizer
  - Operation directly after inserting the power plug
- You can change sensitivity setting of the dust sensor lamp.

**3 Clean monitor (Odor)**

Detects changes to odors and indicates the results.

Odor	Indicator	Off	On
Weak ↓	Green	<input type="checkbox"/>	<input type="checkbox"/>
	Green	<input checked="" type="checkbox"/> Yellow	<input type="checkbox"/>
Strong	Green	<input checked="" type="checkbox"/> Yellow	<input checked="" type="checkbox"/> Red

- Reactions to sudden temperature/humidity changes and odorless gas (carbon monoxide) may occur.
- There may not be any reaction for a uniform case without any changes to the intensity of the odor.
- There may be no reaction to pet odors or garlic odors.
- Different people have different sensitivity to odors so you may not notice an odor even though the lamp is green.
- In the following case, only the green light is on for the first 1 minute and this state is regarded as the reference value of the odor sensor.
  - Operation directly after setting the front panel or plasma ionizer
  - Operation directly after inserting the power plug

**4 Automatic operation indicator (yellow)**

Lit during automatic operation.

**5 Airflow rate indicator (green)** (page 7.)

Lit by the set airflow rate setting. (The air volume lamp is on during automatic or manual operation.)

**6 Turbo mode indicator (green)** (page 7.)

Lit during turbo mode.

**7 Anti-pollen mode indicator** (page 7.)

Lit during pollen mode.

**8 Negative ion mode indicator** (page 7.)

Indicates during negative ion operation.

**9 OFF timer setting indicator (yellow)** (page 7.)

Indicates the set OFF timer time. Indicates the remaining time after setting as the time passes.

**10 Clean indicator (red)** (pages 11, 12.)

The lamp will blink for cleaning time of the plasma ionizer.

**11 Replace indicator (red) / Reset button**

The lamp will be on for replacement time of the pleated filter and blink after certain time has elapsed from the turning on.

\* Press the reset button after replacement. (page 10.)

**12 Lock lamp** (page 7.)

Lit during lock.

**13 Air intake for odor sensor**

Air is taken in from here and the odor sensor detects the odor state.

**14 Receiver**

Receives signals from the remote controller.

**15 Operation switch / stop button**

Each time this button is pressed, the operation mode switches as shown below.

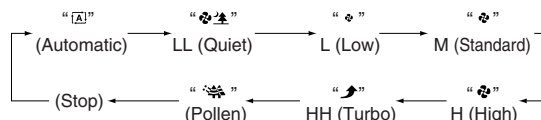

\* During automatic operation the airflow rate at that time will also be lit.



## 4.3 Preparation before Operation

# Preparation Before Operation

### ■ Remote controller setup

#### 1. Remote controller preparations

- Battery is already set in the remote controller but the remote controller cannot be used as is without first preparing it. Use the remote controller after pulling out the clear sheet from the battery cover.

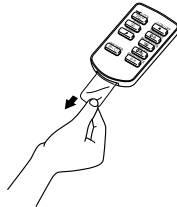

#### 2. Remote controller storage

- When the remote controller is not being used, you can store it in the remote controller storage slot.

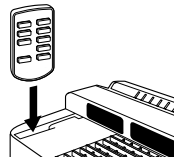

#### 3. Using the remote controller

- Point the transmitter of the remote controller towards the receiver of the main unit. If an obstruction to the signal, such as a curtain, exists, the remote controller will not operate.
- The distance from which the remote controller can transmit is approximately 6m.

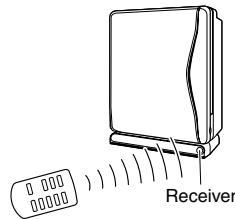

#### 4. Battery replacement

- Open the cover on the rear of the remote controller towards the arrow.
- Replace the battery with CR2025 battery. (Be sure to set the battery with the + side of the cover as shown in the figure.)
- Close the cover to its original position.

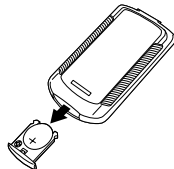

### NOTE

- Store the batteries where babies and children cannot reach them. If, by chance, a battery is swallowed, be sure to contact a doctor immediately.
- When discarding batteries, cover the terminals of the batteries with tape. If mixed with other metal or batteries, heat, explosion or combustion may occur.

### ATTENTION

#### Battery

- The included coin type battery is prepared for initial use. They will be consumed within 1 year from the manufacturing date of the air purifier.
- A replacement target is approximately 1 year but if the reception becomes difficult, replace the batteries with new coin type battery CR2025.
- Coin type battery close to the "recommended usage period" may need to be replaced soon.
- In order to prevent malfunctions or injuries due to leaking or explosions, be sure to remove the coin type battery when the unit will not be used for a long period of time.

#### Remote controller

- Do not drop or place the remote controller in water. (Damage may occur.)
- Do not press the remote controller buttons with sharp objects. (Damage may occur.)
- The signals may not be received well of electronic lighting style fluorescent lamps (such as inverter fluorescent lamps) are in the same room. For these cases, discuss with the dealer.
- If other electrical device operate by the remote controller, either separate them from the remote controller or discuss with the dealer.

### ■ Attaching the pleated filter

#### WARNING

Set the filter while the power supply plug is not plugged in.

#### CAUTION

- The unit must be operated with a pre-filter. If they are not set and the unit is operated, malfunctions may occur.

#### 1. Remove the front panel.

- Place your fingers in the indentations on the bottom of the unit and pull forward, holding on to the bottom of the panel.

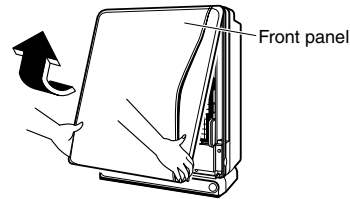

#### CAUTION

- Do this before plugging the unit into a power supply.
- Always install the pleated filter before running the unit.

#### 2. Remove the shock-absorbing material and then remove the plasma ionizer.

- Remove the shock-absorbing material.

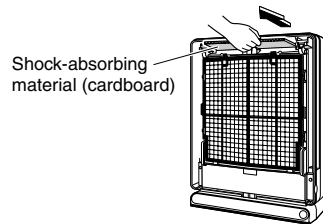

- Holding the handle, lift towards yourself and remove from the top 2 hooks.

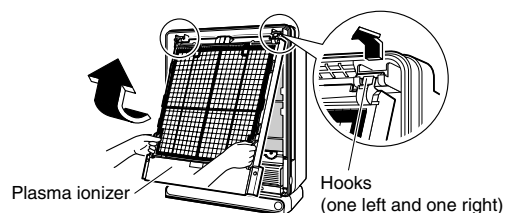

**3. Attach the pleated filter.**

- Remove the pleated filter from the bag.

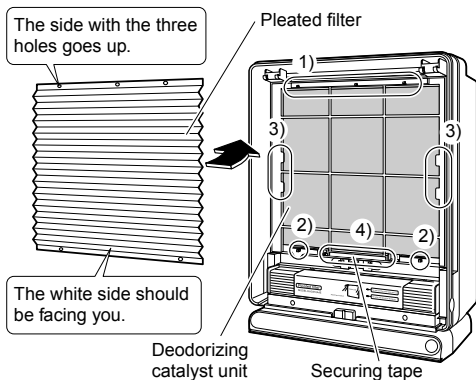

- Hook on the top and bottom hooks, insert into the left and right hooks, and then secure with the tape.

1) Place the pleated filter holes on the 3 upper tabs of the deodorizing catalyst unit.

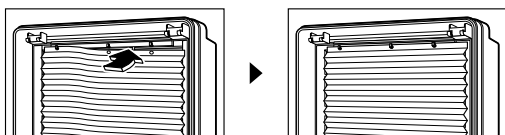

2) Hook the holes of the pleated filter on the bottom hooks. (2 locations)

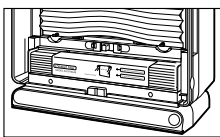

3) Insert the pleated filter into the left and right hooks.

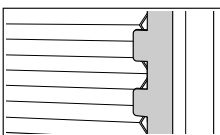

4) Secure the pleated filter with the tape.

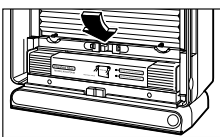

**4. Install the plasma ionizer in its original configuration.**

- Holding the handle, snap onto the 2 upper hooks and push in.
- Insert the plasma ionizer fully.

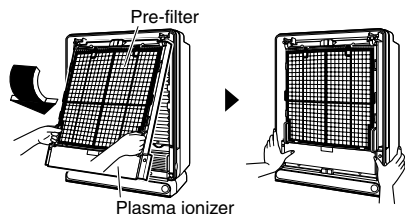

**NOTE**

- Only run the unit with the pre-filter and pleated filter in place. If they are not in place, running the machine may break it.
- If the front and blue sides of the pleated filter are reversed, the unit's performance will suffer.

**■ Attaching the bio-antibody filter**

**1. Remove the pre-filter.**

- Remove by pulling out in front while holding the tabs on top of the pre-filter.

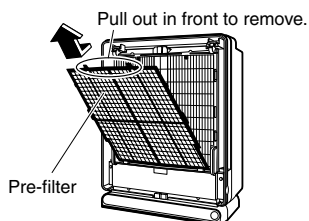

**2. Attach the bio-antibody filter.**

- Hook the holes (2 locations) of the bio-antibody filter on the hooks (2 locations) of the plasma ionizer.

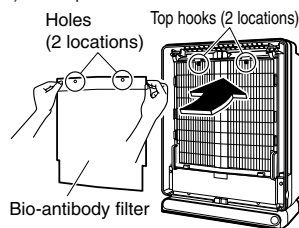

**3. Restore the pre-filter.**

- Hook the bottom part of the pre-filter on the bottom hooks (2 locations) of the plasma ionizer and then insert it into the left and right hooks (4 locations).

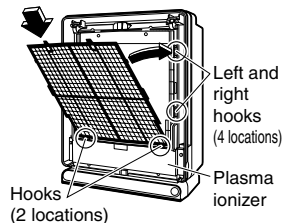

**4. Restore the front panel.**

- Hook the top hooks (3 locations) of the front panel on the grooves on top of the main unit and then close the panel.

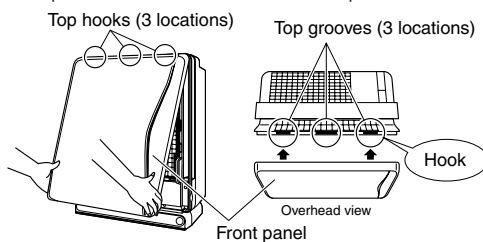

**NOTE**

- Securely close the panel. Failing to do so may cause activation of the safety switch and out of unit operation.

**ATTENTION**

- The bio-antibody filter is a dedicated filter to speed up virus elimination. Use it in winter when air is dry and virus is easy to grow. Change and storage (page 9.)
- \* The air cleaning effect remains regardless of the attachment.

# Preparation Before Operation

## ■ Installation of main unit

To install the unit, comply with the following standards to ensure performance.

<If installed on a table>

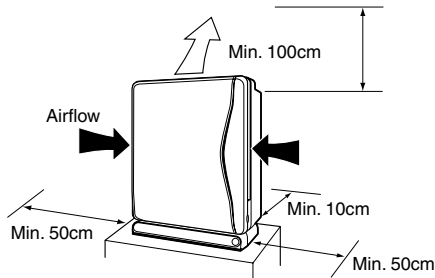

### — ATTENTION —

- If operated outside the conditions shown below, malfunction may occur.
- Indoor temperature 0-32°C
- Indoor humidity 80% or less

# How to Operate

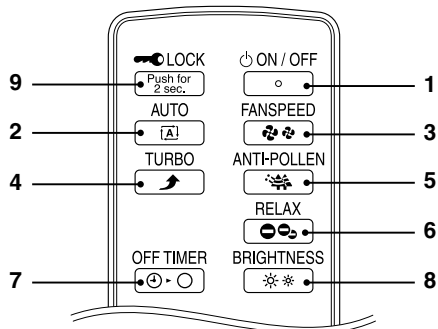

### 1 When operating

Press the [ON/OFF] button.  
Pressing again will stop.

### 2 When you want to automatically switch the airflow rate

Press the “[A]” [AUTO] button.

- Automatically adjusts the airflow rate to “LL (Quiet), “L (Low), “M (Standard), “H (high) in response to the dirty condition of the air.

### 3 When you want to manually switch the airflow rate

Press the “[FANSPEED]” [FANSPEED] button.

- Each time it is pressed the airflow rate switches as shown below allowing you to choose your desired flow.

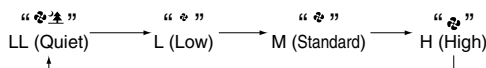

- The setting “LL (Quiet)” is a very slow airflow rate and is convenient when sleeping.
- After setting “LL (Quiet)” the power for cleaning the air decreases because of the operation at slow airflow rate.

### 4 When you want to quickly clean the air

Press the “[TURBO]” [TURBO] button.

- A high airflow rate will quickly remove any dirtiness in the air.
- This is convenient to use when cleaning.

### 5 When you want to remove pollen

Press the “[ANTI-POLLEN]” [ANTI-POLLEN] button.

- Switching the airflow speed every 5 minutes between “M (Standard)” and “L (Low)” will catch pollen before they fall on the floor.

### 6 When you expel negative ions

Press the “[RELAX]” [RELAX] button.

Pressing again will cancel.

- Generates negative ions.

### 7 When you want to decide a time to stop operation

Press the “[OFF TIMER]” [OFF TIMER] button.

- Each time it is pressed the timer setting switches as shown below. The remaining time will be lit in the “OFF timer setting indicator”.

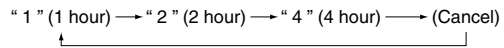

- When the set time is reached, the operation will automatically stop.
- The set time can be changed if the button is pressed while the timer is operating.

### 8 When you want to change the brightness of the operation lamp and clean monitors

Press the “[BRIGHTNESS]” [BRIGHTNESS] button.

- Each time it is pressed, the display will switch as shown below.

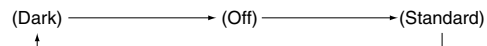

### 9 When you want to prevent incorrect operation

Press the “[LOCK]” [LOCK] button for 2 seconds.

Pressing again for 2 seconds will cancel.

- Stops the function of the button other than the “[LOCK]” button on the main unit and buttons on the remote controller.
- This makes it possible to prevent children from operating the unit incorrectly.
- When you want to release the child lock settings and the remote controller is not in your hand, remove the power plug once and then reinsert it and operate the unit.

## ■ When you want to operate the unit using the button on the main unit

When the remote controller is not in your hand, you can use the “[Operation Switch / Stop]” button on the main unit without using the remote controller. (page 4.)

### — NOTE —

- The unit will not operate for 3 seconds after the front panel or plasma ionizer is set or power plug is inserted even though “[ON/OFF]” button on the remote controller is pressed.
- Operation will stop for safety when the front panel is opened during operation.
- When an incorrect operation is performed during operation If the main unit display is abnormally on or remote controller is disabled due to thunder or radio transmission during operation, pull the power plug and then re-insert it after 3 seconds.

## 4.4 Care and Cleaning

# Care and Cleaning

### ■ Cleaning chart

For cleaning, remove each part in the number order.  
For restoring each part, follow the opposite order.

#### ⚠ CAUTION

- Stop operation and pull the power plug before cleaning.

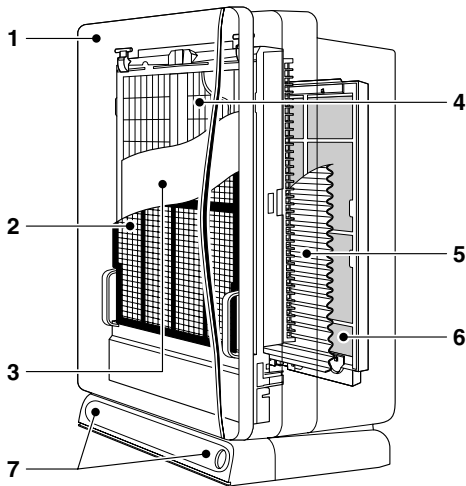

- 1 Front panel** (page 8.)  
If gets dirty; **wipe off**
- 2 Pre-filter** (page 9.)  
Once in two weeks; **clean**
- 3 Bio-antibody filter** (page 9.)  
1 year after opening; **replace**  
**Unwashable**
- 4 Plasma ionizer** (pages 11, 12.)  
If the cleaning sign blinks;  
  - Opposing pole plate; **soak**
  - Streamer discharger; **soak**
  - Ionizing frame (ionized wire); **soak**
- 5 Pleated filter** (page 10.)  
If the replacement sign turns on or blinks; **replace**
- 6 Deodorizing catalyst unit** (page 15.)  
If it gets dirty, without removing from the main unit; **vacuum**  
**Unwashable**
- 7 Air inlet for the dust/odor sensor** (page 8.)  
If clogged; **vacuum**

#### ⚠ WARNING

**During maintenance you must stop the operation and remove the power plug from the electrical outlet.**  
Electric shock or injury may occur.

#### ⚠ CAUTION

**Do not wash the main unit with water.**  
If water gets inside the unit, electric shock or malfunction may occur.



### ■ Cleaning the air inlet for the dust/odor sensor

- Clean dusts clogged in the air inlet for the dust/odor sensor.
- Use crevice nozzle of a cleaner for cleaning.

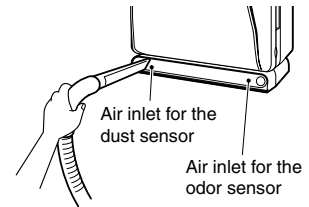

### ■ Cleaning the front panel

- Wipe off the dirt with a cloth or tissue slightly soaked with water.
- In the case of heavy dirt, wipe it off with a cloth soaked with mild detergent.

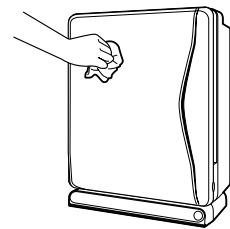

#### ⚠ CAUTION

- Do not use hard sponge. Scratch may result.

#### ⚠ WARNING

- Do not use gasoline, benzene, thinner, polishing powder, kerosene or alcohol. Crack, electric shock or fire may result.
- Do not rinse the main unit. Electric shock, fire or breakdown may result.

### ■ ATTENTION

- **Be careful not to scratch the front or damage the rear protrusions of the removed front panel.**  
In particular, the rear protrusions function as a safety switch to turn OFF the power if the front panel is opened.  
If damaged, the unit will not operate.

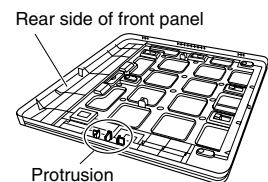

### ■ NOTE

**If the front panel is not correctly set on the main unit, the unit will not operate.**

#### ⚠ WARNING

- Do not touch the safety switch on back of the hole on bottom of the main unit.  
Electric shock may result.

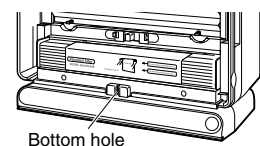

# Care and Cleaning

## ■ Cleaning the pre-filter

It is recommended to clean the pre-filter every two weeks.

### 1. Remove the front panel.

- Lay your finger to the dent at bottom of the main unit, hold bottom part of the panel and then pull it up.

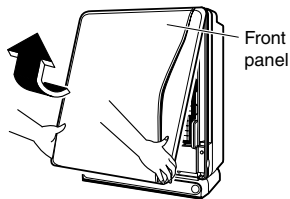

### 2. Remove the pre-filter.

- Remove by pulling out in front while holding the tabs on top of the pre-filter.

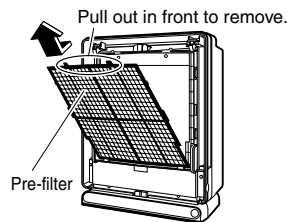

### 3. Clean the pre-filter.

- After using a vacuum cleaner to remove any dust, clean with water.
- If it is very dirty, use a soft brush or a neutral cleaner to clean then dry well in the shade.

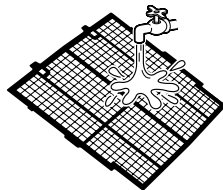

## ■ NOTE

- "Cleaning sign" may blink if any droplet remains.

### 4. Install the pre-filter in its original position.

- Hook the bottom part of the pre-filter on the bottom hooks (2 locations) of the plasma ionizer and then insert it into the left and right hooks (4 locations).

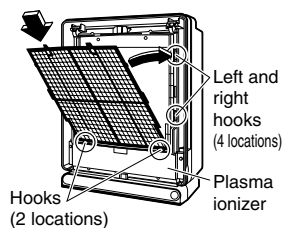

### 5. Restore the front panel.

- Hook the top hooks (3 locations) of the front panel on the grooves on top of the main unit and then close the panel.

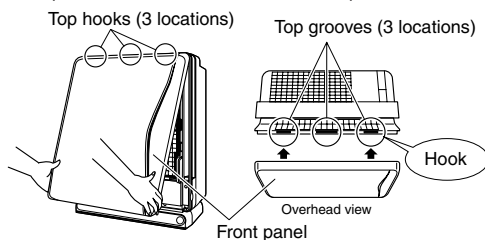

## ■ NOTE

- Securely close the panel. Failing to do so may cause activation of the safety switch and out of unit operation.

## ⚠ CAUTION

- Do not dry at a location directly exposed to the sun.
- Do not clean with water hotter than 50°C.
- Do not burn with fire. Color changes or deformation may occur and the unit may become unusable.

## ■ Replacing the bio-antibody filter (The bio-antibody filter should be replaced around once a year.)

### 1. Remove the front panel. (See the left figure.)

### 2. Remove the pre-filter. (See the left figure.)

### 3. Replace the bio-antibody filter with new one.

- Remove a used bio-antibody filter from the hooks (2 locations) on top of the plasma ionizer.
- Hook the holes (2 locations) of a new bio-antibody filter on the hooks (2 locations) on top of the plasma ionizer.

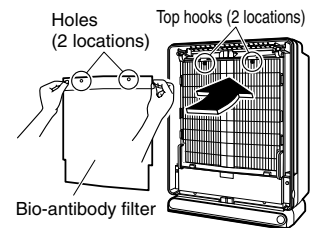

### 4. Install the pre-filter in its original position. (See the left figure.)

### 5. Restore the front panel. (See the left figure.)

## ■ NOTE

### Replacing the bio-antibody filter

- Contact your dealer for replacement bio-antibody filter.
- Life of the bio-antibody filter is about 1 year after opening.
- If you do not use the bio-antibody filter for a long time, store it away from direct sunlight without opening.

**■ Replace a pleated filter**

(Replace the pleated filter when the “replace indicator” on the main unit display turns on or blinks.)

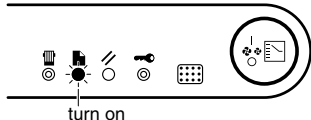

1. Remove the front panel. (page 9.)

2. Remove the plasma ionizer.

- Holding the handle, lift towards yourself and remove from the top 2 hooks.

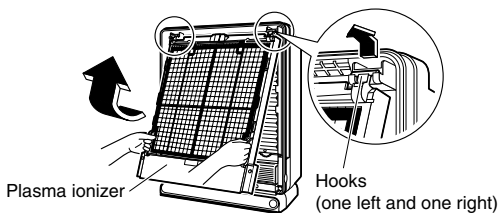

3. Replace a pleated filter with new one.

- 1) Remove a used pleated filter.
  - Remove a pleated filter from the tape at bottom of the deodorization catalytic unit and then unhook the hooks (3 locations on top and 2 locations on bottom).

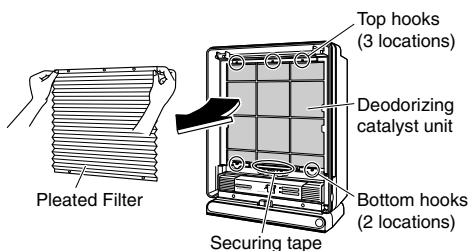

- 2) Take out a new pleated filter (1 sheet) and then attach it to the deodorization catalytic unit.
  - Hook on top and bottom hooks, insert into left and right hooks and then secure with the tape.
- 3) Place the pleated filter holes on the 3 upper tabs of the deodorizing catalyst unit.

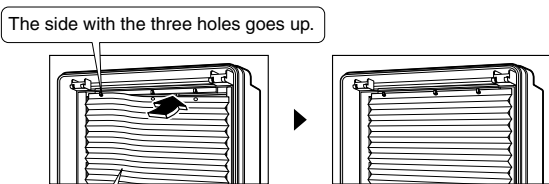

The white side should be facing you.

- 4) Hook the holes of the pleated filter on the bottom hooks. (2 locations)

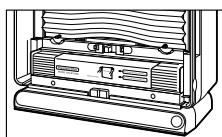

- 5) Insert the pleated filter into the left and right hooks.

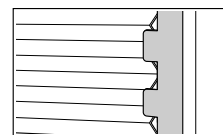

- 6) Secure the pleated filter with the tape.

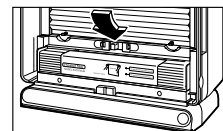

4. Restore the plasma ionizer and the front panel. (page 6.)

5. Insert the power plug.

6. Press the reset switch on the main unit display.

Press the reset switch with a sharp material such as a tooth pick to turn off the replacement sign. (It will beep.)

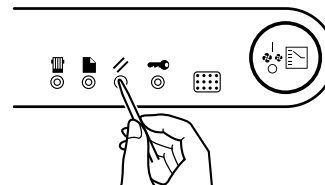

**— NOTE —**

**Replace a pleated filter**

- Contact your dealer for replacement pleated filter.
- It is not necessary to replace a pleated filter until the replacement sign turns on or blinks. When the replacement sign turns on, replace a filter even though it is not dirty.
  - \* Apparent dirt is not proportional to filter performance.
- The replacement timing of the pleated filter differs depending on usage and installed place. The replacement sign turns on after a year of everyday use in a home where 10 cigarettes are smoked per day. (The replacement timing will be shorten for use in a heavily air polluted place.)

**■ Remove the plasma ionizer**

**⚠ CAUTION**

- When cleaning be careful not to cut your hands on the ionizing line. (Wearing rubber gloves is safer.)

1. Remove the front panel.

- Lay your finger to the dent at bottom of the main unit, hold bottom part of the panel and then pull it up.

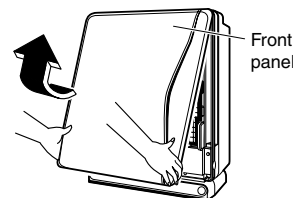

2. Remove the pre-filter. (page 9.)



# Care and Cleaning

### 3. Remove the bio-antibody filter.

- Remove the bio-antibody filter from hooks (2 locations) at top of the plasma ionizer.

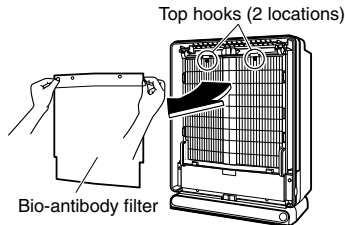

### 4. Remove the plasma ionizer.

- Holding the handle, lift towards yourself and remove from the top 2 hooks.

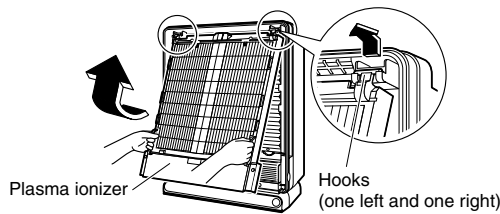

### 5. Remove the opposing pole plates at back of the plasma ionizer.

- Open the knob of the ionizer frame and hold up the opposing pole plate to remove.

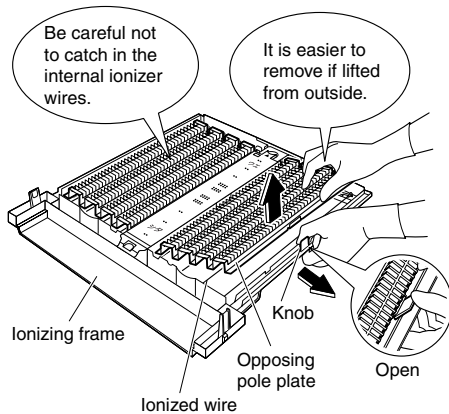

### 6. Remove the streamer discharger.

- Insert your finger into the hole on top (hole with ▲ mark) and then gently pull up the streamer discharger.

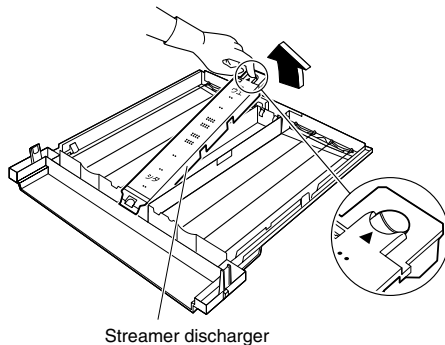

### ■ Clean the plasma ionizer

(If “cleaning sign” on the main unit display blinks)

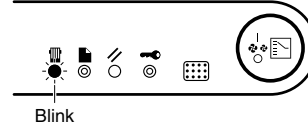

### ⚠ CAUTION

- Stop operation before cleaning and be careful not to cut your hands with the opposing pole plate or ionizer wires. (It is safer to use rubber gloves.)

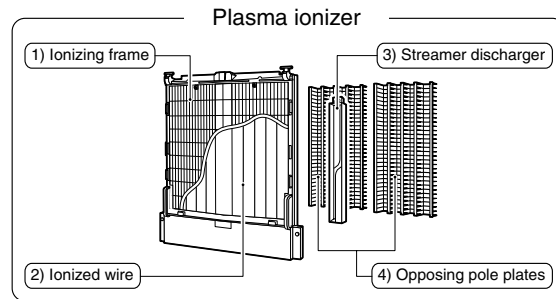

### ⚠ CAUTION

### ■ There are ionizer wires at back of the opposing pole plate. When attaching or removing, be careful not to cut them.

- “Cleaning sign” blinks if operated while the ionizer wires are cut. The dust elimination efficiency deteriorates while the sign is blinking.
- If the ionizer wires should be cut, replacement is necessary. Contact your dealer.

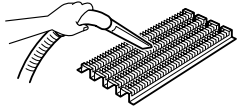
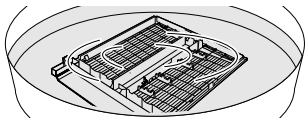
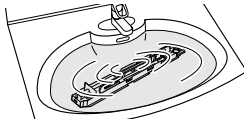
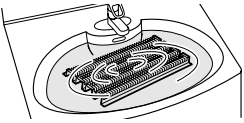
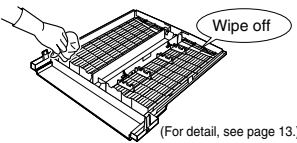
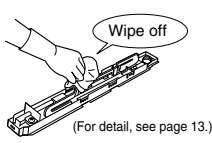
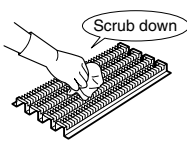
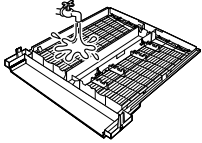
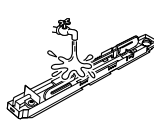
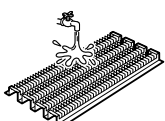
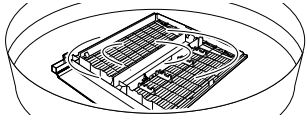
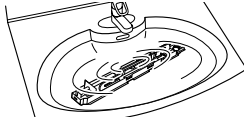
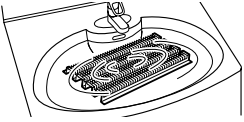
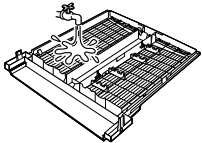
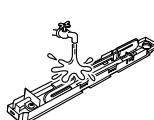
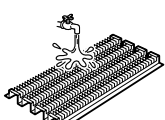
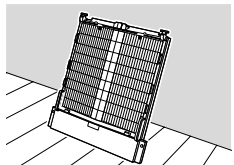
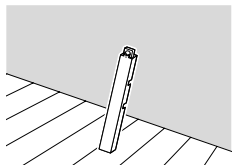
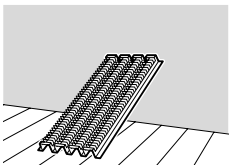
Contents	1) Ionizing frame	2) Ionized wire	3) Streamer discharger	4) Opposing pole plate
Remove each part. (page 11.)	(page 11.)		(page 11.)	
Vacuum dusts on the surface with a cleaner. <b>Vacuum</b>				
▼	<b>Caution</b> <ul style="list-style-type: none"> <li>Do not remove the screws on the ionizer or streamer discharger. Breakdown may result.</li> </ul>			
Soak in water or warm water with liquid mild detergent. (about 1 hour) <b>Soak in water with detergent</b>				
Clean off the dirt with a cloth or soft brush. <b>Wipe the dirt off</b>				
▼	<b>Caution</b> <ul style="list-style-type: none"> <li>Be sure to do in a shower-proof place such as bathroom or sink in a kitchen.</li> <li>Use only specified volume of liquid mild detergent.</li> <li>Do not use powder detergent or alkaline detergent and scrub with hard sponge. Distortion or damage to the equipment may result.</li> </ul>			
Rinse with running water. <b>Rinse well</b>				
▼				
Soak in water or warm water to remove detergent. (about 30 minutes) <b>Soak in water or warm water</b>				
▼	<b>Caution</b> <ul style="list-style-type: none"> <li>Soak well, as "cleaning sign" may be on even after cleaning if any detergent remains.</li> </ul>			
Rinse with running water and then dry. <b>Rinse well</b>				
▼	<b>Caution</b> <ul style="list-style-type: none"> <li>Be careful not to leave bits of tissue such as cloth. Malfunction may result.</li> </ul>			
Dry in the breezy shade. (about 1 day) <b>Dry in the shade</b>				
▼	<b>Caution</b> <ul style="list-style-type: none"> <li>Do not expose to direct sunlight. Resin part may be discolored or distorted.</li> <li>Dry in the shade, as "cleaning sign" may be on even after cleaning if any moisture remains.</li> </ul>			
Attach each part. (page 14.)	(page 14.)		(page 14.)	



# Care and Cleaning

**CAUTION**

- When cleaning the unit, be careful not to cut your hands with the opposing pole plate or ionizer wires. (It is safer to use rubber gloves.)
- When cleaning the unit, be careful not to cut the ionizer wires.
- Be sure to do in a shower-proof place such as bathroom or sink in a kitchen.
- Use only specified volume of liquid mild detergent.
- Do not use powder detergent or alkaline detergent and scrub with hard sponge. Distortion or damage to the equipment may result.

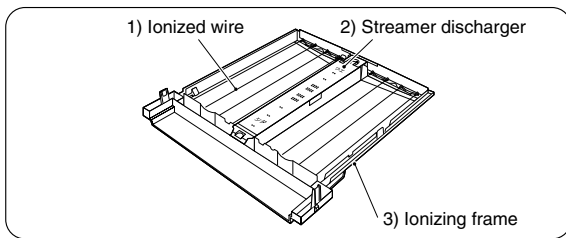

**■ Cleaning the plasma ionizer**

- 1) Ionized wire (8 pieces)
- Clean off the ionizer wires and peripheral resin part with a soft cloth.

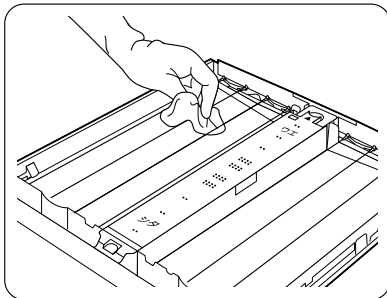

\* Gently wipe off the ionizer wires. Pulling hard may cut them.

- 2) Streamer discharger
- Clean off the internal resin part with a soft cloth. (For removal, see page 11.)

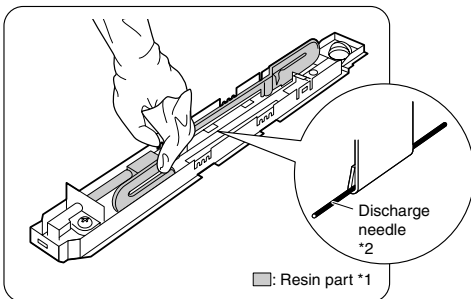

- \*1 Wipe off only the resin part.
- \*2 Do not touch the discharge needle. Bending the needle will reduce deodorizing performance.

- 3) Ionizing frame
- Clean off the resin part with a soft cloth.
  - Use a cotton bud to wipe off dirt of odd-shaped area where your finger does not reach.
  - Be careful not to leave bits of tissue. Malfunction may result.

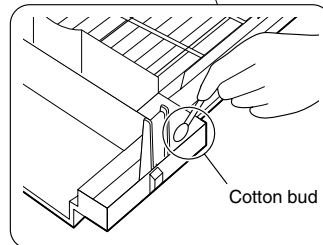
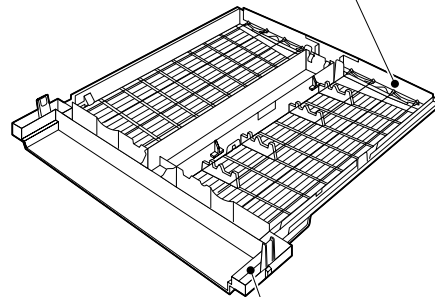
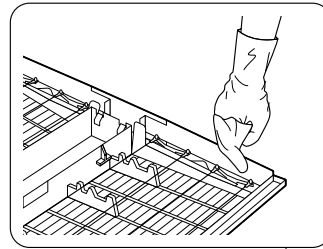

\* Use a cotton bud to wipe off dirt of odd-shaped area.

**NOTE**

**If the ionizer wires are cut;**  
Replacement is necessary. Contact your dealer.

## ■ Assembling the plasma ionizer

### 1. Attach the opposing pole plates.

- 1) Securely insert the opposing pole plate into the hooks (2 locations in the middle) of the plasma ionizer.

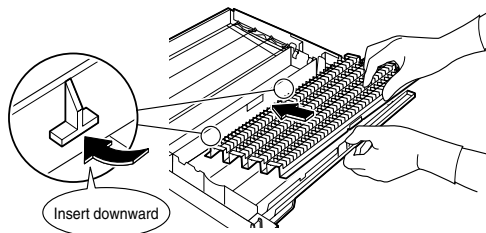

- 2) Attach the opposing pole plate while opening the knobs (one at a side) of the plasma ionizer.

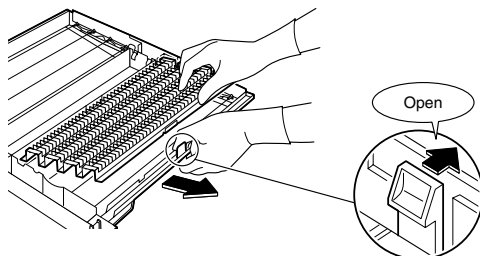

- 3) Insert securely until it clicks.

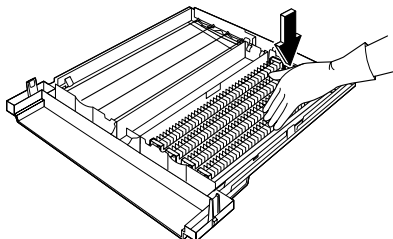

- 4) Attach another side of the opposing pole plate.

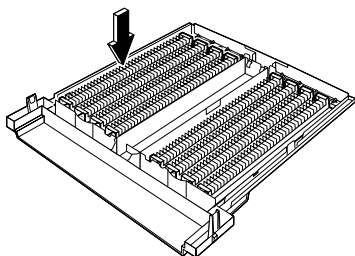

### 2. Attach the streamer discharger.

- 1) Insert bottom of the streamer discharger to the ionizer frame.

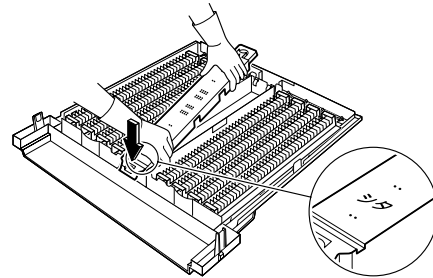

- 2) Insert top of the streamer discharger.

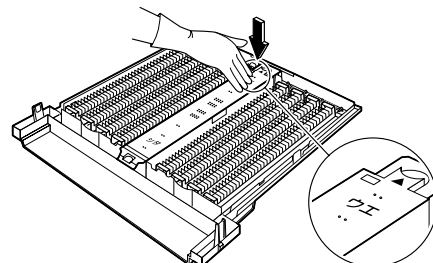

- 3) Confirm if it is attached securely.

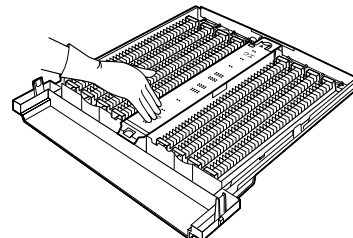

# Care and Cleaning

## ■ Cleaning the deodorization catalytic unit

- Vacuum dusts with a cleaner without removing from the main unit. (Do not wash.)

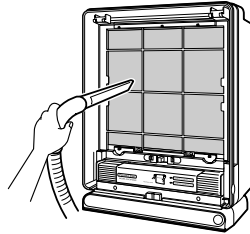

## ■ Sensitivity settings of the dust sensor

The sensitivity of the sensor differs depending on the size of room, installation place, and type of dirt. Change the sensor sensitivity if you don't like it.

1. Press “” on the main unit for 10 seconds with the remote controller pointed at the main unit while holding “” .
  - The receiving tone sounds, one of “” L (Low), “” M (Standard) and “” H (High) lamps blinks for 5 seconds, and then the lamp corresponding to the set sensitivity turns on.
2. Change the settings using the “” [Operation switch/ Stop] button of the main unit.
  - Switches each time it is pressed.
  - The settings is shown in the airflow rate indicator.

Airflow speed display	“” L (Low)	“” M (Standard)	“” H (High)
Dust sensor sensitivity	High (Sensor display becomes easy to light.)	Normal (setting when shipped)	Low (Sensor display will have difficulty coming on.)

3. When you decide on the settings, point the remote controller at the main unit and press the “” [OFF TIMER] button.
  - The receive sound will beep and the setting lamp will flash.
4. Unplug the power plug one time and then after 3 seconds or more plug it in again.
  - This completes the settings.

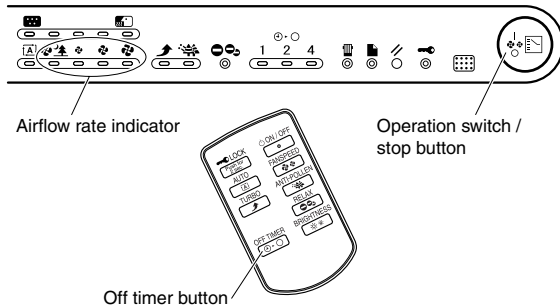

## ■ NOTE

- If the operation of 4. is not performed, the unit will not return to normal operation mode. If the operation of 4. is performed, during the settings, the settings will not be correct.
- When the sensitivity is set high, it will become difficult for the sensor lamp to go out.

## ■ Optional accessories

- For replacement pleated filter and bio-antibody filter, contact your dealer.

Part name	Part number
Pleated filter (7 sheets)	KAC972A4E
Bio-antibody filter (1 sheet)	KAF972A4E

- If used with dirty parts;
  - Cannot obtain air clean effect.
  - Cannot obtain deodorization effect.
  - Odor may arise.

## ■ Disposal requirements

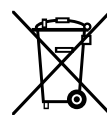

Your Daikin product is marked with this symbol. This means that electrical and electronic products shall not be mixed with unsorted household waste. Disposal of this product must be done in accordance with relevant local and national legislation. By disposing of this product correctly, you will help ensure its proper treatment, recovery and recycling, thus preventing potential negative consequences for the environment and human health. Please contact your local authority for more information. Batteries must be removed from the remote controller and disposed of separately in accordance with relevant local and national legislation.

## 4.5 Troubleshooting

### Frequently asked questions

Question	Answer
1. The dust sensor does not change from the red (green) lamp.	This is due to dusts built up in the dust sensor. Vacuum dusts from the air inlet with a crevice nozzle of a cleaner and then manually operate the unit for a while. The sensor will go back to normal.
2. The sensitivity of the dust sensor seems to be bad (or too good).	This is because react time of the dust sensor differs depending on the size of room. If the unit is installed at the lower position of a room, reaction to smoke of cigarettes or others may be bad. Re-install the unit at the higher place such as on a shelf. If the sensitivity is still bad, adjust the sensor with sensitivity settings.
3. Can I wash the deodorization catalytic unit? Is replacement necessary?	The deodorization catalytic unit cannot be washed. (The unit will be ruined.) Vacuum dusts with a cleaner without removing from the main unit. Replacement is not necessary.
4. What to do if the ionizer wires are cut?	If the ionizer wires should be cut, replacement is necessary. Contact your dealer.
5. Is not a problem to use while the cleaning sign is blinking?	While the cleaning sign is blinking, electric dust collection and deodorization functions remarkably deteriorate as electricity supply to the ionizer wires and streamer discharger stops for safety. Be sure to inspect inside until the sign turns off. (Blinking is not a problem from a safety viewpoint.)

### Trouble Shooting

#### ■ Investigate the problem once again before requesting repairs.

Case	Check	Measure
Does not operate.	Is the power plug unplugged?	Securely insert it.
	Is the front panel correctly set?	Securely set it.
	Are the battery of the remote controller dead?	Replace with new battery. (page 5.)
The four airflow rate displays, LL (Quiet), L (Low), M (Standard) and H (High) are flashing at the same time.	Is there any foreign matter in the air outlet?	Remove the foreign matter. For other cases, contact your dealer.
Air does not come out.		
Cleaning effect is not obtained.	Is the unit installed at a location where the flow does not pass or are there obstructions close to the unit?	Remove the obstruction.
	Is there too much dust in the pre-filter or pleated filter?	Clean or replace. (pages 5, 6, 9)
	Is too much odors or smoke being generated?	For this case, contact your dealer.
Television screen is distorted.	Is a television or radio installed within 2m of this unit or is an indoor antenna being used close to this unit?	Separate the television, radio and indoor antenna from this unit by 2m or more.
	Is the power cord or antenna of the television or radio close to this unit?	Separate the power cord and antenna of the television or radio as much as possible away from this unit.
Crackling, buzzing, and fizzes sounds are audible during operation.	Is the plasma ionizer securely set?	Securely set it.
	Is dust adhering to the ionizing line of the plasma ionizer (resin part)?	Clean the plasma ionizer. (pages 11, 12.)
	Has water entered into the spurt hole moistening the negative ionization assembly?	If the negative ionization assembly is dry, the sound will go away.
	The streamer discharger makes a fizzes sound.	This is not abnormal.
Odor is coming from the air outlet.	Is a large amount of odor being generated temporarily? (Many people smoking or grilling meat.)	If operated, the odor will gradually go away.
	Have you moved the main unit to another room?	Odor from the original room may smell.
	If the pre-filter or plasma ionizer dirty?	Clean it. (pages 9, 11, 12, 13.)
The cleaning sign does not turn off or blinks again even after cleaning the plasma ionizer.	Is the plasma ionizer set securely?	Securely set it.
	Are not droplets left in the opposing pole plates or other places?	Wipe off droplets.
	Are not bits of tissue left in the plasma ionizer?	Remove bits of tissue.
	Did you rinse and soak the plasma ionizer well after washing the plasma ionizer with detergent?	Soak well.
	Are not the ionizer wires cut?	Contact your dealer.

## 5. Optional Accessories

### 5.1 Dimensions

#### 5.1.1 Pleated Photocatalytic Filter

**KAC972A4E**

Specifications	
Item	Model
	KAC972A4E
Material	Non-woven fabric (electrostatic) (Antibacterial and antiviral agent impregnated)
No. of packages	7

Notes: 1. Replacement guideline: Every year (for about 7 years in total)  
2. Appearance color: White (front), blue (back)

C:3JHB10512

#### 5.1.2 Bio-Antibody Filter

**KAF972A4E**

Specifications	
Item	Model
	KAF972A4E
Material	Polyester/rayon non-woven fabric
No. of packages	(a) Filter 1 (b) Sheet 1

Notes: 1. Replacement guideline: About 1 year (after unpacking)  
2. Appearance color: White

[Storage and handling precautions]

- If you do not use the filter soon, store it in a cool, dry place that is not exposed to direct sunlight.
- The filter color density may become different for production technique reasons. The performance is not affected.
- Unpack the filter just before use. (Otherwise the performance may be affected or the quality degraded.)
- Dispose of the vinyl bag just after unpacking. Otherwise a child may play with it (pulling it over his/her head, for example), resulting in an accident.
- Keep the package out of children's reach.
- Dispose of a used filter as noncombustible waste. For details, follow your local waste sorting rules and regulations.

C:3JHB10513

## 6. Troubleshooting

### 6.1 Basic Inspection

<p>(1) Is the connector for the PCB plugged in? Or is there any poor connection?</p>	
<p>(2) Is the wire harness broken?</p>	

#### ■ It is not malfunction

Red lamp is blinking.  
Time for cleaning the plasma ionizer.

Red lamp is on or blinking.  
Replace the pleated filter and press the reset button.

#### ■ Troubleshooting with Airflow Rate Indicator

The airflow rate indicators blink simultaneously.  
↓  
The DC fan is locked.

## 6.2 Troubleshooting

### 6.2.1 Equipment does not operate, or operation lamps does not light.



**Caution** Be sure to turn off power switch before connect or disconnect connector, or parts damage may be occurred.

1 Models Covered	5 Troubleshooting	
<p>MC707VM-S MC707VM-W</p>	<p><b>Diagnosis</b></p> <pre>                     graph TD                         Q1{Is AC cord plugged in? Or is breaker "ON"?} -- No --&gt; R1[Plug in AC cord. Set breaker to "ON".]                         Q1 -- Yes --&gt; Q2{Is the panel closed certainly?}                         Q2 -- No --&gt; R2[Close the panel firmly.]                         Q2 -- Yes --&gt; Q3{Do other appliances operate?}                         Q3 -- No --&gt; Q4{Is there power failure?}                         Q4 -- Yes --&gt; R3[Wait for power res- toration.]                         Q4 -- No --&gt; Q5{Is 220-240V supplied?}                         Q5 -- No --&gt; R4[When unspecified voltage is applied, replace power sup- ply PCB. (Varistor or fuse may be damaged.)]                         Q5 -- Yes --&gt; Q6{Is rated voltage within ±10%?}                         Q6 -- No --&gt; R5[Contact power company.]                         Q6 -- Yes --&gt; Q7{Is operation possible with remote controller?}                         Q7 -- Yes --&gt; R6[Replace ON/OFF switch cover. (Replace display PCB).]                         Q7 -- No --&gt; Q8{Is operation possible with ON/OFF switch?}                         Q8 -- Yes --&gt; R7[Go to "6.2.2. Remote controller sends signals errat- ically".]                         Q8 -- No --&gt; P1[Remove panel.]                         P1 --&gt; Q9{Is protrusion on the rear panel damaged?}                         Q9 -- Yes --&gt; R8[Replace panel. *Protrusion on front panel switch]                         Q9 -- No --&gt; P2[Front panel switch operation check Press front panel switch with a thin stick, then press ON/OFF switch after 5 seconds.]                         P2 --&gt; Q10{Front panel operation lamp light?}                         Q10 -- Yes --&gt; R9[Replace panel (front panel switch is not securely mounted due to deformity).]                         Q10 -- No --&gt; R10[Replace the equip- ment or the power supply and control PCB.]                     </pre>	<p><b>Remedy</b></p>
<p><b>2 Method of Mal- function Detection</b></p>		
<p><b>3 Malfunction Deci- sion conditions</b></p>		
<p><b>4 Supposed Causes</b></p> <ul style="list-style-type: none"> <li>• The unit is not turned on.</li> <li>• Unspecified voltage is used.</li> <li>• The safety device is activated due to poor assembly of the panel.</li> <li>• Front panel switch is defective.</li> <li>• The PCB is defective.</li> </ul>		

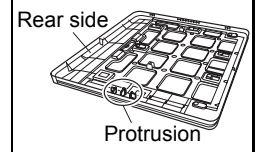

### 6.2.2 Remote controller sends signals erratically.



**Caution**

Be sure to turn off power switch before connect or disconnect connector, or parts damage may be occurred.

<p><b>1 Models Covered</b></p> <p>MC707VM-S MC707VM-W</p>	<p><b>5 Troubleshooting</b></p>	
<p><b>2 Method of Malfunction Detection</b></p>	<p><b>Diagnosis</b></p> <pre> graph TD     D1{Is battery correct? (2.5V or more?)} -- No --&gt; R1[Replace battery.]     D1 -- Yes --&gt; P1[Check if infrared signal is sent from remote control. (Check with an infrared checker.)]     P1 --&gt; D2{Is signal properly transmitted?}     D2 -- No --&gt; R2[Replace remote controller.]     D2 -- Yes --&gt; P2[Check remote controller for normal operation.]     P2 --&gt; D3{Is there any inverter fluorescent lamps around the unit?}     D3 -- No --&gt; R3[Replace display PCB.]     D3 -- Yes --&gt; R4[Change installation location.]         </pre>	<p><b>Remedy</b></p> <p>*Release child lock.</p> <p>Replace battery.</p> <p>Replace remote controller.</p> <p>Replace display PCB.</p> <p>Change installation location.</p>
<p><b>3 Malfunction Decision conditions</b></p> <p>You can operate with ON/OFF switch on the unit, but not with remote controller.</p>		
<p><b>4 Supposed Causes</b></p> <ul style="list-style-type: none"> <li>• Remote controller battery is exhausted.</li> <li>• Remote controller is defective.</li> <li>• Display PCB is defective.</li> <li>• Malfunction is caused by inverter fluorescent lamps.</li> </ul>		



### 6.2.3 Sensor LED remains lit.



**Caution**

Be sure to turn off power switch before connect or disconnect connector, or parts damage may be occurred.

<h2>1 Models Covered</h2>	<h2>5 Troubleshooting</h2>			
<p>MC707VM-S MC707VM-W</p>	<table border="1"> <thead> <tr> <th data-bbox="569 360 1222 405">Diagnosis</th> <th data-bbox="1222 360 1461 405">Remedy</th> </tr> </thead> </table>		Diagnosis	Remedy
Diagnosis	Remedy			
<h2>2 Method of Malfunction Detection</h2>	<div data-bbox="746 427 1222 931"> <p>&lt;Dust sensor unit LED&gt;</p> <p>Put the plug in a socket while pressing the ON/OFF switch.</p> <p>Does LED light out for about 5 seconds?</p> <p>Yes → It is not malfunction. The sensor is detecting dust in the air.</p> <ul style="list-style-type: none"> <li>• Clean around the sensor.</li> <li>• Change the installation location.</li> </ul> <p>No → Replace the display PCB. (Preferably replace the sensor too.)</p> </div>			
<h2>3 Malfunction Decision conditions</h2>	<div data-bbox="746 1133 1222 1637"> <p>&lt;Odor sensor LED&gt;</p> <p>Check ambient humidity.</p> <p>80%RH or less?</p> <p>No → It is not malfunction. The sensor is detecting moisture in the air.</p> <ul style="list-style-type: none"> <li>• Change the installation location.</li> <li>• Reset the power.</li> </ul> <p>Yes → Wait a while, then check again.</p> <p>Does LED remain lit?</p> <p>Yes → Replace display PCB (Preferably replace the sensor too.)</p> <p>No → It is not malfunction.</p> <ul style="list-style-type: none"> <li>• The sensor may be operating as room is oversized or open.</li> </ul> </div>			
<h2>4 Supposed Causes</h2> <ul style="list-style-type: none"> <li>• Wrong diagnosis (The red LED stays on while the dust sensor or odor sensor is sensing dust and moisture in the air. Such LED light-up has been wrongly judged as an error.)</li> <li>• Sensor failure (The display PCB is in trouble.)</li> </ul>				

## 6.2.4 DC fan locks.



**Caution**

Be sure to turn off power switch before connect or disconnect connector, or parts damage may be occurred.

1 Models Covered	5 Troubleshooting			
MC707VM-S MC707VM-W	<table border="1"> <thead> <tr> <th data-bbox="571 360 1222 405">Diagnosis</th> <th data-bbox="1222 360 1463 405">Remedy</th> </tr> </thead> </table>		Diagnosis	Remedy
Diagnosis	Remedy			
<h3>2 Method of Malfunction Detection</h3>	<div data-bbox="746 427 1222 898"> <pre> graph TD     A[Four airflow rate indicators blink simultaneously.] --&gt; B[Retry to operate with ON/OFF switch.]     B --&gt; C[Airflow rate indicators blink then go off.]     C --&gt; D{Is fan motor connector off?}     D -- Yes --&gt; E[Correct.]     D -- No --&gt; F[Replace the fan motor.]           </pre> </div> <div data-bbox="1238 562 1463 1088"> <p>NOTE: If connector is unplugged with unit turned on, fan motor may be damaged. (Turn off power before plugging in connector.)</p> <p>• When the indicators blink after restarting, replace the power supply and control PCB.</p> </div>			
<p>Abnormality of the fan motor is detected by revolutions with the Hall IC while the fan motor is running.</p>				
<h3>3 Malfunction Decision conditions</h3>				
<p>When the fan motor is not revved up.</p>				
<h3>4 Supposed Causes</h3>				
<ul style="list-style-type: none"> <li>• Fan motor is defective.</li> <li>• Power supply and control PCB is defective.</li> <li>• Connector is off.</li> </ul>				

**6.2.5 LED automatically operates.**



**Caution** Be sure to turn off power switch before connect or disconnect connector, or parts damage may be occurred.

<p><b>1 Models Covered</b></p>	<p><b>5 Troubleshooting</b></p>	
<p>MC707VM-S MC707VM-W</p>	<p><b>Diagnosis</b></p>	<p><b>Remedy</b></p>
<p><b>2 Method of Malfunction Detection</b></p>	<pre> graph TD     A[LED may be in demo mode.] --&gt; B[Exit demo mode.]     B --&gt; C[Unplug unit or turn off power.]     C --&gt; D{Restart. Does unit beep after 3 seconds?}     D -- No --&gt; E[Demo mode is exited.]     D -- Yes --&gt; F[The unit is in demo mode as reset switch is blocked. Check it.]             </pre>	
<p><b>3 Malfunction Decision conditions</b></p>		
<p><b>4 Supposed Causes</b></p> <ul style="list-style-type: none"> <li>• Malfunction (demo mode)</li> <li>• The reset switch is blocked.</li> </ul>		

## 7. Removal Procedure

### 7.1 Removal of the Front Panel / Filters

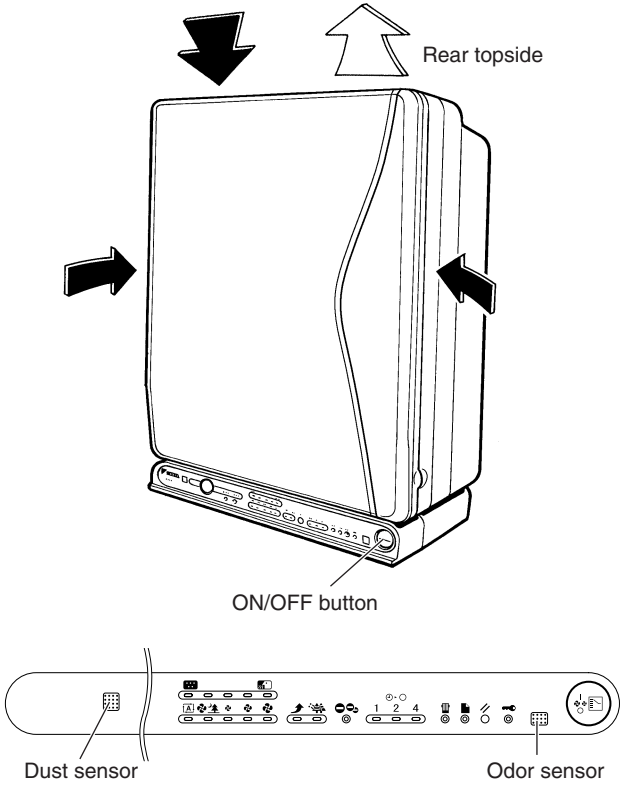
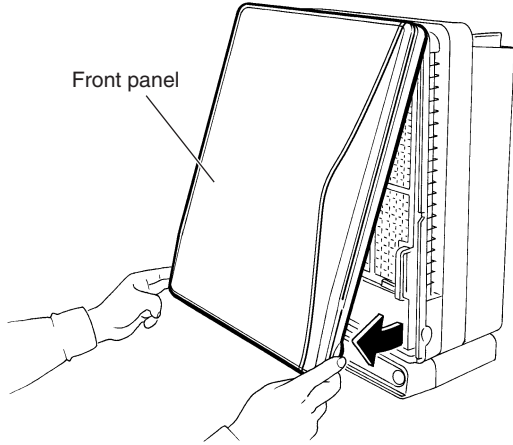

**Warning** Be sure to wait 10 minutes or more after turning off all power supplies before disassembling work.

	Procedure	Points
<p><b>1. Appearance</b></p>		
<p><b>2. Removing the front panel</b></p> <p>(1) Hold both sides of the front panel and pull out the panel toward yourself.</p>		<p>* The upper part of the panel is roundish. When assembling, slide the panel in upright position for easy installation.</p>

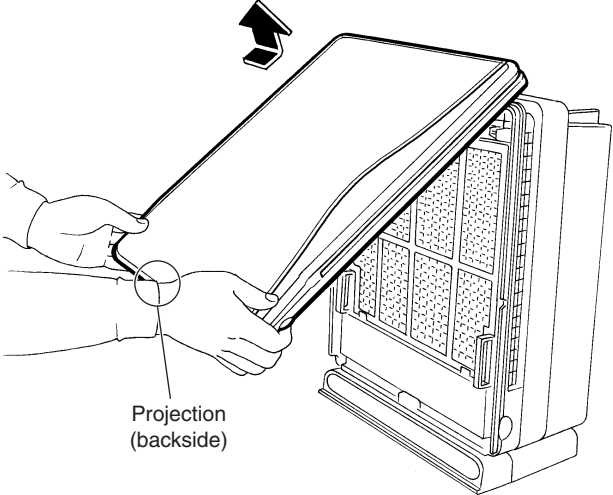
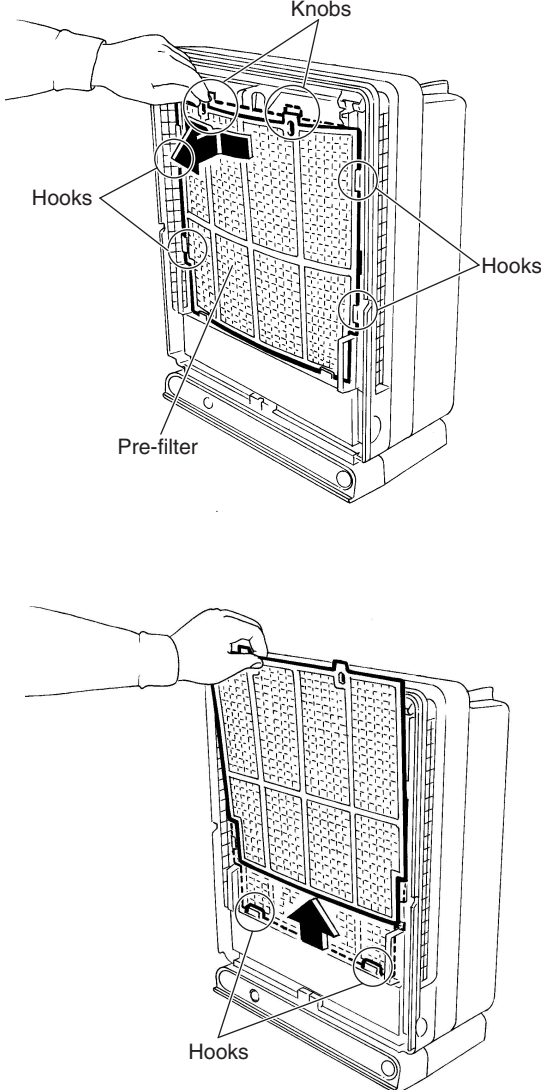
	Procedure	Points
<p>(2) Lift the panel to undo the hooks. Now detach the panel.</p>		<p>* The projection at the back side of the front panel operates the safety switch. Be careful not to transform the projection.</p>
<p><b>3. Removing the pre-filter</b></p> <p>(1) Bend the pre-filter slightly and detach the two upper knobs.</p> <p>(2) Lift the pre-filter and release it from the lower hooks.</p>		<p>* When assembling, catch the lower hooks first and then the right and left hooks.</p>

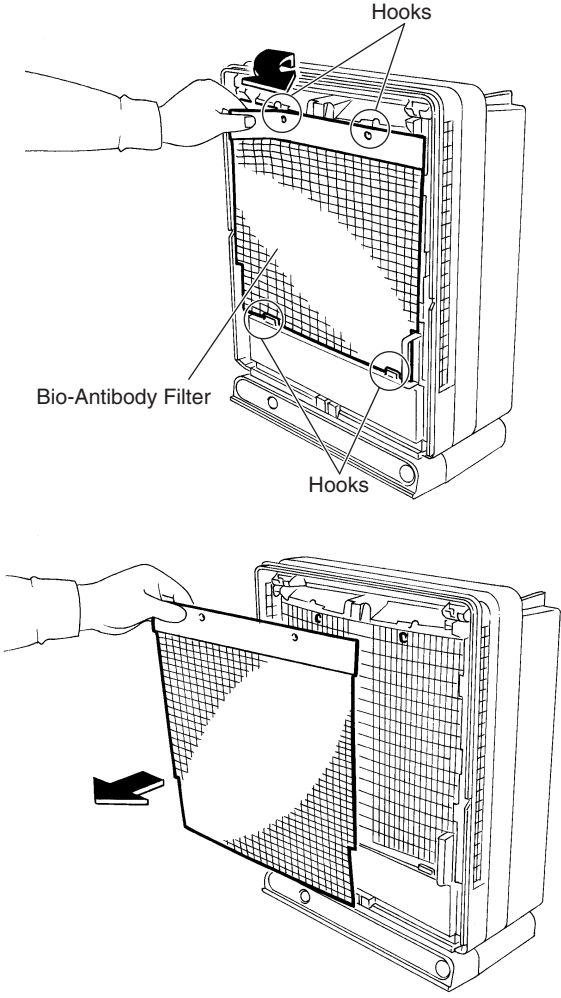
	Procedure	Points
<p data-bbox="145 432 507 510"><b>4. Removing the Bio-Antibody Filter</b></p> <p data-bbox="145 533 507 638">(1) Bend the fixing part slightly to undo upper two hooks.</p>	 <p data-bbox="598 405 1093 907">The diagram consists of two parts. The top part shows a hand reaching into the top of the air purifier's filter compartment. The hand is bending a metal or plastic fixing part at the top edge. Two circular hooks are labeled 'Hooks' with lines pointing to them. A 'Bio-Antibody Filter' is shown as a rectangular mesh with a white circular area in the center. The bottom part of the diagram shows the hand pulling the filter out of the compartment. A black arrow points to the left, indicating the direction of removal.</p>	<p data-bbox="1193 427 1463 629">* When assembling, catch the bottom hooks. (Unless the hooks are caught, the pre-filter, which uses the same hooks, cannot be assembled.)</p>

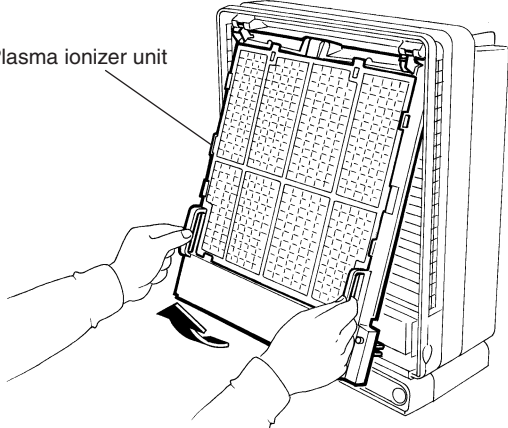
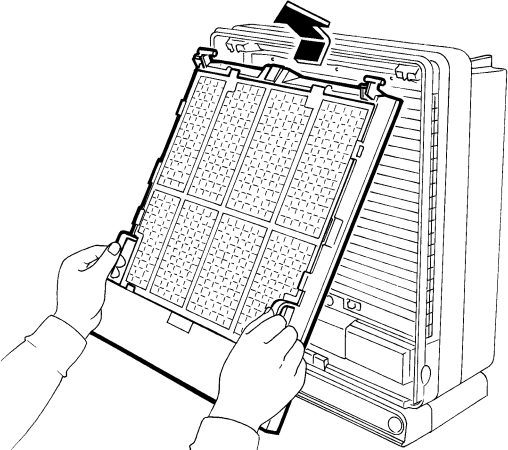
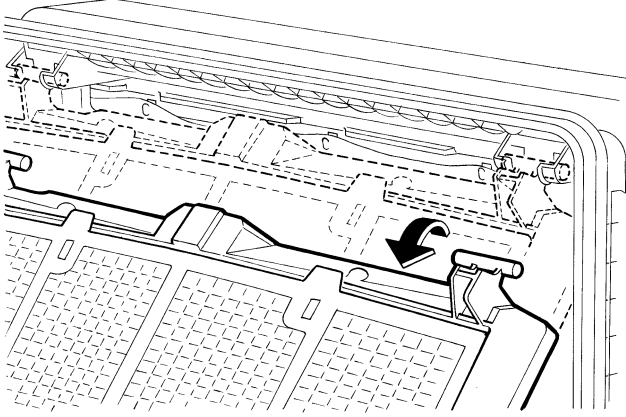
	Procedure	Points
<p data-bbox="148 432 507 510"><b>5. Removing the plasma ionizer unit</b></p> <p data-bbox="148 528 497 712">(1) Hold the grips of the plasma ionizer unit. Pull the unit toward yourself to release its bottom.</p> <p data-bbox="148 972 472 1077">(2) Lift the unit to undo the hooks. Now detach the unit.</p>	<p data-bbox="576 506 762 533">Plasma ionizer unit</p>   	

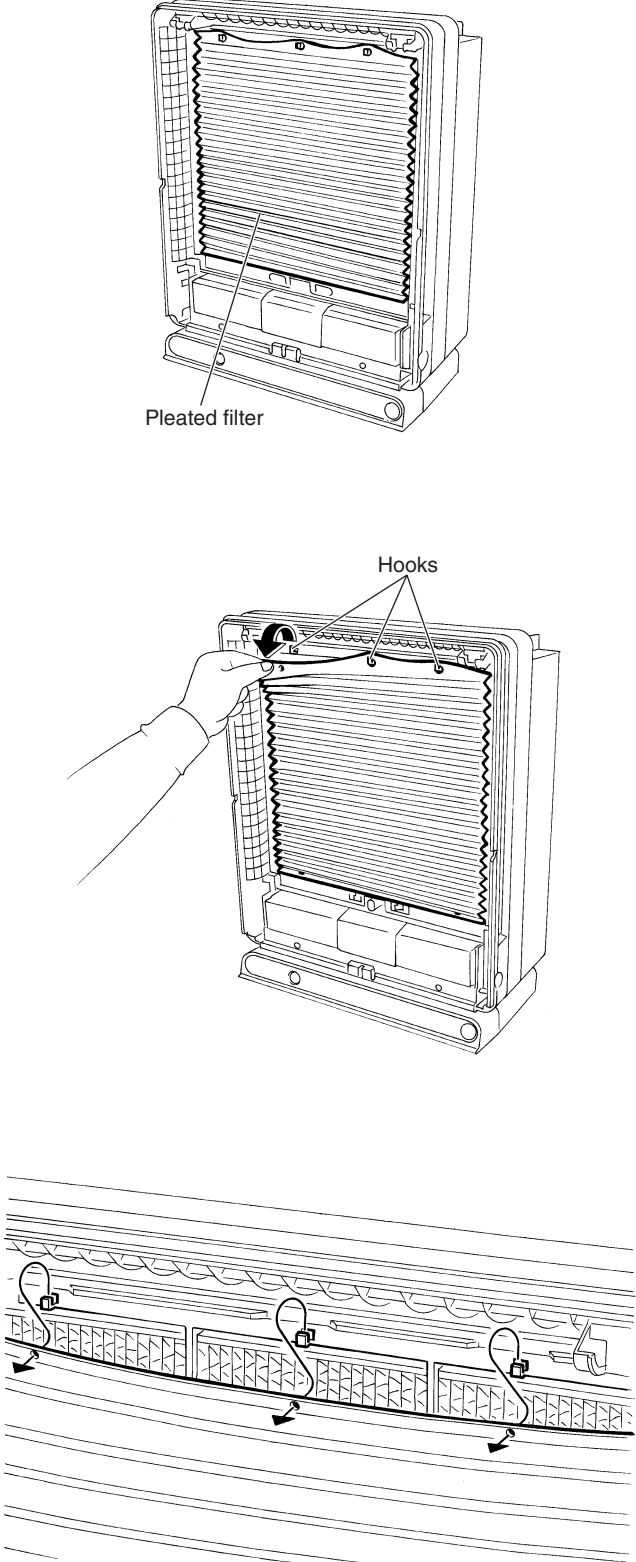
	Procedure	Points
<p data-bbox="148 432 400 510"><b>6. Removing the pleated filter</b></p> <p data-bbox="148 528 411 600">(1) Undo the three hooks.</p> <p data-bbox="148 976 483 1122">(2) The filter is made of fiber. Undo the hook with stretching the filter.</p> <p data-bbox="148 1547 472 1619">(3) Zoomed up view of the upper hooks.</p>	 <p data-bbox="675 846 794 869">Pleated filter</p> <p data-bbox="906 994 970 1016">Hooks</p>	

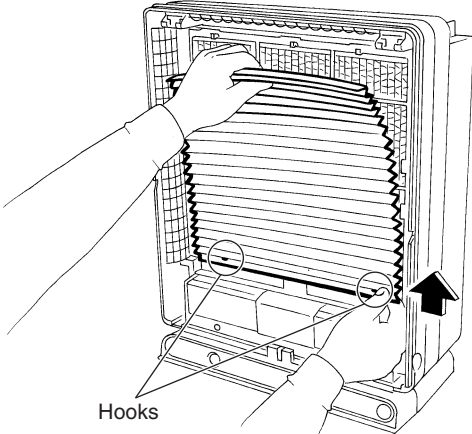
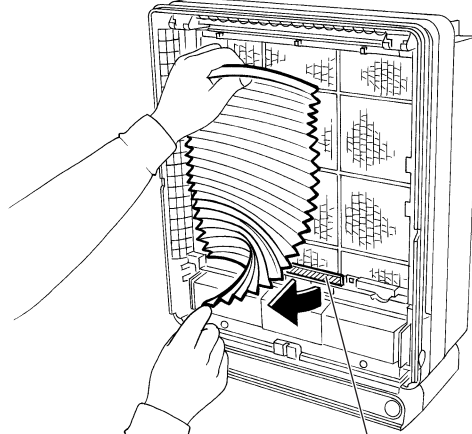
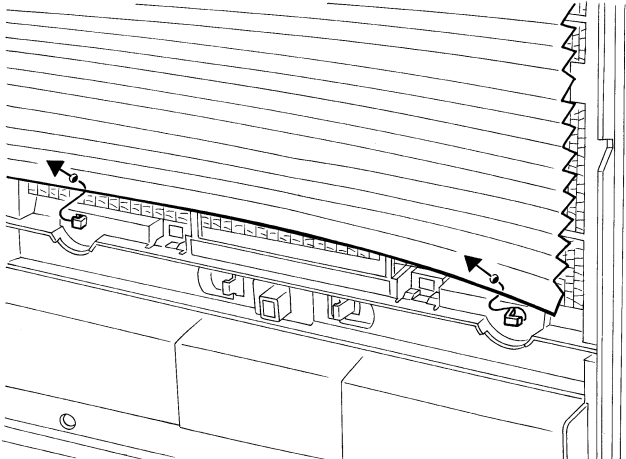

	Procedure	Points
<p>(4) Undo the two bottom hooks and remove the filter.</p>	 <p>Hooks</p>	
<p>(5) A piece of Velcro is at the bottom.</p>	 <p>Velcro</p>	<p>* When assembling, stick the Velcro.</p>
<p>(6) Zoomed up view of the bottom hooks.</p>		

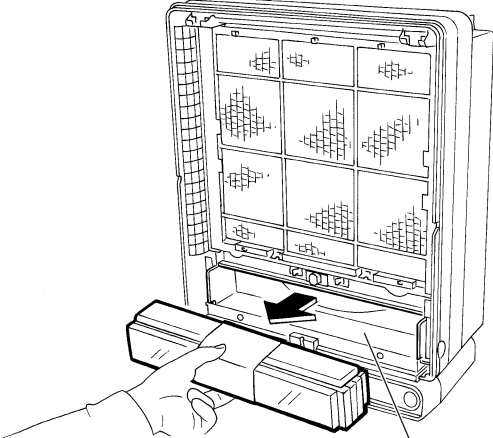
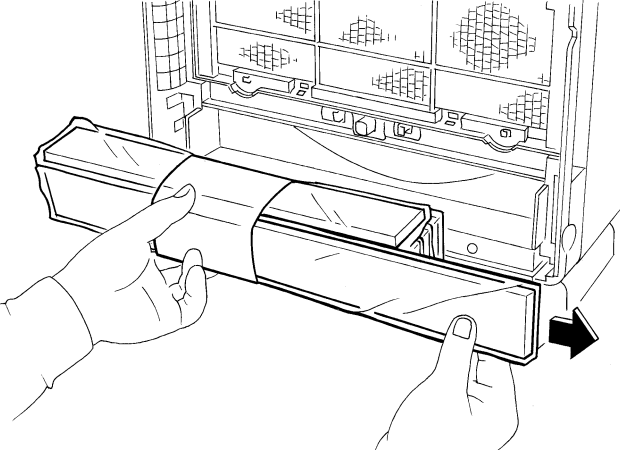
	Procedure	Points
<p data-bbox="150 398 488 472">(7) Take out the spare filter from the holder.</p> <p data-bbox="150 949 443 1055">(8) Take out the filter from the bag and attach it.</p>	 <p data-bbox="927 887 1114 909">Pleated filter holder</p> 	

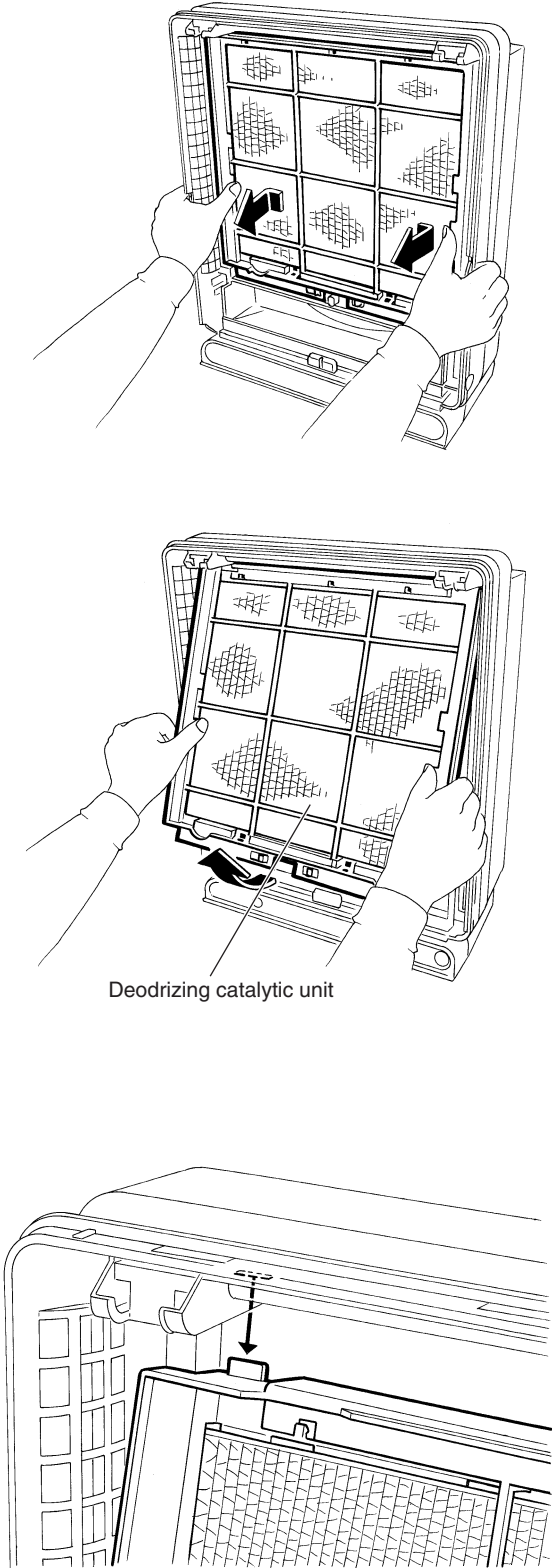
	Procedure	Points
<p><b>7. Removing the deodorizing catalytic filter</b></p> <p>(1) Undo the right and left hooks.</p> <p>(2) Undo the bottom hook and remove the deodorizing catalytic unit.</p>	 <p>Deodorizing catalytic unit</p>	

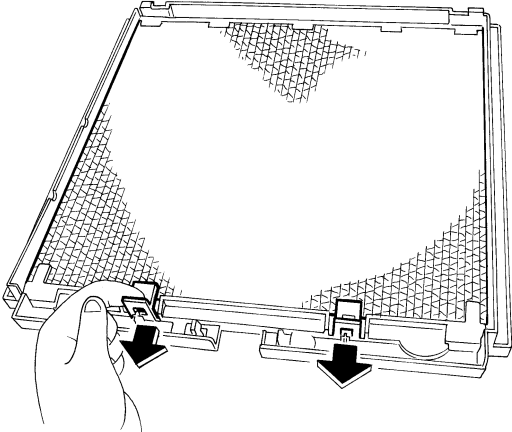
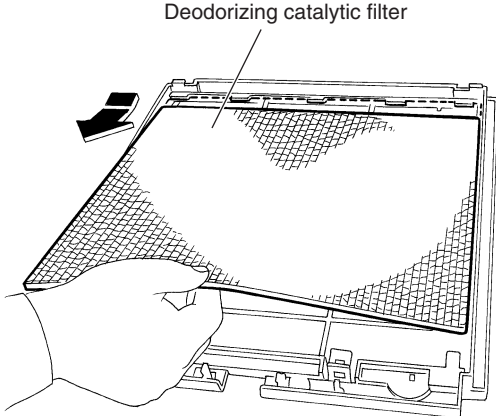
	Procedure	Points
<p>(3) Undo the two hooks at the bottom and remove the deodorizing catalytic filter.</p> <p>(4) When assembling, catch the bottom hooks, slightly bend the filter itself and fit it into position.</p>	 <p>Deodorizing catalytic filter</p> 	

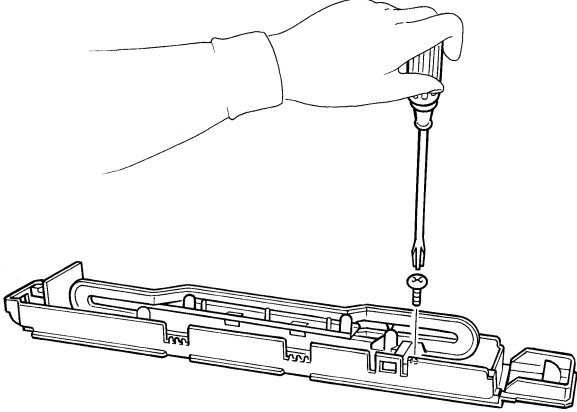
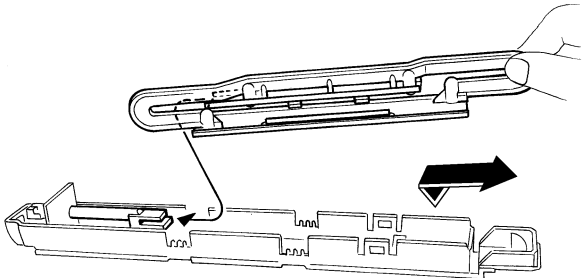
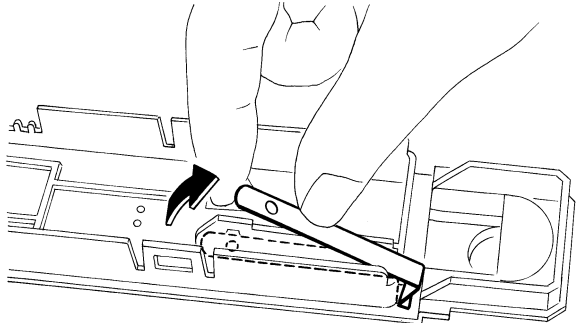

Procedure	Points
<p>(4) Remove the screw.</p>          <p>(5) Lift up and slide the unit to remove it.</p>	   <p>* When assembling, insert the upper narrow sheet metal.</p>



Procedure	Points
<p><b>2. Removing the ionizing wires</b></p> <p>(1) Pinch and detach the ionizing wires with pincers.</p>	<div data-bbox="571 414 1125 869" data-label="Image"> </div> <div data-bbox="528 1059 1166 1547" data-label="Image"> </div> <div data-bbox="1204 1025 1437 1144" data-label="Text"> <p><b>⚠ CAUTION</b> Be careful not to get your hands cut by the ionizing wires.</p> </div> <div data-bbox="1177 1160 1465 1509" data-label="List-Group"> <ul style="list-style-type: none"> <li>* Once removed, the ionizing wires cannot be reused.</li> <li>* When cleaning the ionizing wires, do not remove them. (See the Operation Manual.)</li> <li>* If the air purifier is used with the wire cut, the clean indicator will blink after 24 hours.</li> </ul> </div>



## 7.4 Removal of Fan Motor

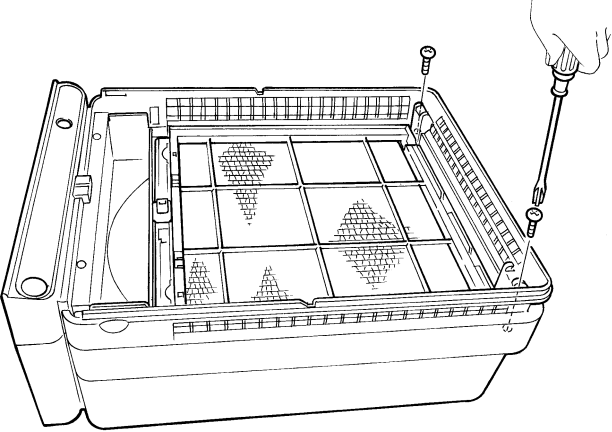
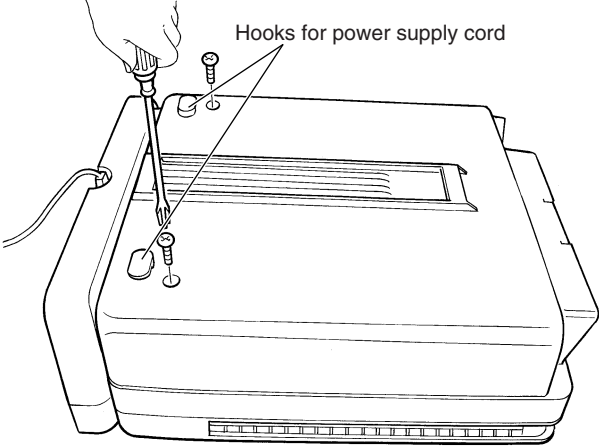
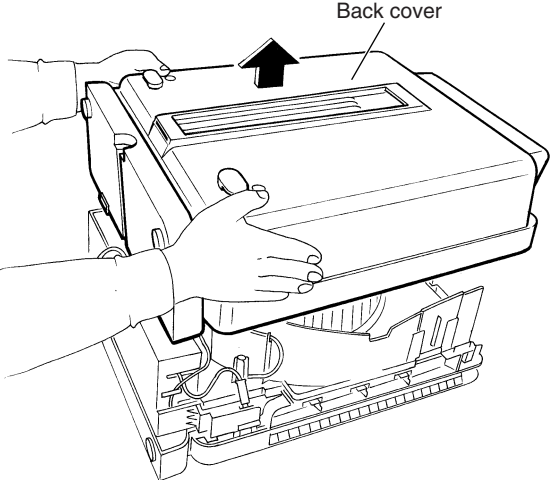

**Warning** Be sure to wait 10 minutes or more after turning off all power supplies before disassembling work.

	Procedure	Points
<p><b>1. Removing the back cover</b></p> <p>(1) Remove the 2 screws from the front top.</p> <p>(2) Remove the 2 screws from the back cover.</p> <p>(3) Lift and detach the back cover from the main body.</p>	  	<p>* Point Note that the screws are provided deep at the front.</p>

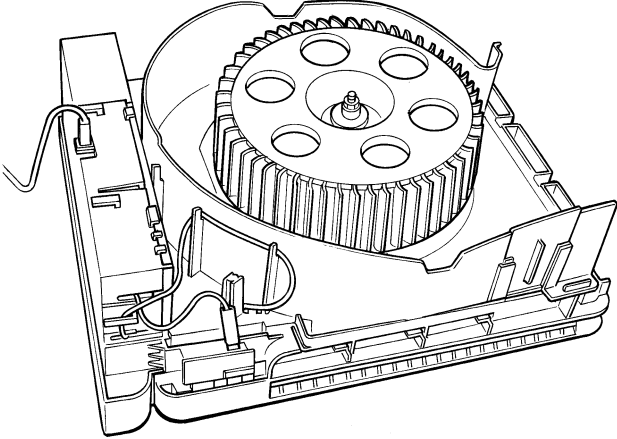
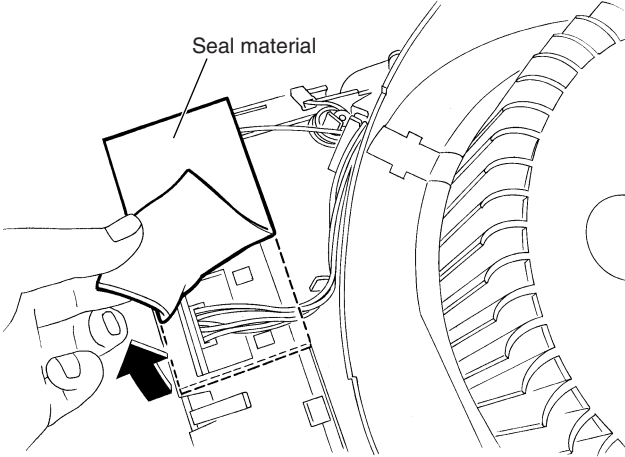
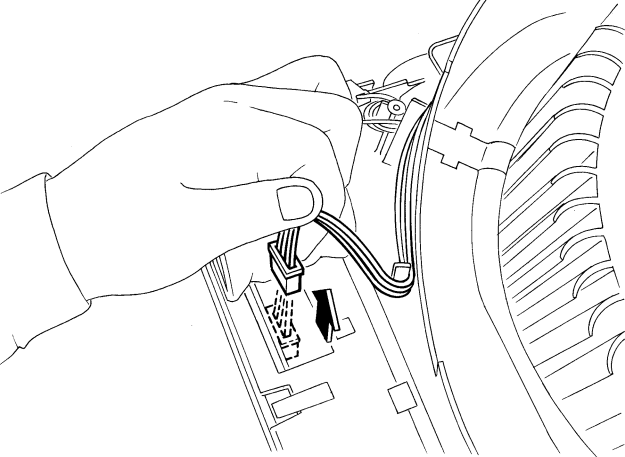
	Procedure	Points
<p data-bbox="145 427 507 510"><b>2. Removing the fan motor</b></p> <p data-bbox="145 528 496 600">(1) The figure shows the wiring routes.</p> <p data-bbox="145 943 384 1014">(2) Peel the seal material.</p> <p data-bbox="145 1469 464 1541">(3) Disconnect the fan motor connectors.</p>	 <p data-bbox="719 1003 847 1025">Seal material</p>  	<p data-bbox="1182 931 1453 1014">* Once removed, the seal material cannot be reused.</p>

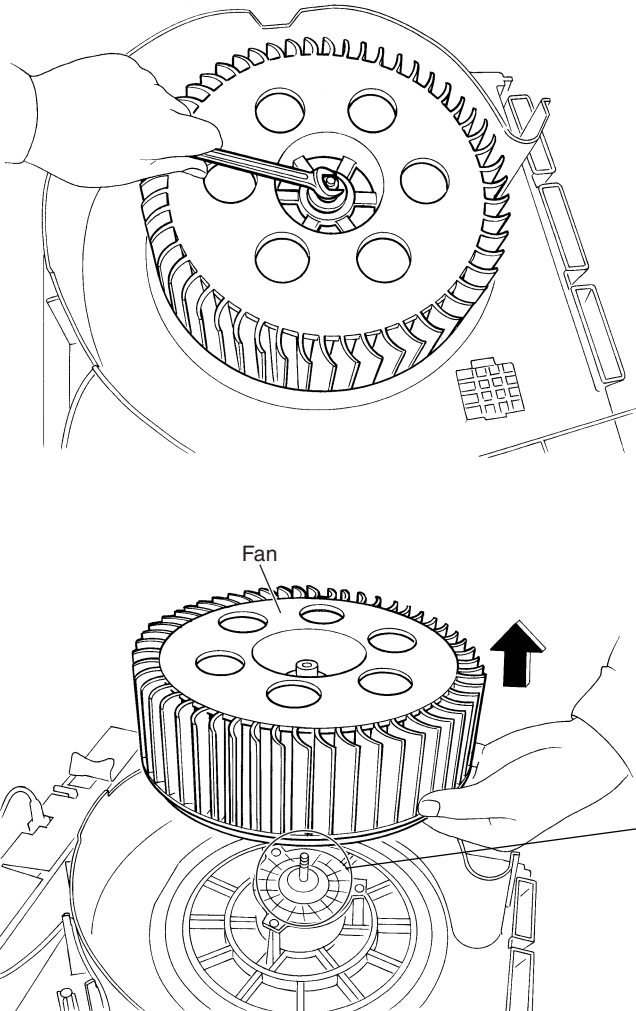
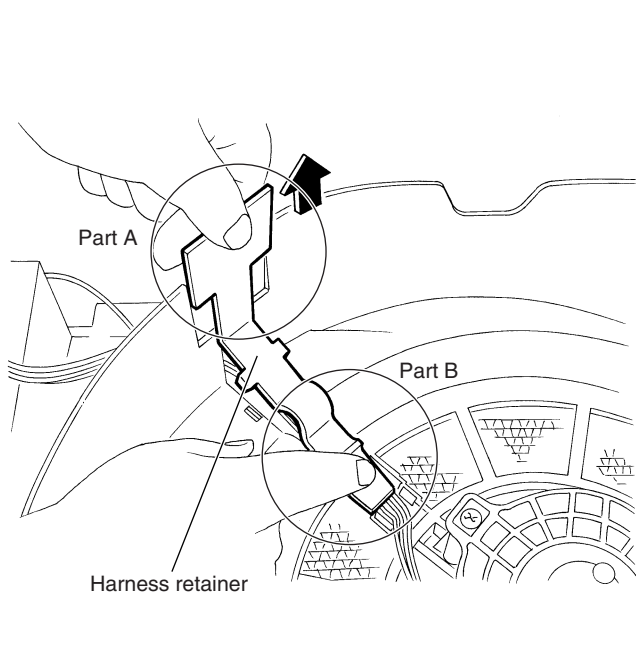
Procedure	Points
<p>(4) Remove the nut and pull out the fan.</p>	 <p>* When assembling, align the ▼ mark on the fan with the D cut on the motor shaft.</p>
<p>(5) Lift and detach the harness retainer.</p> <p>(6) When assembling, put part A first in the groove, and then slide part B along the way.</p>	

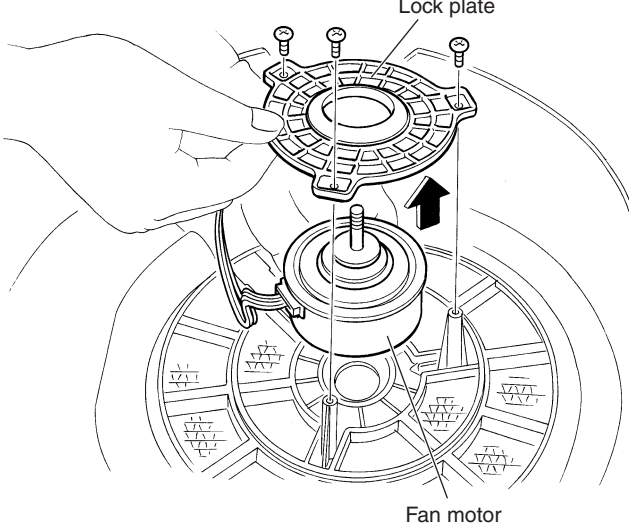
	Procedure	Points
<p>(7) Remove the 3 screws from the lock plate and take out the fan motor.</p>	 <p>The diagram illustrates the removal of the fan motor. A hand is shown unscrewing three screws from a lock plate. An arrow points upwards from the fan motor, indicating its removal. Labels 'Lock plate' and 'Fan motor' are present.</p>	<ul style="list-style-type: none"><li>* The motor and the harness are integrated together.</li><li>* Make sure no washers are left behind the fan.</li></ul>

## 7.5 Removal of Electrical Box / PCB

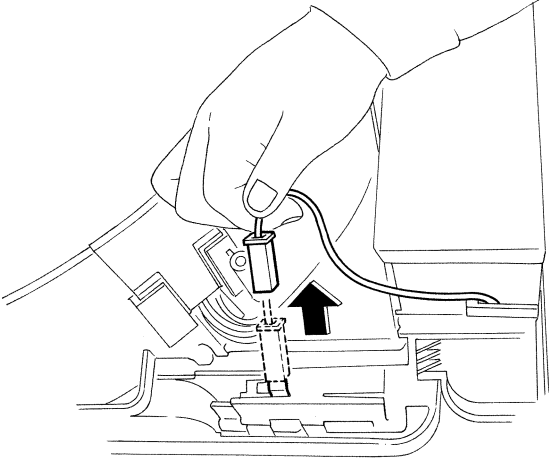
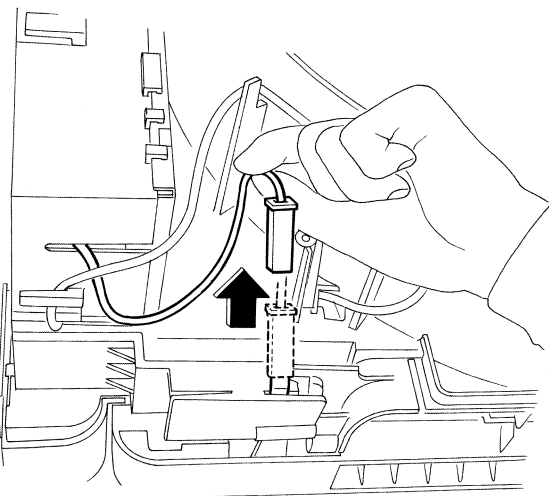
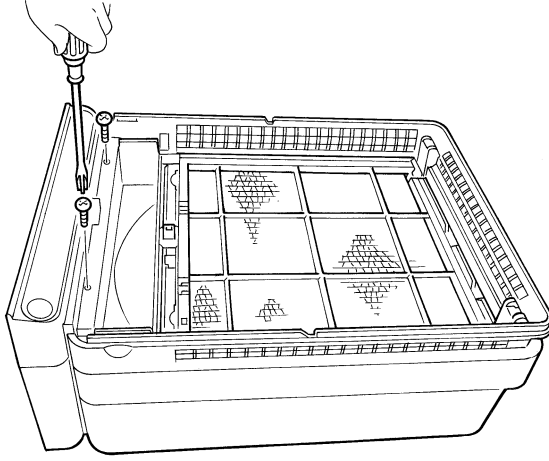

**Warning** Be sure to wait 10 minutes or more after turning off all power supplies before disassembling work.

	Procedure	Points
<p>* Remove the back cover. * Disconnect the fan motor connector.</p> <p><b>1. Disconnecting the faston terminal</b></p> <p>(1) Disconnect the terminal located at left.</p> <p>(2) Disconnect the terminal located at right.</p>	 	
<p><b>2. Removing the electrical box</b></p> <p>(1) Remove the 2 screws from the front bottom.</p>		<p>* The screws are M4×12 in size. (The other ones are M4×16.) Use regular length of screws.</p>

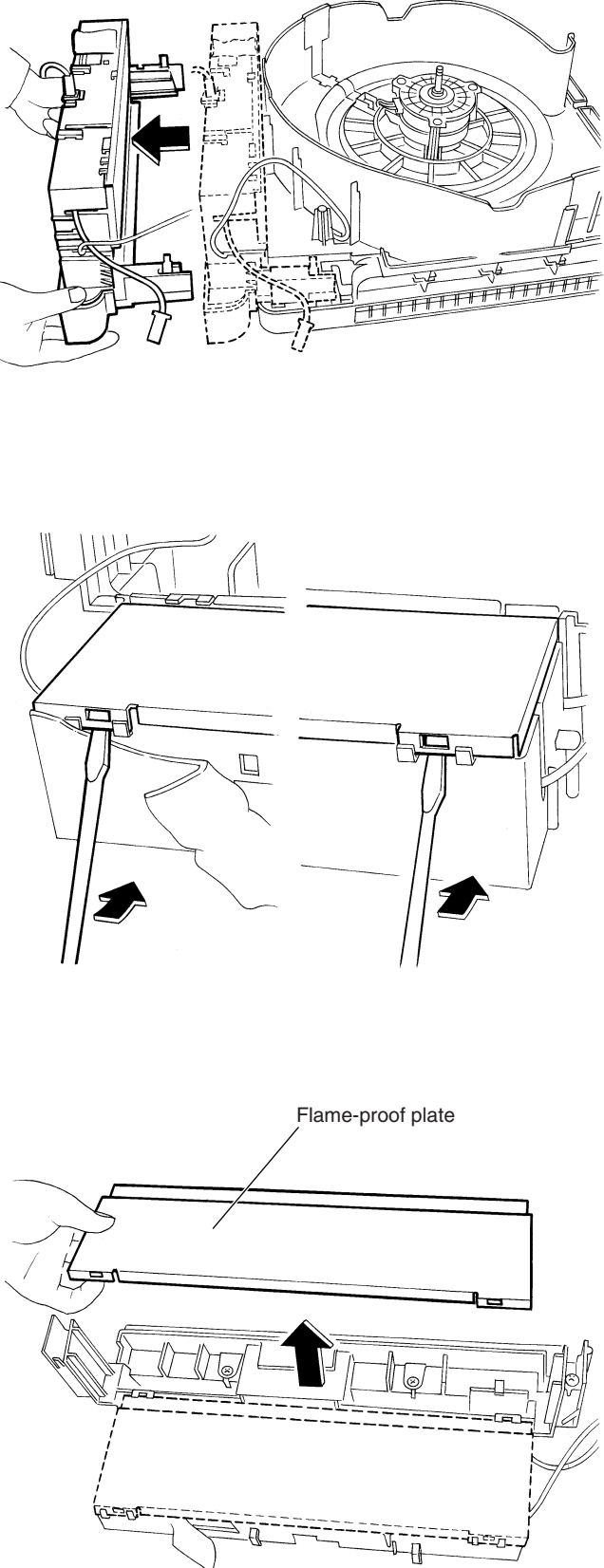
	Procedure	Points
<p>(2) Pull out the electrical box to detach.</p> <p><b>3. Removing the PCB</b></p> <p>(1) Undo the 2 hooks at the back and take out the flame-proof plate.</p>	 <p>The diagram is divided into three parts. The top part shows a hand pulling an electrical box out of the unit, with a dashed line indicating its original position. The middle part shows two hooks being unhooked from the back of the unit. The bottom part shows the flame-proof plate being lifted out of the unit, with a label 'Flame-proof plate' pointing to it.</p>	<p>* When assembling, fit the box in the groove.</p> <p>* When fitting the flame-proof plate in position, be careful not to confuse the inserting positions.</p>

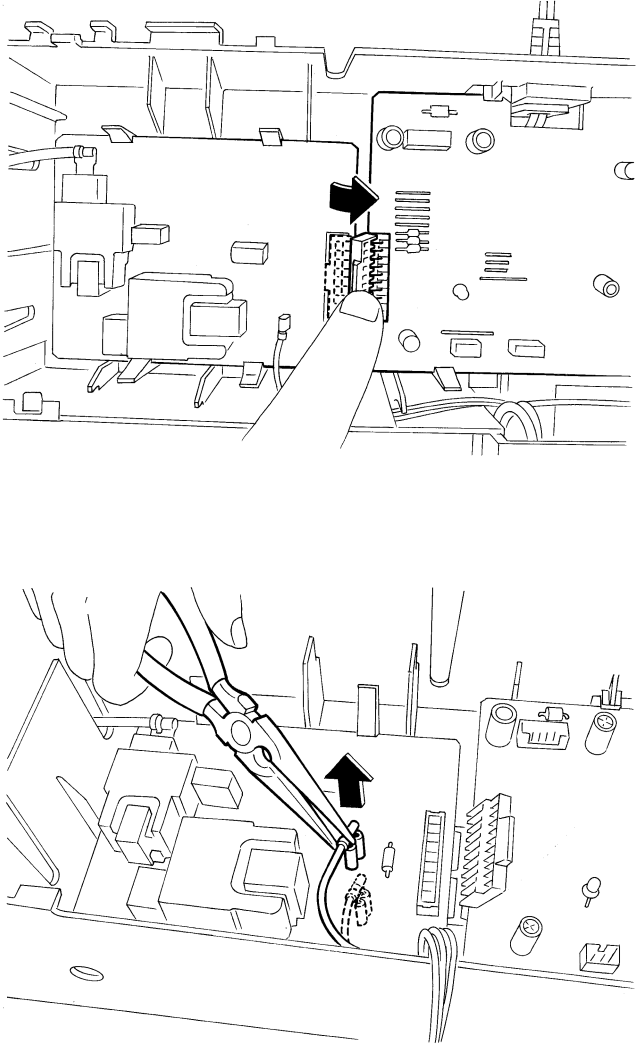
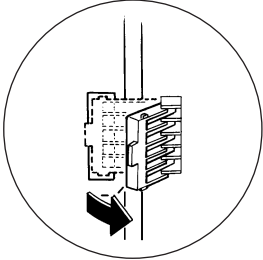
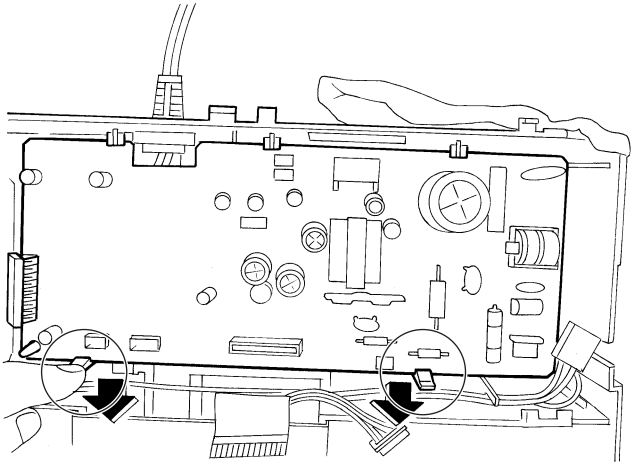

	Procedure	Points
<p>(4) Disconnect the PCB connector.</p>		<p>* When connecting, connect firmly not to be unfastened.</p> 
<p>(5) Undo the 2 hooks and remove the PCB.</p>		



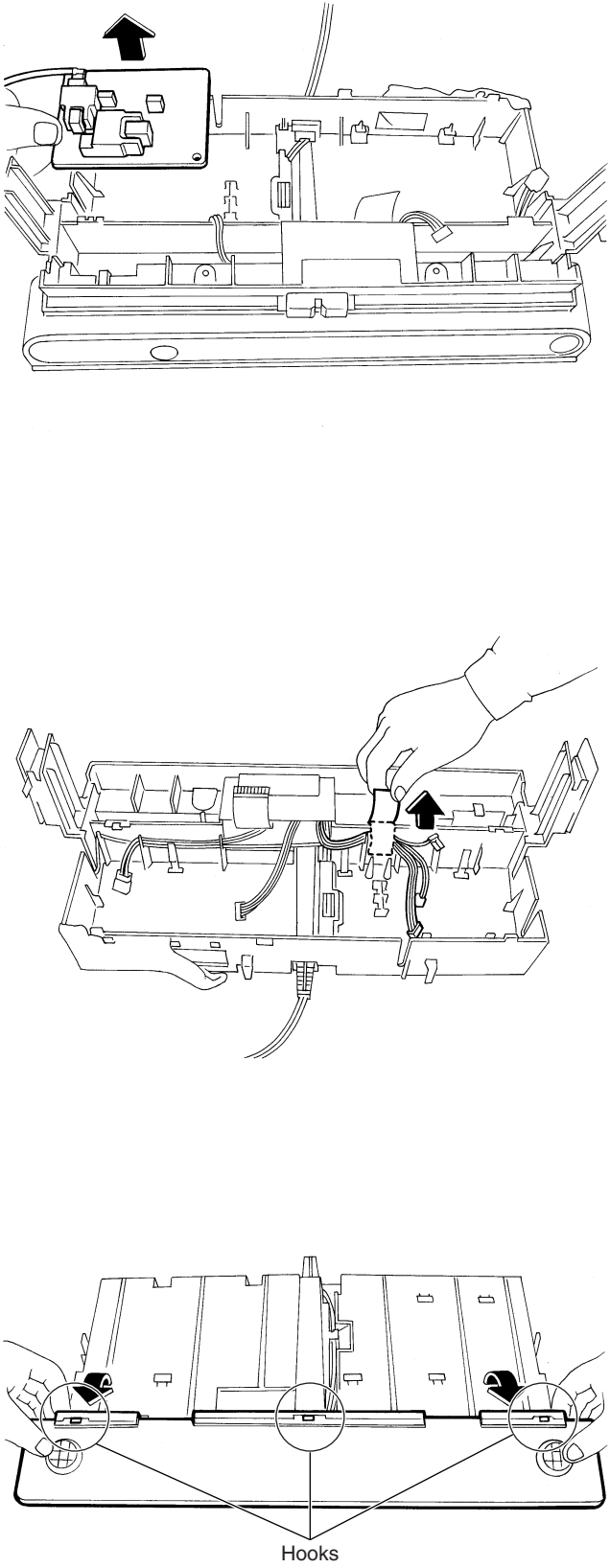

	Procedure	Points
<p data-bbox="150 913 448 947">(8) Remove the tape.</p> <p data-bbox="150 1559 464 1697">(9) Undo the 3 hooks from the back to remove the display PCB.</p>	 <p data-bbox="823 1883 887 1906">Hooks</p>	

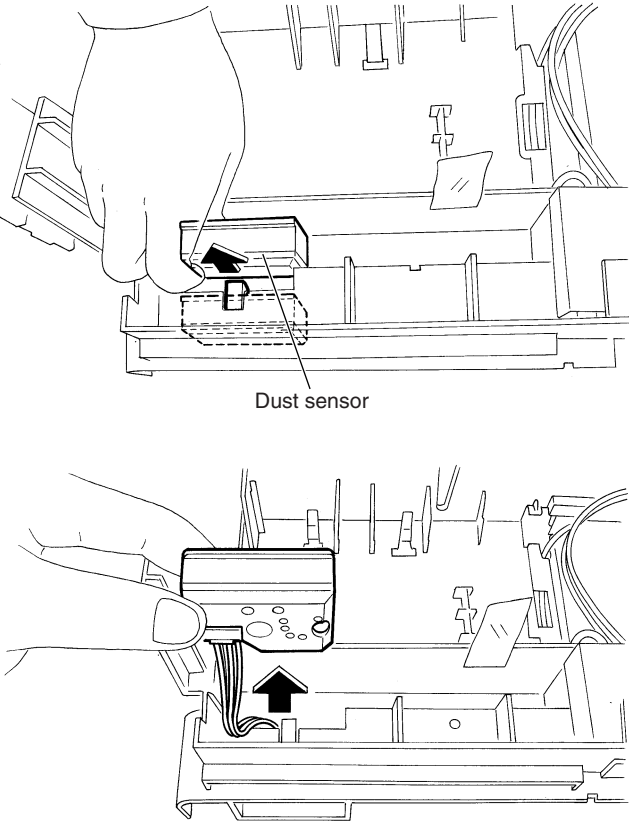
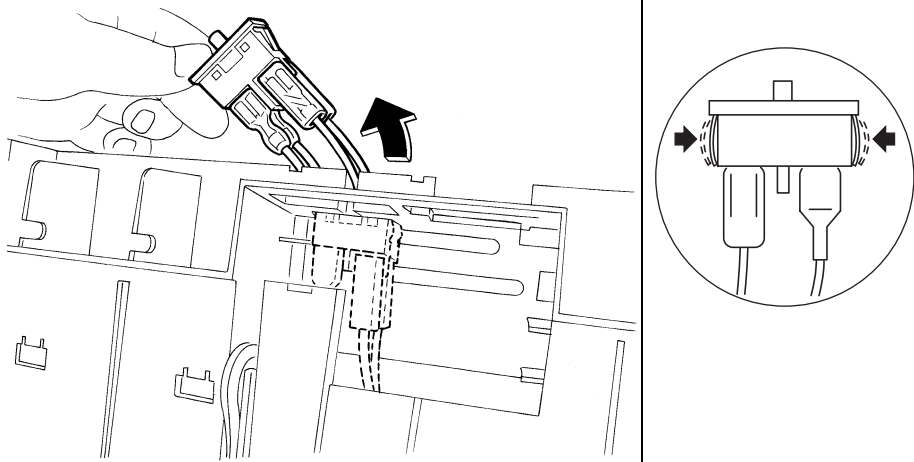

	Procedure	Points
<p>(12) Undo the hook from the dust sensor and push out the sensor from front.</p>	 <p>Dust sensor</p>	
<p>(13) Pinch the bulge of the safety door switch from inside to push out the switch.</p>		

Warning



- Daikin Industries, Ltd.'s products are manufactured for export to numerous countries throughout the world. Daikin Industries, Ltd. does not have control over which products are exported to and used in a particular country. Prior to purchase, please therefore confirm with your local authorized importer, distributor and/or retailer whether this product conforms to the applicable standards, and is suitable for use, in the region where the product will be used. This statement does not purport to exclude, restrict or modify the application of any local legislation.
  - Use only those parts and accessories supplied or specified by Daikin.
  - Read the User's Manual carefully before using this product. The User's Manual provides important safety instructions and warnings. Be sure to follow these instructions and warnings.
- If you have any inquiries, please contact your local importer, distributor and/or retailer.

**Cautions on product corrosion**

1. Air conditioners should not be installed in areas where corrosive gases, such as acid gas or alkaline gas, are produced.
2. If the outdoor unit is to be installed close to the sea shore, direct exposure to the sea breeze should be avoided and choose an outdoor unit with anti-corrosion treatment.



JMI-0107



JQA-1452

**About ISO9001**

ISO 9001 is a plant certification system defined by the International Organization for Standardization (ISO) relating to quality assurance. ISO 9001 certification covers quality assurance aspects related to the "design, development, manufacture, installation, and supplementary service" of products manufactured at the plant.



EC99J2044



JQA-E-90108

**About ISO 14001**

ISO 14001 is the standard defined by the International Organization for Standardization (ISO) relating to environmental management systems. Our group has been acknowledged by an internationally accredited compliance organisation as having an appropriate programme of environmental protection procedures and activities to meet the requirements of ISO 14001.

**Dealer**

**DAIKIN INDUSTRIES, LTD.**

Head Office:  
Umeda Center Bldg., 2-4-12, Nakazaki-Nishi,  
Kita-ku, Osaka, 530-8323 Japan

Tokyo Office:  
JR Shinagawa East Bldg., 2-18-1, Konan,  
Minato-ku, Tokyo, 108-0075 Japan

<http://www.daikin.com/global/>

©All rights reserved