



SiBE81-909

Preliminary

Service Manual

Humidifying Air Purifier



Air Purifier

MCK75JVM-K

1.Introduction	2
2.Precautions for Use.....	5
2.1 Required Conditions	5
2.2 Applicable Room Area	5
3.Functions	6
4.Specifications	7
4.1 Specifications	7
4.2 Dimension	9
4.3 Wiring Diagram	10
4.4 Packaging Drawing	11
5.Operation Manual.....	12
5.1 Safety Precautions	12
5.2 Names and Operation of Each Part	16
5.3 Sensitivity Settings of the Dust Sensor	22
5.4 Installation	23
5.5 Preparation of Remote Controller	24
5.6 Attach the Filter	25
5.7 Water Tank Preparations	26
5.8 Air Purifying Operation	28
5.9 Humidify and Air Purifying Operations	29
5.10 How to Operate with Remote Controller	30
5.11 How to Use the Recyclable Deodorizing Cartridge	32
5.12 Quick Reference Table of Maintenance	34
5.13 Care and Cleaning	36
6.Optional Accessories	48
6.1 Dimensions	48
7.Troubleshooting	50
7.1 Basic Inspection	50
7.2 Check Before Requesting Servicing	53
7.3 Frequently Asked Questions	56
7.4 Troubleshooting	57
7.5 Check	64

1. Introduction

“Clean Humidification” and “High Airflow Rate Purifying” are realized.

Both “full humidification” and “full dust collection” can be used.

NEW

Full Humidification

3 features for “Clean Humidification”

- ① Antibacterial humidifying filter
- ② Silver ion antibacterial effect
- ③ Unsoaking humidifying rotor

Max. humidifying amount: 600mL/h
(Vaporization humidifying system)

Slim tank capacity: 4L
Double path mixing structure

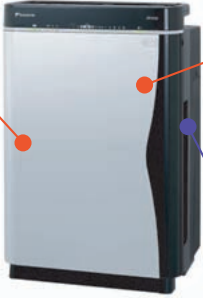

Full Dust Collection

High airflow rate suction dust collection: 7.5m³/min

High hydrostatic thin-type fan is equipped.

Full Deodorization

Photocatalyst & Streamer discharge

+ Recyclable deodorizing cartridge

Of course, deodorization is [full-scale]

Recyclable



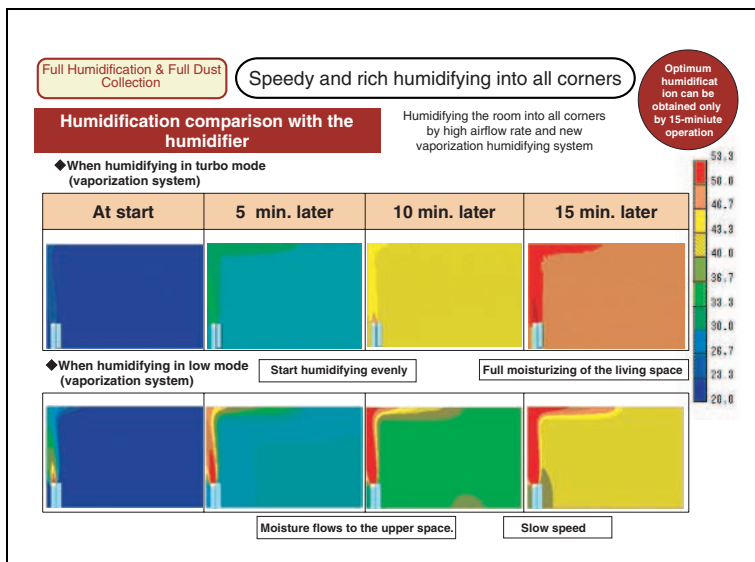

- Test condition: Air test room (W 3700 × D 3700 × H 2400) *equivalent to 13 m² room
- Room temperature: 21°C measured with an existing model, 27°C with a new model

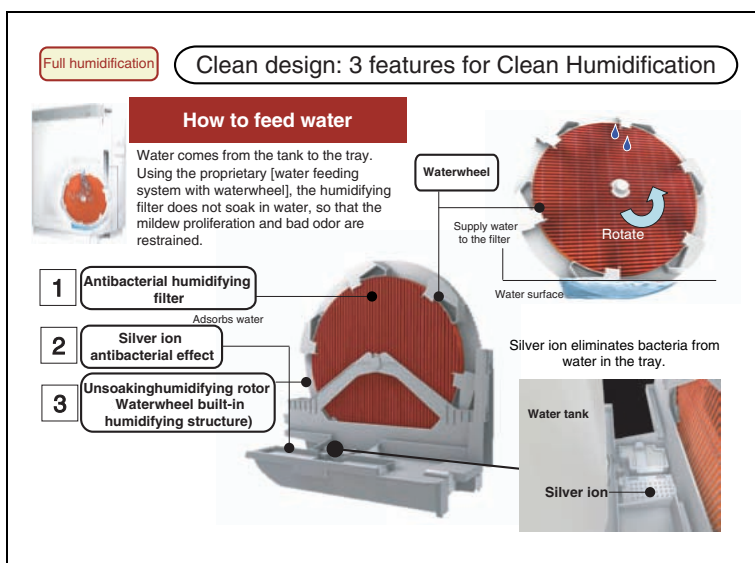

Full humidification **New Design: High hydrostatic thin-type powerful fan**

“Double Path Mixing Structure”

Newly designed thin-type fan
Vaporized air and non-vaporized air
are mixed and discharged by shifting
the humidifying filter from the fan.
This design prevents drop of the
airflow temperature and restrains
drop of the room temperature.

Humidified air

Dry air

Airflow temperature increases **2°C**
(Compared with a model without double path mixing structure)

High hydrostatic thin-type fan

Fan thickness **20mm**
thinner than the existing model

Humidifying filter

Air to be humidified

When humidifying in turbo mode
50 dB
(7.5m³/min)

Electric dust collection area is positioned in front of the humidifying rotor where little pressure loss is observed and quiet sound is heard even if the humidifying operation is performed.

Full Humidification & Full Dust Collection **Sensitive Control**

6-step airflow mode (Top in the market)

When automatic airflow mode is selected, humidity, dust or odor sensor detects the air condition in the room and optimal operation is performed within a mode range from quiet to high.

<Pollen> operation Air purification

In this operation, pollens are caught before they drop on the floor with gentle air draft by switching airflow between “Standard” and “Low”.

[Top operation area]

[Monitor display]

Dust sensor lamp Humidity indicator lamp Odor sensor lamp

Simple and sensitive settings are available.

Compact Design

“Slim Tank”

The water tank is positioned at the front.
Structure for easier maintenance

Water tank

Unsoaking humidifying rotor

[In maintenance] Structure for easier removal

Compact No.1*

268mm

395mm

* Comparison of a new model and an air purifier with the humidifier (class: airflow rate = 7.5m³/min.) (As of July 16, 2008)

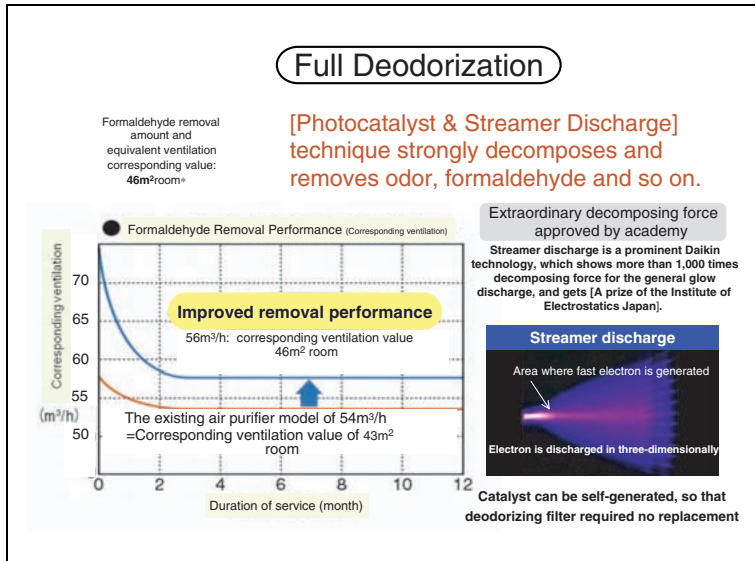

- [Test Conditions]
 - Airflow rate: 7.5m³/min
 - Test room: About 10m² space
 - Conforming to WG standard for reviewing the MLIT evaluation test method of sick building overall project
 - * Corresponding value when the mechanical ventilation specified in the building standard law is carried out.

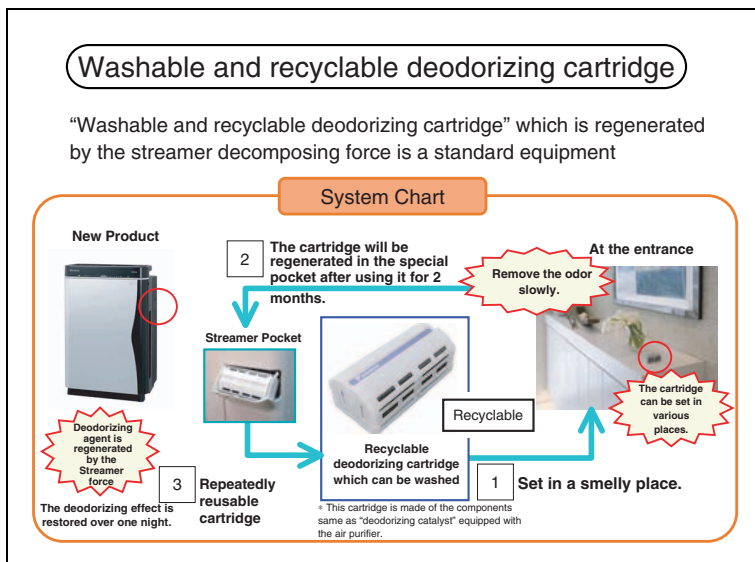

2. Precautions for Use

2.1 Required Conditions

■Power Supply

1φ, 220-240/220-230V, 50/60Hz

■Miscellaneous

- This product is for home use. Do not use for special purpose.
- This product is for indoor use only. Do not use in bathroom or outdoors as it is not water/condensation proof.
- Do not modify this product.

2.2 Applicable Room Area

	Air purifying operation	Humidifying operation
m ²	46	—

Note) The applicable room area is appropriate for the operating unit of maximum fan speed (HH).

Applicable room area indicates the space where a certain amount of dust particles can be removed in 30 minutes.
(JEM1467)

3. Functions

Category	Functions	MCK75JVM-K
Structure	Odor sensor	○
	Dust sensor	○
	Humidity sensor	○
	Temperature sensor	○
Health & Clean	Flash streamer discharge	○
	Catechin pre-filter	○
	Titanium apatite photocatalytic filter	○
	Bio-antibody filter	-
	Attached pleated filter (sheets)	1+6
	Humidifying filter	○
	Deodorizing catalyst	○
	Recyclable deodorizing cartridge	○
Monitor	Odor sensor lamp	○
	Dust sensor lamp	○
	Humidity indicator lamp	○
Operation	Automatic air-purifying airflow rate	○
	Manual air-purifying airflow rate	○
	Anti-pollen mode (air-purifying)	○
	Automatic humidifying airflow rate	○
	Manual humidifying airflow rate	○
	Anti-pollen mode (humidifying)	○
	Humidity setting	○
	Turbo mode	○
Negative ion	-	
Maintenance	Quick-wipe panel	○
	Water supply indicator	○
	Plasma ionizer cleaning indicator	○
	Streamer unit cleaning indicator	○
	Air-purifying filter replacement indicator	○
	Humidifying filter replacement indicator	○
Convenience	OFF TIMER (hours)	1-4-8
	Child proof lock	○
	Brightness adjustment	○
	Deodorizing cartridge recycle function	○
	Remote controller storage	○
Other Functions	Automatic OFF function for turnover	○
	Standby electricity saving	○ (below 0.5W)
Remote controller	Wireless remote controller	ARC458A4

4. Specifications

4.1 Specifications

Model		MCK75JVM-K	
		Air purifying operation	Humidifying operation
Type		Humidifying air purifier	
Color ★1		Black	
Power supply		1φ, 220-240/220-230V, 50/60Hz	
Running current (HH/H/M/L/LL)	A	0.71 / 0.31 / 0.19 / 0.12 / 0.09	0.72 / 0.32 / 0.19 / 0.13 / 0.11
Power consumption (HH/H/M/L/LL)	W	81 / 35 / 18 / 11 / 8	84 / 37 / 20 / 13 / 12
Humidification (HH/H/M/L/LL)★2	mL/h	—	600 / 470 / 370 / 290 / 240
Water tank capacity	L	4.0	
Operating sound ★3 (HH/H/M/L/LL)	dB(A)	50 / 43 / 36 / 26 / 17	50 / 43 / 36 / 26 / 23
Airflow rate (HH/H/M/L/LL)	m³/h	450 / 330 / 240 / 150 / 60	450 / 330 / 240 / 150 / 120
Fan	Type	Multi Blade Fan (Sirocco fan with shroud assembly)	
	Running method	Direct drive	
Dust collecting method		Plasma ionizer + Electrostatic dust collection filter	
Deodorizing method		Flash streamer + Titanium apatite photocatalytic filter + Deodorizing catalyst	
Air filter		Polypropylene net with catechin	
Bacteria filtering method		—	
Sign		Dust sensor lamp: 3 stages Odor sensor lamp: 3 stages Humidify indicator lamp: 3 stages Humidify ON/OFF Airflow rate: Automatic/LL/L/M/H, Turbo mode (HH), Anti-pollen mode Humidify setting: LOW/STD/HIGH/CONT OFF timer: 1/4/8hrs Cleaning Sign: Ionization/Streamer Replacement Sign: Humidifying filter, Air-purifying filter Water supply lamp Child proof lock lamp Regeneration lamp (8hrs) Check lamp	
Dimensions (H x W x D)	mm	590 x 395 x 268	
Package dimensions (H x W x D)	mm	653 x 445 x 318	
Product weight	kg	11.0	
Gross weight	kg	15.0	
Safety device		Safety switch (Operation stops when the front panel is opened.)	
Power cord	m	2.0	
Standard accessories		Operation manual (1), Wireless remote controller (1), Photocatalytic pleated filter (1+6), Deodorization cartridge (1) ★4	
Drawing number		3D063375	

NOTE:

- ★1. Panel color : Silver (General) / Bordeaux, Black Optional accessory (for Russia only).
- ★2. Humidification amount changes in accordance with indoor and outdoor temperature and humidity.
Measurement condition : 20°C (temperature), 30% (humidity) (JEM1426)
- ★3. Operating sound levels are the average of values measured at 1m away from the front, left, right, and top of the unit.
(This equal to the value in an anechoic chamber.)
- ★4. The refreshing time of the deodorization cartridge is 8 hours.

4.2 Dimension

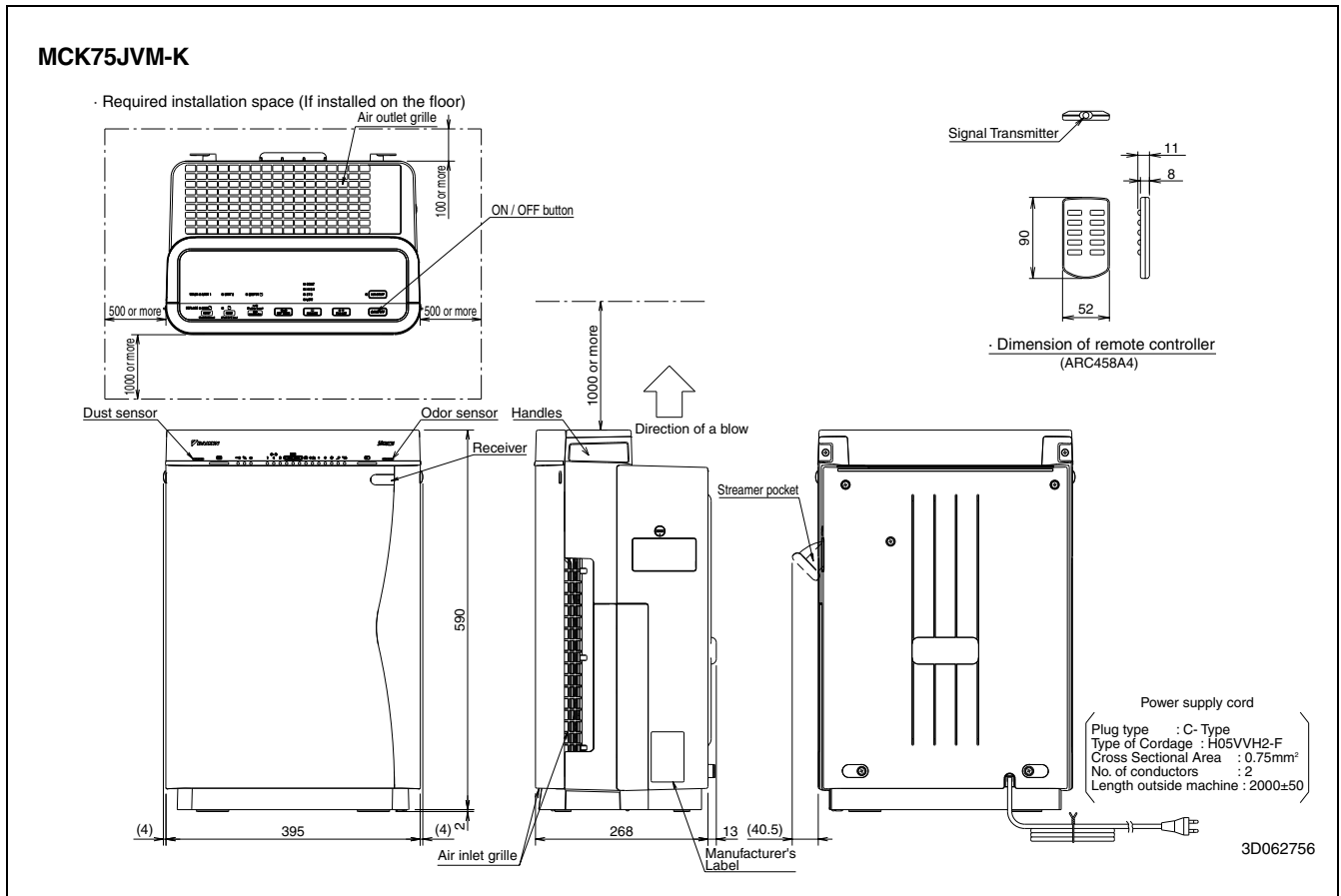

4.3 Wiring Diagram

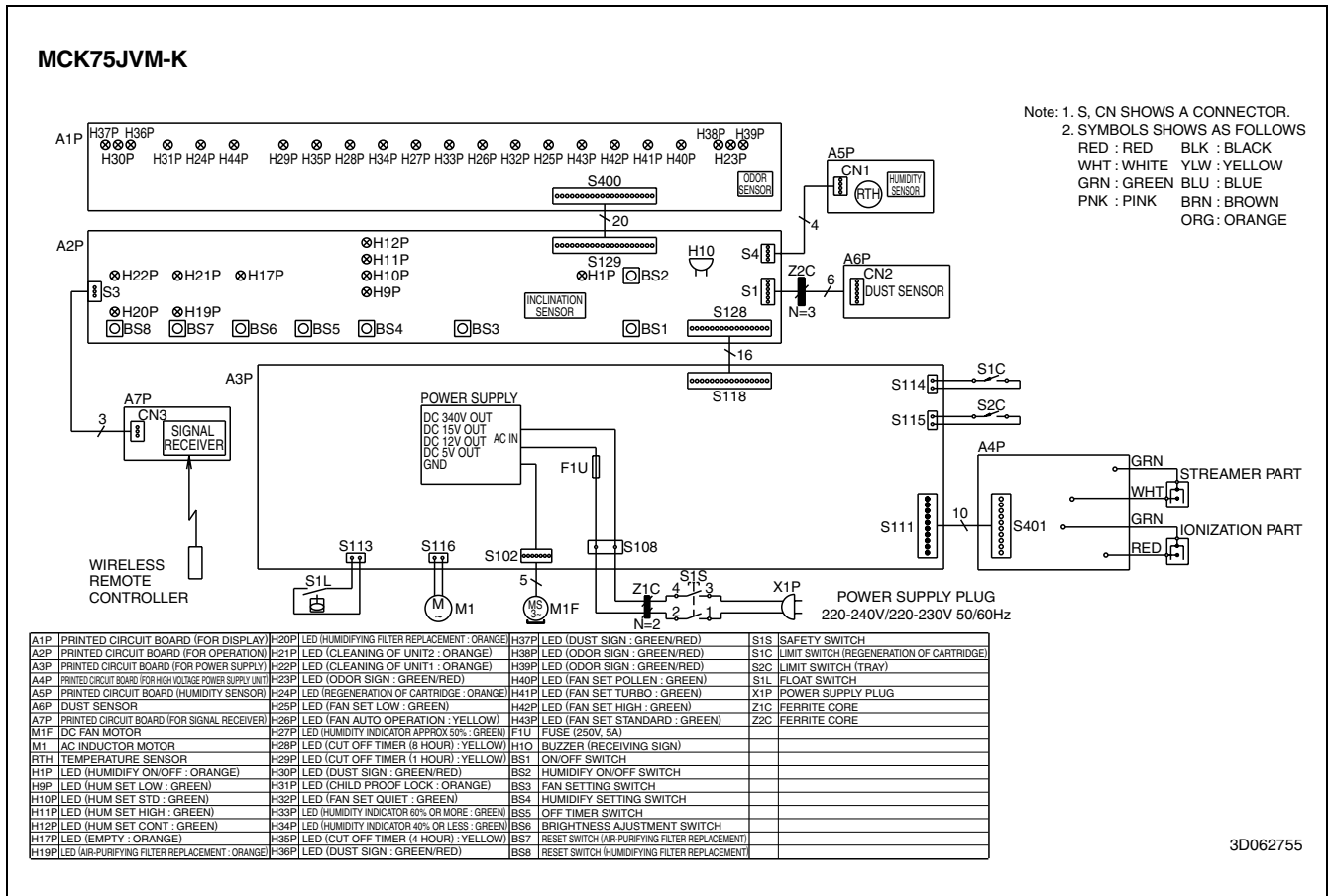

3D062755

4.4 Packaging Drawing

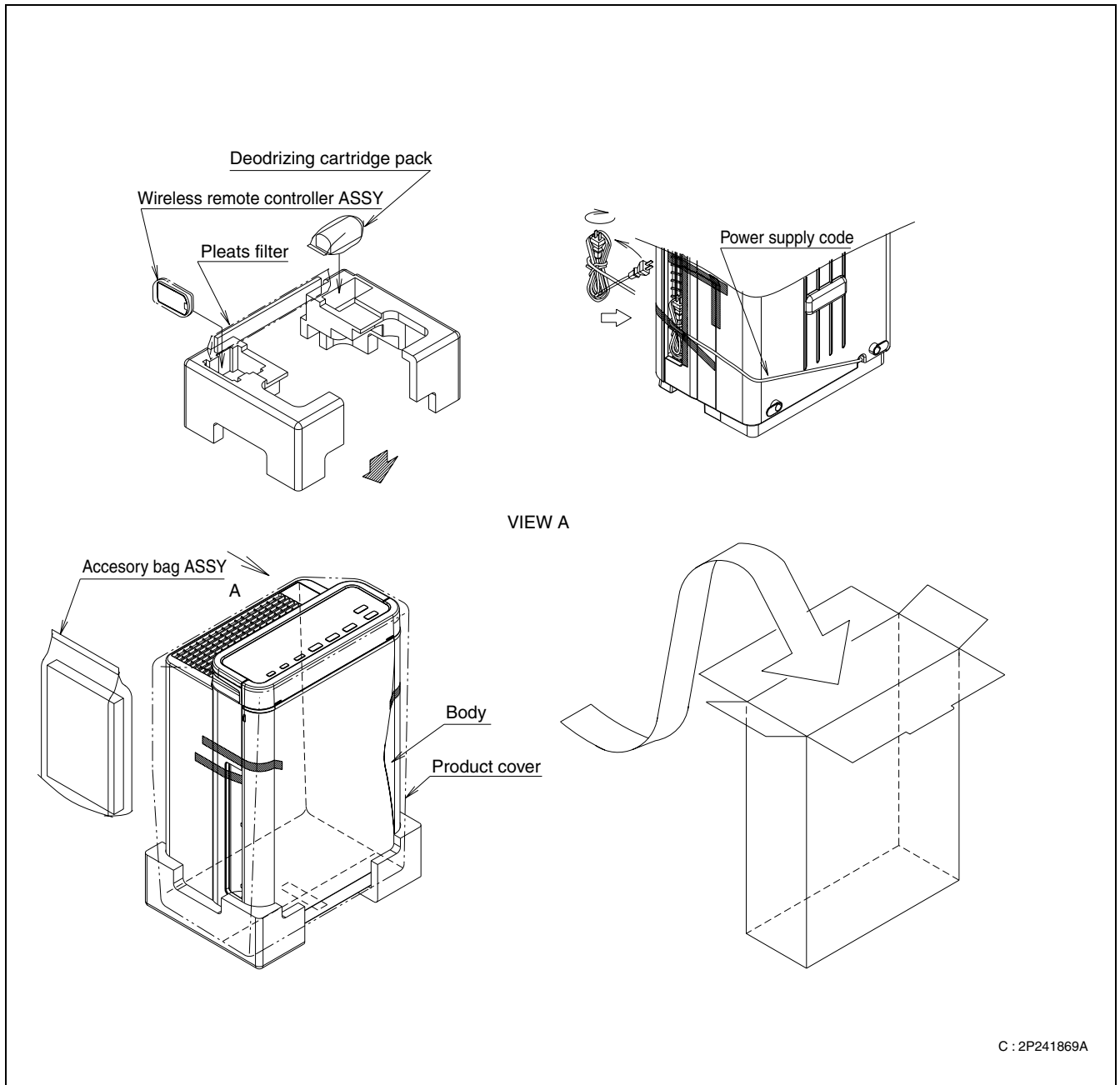



C : 2P241869A

5. Operation Manual







5.1 Safety Precautions

Safety Precautions

- Before use, read these Safety Precautions to ensure proper use.
- The precautions used in this manual are classified into the following two types. Both contain important safety information, therefore observe them at all times.

 WARNING	Improper handling may lead to serious injury or even death.	 CAUTION	Improper handling may lead to injury or property damage. In some situations, the consequences may be grave.
---	---	---	---

- The icons used in this manual mean the following.

	Never do.		Be sure to follow the instructions.		Unplug the power cord.		Keep away from flames.
	Do not disassemble.		Do not handle with wet hands.		Do not wet.		

- After reading this manual, keep it in a handy place for future reference by users.

WARNING

Power supply cord and plug



- **Use only a 220 - 240V power supply.**
Other power supplies may lead to fire or electric shock.
- **Do not damage, remodel, bend unreasonably, pull, twist or use the power supply cord bundled up.**
Also, do not place heavy objects on or pinch the power supply cord.
Damage to the power supply cord may lead to fire or electric shock.
- **Do not use the unit when the power supply cord or plug is damaged or plugged loosely into an electrical socket.**
A damaged or loose cord or plug may lead to fire because of a short circuit or electric shock.
- **Do not use the unit beyond the rating of the electrical socket or branching device.**
Exceeding the rating of multiple socket outlets may lead to fire because of overheating.
- **Do not insert or remove the power plug to turn the unit ON/OFF.**
Abusive handling may lead to electric shock or fire because of overheating.



- **Insert the power plug into the socket all the way to the base.**
Incomplete connections may lead to electric shock or fire because of overheating.
- **Periodically clean dust and other matter from the power plug with a dry cloth.**
Insulation failure caused by humidity or otherwise may lead to fire.
- **Stop operation and unplug the power supply cord if detecting anything strange such as burning odors.**
Continued use the unit in anything strange may lead to electric shock or fire because of overheating.
Contact the service shop.
- **If the power supply cord is damaged, it must be replaced by the manufacturer, its service shop or similarly qualified persons in order to avoid a hazard.**
A damaged cord may lead to electric shock or fire because of overheating.

- **Before cleaning or relocating the unit, stop operation and unplug the power supply cord from the electrical socket.**
Handling with the unit plugged in and running may lead to electric shock or injury.

⚠ WARNING

<p>Main unit</p> 	<ul style="list-style-type: none"> • Do not use the unit anywhere there is airborne oil such as machine oil. Airborne oils may lead to cracking, electric shock or ignition. • Do not use the unit anywhere there are abundant oil vapours such as in kitchens, combustible or corrosive gases, or metallic dust. These kinds of environments may lead to fire or damage. • Keep fingers and objects out of the air inlets, air outlet and other openings. Improper handling may lead to electric shock, injury or damage. • Do not wet the air outlet or unit frame. Contact with water may lead to fire or electric shock. • Do not use combustible substances, i.e., hairspray, insecticides, etc., near the unit. Do not wipe the unit with benzene or thinner. These substances may lead to cracking, electric shock or ignition. • Use a neutral liquid detergent to clean the unit. Use of chlorine or acidic detergents to clean the unit may generate harmful gas and harm health. <hr/> <ul style="list-style-type: none"> • Keep cigarettes, incense and other naked flames away from the unit. Naked flames may lead to fire. • Do not disassemble, remodel or service the unit yourself. Improper handling may lead to fire, electric shock or injury. Contact the service shop. • Do not operate the unit with wet hands. Contact with water may lead to electric shock. • Do not use the unit anywhere that is very humid such as bathrooms or that experiences sudden temperature changes such as cold storage boxes. Improper environments may lead to electric shock or damage.
--	--

⚠ CAUTION

<p>Power supply cord and plug</p> 	<ul style="list-style-type: none"> • Hold the power plug – not the power supply cord – and pull to unplug the unit. Pulling on the power supply cord may lead to fire or electric shock because of short circuits. • Before long periods of disuse, unplug the power supply cord from the electrical socket. Degraded insulation may lead to electric shock, current leaks or fire.
--	---

Safety Precautions

CAUTION

Main unit



- **Do not use the unit anywhere it is exposed to direct sunlight, rain or wind.**
Overheating or contact with water may lead to fire or electric shock.
- **Do not use the unit anywhere that is hot such as near to heaters.**
High temperatures may discolour or deform the unit.
- **Do not block the air inlets or air outlet with laundry, cloth, curtains, etc.**
Adhering lint may obstruct air passage, possibly leading to overheating and fire.
- **Do not use the unit anywhere the floor is unstable.**
If the unit topples over, water will spill from it, possibly wetting furniture or leading to fire or electric shock.
If the unit topples over, put it upright immediately.

- **Do not use the unit anywhere that chemicals are handled.**
Volatile medicines or solvents (found in hospitals, factories, test labs, beauty salons, photo developing labs, etc.) may degrade mechanical parts, possibly causing water leaks that may resultantly wet furniture, etc.



- **Do not use powders such as cosmetics near to the unit.**
Contact with powders may result in electric shock or damage.

- **Do not use the unit in cramped spaces such as closets.**
Poor ventilation may lead to overheating and fire.

- **Do not expose plants or animals to direct air currents from the unit.**
Overexposure to air currents may have adverse effects.

- **Keep fish tanks, vases and other water containers away from the unit.**
Water infiltration into the unit may lead to electric shock, fire or damage.

- **Do not climb, sit or lean on the unit.**
Falling or toppling over may lead to injury.

- **Do not remove the filter with the unit lying on its side.**
Handling of the sort facilitates dust infiltration, possibly leading to fire or electric shock.
Also, water may spill from the unit, possibly leading to damage.

- **Do not remove the float or Styrofoam from the float.**
This will disable humidification.

- **Do not remove the silver ion cartridge.**
This will disable the antibacterial, anti-mildew and slime prevention effects.



- **Regularly ventilate the room when using the unit in conjunction with combustion appliances.**

Inadequate ventilation may lead to CO poisoning.
This product does not remove CO.

- **Change the water in the tank for fresh tap water every day when humidifying and periodically clean inside the unit to always keep it clean.**

Failure to clean the unit may lead to mildew and bacteria proliferation because of grime and scale, and resultantly foul odors. Depending on their physical condition, some persons may be hypersensitive and their health jeopardised as a result.

• In such case, contact a doctor.



- **Before moving the unit, stop operation and discard the water from the water tank and humidifying tray.**

Leaks or spills from the water tank or humidifying tray may wet furniture or lead to electric shock or current leaks.

- **This appliance is not intended to be used by persons with reduced physical, sensory or mental capabilities, or with lack of operation knowledge, unless they have been given supervision or instruction concerning the appliance use by person responsible for their safety. Keep out of children's reach to ensure that they do not play with the appliance.**

- **Unplug the unit during filling and cleaning.**

Handling with the unit plugged in may lead to electric shock or damage.

⚠ CAUTION

Other		<ul style="list-style-type: none"> • If used where pets are kept, be careful that pets do not urinate on the unit or bite the power supply cord. This may lead to electric shock or fire. In the event of abuse by pets, stop operation, unplug the power supply cord and contact the service shop. • Do not use combustion appliances where directly exposed to air currents from the air outlet. Incomplete combustion of the combustion appliance may lead to CO poisoning, etc. • Before using indoor fumigating insecticides, stop operation to prevent chemicals from being sucked into the unit. Because chemicals accumulate inside the unit, some persons may, depending on their physical condition, be hypersensitive and have their health jeopardised as a result.
-------	---	---



Precautions in use

- **Keep TVs, radios, stereos, radio clocks and antenna wires at least 2m from the unit.**
Interference may affect images and audio. The same applies to cordless phones, wireless microphones and other devices that emit weak electric waves. (However, audio interference may occur even beyond 2m depending on the strength of the electric waves. Reception is particularly hindered when using indoor antennas, therefore distance antennas far enough away to prevent noise from being picked up.)
- **Do not use the unit in the place of kitchen fans or stove hoods.**
This kind of use will shorten the service-life of the pre-filter and pleated filter, possibly leading to damage.
- **Do not use the unit to preserve artwork, academic materials, etc., or for commercial or other special applications.**
This kind of use may degrade the quality of preserved objects.
- **Correctly attach parts after cleaning the unit.**
Using the unit with parts such as filters removed may lead to damage.
- **Use only tap water.**
In general, tap water is chlorinated, which prevents bacteria from proliferating.
- **Do not add the below liquids to the water tank.**
Hot water of 40°C or more, aromatic oils, chemicals, dirty water, water containing fragrances or solvents, etc.
Liquids of the sort may deform or damage the unit.
Purified water, alkaline ion water, mineral water, well water, etc.
These types of water may lead to bacterial proliferation.
- **Do not overhumidify the room.**
Overhumidification may lead to condensation and mildew in the room.
- **Periodically clean the unit.**
Clean the unit as explained in "CARE and CLEANING". [▶Page 27-38.](#)
Excessive dirt may lead to mildew, foul odors or lost humidification capacity.
- **Be careful of freezing.**
Discard water from the water tank and humidifying tray if freezing is suspected.
Using the unit when water is frozen may lead to damage.
- **Discard water from the unit when the unit is not being used.**
If not using the unit, discard the water from the water tank and humidifying tray.
Grime and scale may cause mildew and bacteria, possibly leading to foul odors.

This product does not remove the harmful substances (CO, etc.) in cigarette smoke.

5.2 Names and Operation of Each Part

Names and Operation of Each Parts

Main unit

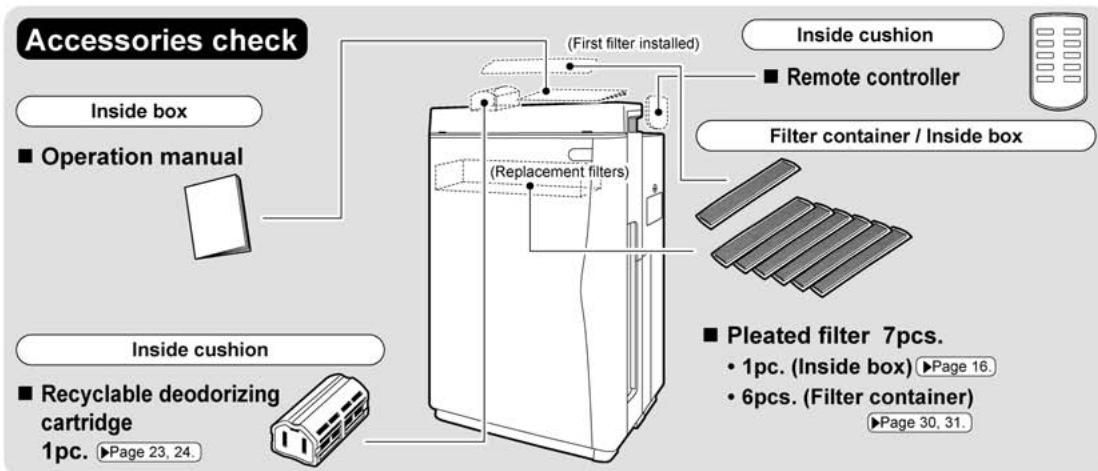
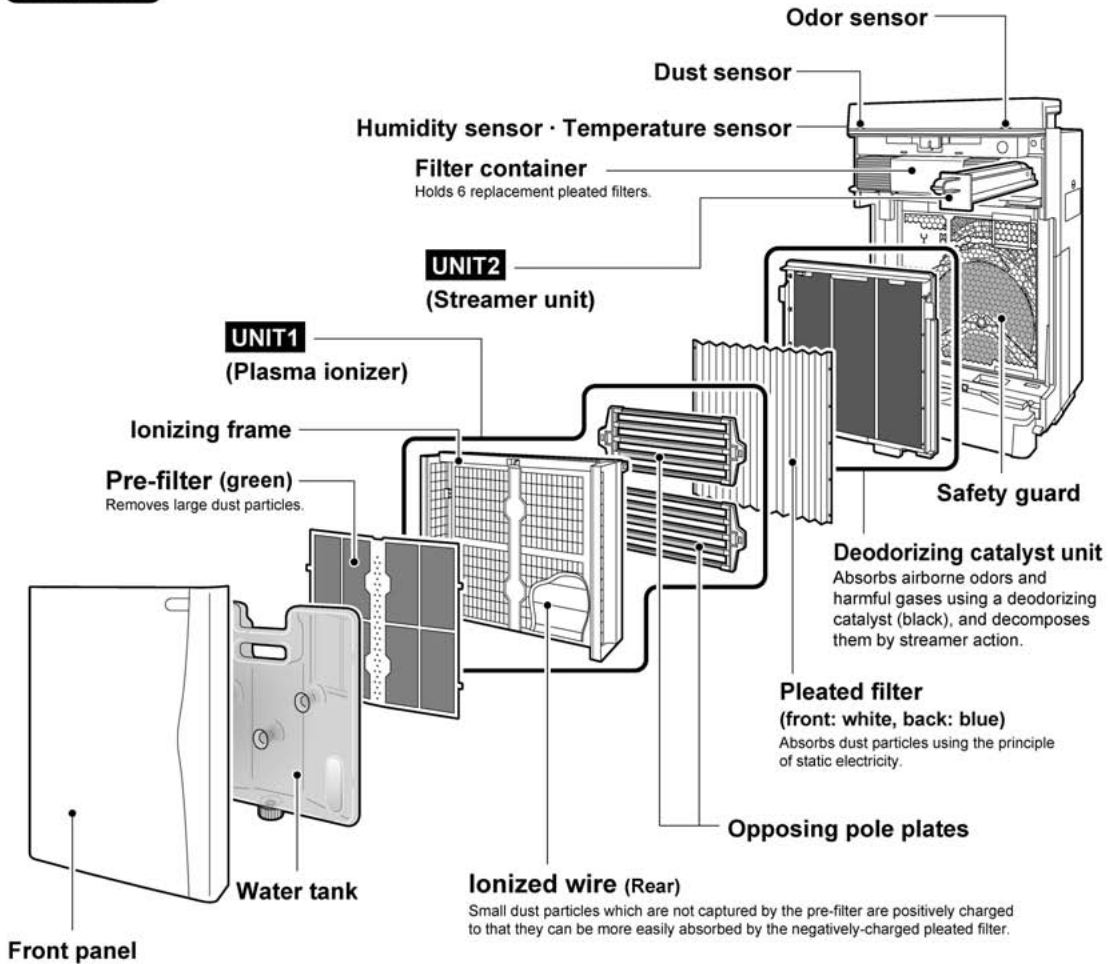

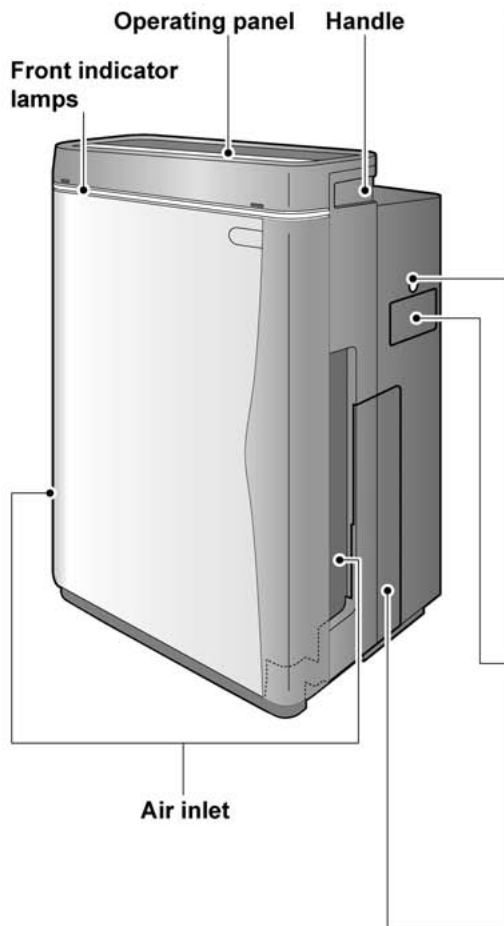

Side panel

Pocket lock
Prevents streamer pocket from opening inadvertently. Use a coin to open.

Unlock

Coin

Lock

Pocket lock

How to use the pocket lock

Unlock ↔ Lock

To lock, turn to where the ▲ meet.

Streamer pocket

Recyclable deodorizing cartridge

Streamer pocket

Use to regenerate the recyclable deodorizing cartridge. Inserting into the streamer pocket decomposes absorbed odors and enables reuse.

▶Page 23, 24.

Rear

Air outlet

Power supply cord hook
Winds the cord for storing unit.

Power supply cord

Humidifying filter

Waterwheel

Humidifying tray

Names and Operation of Each Parts

Operating panel

□ EMPTY

Water supply lamp

- If the water tank empties during humidifying operation, a long beep sound repeat 3 times and this lamp lights. **Humidifying operation** stops. (Air purifying operation continues while the humidify lamp is lit.)
- To resume humidifying operation, add water to the water tank, restore the water tank and press **ON/OFF**.

Brightness adjustment

Use to set lamp brightness for sleeping or as you prefer. Each time the button is pressed, the brightness of the operating panel lamps and front indicator lamps change as follows. [▶Page 13.](#)

<Operating panel lamps>

Bright → Dimmed → Dimmed

<Front indicator lamps> [▶Page 11, 12.](#)

Bright → Dimmed → OFF

- Only the front indicator lamps go completely off.

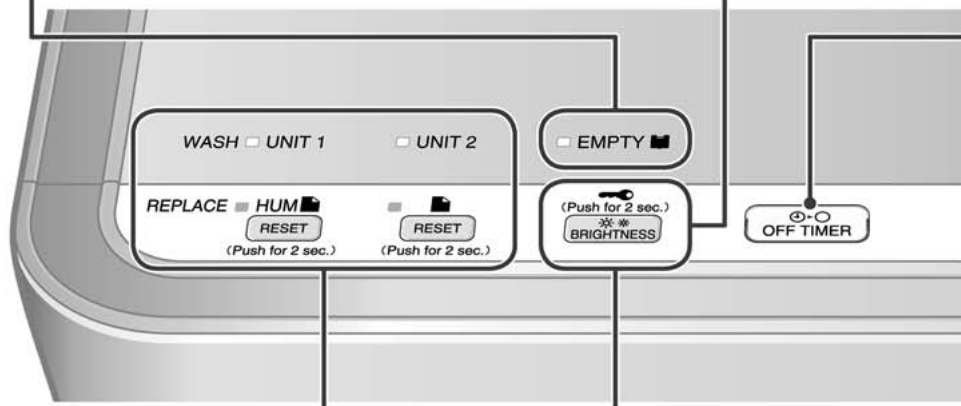

WASH □ UNIT 1 □ UNIT 2

REPLACE ■ HUM ■ ■ ■

RESET RESET

(Push for 2 sec.) (Push for 2 sec.)

Humidifying filter lamp (HUM ■)

- This lamp lights when it is time to replace the humidifying filter. It flashes if more time passes without changing the filter. [▶Page 37.](#)
- After replacing the filter, press and hold **RESET** for about 2 seconds. (A short beep sound is emitted and the lamps go out.)

Air-purifying filter lamp (■)

- This lamp lights when it is time to replace the pleated filter. It flashes if more time passes without changing the filter. [▶Page 30.](#)
- After replacing the filter, press and hold **RESET** for about 2 seconds. (A short beep sound is emitted and the lamps go out.)

UNIT lamp

- UNIT1→This lamp lights when it is time to clean the plasma ionizer.
- UNIT2→This lamp lights when it is time to clean the streamer unit. [▶Page 33, 34.](#)

(Push for 2 sec.)

*** BRIGHTNESS

Child proof lock

Press and hold ***** BRIGHTNESS** for about 2 seconds to engage the child proof lock. (Do the same to cancel the setting.)

When engaged, the child proof lock restricts unit operation so that it is not inadvertently operated by children.

ATTENTION

- The recyclable deodorizing cartridge can be regenerated even while the child proof lock is engaged.
- If the front panel is removed while the child proof lock is engaged, the unit stops for safety reasons and the child proof lock is canceled.



OFF TIMER button

Each time pressing this button, the OFF time changes as follows.

<Front indicator lamps>

- The timer setting indicator lights depending on the remaining time.
- The set time can be changed while the timer is running.

ATTENTION

- The operating panel is covered in a protective sheet to protect against scratching. Peel the sheet off before use.
- If the front panel is opened during operation, the unit stops for safety reasons.
- **If the unit malfunctions during operation**
During operation, if the indicator lamps light erroneously or the unit cannot be operated because of lightning or other reason, unplug the power supply cord, wait at least 3 seconds, plug the power supply cord back in and start the unit.

Humidify ON/OFF button

- Each time this button pressed, the humidifying operation is turned on and off.
- The lamp is lit while humidifying operation is ON.
- Air purifying operation is in active while humidifying operation. (Humidifying operation cannot run by itself.)

ON/OFF button

When this button is pressed, the unit starts. When pressed again, it stops.

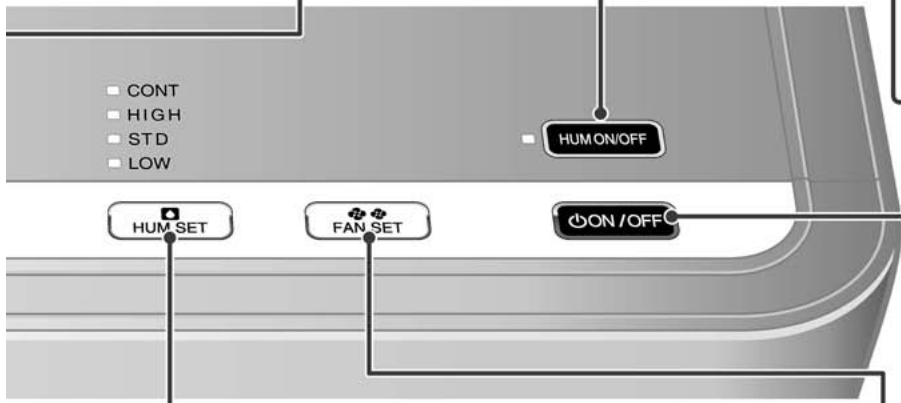

Humidify setting button

Each time pressing this button, the humidify setting changes as follows. [▶Page 20.](#)

- The humidify setting cannot be changed when humidifying operation is OFF.

Fan setting button

Each time pressing this button, the airflow rate setting changes as follows. [▶Page 19.](#)

<Front indicator lamps>

- "[A]" and "🌿", "🌿", "🌿" or "🌿" will be lit simultaneously while in auto mode.
- The fan will be set to auto mode if the HIGH, STD, or LOW humidify setting is selected while in humidifying operation.

Names and Operation of Each Parts

Front indicator lamps

The readings of room hygrometers and the unit's humidity indicator lamp may differ.

- This is because air currents cause temperature and humidity drifts even in the same room.
- Consider the humidity indicator lamp as just a reference reading.

Child proof lock lamp

- This lamp is lit while the child proof lock is engaged. If other buttons are pressed while the lamp is lit, a short beep sound repeat 3 times and button operations are ignored.

Regeneration lamp

- This lamp is lit while the recyclable deodorizing cartridge is being regenerated in the streamer pocket.
- Regeneration takes 8 hours.
- Recyclable deodorizing cartridge regeneration is started and stopped by opening and closing the streamer pocket.

▶Page 24.

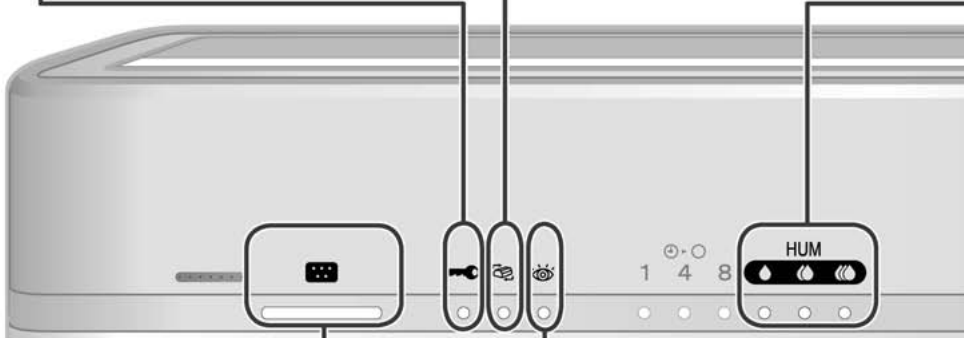

Dust sensor lamp

Dust sensor detects the dirty state of the air. The level of dirt is indicated by dust sensor lamp on 3 colors: green, orange and red.

- When the lamp is lit on green, the air is clean.

Dust

Low → High

Green
Orange
Red

- In the following cases, the lamp is lit on green for the initial 2 seconds regardless how clean the air is.
 - (1) Operation directly after setting the front panel.
 - (2) Operation directly after setting the power plug.
- If the dust sensor reaction is dull, adjust the sensitivity setting. ▶Page 13.

Sensor types and performance

Dust sensor	Detectable	Cigarette smoke, pollen, mites, house dust, shed pet fur, diesel soot
	Sometimes detectable	Steam, oil vapors

Check lamp

This lamp lights to notify users that it is time to replacement or care. Check the operating panel for the area requiring attention.

(Any of the humidifying filter lamp, Air-purifying filter lamp, UNIT1/2 lamps, or water supply lamp will light or flash together with the check lamp.) ▶Page 25.



Humidity indicator lamp
 (For reference only)
 This lamp indicates the room humidity detected by humidity sensor.
 ● :Humidity: 40% or less
 ●● :Humidity: Approx. 50%
 ●●● :Humidity: 60% or more
 In case running the unit just to air purifying operation, the lamp also indicates the humidity level.



Odor sensor lamp
 Odor sensor detects the changes in airborne odors. The level of odors is indicated by odor sensor lamp on 3 colors: green, orange and red.

- When the lamp is lit on green, the air is clean.

- In the following cases, the lamp is lit on green for the initial 1 minute. This state is regarded as the sensitivity reference value of the odor sensor.
 - (1) Operation directly after setting the front panel.
 - (2) Operation directly after setting the power plug.
 - (3) In case the operation is started again.
- If the odor level remains constant without intensifying or weakening, the sensor may not detect even strong odors.
- The odor sensor may not detect the type of odors other than ammonia, such as pet odors, garlic, etc.
- Different people have different sensitivity to odors so you might notice an odor even though the lamp is green. If bothered by odors, set manual airflow control and run the unit at a higher airflow rate.

Sensor types and performance

Odor sensor	Detectable	Cigarette odors, cooking odors, pet and toilet odors, raw waste odors, mildew odors , sprays, alcohol
	Sometimes detectable	Sudden changes in temperature and humidity, odorless gases such as CO, steam, oil vapours, gas from combustion appliances

5.3 Sensitivity Settings of the Dust Sensor

Sensitivity Settings of the Dust Sensor

If dust sensor sensitivity is not how you want it, change the setting.

Operating panel

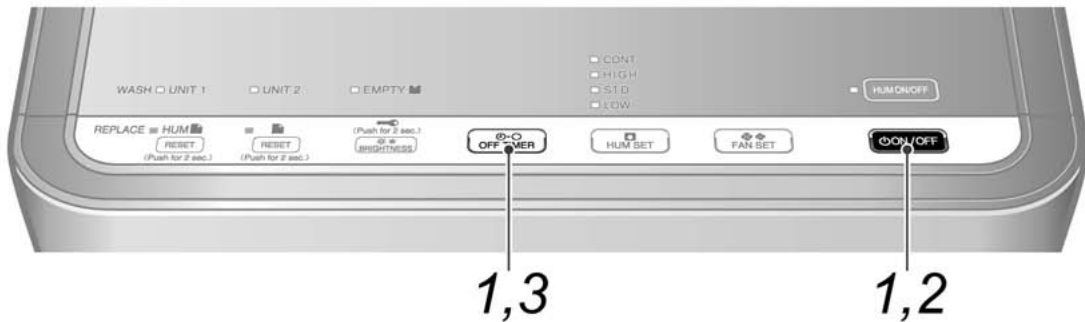

1 Press **ON/OFF** for 10 seconds.
While holding down **ON/OFF**, press **OFF TIMER**.

- After a short beep sound is emitted and the airflow ("L" (Low), "M" (Standard), "H" (High)) lamps flash for about 5 seconds, the lamp corresponding to the current sensitivity setting lights.

2 Change the sensitivity setting from **ON/OFF**.

- Each time the button is pressed, the airflow lamps and the sensitivity change as below.
- The sensitivity setting is indicated by the airflow lamps.
If the airflow lamps do not change, unplug the power supply cord, wait at least 3 seconds, plug the power supply cord back in and try the operation again from the beginning.

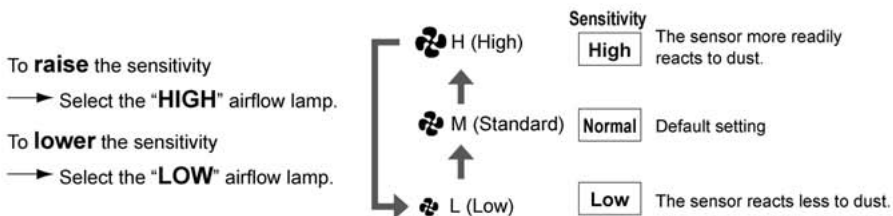

3 After changing the setting, press **OFF TIMER**.

- A short beep sound is emitted and the lamp of the set sensitivity flashes.

4 Unplug the power supply cord, wait at least 3 seconds and plug the power supply cord back in.
This completes the setting.

ATTENTION

- Dust sensor sensitivity can be set while the unit is running or stopped.
- If step **4** is not performed, the unit does not go back to the normal operating mode.

5.4 Installation

Installation

How to install

Set the unit in a preferred location.

Observe the following installation clearances to ensure unit performance.

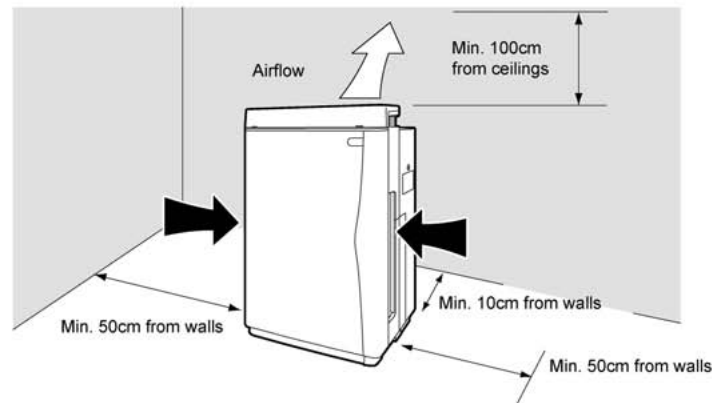

NOTE

- Depending on the type of wall, the wall may dirty even at the above installation clearance. In such case, move the unit a safe distance away from the wall.

ATTENTION

Smart installation

- Select a location that allows air to reach the entire room.
- Air is blown slightly to the right, but nothing is wrong with the unit.
- Set the unit on a stable floor. Unless the floor is stable, the unit may vibrate excessively.

Do not use the unit in the following places.

■ In contact with walls, furniture, curtains, etc.

Contacted objects may stain or deform.

■ On thick pile carpets or bedding

The unit may tilt, possibly spilling water or preventing the water level sensor from working correctly.

■ Exposed to direct sunlight or near to heaters

The unit may deform or discolor and the temperature and humidity sensors and safety devices may malfunction.

■ Exposed to outdoor air (i.e., by windows, etc.) or drafts from air conditioners, etc.

Room humidity may not be correctly indicated.

■ Near to curtains, bedding, etc.

The air inlets may be blocked, possibly leading to damage.

■ On inclined or unstable floors

The unit may fall or topple over in earthquakes or if contacted by someone. If installed on an inclined surface, a safety device may trip and stop the unit.

■ Exposed to electromagnetic waves such as near to microwave ovens, speakers, etc.

The unit may not work correctly.

5.5 Preparation of Remote Controller

Preparation of Remote Controller

Remote controller setup

1 Remote controller preparations

- Battery is already set in the remote controller.
To use the remote controller, pulling out the clear sheet from the battery cover.

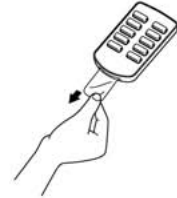

2 Using the remote controller

- Point the transmitter of the remote controller towards the receiver of the main unit.
If an obstruction to the signal, such as a curtain, exists, the remote controller will not operate.
- The distance from which the remote controller can transmit is approximately 6m.

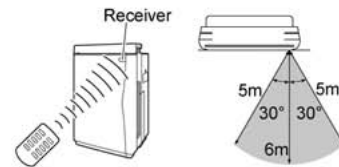

3 Battery replacement

- 1) Push the tab of the cover toward the arrow.
- 2) Pull out the cover.
- 3) Replace the battery with CR2025 (lithium) battery.
(Be sure to set the battery with the + side of the cover as shown in the figure.)
- 4) Close the cover to its original position.

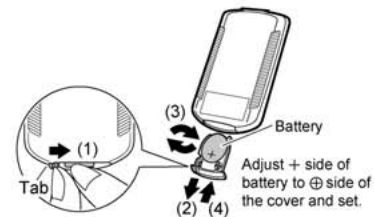

NOTE

- Store the batteries where babies and children cannot reach them.
If, by chance, a battery is swallowed, be sure to contact a doctor immediately.
- When discarding batteries, cover the terminals of the batteries with tape.
If mixed with other metal or batteries, heat, explosion or combustion may occur.

ATTENTION

Battery

- The included coin type battery is prepared for initial use.
They will be consumed within 1 year from the manufacturing date of the air purifier.
- A replacement target is approximately 1 year but if the reception becomes difficult, replace the batteries with new coin type battery CR2025 (lithium).
- Coin type battery close to the "recommended usage period" may need to be replaced soon.
- In order to prevent malfunctions or injuries due to leaking or explosions, be sure to remove the coin type battery when the unit will not be used for a long period of time.

Remote controller

- Do not drop or place the remote controller in water.
(Damage may occur.)
- Do not press the remote controller buttons with sharp objects.
(Damage may occur.)
- The signals may not be received well of electronic lighting style fluorescent lamps (such as inverter fluorescent lamps) are in the same room. For these cases, consult your dealer.
- If other electrical device operate by the remote controller, either separate them from the remote controller or consult your dealer.

5.6 Attach the Filter

Attach the Filter

⚠ CAUTION

- Do the following before plugging in the power supply cord.

Attach the pleated filter

Be sure to attach the pleated filter before starting the unit.

1 Remove the front panel.

- Push the 2 projections (left and right) inwards, and pull the front panel upwards and remove.

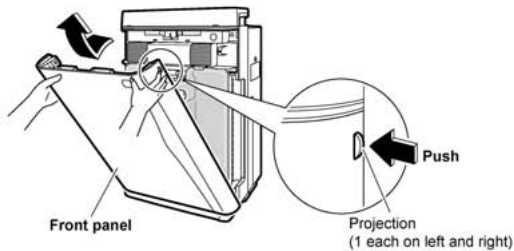

2 Remove the water tank.

- Holding the water tank by the handle, pull the tank upwards and out of the unit.

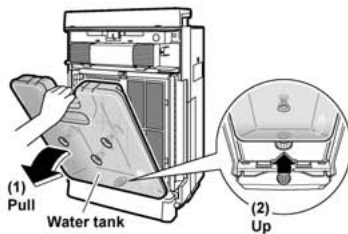

3 Remove the UNIT1.

- Holding the UNIT1 by the handle, pull the UNIT1 upwards and out of the unit.

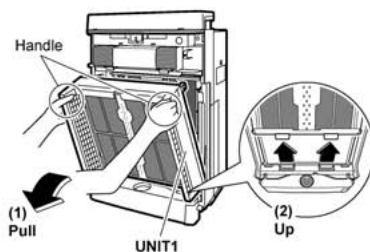

4 Remove the deodorizing catalyst unit.

- Holding the deodorizing catalyst unit by the handle, pull the deodorizing catalyst unit upwards and out of the unit.

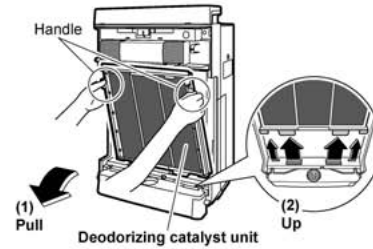

5 Attach the pleated filter.

Attach the pleated filter with the white side facing to the front.

- Fit the projections (5 locations) on the left and right faces of the deodorizing catalyst unit into the holes (5 locations) on the left and right of the pleated filter.

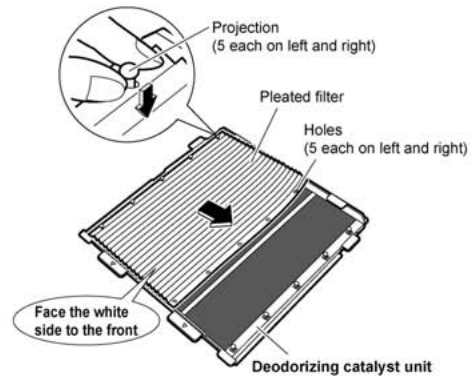

- Insert the pleated filter underneath the tabs (4 locations) at the top and bottom of the deodorizing catalyst unit.

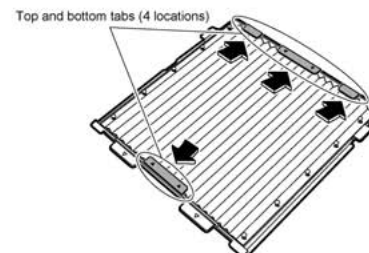

NOTE

- Always run the unit with both a pre-filter (green) and pleated filter (front: white, back: blue). Running the unit without both filters may lead to damage.
- Unit performance drops if the pleated filter is attached backwards.

5.7 Water Tank Preparations

Water Tank Preparations

Water tank preparations

Air purifying operation can be operated even without water in the tank.

1 Open the cap on the water tank.



2 Add water to the tank and close the cap.

Use only tap water.

- Add water somewhere that can be wet if spilled.
- Before adding the actual water to use in humidification, add a small amount of water to the tank, shake to rinse internally and discard the water.

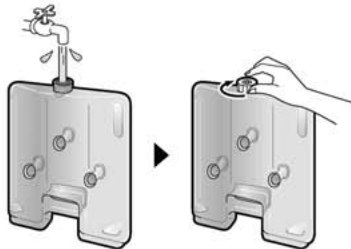

Close the water tank cap tightly.
Unless tight, water may leak.

- Hold a full water tank by the handle to carry.
- Do not touch the valve at the center of the cap. Water may spill from the tank.

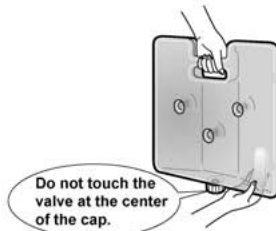

NOTE

Do not add the following to the water tank.

- Hot water of 40°C or more, aromatic oils, chemicals, dirty water, water containing fragrances or solvents, etc. Liquids of the sort may deform or damage the unit.
- Purified water, alkaline ion water, mineral water, well water, etc. These types of water may lead to mildew or bacterial proliferation.

After attaching the filter

1 Restore the deodorizing catalyst unit.

- Holding the deodorizing catalyst unit by the handle, fit the projections on the unit into the grooves (4 locations) at the bottom of the main unit and press the deodorizing catalyst unit into the main unit.

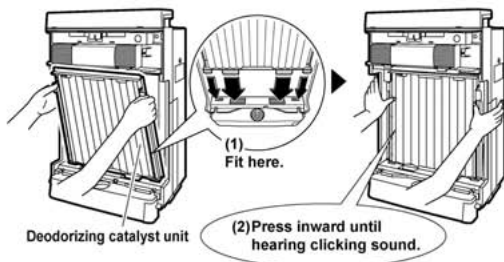

2 Restore the UNIT1.

- Holding UNIT1 by the handle, fit the projections on the unit into the grooves (2 locations) at the bottom of the main unit, and press UNIT1 into the main unit.

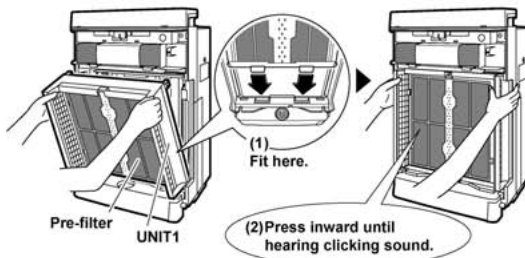

3 Restore the water tank.

- Holding the water tank by the handle, fit the tank into the hole at the bottom of the main unit, and press the tank into the main unit.

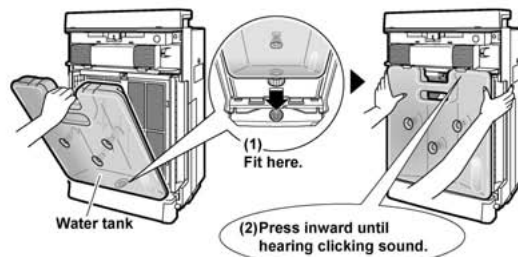

4 Restore the front panel.

- Fit the tabs (2 locations) at the bottom of the panel into the grooves at the bottom of the main unit, and close the panel.

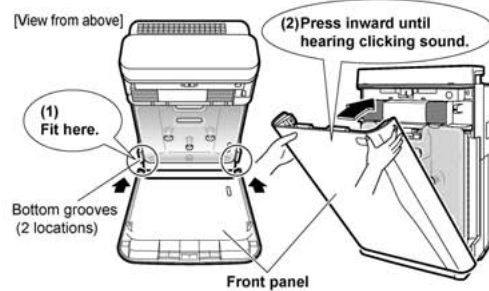

To correctly restore the front panel, press the front panel until hearing the clicking sound from the left and right sides. Unless properly installed, a safety switch may trip and prevent the unit from starting. ▶Page 27.

NOTE

- Always run the unit with both a pre-filter (green) and pleated filter (front: white, back: blue). Running the unit without both filters may lead to damage.

5.8 Air Purifying Operation

Air Purifying Operation

- Plug the power supply cord into an electrical socket.

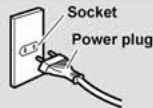

NOTE

- Do not insert or remove the power plug to turn the unit on/off. Abusive handling may lead to electric shock or fire because of overheating.

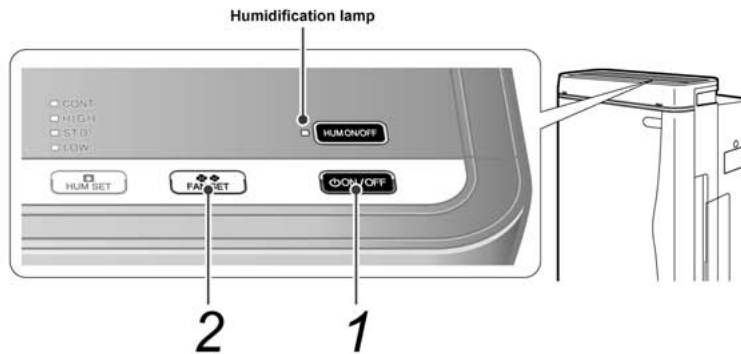

1 Press **ON/OFF**.

- If humidification was run the last time that the unit was used, humidification starts automatically, therefore press **HUMON/OFF** to turn OFF the humidification lamp.

2 Press **FAN SET** to change the airflow rate.

- Each time the button is pressed, the airflow rate changes as follows.

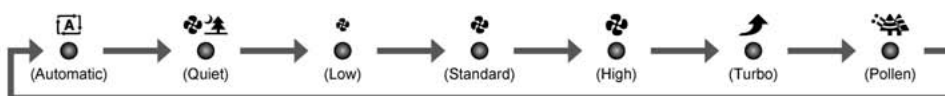

Auto mode

Airflow rate ((Quiet) (Low) (Standard) (High)) is automatically adjusted according to the dirty state of the air.

Quiet mode

Air flows at a super slow rate. This mode is recommended when sleeping.

Turbo mode

This is the high airflow rate mode that quickly removes airborne dust.

Anti-pollen mode

The airflow rate is changed every 5 minutes to create gentle air currents so as to catch the pollen before settling on the floor.

ATTENTION

- The default settings are air purifying operation and "auto" airflow rate control. If the power supply cord is unplugged or if the front panel was opened and the unit restarted, the next time that the unit is used, it runs at the last used settings.

5.9 Humidify and Air Purifying Operations

Humidify and Air Purifying Operations

- Do not move the unit while it is running. Displacements may cause water leaks, damage or malfunctions.

Air purifying operation is in active while humidifying operation.
(Humidification cannot run by itself.)

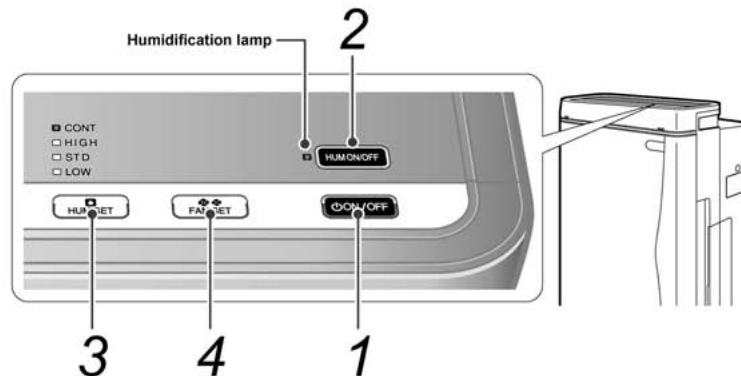

1 Press **ON/OFF**.

2 Press **HUMON/OFF** to light the humidification lamp.
• If humidification was run the last time that the unit was used, the humidification lamp lights automatically.

3 Press **HUM SET** to change the humidify setting.
• Each time the button is pressed, the humidify setting changes as follows.



NOTE

- Be sure to install the humidifying filter to run the unit.

4 Press **FAN SET** to change the airflow rate.
• Each time the button is pressed, the airflow rate changes as follows.
• The fan will be set to auto mode if the HIGH, STD, or LOW humidity setting is selected while in humidifying operation. The airflow rate setting cannot be select.
• To set the airflow rate, set the humidify setting "CONT". Humidifying capacity increases alongside airflow rate.
• When set to "auto", airflow rate is automatically adjusted according to the dirty state of the air and humidity in the air.

ATTENTION

- As water is supplied from the water tank to the humidifying tray, the sound may be heard, but there is nothing wrong with the unit.
- If the set humidity is reached or the water supply lamp lights during humidification, humidification stops, but air purifying operation continues.
- Humidification rate varies according to the airflow rate setting.

5.10 How to Operate with Remote Controller

How to Operate with Remote Controller

How to operate with remote controller

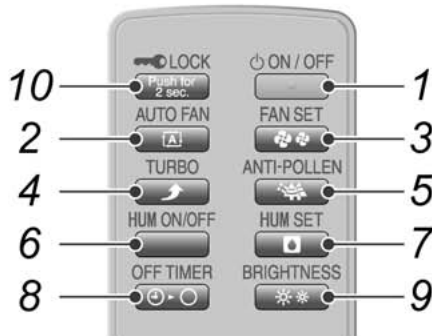

1. ON/OFF button
2. Auto fan button
3. Fan setting button
4. Turbo button
5. Anti-pollen button
6. Humidify ON/OFF button
7. Humidify setting button
8. OFF TIMER button
9. Brightness adjustment button
10. Child proof lock button

1 To start operation

Press “ ON / OFF”.

- Pressing again will stop.

2 To automatically switch the airflow rate

Press “”.

- Automatically adjusts the airflow rate to “ LL (Quiet), “ L (Low), “ M (Standard), “ H (High) in response to the dirty state of the air.

3 To manually switch the airflow rate

Press “”.

- Each time it is pressed, the airflow rate switches as shown below allowing you to choose your desired flow.



- The setting “ LL (Quiet) is a very slow airflow rate and is convenient when sleeping.
- After setting “ LL (Quiet) the power for cleaning the air decreases because of the operation at slow airflow rate.

4 To clean the air quickly

Press “”.

- A high airflow rate will quickly remove any dirtiness in the air.
- This is convenient to use when cleaning.

5 To remove pollen

Press “”.

- Switching the airflow speed every 5 minutes between “ M (Standard) and “ L (Low) will catch pollen before they fall on the floor.

6 To switch the humidifying operation ON/OFF

Press "**HUM ON/OFF**".

- Each time it is pressed, the humidifying operation ON/OFF will switch.
- When the humidifying operation ON/OFF is switched humidity indicator lamp indicate temporarily as shown below.
 - In case the humidifying operation is turned ON: the humidity indicator lamp will be changed and indicate the setting.
 - In case the humidifying operation is turned OFF: the humidity indicator lamp will turn OFF for 2 seconds.

7 To change the humidify setting

Press "**HUM SET**".

- Each time it is pressed, the humidity indicator lamp indicate temporarily as shown below.



8 To decide a time to stop operation

Press "**OFF TIMER**".

- Each time it is pressed, the timer setting switches as shown below. The remaining time will be lit in the OFF timer lamp.



- When the set time is reached, the operation will automatically stop.
- The set time can be changed if the button is pressed while the timer is operating.

9 To change the brightness of the operation panel lamps and front indicator lamps

Press "**BRIGHTNESS**".

- Each time it is pressed, the display will switch as shown below.

<Operating panel lamps>



<Front indicator lamps> [▶Page 11, 12.](#)



- Only the front indicator lamps go completely off.

10 To prevent incorrect operation

Press "**LOCK**" for 2 seconds.

- Stops the function of the button other than the "**LOCK**" on the main unit and buttons on the remote controller.
- This makes it possible to prevent children from operating the unit incorrectly.
- To release the child proof lock settings, press "**LOCK**" again for 2 seconds.
- To release the child proof lock settings when the remote controller is not in your hand, press "**BRIGHTNESS**" of the unit for 2 seconds.

NOTE

- The unit will not operate for 3 seconds after the front panel is set or power plug is inserted even though "**ON/OFF**" button on the remote controller is pressed.
- Operation will stop for safety when the front panel is opened during operation.
- When an incorrect operation is performed during operation. If the main unit display is abnormally on or remote controller is disabled due to thunder or radio transmission during operation, pull the power plug and then re-insert it after 3 seconds.

5.11 How to Use the Recyclable Deodorizing Cartridge

How to Use the Recyclable Deodorizing Cartridge

- The recyclable deodorizing cartridge can be removed from the air purifier and used to deodorize remote locations. Deodorizing capacity can be regenerated with the streamer pocket so as to use the cartridge time and time again.

Uses The deodorizing cartridge can be used in the below places.

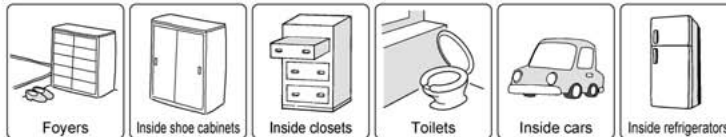

For refrigerator use only
(The recyclable deodorizing cartridge cannot be used inside freezers.)

- Do not use or store the recyclable deodorizing cartridge anywhere near to flames, exposed to direct sunlight or that is extremely hot or humid.

To use Inside refrigerators

- Use 1 recyclable deodorizing cartridge per 450L of refrigerator.
- For sanitary reasons, use the cartridge solely for the refrigerator.
- Position the cartridge so as not to contact food.
- Do not use the cartridge Inside freezers.
- Condensation forms on the case if the cartridge is moved from cold places to warm places.
- If condensation adheres to the cartridge, wipe up the water with a soft piece of cloth and dry the cartridge naturally.

To use Inside cars

- Position the recyclable deodorizing cartridge so as not to obstruct the driver's vision.
- Do not locate the cartridge under the driver's seat because it may obstruct pedal operations.
- Do not locate the cartridge in hot places such as on the dashboard, because it may deform.

How to use

(1) Take the recyclable deodorizing cartridge out of the bag.

- Though it can be used as is, a better deodorizing effect is obtained if the cartridge is first regenerated before actual use.
- Bag content: Deodorizing catalyst filter (1pc.)
- Components: Photocatalyst (titanium apatite), activated charcoal

(2) Set the starting month on the back of the recyclable deodorizing cartridge.

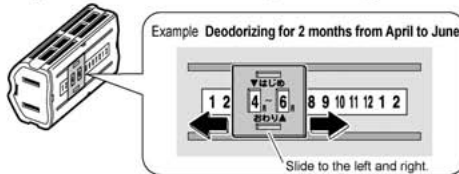

(When the left slot is over the starting month, the month that the deodorizing cartridge should be regenerated is shown in the right slot.)

(3) Set in a smelly place.

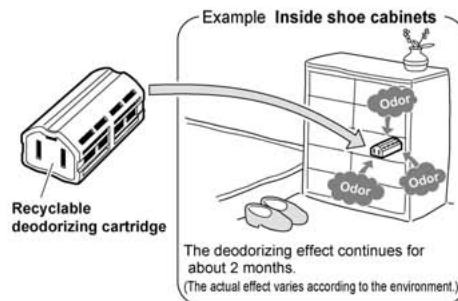

Expected duration of effect	About 2 months
Recommended coverage area	About 1.7m ²

The recyclable deodorizing cartridge removes odors by absorbing the odor element therefore sufficient effect may not be obtained if used in spacious places.

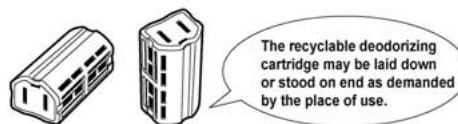

NOTE

- The recyclable deodorizing cartridge is not edible. Accidental swallowing may result in serious illness, therefore be particularly mindful to place the cartridge out of the reach of children. If accidentally swallowed, consult a doctor.
- Do not use the cartridge together with other air fresheners, deodorizers, insecticides, etc.
- Keep away from pets.
- Clothes may be stained if contacted by the cartridge.
- Use the cartridge solely for its intended purpose.
- Do not disassemble the cartridge.
- The recyclable deodorizing cartridge is not intended for use in spacious places and places of strong smell, therefore use the main unit in those cases.
- The air purifier may be used with the recyclable deodorizing cartridge inserted Inside the streamer pocket without any problems.

How to regenerate the recyclable deodorizing cartridge

After about 2 months (reference only), regenerate the recyclable deodorizing cartridge inside the streamer pocket.
 Sufficient deodorizing effect may not be obtained if the cartridge is not regenerated periodically.
 Recyclable deodorizing cartridge regeneration is started and stopped by opening and closing the streamer pocket.

Procedure

Note

1 Open the streamer pocket and place the recyclable deodorizing cartridge inside.

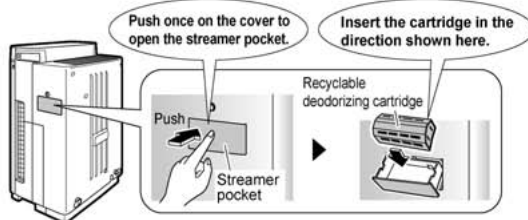

- Do not put anything other than the recyclable deodorizing cartridge into the streamer pocket. This may lead to damage.
- The recyclable deodorizing cartridge cannot be regenerated if wet with condensation, etc. Inserting a wet cartridge into the streamer pocket may lead to damage.

2 Close the streamer pocket.

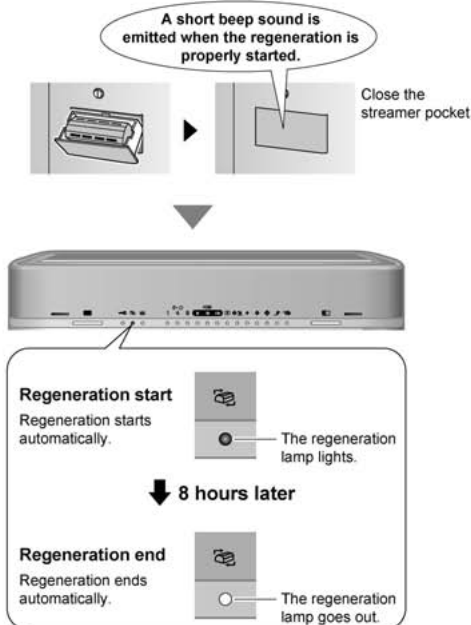

After regeneration ends, remove the recyclable deodorizing cartridge and return it to its place of use.

- Do not use the air purifier with the streamer pocket open. This may lead to damage.
- The streamer pocket can be locked. [▶Page 8.](#)
- When starting regeneration, make sure the regeneration lamp lights.
- The recyclable deodorizing cartridge can be regenerated without running the air purifier by simply plugging into the power supply cord.
- Regeneration stops automatically for safety reasons if the front panel is opened or the power supply cord is unplugged during regeneration. In such case, the regeneration time also resets. To start regeneration again, open and close the streamer pocket.
- Depending on the conditions of use and how old the recyclable deodorizing cartridge is, regeneration may not completely restore the deodorizing effect.
- The recyclable deodorizing cartridge can be regenerated about 200 times. (The actual amount varies according to the environment.)

■ Main operating condition

	Regeneration
Air purifier running	Possible
Air purifier stopped	Possible (Fan turns and air is blown from the air outlet.)
Child proof lock engaged	Possible
Unit unplugged Front panel open	Impossible

5.12 Quick Reference Table of Maintenance

Quick Reference Table of Maintenance

⚠ WARNING

- Before performing maintenance, stop the unit and unplug the power supply cord.

If the check lamp lights, check the location that requires attention on the operating panel.

- Any of the humidifying filter lamp (HUM), Air-purifying filter lamp (), UNIT1/2 lamps, or water supply lamp (EMPTY) will light or flash together with the check lamp ().

<Front indicator lamps>

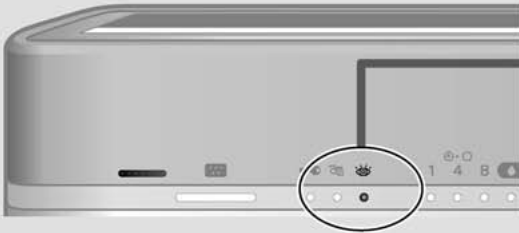

<Operating panel>

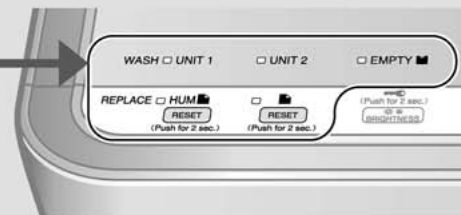

Remove parts for maintenance in numerical order.

Reattach them in the opposite order in which they were removed.

Sequence	Part	When to perform maintenance	How to perform maintenance	Reference page
(1)	Front panel	If bothered by dirt	Wipe	Page 27.
(2)	Water tank	Every time you add water	Rinse with water	Page 28.
(3)	Pre-filter	Once every 2 weeks	Vacuum cleaner Rinse with water	Page 29.
(4)	UNIT1 (Plasma ionizer)	If the "UNIT1" lamp lights	Soak, drain and dry	Page 33, 34.
(5)	UNIT2 (Streamer unit)	If the "UNIT2" lamp lights	Soak, drain and dry	Page 33, 34.
(6)	Pleated filter	If the Air-purifying filter lamp lights or flashes	Replace Cannot be rinsed in water	Page 30, 31.
(7)	Deodorizing catalyst unit	If bothered by dirt	Vacuum cleaner Cannot be rinsed in water	Page 28.
	*Humidifying tray	Once every 3 days	Rinse with water	Page 36.
	*Humidifying filter (Waterwheel)	Once every 1 week	Soak, drain and dry	Page 35.
	*Humidifying filter	If the humidifying filter lamp lights or flashes	Replace	Page 37.
	Air inlets for Dust/Odor sensors and Temperature/Humidity sensors	If clogged	Vacuum cleaner	Page 27.
	Recyclable deodorizing cartridge	If dust has accumulated If bothered by dirt	Vacuum cleaner Soak, drain and dry Cannot be washed with detergent	Page 28.

*To clean the humidifying tray or humidifying filter, first remove the (1) front panel and remove the (2) water tank.

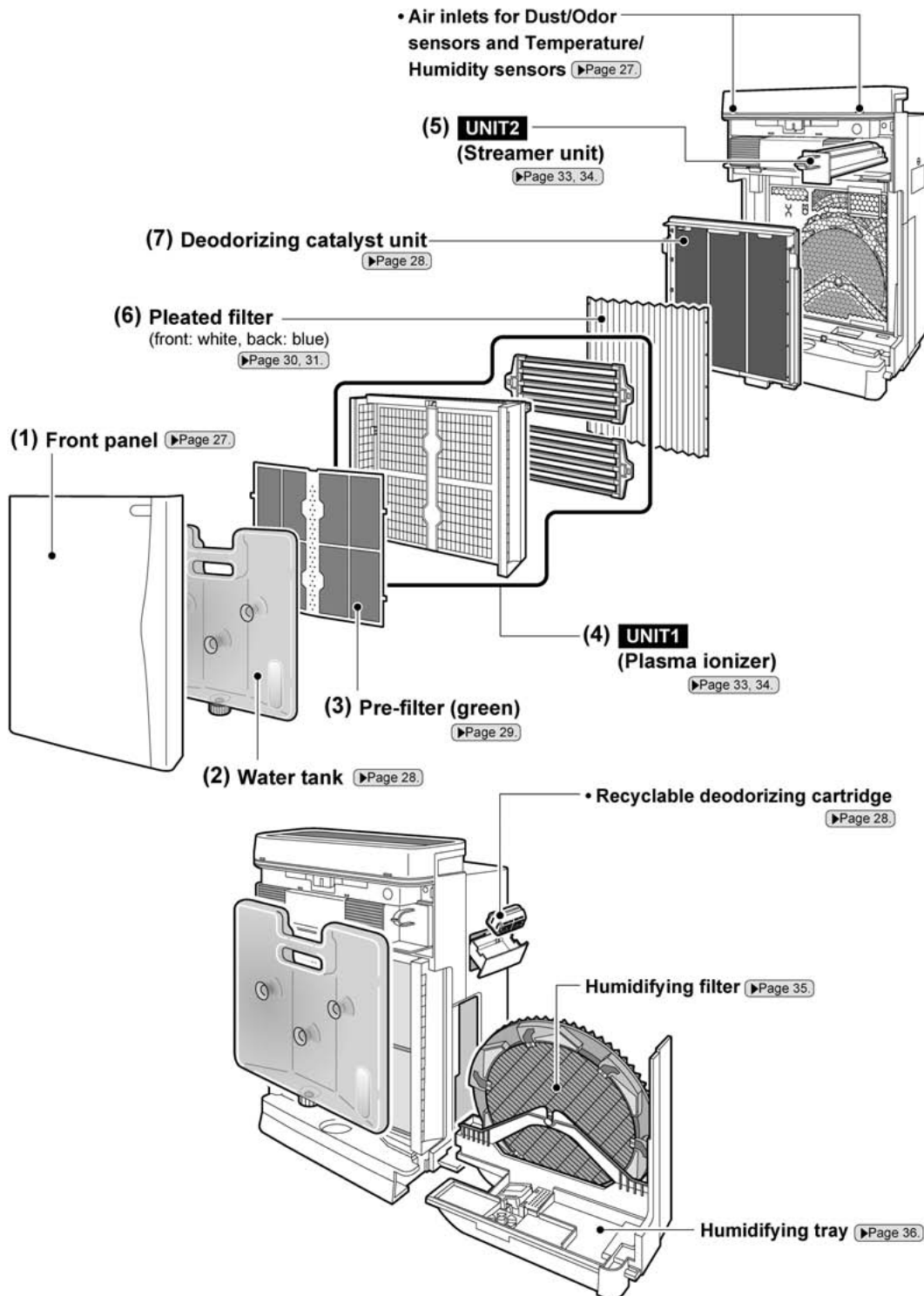

To clean the humidifying tray or humidifying filter, first remove the (1) front panel and remove the (2) water tank.

5.13 Care and Cleaning

Care & Cleaning

Front panel cleaning Wipe

- Wipe off dirt with a piece of cloth or tissue moistened with water.
- For stubborn dirt, wipe with a cloth moistened with a neutral liquid detergent.



CAUTION

- Do not use hard bristle brushes, etc. Tools of the sort may scratch the front panel.

WARNING

- Do not use petrol, benzene, thinner, scouring powder, kerosene, alcohol, etc. Substances of the sort may lead to cracking, electric shock or ignition.
- Do not wash the unit frame with water. Contact with water may lead to electric shock, fire or damage.

Sensor air inlet cleaning Vacuum cleaner (Dust, odor, temperature and humidity sensors)

- Using a vacuum cleaner nozzle attachment with a narrow opening, suck up dust adhering to the air inlets and sensor holes.

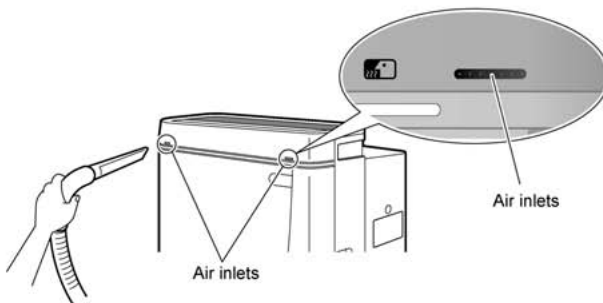

Unit frame cleaning Vacuum cleaner

- If dust has accumulated, suck it up with a vacuum cleaner.

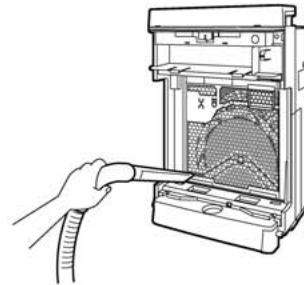

NOTE

- Be careful not to scratch the front of the front panel or damage the projections on the back of it when it is removed. The projections on the backside operate as a safety switch that shuts power OFF when the panel is opened. If damaged, the unit cannot be started.

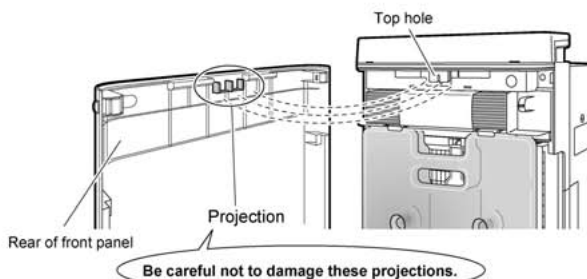

WARNING

- In the rear of the hole at the top of the unit is a safety switch, therefore do not touch it. Touching the switch may result in electric shock.
- If the switches are accidentally damaged and the unit cannot be started as a result, contact the service shop.

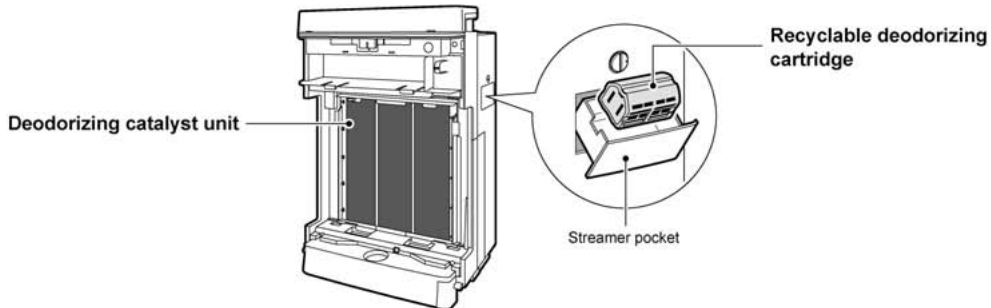

Recyclable deodorizing cartridge cleaning

Vacuum cleaner

Soak, drain and dry

Cannot be washed with detergent

- If dust has accumulated, suck it up with a vacuum cleaner.
- If bothered by dirt on the cartridge, soak the cartridge in warm or plain water for about 10 minutes, drain thoroughly and dry in a well-ventilated shade for about 1 day.

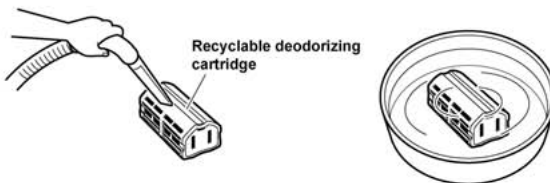

CAUTION

- Do not disassemble the recyclable deodorizing cartridge.
- Do not use detergents, chemicals, etc. Substances of the sort diminish deodorizing performance.

Water tank cleaning

Rinse with water

- Each time before you add water to the tank, add a small amount of water to the tank, close the cap and shake to rinse internally.
- Once a week, clean the inside of the tank by adding neutral liquid detergent to the water and shaking tank.
- For stubborn dirt, wash with a soft bristle brush or neutral liquid detergent. Rinse off the detergent thoroughly.



Deodorizing catalyst unit cleaning

Vacuum cleaner

Cannot be rinsed in water

Replacement unnecessary

- Remove the deodorizing catalyst unit and suck up dust with a vacuum cleaner.
- Do not rub the front surface.
- For procedures on removing and restoring the deodorizing catalyst unit, see "Pleated filter replacement". [▶Page 30, 31.](#)

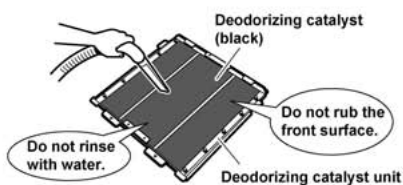

CAUTION

- Do not rinse the deodorizing catalyst unit with water. Contact with water prevents further use.



Care & Cleaning

Pre-filter cleaning (About once every 2 weeks) **Vacuum cleaner** **Rinse with water**

1 Remove the front panel.

- Push the 2 projections (left and right) inwards, and pull the front panel upwards and remove.

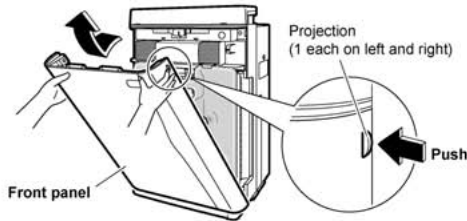

2 Remove the water tank.

- Holding the water tank by the handle, pull the tank upwards and out of the unit.

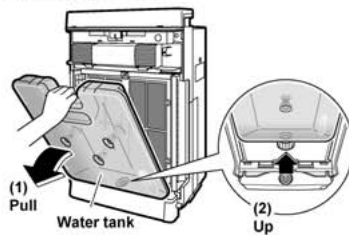

3 Clean the pre-filter.

- Suck up dust with a vacuum cleaner.



4 For stubborn dirt Rinse the pre-filter with water.

- Fit your fingers in the recess at the top of the pre-filter, pull the filter to the front and disengage the tabs (4 locations) on the left and right of the pre-filter from the holes (4 locations) on the left and right of UNIT1.

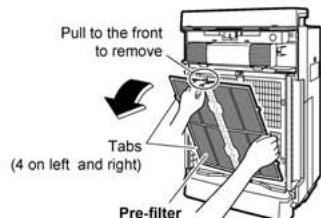

- For stubborn dirt, wash with a soft bristle brush or neutral liquid detergent, and dry thoroughly in a well-ventilated shade.

If water droplets remain on the pre-filter, the "UNIT1" lamp may light, therefore dry the pre-filter adequately before using it again.

5 Restore the pre-filter.

- Align the tabs (4 locations) on the left and right of the pre-filter with the holes (4 locations) on the left and right of UNIT1, and insert into the holes.

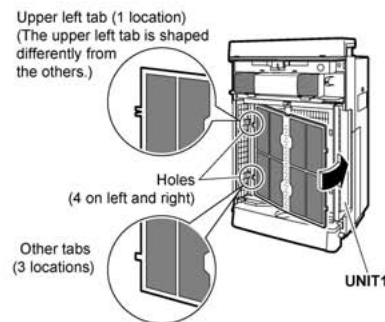

6 Restore the water tank.

- Holding the water tank by the handle, fit the tank into the hole at the bottom of the main unit, and press the tank into the main unit.

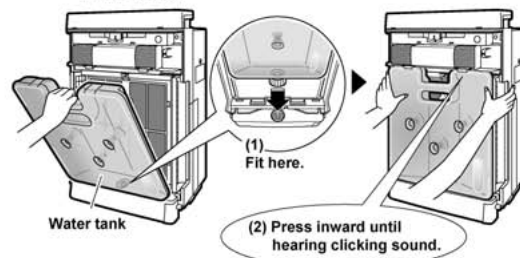

7 Restore the front panel.

- Fit the tabs (2 locations) at the bottom of the panel into the grooves at the bottom of the main unit, and close the panel.

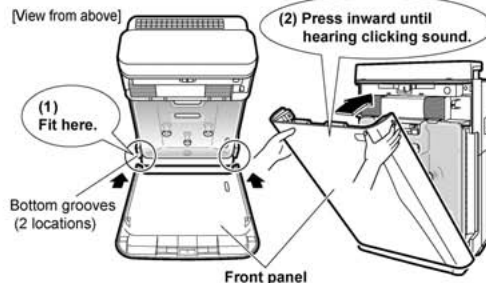

To correctly restore the front panel, press the front panel until hearing the clicking sound from the left and right sides. Unless properly installed, a safety switch may trip and prevent the unit from starting. [▶Page 27.](#)

Plated filter replacement

Cannot be rinsed in water



The plated filter does not need replacing until the Air-purifying filter lamp lights or flashes.

If the Air-purifying filter lamp lights or flashes

Replace

WARNING

- Before performing maintenance, stop the unit and unplug the power supply cord.

1 Remove the front panel. [▶Page 29.](#)

2 Remove the water tank. [▶Page 29.](#)

3 Remove the UNIT1.

- Holding the UNIT1 by the handle, pull the UNIT1 upwards and out of the unit.

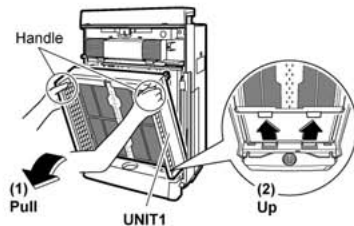

4 Remove the deodorizing catalyst unit.

- Holding the deodorizing catalyst unit by the handle, pull the deodorizing catalyst unit upwards and out of the unit.

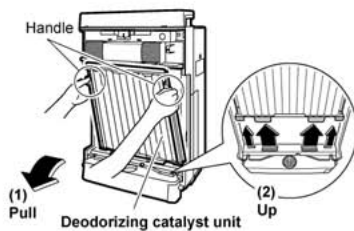

5 Replace the plated filter with a new filter.

- (1) Remove the used plated filter.
 - Release the plated filter from the projections (5 locations each) on the left and right of the deodorizing catalyst unit (front side).
- (2) Take a new plated filter from the filter storage area, remove it from its bag and attach it to the deodorizing catalyst unit.

Attach the plated filter with the white side facing to the front.

- Fit the projections (5 locations) on the left and right faces of the deodorizing catalyst unit into the holes (5 locations) on the left and right of the plated filter.

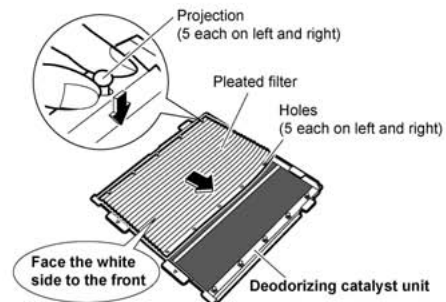

- Insert the plated filter underneath the tabs (4 locations) at the top and bottom of the deodorizing catalyst unit.

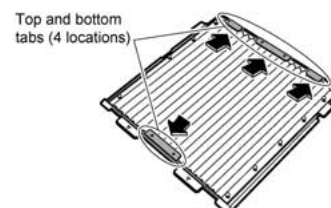

NOTE

- If the deodorizing catalyst unit is dirty, suck up dust with a vacuum cleaner. If the plate is dirty, wipe off dirt with a piece of cloth or tissue moistened with water. [▶Page 28.](#)
For stubborn dirt, wipe with a cloth moistened with a neutral liquid detergent. (Do not rinse in water.)

Care & Cleaning

6 Restore the deodorizing catalyst unit.

- Holding the deodorizing catalyst unit by the handle, fit the projections on the unit into the grooves (4 locations) at the bottom of the main unit and press the deodorizing catalyst unit into the main unit.

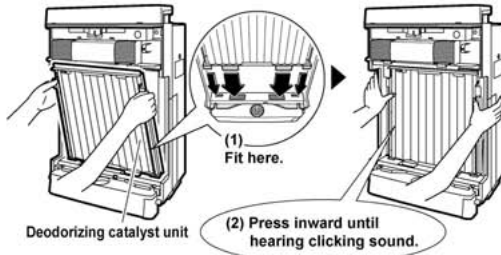

7 Restore the UNIT1.

- Holding UNIT1 by the handle, fit the projections on the unit into the grooves (2 locations) at the bottom of the main unit, and press UNIT1 into the main unit.

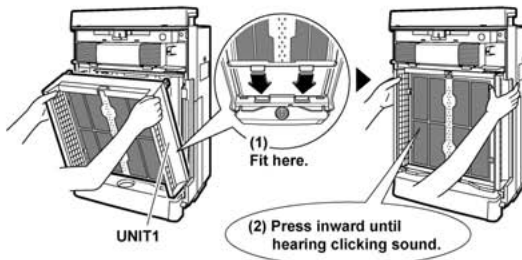

8 Restore the water tank. [▶Page 29.](#)

9 Restore the front panel. [▶Page 29.](#)

10 Plug the power supply cord in.

11 Press and hold the air-purifying filter reset button at the top of the unit for 2 seconds.

(A double acoustic tone is emitted and the Air-purifying filter lamp goes out.)

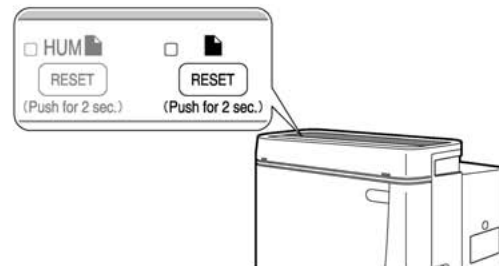

- After replacing the pleated filter, the Air-purifying filter lamp does not go out unless the filter reset button is pressed and held for 2 seconds.

— Pleated filter replacement —

- For replacement pleated filters, contact the service shop. (See the ATTENTION on page 38.)
- The pleated filter does not need replacing until the Air-purifying filter lamp lights or flashes. Replace the pleated filter if the Air-purifying filter lamp lights or flashes, even if the filter is not dirty. Visible grime and filter performance are not proportional to one another.
- The replacement interval for the pleated filter varies according to how the unit is used and where it is located. The Air-purifying filter lamp lights after about 1 year in a home where every day 10 cigarettes are smoked and the unit is used. (The replacement interval shortens when the unit is used where the air is particularly dirty.)
- Dispose of used pleated filters as noncombustible waste. (Material: polypropylene/polyester nonwoven textile)
- If you replace the pleated filter before the Air-purifying filter lamp lights because dirt bothered you, press and hold the pleated filter reset button for 2 seconds.

UNIT1 (Plasma ionizer) removing and attaching

⚠ CAUTION

- Wear rubber gloves to remove and attach the opposite pole plates. Hands can be cut on the opposite pole plates and ionized wires.

Remove

1 Remove the front panel. [▶Page 29.](#)

2 Remove the water tank. [▶Page 29.](#)

3 Remove the UNIT1.
 • Holding the UNIT1 by the handle, pull the UNIT1 upwards and out of the unit.

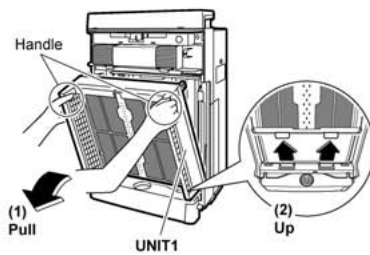

4 Remove the opposite pole plates on the backside of UNIT1.

- Pinching together the white and green knobs (2 sets on left and right), lift the opposite pole plates up and out.

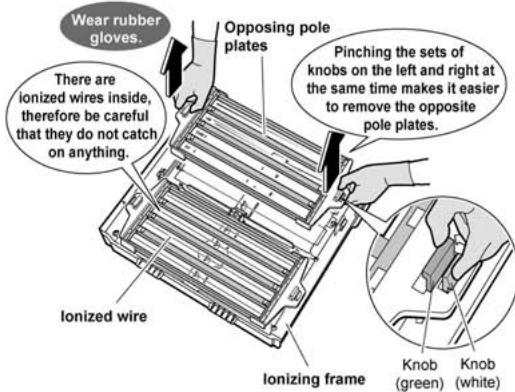

Attach

1 Attach the opposing pole plates.
 (1) Fit the opposite pole plates over the knobs (2 sets on left and right) on the ionizing frame.

The opposite pole plates have no required right and left direction and can be attached either side of ionizing frame. Attach them so that the arrow is visible.

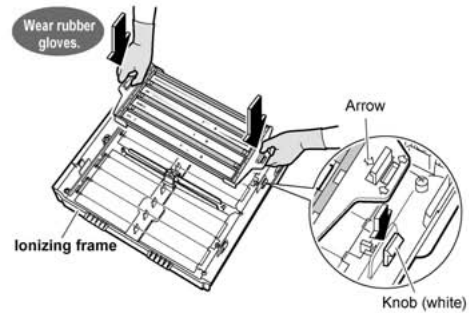

(2) Insert securely until it clicks.

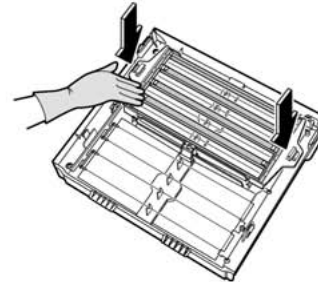

(3) Attach another side of the opposing pole plate.

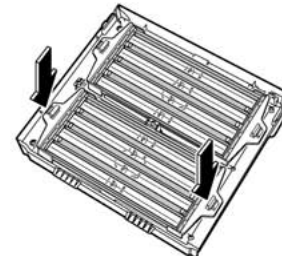

2 Restore the UNIT1 [▶Page 31.](#), pre-filter, water tank and front panel. [▶Page 29.](#)

Care & Cleaning

Cleaning UNIT1 (plasma ionizer) and UNIT2 (streamer unit)

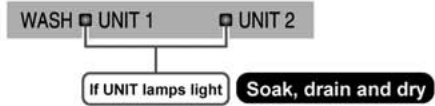

CAUTION

- Before performing maintenance, stop the unit and unplug the power supply cord.
- Wear **rubber gloves** to when wiping or rubbing the units. Hands can be cut on the opposite pole plates and ionized wires.

Procedure	UNIT1		
	(1) Ionizing frame	(2) Ionized wire	(3) Opposing pole plates
Remove parts.	▶Page 32.		▶Page 32.
Suck up dust on the front surface with a vacuum cleaner.			
Soak in lukewarm or plain water. (Approx. 1 hour)			
Remove dirt with a piece of cloth, soft bristle brush, etc.	<p>Wipe</p> <p>Wear rubber gloves.</p> <p>(For details, see (1) and (2) in the below figure.)</p>	<p>Rub</p> <p>Wear rubber gloves.</p>	
Rinse in running water and drain.			
Dry in a well-ventilated shade. (Approx. 1 day)			
Reattach parts.	▶Page 31.		▶Page 32.

(1) Ionizing frame (Remove dirt after soaking but before drying.)

- Remove dirt from plastic parts with a soft piece of cloth.
- Wipe away dirt in recesses and places where fingers do not fit with a cotton swab, etc.
- Do not leave any lint from cleaning cloths behind. Lint may lead to malfunction.



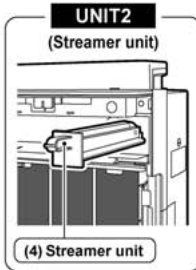
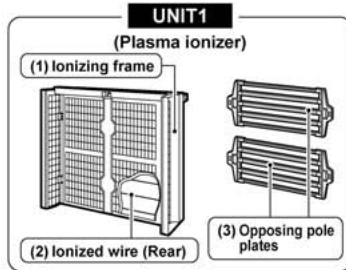

CAUTION

- There are ionized wires to the rear of the opposite pole plates. Be careful not to snap these wires when removing and attaching the units.
- If the unit is run with broken ionized wires, the "UNIT1" lamp lights. While the lamp is lit, dust collecting capacity is low.
- If the ionized wires are accidentally snapped, they need replacing, therefore contact the service shop. (Do not replace the wires yourself.)

UNIT2	Notes
(4) Streamer unit	
Open the front panel and pull out the streamer unit.	
	<ul style="list-style-type: none"> Do not remove the screws from the ionizing frame or streamer unit. This may lead to damage.
	<ul style="list-style-type: none"> Clean UNIT1 and UNIT2 somewhere that can be wet such as in a shower room or kitchen sink. For stubborn dirt, soak UNIT1 and UNIT2 in lukewarm or plain water in which neutral liquid detergent (i.e., kitchen cleaner, etc.) has been dissolved. Use the amount of neutral liquid detergent indicated in the cleaner's instructions.
<p>Wipe</p> <p>Wear rubber gloves.</p> <p>(For details, see (4) in the below figure.)</p>	<ul style="list-style-type: none"> Do not use powdered, alkaline or acidic cleaners, and do not rub with hard bristle brushes, etc. Abusive handling may lead to deformation and damage. Do not touch the needles inside UNIT2 (streamer unit). Deodorizing capacity diminishes if the needles are deformed.
	<ul style="list-style-type: none"> If cleaner remains on UNITS 1 or 2, the "UNIT1" and "UNIT2" lamps do not go out after cleaning, therefore rinse off the cleaner well. Do not leave any lint from cleaning cloths behind. Lint may lead to malfunction. Plastic parts may deform or discolor if exposed to direct sunlight. If water remains on UNITS 1 or 2, even in small quantities, the "UNIT1" and "UNIT2" lamps do not go out after cleaning, therefore dry thoroughly in a shade.
Reattach the streamer unit as before.	

(2) Ionized wire (8 locations)

- Remove dirt from ionized wires and surrounding plastic parts with a soft piece of cloth.



(4) Streamer unit

- Remove dirt from plastic parts (■) in internal areas with a cotton swab or soft piece of cloth.
- Do not remove the screws.

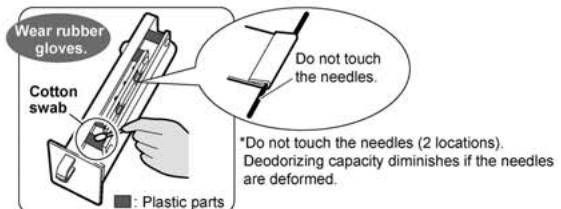

Care & Cleaning

Humidifying filter cleaning (About once every 1 week) Soak, drain and dry

How quickly the humidifying filter becomes dirty depends on the environment of use. If odors are emitted from the air outlet or if humidification capacity is low (the decrease of water is slow), clean the humidifying filter as follows even within 1 week. Clean the humidifying filter in the same way if the unit has not been used for a long period of time.

WARNING

- Before performing maintenance, stop the unit and unplug the power supply cord.

1 Remove the front panel and water tank.

▶Page 29.

2 Pull out the humidifying tray and remove the waterwheel and humidifying filter.

- The water tank must first be removed to pull out the humidifying tray.
- Hold the humidifying tray by the recess on its underside to pull out. (See the figure at right.)
- The humidifying tray contains water, therefore pull it out slowly.

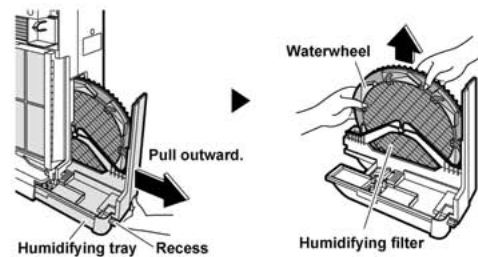

Do not remove the humidifying filter from the waterwheel. The filter may lose its shape.

3 Dissolve neutral liquid detergent in warm or plain water.

Quantity: Use the amount of neutral liquid detergent indicated in the cleaner's instructions.

4 Immerse the humidifying filter in the water and soak for about 30 - 60 minutes.

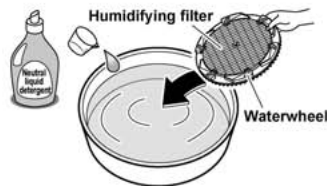

For stubborn scale (white or brown)

(Running the unit with scale diminishes humidifying capacity.)

3 Dissolve citric acid in warm (approx. 40°C or less) or plain water.

Quantity: Approx. 20g citric acid (2 large spoonfuls) per 3L water.

4 Immerse the humidifying filter in the water and soak for about 2 hours.



ATTENTION

- Citric acid can be purchased at pharmacies and drugstores.

5 Rinse in running water.

- Use clean water.
- Repeat 2 - 3 times with fresh water each time.
- Do not apply force to the humidifying filter when cleaning. The filter may lose its shape.

Inadequate rinsing may lead to odors or unit deformation or discoloring.

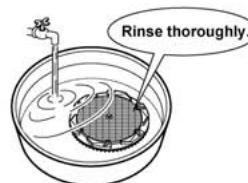

6 Restore the humidifying tray.

- Reattach the humidifying filter and waterwheel to the humidifying tray, and push the humidifying tray back into the unit until hearing clicking sound. Humidification cannot be run unless the humidifying filter is properly installed.

Attach the humidifying filter and waterwheel.

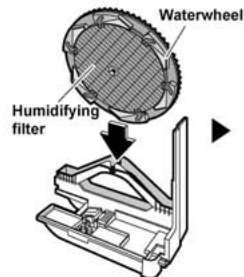

Press inward until hearing clicking sound.



7 Restore the water tank and front panel. [▶Page 29.](#)

Install the humidifying filter and waterwheel in the direction shown in the figure.

Humidifying tray cleaning (About once every 3 days) [Rinse with water](#)

1 Remove the front panel and water tank. [▶Page 29.](#)

2 Pull out the humidifying tray and remove the waterwheel and humidifying filter. [▶Page 35.](#)

3 Rinse the humidifying tray in water.



For stubborn scale

- Dissolve citric acid in lukewarm or plain water and moisten a soft cloth or soft bristle brush with the water. Remove scale with the soft cloth or the soft bristle brush. Rinse off thoroughly with clean water. *About the quantity of citric acid, refer to "For stubborn scale (white or brown)". [▶Page 35.](#)

4 Restore the humidifying tray. [▶See above.](#)

5 Restore the water tank and front panel. [▶Page 29.](#)

ATTENTION

- Do not remove the float or silver ion cartridge.
- Without the float, humidifying operation cannot be run. Without the silver ion cartridge, the antibacterial, anti-mildew and slime prevention effects are disabled.
- Depending on the water quality and environment of usage, the accumulated water in the humidifying tray may be discolored by scale etc. If that occurs, follow the instructions above and clean the tray.

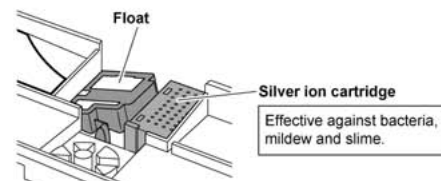

Care & Cleaning

Humidifying filter replacement (About every 2 years [2 seasons])



Using the unit without replacing the humidifying filter causes mildew, foul odors and humidification loss.

WARNING

- Before performing maintenance, stop the unit and unplug the power supply cord.

If the humidifying filter lamp lights or flashes **Replace**

1 Remove the front panel and water tank. ▶Page 29.

2 Pull out the humidifying tray and remove the waterwheel and humidifying filter. ▶Page 35.

3 Remove the shaft that locks the humidifying filter and waterwheel.

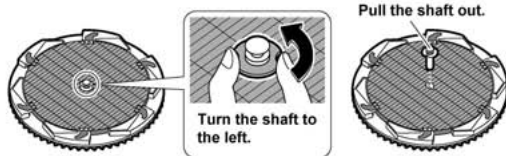

4 Remove the humidifying filter from the waterwheel, and attach a new filter.

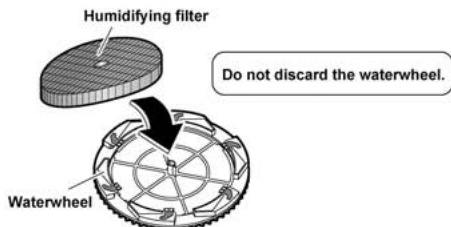

- Tuck the humidifying filter underneath the tabs (6 locations) on the waterwheel so that it does not stick out from the waterwheel.

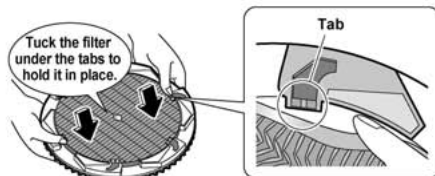

5 Restore the shaft as before.



6 Restore the humidifying tray. ▶Page 36.

7 Restore the water tank and front panel. ▶Page 29.

8 Plug the power supply cord in.

9 Press and hold the humidifying filter reset button at the top of the unit for 2 seconds. (A short beep sound is emitted and the humidifying filter lamp goes out.)

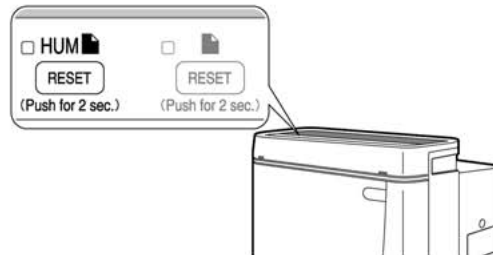

- After replacing the humidifying filter, the humidifying filter lamp does not go out unless the filter reset button is pressed and held for 2 seconds.

Humidifying filter replacement

- For replacement humidifying filters, contact the service shop. (See the ATTENTION on page 38.)
- Dispose of used humidifying filters as noncombustible waste. (Material: Polyester, rayon)

Options

ATTENTION

- For replacement pleated filters, humidifying filters or recyclable deodorizing cartridges contact the service shop.
- If the unit is used with dirty parts
 - Air is not cleaned.
 - Odors are not removed.
 - Unnecessary odors may be generated.
- Discard of the pleated filters, humidifying filters and recyclable deodorizing cartridges as noncombustible waste.

Part	Model
Pleated filter (7)	KAC998A4E
Humidifying filter (Without frame) (1)	KNME998A4E

■ Disposal requirements



Your product and the batteries supplied with the controller are marked with this symbol. This symbol means that electrical and electronic products and batteries shall not be mixed with unsorted household waste.

For batteries, a chemical symbol can be printed beneath the symbol. This chemical symbol means that the battery contains a heavy metal above a certain concentration. Possible chemical symbols are:

- Pb: lead (>0.004%)
- Hg: mercury (>0.0005%)

Do not try to dismantle the system yourself: the dismantling of the product, treatment of the refrigerant, of oil and of other parts must be done by a qualified installer in accordance with relevant local and national legislation.

Units and waste batteries must be treated at a specialized treatment facility for re-use, recycling and recovery.

By ensuring correct disposal, you will help to prevent potential negative consequences for the environment and human health. Please contact the installer or local authority for more information.

6. Optional Accessories

6.1 Dimensions

6.1.1 Pleated Filter

KAC998A4E

Specifications	
Item	Model
	KAC998A4E
Material	Non-woven fabric (electrostatic)
Quantity	7

Notes: 1. Replacement guideline: Every year (for about 7 years in total)
2. Appearance color: White (front), blue (back)

C:3JHB13523

6.1.2 Humidifying Filter

KNME998A4E

Specifications	
Item	Model
	KNME998A4E
Material	Non-woven fabric (Rayon / PET)
Quantity	1

Notes: 1. Replacement guideline: Approx. 2 years
2. Appearance color: Orange
3. Every 2 weeks, soak in water or warm water with neutral detergent for 30-60 minutes. Rinse well afterwards.

C:3JHB13522

6.1.3 Front Panel (for Russia)

BCK75J-BD

FRONT PANEL (OPTION)

Specifications	
Model	BCK75J-BD
Color and Quantity	Bordeaux: 1 Black: 1

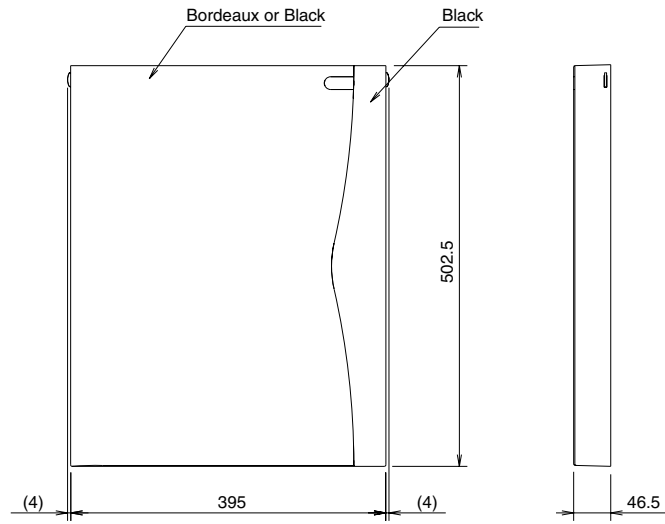

C:3D063742

7. Troubleshooting

7.1 Basic Inspection

<p>(1) Is the connector for the PCB plugged in? Or is there any poor connection?</p>	
<p>(2) Is the wire harness broken?</p>	

■It is not malfunction.

Operating panel

Lighting
 UNIT1▶Plasma ionizer
 UNIT2▶Streamer unit
 Clean as above.

Lighting or Flash
 Replace the humidifying filter or the air-purifying filter (pleated filter). Then, press and hold the RESET button for 2 seconds.

Front indicator lamps

If a long beep sound repeat 3 times is emitted and the dust and odor lamps flash (red) at the same time
 The lamps will blink if the unit is leaned in excess or toppled.
 Set the unit on a flat floor and press the ON/OFF button.

Front indicator lamps

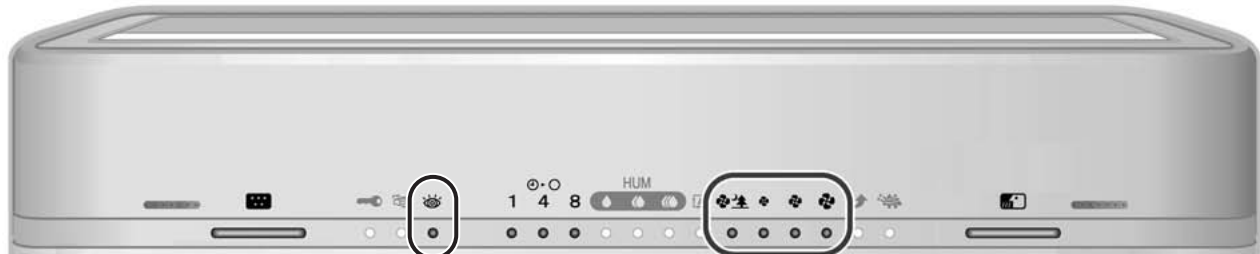

Check lamp



**If all 4 lamps flash at the same time
(The check lamp flashes, too.)**

Something is obstructing the air outlet. Unplug the power supply cord, remove the obstruction, plug the power supply cord back in and start the unit.

Operating panel

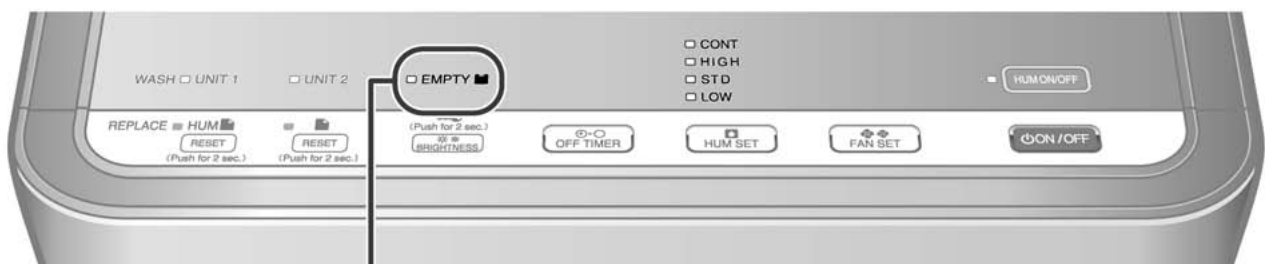

If a long beep sound repeat 3 times is emitted and the water supply lamp flashes

The humidifying tray is out of place. Install it correctly.

■ It may be malfunction.

Front indicator lamps

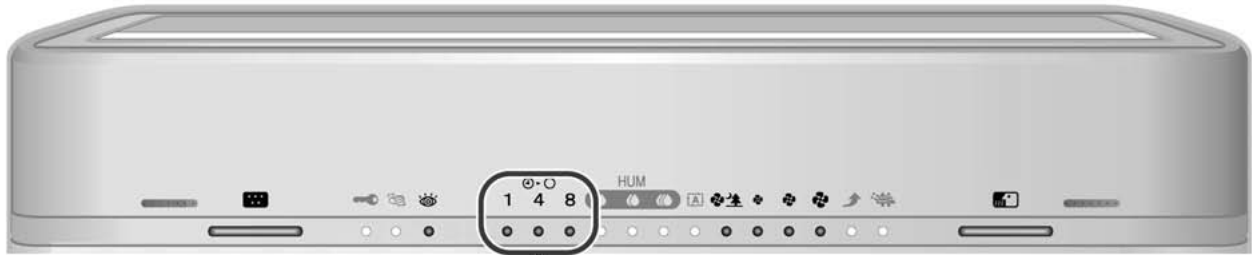

1 4 8

If all 3 lamps flash at the same time
 Trouble has occurred in electrical parts.

Contact the service shop.

Operating panel

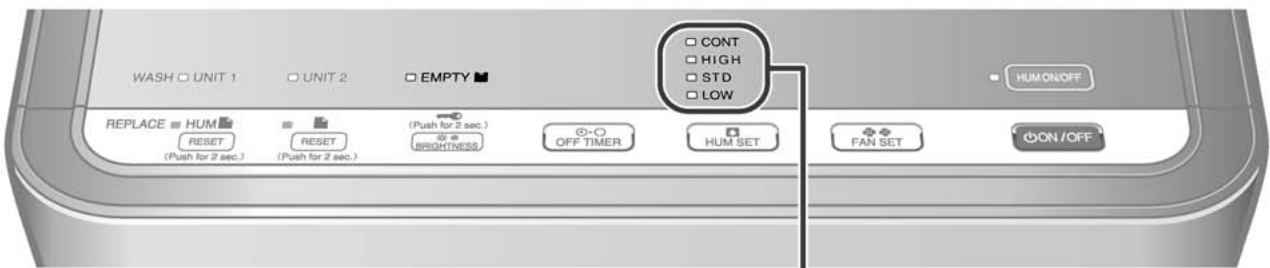

CONT
 HIGH
 STD
 LOW

If a long beep sound repeat 3 times is emitted and the 4 lamps flash at the same time
 Trouble has occurred in the temperature or humidity sensor.

Contact the service shop.

7.2 Check Before Requesting Servicing

Troubleshooting

The following situations have logical explanations. Before requesting servicing, make the following checks.

If this happens	Check
The current humidity remains high.	Humidity in rooms facing north or rooms near plumbing fixtures such as bathrooms is normally high because moisture readily accumulates.
The readings of the room hygrometer and unit's humidity indicator lamp differ.	This is because air currents cause temperature and humidity drifts even in the same room. Consider the humidity indicator lamp as just a reference reading.
A catching sound is heard during operation.	A catching sound is made when humidifying operation starts and stops.
The sound of water is heard during operation.	The sound of water may be heard as water is supplied from the water tank to the humidifying tray.
A splashing sound is heard during operation.	This is the sound of water from the waterwheel splashing on the humidifying filter.

If this happens	Check	How to resolve
Does not operate.	<ul style="list-style-type: none"> The dust and odor sensor lamps are flashing? Is the humidifying tray out of place? (The water supply lamp is flashing.) Is the front panel or UNIT1 improperly set? Are the projections on the backside of the front panel damaged? 	<ul style="list-style-type: none"> Set the unit on a flat floor and press the ON/OFF button. Set the humidifying tray properly. Securely set it. ▶Page 18. Check the projections. ▶Page 27.
<ul style="list-style-type: none"> ■ The airflow rate "high", "standard", "low" and "quiet" lamps all flash at the same time. ■ The unit does not blow air. 	<ul style="list-style-type: none"> Is there any foreign matter in the air outlet? 	<ul style="list-style-type: none"> Unplug the power supply cord, remove the obstruction, plug the power supply cord back in and start the unit. If the situation at left still persists or if the obstruction cannot be moved, contact the service shop.
Both the dust and odor sensor lamps are flashing a red color.	<ul style="list-style-type: none"> Is the unit leaned in excess or toppled? 	<ul style="list-style-type: none"> Set the unit on a flat floor and press the ON/OFF button.
Air is not cleaned.	<ul style="list-style-type: none"> Is the unit located where air does not reach the entire room or is something obstructing the air flow? Has a lot of dust accumulated on the pre-filter and/or pleated filter? Is the room overly smelly or smoky? 	<ul style="list-style-type: none"> Select an unobstructed location from where air can reach the entire room. Clean the pre-filter and/or pleated filter. ▶Page 29-31. Odors should clear as the unit continues running.
The TV picture is distorted.	<ul style="list-style-type: none"> • Is a television or radio installed within 2m of this unit or is an indoor antenna being used close to this unit? • Is the power supply cord or antenna of the television or radio close to this unit? 	<ul style="list-style-type: none"> Move the unit as far away from TVs, radios and antennas as possible. ▶Page 6.

If this happens	Check	How to resolve
Crackling, buzzing, and fizzes sounds are audible during operation.	Is the UNIT1 set securely? Has dust accumulated on the ionized wires of the ionizing frame? A hissing sound heard from UNIT2 during operation. There is nothing wrong with the unit.	Securely set it. ▶Page 18. Clean it. ▶Page 33, 34. -
Odor is coming from the air outlet.	Is a large amount of odor being generated temporarily? (Many people smoking or grilling meat.) Have you moved the main unit to another room? Are the pre-filter, pleated filter, UNIT1 and/or humidifying filter dirty? Are odors constantly being generated in the room (i.e., paint, new furniture, wall paper, sprays, cosmetics, chemicals, etc.)?	If operated, the odor will gradually go away. Odor from the original room may smell. Let the unit run for a while. Clean it. ▶Page 29-36. Ventilate the room or let the unit run with air flow promoted in the room.
The "UNIT1" lamp does not go out or immediately lights again, despite having cleaned that UNIT1 (plasma ionizer).	Is the UNIT1 set securely? Are not droplets left in the opposing pole plates or other places? Are not bits of lint left in the UNIT1? Was UNIT1 inadequately rinsed after cleaning with a cleaner? Are not the ionized wires cut?	Securely set it. ▶Page 18. Completely dry UNIT1 after cleaning it. Remove all lint. Remove any remaining cleaner. ▶Page 33, 34. Check the ionized wires. ▶Page 34. If broken, they need replacing, therefore contact the service shop.
Humidity does not rise.	Is the room too big? Is indoor temperature low with the walls and floor dry? Is air flow set to a low rate?	Use the unit in an appropriately sized room. Humidity does not readily rise if the indoor temperature is low, and the walls and floor are dry. Watch the situation for 1 - 2 weeks to see if humidity rises. Set "CONT" for the humidify setting and increase the air flow rate setting.

If the problem cannot be corrected after taking the above action, contact the service shop.

Troubleshooting

The following situations have logical explanations.
Before requesting servicing, make the following checks.

If this happens	Check	How to resolve
<p>The unit does not humidify despite having added water to the water tank. Water level in the water tank does not lower.</p>	<p>Is the humidifier ON/OFF lamp is lit?</p> <p>Does the unit have a humidifying filter?</p> <p>Has scale accumulated on the humidifying filter?</p> <p>Is the humidifying filter lamp lit or flashing?</p> <p>Is the water supply lamp flashing?</p> <p>Is the front panel open?</p>	<p>Press HUM/ON/OFF if the lamp is out.</p> <p>Install a humidifying filter. ▶Page 37.</p> <p>Soak the humidifying filter for about 30 - 60 minutes in warm or plain water in which neutral liquid detergent has been dissolved, then rinse in water. ▶Page 35, 36.</p> <p>Replace the humidifying filter. ▶Page 37.</p> <p>If the lamp is flashing, the humidifying tray is not properly installed. Install the tray properly. ▶Page 35, 36.</p> <p>If none of the front indicator lamps or the lamps on the operating panel light, the front panel may be open. Check that the front panel is securely closed. ▶Page 18.</p>
<p>The room does not humidify despite setting the "CONT" humidify setting.</p>	<p>Is the water supply lamp lit?</p> <p>Does the unit have a humidifying filter?</p> <p>Humidification capacity is low when indoor temperature is low and humidity is high.</p>	<p>Add water. ▶Page 10, 17.</p> <p>Install a humidifying filter. ▶Page 37.</p> <p>-</p>
<p>The unit does not stop even though humidity is high.</p>	<p>Is the humidify setting set to "CONT"?</p> <p>Air purifying operation is in active while humidifying operation. Humidifying operation stops when the set humidity level is reached, but air purification continues.</p> <p>Is the unit exposed to direct sunlight or the hot air draught of heaters?</p>	<p>Change the humidify setting. ▶Page 20.</p> <p>-</p> <p>Move the unit to a location where not exposed to direct sunlight or the hot air draught of heaters.</p>
<p>The water supply lamp is lit even though water was added.</p>	<p>Has the float inside the humidifying tray come off?</p>	<p>Reattach the float as before. ▶Page 36.</p>

If the problem cannot be corrected after taking the above action, contact the service shop.

7.3 Frequently Asked Questions

Frequently Asked Questions

Questions & Answers

Question:

The dust sensor does not change from the orange or red colour.

Answer:

This is due to dusts built up in the dust sensor. Suck up dust accumulated in the dust sensor hole with a vacuum cleaner. [▶Page 27](#)
Normal operation is restored shortly after sucking up dust and running air purification. [▶Page 19](#)

Question:

Does the deodorizing effect of the recyclable deodorizing cartridge disappear entirely in 2 months time?

Answer:

The effect should not completely disappear in 2 months time. [▶Page 23, 24](#)
The effect may decrease by about half depending on the conditions of use.

Question:

The sensitivity of the dust sensor seems to be bad.

Answer:

This is because react time of the dust sensor differs depending on the size of room. Adjust the sensor with sensitivity settings. [▶Page 13](#)

Question:

Can the unit run without the humidifying filter?

Answer:

The unit will engage the humidify setting, but it will not humidify the room. Always install a humidifying filter. (Air can be cleaned.)

Question:

Can I wash the deodorizing catalyst unit? Is replacement necessary?

Answer:

The deodorizing catalyst unit cannot be washed. (The unit will be ruined.) Remove the deodorizing catalyst unit from the main unit and suck up dust with a vacuum cleaner. [▶Page 28](#)
It is not necessary to replace the deodorizing catalyst unit.

Question:

I threw the waterwheel (humidifying filter frame) out.

Answer:

The humidifying filter does not rotate without the waterwheel, therefore the room is not humidified in the humidify setting. To purchase another waterwheel, contact the service shop. (Separately purchased humidifying filters do not come with a waterwheel.) [▶Page 38](#)

Question:

What to do if the ionized wires are cut?

Answer:

Wires need to be replaced. Contact the service shop. Do not replace the wires yourself.

Question:

Do I need to replace the silver ion cartridge in the humidifying tray?

Answer:

The silver ion cartridge do not need replacing for 10 years.

Question:

Can I use the air purifier while the "UNIT1" or "UNIT2" lamp is lit?

Answer:

For safety reasons, power to the ionized wires and streamer unit is shut OFF, therefore dust collecting performance and deodorizing effect drop markedly. Clean inside UNIT1 and 2 until the "UNIT1" and "UNIT2" lamps go out. (There are no safety issues while the lamps are lit.)

7.4 Troubleshooting

7.4.1 Equipment does not operate, or operation lamps does not light.



Caution Be sure to turn off power switch before connect or disconnect connector, or parts damage may be occurred.

1 Models Covered	5 Troubleshooting		
MCK75JVM-K	Diagnosis	Remedy	
<h3>2 Method of Malfunction Detection</h3>	<pre> graph TD Q1{Is the power cord plugged in? Or is the breaker "ON"?} -- No --> R1[Plug in the power cord. Set the breaker to "ON".] Q1 -- Yes --> Q2{Is the panel closed tirmly?} Q2 -- No --> R2[Close the upper part of the panel firmly.] Q2 -- Yes --> Q3{Is the water supply lamp blinking?} Q3 -- Yes --> R3[Go to "7.2.2 The water supply lamp blinks"] Q3 -- No --> Q4{Do other appliances operate?} Q4 -- No --> Q5{Is there power failure?} Q5 -- Yes --> R4[Wait for power restoration.] Q5 -- No --> Q6{Is 220-240V supplied?} Q6 -- No --> R5[When unspecified voltage is applied, replace the power supply PCB. (The varistor or the fuse may be damaged.)] Q6 -- Yes --> Q7{Is rated voltage within ±10%?} Q7 -- No --> R6[Go to Check1 on P. 64. Contact power company.] Q7 -- Yes --> B1[Remove the front panel.] B1 --> Q8{Is the protrusion on the rear panel damaged?} Q8 -- Yes --> R7[Replace the front panel. *The protrusion on the front panel is broken.] Q8 -- No --> B2[Front panel switch operation check Press the front panel switch with a thin stick, then press ON/OFF switch after 5 seconds.] B2 --> Q9{Does the front panel operation lamp light?} Q9 -- Yes --> R8[Replace the front panel. (The front panel switch may not work due to deformity). Replace the power supply PCB or the operation PCB. Go to Check1 on P. 64.] Q9 -- No --> R9[Replace the power supply PCB or the operation PCB. Go to Check1 on P. 64.] </pre>		
<h3>3 Malfunction Decision conditions</h3>			
<h3>4 Supposed Causes</h3>			
<ul style="list-style-type: none"> • The unit is not turned on. • Unspecified voltage is used. • The front panel is broken. (The protrusion on the front panel is broken.) • The power supply PCB is defective. (The front panel switch is defective.) • The operation PCB is defective. 			<p>Rear side</p>

7.4.2 The water supply lamp blinks.



Caution

Be sure to turn off power switch before connect or disconnect connector, or parts damage may be occurred.

<h2>1 Models Covered</h2>	<h2>5 Troubleshooting</h2>		
<p>MCK75JVM-K</p>	<h3>Diagnosis</h3>	<h3>Remedy</h3>	
<h2>2 Method of Malfunction Detection</h2>	<pre> graph TD Q1{Is the humidifying tray removed?} -- Yes --> R1[Set the humidifying tray.] Q1 -- No --> P1[Remove the front panel and the water tank, and then remove the humidifying tray.] P1 --> Q2{Is the protrusion at left end of the humidifying tray damaged?} Q2 -- Yes --> R2[Replace the humidifying tray.] Q2 -- No --> Q3{Is the limit switch connector connected to the power supply PCB?} Q3 -- No --> R3[Connect the limit switch connector. [S115]] Q3 -- Yes --> Q4{Is the harness broken?} Q4 -- Yes --> R4[Replace the harness.] Q4 -- No --> R5[Replace the limit switch. [S2C]] </pre>		
<h2>3 Malfunction Decision conditions</h2>			
<h2>4 Supposed Causes</h2> <ul style="list-style-type: none"> • The humidifying tray is removed or not installed. • The humidifying tray is deformed or broken. • The connector is improperly connected. • The limit switch harness is broken. • The limit switch is defective. 			

7.4.3 The odor / dust sensor lamp keeps lighting red.



Caution

Be sure to turn off power switch before connect or disconnect connector, or parts damage may be occurred.

<h2>1 Models Covered</h2>	<h2>5 Troubleshooting</h2>			
<p>MCK75JVM-K</p>	<table border="1"> <thead> <tr> <th data-bbox="571 358 1222 407">Diagnosis</th> <th data-bbox="1222 358 1461 407">Remedy</th> </tr> </thead> </table>		Diagnosis	Remedy
Diagnosis	Remedy			
<h2>2 Method of Malfunction Detection</h2>	<div data-bbox="699 430 1078 459" style="text-align: center;"> <When the odor sensor is lighting red:> </div> <div data-bbox="740 465 1222 958"> <pre> graph TD A[Check humidity of the installation environment.] --> B{Is the humidity 80% or lower?} B -- No --> R1[This is not a failure. The odor sensor detects moisture in the air. • Install the unit in other place. • Reset the power supply.] B -- Yes --> C[Install the unit in another room or corridor.] C --> D{Does the lamp keep lighting red?} D -- Yes --> R2[Replace the display PCB.] D -- No --> R3[Go to Check1 on P. 64. This is not a failure. • When the room is too large or open, the sensor is always activated due to insufficient capacity.] </pre> </div> <div data-bbox="699 1137 1078 1167" style="text-align: center;"> <When the dust sensor is lighting red:> </div> <div data-bbox="740 1173 1222 1778"> <pre> graph TD E[Clean the air inlet port and the peripheral area of the dust sensor. Install the unit in another place.] --> F{Is the dust sensor lamp changed?} F -- Yes --> R4[This is not a failure.] F -- No --> G{Is the connector of the dust sensor connected?} G -- No --> R5[Connect the connector. [S1, CN2]] G -- Yes --> H{Is the harness broken?} H -- Yes --> R6[Replace the harness.] H -- No --> R7[Replace the dust sensor the operation PCB. Go to Check1 on P. 64.] </pre> </div>			
<h2>3 Malfunction Decision conditions</h2>				
<h2>4 Supposed Causes</h2> <ul style="list-style-type: none"> • Wrong diagnosis (Red lighting of the odor/dust sensor during detecting dust or moisture in the air was decided as failure.) • The sensor is defective. (The display PCB is defective.) • The dust sensor is defective. 				

7.4.4 DC fan locks.



Caution

Be sure to turn off power switch before connect or disconnect connector, or parts damage may be occurred.

<p>1 Models Covered</p>	<p>5 Troubleshooting</p>	
<p>MCK75JVM-K</p>	<p>Diagnosis</p>	<p>Remedy</p>
<p>2 Method of Mal-function Detection</p>	<div style="display: flex; justify-content: space-between;"> <div style="width: 60%;"> <pre> graph TD A[All 4 airflow rate indicators blink simultaneously.] --> B[Disconnect the power supply plug once and wait for 3 seconds. And then, reconnect the power supply plug.] B --> C[Retry to operate with the ON/OFF switch.] C --> D[Airflow rate indicators blink then go OFF.] D --> E{Is there any foreign object in the fan?} E -- Yes --> R1[Remove the foreign objects and restart operation.] E -- No --> F{Is the fan motor connector disconnected?} F -- Yes --> R2[Connect. [S102]] F -- No --> R3[Replace the fan motor.] </pre> </div> <div style="width: 35%; padding-left: 20px;"> <p>NOTE: Turn off the power before unplugging the connector. If the connector is unplugged with the unit turned on, the fan motor may be damaged. (Turn off the power before plugging in connector as well.)</p> <p>• When the indicators blink after restarting, replace the power supply PCB or the operation PCB.</p> <p>Go to Check1 on P. 64.</p> </div> </div>	
<p>Abnormality of the fan motor is detected by revolutions with the Hall IC while the fan motor is running.</p>		
<p>3 Malfunction Decision conditions</p>		
<p>When the fan motor is not revved up.</p>		
<p>4 Supposed Causes</p>		
<ul style="list-style-type: none"> • The fan motor is defective. • The power supply PCB or operation PCB is defective. • Foreign objects in the fan. • The connector is disconnected. 		

7.4.5 The odor / dust / humidity sensor lamp does not light.



Caution

Be sure to turn off power switch before connect or disconnect connector, or parts damage may be occurred.

1 Models Covered	5 Troubleshooting	
MCK75JVM-K	Diagnosis	Remedy
2 Method of Malfunction Detection	<pre> graph TD Q1{If the brightness adjustment button is pressed, is the lamp turned on?} Q2{Is the flat cable linking the display PCB and the operation PCB connected?} R1[This is not a failure.] R2[Connect the flat cable. [S129, S400]] R3[Replace the display PCB or the operation PCB. Go to Check1 on P. 64.] Q1 -- Yes --> R1 Q1 -- No --> Q2 Q2 -- No --> R2 Q2 -- Yes --> R3 </pre>	
3 Malfunction Decision conditions		
4 Supposed Causes <ul style="list-style-type: none"> • The flat cable is improperly connected. • The display PCB is defective. • The operation PCB is defective. 		

7.4.6 Humidity is not increased, or the humidity sensor lamp is not changed.



Caution Be sure to turn off power switch before connect or disconnect connector, or parts damage may be occurred.

<h2>1 Models Covered</h2>	<h2>5 Troubleshooting</h2>			
<p>MCK75JVM-K</p>	<table border="1"> <thead> <tr> <th data-bbox="569 387 1222 436">Diagnosis</th> <th data-bbox="1222 387 1461 436">Remedy</th> </tr> </thead> </table>		Diagnosis	Remedy
Diagnosis	Remedy			
<h2>2 Method of Malfunction Detection</h2>				
<h2>3 Malfunction Decision conditions</h2>				
<h2>4 Supposed Causes</h2> <ul style="list-style-type: none"> • The humidity sensor PCB is defective. • The display PCB is defective. • The operation PCB is defective. • The connector is improperly connected. • The harness is broken. 				

7.4.7 The power supply PCB or the operation PCB is at fault.



Caution

Be sure to turn off power switch before connect or disconnect connector, or parts damage may be occurred.

1 Models Covered	5 Troubleshooting			
MCK75JVM-K	<table border="1" style="width: 100%; border-collapse: collapse;"> <thead> <tr> <th style="width: 70%;">Diagnosis</th> <th style="width: 30%;">Remedy</th> </tr> </thead> </table>		Diagnosis	Remedy
Diagnosis	Remedy			
<h3>2 Method of Malfunction Detection</h3>	<pre> graph TD A[The 3 OFF timer lamps simultaneously blink.] --> B[Check the connector for connection (S108).] B --> C{Is the connector properly connected?} C -- Yes --> D[Replace the power supply PCB. Go to Check1 on P. 64.] C -- No --> E[Correct the connection.] E --> F{Do the lamps above blink again?} F -- Yes --> G[Replace the operation PCB. Go to Check1 on P. 64.] F -- No --> H[OK] </pre>			
<p>Abnormality of the zero cross from the power supply is detected.</p>				
<h3>3 Malfunction Decision conditions</h3>				
<p>When the zero cross cannot continuously be detected for about 10 seconds</p>				
<h3>4 Supposed Causes</h3>				
<ul style="list-style-type: none"> • The connector is improperly connected. • The power supply PCB is defective. • The operation PCB is defective. 				

7.5 Check

7.5.1 Checking the connection when the PCB is replaced.

Check1

Perform the following checking procedure when replacing the PCB.

(1) ■ Procedure

- ① Pressing [ON/OFF] button and [Humidify ON/OFF] button simultaneously, turn on the power. → The buzzer sounds and all lamps light.
- ② After checking the buzzer sound, press [ON/OFF] button once. → The lamps corresponding to the PCB version light.
- ③ Press [Humidify ON/OFF] button once.
- ④ Press [Fan setting] button once. → Check the sensor.
 - Normal** The buzzer sounds and all lamps light.
 - Error** Refer to the 4 lamps below.

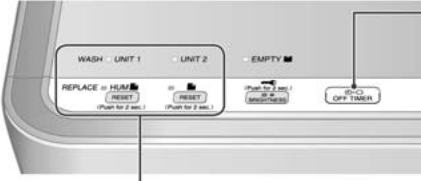

- When the unit 1 lamp blinks:
The dust sensor is at fault or improperly connected.
- When the unit 2 lamp blinks:
The odor sensor is at fault.
- When the humidifying filter lamp blinks:
The humidifying sensor is at fault or improperly connected.
- When the air-purifying filter lamp blinks:
The room temperature thermistor is at fault or improperly connected.

Use the 4 lamps for checking.

⑤ Reset the power supply to resume the normal mode.

(2) ■ Procedure (Wiring check mode)

- ① Insert the power supply plug into the outlet.
- ② Press [OFF TIMER] button within 2 seconds.
 - Normal** The buzzer sounds and all lamps light.
 - Error** (when connection is improper):
 - When the unit 1 lamp lights: The wiring of the dust correction HVU is improperly connected.
 - When the unit 2 lamp lights: The wiring of the streamer HVU is improperly connected.
 - When the unit 1 and unit 2 lamps light simultaneously: The wirings of the dust correction HVU and the streamer HVU are improperly connected.
- ③ Reset the power supply to resume the normal mode.

Warning



- Daikin Industries, Ltd.'s products are manufactured for export to numerous countries throughout the world. Daikin Industries, Ltd. does not have control over which products are exported to and used in a particular country. Prior to purchase, please therefore confirm with your local authorised importer, distributor and/or retailer whether this product conforms to the applicable standards, and is suitable for use, in the region where the product will be used. This statement does not purport to exclude, restrict or modify the application of any local legislation.

- Use only those parts and accessories supplied or specified by Daikin.

- Read the User's Manual carefully before using this product. The User's Manual provides important safety instructions and warnings. Be sure to follow these instructions and warnings.

If you have any enquiries, please contact your local importer, distributor and/or retailer.



JMI-0107



JQA-1452

About ISO 9001

ISO 9001 is a plant certification system defined by the International Organization for Standardization (ISO) relating to quality assurance. ISO 9001 certification covers quality assurance aspects related to the "design, development, manufacture, installation, and supplementary service" of products manufactured at the plant.



EC99J2044

About ISO 14001

ISO 14001 is the standard defined by the International Organization for Standardization (ISO) relating to environmental management systems. Our group has been acknowledged by an internationally accredited compliance organisation as having an appropriate programme of environmental protection procedures and activities to meet the requirements of ISO 14001.

Dealer

DAIKIN INDUSTRIES, LTD.

Head Office:
Umeda Center Bldg., 2-4-12, Nakazaki-Nishi,
Kita-ku, Osaka, 530-8323 Japan

Tokyo Office:
JR Shinagawa East Bldg., 2-18-1, Konan,
Minato-ku, Tokyo, 108-0075 Japan

http://www.daikin.com/global_ac/

©All rights reserved