



ESIE06-05



Service Manual

EWAQ080~260DAYN

EWYQ080~250DAYN

Packaged air-cooled water chillers

www.daikineurope.com

Table of Contents

1 Introduction

1.1	About This Manual	i-ii
-----	-------------------------	------

Part 1 System Outline

1 General Outline

1.1	What Is in This Chapter?	1-3
1.2	Technical Specifications: EWAQ080-260DAYN	1-5
1.3	Technical Specifications for options: EWAQ080-100DAYN	1-8
1.4	Technical Specifications for options: EWAQ130-150DAYN	1-9
1.5	Technical Specifications for options: EWAQ180-210DAYN	1-10
1.6	Technical Specifications for options: EWAQ240-260DAYN	1-11
1.7	Technical Specifications: EWYQ080-250DAYN	1-12
1.8	Technical specifications for options: EWYQ080-100DAYN	1-15
1.9	Technical specifications for options: EWYQ130-150DAYN	1-16
1.10	Technical specifications for options: EWYQ180-210DAYN	1-17
1.11	Technical Specifications for options: EWYQ230-250DAYN	1-18
1.12	Electrical Specifications: EWAQ080-260DAYN	1-19
1.13	Electrical Specifications for options: EWAQ080-100DAYN	1-20
1.14	Electrical Specifications for options: EWAQ130-150DAYN	1-21
1.15	Electrical Specifications for options: EWAQ180-210DAYN	1-22
1.16	Electrical Specifications for options: EWAQ240-260DAYN	1-23
1.17	Electrical Specifications: EWYQ080-260DAYN	1-24
1.18	Electrical Specifications for options: EWYQ080-100DAYN	1-26
1.19	Electrical Specifications for options: EWYQ130-150DAYN	1-27
1.20	Electrical Specifications for options: EWYQ180-210DAYN	1-28
1.21	Electrical Specifications for options: EWYQ230-250DAYN	1-29
1.22	Correction Factors for Glycol	1-30
1.23	Optional equipment for EWAQ-DAYN (N-P-B)	1-32
1.24	Optional equipment for EWYQ-DAYN (N-P-B)	1-33
1.25	Outlook Drawing: EWAQ080-100DAYN(N)	1-34
1.26	Outlook Drawing: EWAQ080-100DAYN(P-B)	1-36
1.27	Outlook Drawing: EWAQ130-150DAYN(N)	1-38
1.28	Outlook Drawing: EWAQ130-150DAYN(P-B)	1-40
1.29	Outlook Drawing: EWAQ180-210DAYN(N)	1-42
1.30	Outlook Drawing: EWAQ180-210DAYN(P-B)	1-44
1.31	Outlook Drawing: EWAQ240-260DAYN(N)	1-46
1.32	Outlook Drawing: EWAQ240-260DAYN(P-B)	1-48
1.33	Outlook Drawing: EWYQ080-100DAYN(N)	1-50
1.34	Outlook Drawing: EWYQ080-100DAYN(P-B)	1-52
1.35	Outlook Drawing: EWYQ130-150DAYN(N)	1-54
1.36	Outlook Drawing: EWYQ130-150DAYN(P-B)	1-56
1.37	Outlook Drawing: EWYQ180-210DAYN(N)	1-58
1.38	Outlook Drawing: EWYQ180-210DAYN(P-B)	1-60
1.39	Outlook Drawing: EWYQ230-250DAYN(N)	1-62
1.40	Outlook Drawing: EWYQ230-250DAYN(P-B)	1-64

2 Piping Layout

2.1	What Is in This Chapter?	1-67
2.2	Functional Diagram Refrigeration Circuit: EWAQ080-100DAYN(N-P-B).....	1-68
2.3	Functional Diagram Refrigeration Circuit: EWAQ130-210DAYN(N-P-B).....	1-70
2.4	Functional Diagram Refrigeration Circuit: EWAQ240-260DAYN(N-P-B).....	1-72
2.5	Components Refrigeration Side : EWAQ080-260DAYN.....	1-74
2.6	Functional Diagram Refrigeration Circuit: EWYQ080-100DAYN(N-P-B).....	1-76
2.7	Functional Diagram Refrigeration Circuit: EWYQ130-210DAYN(N-P-B).....	1-78
2.8	Functional Diagram Refrigeration Circuit: EWYQ230-250DAYN(N-P-B).....	1-80
2.9	Components refrigeration side: EWYQ080-250DAYN.....	1-82
2.10	Functional Diagram Water Piping: EWAQ-EWYQ-DAYN(N-P-B).....	1-84
2.11	Components Water Side : EWAQ- EWYQ- DAYN(N-P-B)	1-85

3 Wiring Layout

3.1	What Is in This Chapter?	1-87
3.2	Wiring Layout : EWAQ080-100DAYN(N-P-B) and EWYQ080-100DAYN(N-P-B) Standard Unit.....	1-88
3.3	Wiring Layout : EWAQ130-260DAYN(N-P-B) and EWYQ130-250DAYN(N-P-B) Standard Unit.....	1-116
3.4	Wiring layout: EWAQ080-100DAYN(N-P-B) and EWYQ080-100DAYN(N-P-B) with OPIF	1-149
3.5	Wiring Layout : EWAQ130-260DAYN(N-P-B) and EWYQ130-250DAYN(N-P-B) with OPIF	1-177

Part 2 Functional Description

1 Operation Range

1.1	What Is in This Chapter?	2-3
1.2	Operational Range: EWAQ080-100-180-210-240-260DAYN(N-P-B).....	2-4
1.3	Operational Range: EWAQ130-150DAYN(N-P-B)	2-5
1.4	Operational Range: EWYQ080-100-180-210-230-250DAYN(N-P-B).....	2-6
1.5	Operational Range: EWYQ130-150DAYN(N-P-B)	2-7

2 The Digital Controller For Multiscroll Chillers

2.1	What Is In This Chapter?	2-9
2.2	The Controller	2-10
2.3	Start/Stop, Cool/Heat and Temperature settings	2-12
2.4	Menu Overview	2-13
2.5	How to Read or Adjust Parameter Settings: the Programming Procedure	2-14
2.6	Read-out Menu	2-15
2.7	Set Points Menu.....	2-25
2.8	User Settings	2-26
2.9	Timers menu	2-43
2.10	Info menu	2-45
2.11	Input/Output Status Menu	2-48
2.12	User Password Menu.....	2-56
2.13	Network Menu	2-58
2.14	Cool / Heat Menu	2-60
2.15	Service Menu	2-61
2.16	Menu overview	2-102
2.17	Service menu overview	2-103

3 Functional Control for a Standalone Unit

3.1	What Is in This Chapter?	2-105
3.2	Operation Flowchart.....	2-106
3.3	On/Off Management	2-107
3.4	Thermostat Control	2-108
3.5	Manual Control.....	2-114
3.6	Compressor Control.....	2-115
3.7	Fan Control	2-119
3.8	Pump Control	2-128
3.9	Floating Setpoint	2-129
3.10	Free Cooling	2-133
3.11	Superheat control.....	2-137
3.12	Changeable digital inputs.....	2-140
3.13	Changeable digital outputs	2-141
3.14	Changeable analogue inputs	2-142
3.15	Changeable analogue outputs	2-143
3.16	DICN Basic Setup (=master/slave system).....	2-144
3.17	BMS Function	2-153
3.18	Freeze-up Control	2-157
3.19	Discharge gas safety	2-163
3.20	Password Function	2-164
3.21	History logging	2-165
3.22	Defrost management	2-166
3.23	Reversing valve	2-171
3.24	Low pressure bypass	2-172
3.25	Simulation	2-173

Part 3 Troubleshooting

1 Overview of Fault Indications and Safeties

1.1	What Is in This Chapter?	3-3
1.2	What happens in the Event of an Alarm?	3-4
1.3	What to do in the Event of an Alarm?	3-5
1.4	Overview of Unit Safeties	3-6
1.5	Overview of Circuit Safeties.....	3-11
1.6	Overview of Network Safeties.....	3-19
1.7	Overview of Warnings.....	3-21
1.8	Overview of Start Problems	3-23

2 Checking the Temperature Sensors

2.1	Temperature and resistance characteristics of thermistor type 1	3-27
2.2	Temperature and resistance characteristics of thermistor type 2	3-28
2.3	Temperature and Resistance characteristics of Thermistor Type 3	3-29
2.4	Temperature and resistance characteristics of thermistor type 4.	3-30

3 Reset procedure

3.1	Introduction	3-31
3.2	Login/Logout	3-32

4 Procedure for Software Upload

4.1	What is in this chapter	3-33
4.2	Overview hardware software/Source files.....	3-34
4.3	Software upload procedure: PCASOfash	3-35
4.4	Installation of PCASOfash Software	3-40
4.5	Overview of most common problems.....	3-41

5 Procedure for main PCB changing

5.1	Changing the main PCB	3-43
5.2	Configuration of Main PCB nr 1	3-44
5.3	Configuration of Main PCB nr 2	3-45

6 Procedure for extension PCB changing

6.1	Changing the extension PCB.....	3-47
6.2	Configuration of the extension PCB.....	3-47

7 Procedure for controller changing

7.1	Changing the Main Controller.....	3-49
7.2	Configuration of the Main Controller.....	3-49
7.3	Configuration of the Sub Controller.....	3-49

8 Procedure for EEV PCB changing

8.1	Changing the EEV PCB.....	3-51
8.2	Configuration of EEV PVB.....	3-51

9 Procedure for compressor replacement : Suction washer

9.1	Introduction.....	3-53
9.2	Use of Suction Washer.....	3-53

10 Procedure for Compressor Oil Fill or Oil Drain

10.1	Introduction.....	3-55
10.2	Compressor connections.....	3-55

11 Compressor electrical connections and wiring

11.1	Electrical connections for SJ161.....	3-57
11.2	Electrical connections SJ180.....	3-57
11.3	Electronic protection module wiring.....	3-57
11.4	Electrical connections for SJ240-300.....	3-58
11.5	Electronic protection module wiring.....	3-58

12 Procedure to Clear the Refrigerant Circuit in Case of Frozen

Evaporators

Part 4 Commissioning and Test Run

1 Pre-Test Run Checks

1.1	What Is in This Chapter?	4-3
1.2	General Checks	4-5
1.3	Water Piping Checks	4-6
1.4	Water Pressure Drop through Evaporator: EWAQ080-100DAYN (N-P-B)	4-11
1.5	Water Pressure Drop through Evaporator: EWAQ130-210DAYN(N-P-B)	4-12
1.6	Water Pressure Drop through Evaporator: EWAQ240-260DAYN (N-P-B)	4-13
1.7	Water Pressure Drop through Evaporator: EWYQ080-100DAYN (N-P-B)	4-14
1.8	Water Pressure Drop through Evaporator: EWYQ130-210DAYN(N-P-B)	4-15
1.9	Water Pressure Drop through Evaporator: EWYQ230-250DAYN(N-P-B)	4-16
1.10	Unit pressure drop : EWAQ080-100DAYNN Standard Model	4-17
1.11	Unit pressure drop : EWAQ130-210DAYNN Standard Model	4-19
1.12	Unit pressure drop : EWAQ240-260DAYNN Standard Model	4-21
1.13	Unit pressure drop : EWYQ080-100DAYNN Standard Unit.....	4-23
1.14	Unit pressure drop : EWYQ130-210DAYNN Standard Unit.....	4-25
1.15	Unit pressure drop : EWYQ230-250DAYNN Standard Unit.....	4-27
1.16	External Static Unit Pressure: EWAQ080-100 DAYN (P-B)	4-29
1.17	External Static Unit Pressure: EWAQ130-210 DAYN (P-B)	4-31
1.18	External Static Unit Pressure: EWAQ240-260DAYN (P-B)	4-32
1.19	External Static Unit Pressure: EWYQ080-100DAYN (P-B)	4-34
1.20	External Static Unit Pressure: EWYQ130-210DAYN (P-B)	4-35
1.21	External Static Unit Pressure: EWYQ230-250DAYN (P-B)	4-36
1.22	External Static Unit Pressure: EWAQ080-100DAYN (OPHP)	4-37
1.23	External Static Unit Pressure: EWAQ130-210DAYN (OPHP)	4-39
1.24	External Static Unit Pressure: EWAQ240-260DAYN (OPHP)	4-40
1.25	External Static Unit Pressure: EWYQ080-100DAYN (OPHP)	4-41
1.26	External Static Unit Pressure: EWYQ130-210DAYN (OPHP)	4-43
1.27	External Static Unit Pressure: EWYQ230-250DAYN (OPHP)	4-45
1.28	Electrical Checks	4-46
1.29	Field wiring connection diagram : EWAQ/EWYQ 080-260 DAYN*	4-47

Part 5 Maintenance

1 Maintenance

1.1	What Is in This Chapter	5-3
1.2	Maintenance of the Main Parts	5-4
1.3	Maintenance of the Control Devices	5-6
1.4	Periodical Checks	5-7

Part 6 Appendix

1 Appendix

1.1	What Is in This Chapter	6-3
1.2	History of the Software.....	6-4

1 Introduction

1.1 About This Manual

Target group	This service manual is intended for and should only be used by qualified engineers.
Purpose of this manual	This service manual contains all the information you need to carry out the necessary repair and maintenance tasks for the EWAQ 080~260 DAYN and EWYQ 080~250 DAYN.
EWAQ 080~ 260 DAYN	<p>The Daikin EWAQ 080~260 DAYN packaged air-cooled water chillers:</p> <ul style="list-style-type: none"> ■ Are designed for outdoor installation. ■ Are used for cooling applications. ■ Used refrigerant R410a. ■ Are available in 8 standard sizes with nominal cooling capacities ranging from 80 kW to 254 kW. ■ Have 3 types of units: <p>EWAQ 080~260 DAYNN: without hydraulic module, naked model</p> <p>EWAQ 080~260 DAYNP: with hydraulic module: pump and expansion vessel</p> <p>EWAQ 080~260 DAYNB: with hydraulic module: buffer tank, pump and expansion vessel</p>
EWYQ 080~250 DAYN	<p>The Daikin EWYQ 080~250DAYN packaged air-cooled water chillers:</p> <ul style="list-style-type: none"> ■ Are designed for outdoor installation. ■ Are used for cooling and heating applications ■ Used refrigerant R410a. ■ Are available in 8 standard sizes with nominal cooling capacities ranging from 77kW to 252kW and heating from 87,7 kW to 284kW. ■ Have 3 types of units: <p>EWAQ 080~250 DAYNN: without hydraulic module, naked model</p> <p>EWAQ 080~250 DAYNP: with hydraulic module: pump and expansion vessel</p> <p>EWAQ 080~250 DAYNB: with hydraulic module: buffer tank, pump and expansion vessel</p>
Before starting up the unit	Before starting up the unit for the first time, make sure it has been properly installed.

Part 1

System Outline

Introduction

This part contains an outline of all the relevant elements in the EWAQ 080~260DAYN and EWYQ 080~250 DAYN installation.

What is in this part?

This part contains the following chapters:

Chapter	See page
1-General Outline	1-3
2-Piping Layout	1-67
3-Wiring Layout	1-87

1 General Outline

1.1 What Is in This Chapter?

Introduction

This chapter contains the following information:

- Technical specifications
- Electrical specifications
- Outlook drawings: Outlook, dimensions, installation and service space.

Overview

This chapter contains the following topics:

Topic	See page
1.2–Technical Specifications: EWAQ080-260DAYN	1–5
1.3–Technical Specifications for options: EWAQ080-100DAYN	1–8
1.4–Technical Specifications for options: EWAQ130-150DAYN	1–9
1.5–Technical Specifications for options: EWAQ180-210DAYN	1–10
1.6–Technical Specifications for options: EWAQ240-260DAYN	1–11
1.7–Technical Specifications: EWYQ080-250DAYN	1–12
1.8–Technical specifications for options: EWYQ080-100DAYN	1–15
1.9–Technical specifications for options: EWYQ130-150DAYN	1–16
1.10–Technical specifications for options: EWYQ180-210DAYN	1–17
1.11–Technical Specifications for options: EWYQ230-250DAYN	1–18
1.12–Electrical Specifications: EWAQ080-260DAYN	1–19
1.13–Electrical Specifications for options: EWAQ080-100DAYN	1–20
1.14–Electrical Specifications for options: EWAQ130-150DAYN	1–21
1.15–Electrical Specifications for options: EWAQ180-210DAYN	1–22
1.16–Electrical Specifications for options: EWAQ240-260DAYN	1–23
1.17–Electrical Specifications: EWYQ080-260DAYN	1–24
1.18–Electrical Specifications for options: EWYQ080-100DAYN	1–26
1.19–Electrical Specifications for options: EWYQ130-150DAYN	1–27
1.20–Electrical Specifications for options: EWYQ180-210DAYN	1–28
1.21–Electrical Specifications for options: EWYQ230-250DAYN	1–29
1.22–Correction Factors for Glycol	1–30
1.23–Optional equipment for EWAQ-DAYN (N-P-B)	1–32
1.24–Optional equipment for EWYQ-DAYN (N-P-B)	1–33
1.25–Outlook Drawing: EWAQ080-100DAYN(N)	1–34
1.26–Outlook Drawing: EWAQ080-100DAYN(P-B)	1–36
1.27–Outlook Drawing: EWAQ130-150DAYN(N)	1–38
1.28–Outlook Drawing: EWAQ130-150DAYN(P-B)	1–40

Topic	See page
1.29–Outlook Drawing: EWAQ180-210DAYN(N)	1–42
1.30–Outlook Drawing: EWAQ180-210DAYN(P-B)	1–44
1.31–Outlook Drawing: EWAQ240-260DAYN(N)	1–46
1.32–Outlook Drawing: EWAQ240-260DAYN(P-B)	1–48
1.33–Outlook Drawing: EWYQ080-100DAYN(N)	1–50
1.34–Outlook Drawing: EWYQ080-100DAYN(P-B)	1–52
1.35–Outlook Drawing: EWYQ130-150DAYN(N)	1–54
1.36–Outlook Drawing: EWYQ130-150DAYN(P-B)	1–56
1.37–Outlook Drawing: EWYQ180-210DAYN(N)	1–58
1.38–Outlook Drawing: EWYQ180-210DAYN(P-B)	1–60
1.39–Outlook Drawing: EWYQ230-250DAYN(N)	1–62
1.40–Outlook Drawing: EWYQ230-250DAYN(P-B)	1–64

1.2 Technical Specifications: EWAQ080-260DAYN

Technical specifications

The table below contains the technical specifications.

				EWAQ080DA YN	EWAQ100DA YN	EWAQ130DA YN	EWAQ150DA YN	EWAQ180DA YN	EWAQ210DAY N	EWAQ240DA YN	EWAQ260DA YN	
Capacity (Eurovent conditions specified in notes)	Cooling	Nominal	kW	80	105	131	152	182	209	236	254	
Capacity Steps			%	0-50-100	0-50-100	0-25 50-75-100	0-25 50-75-100	21/29-43/50/ 57-71/79-100	0-25 50-75-100	22/28-40/50/ 56-72/78-100	0-25 50-75-100	
Nominal input (Eurovent conditions specified in notes)	Cooling		kW	26.4	36.2	46.6	56.3	64.5	74.6	82.2	94.0	
EER				3.03	2.90	2.81	2.70	2.82	2.80	2.80	2.70	
ESEER				4.12	4.00	4.34	4.22	4.36	4.32	4.20	4.00	
Casing	Colour			Ivory white								
	Material			Polyester painted galvanised steel plate/Munsell code 5Y7.5/1								
Dimensions	Unit	Height	mm	2311	2311	2311	2311	2311	2311	2311	2311	
		Width	mm	2000	2000	2000	2000	2000	2000	2000	2000	
		Depth	mm	2566	2566	2631	2631	3081	3081	4850	4850	
Weight	Unit		kg	1350	1400	1500	1550	1800	1850	3150	3250	
	Operating weight		kg	1315	1415	1517	1569	1825	1877	3189	3292	
	Gross weight		kg	1400	1450	1550	1600	1850	1900	3200	3300	
Water Heat Exchanger	Type			Brased plate								
	Filter	Type			STRAINER GALVANIZED							
		Diameter perforations	mm		1	1	1	1	1	1	1	1
	Minimum water volume in the system			l	358	470	295	341	408	468	529	569
	Water flow rate	Min	l/min		115	151	188	218	261	300	339	364
		Max	l/min		459	602	754	871	1043	1198	1355	1456
Nominal Water Flow	Cooling	l/min		229	301	377	436	522	599	677	728	
Nominal Water Flow	Cooling	Total	kPa	59	58	52	49	52	53	51	47	
Water Heat Exchanger	Insulation material			Foamed synthetic elastomer								
	Model	Quantity			1	1	1	1	1	1	1	1
		Model			PT120	PT120	DV47	DV47	DV58	DV58	DV58	DV58

1

				EWAQ080DA YN	EWAQ100DA YN	EWAQ130DA YN	EWAQ150DA YN	EWAQ180DA YN	EWAQ210DAY N	EWAQ240DA YN	EWAQ260DA YN
Air Heat Exchanger	Type		Cross fin coil / Hi-Xss tubes and PE coated								
	Rows		2	2	3	3	3	3	3	3	3
	Stages		56	56	48	56	56	56	56	48	48
	Fin Pitch	mm	1.8	1.8	1.8	1.8	1.8	1.8	1.8	1.8	1.8
	Face Area	m2	2.46	2.46	2.11	2.46	3.02	3.02	3.02	2.11	2.11
	No. of Coils		4	4	4	4	4	4	4	8	8
Hydraulic Components	Unit water volume	l	15	15	17	19	25	27	39	42	
	Nominal water pressure drop unit	kPa	66	67	64	63	72	79	83	85	
Fan	Drive		Direct drive								
	Nominal air flow	m3/min	780	780	800	860	1290	1290	1600	1600	
	Model	Quantity		4	4	4	4	6	6	8	8
		Speed	rpm	880	880	900	970	970	970	900	900
	Motor Output	W	500	500	600	1000	1000	1000	600	600	
	Discharge direction		Vertical								
Compressor	Type		Scroll compressor								
	Refrigerant oil type		Daphne FVC68D								
	Refrigerant oil charge	l	6.7	6.7	3.3	6.7	6.7	6.7	6.7	6.7	
	Model	Quantity		2	2	4	4	2	4	2	4
		Model		SJ180	SJ240	SJ161	SJ180	SJ180	SJ240	SJ240	SJ300
	Speed	rpm	2900	2900	2900	2900	2900	2900	2900	2900	
	Quantity						2		2		
	Model						SJ240		SJ300		
Speed	rpm					2900		2900			
Sound Level	Sound Power	Cooling	dBA	86	86	88	89	90	91	91	91
Refrigerant circuit	Refrigerant type		R-410A								
	Refrigerant charge	kg	33	33	19	25	29	28	39	39	
		kg			19	25			39	39	
	No of circuits		1	1	2	2	2	2	2	2	
	Refrigerant control		Electronic expansion valve								
Piping connections	Water heat exchanger inlet / outlet		3" OD	3" OD	3" OD	3" OD	3" OD	3" OD	3"	3"	
	Water heat exchanger drain		1/2" G								

	EWAQ080DA YN	EWAQ100DA YN	EWAQ130DA YN	EWAQ150DA YN	EWAQ180DA YN	EWAQ210DAY N	EWAQ240DA YN	EWAQ260DA YN
Safety Devices	High pressure switch		High pressure (pressure switch)					
	Pressure relief valve							
	Low pressure protection						Low pressure safety	
	Freeze up protection							
	Flowswitch							
	Discharge temperature control							
	Reverse phase protector							
	Electronic protection module compressors (only for SJ180 SJ240)		Electronic protection module compressors (only for SJ180)		Electronic protection module compressors (only for SJ180 SJ240)		Electronic protection module compressors	
	Overcurrent relays for compressors and fans							
Notes	Nominal cooling capacity at Eurovent conditions: Evaporator 12xC/7xC; ambient 35xC							
	Nominal cooling capacity at Eurovent conditions: Evaporator 12xC/7xC; ambient 35xC (= Power input compressors + fans + electrical circuit)							
	Minimum required watervolume for standard thermostat settings and at nominal conditions							

1.3 Technical Specifications for options: EWAQ080-100DAYN

Technical specifications

The table below contains the technical specifications for the options of the EWAQ080-100 DAYN.

Technical specifications options				
OPSP				
Units			EWAQ080DAYN*	EWAQ100DAYN*
Weight	Additional machine weight	kg	250	250
	Additional operation weight	kg	283	283
	Additional gross weight	kg	250	250
Pump	Type		Single-stage-in-line-pumps	Single-stage-in-line-pumps
	Quantity		1	1
	Model		TP50-240/2	TP50-240/2
	Nominal Static Height Unit	kPa	142	133
Hydraulic components	Additional unit water volume	l	33	33
	Expansion vessel	l	35	
	Pre-charge pressure exp. vessel	bar	1,5	
	Safety valve	bar	3	
OPSB + OPBT				
Units			EWAQ080DAYN*	EWAQ100DAYN*
Weight	Additional machine weight	kg	300	300
	Additional operation weight	kg	523	523
	Additional gross weight	kg	300	300
Pump	Type		Single-stage-in-line-pumps	Single-stage-in-line-pumps
	Quantity		1	1
	Model		TP50-240/2	TP50-240/2
	Nominal Static Height Unit	kPa	142	133
Hydraulic components	Buffer tank	l	190	190
	Additional unit water volume	l	223	223
	Expansion vessel	l	35	
	Pre-charge pressure exp. vessel	bar	1,5	
	Safety valve	bar	3	
OPHP				
Units			EWAQ080DAYN*	EWAQ100DAYN*
Pump	Type		Single-stage-in-line-pumps	Single-stage-in-line-pumps
	Quantity		1	1
	Model		TP50-240/2	TP50-240/2
	Nominal Static Height Unit	kPa	337	322

1.4 Technical Specifications for options: EWAQ130-150DAYN

Technical specifications

The table below contains the technical specifications for the options of the EWAQ130-150DAYN.

Technical specifications options				
OPSP				
Units			EWAQ130DAYN*	EWAQ150DAYN*
Weight	Additional machine weight	kg	250	250
	Additional operation weight	kg	286	286
	Additional gross weight	kg	250	250
Pump	Type		Single-stage-in-line-pumps	Single-stage-in-line-pumps
	Quantity		1	1
	Model		TP65-230/2	TP65-230/2
	Nominal Static Height Unit	kPa	134	126
Hydraulic components	Additional unit water volume	l	36	36
	Expansion vessel	l	35	
	Pre-charge pressure exp. vessel	bar	1,5	
	Safety valve	bar	3	
OPSP + OPBT				
Units			EWAQ130DAYN*	EWAQ150DAYN*
Weight	Additional machine weight	kg	300	300
	Additional operation weight	kg	526	526
	Additional gross weight	kg	300	300
Pump	Type		Single-stage-in-line-pumps	Single-stage-in-line-pumps
	Quantity		1	1
	Model		TP65-230/2	TP65-230/2
	Nominal Static Height Unit	kPa	134	126
Hydraulic components	Buffer tank	l	190	190
	Additional unit water volume	l	226	226
	Expansion vessel	l	35	
	Pre-charge pressure exp. vessel	bar	1,5	
	Safety valve	bar	3	
OPHP				
Units			EWAQ130DAYN*	EWAQ150DAYN*
Pump	Type		Single-stage-in-line-pumps	Single-stage-in-line-pumps
	Quantity		1	1
	Model		TP65-340/2	TP65-340/2
	Nominal Static Height Unit	kPa	253	248

1

1.5 Technical Specifications for options: EWAQ180-210DAYN

Technical specifications

The table below contains the technical specifications for the options of the EWAQ180-210DAYN.

Technical specifications options				
OPSP				
Units			EWAQ180DAYN*	EWAQ210DAYN*
Weight	Additional machine weight	kg	250	250
	Additional operation weight	kg	286	286
	Additional gross weight	kg	250	250
Pump	Type		Single-stage-in-line-pumps	Single-stage-in-line-pumps
	Quantity		1	1
	Model		TP65-260/2	TP65-260/2
	Nominal Static Height Unit	kPa	142	120
Hydraulic components	Additional unit water volume	l	36	36
	Expansion vessel	l	35	
	Pre-charge pressure exp. vessel	bar	1,5	
	Safety valve	bar	3	
OPSP + OPBT				
Units			EWAQ180DAYN*	EWAQ210DAYN*
Weight	Additional machine weight	kg	300	300
	Additional operation weight	kg	526	526
	Additional gross weight	kg	300	300
Pump	Type		Single-stage-in-line-pumps	Single-stage-in-line-pumps
	Quantity		1	1
	Model		TP65-260/2	TP65-260/2
	Nominal Static Height Unit	kPa	142	120
Hydraulic components	Buffer tank	l	190	190
	Additional unit water volume	l	226	226
	Expansion vessel	l	35	
	Pre-charge pressure exp. vessel	bar	1,5	
	Safety valve	bar	3	
OPHP				
Units			EWAQ180DAYN*	EWAQ210DAYN*
Pump	Type		Single-stage-in-line-pumps	Single-stage-in-line-pumps
	Quantity		1	1
	Model		TP65-410/2	TP65-410/2
	Nominal Static Height Unit	kPa	296	278

1.6 Technical Specifications for options: EWAQ240-260DAYN

Technical specifications

The table below contains the technical specifications for the options of the EWAQ240-260DAYN.

Technical specifications options				
OPSP				
Units			EWAQ240DAYN*	EWAQ260DAYN*
Weight	Additional machine weight	kg	250	250
	Additional operation weight	kg	271	271
	Additional gross weight	kg	250	250
Pump	Type		Single-stage-in-line-pumps	Single-stage-in-line-pumps
	Quantity		1	1
	Model		TP65-260/2	TP65-260/2
	Nominal Static Height Unit Cooling	kPa	119	110
Hydraulic components	Additional unit water volume	l	21	21
	Expansion vessel	l	50	
	Pre-charge pressure exp. vessel	bar	1,5	
	Safety valve	bar	3	
OPSP + OPBT				
Units			EWAQ240DAYN*	EWAQ260DAYN*
Weight	Additional machine weight	kg	300	300
	Additional operation weight	kg	511	511
	Additional gross weight	kg	300	300
Pump	Type		Single-stage-in-line-pumps	Single-stage-in-line-pumps
	Quantity		1	1
	Model		TP65-260/2	TP65-260/2
	Nominal Static Height Unit Cooling	kPa	126	117
Hydraulic components	Buffer tank	l	190	190
	Additional unit water volume	l	211	211
	Expansion vessel	l	50	
	Pre-charge pressure exp. vessel	bar	1,5	
	Safety valve	bar	3	
OPHP				
Units			EWAQ240DAYN*	EWAQ260DAYN*
Pump	Type		Single-stage-in-line-pumps	Single-stage-in-line-pumps
	Quantity		1	1
	Model		TP65-410/2	TP65-410/2
	Nominal Static Height Unit Cooling	kPa	321	276

1.7 Technical Specifications: EWYQ080-250DAYN

Technical Specifications

The table below contains the technical specifications.

2-1 TECHNICAL SPECIFICATIONS				EWYQ080 DAYN	EWYQ100D AYN	EWYQ130DA YN	EWYQ150D AYN	EWYQ180DA YN	EWYQ210D AYN	EWYQ230DA YN	EWYQ250D AYN	
Capacity (Eurovent conditions specified in notes)	Cooling	Nominal	kW	77	100	136	145	183	211	234	252	
	Heating	Nominal	kW	87.7	114	149	165	199	225	258	284	
Capacity Steps			%	0-50-100	0-50-100	0-25 50-75-100	0-25 50-75-100	21/29-43/50 /57-71/79-100	0-25 50-75-100	22/28-40/50 /56-72/78-100	0-25 50-75-100	
Nominal input (Eurovent conditions specified in notes)	Cooling		kW	26.5	36.2	47.6	55.7	63.8	75.3	82.2	94.0	
	Heating		kW	30.0	38.1	49.6	58.8	68.0	77.0	86.9	97.9	
EER				2.91	2.76	2.86	2.60	2.87	2.80	2.85	2.68	
COP (Eurovent conditions specified in notes)				2.92	2.99	3.00	2.81	2.93	2.92	2.97	2.90	
ESEER				4.00	4.00	4.20	4.20	4.20	4.20	4.20	4.20	
Casing	Colour			Ivory white								
	Material			Polyester painted galvanised steel plate								
Dimensions	Unit	Height	mm	2311	2311	2311	2311	2311	2311	2311	2311	
		Width	mm	2000	2000	2000	2000	2000	2000	2000	2000	
		Depth	mm	2566	2566	2631	2631	3081	3081	4850	4850	
Weight	Unit		kg	1400	1450	1550	1600	1850	1900	3200	3300	
	Operating weight		kg	1415	1465	1567	1619	1875	1927	3239	3342	
	Gross weight		kg	1450	1500	1600	1650	1900	1950	3250	3350	
Water Heat Exchanger	Type			Brased plate								
	Filter	Type			STRAINER GALVANIZED							
		Diameter perforations	mm	1	1	1	1	1	1	1	1	
	Minimum water volume in the system			l	393	511	334	370	446	504	560	616
	Water flow rate	Min	l/min	110	143	195	208	262	302	330	358	
		Max	l/min	503	654	854	946	1141	1290	1433	1571	
Nominal Water Flow	Cooling	l/min	221	287	390	416	525	605	659	717		
	Heating	l/min	251	327	427	473	570	645	717	786		
Nominal Water Flow	Cooling	Total	kPa	36	36	43	38	41	44	38	37	
Water Heat Exchanger	Insulation material			Foamed synthetic elastomer								
	Model	Quantity		1	1	1	1	1	1	1	1	
		Model		PT120	PT120	DV47HP	DV47HP	DV58HP	DV58HP	DV58HP	DV58HP	

2-1 TECHNICAL SPECIFICATIONS			EWYQ080 DAYN	EWYQ100D AYN	EWYQ130DA YN	EWYQ150D AYN	EWYQ180DA YN	EWYQ210D AYN	EWYQ230DA YN	EWYQ250D AYN
Air Heat Exchanger	Type		Cross fin coil / Hi-Xss tubes and PE coated							
	Rows		2	2	3	3	3	3	3	3
	Stages		56	56	48	56	56	56	48	48
	Fin Pitch	mm	1.8	1.8	1.8	1.8	1.8	1.8	1.8	1.8
	Face Area	m2	2.46	2.46	2.11	2.46	3.02	3.02	2.11	2.11
No. of Coils		4	4	4	4	4	4	4	8	8
Hydraulic Components	Unit water volume	l	15	15	17	19	25	27	39	42
	Nominal water pressure drop unit	kPa	42	43	55	51	61	70	68	74
Fan	Drive		Direct drive							
	Nominal air flow	m3/m in	780	780	800	860	1290	1290	1600	1600
	Model	Quantity	4	4	4	4	6	6	8	8
		Speed	rpm	880	880	900	970	970	970	900
	Motor Output	W	500	500	600	1000	1000	1000	600	600
Discharge direction		Vertical								
Compressor	Type		Scroll compressor							
	Refrigerant oil type		Daphne FVC68D							
	Refrigerant oil charge	l	6.7	6.7	3.3	6.2	6.2	6.2	6.2	6.2
	Model	Quantity	2	2	4	4	2	4	2	4
		Model	SJ180	SJ240	SJ161	SJ180	SJ180	SJ240	SJ240	SJ300
	Speed	rpm	2900	2900	2900	2900	2900	2900	2900	2900
	Quantity						2		2	
Model						SJ240		SJ300		
Speed	rpm					2900		2900		
Sound Level	Sound Power	Cooling	dBa	86	86	88	89	90	91	93
Refrigerant circuit	Refrigerant type		R-410A							
	Refrigerant charge	kg	33	37	22	22	32	32	39	39
		kg			22	22	32	32	39	39
	No of circuits		1	1	2	2	2	2	2	2
Refrigerant control		Electronic expansion valve								
Piping connections	Water heat exchanger inlet / outlet		3" OD	3" OD	3" OD	3" OD	3" OD	3" OD	3"	3"
	Water heat exchanger drain		1/2" G							

1

2-1 TECHNICAL SPECIFICATIONS	EWYQ080 DAYN	EWYQ100D AYN	EWYQ130DA YN	EWYQ150D AYN	EWYQ180DA YN	EWYQ210D AYN	EWYQ230DA YN	EWYQ250D AYN
Safety Devices	High pressure (pressure switch)							
	Pressure relief valve							
	Low pressure safety	Low pressure safety	Low pressure safety	Low pressure safety	Low pressure protection	Low pressure protection	Low pressure safety	Low pressure safety
	Freeze up protection							
	Flowswitch							
	Discharge temperature control							
	Reverse phase protector							
	Electronic protection module compressors	Electronic protection module compressors	Electronic protection module compressors (only for SJ180 SJ240)	Electronic protection module compressors (only for SJ180 SJ240)	Electronic protection module compressors (only for SJ180 SJ240)	Electronic protection module compressors (only for SJ180 SJ240)	Electronic protection module compressors	Electronic protection module compressors
Overcurrent relays for compressors and fans								
Notes	Nominal cooling capacity at Eurovent conditions: Evaporator 12xC/7xC; ambient 35xC							
	Nominal cooling capacity at Eurovent conditions: Evaporator 12xC/7xC; ambient 35xC (= Power input compressors + fans + electrical circuit)							
	Minimum required watervolume for standard thermostat settings and at nominal conditions							
	Nominal heating capacity at Eurovent conditions: Evaporator 40xC/45xC, ambient: drybulb 7xC, wetbulb 6xC							
	Nominal heating power input at Eurovent conditions: Evaporator 40xC/45xC, ambient: drybulb 7xC, wetbulb 6xC (=Power input compressors+fans+electrical circuit)							

1.8 Technical specifications for options: EWYQ080-100DAYN

Technical specifications

The table below contains the technical specifications for the options of the EWYQ080-100DAYN.

Technical specifications options				
OPSP				
Units			EWYQ080DAYN*	EWYQ100DAYN*
Weight	Additional machine weight	kg	250	250
	Additional operation weight	kg	268	268
	Additional gross weight	kg	250	250
Pump	Type		Single-stage-in-line-pumps	Single-stage-in-line-pumps
	Quantity		1	1
	Model		TP50-240/2	TP50-240/2
	Nominal Static Height Unit cooling	kPa	173	154
Hydraulic components	Additional unit water volume	l	18	18
	Expansion vessel	l	35	
	Pre-charge pressure exp. vessel	bar	1,5	
	Safety valve	bar	3	
OPSP + OPBT				
Units			EWYQ080DAYN*	EWYQ100DAYN*
Weight	Additional machine weight	kg	300	300
	Additional operation weight	kg	508	508
	Additional gross weight	kg	300	300
Pump	Type		Single-stage-in-line-pumps	Single-stage-in-line-pumps
	Quantity		1	1
	Model		TP50-240/2	TP50-240/2
	Nominal Static Height Unit cooling	kPa	173	154
Hydraulic components	Buffer tank	l	190	190
	Additional unit water volume	l	208	208
	Expansion vessel	l	35	
	Pre-charge pressure exp. vessel	bar	1,5	
	Safety valve	bar	3	
OPHP				
Units			EWYQ080DAYN*	EWYQ100DAYN*
Pump	Type		Single-stage-in-line-pumps	Single-stage-in-line-pumps
	Quantity		1	1
	Model		TP50-430/2	TP50-430/2
	Nominal Static Height Unit Cooling	kPa	365	348

1.9 Technical specifications for options: EWYQ130-150DAYN

Technical specifications

The table below contains the technical specifications for the options of the EWYQ130-150DAYN.

Technical specifications options				
OPSP				
Units			EWYQ130DAYN*	EWYQ150DAYN*
Weight	Additional machine weight	kg	250	250
	Additional operation weight	kg	286	286
	Additional gross weight	kg	250	250
Pump	Type		Single-stage-in-line-pumps	Single-stage-in-line-pumps
	Quantity		1	1
	Model		TP65-260/2	TP65-260/2
	Nominal Static Height Unit Cooling	kPa	141	141
Hydraulic components	Additional unit water volume	l	36	36
	Expansion vessel	l	35	
	Pre-charge pressure exp. vessel	bar	1,5	
	Safety valve	bar	3	
OPSP + OPBT				
Units			EWYQ130DAYN*	EWYQ150DAYN*
Weight	Additional machine weight	kg	300	300
	Additional operation weight	kg	526	526
	Additional gross weight	kg	300	300
Pump	Type		Single-stage-in-line-pumps	Single-stage-in-line-pumps
	Quantity		1	1
	Model		TP65-260/2	TP65-260/2
	Nominal Static Height Unit Cooling	kPa	141	141
Hydraulic components	Buffer tank	l	190	190
	Additional unit water volume	l	226	226
	Expansion vessel	l	35	
	Pre-charge pressure exp. vessel	bar	1,5	
	Safety valve	bar	3	
OPHP				
Units			EWYQ130DAYN*	EWYQ150DAYN*
Pump	Type		Single-stage-in-line-pumps	Single-stage-in-line-pumps
	Quantity		1	1
	Model		TP65-340/2	TP65-340/2
	Nominal Static Height Unit	kPa	261	261

1.10 Technical specifications for options: EWYQ180-210DAYN

Technical specifications

The table below contains the technical specifications for the options of the EWYQ180-210DAYN.

Technical specifications options				
OPSP				
Units			EWYQ180DAYN	EWYQ210DAYN
Weight	Additional machine weight	kg	250	250
	Additional operation weight	kg	286	286
	Additional gross weight	kg	250	250
Pump	Type		Single-stage-in-line-pumps	Single-stage-in-line-pumps
	Quantity		1	1
	Model		TP65-260/2	TP65-260/2
	Nominal Static Height Unit cooling	kPa	152	128
Hydraulic components	Additional unit water volume	l	36	36
	Expansion vessel	l	35	
	Pre-charge pressure exp. vessel	bar	1,5	
	Safety valve	bar	3	
OPSP + OPBT				
Units			EWYQ180DAYN	EWYQ210DAYN
Weight	Additional machine weight	kg	300	300
	Additional operation weight	kg	526	526
	Additional gross weight	kg	300	300
Pump	Type		Single-stage-in-line-pumps	Single-stage-in-line-pumps
	Quantity		1	1
	Model		TP65-260/2	TP65-260/2
	Nominal Static Height Unit Cooling	kPa	152	128
Hydraulic components	Buffer tank	l	190	190
	Additional unit water volume	l	226	226
	Expansion vessel	l	35	
	Pre-charge pressure exp. vessel	bar	1,5	
	Safety valve	bar	3	
OPHP				
Units			EWYQ180DAYN*	EWYQ210DAYN*
Pump	Type		Single-stage-in-line-pumps	Single-stage-in-line-pumps
	Quantity		1	1
	Model		TP65-410/2	TP65-410/2
	Nominal Static Height Unit	kPa	306	286

1

1.11 Technical Specifications for options: EWYQ230-250DAYN

Technical specifications

The table below contains the technical specifications for the options of the EWYQ230~250DAYN.

Technical specifications options				
OPSP				
Units			EWYQ230DAYN*	EWYQ250DAYN*
Weight	Additional machine weight	kg	250	250
	Additional operation weight	kg	271	271
	Additional gross weight	kg	250	250
Pump	Type		Single-stage-in-line-pumps	Single-stage-in-line-pumps
	Quantity		1	1
	Model		TP65-260/2	TP65-260/2
	Nominal Static Height Unit Cooling	kPa	143	129
Hydraulic components	Additional unit water volume	l	21	21
	Expansion vessel	l	50	
	Pre-charge pressure exp. vessel	bar	1,5	
	Safety valve	bar	3	
OPSP + OPBT				
Units			EWYQ230DAYN*	EWYQ250DAYN*
Weight	Additional machine weight	kg	300	300
	Additional operation weight	kg	511	511
	Additional gross weight	kg	300	300
Pump	Type		Single-stage-in-line-pumps	Single-stage-in-line-pumps
	Quantity		1	1
	Model		TP65-260/2	TP65-260/2
	Nominal Static Height Unit Cooling	kPa	143	129
Hydraulic components	Buffer tank	l	190	190
	Additional unit water volume	l	211	211
	Expansion vessel	l	50	
	Pre-charge pressure exp. vessel	bar	1,5	
	Safety valve	bar	3	
OPHP				
Units			EWYQ230DAYN*	EWYQ250DAYN*
Pump	Type		Single-stage-in-line-pumps	Single-stage-in-line-pumps
	Quantity		1	1
	Model		TP65-410/2	TP65-410/2
	Nominal Static Height Unit	kPa	292	280

1.12 Electrical Specifications: EWAQ080-260DAYN

Electrical specifications

The table below contains the electrical specifications.

			EWAQ080 DAYN	EWAQ100D AYN	EWAQ130D AYN	EWAQ150D AYN	EWAQ180D AYN	EWAQ210D AYN	EWAQ240DA YN	EWAQ260D AYN	
Power supply	Phase		3	3	3	3	3	3	3	3	
	Frequency	Hz	50	50	50	50	50	50	50	50	
	Voltage		V	400	400	400	400	400	400	400	400
	Voltage Tolerance	Minimum	%	-10%							
Maximum		%	+10%								
Unit	Starting current		A	201 (max. 240)	221 (max. 272)	161 (max. 269)	199 (max. 320)	221 (max. 357)	221 (max. 368)	266 (max. 426)	266 (max. 468)
	Nominal Running Current Cooling		A	60	72	88	113	131	144	162	181
	Maximum Running Current		A	96	120	160	177	209	233	262	290
	Recommended fuses according to IEC standard 269-2			3x125gL	3x160gL	3x200gL	3x200gL	3x250gL	3x250gL	3x300gL	3x355gL
Fan	Starting method		Direct On-Line								
	Maximum Running Current	A	1.5	1.5	1.4	2.1	2.1	2.1	1.6	1.6	
Compressor	Starting current		A	195	215	158	195	195/215	215	215/260	260
	Nominal Running Current (RLA)		A	25/25	31/31	19/19	25/25	25/31	31/31	31/40	40/40
	Maximum Running Current		A	39	51	35	39	39/51	51	51/65	65
	Starting method			Direct On-Line							
Control circuit	Phase		1	1	1	1	1	1	1	1	
	Frequency	Hz	50	50	50	50	50	50	50	50	
	Voltage		V	230V (supplied by factory installed transformers)							
	Crankcase heater (E1/2HC)		W	2x75	2x75	4x65	4x75	4x75	4x75	75	75
Notes	Starting current of the unit = maximum running current 4 fans + starting current 1 compressor			Starting current of the unit = maximum running current 2 fans(1 circuit) + starting current 1 compressor			Starting current of the unit = maximum running current 3 fans(1 circuit) + starting current 1 compressor			Initial starting current = maximum running current 4 fans + starting current 1 compressor	
	Maximum starting current = maximum running current 4 fans + maximum running current 1 compressor + starting current 1 compressor			Maximum starting current of the unit = maximum running current 4 fans + maximum running current 3 compressors + starting current 1 compressor			Maximum starting current = maximum running current 6 fans + maximum running current 3 compressors + starting current 1 compressor			Maximum starting current = maximum running current 8 fans + maximum running current 3 compressors + starting current 1 compressor	



1.13 Electrical Specifications for options: EWAQ080-100DAYN

Electrical specifications

The table below contains the electrical specifications for the options of the EWAQ080-100 DAYN.

Electrical specifications options				
OPSP				
Units			EWAQ080DAYN*	EWAQ100DAYN*
Std Pump	Starting method		Direct On-Line	
	Power	W	2,2kW	2,2kW
	Maximum Running current	A	4,5	4,5
	Starting current	A	42	42
OPHP				
Units			EWAQ080DAYN*	EWAQ100DAYN*
High Esp Pump	Starting method		Direct On-Line	
	Power	W	5,5kW	5,5kW
	Maximum Running current	A	11,2	11,2
	Starting current	A	131	131
OP 10				
Units			EWAQ080DAYN*	EWAQ100DAYN*
Heater Tape	Supply Voltage	V	230+/-10%	
	Recommended fuses	A	2x 10 A	
	Power standard model		1 x 300W	1 x 300W
	Power model with pump		2 x 300W	2 x 300W
	Power model with pump and buffer tank		2 x 300W + 1 x 150W	2 x 300W + 1 x 150W

1.14 Electrical Specifications for options: EWAQ130-150DAYN

Electrical specifications

The table below contains the electrical specifications for the options of the EWAQ130-150DAYN.

Electrical specifications options				
OPSP				
Units			EWAQ130DAYN*	EWAQ150DAYN*
Std Pump	Starting method		Direct On-Line	
	Power	W	3 kW	3 kW
	Maximum Running current	A	6,3	6,3
	Starting current	A	58	58
OPHP				
Units			EWAQ130DAYN*	EWAQ150DAYN*
High Esp Pump	Starting method		Direct On-Line	
	Power	W	5,5 kW	5,5 kW
	Maximum Running current	A	11,2	11,2
	Starting current	A	131	131
OP 10				
Units			EWAQ130DAYN*	EWAQ150DAYN*
Heater Tape	Supply Voltage	V	230+/-10%	
	Recommended fuses	A	2x 10 A	
	Power standard model		1 x 300W	1 x 300W
	Power model with pump		2 x 300W	2 x 300W
	Power model with pump and buffer tank		2 x 300W + 1 x 150W	2 x 300W + 1 x 150W

1.15 Electrical Specifications for options: EWAQ180-210DAYN

Electrical specifications

The table below contains the electrical specifications for the options of the EWAQ180-210 DAYN.

Electrical specifications options				
OPSP				
Units			EWAQ180DAYN*	EWAQ210DAYN*
Std Pump	Starting method		Direct On-Line	
	Power	W	4kW	4kW
	Maximum Running current	A	8	8
	Starting current	A	98	98
OPHP				
Units			EWAQ180DAYN*	EWAQ210DAYN*
High Esp Pump	Starting method		Direct On-Line	
	Power	W	7,5kW	7,5kW
	Maximum Running current	A	15,2	15,2
	Starting current	A	169	169
OP10				
Units			EWAQ180DAYN*	EWAQ210DAYN*
Heater Tape	Supply Voltage	V	230+/-10%	
	Recommended fuses	A	2x 10A	
	Power standard model		1 x 300W	1 x 300W
	Power model with pump		2 x 300W	2 x 300W
	Power model with pump and buffer tank		2 x 300W + 1 x 150W	2 x 300W + 1 x 150W

1.16 Electrical Specifications for options: EWAQ240-260DAYN

Electrical specifications

The table below contains the electrical specifications for the options of the EWAQ240-260 DAYN.

Electrical specifications options				
OPSP				
Units			EWAQ240DAYN*	EWAQ260DAYN*
Std Pump	Starting method		Direct On-Line	
	Power	kW	4,0	4,0
	Maximum Running current	A	8,0	8,0
	Starting current	A	98	98
OPHP				
Units			EWAQ240DAYN*	EWAQ260DAYN*
High Esp Pump	Starting method		Direct On-Line	
	Power	kW	7,5	7,5
	Maximum Running current	A	15,2	15,2
	Starting current	A	169	169
OP10				
Units			EWAQ240DAYN*	EWAQ260DAYN*
Heater Tape	Supply Voltage	V	230+/-10%	
	Recommended fuses	A	2x 10 A	
	Power standard model		1 x 300W	1 x 300W
	Power model with pump		2 x 300W	2 x 300W
	Power model with pump and buffer tank		2 x 300W + 1 x 150W	2 x 300W + 1 x 150W

1

1.17 Electrical Specifications: EWYQ080-260DAYN

Electrical specifications

The table below contains the electrical specifications.

		EWYQ080 DAYN	EWYQ100D AYN	EWYQ130DA YN	EWYQ150DA YN	EWYQ180D AYN	EWYQ210D AYN	EWYQ230DA YN	EWYQ250D AYN	
Power supply	Phase	3	3	3	3	3	3	3	3	
	Frequency	Hz	50	50	50	50	50	50	50	
	Voltage	V	400	400	400	400	400	400	400	
	Voltage Tolerance	Minimum	-10%							
		Maximum	+10%							
Unit	Starting current	A	201 (max. 240)	221 (max. 272)	161 (max. 269)	199 (max. 320)	221 (max. 357)	221 (max. 368)	266 (max. 440)	266 (max. 468)
	Nominal Running Current Cooling	A	60	72	88	113	131	144	162	181
	Maximum Running Current	A	96	120	160	177	209	233	262	290
	Recommended fuses according to IEC standard 269-2		3x125gL	3x160gL	3x200gL	3x200gL	3x250gL	3x250gL	3x300gL	3x355gL
	Starting method	Direct On-Line								
Fan	Maximum Running Current	A	1.5	1.5	1.4	2.1	2.1	2.1	1.6	1.6
	Starting current	A	195	215	158	195	195/215	215	215/260	260
Compressor	Nominal Running Current (RLA)	A	25/25	31/31	19/19	25/25	25/31	31/31	31/40	40/40
	Maximum Running Current	A	39	51	35	39	39/51	51	51/65	65
	Starting method	Direct On-Line								
	Phase	1								
Control circuit	Frequency	Hz	50	50	50	50	50	50	50	50
	Voltage	V	230V (supplied by factory installed transformers)	230V (supplied by factory installed transformers)	230V (supplied by factory installed transformers)	230V (supplied by factory installed transformers)			230V/24V AC (supplied by factory installed transformers)	230V/24V AC (supplied by factory installed transformers)
	Crankcase heater (E1/2HC)	W	2x75	2x75	4x65	4x75	4x75	4x75	4x75	4x75
	Phase	1								

	EWYQ080 DAYN	EWYQ100D AYN	EWYQ130DA YN	EWYQ150DA YN	EWYQ180D AYN	EWYQ210D AYN	EWYQ230DA YN	EWYQ250D AYN
Notes	Initial starting current = Maximum running current 4 fans (1 circuit) + starting current 1 compressor	Initial starting current = Maximum running current 4 fans (1 circuit) + starting current 1 compressor	Starting current of the unit = Maximum running current 2 fans (1 circuit) + starting current 1 compressor	Starting current of the unit = Maximum running current 2 fans (1 circuit) + starting current 1 compressor	Initial starting current = Maximum running current 3 fans (1 circuit) + starting current 1 compressor	Initial starting current = Maximum running current 3 fans (1 circuit) + starting current 1 compressor	Initial starting current = Maximum running current 4 fans (1 circuit) + starting current 1 compressor	Initial starting current = Maximum running current 4 fans (1 circuit) + starting current 1 compressor
	Max. starting current of the unit = Maximum running current 4 fans + max. running current 3 compressors + starting current 1 compressor	Max. starting current of the unit = Maximum running current 4 fans + max. running current 3 compressors + starting current 1 compressor	Max. starting current of the unit = Maximum running current 4 fans + max. running current 3 compressors + starting current 1 compressor	Max. starting current of the unit = Maximum running current 4 fans + max. running current 3 compressors + starting current 1 compressor	Max. starting current of the unit = Maximum running current 4 fans + max. running current 3 compressors + starting current 1 compressor	Maximum starting current = maximum running current 6 fans + maximum running current 3 compressors + starting current 1 compressor	Maximum starting current = maximum running current 6 fans + maximum running current 3 compressors + starting current 1 compressor	Maximum starting current = maximum running current 8 fans + maximum running current 3 compressors + starting current 1 compressor

1.18 Electrical Specifications for options: EWYQ080-100DAYN

Electrical specifications

The table below contains the electrical specifications for the options of the EWYQ080-100DAYN.

Electrical specifications options				
OPSP				
Units			EWYQ080DAYN*	EWYQ100DAYN*
Std Pump	Starting method		Direct On-Line	
	Power	kW	2,2	2,2
	Maximum Running current	A	4,45	4,45
	Starting current	A	42	42
OPHP				
Units			EWYQ080DAYN*	EWYQ100DAYN*
High Esp Pump	Starting method		Direct On-Line	
	Power	kW	5,5	5,5
	Maximum Running current	A	11,2	11,2
	Starting current	A	131	131
OP10				
Units			EWYQ080DAYN*	EWYQ100DAYN*
Heater Tape	Supply Voltage	V	230+/-10%	
	Recommended fuses	A	2 x 10 A	
	Power standard model		1 x 300W	1 x 300W
	Power model with pump		2 x 300W	2 x 300W
	Power model with pump and OPBT		2 x 300W + 1 x 150W	2 x 300W + 1 x 150W

1.19 Electrical Specifications for options: EWYQ130-150DAYN

1

Electrical specifications

The table below contains the electrical specifications for the options of the EWYQ130-150DAYN.

Electrical specifications options				
OPSP				
Units			EWYQ130DAYN*	EWYQ150DAYN*
Std Pump	Starting method		Direct On-Line	
	Power	W	3kW	3kW
	Maximum Running current	A	6,3	6,3
	Starting current	A	58	58
OPHP				
Units			EWYQ130DAYN*	EWYQ150DAYN*
High Esp Pump	Starting method		Direct On-Line	
	Power	W	5,5kW	5,5kW
	Maximum Running current	A	11,2	11,2
	Starting current	A	131	131
OP10				
Units			EWYQ130DAYN*	EWYQ150DAYN*
Heater Tape	Supply Voltage	V	230+/-10%	
	Recommended fuses	A	2 x 10A	
	Power standard model		1 x 300W	1 x 300W
	Power model with pump		2 x 300W	2 x 300W
	Power model with pump and OPBT		2 x 300W + 1 x 150W	2 x 300W + 1 x 150W

1

1.20 Electrical Specifications for options: EWYQ180-210DAYN

Electrical specifications

The table below contains the electrical specifications for the options of the EWYQ180-210DAYN.

Electrical specifications options				
OPSP				
Units			EWYQ180DAYN*	EWYQ210DAYN*
Std Pump	Starting method		Direct On-Line	
	Power	kW	4kW	4kW
	Maximum Running current	A	8	8
	Starting current	A	98	98
OPHP				
Units			EWYQ180DAYN*	EWYQ210DAYN*
High Esp Pump	Starting method		Direct On-Line	
	Power	kW	7,5kW	7,5kW
	Maximum Running current	A	15,2	15,2
	Starting current	A	169	169
OP10				
Units			EWYQ180DAYN*	EWYQ210DAYN*
Heater Tape	Supply Voltage	V	230+/-10%	
	Recommended fuses	A	2 x 10A	
	Power standard model		1 x 300W	1 x 300W
	Power model with pump		2 x 300W	2 x 300W
	Power model with pump and buffer tank		2 x 300W + 1 x 150W	2 x 300W + 1 x 150W

1.21 Electrical Specifications for options: EWYQ230-250DAYN

Electrical specifications

The table below contains the electrical specifications for the options of the EWYQ230-250DAYN.

Electrical specifications options				
OPSP				
Units			EWYQ230DAYN*	EWYQ250DAYN*
Std Pump	Starting method		Direct On-Line	
	Power	kW	4,0	4,0
	Maximum Running current	A	8,0	8,0
	Starting current	A	98	98
OPHP				
Units			EWYQ230DAYN*	EWYQ250DAYN*
High Esp Pump	Starting method		Direct On-Line	
	Power	kW	7,5	7,5
	Maximum Running current	A	15,2	15,2
	Starting current	A	169	169
OP 10				
Units			EWYQ230DAYN*	EWYQ250DAYN*
Heater Tape	Supply Voltage	V	230+/-10%	
	Recommended fuses	A	2 x 10A	
	Power standard model		1 x 300W	1 x 300W
	Power model with pump		2 x 300W	2 x 300W
	Power model with pump and OPBT		2 x 300W + 1 x 150W	2 x 300W + 1 x 150W

1

1.22 Correction Factors for Glycol

Correction factors The illustration below shows the correction factors for glycol.

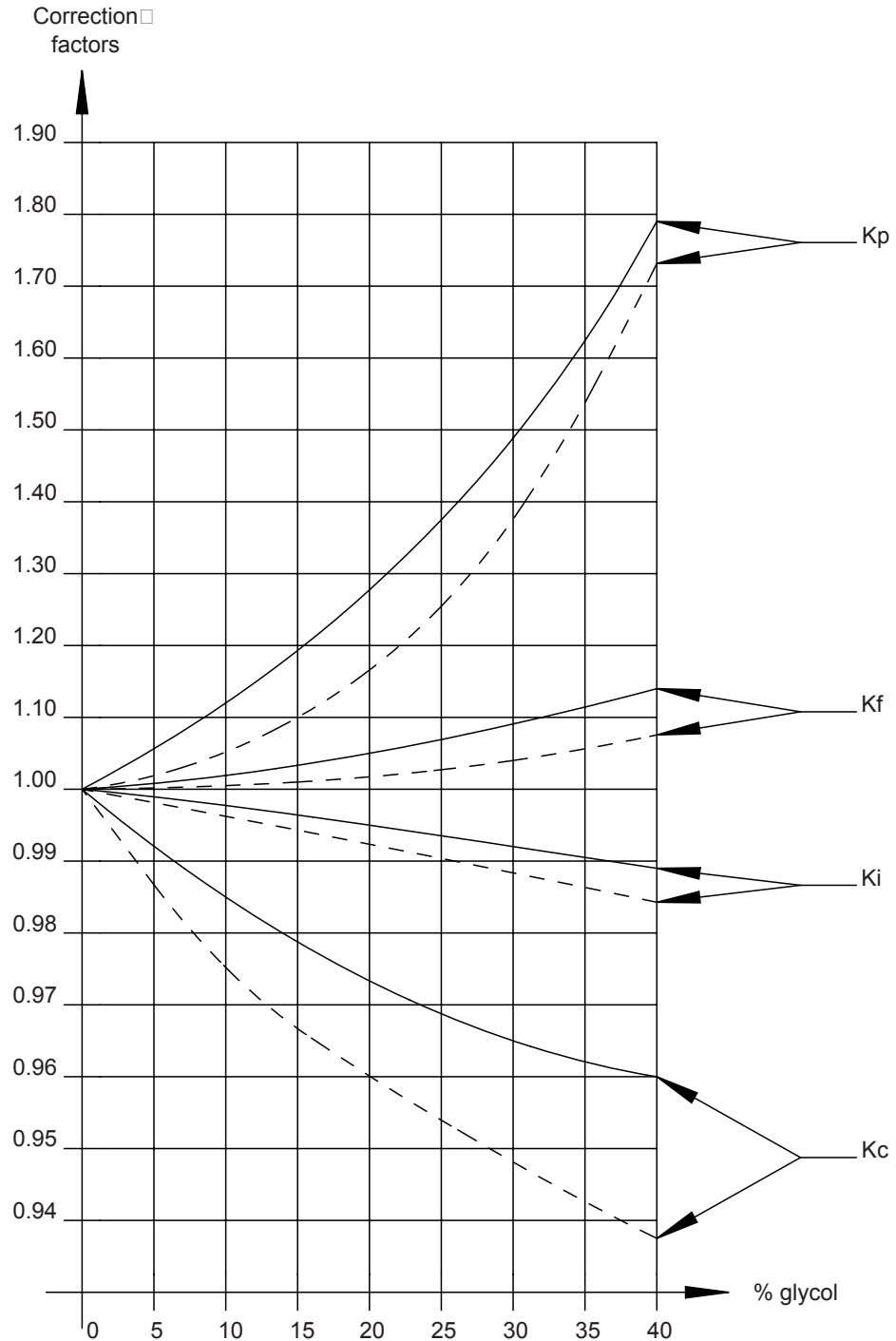

Legend

The table below describes the patterns and symbols used for the correction factors illustrated above.

Pattern	Description
_____	Ethylene glycol
-----	Propylene glycol
Kc	Correction on cooling capacity
Ki	Correction on power input
Kf	Correction on flow rate
Kp	Correction on pressure drop

Glycol freezing point

The table below contains glycol freezing points for different glycol concentrations.

Type	Concentration (wt%)	0	10	20	30	40
Ethylene glycol	Freezing point °C	0	-4	-9	-16	-23
	Minimum LWE °C	4	2	0	-5	-11
Propyl-ene glycol	Freezing point °C	0	-3	-7	-13	-22
	Minimum LWE °C	4	3	-2	-4	-10

1.23 Optional equipment for EWAQ-DAYN (N-P-B)

Optional equipment for EWAQ-DAYNN

Capacity: 080-260 kW

EWAQ080DAYNN	EWAQ150DAYNN	EWAQ240DAYNN
EWAQ100DAYNN	EWAQ180DAYNN	EWAQ260DAYNN
EWAQ130DAYNN	EWAQ210DAYNN	

Option number	Option description	Unit size								Availability
		080	100	130	150	180	210	240	260	
	Standard unit	°	°	°	°	°	°	°	°	
OPSC	Single pump contactor	°	°	°	°	°	°	°	°	fact. mount.
OPTC	Twin pump contactor	°	°	°	°	°	°	°	°	fact. mount.
OPSP	Single pump	°	°	°	°	°	°	°	°	fact. mount.
OPTP	Twin pump (1 pump house, dual motor)	°	°	°	°	°	°	°	°	fact. mount.
OPHP	High ESP pump (single pump only)	°	°	°	°	°	°	°	°	fact. mount.
OPBT	Buffer tank	°	°	°	°	°	°	°	°	fact. mount.
OPIF	Inverter fans (For low ambient -15°C)	°	°	°	°	°	°	°	°	fact. mount.
OPZL	Glycol 0°C/ -10°C	°	°	°	°	°	°	°	°	fact. mount.
OP03	Dual pressure relief valve	°	°	°	°	°	°	°	°	fact. mount.
OP10	Evaporator heater tape	°	°	°	°	°	°	°	°	fact. mount.
OP12	Option valves (discharge-, liquid line- and suction stop valve)	°(S)	°(S)	°(S)	°(S)	°(S)	°(S)	°(S)	°(S)	fact. mount.
OP57	A-meter / V-meter	°	°	°	°	°	°	°	°	fact. mount.
OPLN	Low noise = OPIF + Compressor housing	°	°	°	°	°	°	°	°	fact. mount.
OPCG	Condenser protection grills	°	°	°	°	°	°	°	°	fact. mount.
	Available kits									
EKLONPG	Gateway for LON	°	°	°	°	°	°	°	°	Kit
EKBNPG	Gateway for BACNET	°	°	°	°	°	°	°	°	Kit
EKACPG	Address card	°	°	°	°	°	°	°	°	Kit
EKRUPG	Remote user interface	°	°	°	°	°	°	°	°	Kit

Notes

- ° Available
- Not available
- (S) Option required for Swedish national law SNFS 1992:16

1.24 Optional equipment for EWYQ-DAYN (N-P-B)

Optional equipment for EWYQ-DAYNN

Capacity: 080-250 kW

EWYQ080DAYNN	EWYQ150DAYNN	EWYQ230DAYNN
EWYQ100DAYNN	EWYQ180DAYNN	EWYQ250DAYNN
EWYQ130DAYNN	EWYQ210DAYNN	

Option number	Option description	Unit size								Availability
		080	100	130	150	180	210	230	250	
	Standard unit	°	°	°	°	°	°	°	°	
OPSC	Single pump contactor	°	°	°	°	°	°	°	°	fact. mount.
OPTC	Twin pump contactor	°	°	°	°	°	°	°	°	fact. mount.
OPSP	Single pump	°	°	°	°	°	°	°	°	fact. mount.
OPTP	Twin pump (1 pump house, dual motor)	°	°	°	°	°	°	°	°	fact. mount.
OPHP	High ESP pump (single pump only)	°	°	°	°	°	°	°	°	fact. mount.
OPBT	Buffer tank	°	°	°	°	°	°	°	°	fact. mount.
OPIF	Inverter fans (For low ambient -15°C)	°	°	°	°	°	°	°	°	fact. mount.
OPZL	Glycol 0°C / -10°C	°	°	°	°	°	°	°	°	fact. mount.
OP03	Dual pressure relief valve	°	°	°	°	°	°	°	°	fact. mount.
OP10	Evaporator heater tape	°	°	°	°	°	°	°	°	fact. mount.
OP12	Option valves (discharge-, liquid line- and suction stop valve)	°(S)	°(S)	°(S)	°(S)	°(S)	°(S)	°(S)	°(S)	fact. mount.
OP57	A-meter / V-meter	°	°	°	°	°	°	°	°	fact. mount.
OPLN	Low noise = OPIF + Compressor housing	°	°	°	°	°	°	°	°	fact. mount.
OPCG	Condenser protection grills	°	°	°	°	°	°	°	°	fact. mount.
	Available kits									
EKLONPG	Gateway for LON	°	°	°	°	°	°	°	°	Kit
EKBNPG	Gateway for BACNET	°	°	°	°	°	°	°	°	Kit
EKACPG	Address card	°	°	°	°	°	°	°	°	Kit
EKRUPG	Remote user interface	°	°	°	°	°	°	°	°	Kit

Notes

- ° Available
- Not available
- (S) Option required for Swedish national law SNFS 1992:16

1.25 Outlook Drawing: EWAQ080-100DAYN(N)

EWAQ080-100DAYN (N)

The illustration below shows the outlook, the dimensions and the installation and service space of the unit (mm).

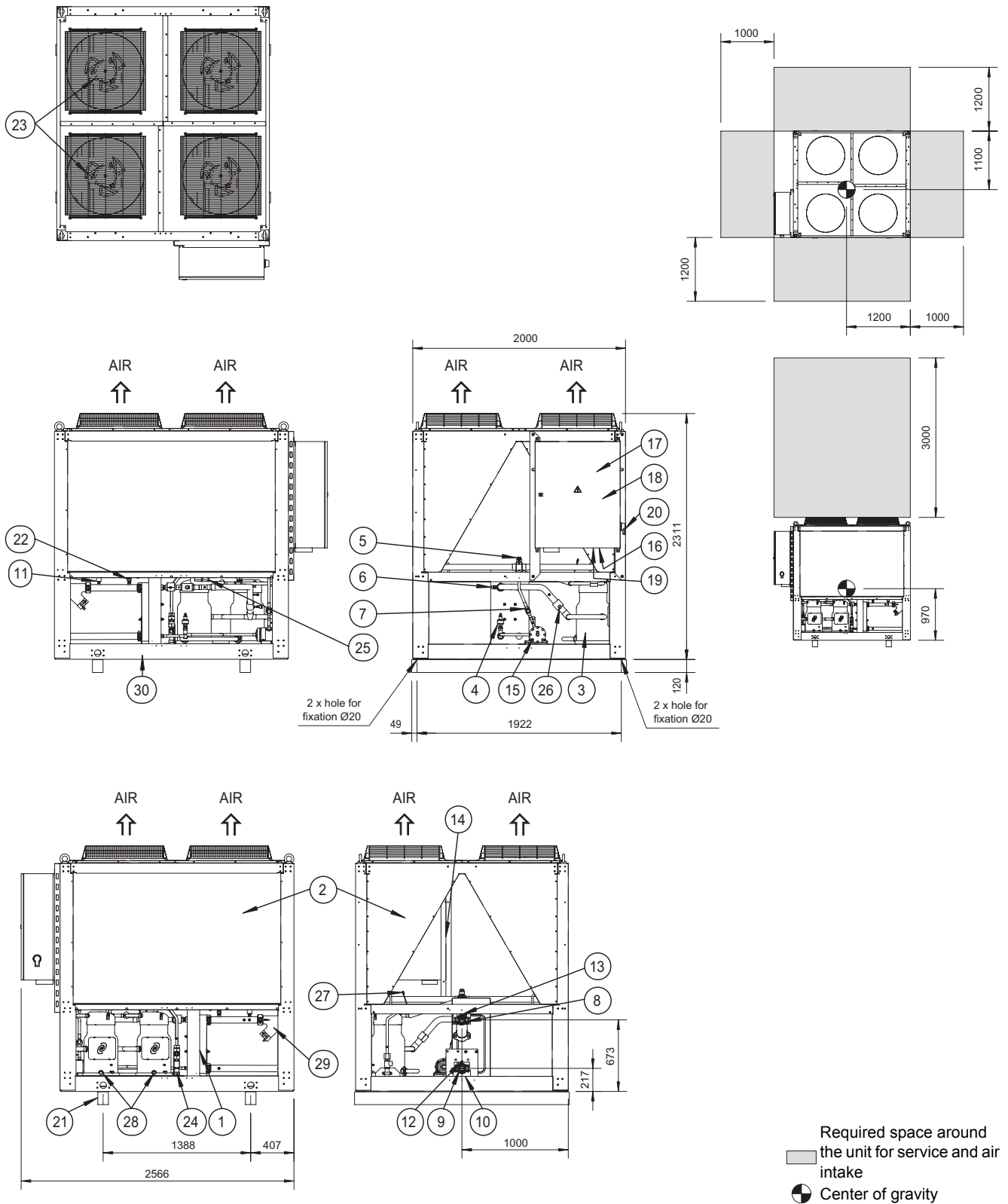

Components

The table below lists the components.

No.	Component
1	Evaporator
2	Condensor
3	Compressor
4	Expansion valve + sight glass
5	Discharge valve (Optional)
6	Suction stopvalve (Optional)
7	Liquid stopvalve (Optional)
8	Chilled water IN (Victaulic coupling)
9	Chilled water OUT (Victaulic coupling)
10	Water drain evaporator
11	Air purge
12	Leaving water temperature sensor
13	Entering water temperature sensor
14	Ambient temperature sensor
15	Drier + charge valve

No.	Component
16	Power supply intake
17	Switchbox
18	Digital display controller (Inside switchbox)
19	Field wiring intake
20	Main isolator switch
21	Transport beam
22	Flowswitch
23	Fan
24	Safety valve
25	High pressure sensor
26	Low pressure sensor
27	High pressure switch
28	Oil sight glass
29	Water filter
30	Frame

1

1.26 Outlook Drawing: EWAQ080-100DAYN(P-B)

EWAQ080-100DAYN (P-B)

The illustration below shows the outlook, the dimensions and the installation and service space of the unit (mm).

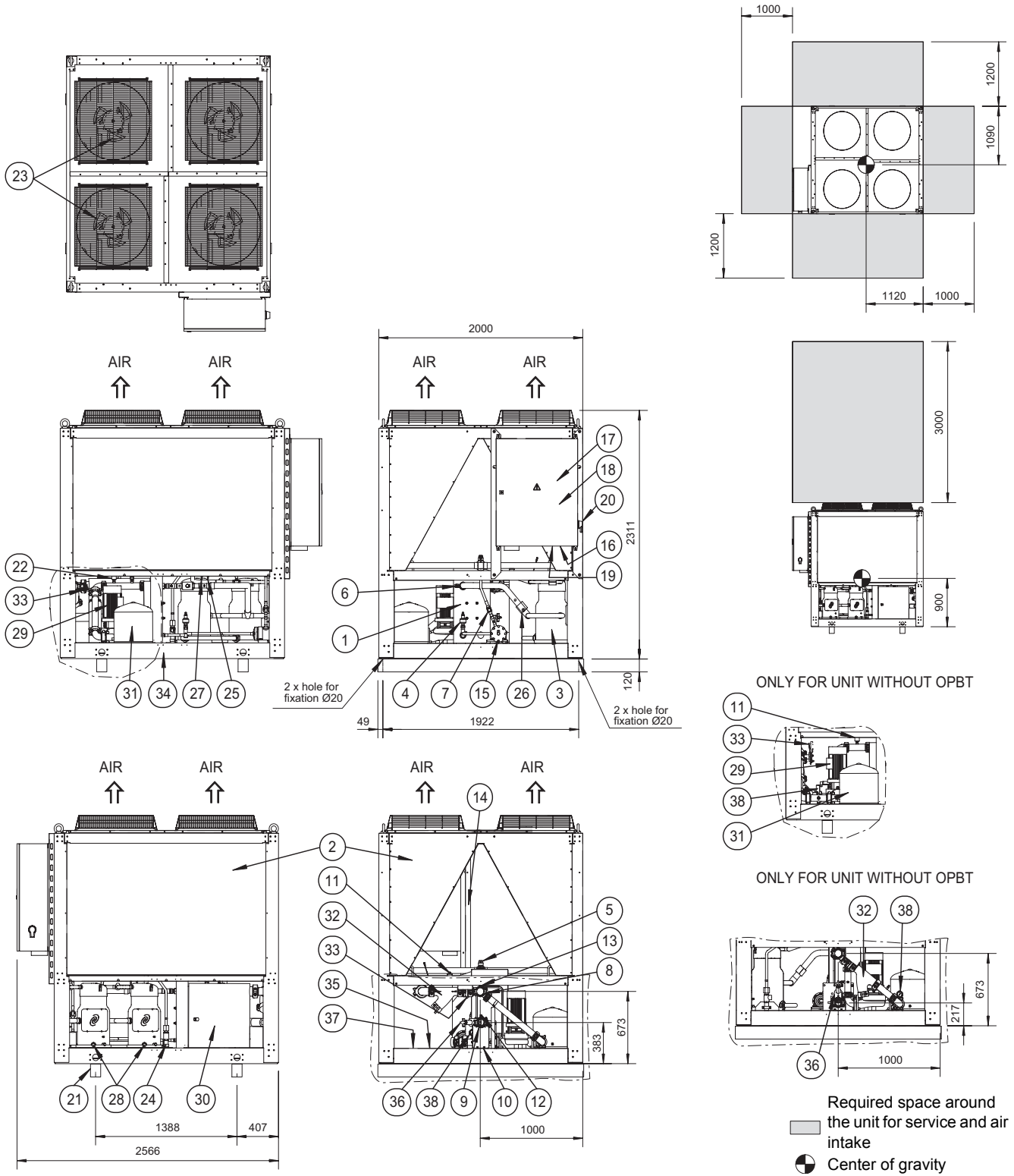

Components

The table below lists the components.

No.	Component
1	Evaporator
2	Condensor
3	Compressor
4	Expansion valve + sight glass
5	Discharge stopvalve (Optional)
6	Suction stopvalve (Optional)
7	Liquid stopvalve (Optional)
8	Chilled water IN (Victaulic coupling)
9	Chilled water OUT (Victaulic coupling)
10	Water drain evaporator
11	Air purge
12	Leaving water temperature sensor
13	Entering water temperature sensor
14	Ambient temperature sensor
15	Drier + charge valve
16	Power supply intake
17	Switchbox
18	Digital display controller (Inside switchbox)
19	Field wiring intake

No.	Component
20	Main isolator switch
21	Transport beam
22	Flowswitch
23	Fan
24	Safety valve
25	High pressure sensor
26	Low pressure sensor
27	High pressure switch
28	Oil sight glass
29	Pump (optional)
30	Buffer tank (optional)
31	Expansion vessel (optional)
32	Water filter
33	Water stopvalve (optional)
34	Frame
35	Buffer tank drain valve (optional)
36	Regulating valve (optional)
37	Water safety valve (optional)
38	Pressure gauge (optional)

1.27 Outlook Drawing: EWAQ130-150DAYN(N)

EWAQ130-150DAYN (N)

The illustration below shows the outlook, the dimensions and the installation and service space of the unit (mm).

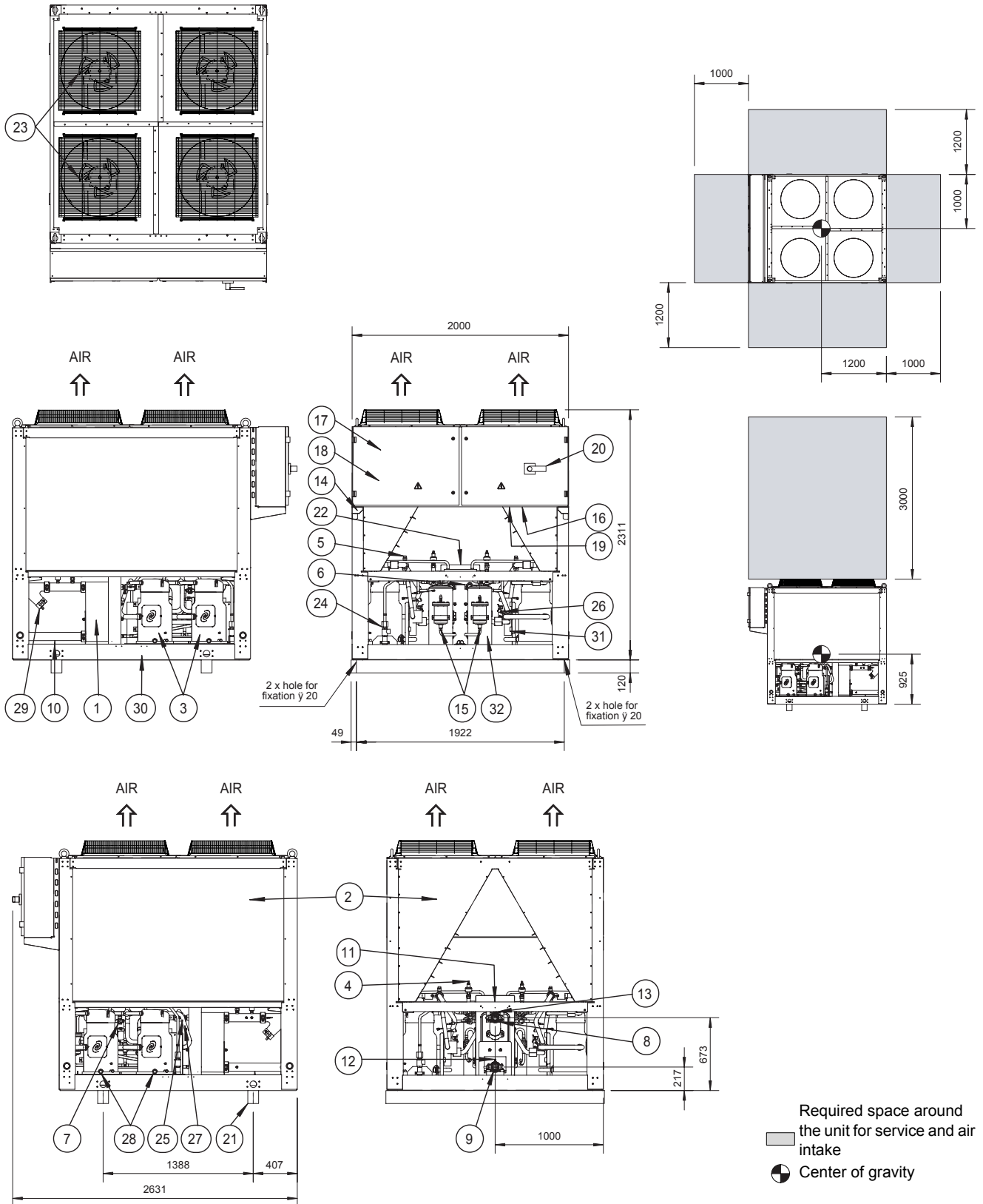

Components

The table below lists the components.

No.	Component
1	Evaporator
2	Condensor
3	Compressor
4	Expansion valve + sight glass
5	Discharge stopvalve (Optional)
6	Suction stopvalve (Optional)
7	Liquid stopvalve (Optional)
8	Chilled water IN (Victaulic coupling)
9	Chilled water OUT (Victaulic coupling)
10	Water drain evaporator
11	Air purge
12	Leaving water temperature sensor
13	Entering water temperature sensor
14	Ambient temperature sensor
15	Drier + charge valve

No.	Component
16	Power supply intake
17	Switchbox
18	Digital display controller (Inside switchbox)
19	Field wiring intake
20	Main isolator switch
21	Transport beam
22	Flowswitch
23	Fan
24	Safety valve
25	High pressure sensor
26	Low pressure sensor
27	High pressure switch
28	Oil sight glass
29	Water filter
30	Frame

1.28 Outlook Drawing: EWAQ130-150DAYN(P-B)

EWAQ130-150DAYN (P-B)

The illustration below shows the outlook, the dimensions and the installation and service space of the unit (mm).

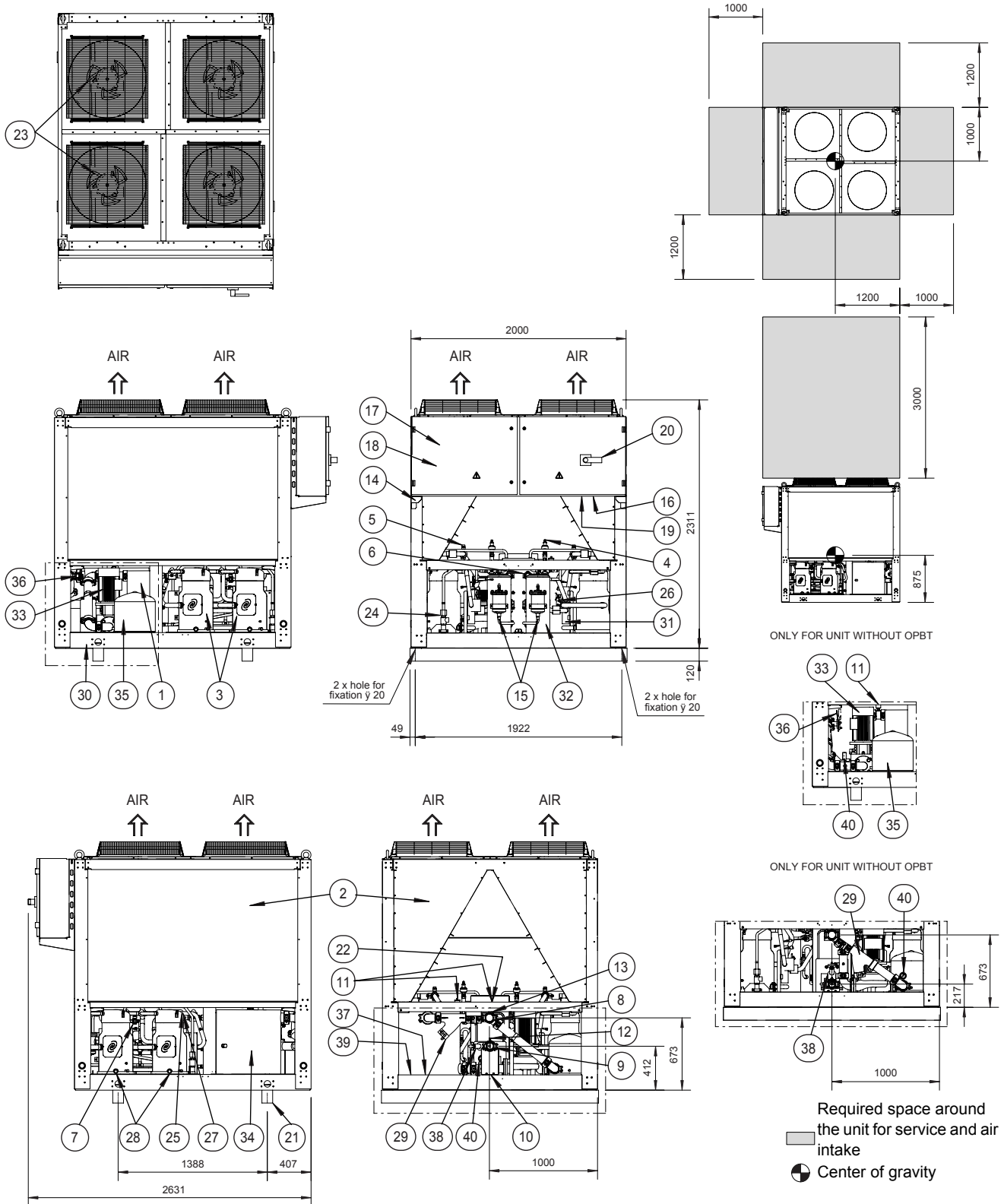

Components

The table below lists the components.

No.	Component
1	Evaporator
2	Condensor
3	Compressor
4	Expansion valve + sight glass
5	Discharge stopvalve (Optional)
6	Suction stopvalve (Optional)
7	Liquid stopvalve (Optional)
8	Chilled water IN (Victaulic coupling)
9	Chilled water OUT (Victaulic coupling)
10	Water drain evaporator
11	Air purge
12	Leaving water temperature sensor
13	Entering water temperature sensor
14	Ambient temperature sensor
15	Drier + charge valve
16	Power supply intake
17	Switchbox
18	Digital display controller (Inside switchbox)
19	Field wiring intake

No.	Component
20	Main isolator switch
21	Transport beam
22	Flowswitch
23	Fan
24	Safety valve
25	High pressure sensor
26	Low pressure sensor
27	High pressure switch
28	Oil sight glass
29	Pump (optional)
30	Buffer tank (optional)
31	Expansion vessel (optional)
32	Water filter
33	Water stopvalve (optional)
34	Frame
35	Buffer tank drain valve (optional)
36	Regulating valve (optional)
37	Water safety valve (optional)
38	Pressure gauge (optional)

1.29 Outlook Drawing: EWAQ180-210DAYN(N)

EWAQ180-210DAYN (N)

The illustration below shows the outlook, the dimensions and the installation and service space of the unit (mm).

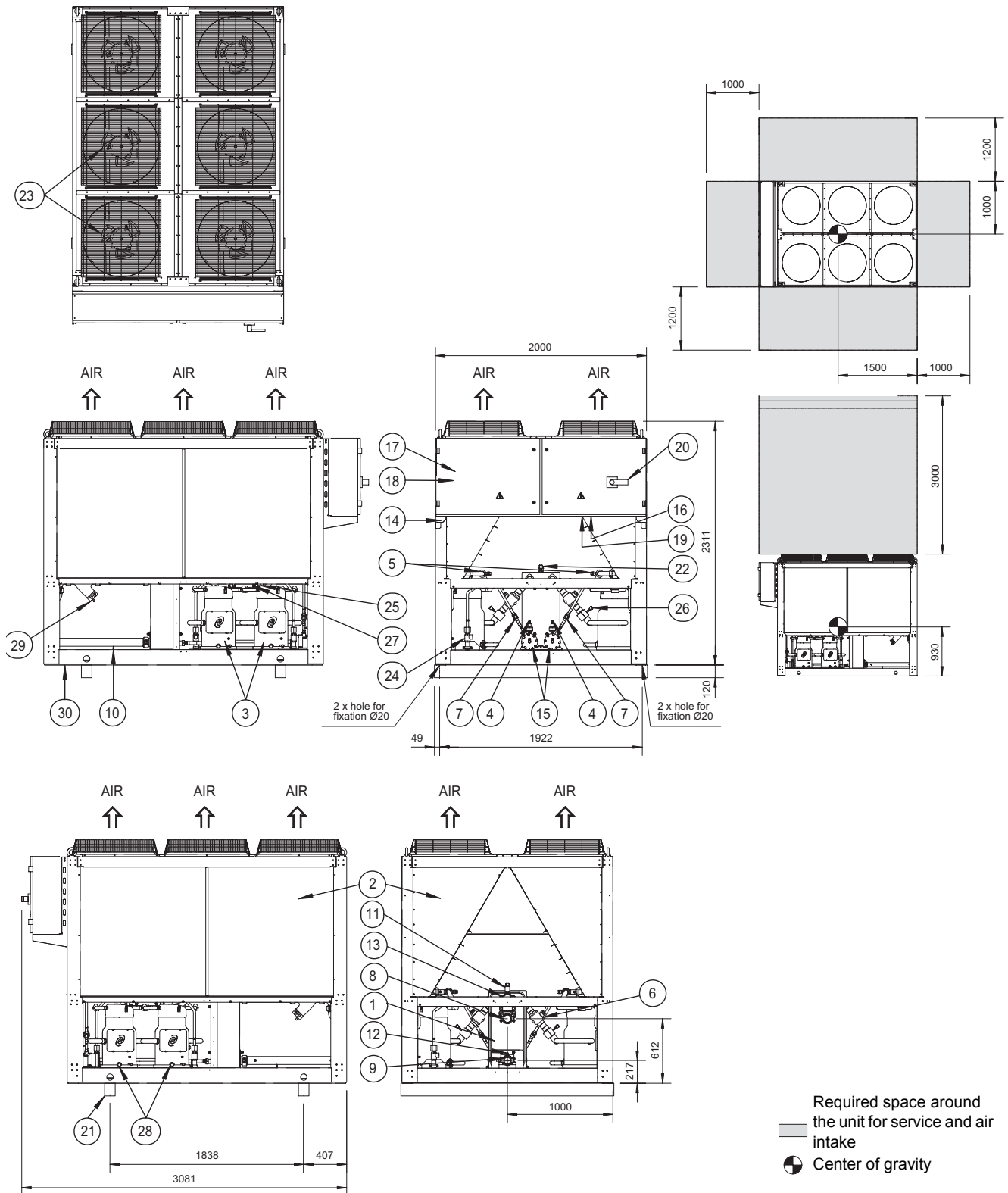

Components

The table below lists the components.

No.	Component
1	Evaporator
2	Condensor
3	Compressor
4	Expansion valve + sight glass
5	Discharge stopvalve (Optional)
6	Suction stopvalve (Optional)
7	Liquid stopvalve (Optional)
8	Chilled water IN (Victaulic coupling)
9	Chilled water OUT (Victaulic coupling)
10	Water drain evaporator
11	Air purge
12	Leaving water temperature sensor
13	Entering water temperature sensor
14	Ambient temperature sensor
15	Drier + charge valve

No.	Component
16	Power supply intake
17	Switchbox
18	Digital display controller (Inside switchbox)
19	Field wiring intake
20	Main isolator switch
21	Transport beam
22	Flowswitch
23	Fan
24	Safety valve
25	High pressure sensor
26	Low pressure sensor
27	High pressure switch
28	Oil sight glass
29	Water filter
30	Frame

1

1.30 Outlook Drawing: EWAQ180-210DAYN(P-B)

EWAQ180-210DAYN (P-B)

The illustration below shows the outlook, the dimensions and the installation and service space of the unit (mm).

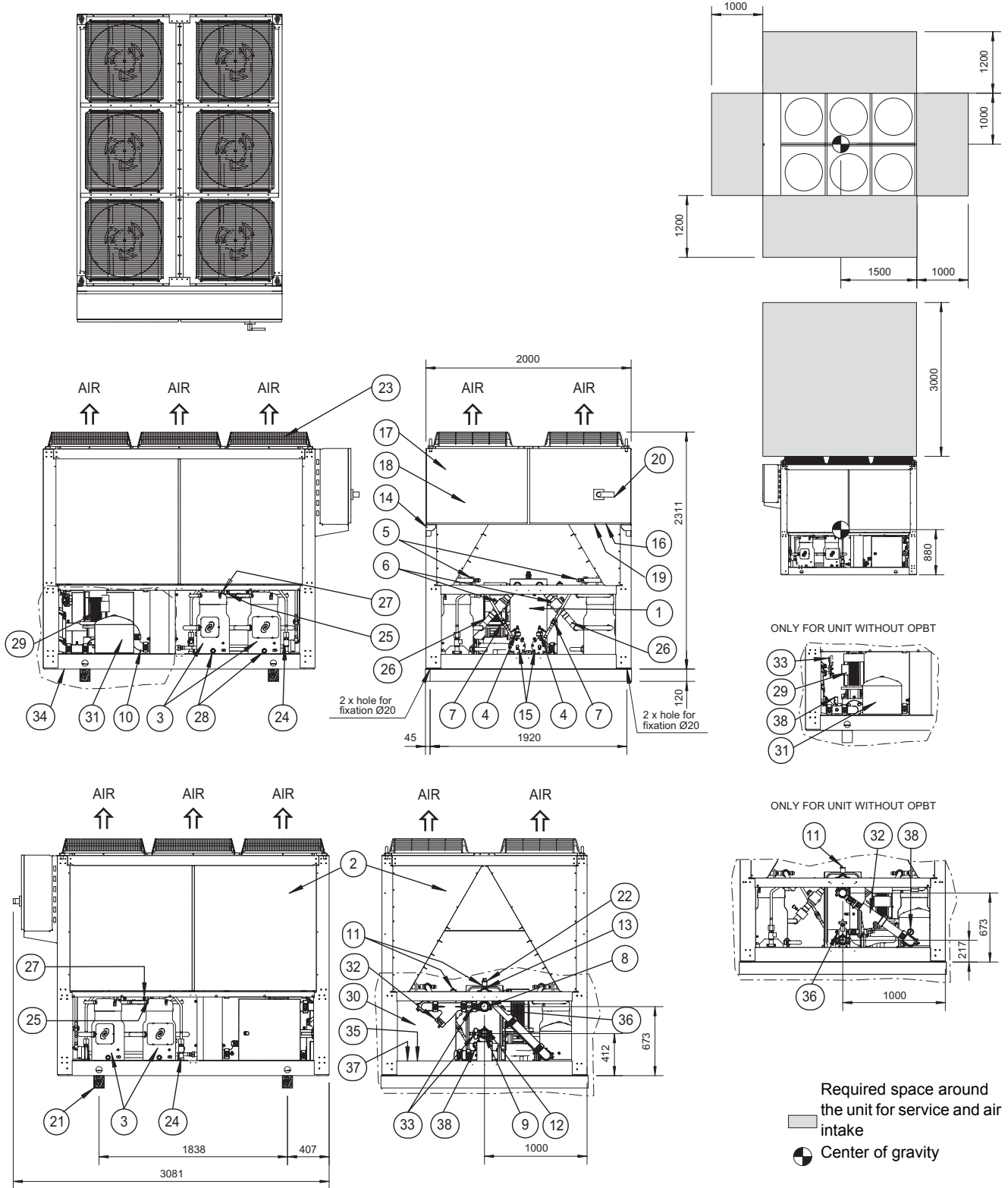

Components

The table below lists the components.

No.	Component
1	Evaporator
2	Condensor
3	Compressor
4	Expansion valve + sight glass
5	Discharge stopvalve (Optional)
6	Suction stopvalve (Optional)
7	Liquid stopvalve (Optional)
8	Chilled water IN (Victaulic coupling)
9	Chilled water OUT (Victaulic coupling)
10	Water drain evaporator
11	Air purge
12	Leaving water temperature sensor
13	Entering water temperature sensor
14	Ambient temperature sensor
15	Drier + charge valve
16	Power supply intake
17	Switchbox
18	Digital display controller (Inside switchbox)
19	Field wiring intake

No.	Component
20	Main isolator switch
21	Transport beam
22	Flowswitch
23	Fan
24	Safety valve
25	High pressure sensor
26	Low pressure sensor
27	High pressure switch
28	Oil sight glass
29	Pump (optional)
30	Buffer tank (optional)
31	Expansion vessel (optional)
32	Water filter
33	Water stopvalve (optional)
34	Frame
35	Buffer tank drain valve (optional)
36	Regulating valve (optional)
37	Water safety valve (optional)
38	Pressure gauge (optional)

1

1.31 Outlook Drawing: EWAQ240-260DAYN(N)

EWAQ240-260DAYN (N)

The illustration below shows the outlook, the dimensions and the installation and service space of the unit (mm).

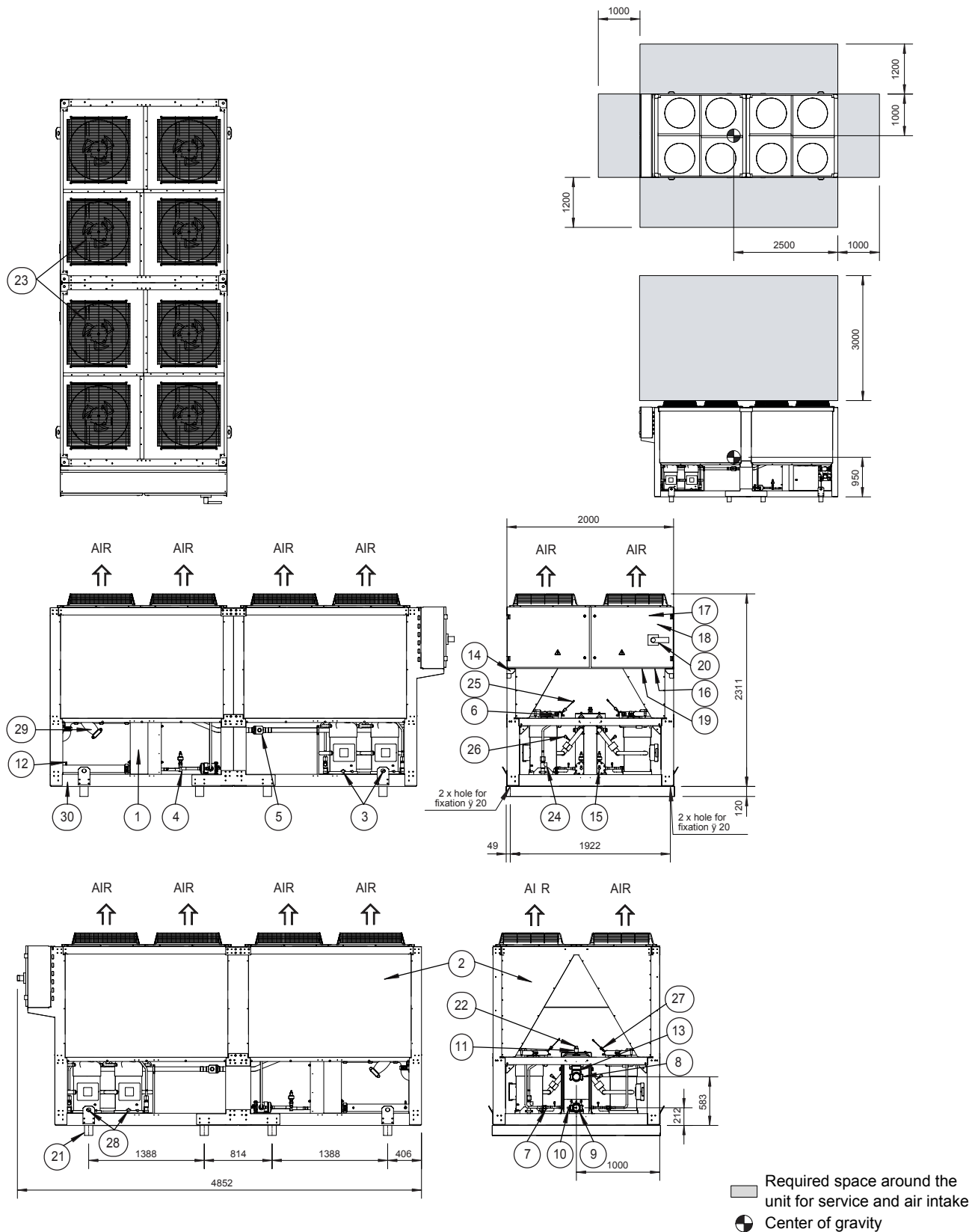

Components

The table below lists the components.

No.	Component
1	Evaporator
2	Condensor
3	Compressor
4	Expansion valve + sight glass
5	Discharge stopvalve (Optional)
6	Suction stopvalve (Optional)
7	Liquid stopvalve (Optional)
8	Chilled water IN (Victaulic coupling)
9	Chilled water OUT (Victaulic coupling)
10	Water drain evaporator
11	Air purge
12	Leaving water temperature sensor
13	Entering water temperature sensor
14	Ambient sensor
15	Drier + charge valve

No.	Component
16	Power supply intake
17	Switchbox
18	Digital display controller (Inside switchbox)
19	Field wiring intake
20	Main isolator switch
21	Transport beam
22	Flowswitch
23	Fan
24	Safety valve
25	High pressure sensor
26	Low pressure sensor
27	High pressure switch
28	Oil sight glass
29	Water filter
30	Frame

1.32 Outlook Drawing: EWAQ240-260DAYN(P-B)

EWAQ240-260DAYN (P-B)

The illustration below shows the outlook, the dimensions and the installation and service space of the unit (mm).

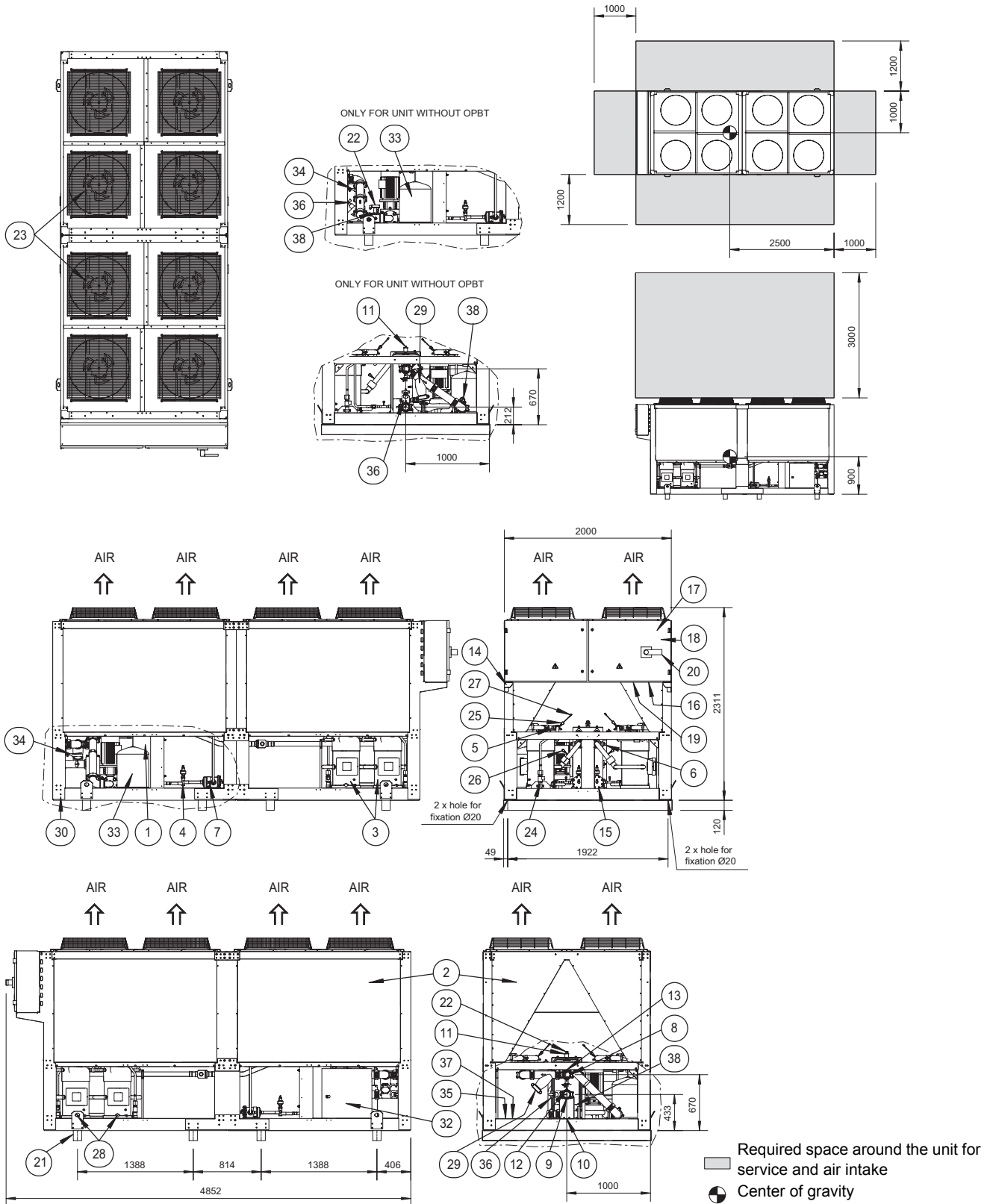

Components

The table below lists the components.

No.	Component
1	Evaporator
2	Condensor
3	Compressor
4	Expansion valve + sight glass
5	Discharge stopvalve (Optional)
6	Suction stopvalve (Optional)
7	Liquid stopvalve (Optional)
8	Chilled water IN (Victaulic coupling)
9	Chilled water OUT (Victaulic coupling)
10	Water drain evaporator
11	Air purge
12	Leaving water temperature sensor
13	Entering water temperature sensor
14	Ambient sensor
15	Drier + charge valve
16	Power supply intake
17	Switchbox
18	Digital display controller (Inside switchbox)
19	Field wiring intake

No.	Component
20	Main isolator switch
21	Transport beam
22	Flowswitch
23	Fan
24	Safety valve
25	High pressure sensor
26	Low pressure sensor
27	High pressure switch
28	Oil sight glass
29	Water filter
30	Frame
31	Pump (optional)
32	Buffer tank (optional)
33	Expansion vessel (optional)
34	Water stopvalve (optional)
35	Buffertank drain valve (optional)
36	Regulating valve (optional)
37	Water safety valve (optional)
38	Pressure gauge (optional)

1.33 Outlook Drawing: EWYQ080-100DAYN(N)

EWYQ080-100DAYN (N)

The illustration below shows the outlook, the dimensions and the installation and service space of the unit (mm).

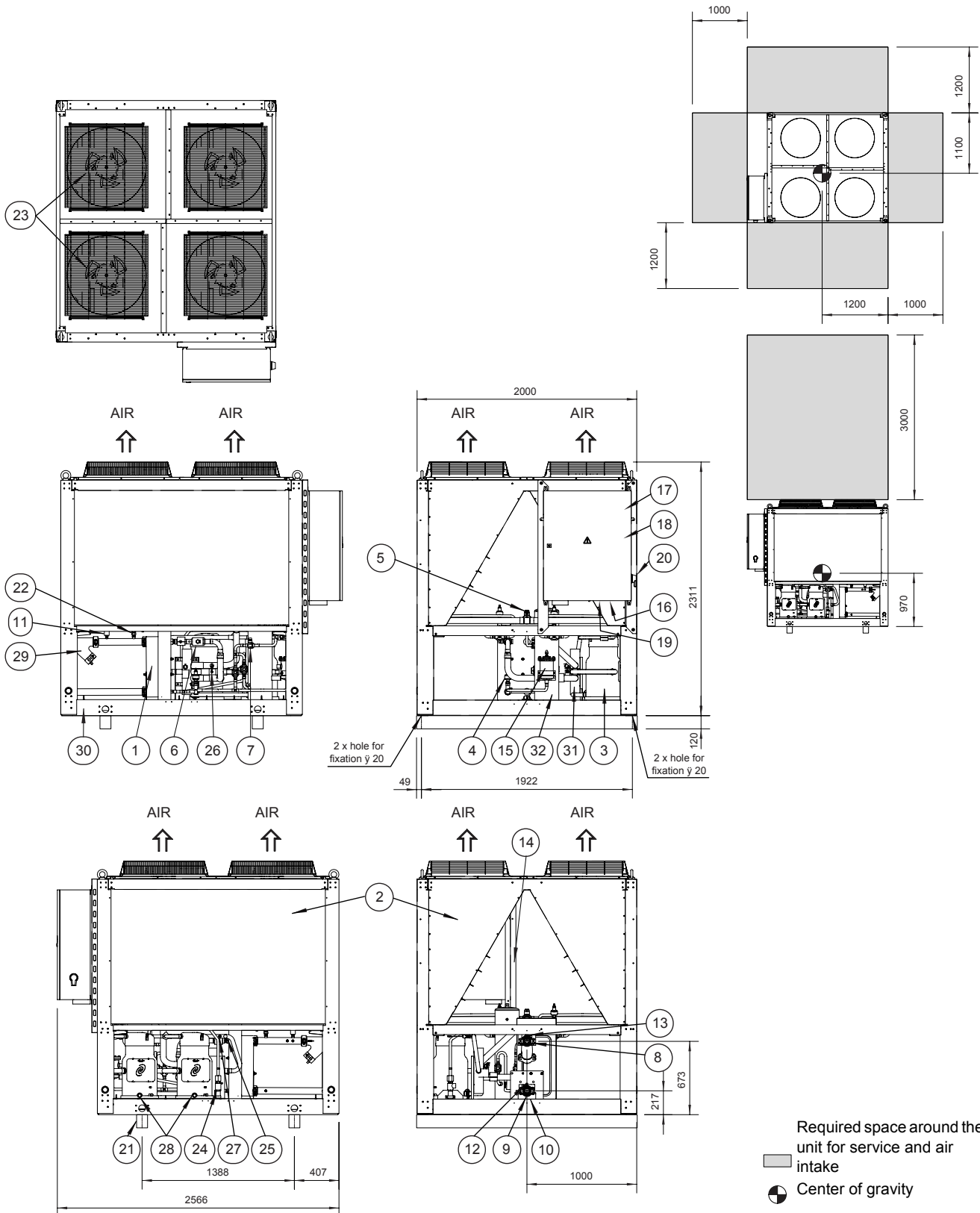

Components

The table below lists the components.

No.	Component
1	Evaporator
2	Condensor
3	Compressor
4	Expansion valve + sight glass
5	Discharge stopvalve (Optional)
6	Suction stopvalve (Optional)
7	Liquid stopvalve (Optional)
8	Chilled water IN (Victaulic coupling)
9	Chilled water OUT (Victaulic coupling)
10	Water drain evaporator
11	Air purge
12	Leaving water temperature sensor
13	Entering water temperature sensor
14	Ambient temperature sensor
15	Drier + charge valve
16	Power supply intake

No.	Component
17	Switchbox
18	Digital display controller (Inside switchbox)
19	Field wiring intake
20	Main isolator switch
21	Transport beam
22	Flowswitch
23	Fan
24	Safety valve
25	High pressure sensor
26	Low pressure sensor
27	High pressure switch
28	Oil sight glass
29	Water filter
30	Frame
31	4-way valve
32	Liquid receiver

1.34 Outlook Drawing: EWYQ080-100DAYN(P-B)

EWYQ080-100DAYN (P-B)

The illustration below shows the outlook, the dimensions and the installation and service space of the unit (mm).

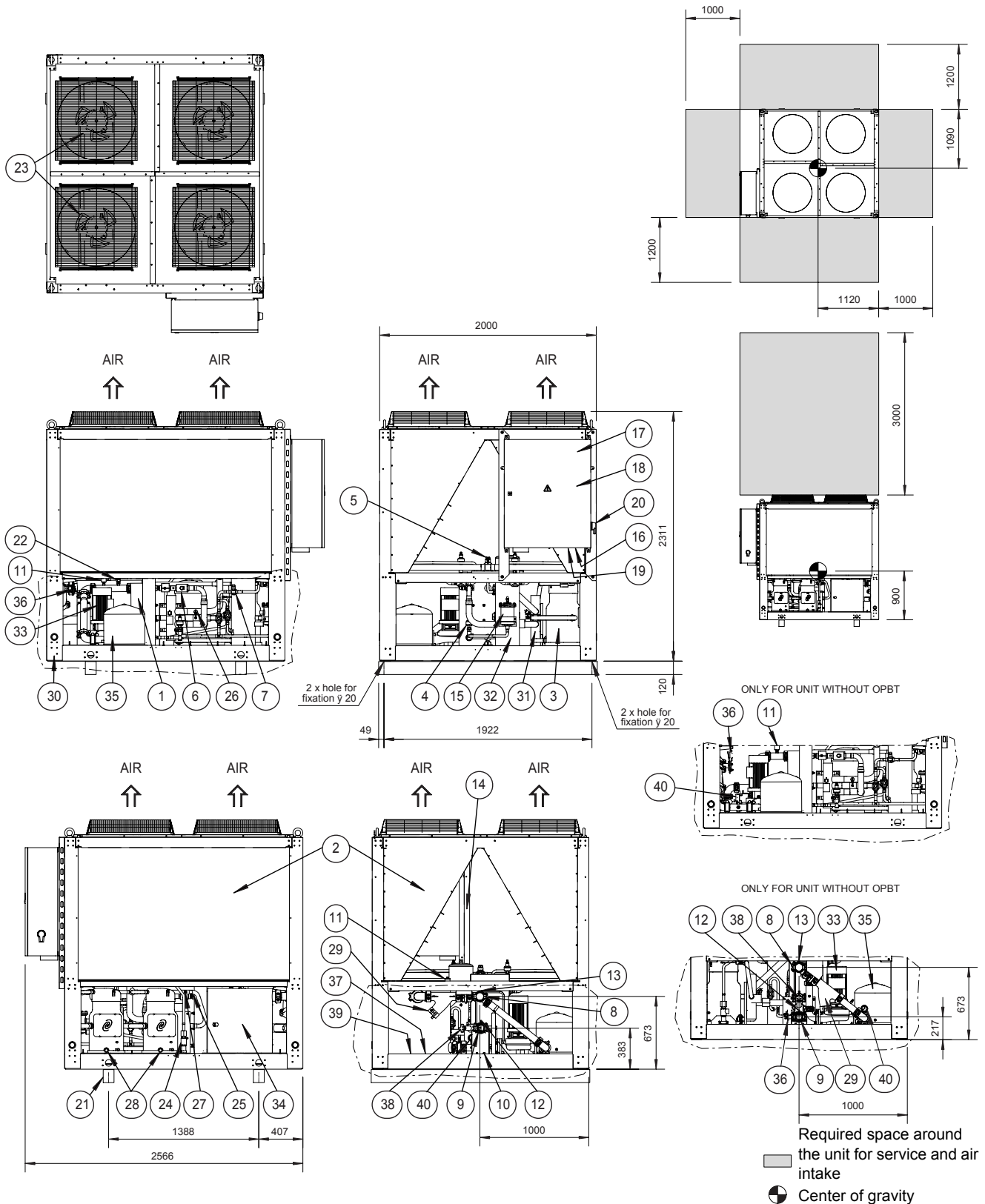

Components

The table below lists the components.

No.	Component
1	Evaporator
2	Condensor
3	Compressor
4	Expansion valve + sight glass
5	Discharge stopvalve (Optional)
6	Suction stopvalve (Optional)
7	Liquid stopvalve (Optional)
8	Chilled water IN (Victaulic coupling)
9	Chilled water OUT (Victaulic coupling)
10	Water drain evaporator
11	Air purge
12	Leaving water temperature sensor
13	Entering water temperature sensor
14	Ambient temperature sensor
15	Drier + charge valve
16	Power supply intake
17	Switchbox
18	Digital display controller (Inside switchbox)
19	Field wiring intake
20	Main isolator switch

No.	Component
21	Transport beam
22	Flowswitch
23	Fan
24	Safety valve
25	High pressure sensor
26	Low pressure sensor
27	High pressure switch
28	Oil sight glass
29	Water filter
30	Frame
31	4-way frame
32	Liquid receiver
33	Pump (Optional)
34	Buffer tank (Optional)
35	Expansion vessel (Optional)
36	Water stopvalve (Optional)
37	Buffer tank drain valve (Optional)
38	Regulating valve (Optional)
39	Water safety valve (Optional)
40	Pressure gauge (Optional)

1.35 Outlook Drawing: EWYQ130-150DAYN(N)

EWYQ130-150DAYN (N)

The illustration below shows the outlook, the dimensions and the installation and service space of the unit (mm).

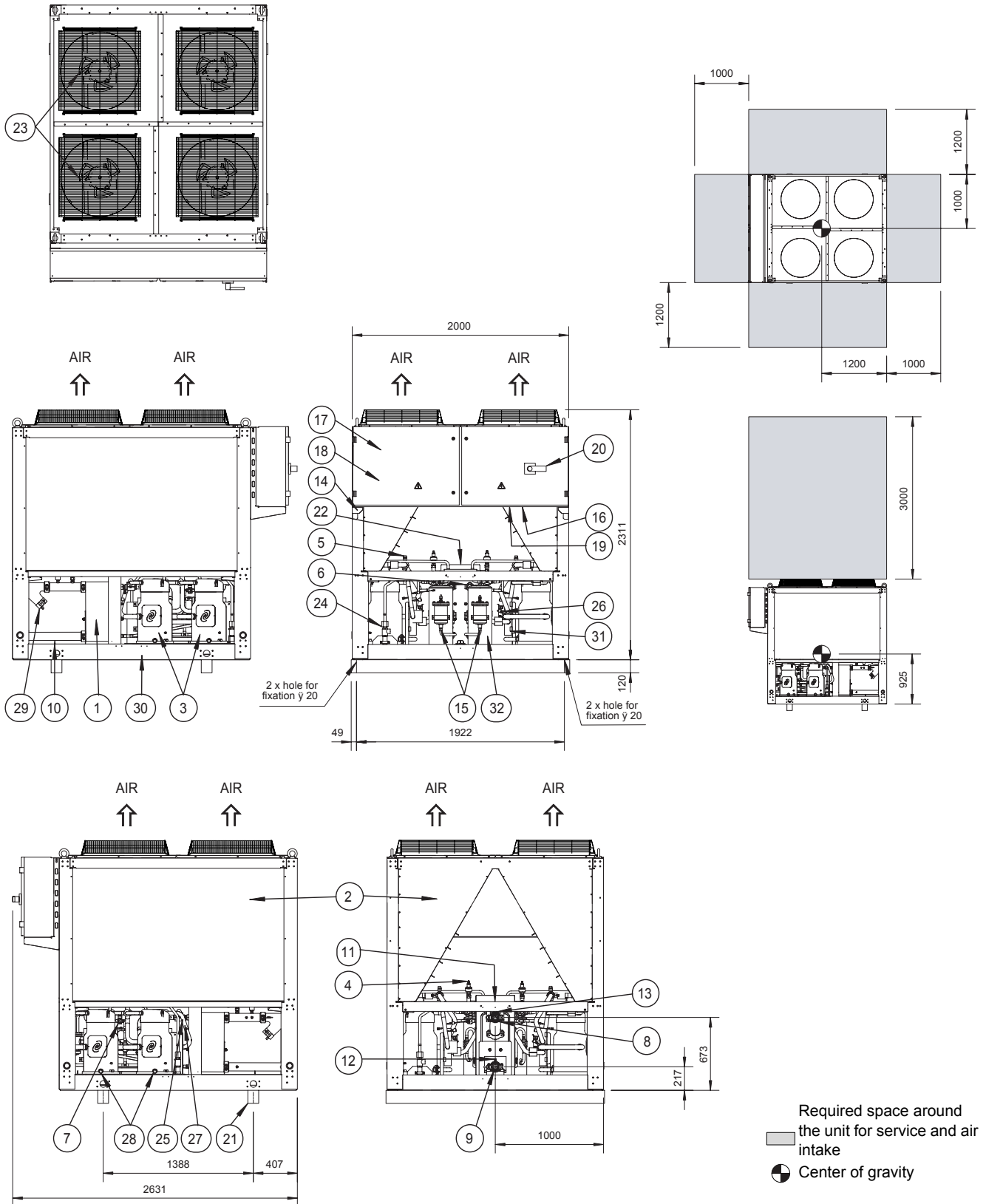

Required space around the unit for service and air intake

Center of gravity

Components

The table below lists the components.

No.	Component
1	Evaporator
2	Condensor
3	Compressor
4	Expansion valve + sight glass
5	Discharge stopvalve (Optional)
6	Suction stopvalve (Optional)
7	Liquid stopvalve (Optional)
8	Chilled water IN (Victaulic coupling)
9	Chilled water OUT (Victaulic coupling)
10	Water drain evaporator
11	Air purge
12	Leaving water temperature sensor
13	Entering water temperature sensor
14	Ambient temperature sensor
15	Drier + charge valve
16	Power supply intake

No.	Component
17	Switchbox
18	Digital display controller (Inside switchbox)
19	Field wiring intake
20	Main isolator switch
21	Transport beam
22	Flowswitch
23	Fan
24	Safety valve
25	High pressure sensor
26	Low pressure sensor
27	High pressure switch
28	Oil sight glass
29	Water filter
30	Frame
31	4-way valve
32	Liquid receiver

1

1.36 Outlook Drawing: EWYQ130-150DAYN(P-B)

EWYQ130-150DAYN (P-B)

The illustration below shows the outlook, the dimensions and the installation and service space of the unit (mm).

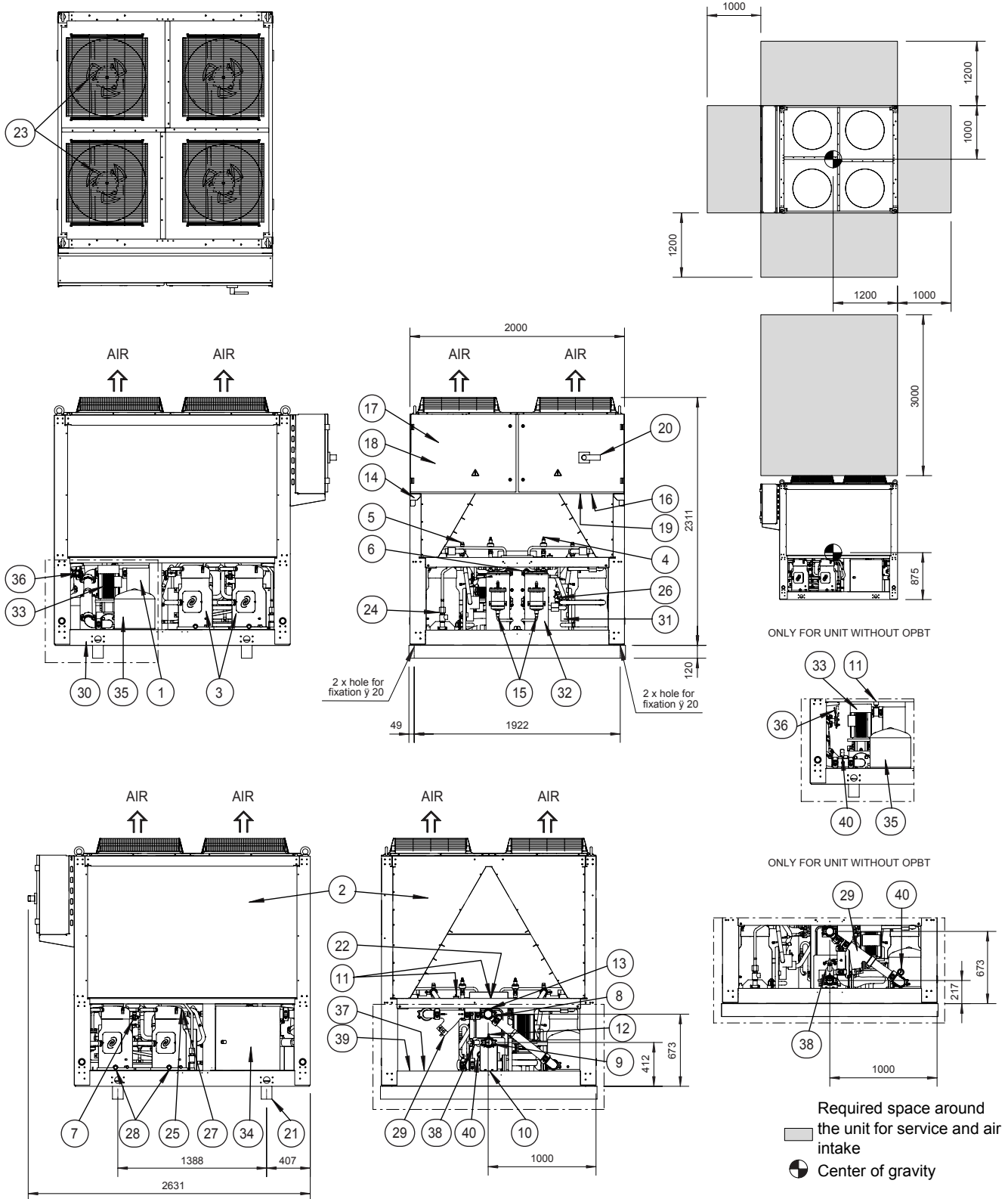

Components

The table below lists the components.

No.	Component
1	Evaporator
2	Condensor
3	Compressor
4	Expansion valve + sight glass
5	Discharge stopvalve (Optional)
6	Suction stopvalve (Optional)
7	Liquid stopvalve (Optional)
8	Chilled water IN (Victaulic coupling)
9	Chilled water OUT (Victaulic coupling)
10	Water drain evaporator
11	Air purge
12	Leaving water temperature sensor
13	Entering water temperature sensor
14	Ambient temperature sensor
15	Drier + charge valve
16	Power supply intake
17	Switchbox
18	Digital display controller (Inside switchbox)
19	Field wiring intake
20	Main isolator switch

No.	Component
21	Transport beam
22	Flowswitch
23	Fan
24	Safety valve
25	High pressure sensor
26	Low pressure sensor
27	High pressure switch
28	Oil sight glass
29	Water filter
30	Frame
31	4-way frame
32	Liquid receiver
33	Pump (Optional)
34	Buffer tank (Optional)
35	Expansion vessel (Optional)
36	Water stopvalve (Optional)
37	Buffer tank drain valve (Optional)
38	Regulating valve (Optional)
39	Water safety valve (Optional)
40	Pressure gauge (Optional)

1.37 Outlook Drawing: EWYQ180-210DAYN(N)

EWYQ180-210DAYN (N)

The illustration below shows the outlook, the dimensions and the installation and service space of the unit (mm).

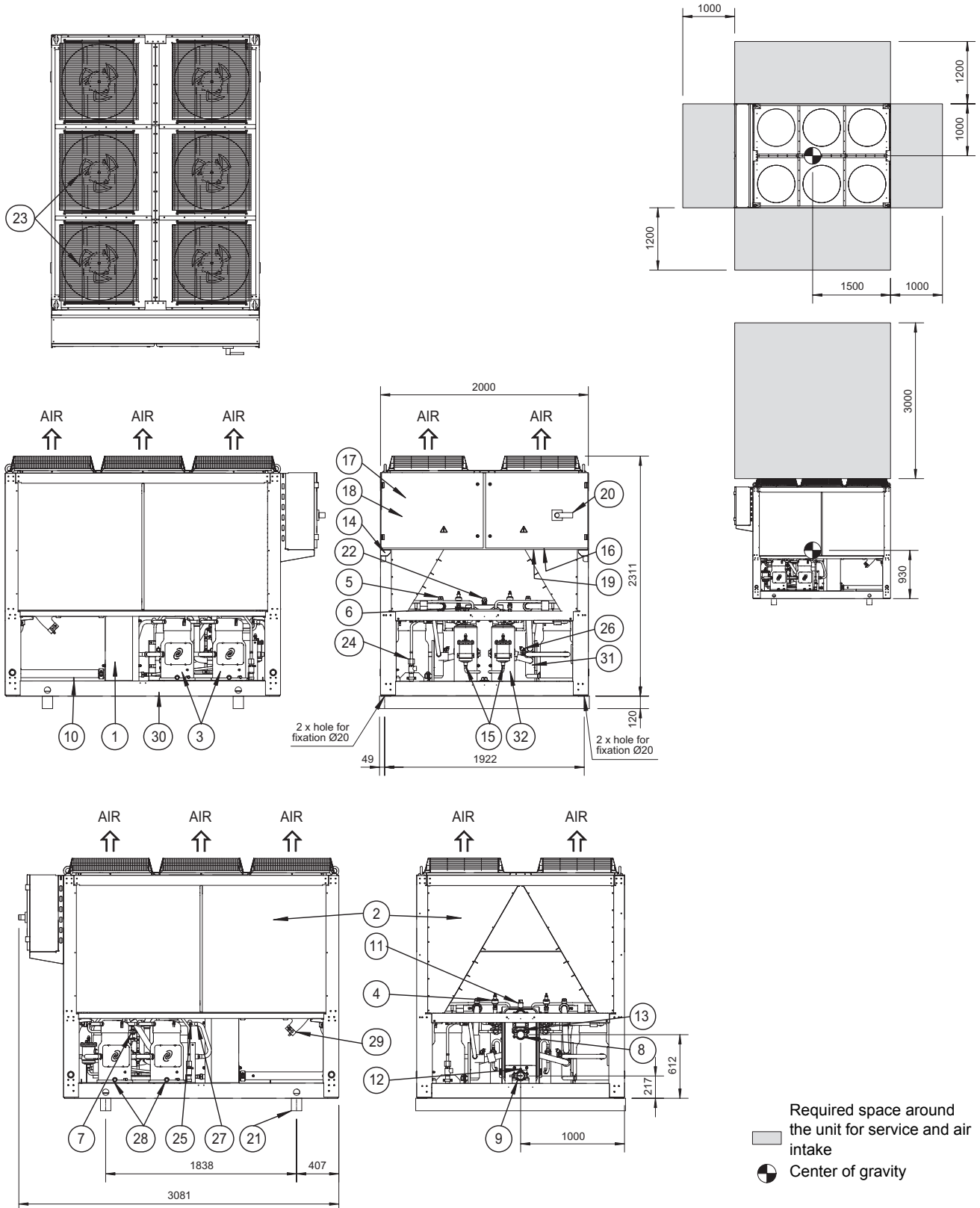

Components

The table below lists the components.

No.	Component
1	Evaporator
2	Condensor
3	Compressor
4	Expansion valve + sight glass
5	Discharge stopvalve (Optional)
6	Suction stopvalve (Optional)
7	Liquid stopvalve (Optional)
8	Chilled water IN (Victaulic coupling)
9	Chilled water OUT (Victaulic coupling)
10	Water drain evaporator
11	Air purge
12	Leaving water temperature sensor
13	Entering water temperature sensor
14	Ambient temperature sensor
15	Drier + charge valve
16	Power supply intake

No.	Component
17	Switchbox
18	Digital display controller (Inside switchbox)
19	Field wiring intake
20	Main isolator switch
21	Transport beam
22	Flowswitch
23	Fan
24	Safety valve
25	High pressure sensor
26	Low pressure sensor
27	High pressure switch
28	Oil sight glass
29	Water filter
30	Frame
31	4-way valve
32	Liquid receiver

1

1.38 Outlook Drawing: EWYQ180-210DAYN(P-B)

EWYQ180-210DAYN (P-B)

The illustration below shows the outlook, the dimensions and the installation and service space of the unit (mm).

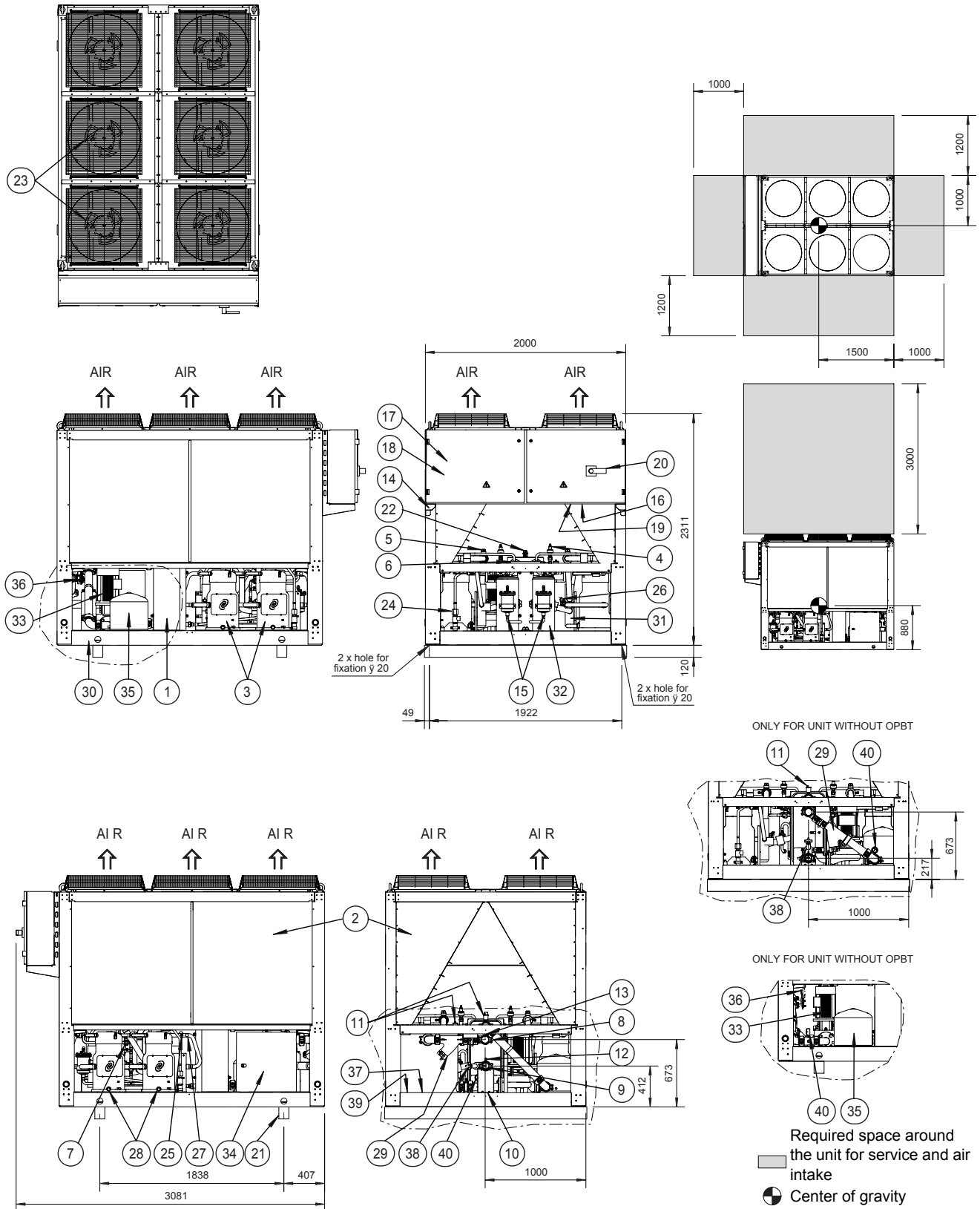

Components

The table below lists the components.

No.	Component
1	Evaporator
2	Condensor
3	Compressor
4	Expansion valve + sight glass
5	Discharge stopvalve (Optional)
6	Suction stopvalve (Optional)
7	Liquid stopvalve (Optional)
8	Chilled water IN (Victaulic coupling)
9	Chilled water OUT (Victaulic coupling)
10	Water drain evaporator
11	Air purge
12	Leaving water temperature sensor
13	Entering water temperature sensor
14	Ambient temperature sensor
15	Drier + charge valve
16	Power supply intake
17	Switchbox
18	Digital display controller (Inside switchbox)
19	Field wiring intake
20	Main isolator switch

No.	Component
21	Transport beam
22	Flowswitch
23	Fan
24	Safety valve
25	High pressure sensor
26	Low pressure sensor
27	High pressure switch
28	Oil sight glass
29	Water filter
30	Frame
31	4-way frame
32	Liquid receiver
33	Pump (Optional)
34	Buffer tank (Optional)
35	Expansion vessel (Optional)
36	Water stopvalve (Optional)
37	Buffer tank drain valve (Optional)
38	Regulating valve (Optional)
39	Water safety valve (Optional)
40	Pressure gauge (Optional)

1

1.39 Outlook Drawing: EWYQ230-250DAYN(N)

EWYQ230-250DAYN (N)

The illustration below shows the outlook, the dimensions and the installation and service space of the unit (mm).

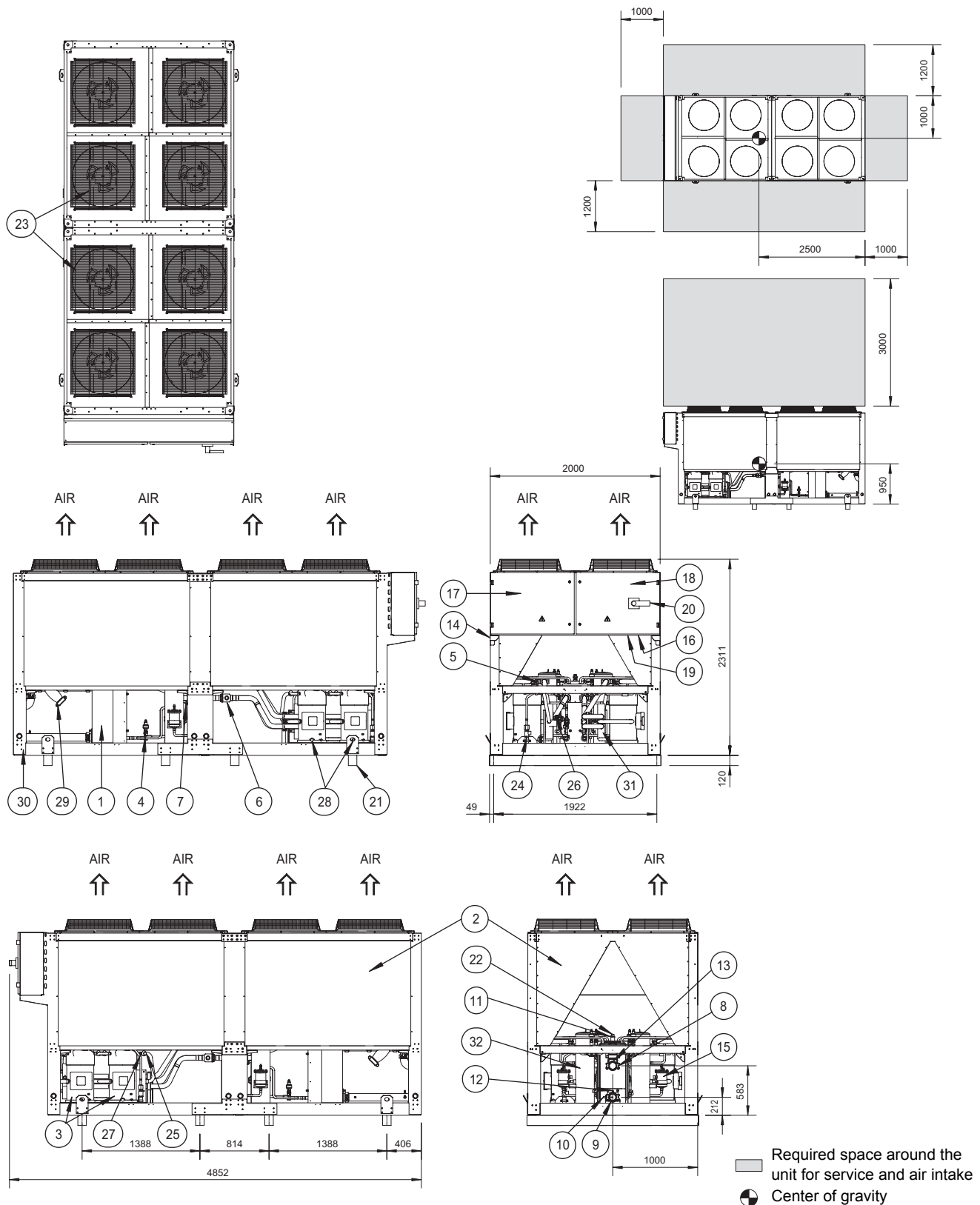

Components

The table below lists the components.

No.	Component
1	Evaporator
2	Condensor
3	Compressor
4	Expansion valve + sight glass
5	Discharge stopvalve (Optional)
6	Suction stopvalve (Optional)
7	Liquid stopvalve (Optional)
8	Chilled water IN (Victaulic coupling)
9	Chilled water OUT (Victaulic coupling)
10	Water drain evaporator
11	Air purge
12	Leaving water temperature sensor
13	Entering water temperature sensor
14	Ambient sensor
15	Drier + charge valve
16	Power supply intake

No.	Component
17	Switchbox
18	Digital display controller (Inside switchbox)
19	Field wiring intake
20	Main isolator switch
21	Transport beam
22	Flowswitch
23	Fan
24	Safety valve
25	High pressure sensor
26	Low pressure sensor
27	High pressure switch
28	Oil sight glass
29	Water filter
30	Frame
31	4-way valve
32	Liquid receiver

1.40 Outlook Drawing: EWYQ230-250DAYN(P-B)

EWYQ230-250DAYN (P-B)

The illustration below shows the outlook, the dimensions and the installation and service space of the unit (mm).

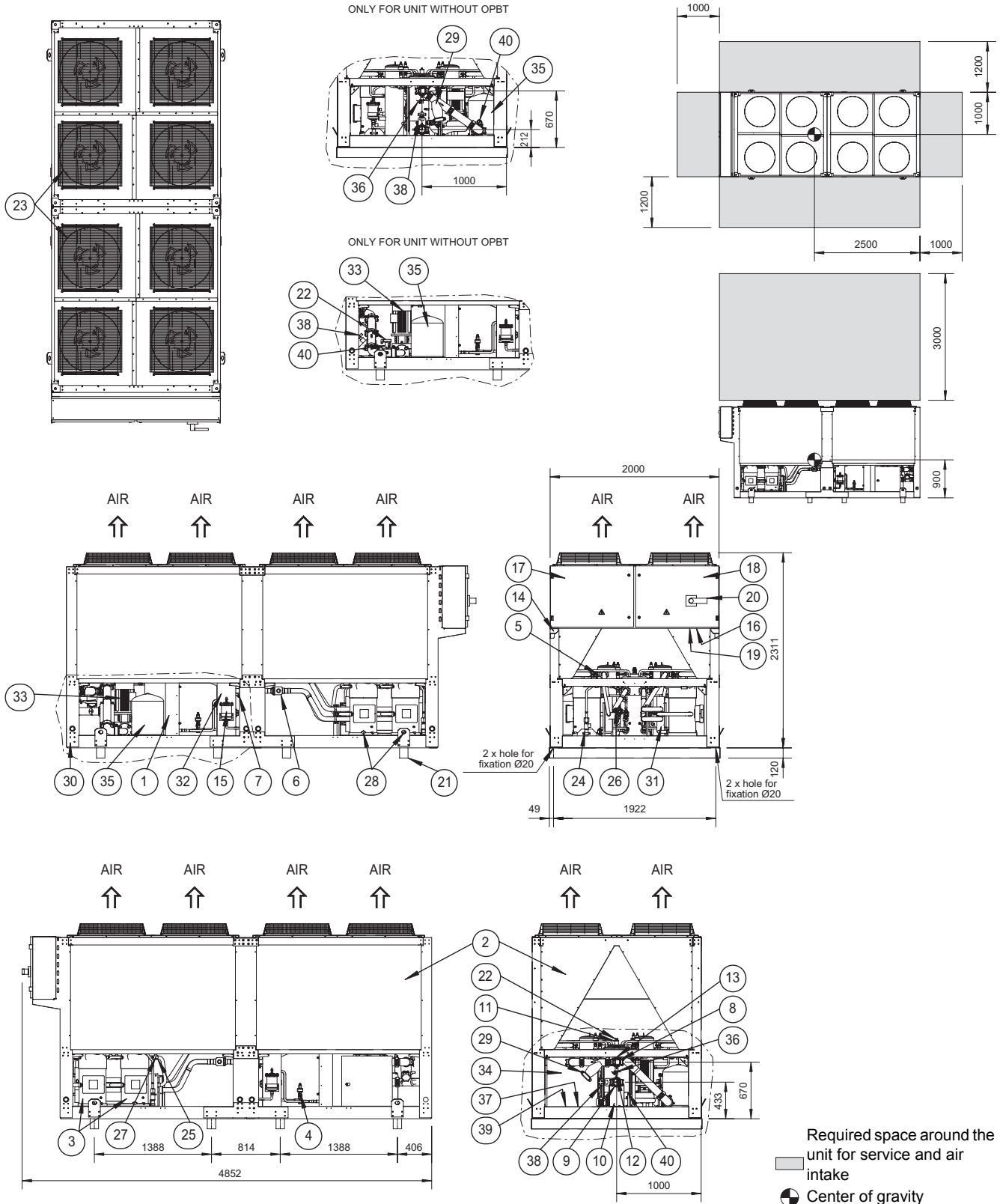

Components

The table below lists the components.

No.	Component
1	Evaporator
2	Condensor
3	Compressor
4	Expansion valve + sight glass
5	Discharge stopvalve (Optional)
6	Suction stopvalve (Optional)
7	Liquid stopvalve (Optional)
8	Chilled water IN (Victaulic coupling)
9	Chilled water OUT (Victaulic coupling)
10	Water drain evaporator
11	Air purge
12	Leaving water temperature sensor
13	Entering water temperature sensor
14	Ambient temperature sensor
15	Drier + charge valve
16	Power supply intake
17	Switchbox
18	Digital display controller (Inside switchbox)
19	Field wiring intake
20	Main isolator switch

No.	Component
21	Transport beam
22	Flowswitch
23	Fan
24	Safety valve
25	High pressure sensor
26	Low pressure sensor
27	High pressure switch
28	Oil sight glass
29	Water filter
30	Frame
31	4-way valve
32	Liquid receiver
33	Pump (Optional)
34	Buffer tank (Optional)
35	Expansion vessel (Optional)
36	Water stopvalve (Optional)
37	Buffer tank drain valve (Optional)
38	Regulating valve (Optional)
39	Water safety valve (Optional)
40	Pressure gauge (Optional)

1

2 Piping Layout

2.1 What Is in This Chapter?

Introduction This chapter describes the internal refrigeration circuit and the water piping, depending on the unit model (N-P-B).

Overview This chapter contains the following topics:

Topic	See page
2.2–Functional Diagram Refrigeration Circuit: EWAQ080-100DAYN(N-P-B)	1–68
2.3–Functional Diagram Refrigeration Circuit: EWAQ130-210DAYN(N-P-B)	1–70
2.4–Functional Diagram Refrigeration Circuit: EWAQ240-260DAYN(N-P-B)	1–72
2.5–Components Refrigeration Side : EWAQ080-260DAYN	1–74
2.6–Functional Diagram Refrigeration Circuit: EWYQ080-100DAYN(N-P-B)	1–76
2.7–Functional Diagram Refrigeration Circuit: EWYQ130-210DAYN(N-P-B)	1–78
2.8–Functional Diagram Refrigeration Circuit: EWYQ230-250DAYN(N-P-B)	1–80
2.9–Components refrigeration side: EWYQ080-250DAYN	1–82
2.10–Functional Diagram Water Piping: EWAQ-EWYQ-DAYN(N-P-B)	1–84
2.11–Components Water Side : EWAQ- EWYQ- DAYN(N-P-B)	1–85



2.2 Functional Diagram Refrigeration Circuit: EWAQ080-100DAYN(N-P-B)

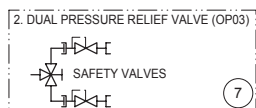
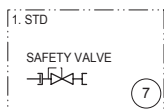
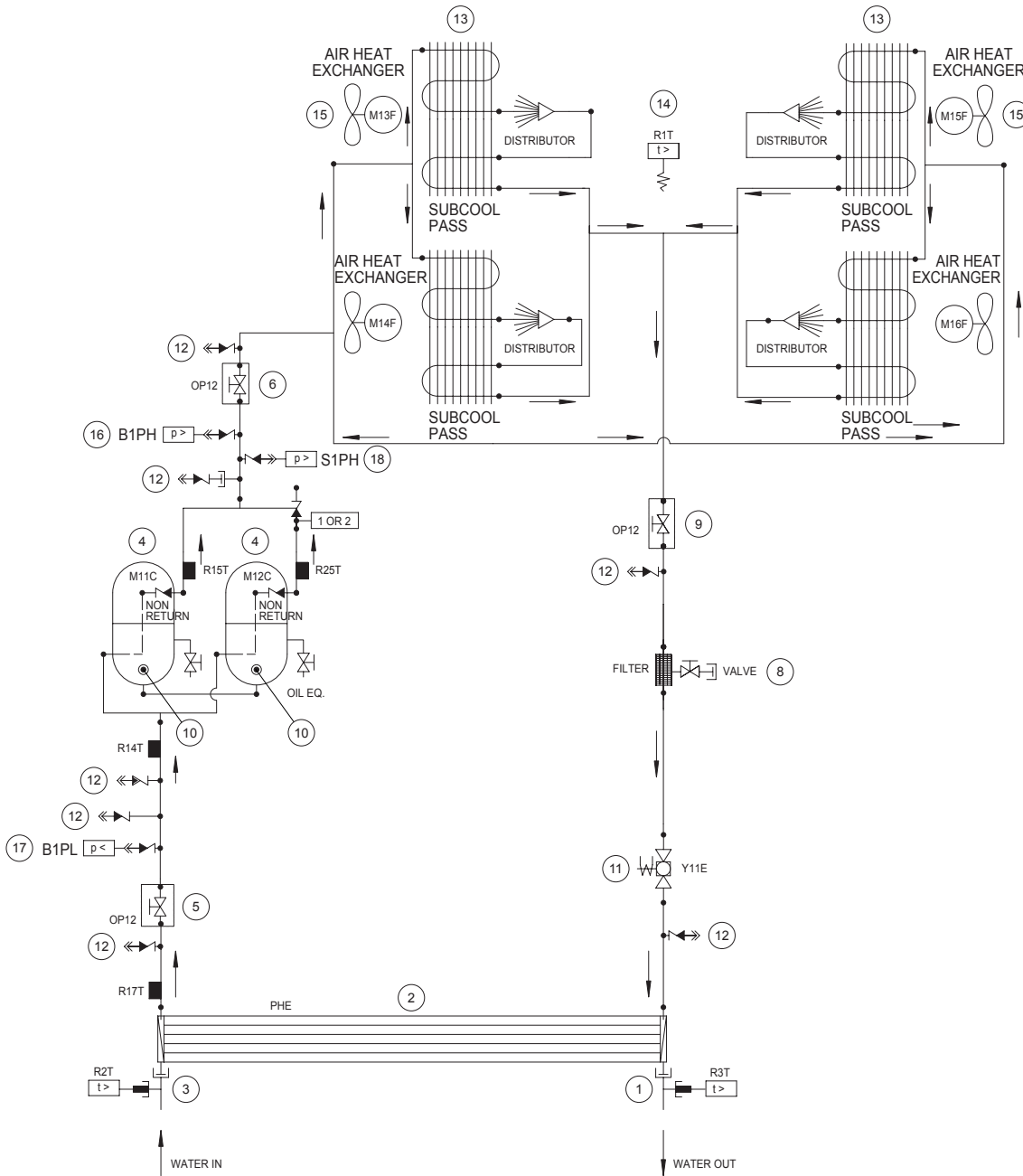

Functional diagram The illustration below shows the functional diagram of the refrigeration circuit of EWAQ080-100DAYN(N-P-B). It is also applicable for glycol applications.



M11-12C	Compressor motors
M13-16F	Fan motors
R14T	Suction temperature sensor
R17T	Refrigerant piping temperature sensor
S1PH	High pressure switch
R15T, R25T	Discharge temperature switch

B1PH	High pressure sensor
B1PL	Low pressure sensor
Y11E	Electronic expansion valve cooling
R1T	Ambient temperature sensor
R2T	Evaporator inlet water temperature sensor
R3T	Evaporator outlet water temperature sensor

-  : Check valve
-  : Flare connection
-  : Screw connection

-  : Flange connection
-  : Pinched pipe
-  : Spinned pipe

1

2.3 Functional Diagram Refrigeration Circuit: EWAQ130-210DAYN(N-P-B)

Functional diagram The illustration below shows the functional diagram of the refrigeration circuit of EWAQ130-210DAYN(N-P-B). It is also applicable for glycol applications.

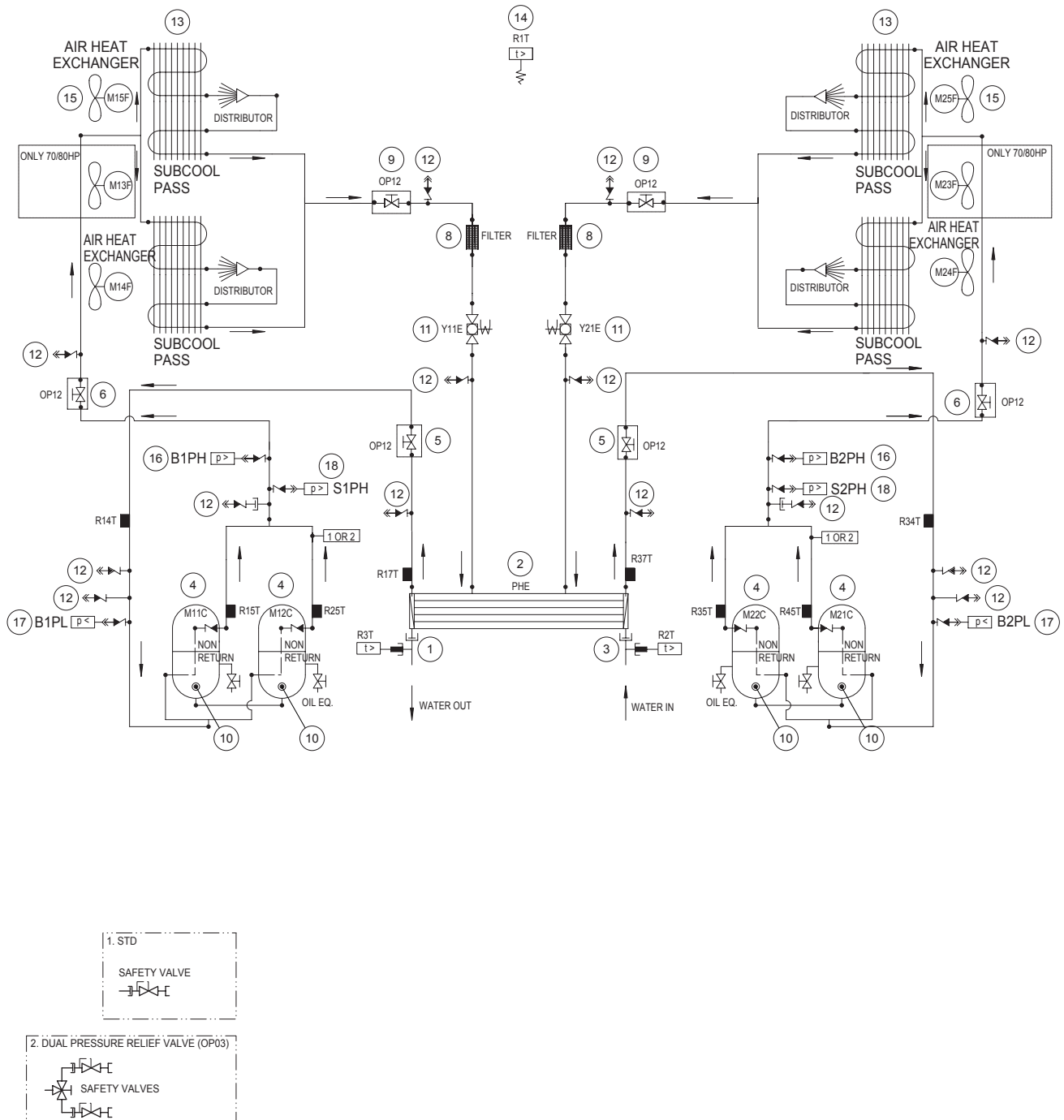

M11-12C	Compressor motors circuit 1
M13-15F	Fan motors circuit 1
R14T	Suction temperature sensor circuit 1
R17T	Refrigerant piping temperature sensor circuit 1
S1PH	High pressure switch circuit 1
R15T, R25T	Discharge temperature sensor circuit 1
B1PH	High pressure sensor circuit 1
B1PL	Low pressure sensor circuit 1
Y11E	Electronic expansion valve cooling circuit 1
M21-22C	Compressor motors circuit 2
M23-25F	Fan motors circuit 2

R34T	Suction temperature sensor circuit 2
R37T	Refrigerant piping temperature sensor circuit 2
S2PH	High pressure switch circuit 2
R35T	Discharge temperature sensor circuit 2
B2PH	High pressure sensor circuit 2
B2PL	Low pressure sensor circuit 2
Y21E	Electronic expansion valve cooling circuit 2
R1T	Ambient temperature sensor
R2T	Evaporator inlet water temperature sensor
R3T	Evaporator outlet water temperature sensor



: Check valve



: Flare connection



: Screw connection



: Flange connection



: Pinched pipe



: Spinned pipe

2.4 Functional Diagram Refrigeration Circuit: EWAQ240-260DAYN(N-P-B)

Functional diagram The illustration below shows the functional diagram of the refrigeration circuit of EWAQ240-260DAYN(N-P-B). It is also applicable for glycol applications.

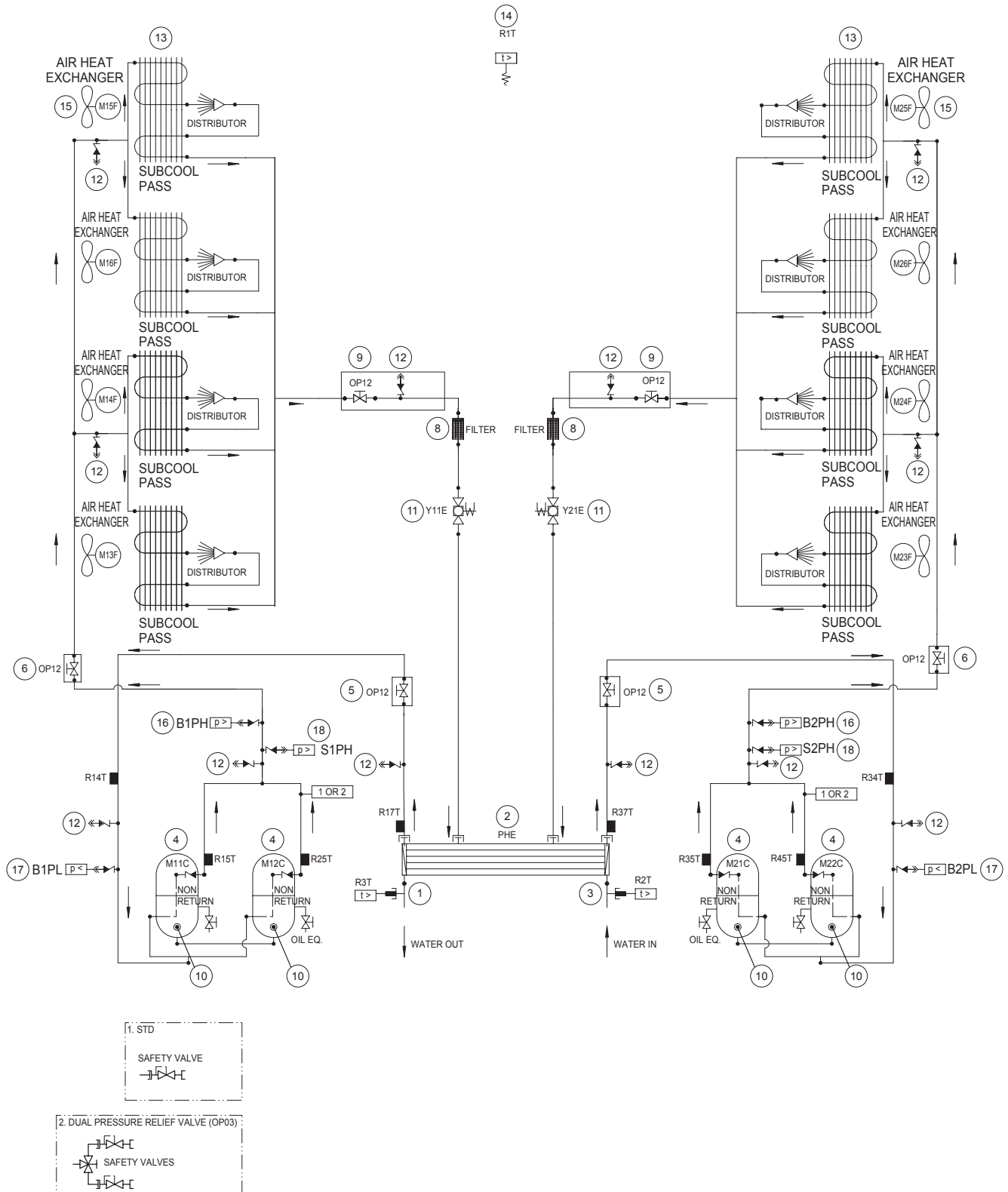

Symbols

The table below describes the symbols.

M11-12C	Compressor motors circuit 1
M13-16F	Fan motors circuit 1
R14T	Suction temperature sensor circuit 1
R17T	Refrigerant piping temperature sensor circuit 1
S1PH	High pressure switch circuit 1
R15T, R25T	Discharge temperature sensor circuit 1
B1PH	High pressure sensor circuit 1
B1PL	Low pressure sensor circuit 1
Y11E	Electronic expansion valve cooling circuit 1
M21-22C	Compressor motors circuit 2
M23-26F	Fan motors circuit 2

R34T	Suction temperature sensor circuit 2
R37T	Refrigerant piping temperature sensor circuit 2
S2PH	High pressure switch circuit 2
R35T	Discharge temperature sensor circuit 2
B2PH	High pressure sensor circuit 2
B2PL	Low pressure sensor circuit 2
Y21E	Electronic expansion valve cooling circuit 2
R1T	Ambient temperature sensor
R2T	Evaporator inlet water temperature sensor
R3T	Evaporator outlet water temperature sensor

- | | | | |
|---|--------------------|---|---------------------|
|  | : Check valve |  | : Flange connection |
|  | : Flare connection |  | : Pinched pipe |
|  | : Screw connection |  | : Spinned pipe |

2.5 Components Refrigeration Side : EWAQ080-260DAYN

Components refrigeration side EWAQ080-260 DAYN

The table below describes the main components of the refrigeration circuit.

1	Water outlet	The water outlet piping connection is delivered with a victaulic joint but without a counter pipe.
2	Evaporator	The water-heat exchanger is of the brazed plate-heat exchanger type.
3	Water inlet	The water inlet piping connection is delivered with a victaulic joint but without a counter pipe.
4	Compressor	A hermetically sealed scroll compressor
5	Suction stop valve (optional)	This suction stop valve can be used in combination with the discharge stop valve to separate the compressors from the system.
6	Discharge stop valve (optional)	This discharge stop valve is used during pump down and service work in combination with the liquid stop valve or suction stop valve if present (optional).
7	Refrigerant circuit safety valve	The safety valve prevents a too high pressure. Activation above 45 bar.
8	Drier/ charge valve	The replaceable filter drier will keep the refrigerant system dry. It is installed behind the condenser and removes small particles from the refrigerant to prevent damage to the compressor and the expansion valve. It is equipped with a 3/8" charge valve.
9	Liquid stop valve (optional)	The liquid stop valve is used as a shut-off valve in case of a pump down.
10	Oil sight glass	An oil sight glass is placed in the compressor to check the oil level of the compressor during operation.
11	Electronic expansion valve + sight glass with moisture indication	The electronic expansion valve is set up to control the superheat between minimum and maximum setpoint. A sight glass with moisture indication is integrated in the expansion valve body and is used to check the refrigerant shortage and/or moisture level in the system.
12	Check valve	Service port.
13	Condenser	The air-heat exchanger is of the cross fin coil type. Hi-X-tubes and PE coated waffle louvre fins are used. The air is discharged upwards.
14	Ambient temperature sensor	The ambient temperature sensor is used to measure the temperature in order to perform some controls.
15	Fan	Direct driven single speed fan or inverter driver fan (only OPIF)
16	High pressure sensor	The high pressure transmitter is used to gain information in order to perform some controls and also to act as safety.
17	Low pressure sensor	The low pressure transmitter is used to gain information in order to perform some controls and also to act as safety.

18	High pressure switch	This switch acts as a circuit safety. <ul style="list-style-type: none">■ Activation at 40,5 bar■ Automatic reset at 30,2 bar
----	----------------------	--

2.6 Functional Diagram Refrigeration Circuit: EWYQ080-100DAYN(N-P-B)

Functional diagram The illustration below shows the functional diagram of the refrigeration circuit of EWYQ080-100DAYN(N-P-B). It is also applicable for glycol applications.

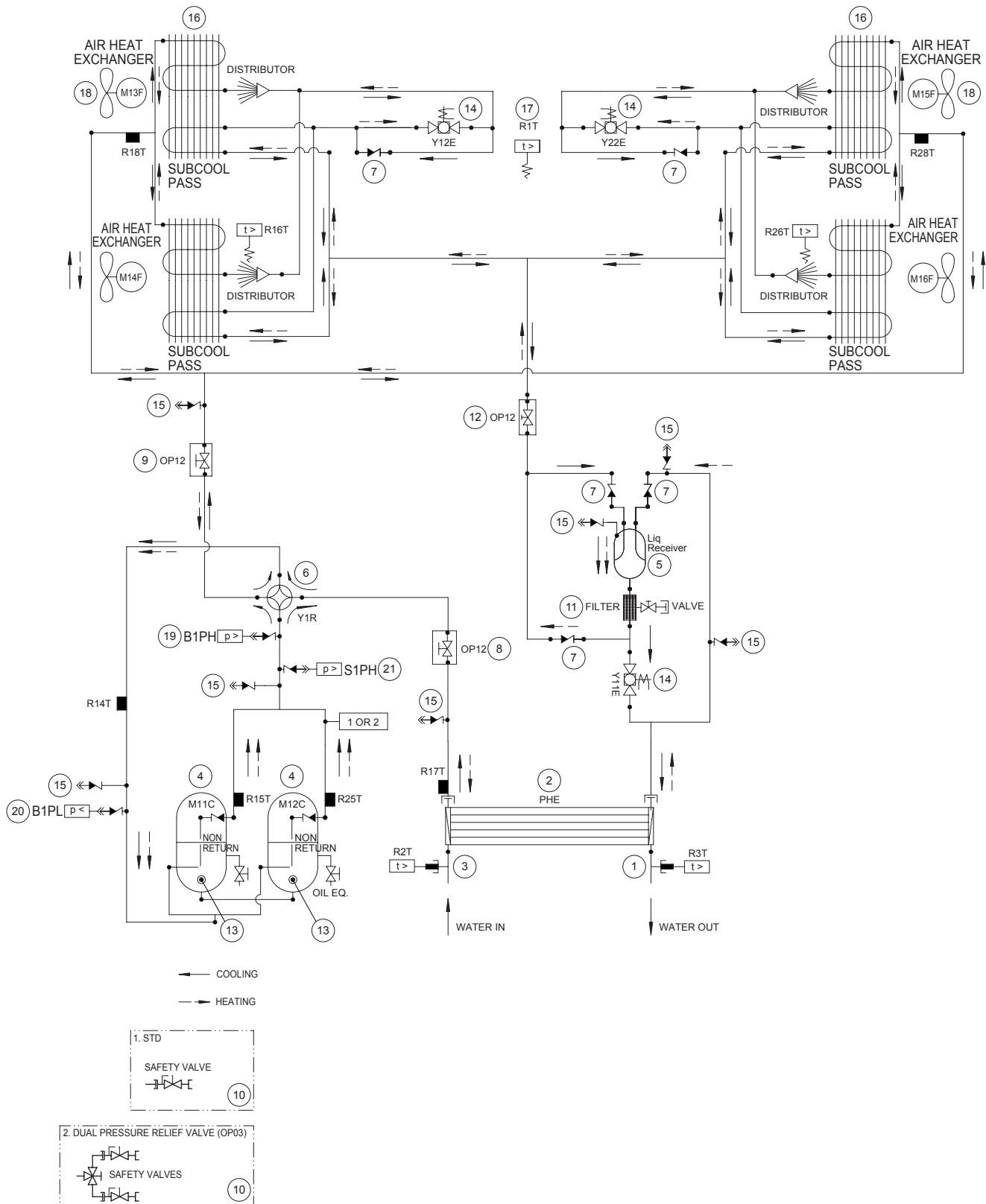

M11-12C	Compressor motors
M13-16F	Fan motors
R14T	Suction temperature sensor
R17T	Refrigerant piping temperature sensor
R18T, R28T	Heating suction piping temperature sensor
R16T, R26T	Coil temperature sensor
S1PH	High pressure switch
Y1R	Reverse valve
R15T, R25T	Discharge temperature sensor

B1PH	High pressure sensor
B1PL	Low pressure sensor
Y11E	Electronic expansion valve cooling
Y12S	Liquid injection valve
Y12E, Y22E	Electronic expansion valve heating coil 1
R1T	Ambient temperature sensor
R2T	Evaporator inlet water temperature sensor
R3T	Evaporator outlet water temperature sensor



: Check valve



: Flare connection



: Screw connection



: Flange connection



: Pinched pipe



: Spinned pipe

1

2.7 Functional Diagram Refrigeration Circuit: EWYQ130-210DAYN(N-P-B)

Functional diagram The illustration below shows the functional diagram of the refrigeration circuit of EWYQ130-210DAYN(N-P-B). It is also applicable for glycol applications.

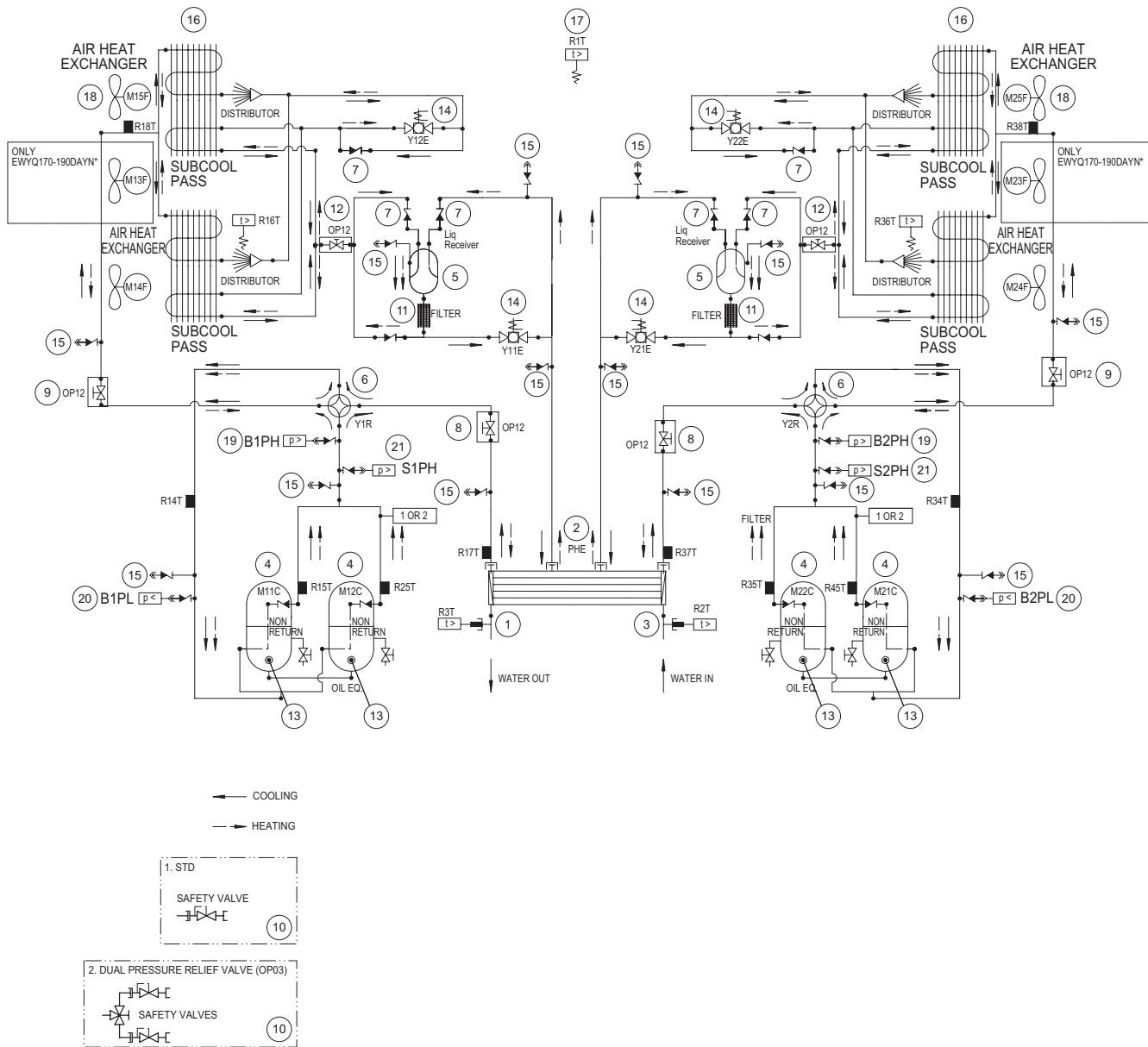

M11-12C	Compressor motors circuit 1
M13-15F	Fan motors circuit 1
R14T	Suction temperature sensor circuit 1
R16T	Coil temperature sensor circuit 1
R17T	Refrigerant piping temperature sensor circuit 1
R18T	Heating suction temp sensor circuit 1
S1PH	High pressure switch circuit 1
Y1R	Reverse valve circuit 1
R15T, R25T	Discharge temperature sensor circuit 1
B1PH	High pressure sensor circuit 1
B1PL	Low pressure sensor circuit 1
Y11E	Electronic expansion valve cooling circuit 1
Y12S	Liquid injection valve circuit 1
Y12E	Electronic expansion valve heating circuit 1
M21-22C	Compressor motors circuit 2
M23-25F	Fan motors circuit 2

R34T	Suction temperature sensor circuit 2
R36T	Coil temperature sensor circuit 2
R37T	Refrigerant piping temperature sensor circuit 2
R38T	Heating suction temp sensor circuit 2
S2PH	High pressure switch circuit 2
Y2R	Reverse valve circuit 2
R35T, R45T	Discharge temperature sensor circuit 2
B2PH	High pressure sensor circuit 2
B2PL	Low pressure sensor circuit 2
Y21E	Electronic expansion valve cooling circuit 2
Y22S	Liquid injection valve circuit 2
Y22E	Electronic expansion valve heating circuit 2
R1T	Ambient temperature sensor
R2T	Evaporator inlet water temperature sensor
R3T	Evaporator outlet water temperature sensor

-  : Check valve
-  : Flare connection
-  : Screw connection
-  : Flange connection
-  : Pinched pipe
-  : Spinned pipe

2.8 Functional Diagram Refrigeration Circuit: EWYQ230-250DAYN(N-P-B)

Functional diagram The illustration below shows the functional diagram of the refrigeration circuit of EWYQ230-250DAYN(N-P-B). It is also applicable for glycol applications.

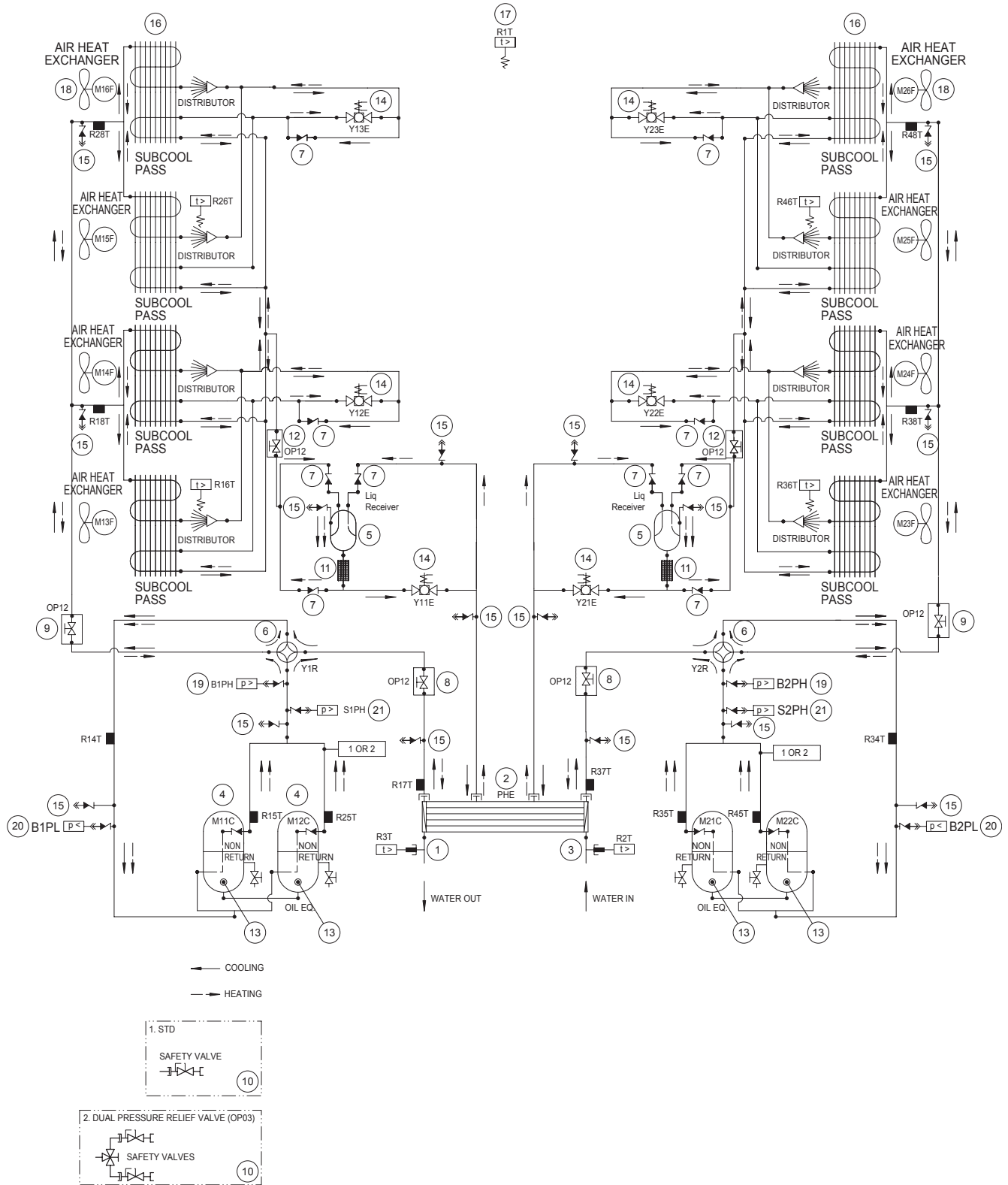

M11-12C	Compressor motors circuit 1
M13-16F	Fan motors circuit 1
R14T	Suction temperature sensor circuit 1
R16T, R26T	Coil temperature sensor circuit 1
R17T	Refrigerant piping temperature sensor circuit 1
S1PH	High pressure switch circuit 1
Y1R	Reverse valve circuit 1
R15T, R25T	Discharge temperature sensor circuit 1
B1PH	High pressure sensor circuit 1
B1PL	Low pressure sensor circuit 1
Y11E	Electronic expansion valve cooling circuit 1
R18T, R28T	Heating suction temperature sensor circuit 1
Y12E, Y13E	Electronic expansion valve heating circuit 1
M21-22C	Compressor motors circuit 2
M23-26F	Fan motors circuit 2

R34T	Suction temperature sensor circuit 2
R36T, R46T	Coil temperature sensor circuit 2
R37T	Refrigerant piping temperature sensor circuit 2
S2PH	High pressure switch circuit 2
Y2R	Reverse valve circuit 2
R35T, R45T	Discharge temperature sensor circuit 2
B2PH	High pressure sensor circuit 2
B2PL	Low pressure sensor circuit 2
Y21E	Electronic expansion valve cooling circuit 2
R38T, R48T	Heating suction temperature sensor circuit 2
Y22E, Y23E	Electronic expansion valve heating circuit 2
R1T	Ambient temperature sensor
R2T	Evaporator inlet water temperature sensor
R3T	Evaporator outlet water temperature sensor

-  : Check valve
-  : Flare connection
-  : Screw connection
-  : Flange connection
-  : Pinched pipe
-  : Spinned pipe

2.9 Components refrigeration side: EWYQ080-250DAYN

Components refrigeration side EWYQ080-250DAY N

The table below describes the main components of the refrigeration circuit.

1	Water outlet	The water outlet piping connection is delivered with a victaulic joint but without a counter pipe.
2	Evaporator	The water-heat exchanger is of the brazed plate-heat exchanger type.
3	Water inlet	The water inlet piping connection is delivered with a victaulic joint but without a counter pipe.
4	Compressor	A hermetically sealed scroll compressor
5	Liquid receiver	The liquid receiver is installed to accumulate the refrigerant.
6	4-way valve	The 4-way valve is used to select cooling or heating.
7	Non-return valve	The non return valve is used to block the refrigerant in one direction.
8	Suction stop valve (optional)	This suction stop valve can be used in combination with the discharge stop valve to separate the compressors from the system.
9	Discharge stop valve (optional)	This stop valve is used during pump down and service work in combination with the liquid stop valve or suction stop valve if present (optional).
10	Refrigerant circuit safety valve	The safety valve prevents a too high pressure. Activation above 45 bar.
11	Drier/ charge valve	The replaceable filter drier will keep the refrigerant system dry. It is installed behind the condenser and removes small particles from the refrigerant to prevent damage to the compressor and the expansion valve. It is equipped with a 3/8" charge valve.
12	Liquid stop valve (optional)	The liquid stop valve is used as a shut-off valve in case of a pump down.
13	Oil sight glass	An oil sight glass is placed in the compressor to check the oil level of the compressor during operation.
14	Electronic expansion valve + sight glass with moisture indication	The electronic expansion valve is set up to control the superheat between minimum and maximum setpoint. A sight glass with moisture indication is integrated in the expansion valve body and is used to check the refrigerant shortage and/or moisture level in the system.
15	Check valve	Service port
16	Condenser	The air-heat exchanger is of the cross fin coil type. Hi-X-tubes and PE coated waffle louvre fins are used. The air is discharged upwards.
17	Ambient temperature sensor	The ambient temperature sensor is used to measure the temperature in order to perform some controls.
18	Fan	Direct driven single speed fan or inverter driver fan (only OPIF)

19	High pressure sensor	The high pressure transmitter is used to gain information in order to perform some controls and also to act as safety.
20	Low pressure sensor	The low pressure transmitter is used to gain information in order to perform some controls and also to act as safety.
21	High pressure switch	This switch acts as a circuit safety. <ul style="list-style-type: none">■ Activation at 40,5 bar■ Automatic reset at 30,2 bar



1

2.10 Functional Diagram Water Piping: EWAQ-EWYQ-DAYN(N-P-B)

Water piping diagram

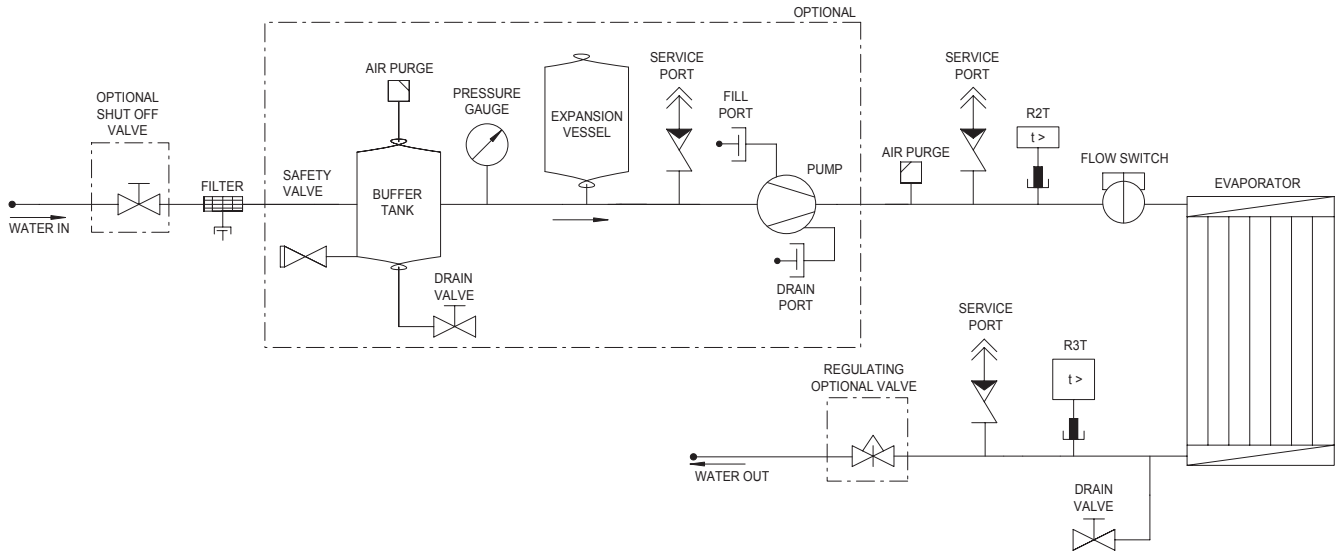
The illustration below shows the functional diagram of the water piping of the EWAQ080~260DAYN(N-P-B) and EWYQ080~250DAYN(N-P-B).



-  : Check valve
-  : Screw connection
-  : Flange connection

2.11 Components Water Side : EWAQ- EWYQ- DAYN(N-P-B)

Components water piping side

The table below describes the main components of the water piping.

1	Flow switch	The mechanical flow switch is used to check if there is flow or enough water flow.
2	Service port	The service port can be used to connect a pressure gauge.
3	Drain valve	The drain valve can be used to drain water from the water circuit.
4	Regulating valve	The pressure regulating valve is used to regulate the water flow on the water side (option).
5	Pump	The single or double pump circulates the water (depending on the option).
6	Fill port on the pump	The fill port can be used to fill the water circuit.
7	Drain port on the pump	The drain port can be used to drain water from the water circuit.
8	Expansion vessel	The expansion vessel deals with water expansion, which occurs when the temperature of the water varies.
9	Pressure gauge	Pressure gauge to check the water pressure
10	Air purge	To purge the water circuit, to prevent air in the water circuit.
11	Buffer tank	This buffer tank is used to store water in order to prevent the compressor from switching ON/OFF continuously depending on the load.
12	Filter	This strainer prevents dirt particles from entering the evaporator. A filter with 1mm mesh is used.
13	Shut off valve	Makes it possible to shut-off a part of the water piping for maintenance (e.g. to change a filter).
14	Water circuit safety valve	The safety valve prevents a too high pressure. Activation above 3 bar.
15	Inlet water sensor R2T	The water temperature sensor is used to control the thermostat function at the heat exchanger inlet.
16	Outlet water sensor R3T	This protection device shuts down the circuit when the temperature of the chilled water becomes too low in order to prevent the water from freezing during operation and is also used to control the thermostat function at the heat exchanger outlet.

1

3 Wiring Layout

3.1 What Is in This Chapter?

Introduction This part gives a general overview of the wiring layout.

Overview This chapter contains the following topics:

Topic	See page
3.2–Wiring Layout : EWAQ080-100DAYN(N-P-B) and EWYQ080-100DAYN(N-P-B) Standard Unit	1–88
3.3–Wiring Layout : EWAQ130-260DAYN(N-P-B) and EWYQ130-250DAYN(N-P-B) Standard Unit	1–116
3.4–Wiring layout: EWAQ080-100DAYN(N-P-B) and EWYQ080-100DAYN(N-P-B) with OPIF	1–149
3.5–Wiring Layout : EWAQ130-260DAYN(N-P-B) and EWYQ130-250DAYN(N-P-B) with OPIF	1–177





3.2 Wiring Layout : EWAQ080-100DAYN(N-P-B) and EWYQ080-100DAYN(N-P-B) Standard Unit

Introduction This chapter gives a general overview of the PCB interconnection, I/O overview, switchbox outlook and wiring of the EWAQ080-100DAYN(N-P-B) and EWYQ080-100DAYN(N-P-B) standard units.

Overview This chapter contains the following topics:

Page description	Page
3.2.1 Notes	1–89
3.2.2 Legend	1–91
3.2.3 PCB interconnection diagram	1–96
3.2.4 PCB I/O overview & fuses	1–97
3.2.5 PCB changeable I/O overview	1–101
3.2.6 Unit outlook	1–102
3.2.7 Switchbox outlook (typical)	1–103
3.2.8 Main power supply	1–104
3.2.9 Trafo & PCB power supply	1–105
3.2.10 Compressor & fan	1–106
3.2.11 Circuit 1: control compressors	1–107
3.2.12 Circuit 1: control fans	1–108
3.2.13 Control circuit (DI 230V)	1–109
3.2.14 Control circuit and EEV	1–110
3.2.15 Circuit 1: sensors	1–111
3.2.16 Field wiring DI, changeable DI	1–112
3.2.17 Field wiring changeable AI/AO	1–113
3.2.18 Field wiring DO, changeable DO	1–114

3.2.1 Notes

- L1, L2, L3 : Main terminals
 - 1-99 : Field wiring terminals
 - 100-199 : Factory upwiring terminals
 - 200- : Internal wiring terminals
 - U-Z : Main terminals in compressor switchbox
 - _____ : Earth wiring
 - 15 : Wire number 15
 - ⊕15 : Terminal number 15
 - : Field supply
 -  : Option
 -  : Not mounted in switchbox
 -  : Wiring depending on model
 -  : PCB
 - **/12.2 : Connection ** continues on page 12 column 2
 - ! : Pin against miswiring
 - ① : Several wiring possibilities
 - N-model : unit with no options included
- Y1R, Y2R reversing valves are activated in cooling mode.

1

Factory installed:	<input type="checkbox"/>	OP10	= Heater tape
	<input type="checkbox"/>	OP57	= A-meter, V-meter
	<input type="checkbox"/>	OPLN	= Low noise (OPIF+ Compressor housing)
	<input type="checkbox"/>	OPTP	= Twinpump
	<input type="checkbox"/>	OPSC	= Single pump contactor
	<input type="checkbox"/>	OPTC	= Twin pump contactor
	<input type="checkbox"/>	OPIF	= Inverter fans for low ambient (-15°C)
	<input type="checkbox"/>	OPHP	= Hi ESP pump
	<input type="checkbox"/>	OPSP	= Single pump
	<input type="checkbox"/>	OPBT	= Buffer tank
User installed:	<input type="checkbox"/>	EKACPG	= Address card including: -RS485 (Integrated modbus) -F1, F2 (DICN + DBACS Connection)
	<input type="checkbox"/>	EKRUPG	Remote used interface
Definitions:			
	DI:	Digital input	
	DO:	Digital output	
	AI:	Analog input	
	AO:	Analog output	
	Ch:	Changeable (function can be selected by the customer)	

3.2.2 Legend

	Not included with standard unit	
	Not possible as option	Possible as option
Obligatory	#	##
Not obligatory	*	**

Part number		Description
A01P		PCB Extension
A02P	**	PCB Communication (EKACPG)
A4P		PCB wired remote controller
A5P	**	PCB wired remote controller (EKRUPG)
A11P, A21P		PCB main controller circuit 1, circuit 2
A13P, A23P	**	frequency inverter circuit 1, circuit 2 (OPIF)
A71P		PCB EEV driver
A72P		PCB EEV driver (only for EWYQ)
A73P		PCB EEV driver (only for EWYQ230-250)
B1PH, B2PH		high pressure sensor circuit 1, circuit 2
B1PL, B2PL		low pressure sensor circuit 1, circuit 2
DS1 (A*P)		PCB dipswitch
E1HS	**	switchbox heater with fan (OPIF) (only for EWAQ130-260 / EWYQ130-250)
E3H	**	heatertape (OP10)
E4H	**	heatertape (OP10) (only for OPSP/OPHP/OPTP)
E5H	*	field heater
E6H	**	buffer tank heater (OP10) (only for OPBT)
E7H	**	switchbox heater (OPIF) (only for EWA/YQ80-100)
E11HC, E12HC		crankcase heater compressor circuit 1
E21HC, E22HC		crankcase heater compressor circuit 2
F1-F3	#	main fuses
F1U (A*P)		fuse PCB
F4, F5	#	fuses for heaters
F6B		autofuse for primary of TR1
F8B	**	autofuse for switchbox heater (OPIF)
F9B		autofuse for secondary of TR2

1

Part number		Description
F11B, F12B		autofuse for compressors (M11C, M12C,) (Not for EWA/YQ80-100)
F14B, F24B		autofuse for fan motors circuit 1, circuit 2
F15B, F25B	**	autofuse for fan motors circuit 1, circuit 2 (OPIF)
F16B	**	autofuse for pump (K1P) (Only for OPSP/ OPHP/ OPSC/ OPTP/OPTC)
F17B	**	autofuse for pump (K2P) (only for OPTP/OPTC)
F21B, F22B		autofuse for compressors (M21C, M22C)
H1-6P	*	indication lamp for changeable digital outputs
H11P, H12P	*	indication lamp for operation compressor circuit 1 (M11C, M12C)
H21p, H22P	*	indication lamp for operation compressor circuit 2 (M21C, M22C)
HAP-HEP (A*P)		light emitting diode PCB
K1A, K2A		auxiliary relay for compressor safety circuit 1, circuit 2
K1P	##	pump contactor (only for OPSP/ OPHP/OPSC/OPTP/OPTC)
K1S	*	overcurrent relay pump
K1R-K22R (A*P)		PCB relay
K2P	**	pump contactor (only for OPTP/ OPTC)
K3A		auxiliary relay for heater tape
K11M, K12M		compressor contactor for circuit 1
K13F, K14F		fan contactor for circuit 1
K13S, K14S		fan overcurrent relay for circuit 1
K15F		fan contactor for circuit 1 (Only for EWAQ80-100/180-210/240-260) (Only for EWYQ80-100/180-210/230-250)
K15S		fan overcurrent relay for circuit 1 (Only for EWAQ80-100/180-210/240-260) (Only for EWYQ80-100/180-210/230-250)
K16F		fan contactor for circuit 1 (Only for EWAQ80-100/240-260) (Only for EWYQ80-100/230-250)
K16S		fan overcurrent relay for circuit 1 (Only for EWAQ80-100/240-260) (Only for EWYQ80-100/230-250)
K21M, K22M		compressor contactor for circuit 2
K23F, K24F		fan contactor for circuit 2
K23S, K24S		fan overcurrent relay for circuit 2
K25F		fan contactor for circuit 2 (Only for EWAQ180-210/240-260) (Only for EWYQ180-210/230-250)

Part number		Description
K25S		fan overcurrent relay for circuit 2 (Only for EWAQ180-210/240-260) (Only for EWYQ180-210/230-250)
K26F		fan contactor for circuit 2 (Only for EWAQ/240-260) (Only for EWYQ230-250)
K26S		fan overcurrent relay for circuit 2 (Only for EWAQ/240-260) (Only for EWYQ230-250)
M1P	**	pump motor 1 (only for OPSP/ OPHP/OPSC/OPTC)
M2P	**	pump motor 2 (only for OPTP/OPTC)
M11C, M12C		compressor motors circuit 1
M13F, M14F		fan motors circuit 1
M15F		fan motors circuit 1 (Only for EWAQ80-100/180-210/240-260) (Only for EWYQ80-100/180-210/230-250)
M16F		fan motors circuit 1 (Only for EWAQ80-100/240-260) (Only for EWYQ80-100/230-250)
M21C, M22C		compressor motors circuit 2
M23F, M24F		fan motors circuit 2
M25F		fan motors circuit 2 (Only for EWAQ180-210/240-260) (Only for EWYQ180-210/230-250)
M26F		fan motors circuit 2 (Only for EWAQ240-260) (Only for EWYQ230-250)
M1F		switchbox fanmotor
Q1T	**	thermostat (OP10)
Q11C, Q12C		For EWAQ130/EWYQ130: thermal protector compressor circuit 1 For EWAQ80-100/150/180-210/240-260: For EWYQ80-100/150/180-210/230-250: electronic protection module compressor circuit 1
Q21C, Q22C		For EWAQ130/EWYQ130: thermal protector compressor circuit 2 For EWAQ150/180-210/240-260: For EWYQ150/180-210/230-250: electronic protection module compressor circuit 2

1

Part number		Description
R1T		ambient temperature sensor
R2T		inlet water temperature sensor
R3T		outlet water temperature sensor
R8T	*	temperature sensor for changeable analog input
R14T		suction temperature sensor circuit 1
R15T, R25T		discharge temperature sensor circuit 1
R16T		coil temperature sensor circuit 1 (only for EWYQ)
R17T		refrigerant piping temperature sensor circuit 1
R18T, R38T		heating suction temperature sensor circuit 1, circuit 2 (only EWYQ)
R28T, R48T		heating suction temperature sensor circuit 1, circuit 2 (only EWYQ80-100/230-250)
R26T		coil temperature sensor circuit 1(only for EQWYQ80-100/230-250)
R34T		suction temperature sensor circuit 2
R35T, R45T		discharge temperature sensor circuit 2
R36T		coil temperature sensor circuit 2 (only for EWYQ)
R37T		refrigerant piping temperature sensor circuit 2
R46T		coil temperature sensor circuit 2 (only for EWYQ230-250)
S1A-S3A (A*P)		PCB dipswitch
S1L		flowswitch
S1M		main isolator switch
S1PH, S2PH		high pressure switch circuit 1, circuit 2
S1S-S5S	*	switch for changeable digital input (remote on/off, C/H, ...)
S1T	**	thermal contact (OPIF)
S2M	#	heater tape isolator switch
T1A	**	current transducer (OP57)
T1V	**	voltage transducer (OP57)
TR1		transfo control circuit (400V/230V)
TR1A	**	current measurement transfo (OP57)
V1C		Ferrite core
V1F, V2F	**	noise filter circuit 1, circuit 2 (OPIF) (Only for EWAQ130-150/180-210) (Only for EWYQ130-150/180-210)
V2C	**	Ferrite core (EKACPG)
X*A (A*P)		PCB terminal
X*Y		connector
X1M (A*P)		PCB terminal strip

Part number	Description
Y1R, Y2R	reverse valve circuit 1, circuit 2 (only EWYQ)
Y11E	electronic expansion valve cooling circuit 1
Y12E	electronic expansion valve heating circuit 1 (only EWYQ)
Y13E	electronic expansion valve heating circuit 1 (only EWYQ80-100/ 230-250)
Y21E	electronic expansion valve cooling circuit 2
Y22E	electronic expansion valve heating circuit 2 (only EWYQ)
Y23E	electronic expansion valve heating circuit 2 (only EWYQ230-250)

3.2.3 PCB interconnection diagram

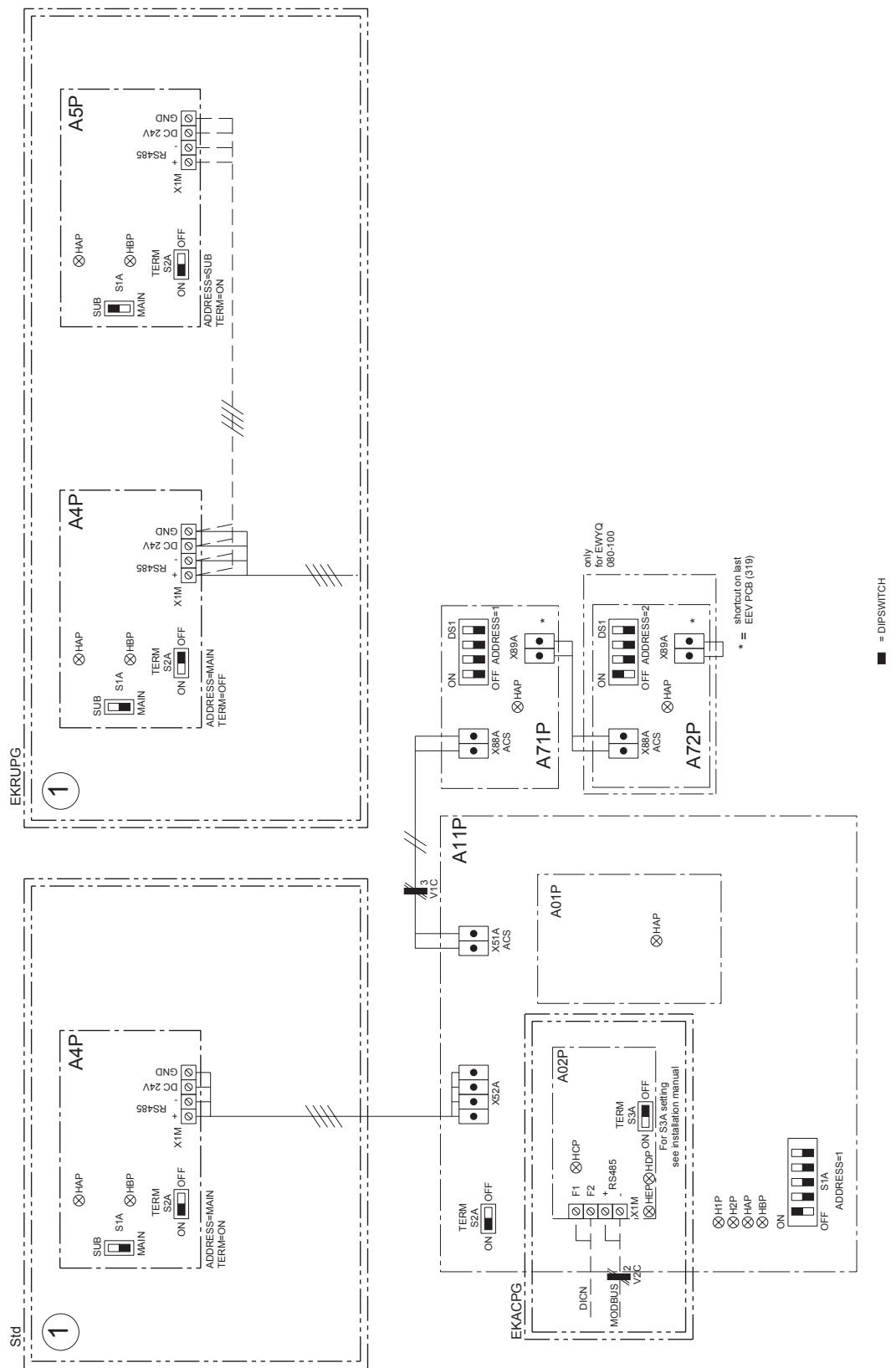

3.2.4 PCB I/O overview & fuses

Main PCB (A11P)	
X12A (1-3-5)	DI: Reverse phase detection (L1-L2-L3) c1
X4A	DI: High pressure switch c1
X5A	DI: Compressor interlock 1 c1
X6A	DI: Compressor interlock 2 c2
X7A	DI: Fan overcurrent relay Fanstep 1 c1
X8A	DI: Fan overcurrent relay Fanstep 2 c1
X9A	DI: Fan overcurrent relay Fanstep 3 c1
X27A	not used
X29A (3-4)	not used
X30A	DI: Flow switch
X31A	DI: Pump interlock
X32A (3-4)	Ch DI 1: function not pre-defined
X32A (1-2)	Ch DI 2: function not pre-defined
X13A	DO: Compressor contactor 1 c1
X14A	DO: Compressor contactor 2 c1
X15A	DO: Heatertape
X16A	DO: Pump contactor
X17A	DO: Reverse valve c1 (Only for EWYQ)
X19A (1-3)	DO: Fanstep 1 c1
X19A (5-7)	DO: Fanstep 2 c1
X20A	DO: Fanstep 3 c1
X22A	Ch DO1: "SAFETY + W. (NO)" (def)
X24A	Ch DO2: "GEN. OPERATION" (def)
X25A	Ch DO3: function not pre-defined
X33A	AI: Ambient sensor
X34A	AI: Inlet water sensor
X35A	AI: Outlet water sensor
X36A	AI: Suction temperature sensor c1
X37A	AI: Refrigerant piping temperature sensor c1
X38A	AI: Coil temperature sensor 1 c1 (only for EWYQ)
X39A	AI: Coil temperature sensor 2 c1 (only for EWYQ)
X40A	AI: Discharge temperature sensor 1 c1
X41A	AI: Discharge temperature sensor 2 c1

1

X42A	AI: High pressure sensor c1
X43A	AI: Low pressure sensor c1
X44A	AI: Current measurement (OP57)
X45A	AI: Voltage measurement (OP57)
HAP, HBP	LED (Service monitor green)
H1P, H2P	LED (Service monitor red)
S1A	dipswitch (address)
S2A	dipswitch (terminal resistor)

Extension PCB (A01P)	
X63A	Ch DO6: Function not pre-defined
X64A (1-3)	Ch DO4: Function not pre-defined
X64A (5-7)	Ch DO5: Function not pre-defined
X65A (1-2)	Ch DI3: Function not pre-defined
X65A (3-4)	Ch DI4: Function not pre-defined
X66A	AI: Heating suction temperature sensor 1 c1 (Only for EWYQ)
X67A	AI: Heating suction temperature sensor 2 c1 (Only for EWYQ)
X68A	Ch AI2: Function not pre-defined
X69A	Ch AI1: Function not pre-defined
X70A	Ch AI4: Function not pre-defined
X71A	Ch AI3: Function not pre-defined
X72A (3-4)	not used
X73A	Ch AO1: Function not pre-defined
X74A (4-5)	not used
HAP, HBP	LED (service monitor green)

Wired remote controller PCB (A4P, A5P)	
HAP, HBP	LED (service monitor green)
S1A	dipswitch (address)
S2A	dipswitch (terminal resistor)

Communication PCB (A02P)	
HCP, HDP, HEP	LED (service monitor green)
S3A	dipswitch (terminal resistor)

EEV PCB (A71P)	
X86A	Y11E Electronic expansion valve
X87A	not used
HAP	LED (service monitor green)
DS1	dipswitch (address)

EEV PCB (A72P) (Only EWYQ)	
X86A	Y12E Electronic expansion valve (only EWYQ)
X87A	Y13E Electronic expansion valve (only EWYQ)
HAP	LED (service monitor green)
DS1	dipswitch (address)

:

	EWAQ80 EWYQ80	EWAQ100 EWYQ100
FUSES		
F1-F3	125gL/gG 500V	160gL/gG 500V
F1U	T 5A/250V	T 5A/250V
F4, F5	10gL/250V	10gL/250V
Circuit breakers		
F8B (OPIF)	-	-
F9B	C 2A/250V	C 2A/250V
Circuit breaker and motor protector settings		
F6B	1,55A	1,55A
F11B	-	-
F12B	-	-
F16B (OPSP/OPSC/OTPT/OPTC)	4,8A	4,8A
F16B (OPHP)	12,0A	12,0A

1

F17B (OPTH/OPTC)	4,8A	4,8A
F14B	6,6A	6,6A
F15B (OPIF)	7,7A	7,7A
K13S-K16S	1,5A	1,5A

3.2.5 PCB changeable I/O overview

Refer to the installation manual for instructions how to configure changeable I/O.

<p style="text-align: center;">Changeable digital input (4 available)</p> <ul style="list-style-type: none"> -None -Status -Dual setpoint Remote on-off -Capacity limitation 25%, 50%, 75%, or setting -Low noise (only for OPIF) -Free cooling signal -Fan forced on 	<p style="text-align: center;">Changeable analog output (1 available)</p> <ul style="list-style-type: none"> -None - Unit capacity (mA, V) -Details of types: Type mA: 0 .. 20mA / 4..20 mA Type V: 0-1V / 0-5V / 0-10V
<p style="text-align: center;">Changeable digital output (6 or 5 available depending on unit)</p> <ul style="list-style-type: none"> - None (open) - Closed - 2nd pump -100% capacity - Full capacity - Free cooling - General operation - Safety + warning NO Safety + warning NC (only for ch DO1) -Safety NO (excluding warning) -Safety NC (excluding warning) (only for ch DO1) -C1, C2 Safety NO -Warning NO - C1, C2 operation - Cooling (only EWYQ) - Heating (only EWYQ) - Defrost (only EWYQ) 	<p style="text-align: center;">Changeable analog input (4 available)</p> <ul style="list-style-type: none"> -None -Status (mA, V, NTC*, DI) -Floating setpoint (mA, V, NTC*) -Water temperature measurement (NTC**) -Changeable DI, refer to Ch DI for possibilities (DI) - Details of types: Type mA: 0..20mA / 4..20mA (internal 5V or external power supply) Type V: 0-1V / 0-5V/ 0-10V Type DI: DI (5V detection) <p>*: for allowed NTC types and how to configure the software please contact your local dealer.</p>

1

3.2.6 Unit outlook

TOP VIEW OF UNIT (FANS)

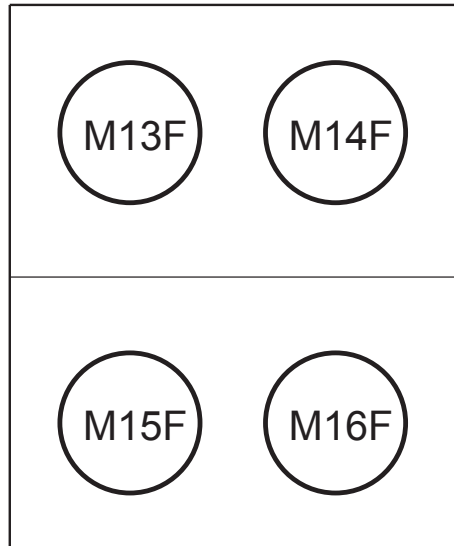

TOP VIEW OF UNIT (COMP+ SB)

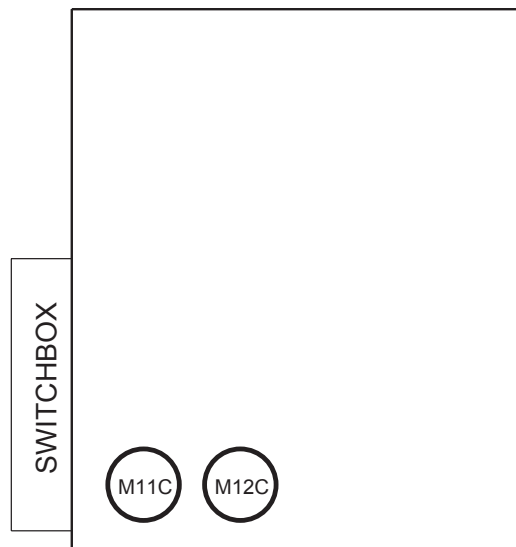

EWAQ 80-100

EWYQ 80-100

3.2.7 Switchbox outlook (typical)

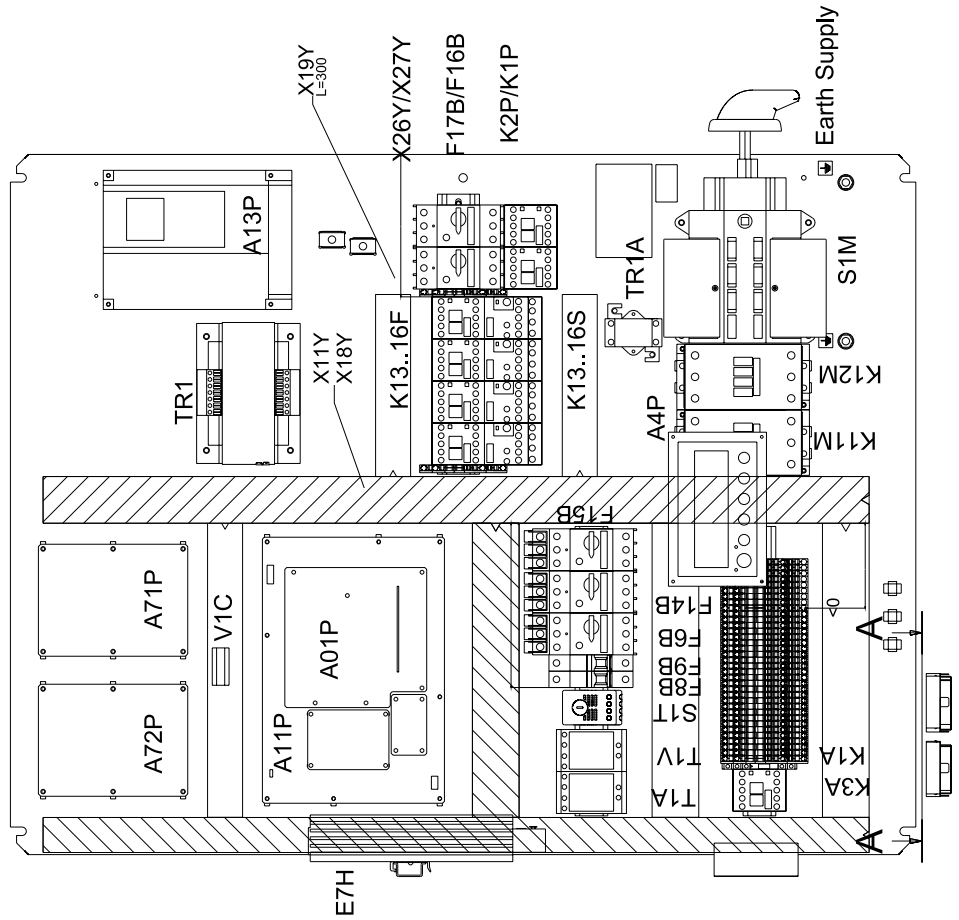

A-A (1 : 2)

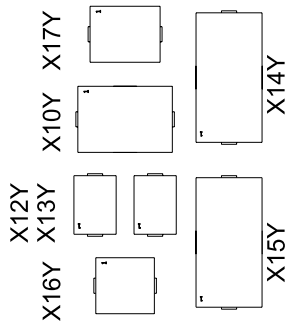

3.2.8 Main power supply

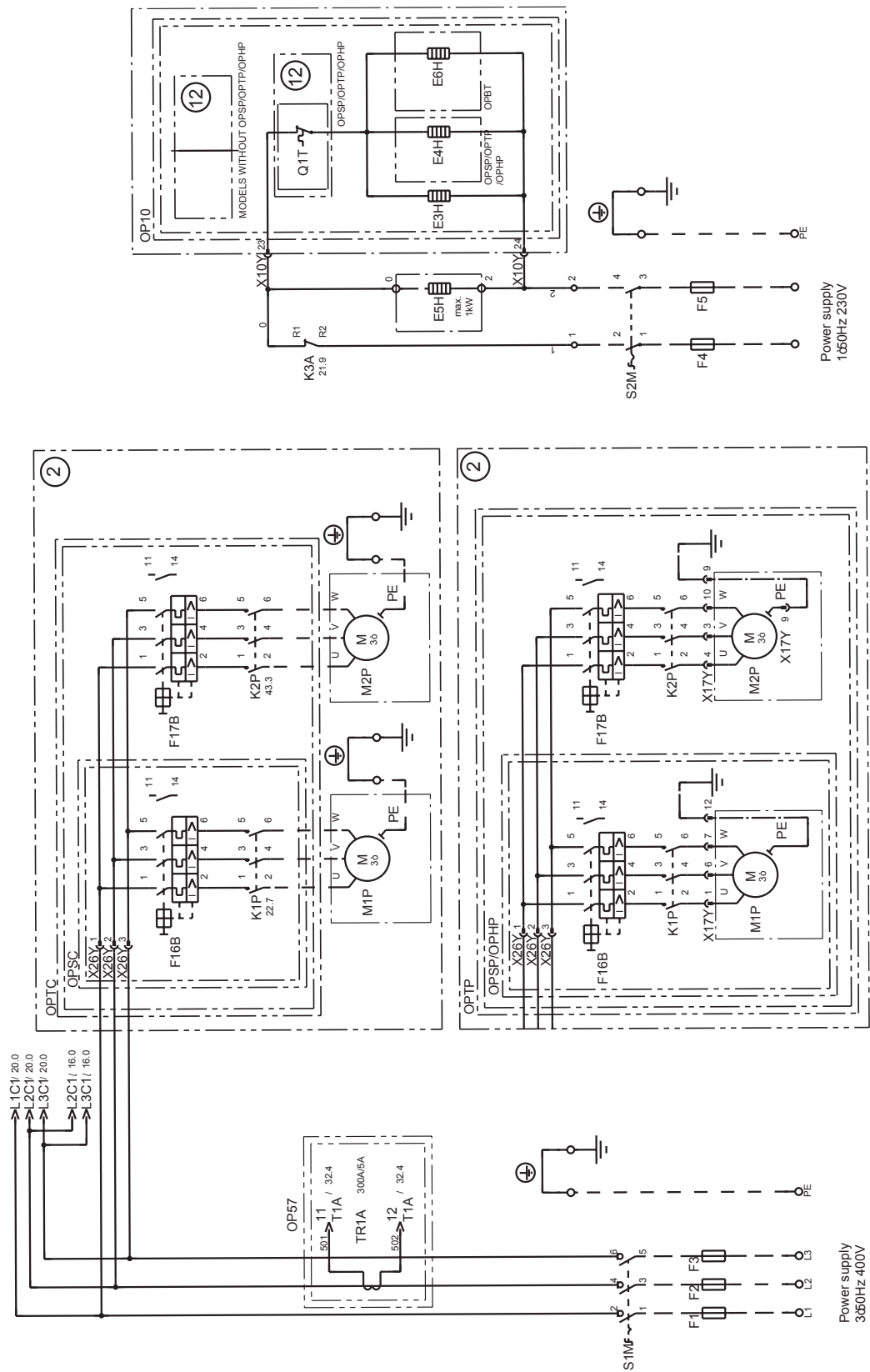

3.2.9 Trafo & PCB power supply

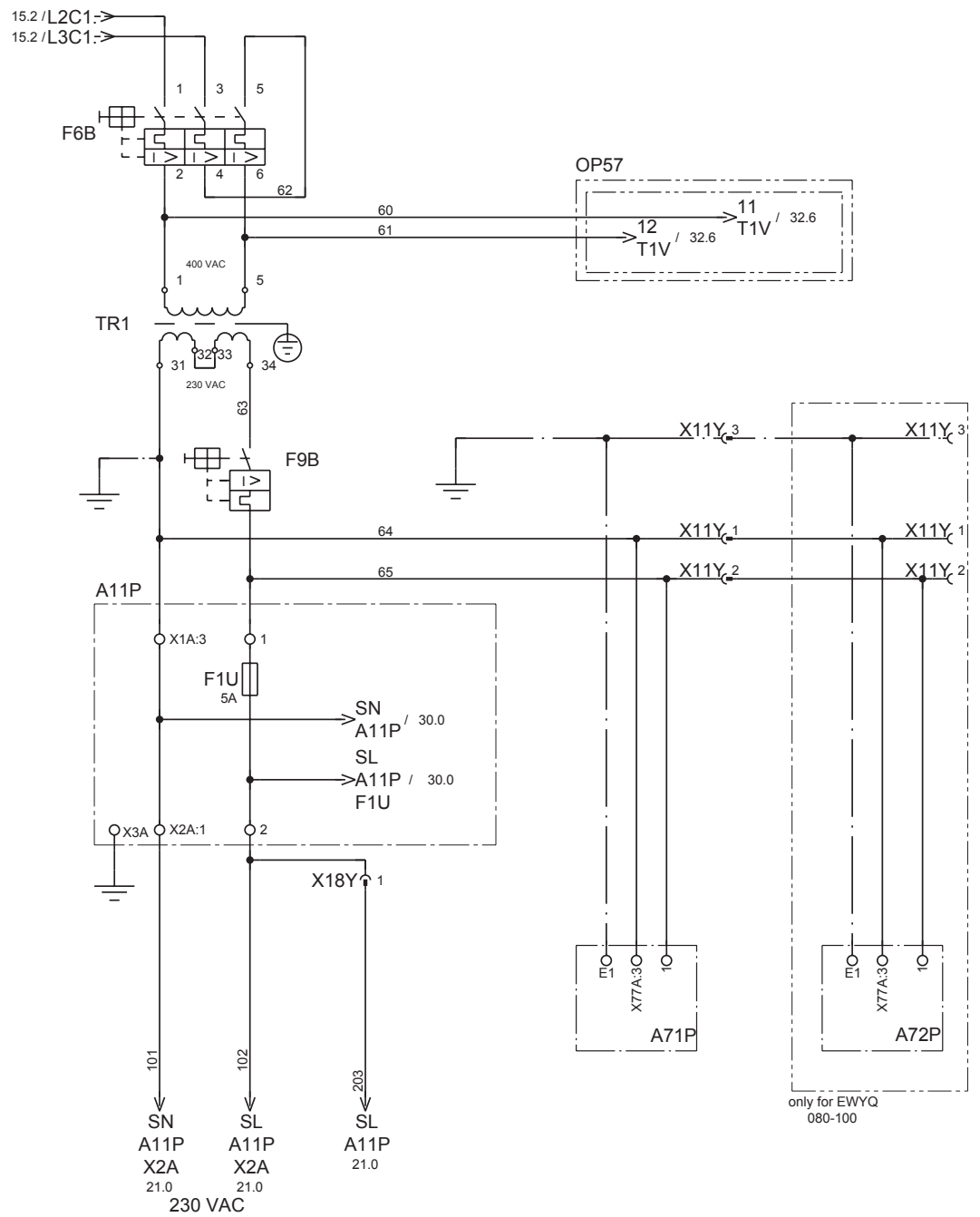

3.2.10 Compressor & fan

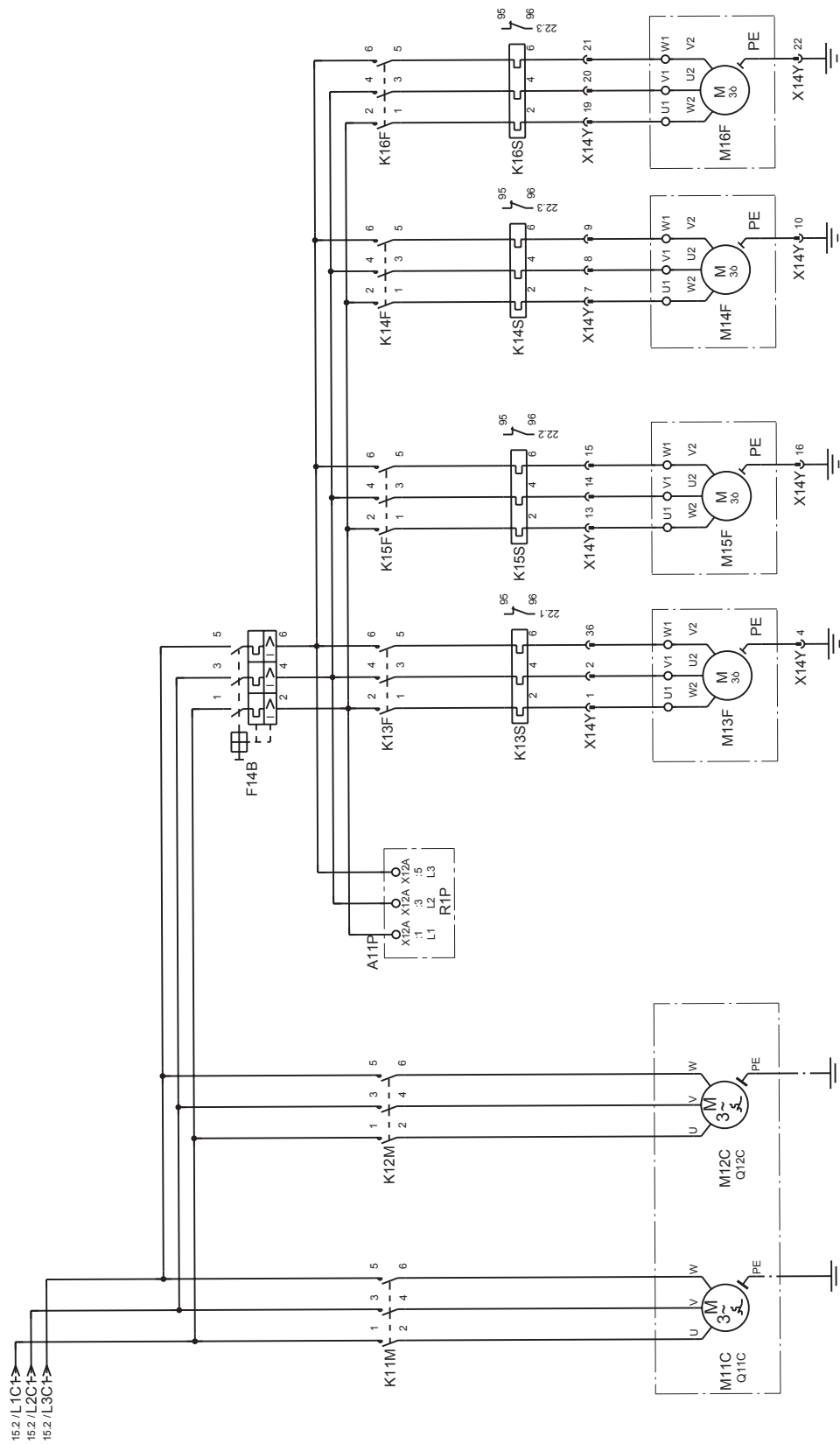

3.2.11 Circuit 1: control compressors

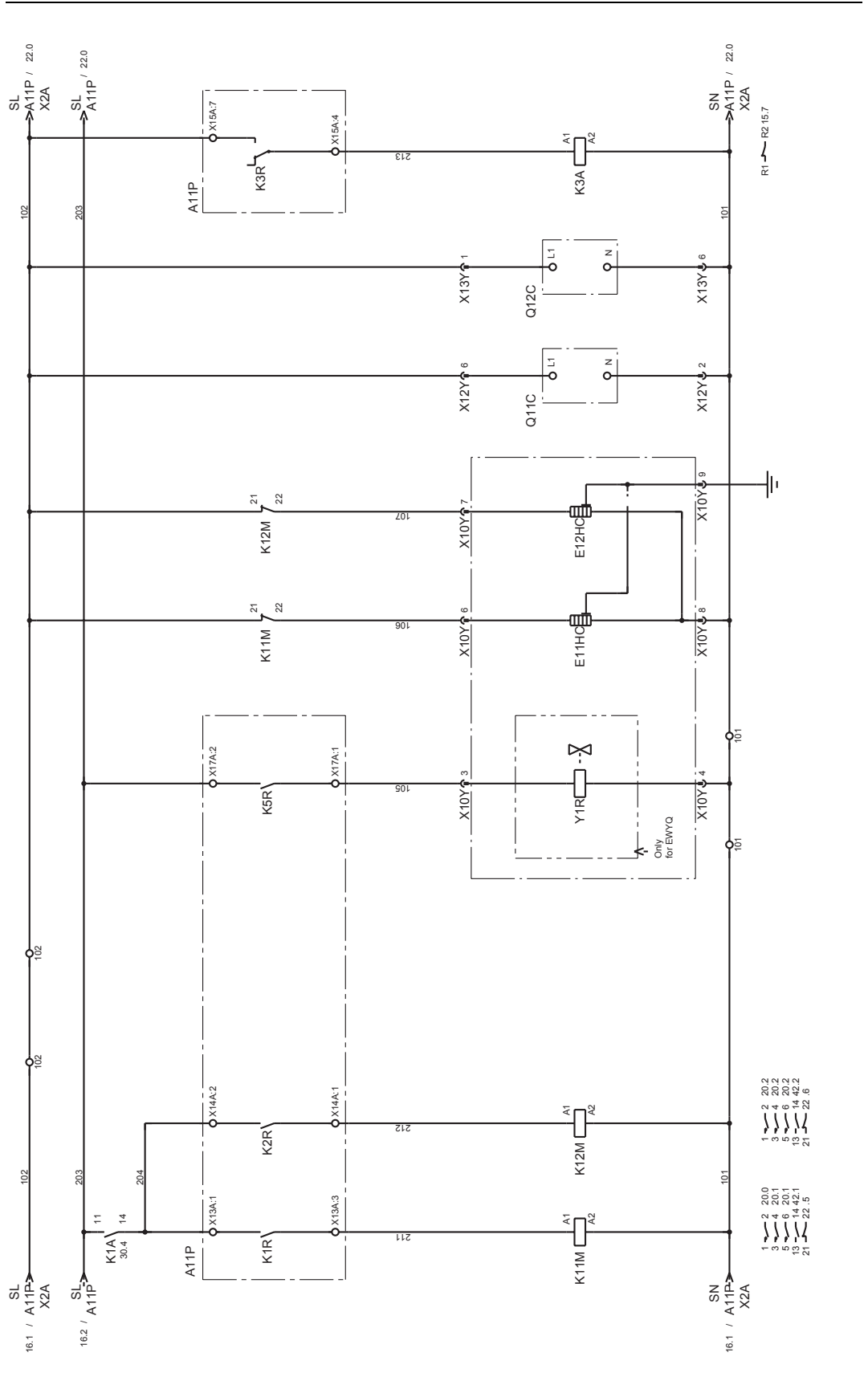

3.2.12 Circuit 1: control fans

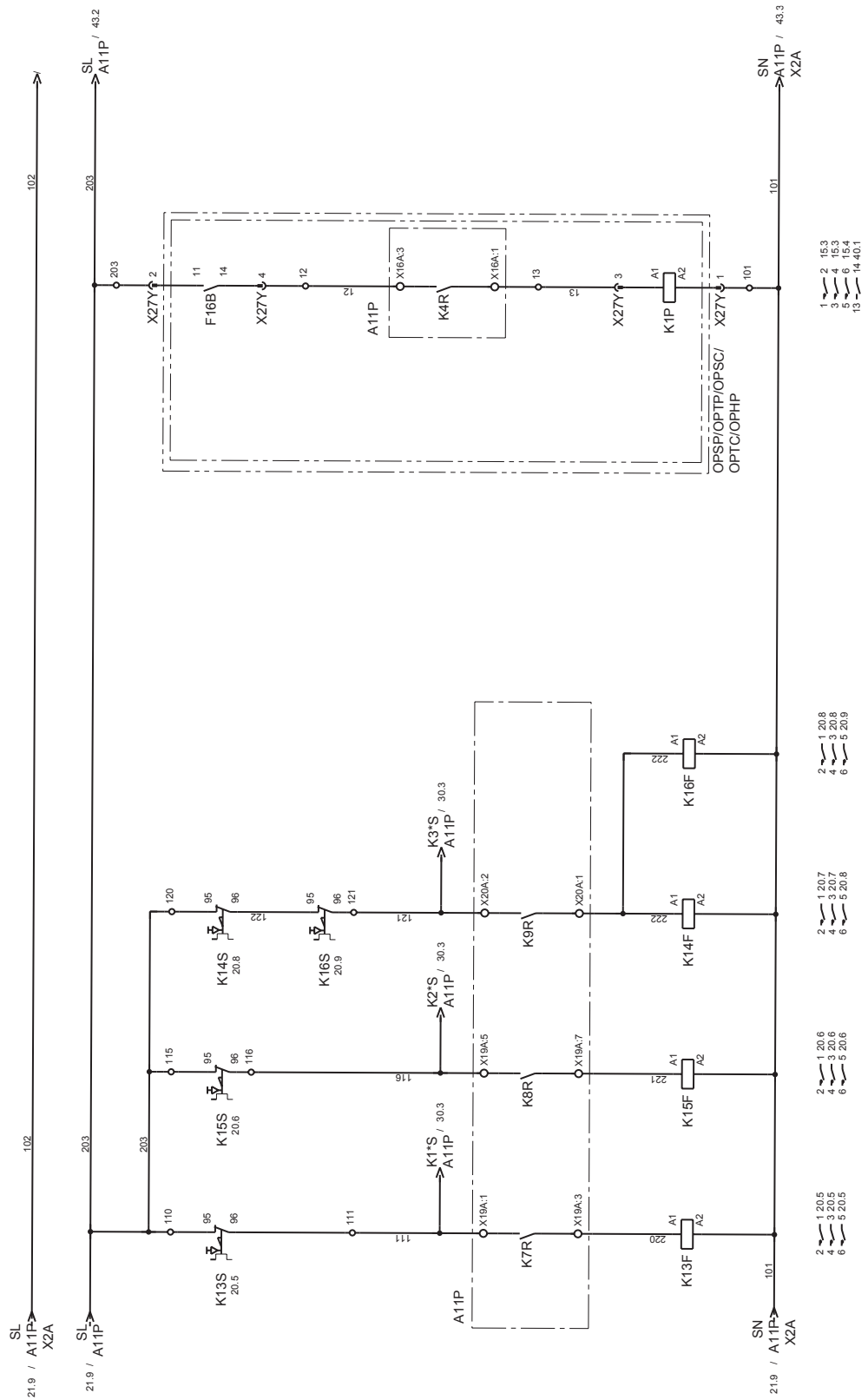

3.2.13 Control circuit (DI 230V)

1

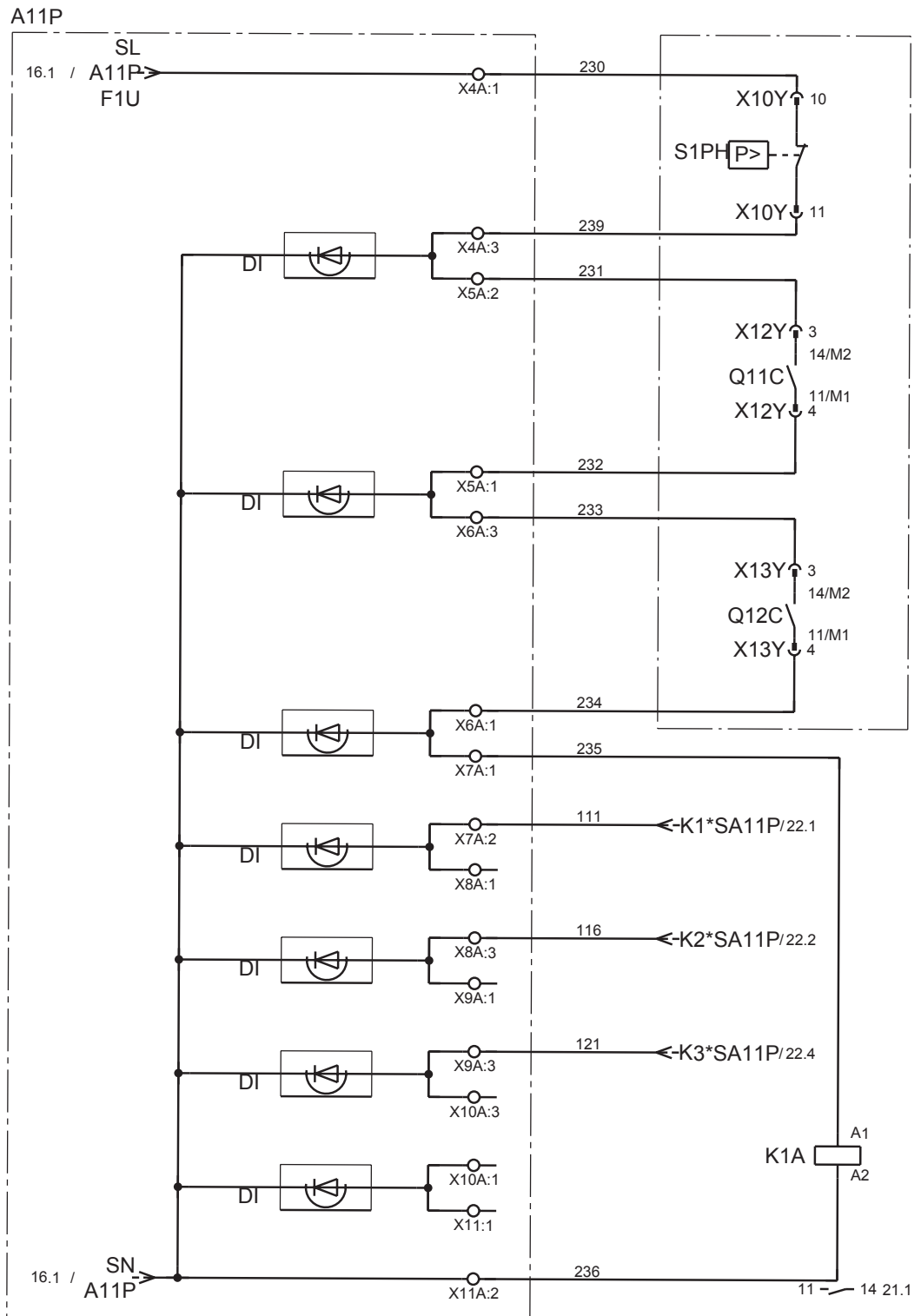

3.2.15 Circuit 1: sensors

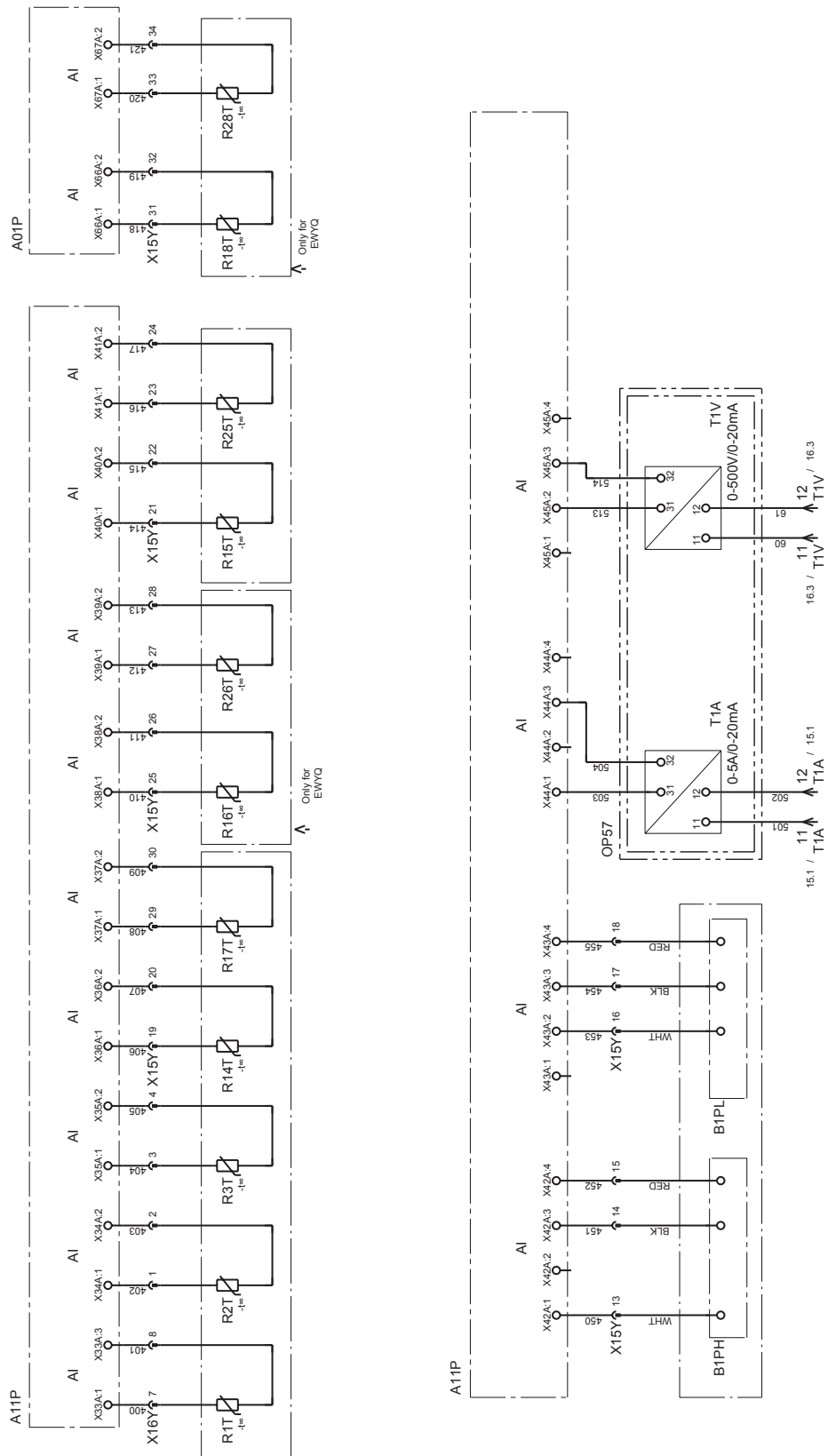

3.2.16 Field wiring DI, changeable DI

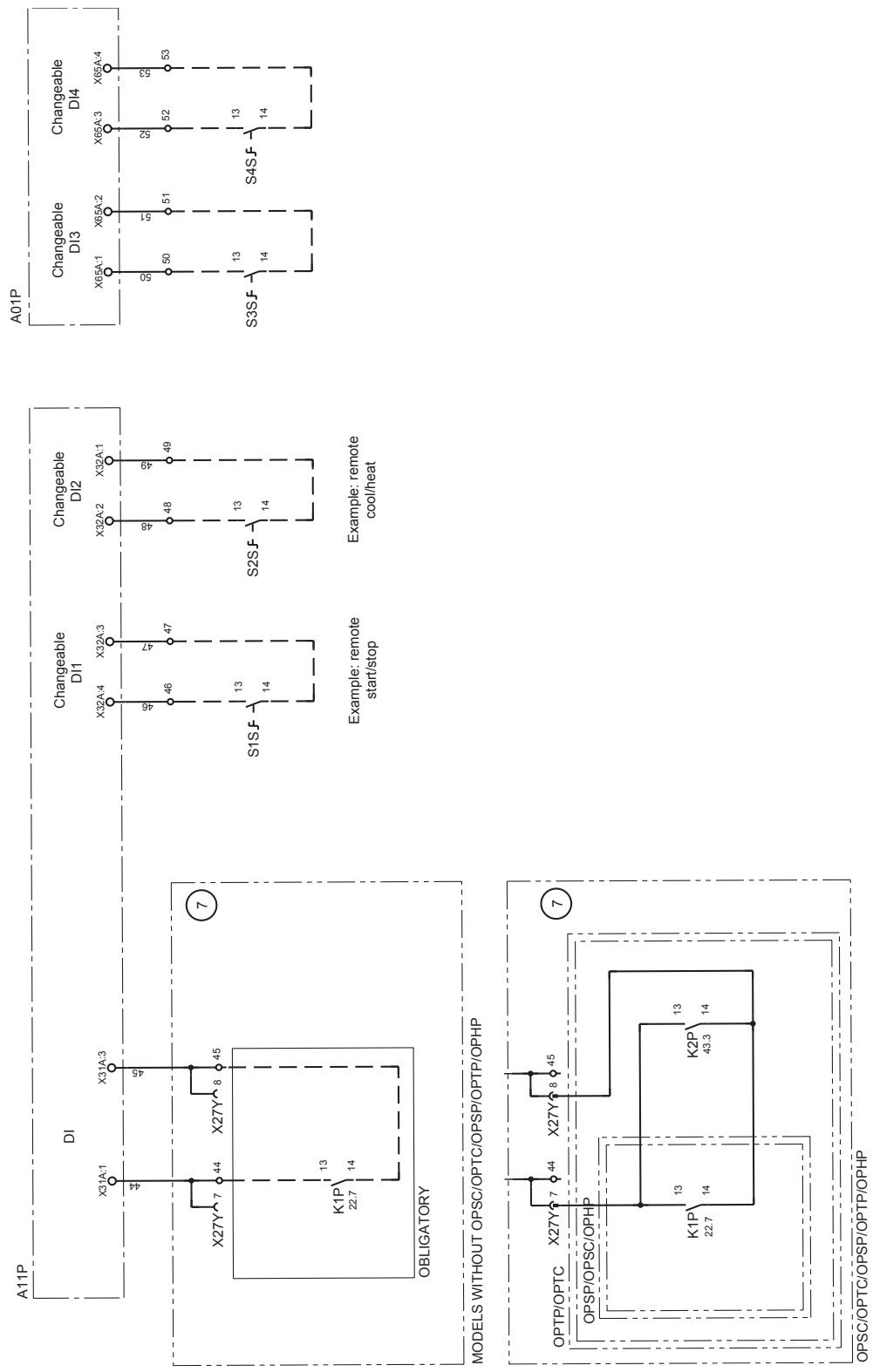

3.2.17 Field wiring changeable AI/AO

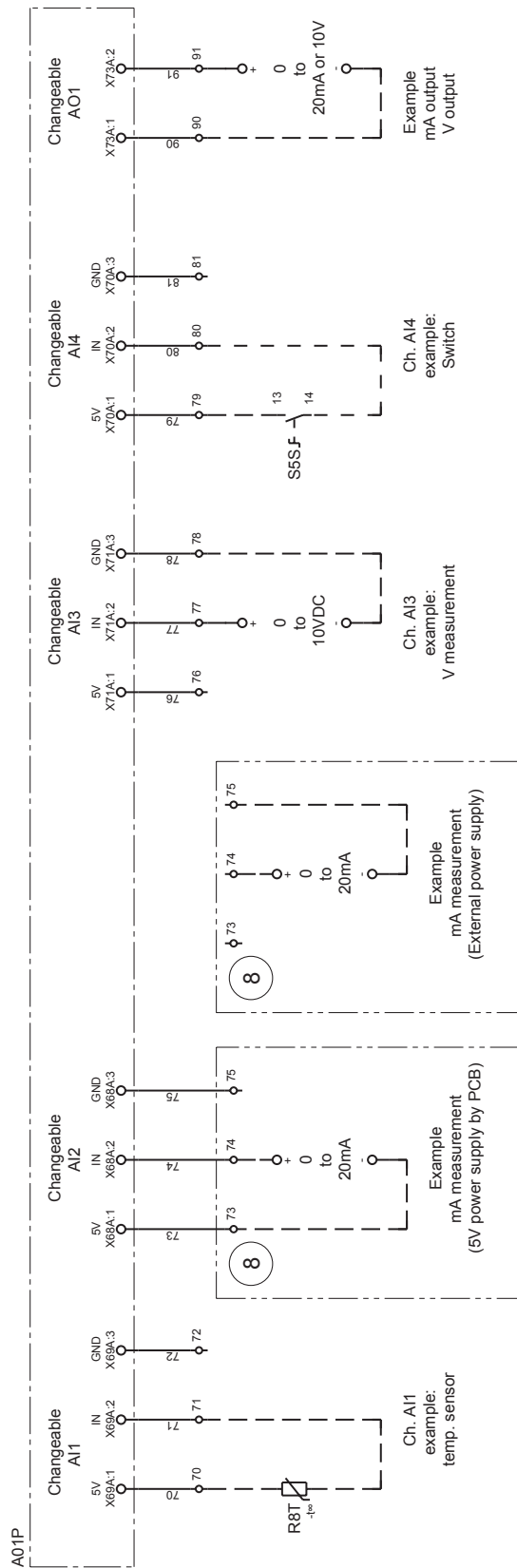

3.2.18 Field wiring DO, changeable DO

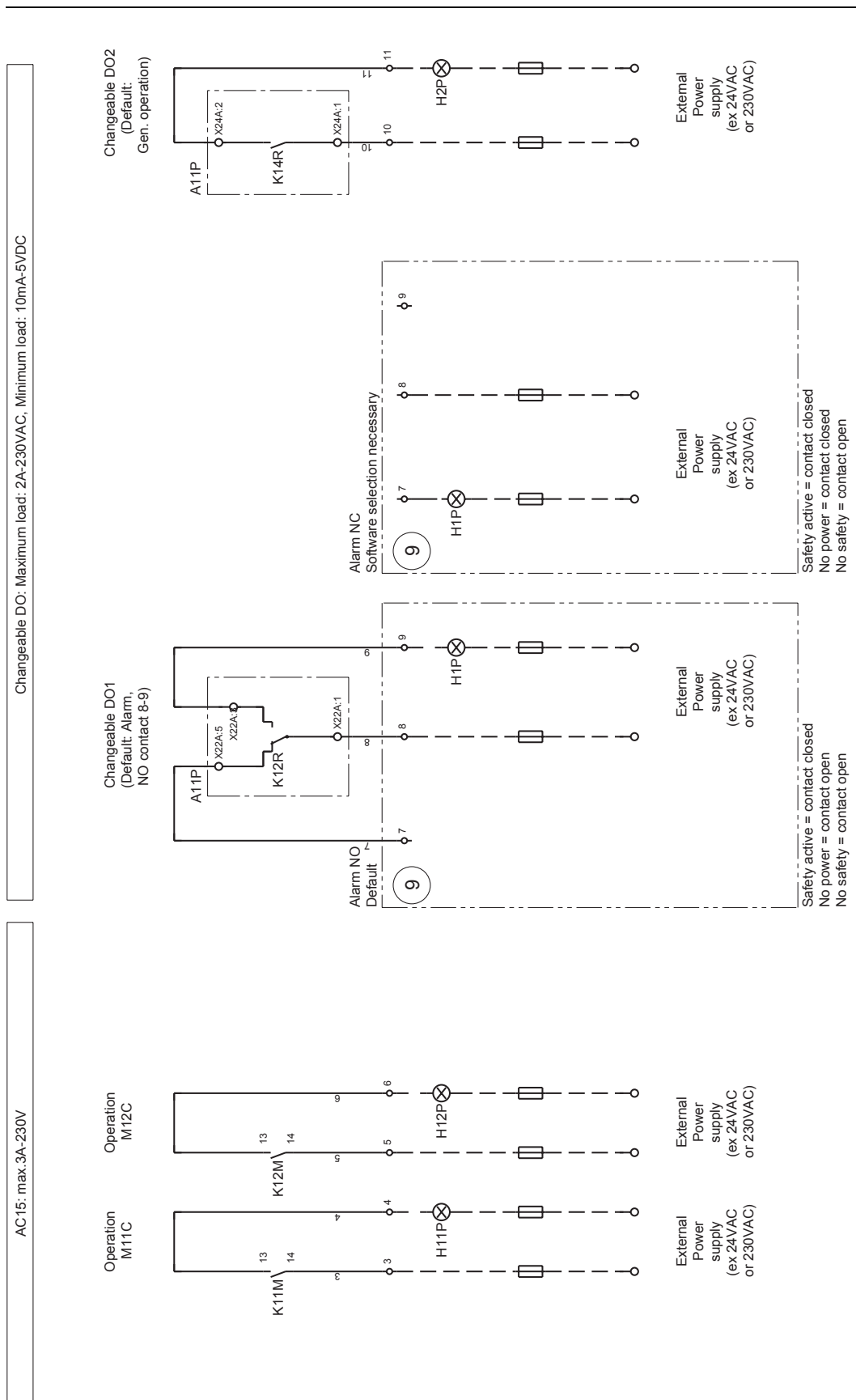

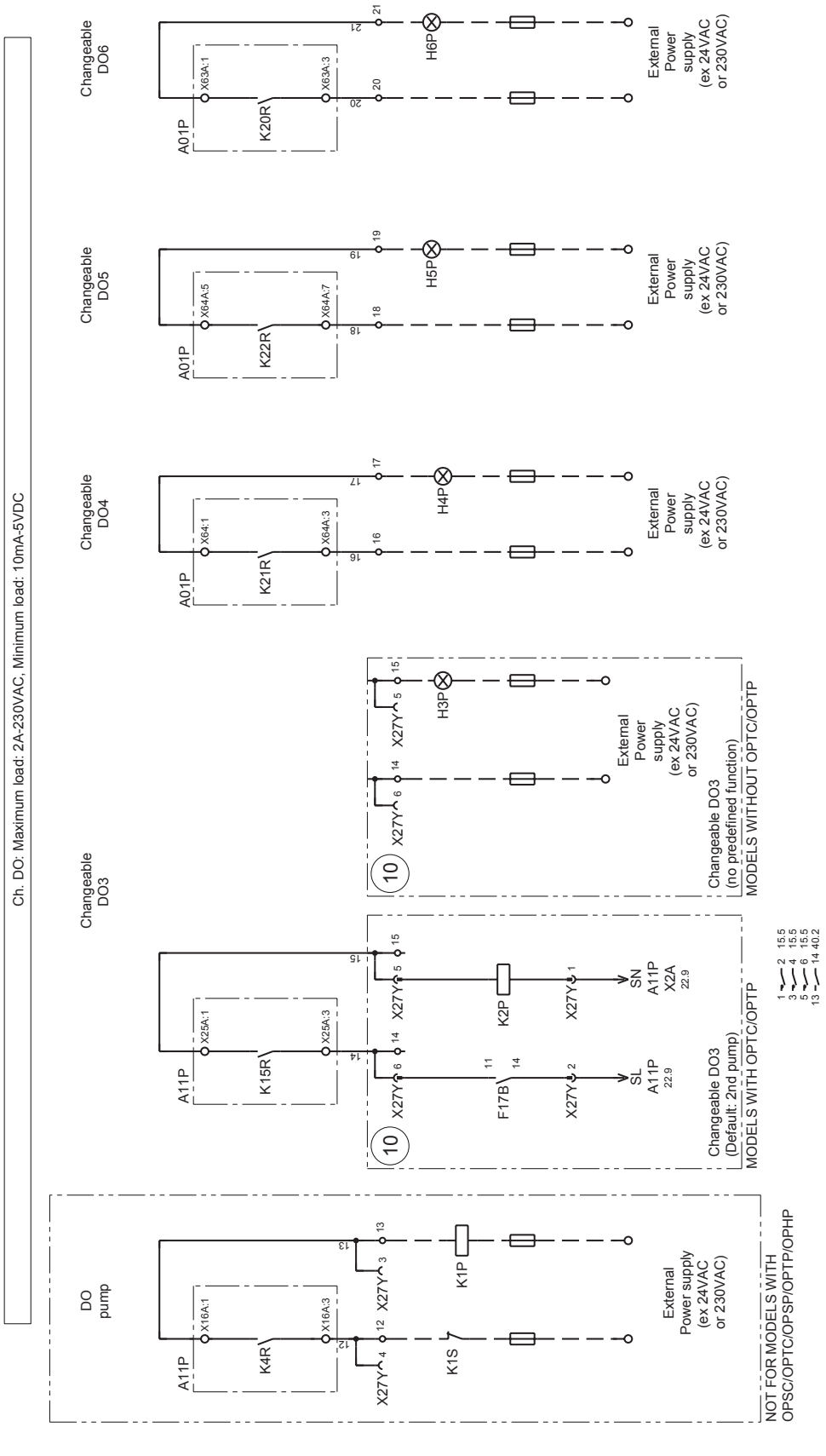





3.3 Wiring Layout : EWAQ130-260DAYN(N-P-B) and EWYQ130-250DAYN(N-P-B) Standard Unit

Introduction This chapter gives a general overview of the PCB interconnection, I/O overview, switchbox outlook and wiring of the EWAQ130-260DAYN(N-P-B) and EWYQ130-250DAYN(N-P-B) standard units.

Overview This chapter contains the following topics:

Page description	Page
3.3.1 Notes	1–117
3.3.2 Legend	1–119
3.3.3 PCB interconnection diagram	1–124
3.3.4 PCB I/O overview & fuses	1–125
3.3.5 PCB changeable I/O overview	1–130
3.3.6 Unit outlook	1–131
3.3.7 Switchbox outlook (typical)	1–132
3.3.8 Main power supply	1–133
3.3.9 Trafo & PCB power supply	1–134
3.3.10 Circuit 1: compressor & fan	1–135
3.3.11 Circuit 1: control compressors	1–136
3.3.12 Circuit 1: control fans	1–137
3.3.13 Circuit 2: compressor & fan	1–138
3.3.14 Circuit 2: control compressors	1–139
3.3.15 Circuit 2: control fans	1–140
3.3.16 Control circuit (DI 230V)	1–141
3.3.17 Control circuit and EEV	1–142
3.3.18 Circuit 1: sensors	1–143
3.3.19 Circuit 2: sensors	1–144
3.3.20 Fieldwiring DI, changeable DI	1–145
3.3.21 Fieldwiring changeable AI/AO	1–146
3.3.22 Fieldwiring DO, changeable DO	1–147

3.3.1 Notes

- L1, L2, L3 : Main terminals
 - 1-99 : Field wiring terminals
 - 100-199 : Factory upwiring terminals
 - 200- : Internal wiring terminals
 - U-Z : Main terminals in compressor switchbox
 - _____ : Earth wiring
 - 15 : Wire number 15
 - ⊙15 : Terminals number 15
 - : Field supply
 -  : Option
 -  : Not mounted in switchbox
 -  : Wiring depending on model
 -  : PCB
 - **/12.2 : Connection ** continues on page 12 column 2
 - ! : Pin against miswiring
 - ① : Several wiring possibilities
 - N-model : unit with no options included
- Y1R, Y2R reversing valves are activated in cooling mode.

1

Factory installed:	<input type="checkbox"/>	OP10	= Heater tape
	<input type="checkbox"/>	OP57	= A-meter, V-meter
	<input type="checkbox"/>	OPLN	= Low noise (OPIF+ Compressorhousing)
	<input type="checkbox"/>	OPTP	= Twinpump
	<input type="checkbox"/>	OPSC	= Single pump contactor
	<input type="checkbox"/>	OPTC	= Twin pump contactor
	<input type="checkbox"/>	OPIF	= Inverter fans for low ambient (-15°C)
	<input type="checkbox"/>	OPHP	= Hi ESP pump
	<input type="checkbox"/>	OPSP	= Single pump
	<input type="checkbox"/>	OPBT	= Buffer tank
User installed:	<input type="checkbox"/>	EKACPG	= Address card including: -RS485 (Integrated modbus) -F1, F2 (DICN + DBACS Connection)
	<input type="checkbox"/>	EKRUPG	Remote used interface
Definitions:			
	DI:	Digital input	
	DO:	Digital output	
	AI:	Analog input	
	AO:	Analog output	
	Ch:	Changeable (function can be selected by the customer)	

3.3.2 Legend

	Not included with standard unit	
	Not possible as option	Possible as option
Obligatory	#	##
Not obligatory	*	**

Part number		Description
A01P		PCB Extension
A02P	**	PCB Communication (EKACPG)
A4P		PCB wired remote controller
A5P	**	PCB wired remote controller (EKRUPG)
A11P, A21P		PCB main controller circuit 1, circuit 2
A13P, A23P	**	frequency inverter circuit 1, circuit 2 (OPIF)
A71P		PCB EEV driver
A72P		PCB EEV driver (only for EWYQ)
A73P		PCB EEV driver (only for EWYQ230-250)
B1PH, B2PH		high pressure sensor circuit 1, circuit 2
B1PL, B2PL		low pressure sensor circuit 1, circuit 2
DS1 (A*P)		PCB dipswitch
E1HS	**	switchbox heater with fan (OPIF) (only for EWAQ130-260 / EWYQ130-250)
E3H	**	heatertape (OP10)
E4H	**	heatertape (OP10) (only for OPSP/OPHP/OTPT)
E5H	*	fieldheater
E6H	**	buffer tank heater (OP10) (only for OPBT)
E7H	**	switchbox heater (OPIF) (only for EWA/YQ80-100)
E11HC, E12HC		crankcase heater compressor circuit 1
E21HC, E22HC		crankcase heater compressor circuit 2
F1-F3	#	main fuses
F1U (A*P)		fuse PCB
F4, F5	#	fuses for heaters
F6B		autofuse for primary of TR1
F8B	**	autofuse for switchbox heater
F9B		autofuse for secondary of TR2
F11B, F12B		autofuse for compressors (M11C, M12C,) (Not for EWA/YQ80-100)

Part number		Description
F14B, F24B		autofuse for fan motors circuit 1, circuit 2
F15B, F25B	**	autofuse for fan motors circuit 1, circuit 2 (OPIF)
F16B	**	autofuse for pump (K1P) (Only for OPSP/ OPHP/ OPSC/ OTP/ OPTC)
F17B	**	autofuse for pump (K2P) (only for OTP/ OPTC)
F21B, F22B		autofuse for compressors (M21C, M22C)
H1-6P	*	indication lamp for changeable digital outputs
H11P, H12P	*	indication lamp for operation compressor circuit 1 (M11C, M12C)
H21P, H22P	*	indication lamp for operation compressor circuit 1 (M21C, M22C)
HAP-HEP (A*P)		light emitting diode PCB
K1A, K2A		auxiliary relay for compressor safety circuit 1, circuit 2
K1P	##	pump contactor (only for OPSP/ OPHP/ OPSC/ OPTC)
K1S	*	overcurrent relay pump
K1R-K22R (A*P)		PCB relay
K2P	**	pump contactor (only for OTP/ OPTC)
K3A		auxiliary relay for heater tape
K11M, K12M		compressor contactor for circuit 1
K13F, K14F		fan contactor for circuit 1
K13S, K14S		fan overcurrent relay for circuit 1
K15F		fan contactor for circuit 1 (Only for EWAQ80-100/180-210/240-260) (Only for EWYQ80-100/180-210/230-250)
K15S		fan overcurrent relay for circuit 1 (Only for EWAQ80-100/180-210/240-260) (Only for EWYQ80-100/180-210/230-250)
K16F		fan contactor for circuit 1 (Only for EWAQ80-100/240-260) (Only for EWYQ80-100/230-250)
K16S		fan overcurrent relay for circuit 1 (Only for EWAQ80-100/240-260) (Only for EWYQ80-100/230-250)
K21M, K22M		compressor contactor for circuit 2
K23F, K24F		fan contactor for circuit 2
K23S, K24S		fan overcurrent relay for circuit 2
K25F		fan contactor for circuit 2 (Only for EWAQ180-210/240-260) (Only for EWYQ180-210/230-250)

Part number		Description
K25S		fan overcurrent relay for circuit 2 (Only for EWAQ180-210/240-260) (Only for EWYQ180-210/230-250)
K26F		fan contactor for circuit 2 (Only for EWAQ/240-260) (Only for EWYQ230-250)
K26S		fan overcurrent relay for circuit 2 (Only for EWAQ/240-260) (Only for EWYQ230-250)
M1P	**	pump motor 1 (only for OPSP/ OPHP/OPSC/OTPT/OPTC)
M2P	**	pump motor 2 (only for /OPTC)
M11C, M12C		compressor motors circuit 1
M13F, M14F		fan motors circuit 1
M15F		fan motors circuit 1 (Only for EWAQ80-100/180-210/240-260) (Only for EWYQ80-100/180-210/230-250)
M16F		fan motors circuit 1 (Only for EWAQ80-100/240-260) (Only for EWYQ80-100/230-250)
M21C, M22C		compressor motors circuit 2
M23F, M24F		fan motors circuit 2
M25F		fan motors circuit 2 (Only for EWAQ180-100/240-260) (Only for EWYQ180-100/230-250)
M26F		fan motors circuit 2 (Only for EWAQ240-260) (Only for EWYQ230-250)
M1F		switchbox fanmotor
Q1T	**	thermostat (OP10)
Q11C, Q12C		For EWAQ130/EWYQ130: thermal protector compressor circuit 1 For EWAQ80-100/150/180-210/240-260: For EWYQ80-100/150/180-210/230-250: electronic protection module compressor circuit 1
Q21C, Q22C		For EWAQ130/EWYQ130: thermal protector compressor circuit 2 For EWAQ150/ 180-210/240-260: For EWYQ150/180-210/230-250: electronic protection module compressor circuit 2

Part number		Description
R1T		ambient temperature sensor
R2T		inlet water temperature sensor
R3T		outlet water temperature sensor
R8T	*	temperature sensor for changeable analog input
R14T		suction temperature sensor circuit 1
R15T, R25T		discharge temperature sensor circuit 1
R16T		coil temperature sensor circuit 1 (only for EWYQ)
R17T		refrigerant piping temperature sensor circuit 1
R18T, R38T		heating suction temperature sensor circuit 1, circuit 2 (only EWYQ)
R28T, R48T		heating suction temperature sensor circuit 1, circuit 2 (only EWYQ80-100/230-250)
R26T		coil temperature sensor circuit 1 (only for EQWYQ80-100/230-250)
R34T		suction temperature sensor circuit 2
R35T, R45T		discharge temperature sensor circuit 2
R36T		coil temperature sensor circuit 2 (only for EWYQ)
R37T		refrigerant piping temperature sensor circuit 2
R46T		coil temperature sensor circuit 2 (only for EWYQ)
S1A-S3A (A*P)		PCB dipswitch
S1L		flowswitch
S1M		main isolator switch
S1PH, S2PH		high pressure switch circuit 1, circuit 2
S1S-S5S	*	switch for changeable digital input (remote on/off, C/H, ...)
S1T	**	thermal contact (OPIF)
S2M	#	heatertape isolator switch
T1A	**	current transducer (OP57)
T1V	**	voltage transducer (OP57)
TR1		transfo control circuit (400V/230V)
TR1A	**	current measurement transfo (OP57)
V1C		Ferrite core
V1F, V2F	**	noise filter circuit 1, circuit 2 (OPIF) (Only for EWAQ130-150/180-210) (Only for EWYQ130-150/180-210)
V2C	**	Ferrite core (EKACPG)
X*A (A*P)		PCB terminal
X*Y		connector
X1M (A*P)		PCB terminal strip

Part number	Description
Y1R, Y2R	reverse valve circuit 1, circuit 2 (only EWYQ)
Y11E	electronic expansion valve cooling circuit 1
Y12E	electronic expansion valve heating circuit 1 (only EWYQ)
Y13E	electronic expansion valve heating circuit 1 (only EWYQ80-100/230-250)
Y21E	electronic expansion valve cooling circuit 2
Y22E	electronic expansion valve heating circuit 2 (only EWYQ)
Y23E	electronic expansion valve heating circuit 2 (only EWYQ 230-250)

3.3.3 PCB interconnection diagram

1

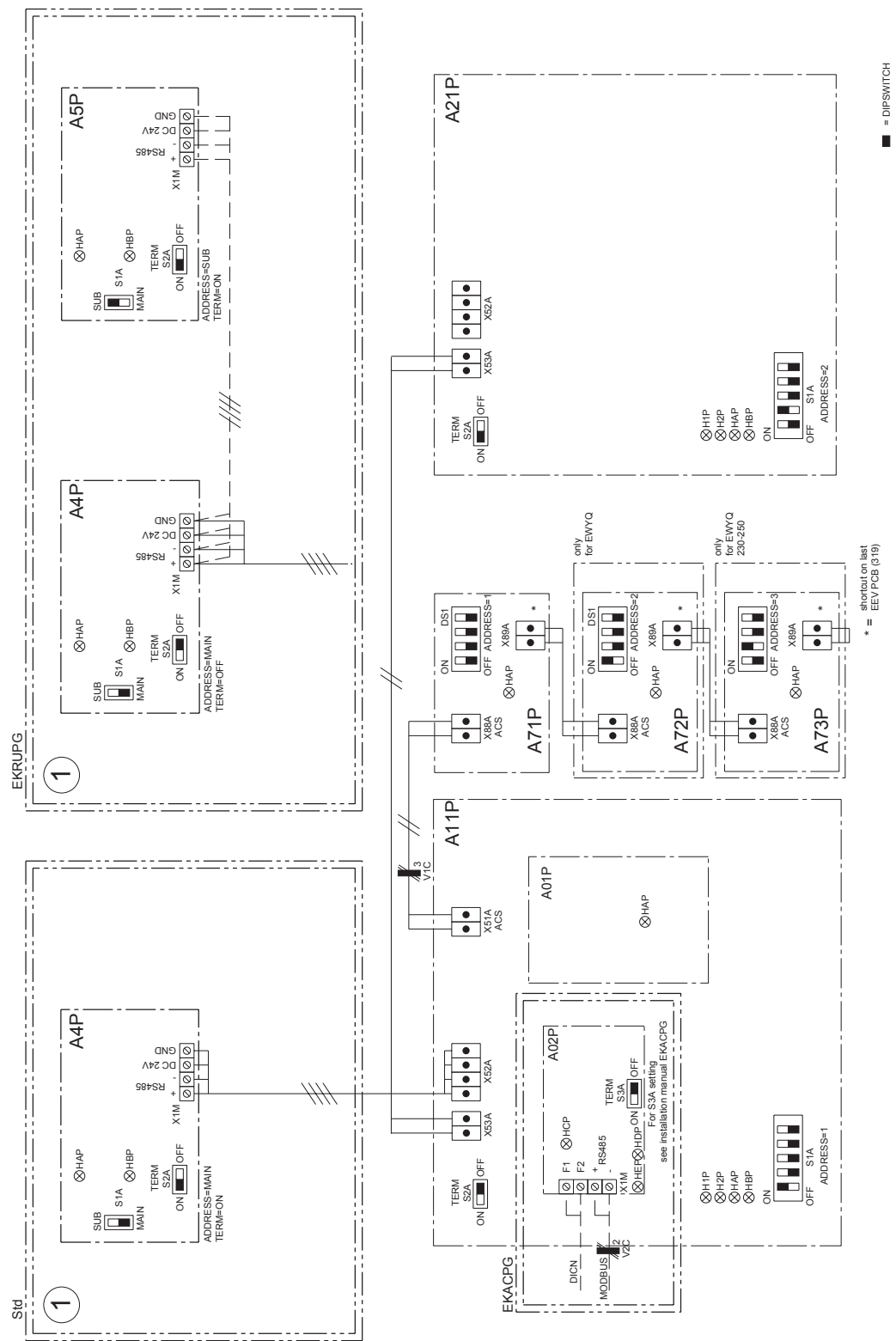

3.3.4 PCB I/O overview & fuses

Main PCB (A11P)	
X12A (1-3-5)	DI: Reverse phase detection (L1-L2-L3) c1
X4A	DI: High pressure switch c1
X5A	DI: Compressor interlock 1 c1
X6A	DI: Compressor interlock 2 c2
X7A	DI: Fan overcurrent relay Fanstep 1 c1
X8A	DI: Fan overcurrent relay Fanstep 2 c1
X9A	DI: Fan overcurrent relay Fanstep 3 c1
X27A	not used
X29A (3-4)	not used
X30A	DI: Flow switch
X31A	DI: Pump interlock
X32A (3-4)	Ch DI 1: function not pre-defined
X32A (1-2)	Ch DI 2: function not pre-defined
X13A	DO: Compressor contactor 1 c1
X14A	DO: Compressor contactor 2 c1
X15A	DO: Heatertape
X16A	DO: Pump contactor
X17A	DO: Reverse valve c1 (Only for EWYQ)
X19A (1-3)	DO: Fanstep 1 c1
X19A (5-7)	DO: Fanstep 2 c1
X20A	DO: Fanstep 3 c1
X22A	Ch DO1: "SAFETY + W. (NO)" (def)
X24A	Ch DO2: "GEN. OPERATION" (def)
X25A	Ch DO3: function not pre-defined
X33A	AI: Ambient sensor
X34A	AI: Inlet water sensor
X35A	AI: Outlet water sensor
X36A	AI: Suction temperature sensor c1
X37A	AI: Refrigerant piping temperature sensor c1
X38A	AI: Coil temperature sensor 1 c1 (only for EWYQ)
X39A	AI: Coil temperature sensor 2 c1 (only for EWYQ)
X40A	AI: Discharge temperature sensor 1 c1

1

X41A	AI: Discharge temperature sensor 2 c1
X42A	AI: High pressure sensor c1
X43A	AI: Low pressure sensor c1
X44A	AI: Current measurement (OP57)
X45A	AI: Voltage measurement (OP57)
HAP, HBP	LED (service monitor green)
H1P, H2P	LED (service monitor red)
S1A	dipswitch (address)
S2A	dipswitch (terminal resistor)

Extension PCB (A01P)	
X63A	Ch DO6: Function not pre-defined
X64A (1-3)	Ch DO4: Function not pre-defined
X64A (5-7)	Ch DO5: Function not pre-defined
X65A (1-2)	Ch DI3: Function not pre-defined
X65A (3-4)	Ch DI4: Function not pre-defined
X66A	AI: Heating suction temperature sensor 1 c1 (Only for EWYQ)
X67A	AI: Heating suction temperature sensor 2 c1 (Only for EWYQ)
X68A	Ch AI2: Function not pre-defined
X69A	Ch AI1: Function not pre-defined
X70A	Ch AI4: Function not pre-defined
X71A	Ch AI3: Function not pre-defined
X72A (3-4)	not used
X73A	Ch AO1: Function not pre-defined
X74A (4-5)	not used
HAP, HBP	LED (service monitor green)

Wired remote controller PCB (A4P, A5P)	
HAP, HBP	LED (service monitor green)
S1A	dipswitch (address)
S2A	dipswitch (terminal resistor)

Communication PCB (A02P)	
HCP, HDP, HEP	LED (service monitor green)
S3A	dipswitch (terminal resistor)

EEV PCB (A71P)	
X86A	Y11E Electronic expansion valve
X87A	Y21E Electronic expansion valve
HAP	LED (service monitor green)
DS1	dipswitch (address)

EEV PCB (A72P) (Only EWYQ)	
X86A	Y12E Electronic expansion valve (only EWYQ)
X87A	Y22E Electronic expansion valve (only EWYQ)
HAP	LED (service monitor green)
DS1	dipswitch (address)

Main PCB (A21P)	
X12A (1-3-5)	DI: Reverse phase detection (L1-L2-L3) c2
X4A	DI: High pressure switch c2
X5A	DI: Compressor interlock 1 c2
X6A	DI: Compressor interlock 2 c2
X7A	DI: Fan overcurrent relay Fanstep 1 c2
X8A	DI: Fan overcurrent relay Fanstep 2 c2
X9A	DI: Fan overcurrent relay Fanstep 3 c2
X27A	not used
X13A	DO: Compressor contactor 1 c2
X14A	DO: Compressor contactor 2 c2
X17A	DO: Reverse valve c2 (Only for EWYQ)
X19A (1-3)	DO: Fanstep 1 c2
X19A (5-7)	DO: Fanstep 2 c2
X20A	DO: Fanstep 3 c2
X34A	AI: Heating suction temperature sensor 1 c2 (Only for EWYQ)
X35A	AI: Heating suction temperature sensor 2 c2 (Only for EWYQ)

1

X36A	AI: Suction temperature sensor c2
X37A	AI: Refrigerant piping temperature sensor c2
X38A	AI: Coil temperature sensor 1 c2 (only for EWYQ)
X39A	AI: Coil temperature sensor 2 c2 (only for EWYQ)
X40A	AI: Discharge temperature sensor 1 c2
X41A	AI: Discharge temperature sensor 2 c2
X42A	AI: High pressure sensor c2
X43A	AI: Low pressure sensor c2
HAP, HBP	LED (service monitor green)
H1P, H2P	LED (service monitor red)
S1A	dipswitch (address)
S2A	dipswitch (terminal resistor)

EEV PCB (A73P) (Only EWYQ230-250)	
X86A	Y13E Electronic expansion valve (only EWYQ230-250)
X87A	Y23E Electronic expansion valve (only EWYQ230-250)
HAP	LED (service monitor green)
DS1	dipswitch (address)

	EWAQ130 EWYQ130	EWAQ150 EWYQ150	EWAQ180 EWYQ180	EWAQ210 EWYQ210	EWAQ240 EWYQ230	EWAQ260 EWYQ250
FUSES						
F1-F3	200gL/gG 500V	200gL/ gG 500V	250gL/gG 500V	250gL/gG 500V	300gL/gG 500V	355gL/gG 500V
F1U	T 5A/250V	T 5A/250V	T 5A/250V	T 5A/250V	T 5A/250V	T 5A/250V
F4, F5	10gL/250 V	10gL/250 V	10gL/250 V	10gL/250 V	10gL/250 V	10gL/250 V
Circuit breakers						
F8B (OPIF)	-	-	-	-	-	-
F9B	C 4A/250V	C 4A/250V	C 4A/250V	C 4A/250V	C 4A/250V	C 4A/250V
Circuit breaker and motor protector settings						
F6B	2,30A	2,30A	2,30A	2,30A	2,30A	2,30A
F11B, F22B	36A	40A	52A	52A	66A	66A
F12B, F21B	36A	40A	52A	52A	66A	66A

F16B (OPSP/ OPSC/ OPTP/OTPC) F16B (OPHP)	6,8A 12A	6,8A 12A	8,6A 16,3A	8,6A 16,3A	8,6A 16,3A	8,6A 16,3A
F17B (OPTP/ OPTC)	6,8A	6,8A	8,6A	8,6A	8,6A	8,6A
F14B, F24B	3,5A	5,1A	7,6A	7,6A	7,0A	6,4A
F15B, F25B (OPIF)	5,6A	7,9A	7,9A	7,9A	9,5A	9,5A
K13S-K16S K23S-K26S	1,6A	2,3A	2,3A	2,3A	1,6A	1,6A

3.3.5 PCB changeable I/O overview

Refer to the installation manual for instructions how to configure changeable I/O.

Changeable digital input (4 available)
-None
-Status
-Dual setpoint
-Remote on-off
-Capacity limitation 25%, 50%, 75%, or setting
-Low noise (only for OPIF)
-Free cooling signal
-Fan forced on

Changeable analog output (1 available)
-None
-Unit capacity (mA,V)
-Details of types:
Type mA: 0..20mA / 4..20mA
Type V: 0-1V / 0-5V / 0-10V

Changeable digital output (6 or 5 available depending on unit)
-None (open)
-Closed
-2nd pump
-100% capacity
-Full capacity
-Free cooling
-General operation
-Safety + warning NO
-Safety + warning NC (only for ch DO1)
-Safety NO (excluding warning)
-Safety NC (excluding warning) (only for ch DO1)
-C1, C2 Safety NO
-Warning NO
- C1, C2 operation
- Cooling (only EWYQ)
- Heating (only EWYQ)
- Defrost (only EWYQ)

Changeable analog input (4 available)
-None
-Status (mA, V, NTC*, DI)
-Floating setpoint (mA, V, NTC*)
-Water temperature measurement (NTC*)
-Changeable DI, refer to Ch DI for possibilities (DI)
- Details of types:
Type mA: 0..20mA / 4..20mA (internal 5V or external power supply)
Type V: 0-1V / 0-5V / 0-10V
Type DI: DI (5V detection)
 *: for allowed NTC types and how to configure the software please contact your local dealer.

3.3.6 Unit outlook

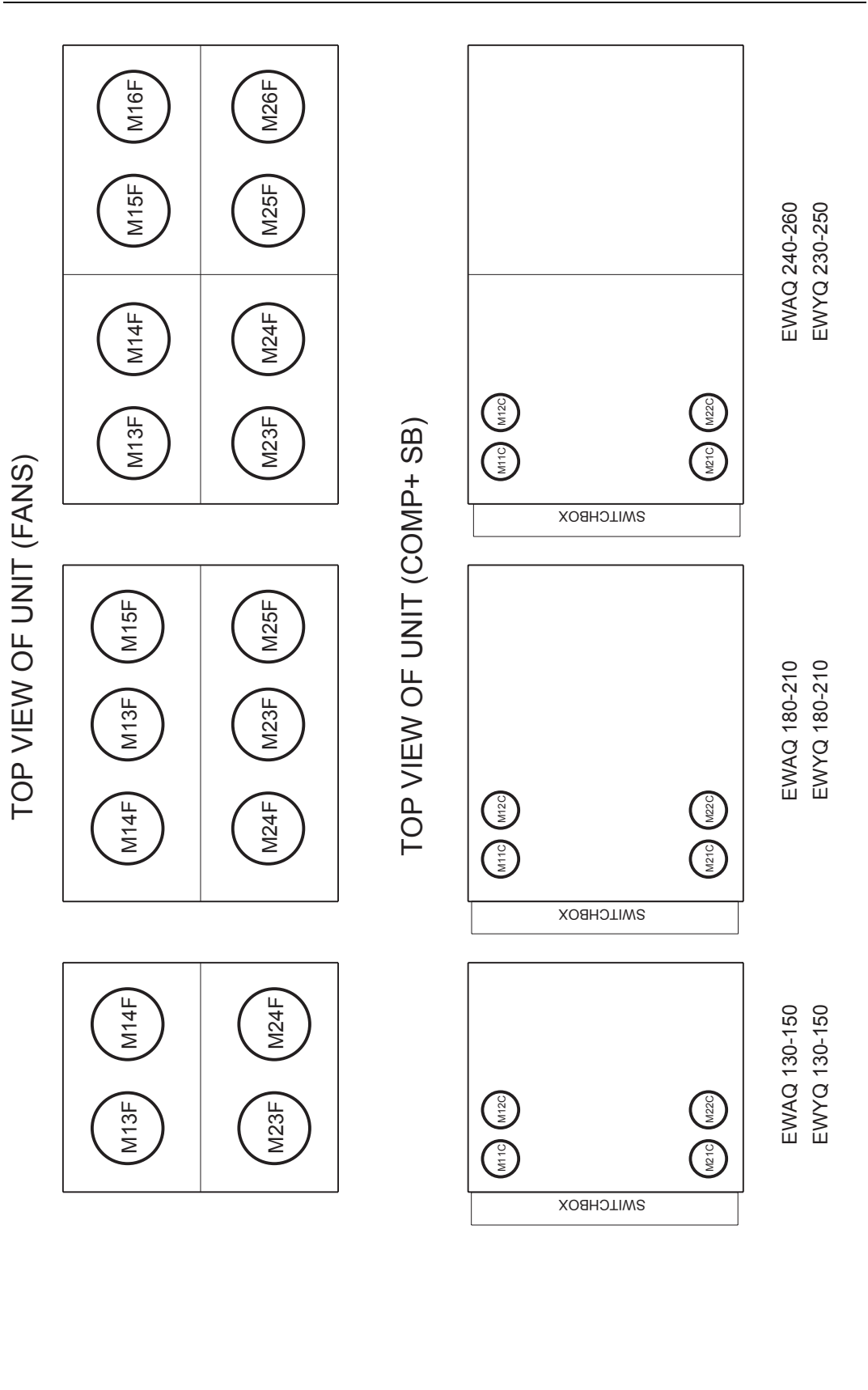

1

3.3.7 Switchbox outlook (typical)

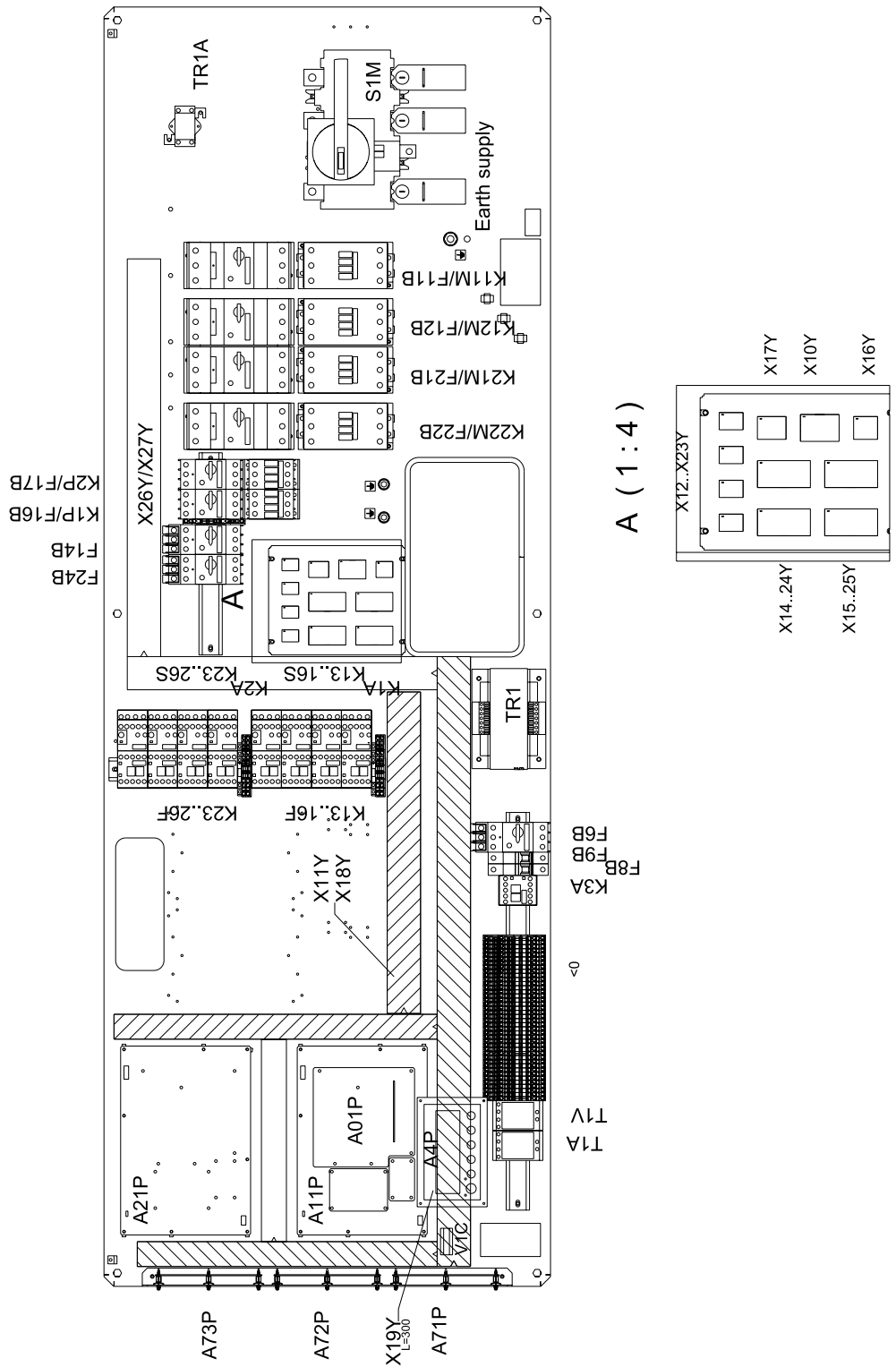

3.3.8 Main power supply

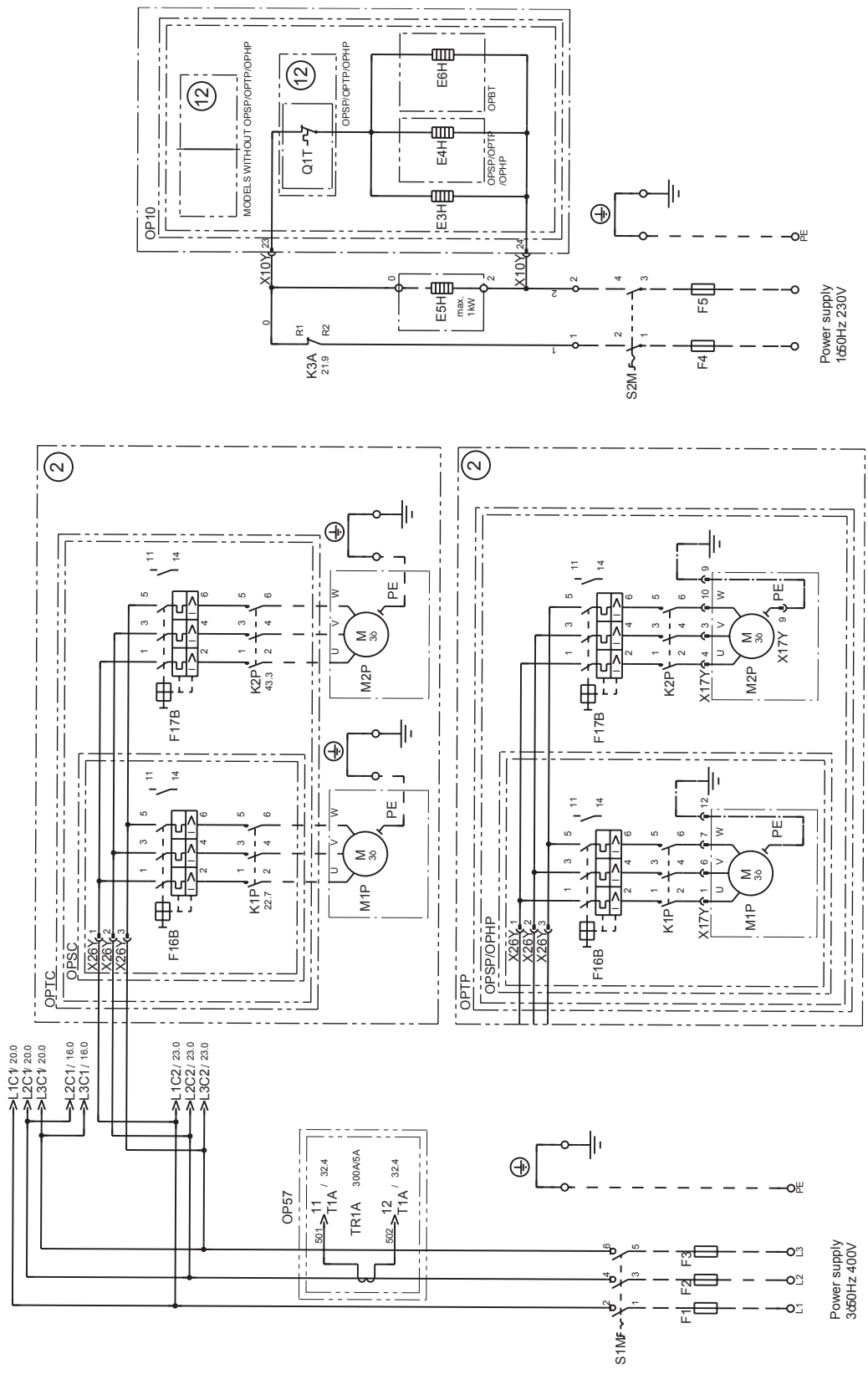

3.3.9 Trafo & PCB power supply

1

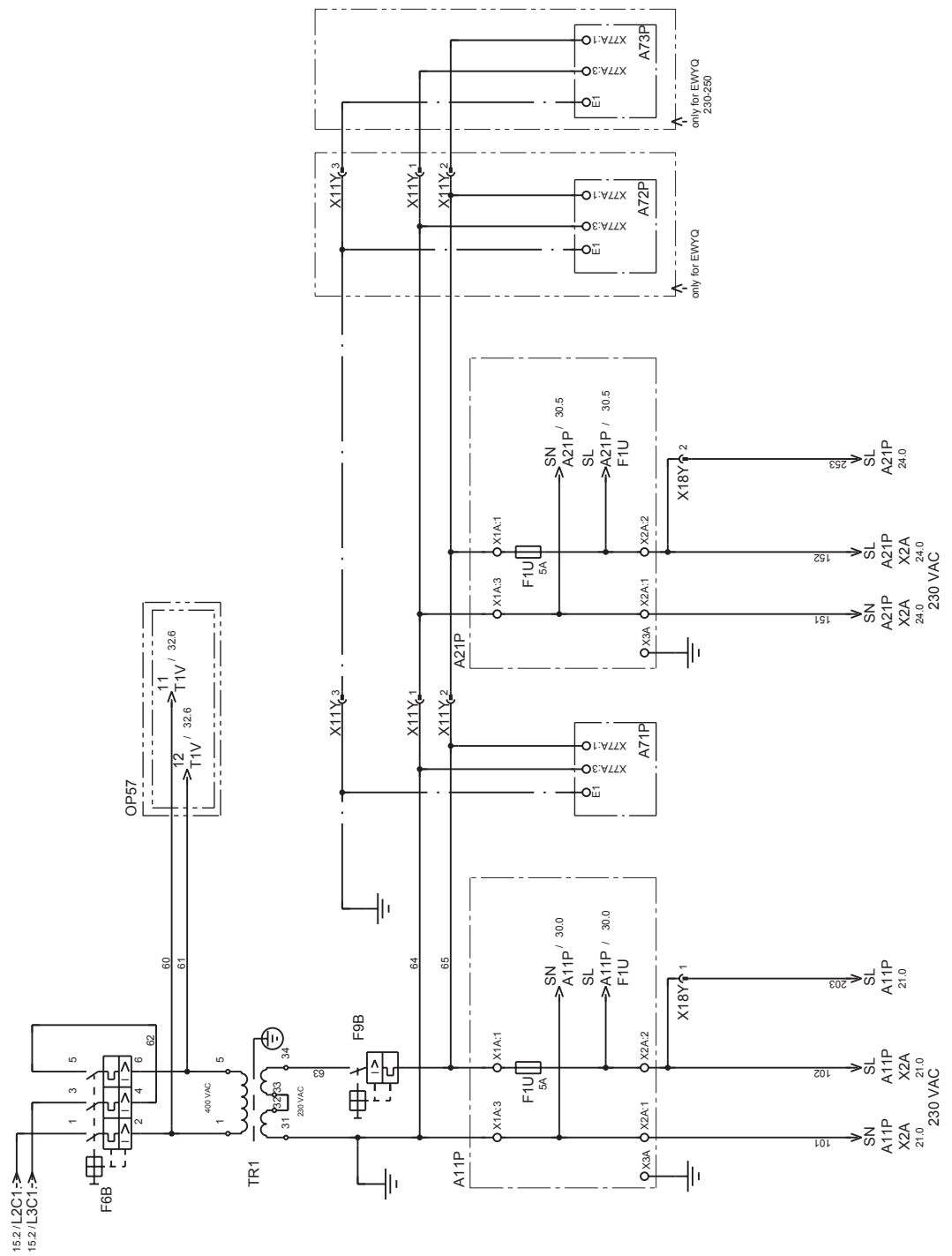

3.3.10 Circuit 1: compressor & fan

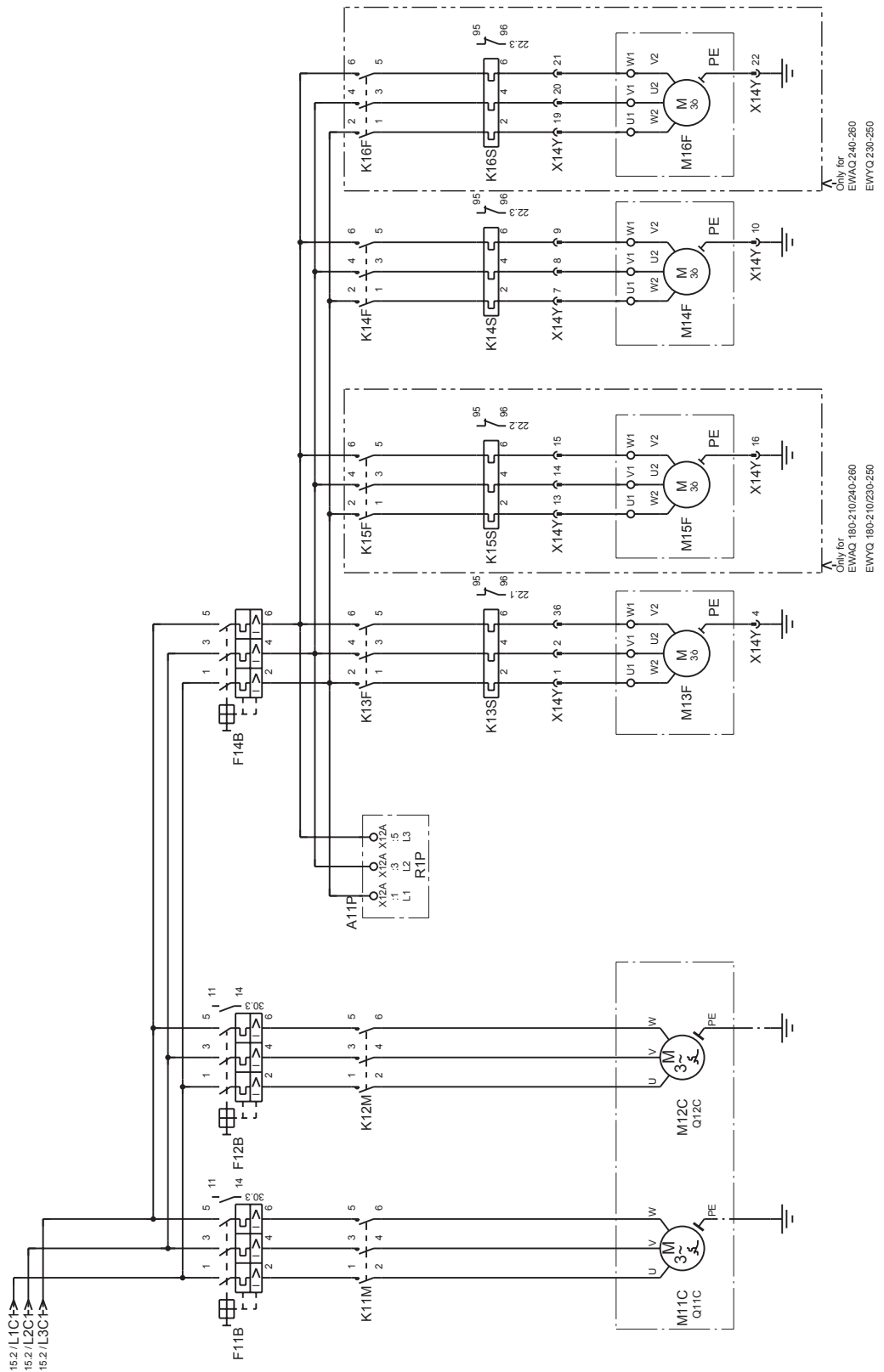

3.3.11 Circuit 1: control compressors

1

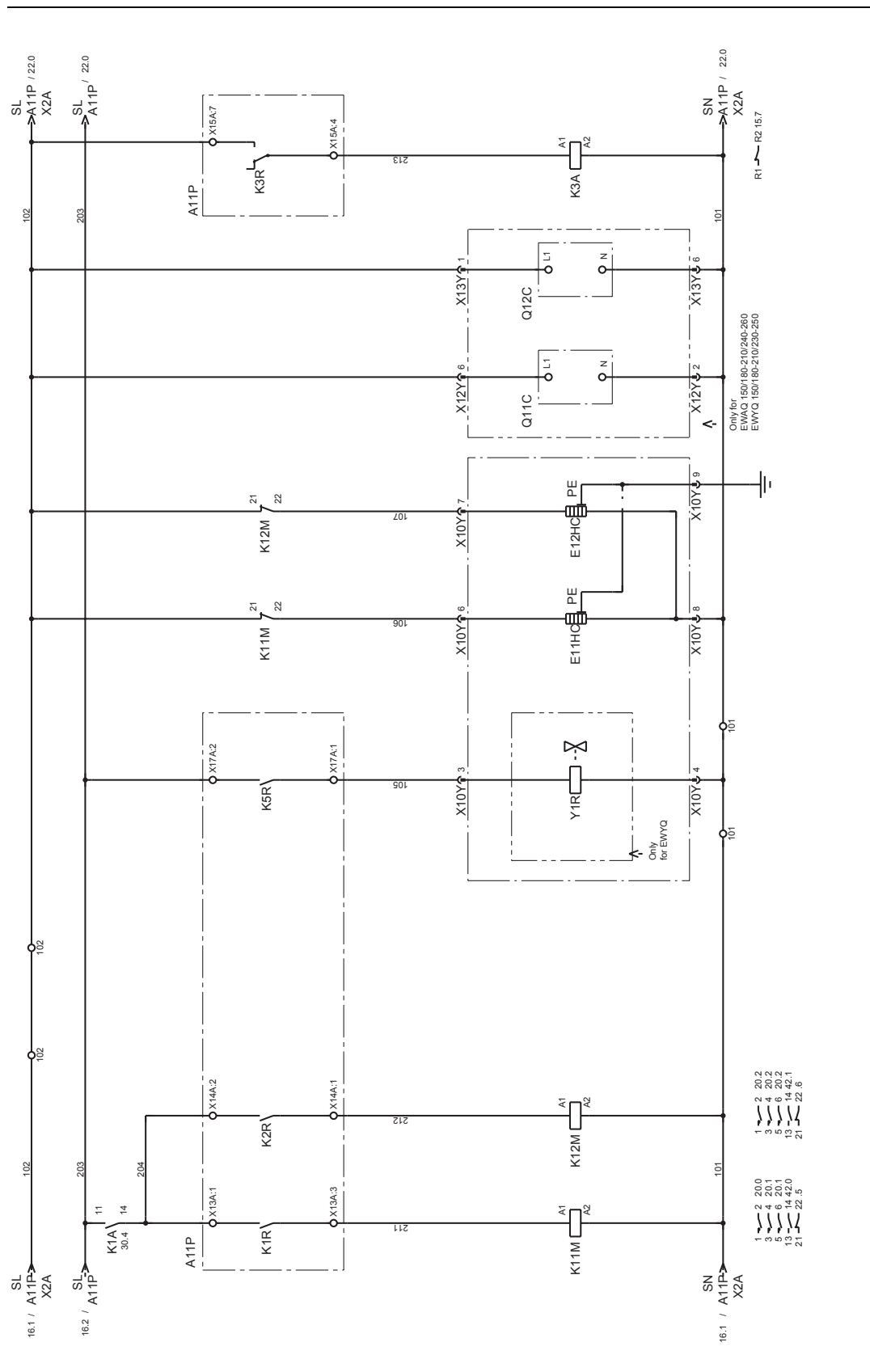

3.3.12 Circuit 1: control fans

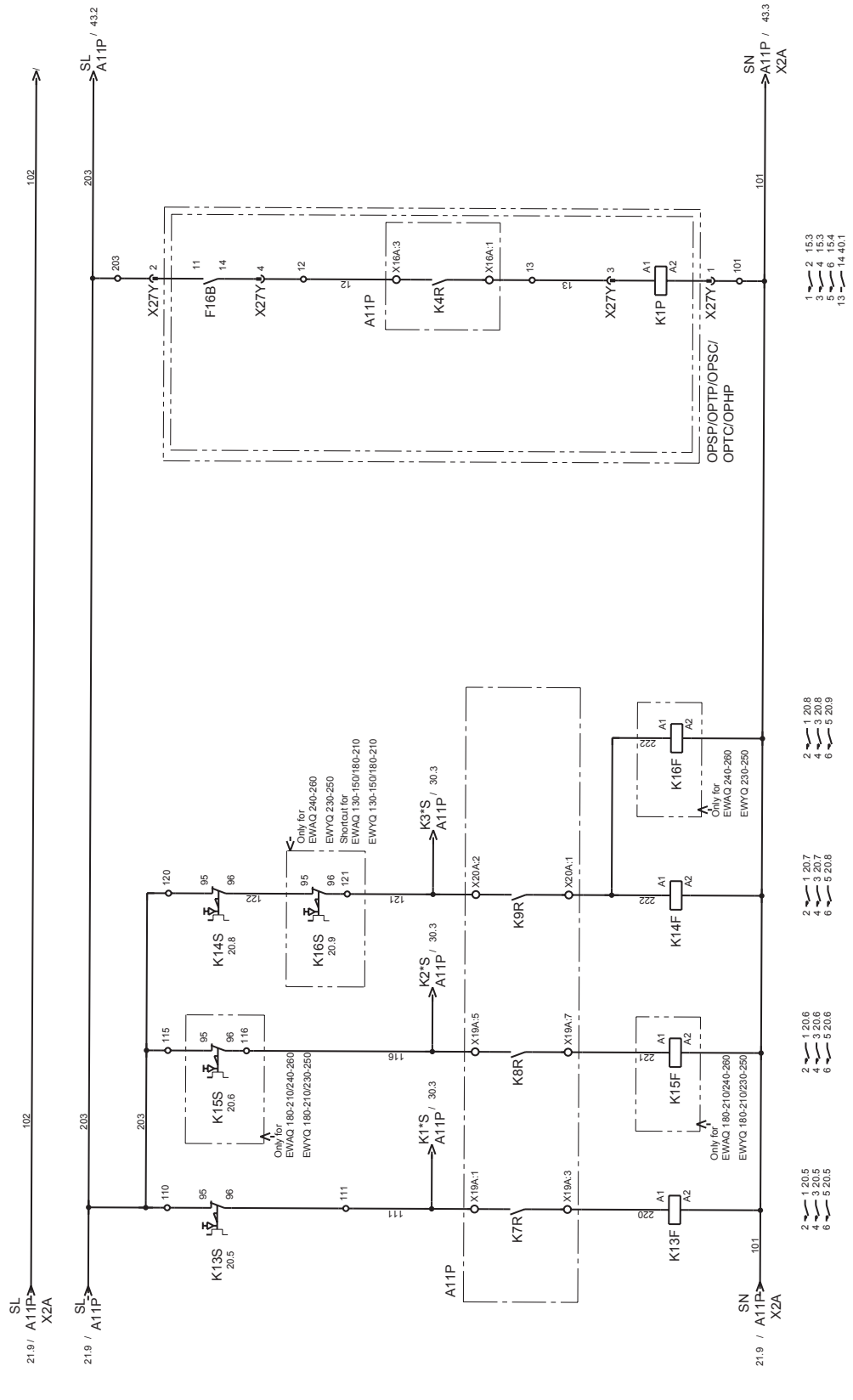

3.3.13 Circuit 2: compressor & fan

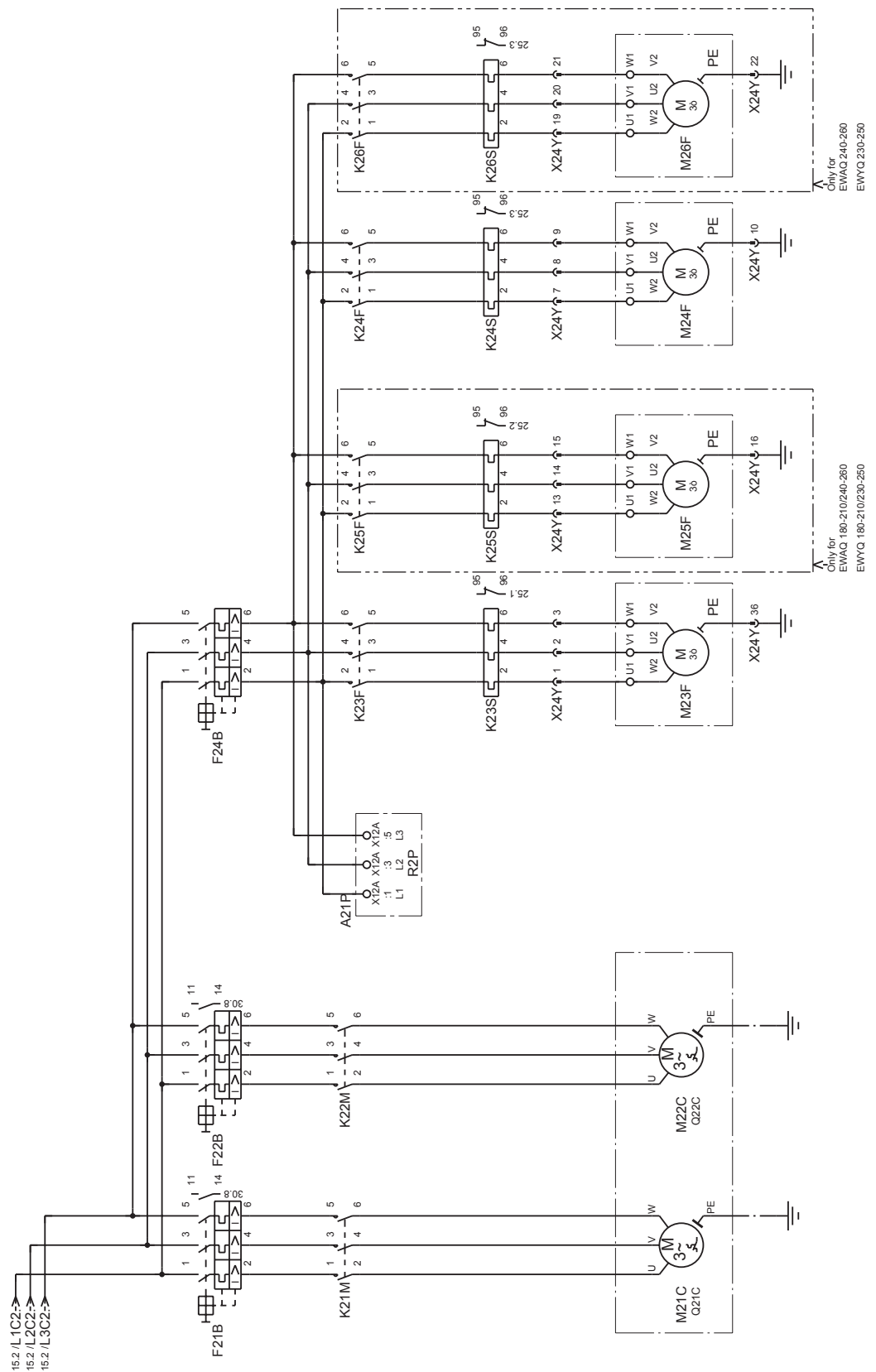

3.3.14 Circuit 2: control compressors

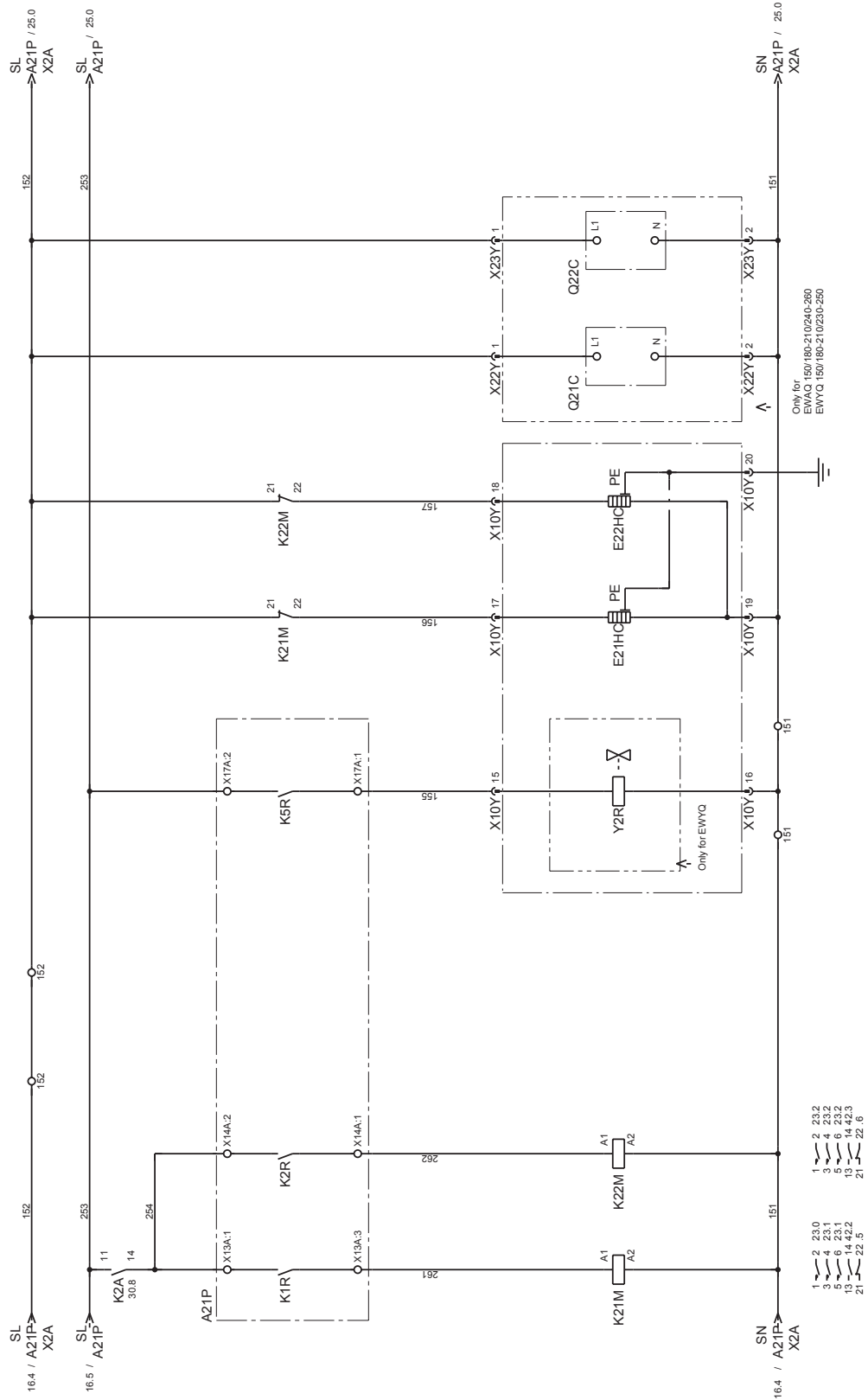

1

3.3.15 Circuit 2: control fans

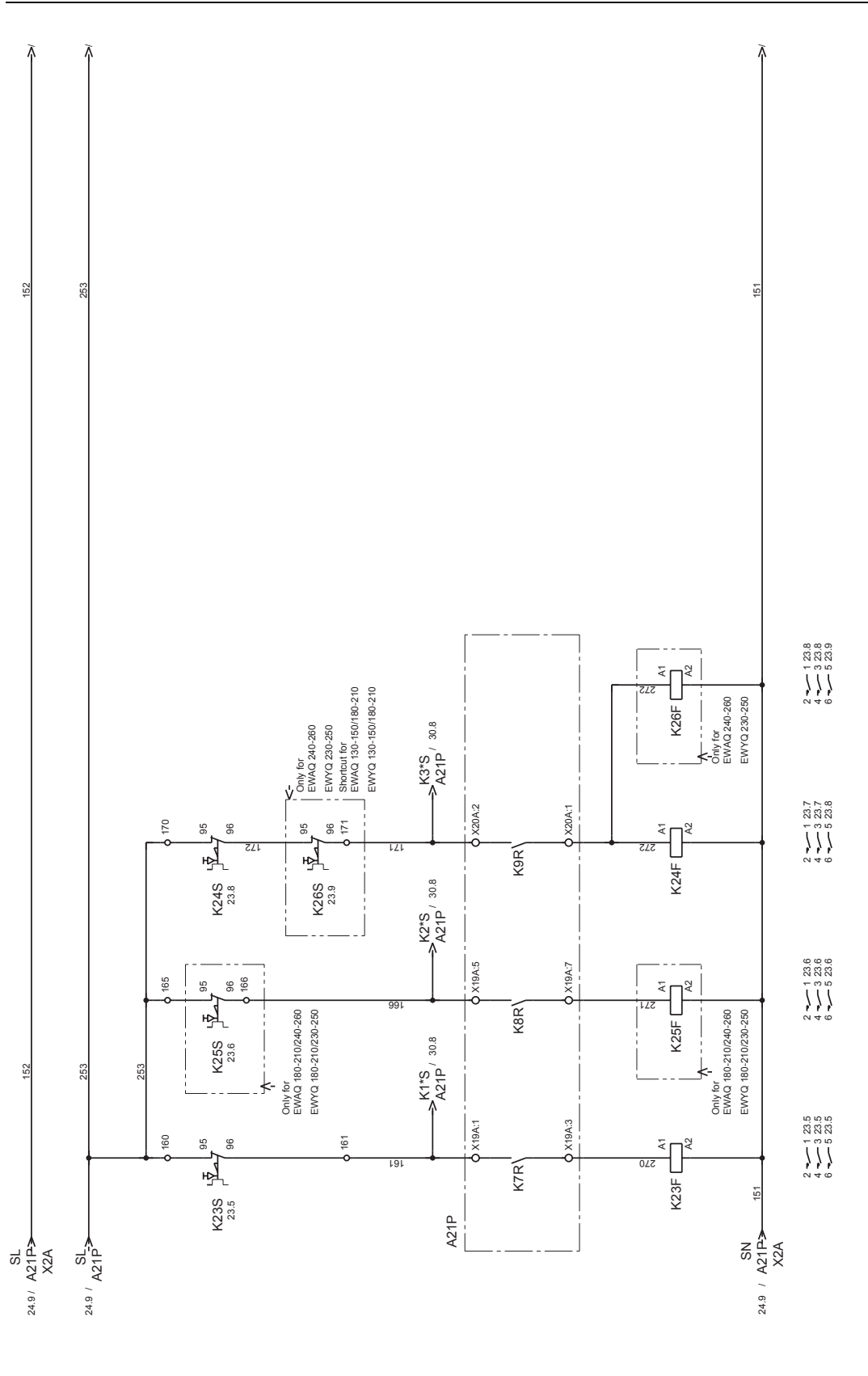

3.3.16 Control circuit (DI 230V)

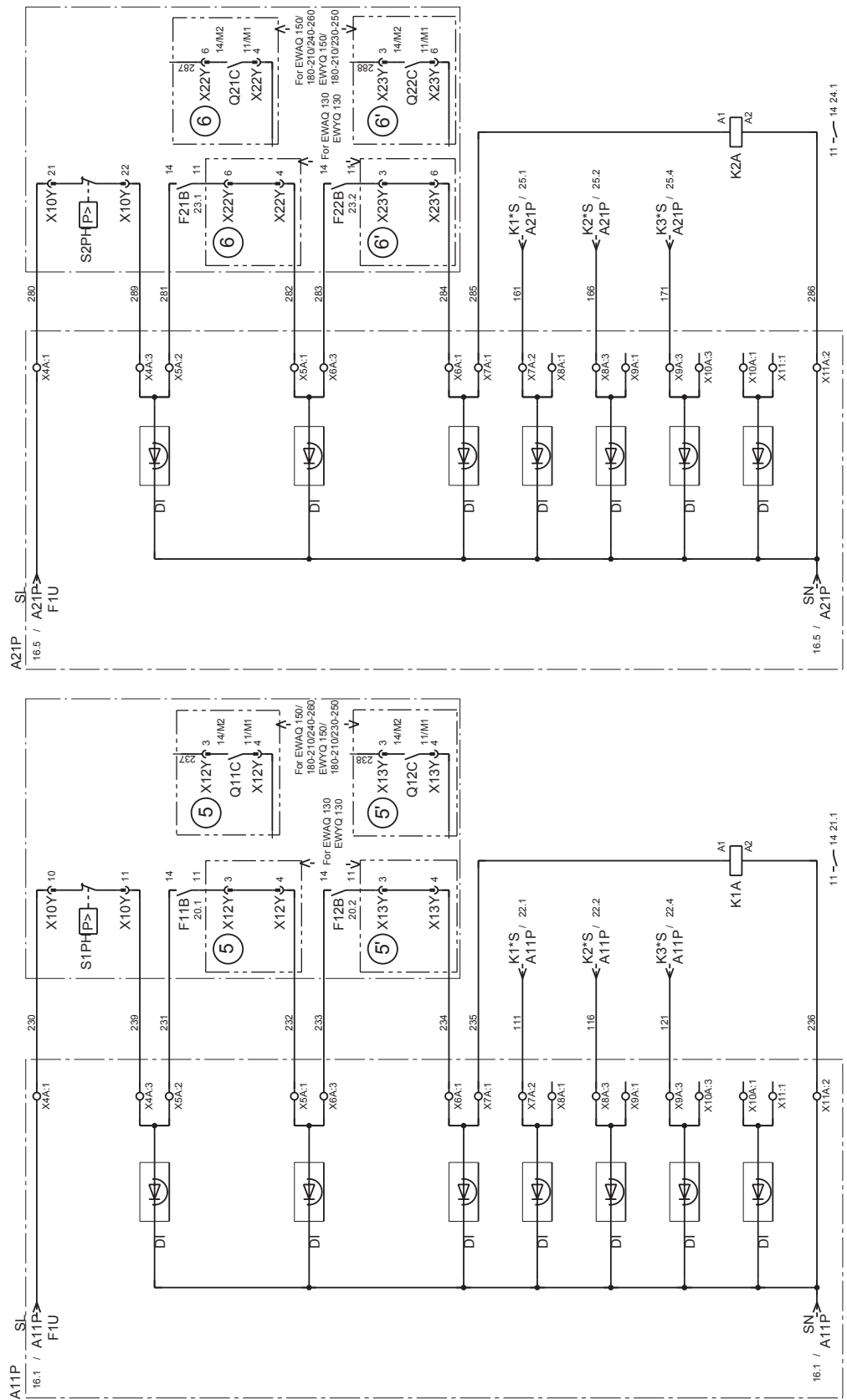

3.3.17 Control circuit and EEV

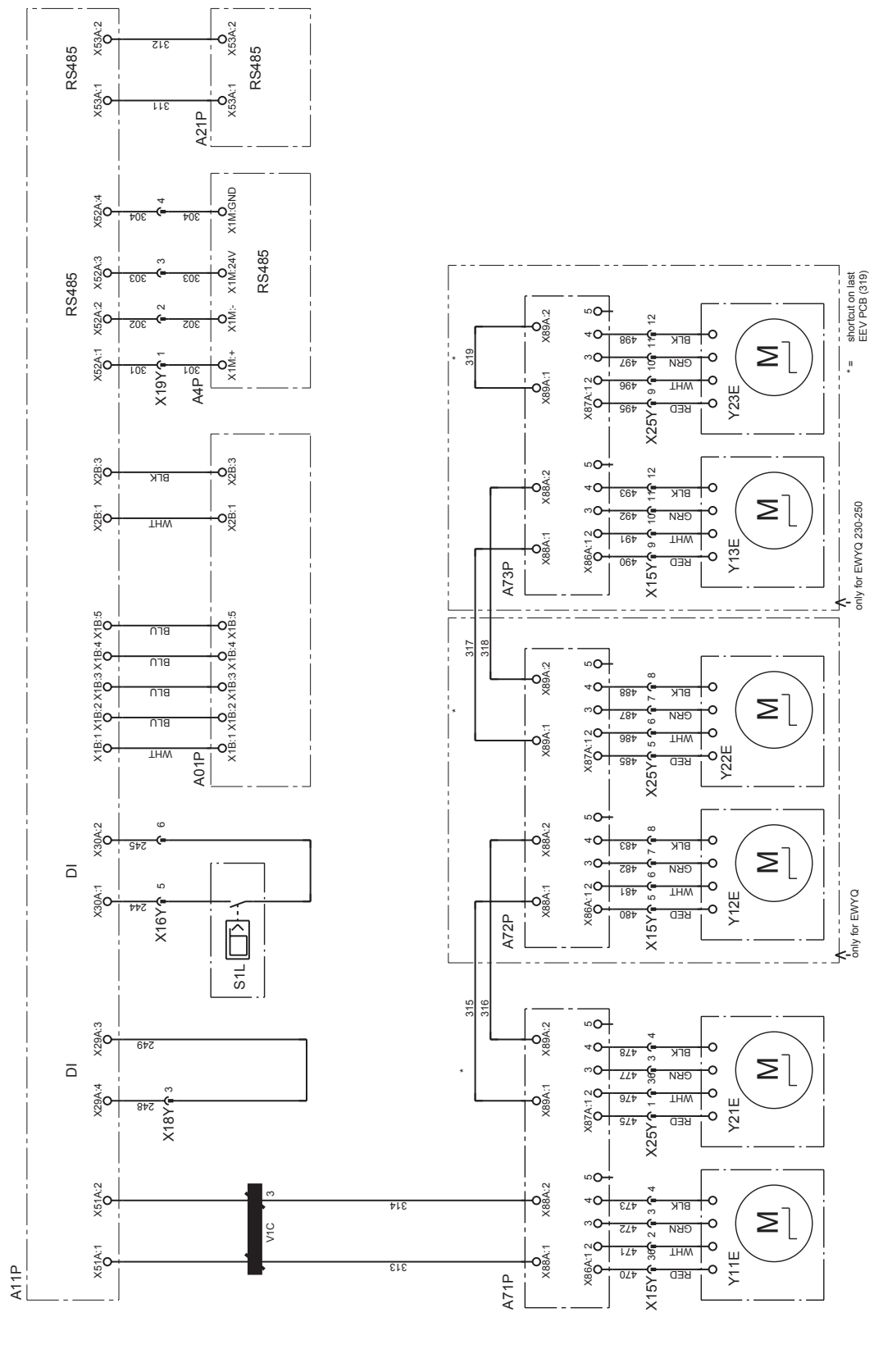

3.3.18 Circuit 1: sensors

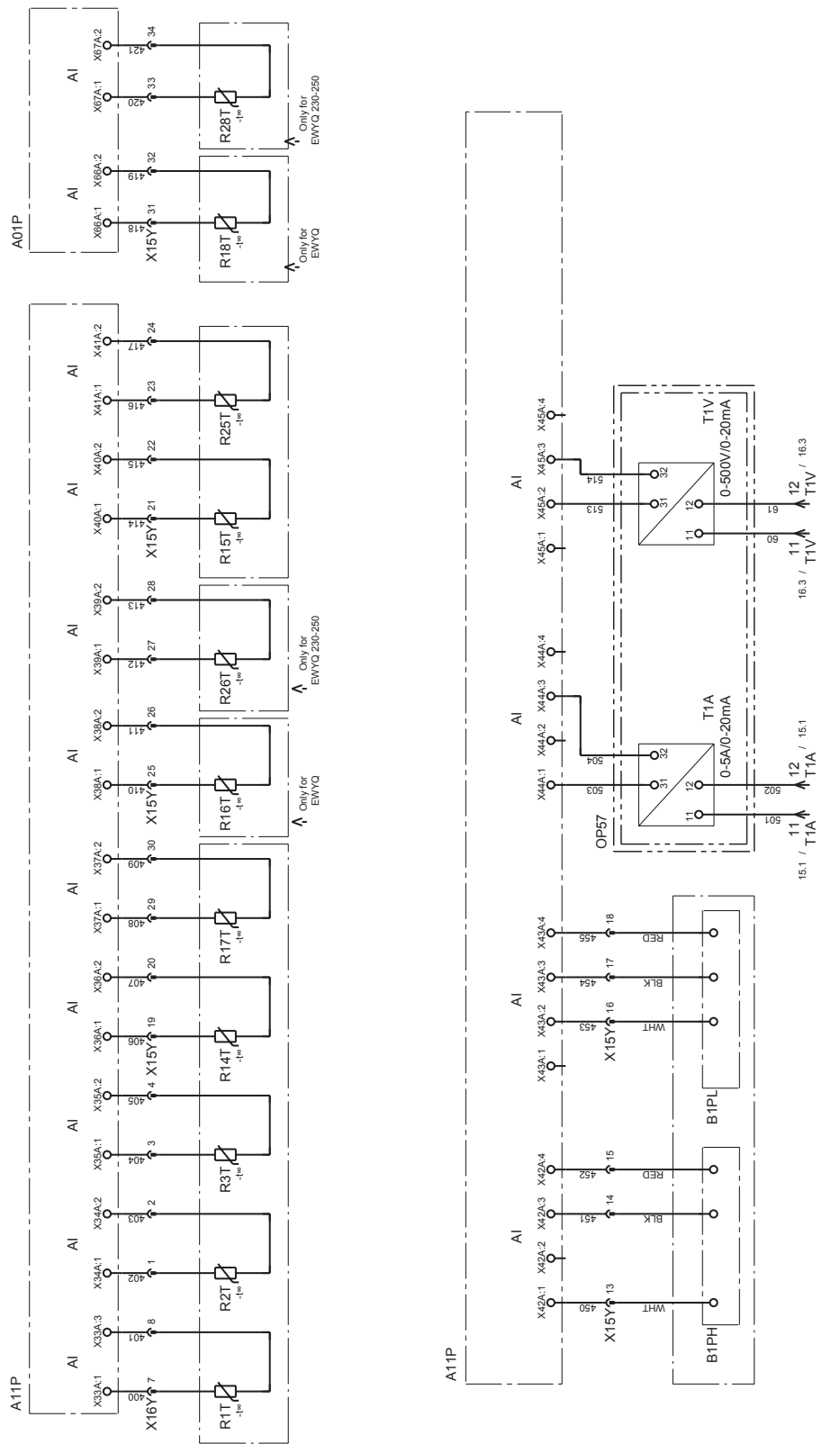

3.3.19 Circuit 2: sensors

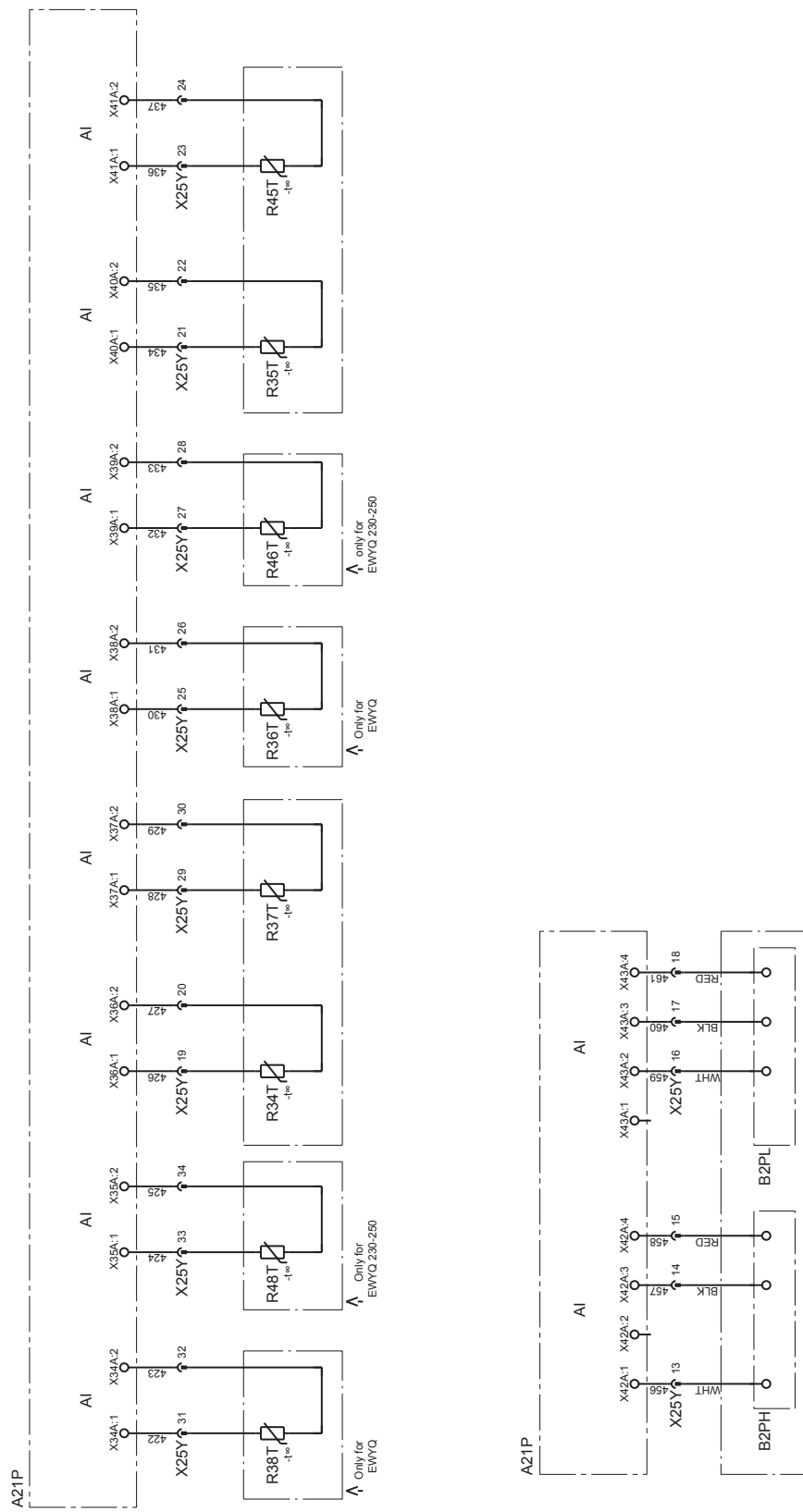

3.3.20 Fieldwiring DI, changeable DI

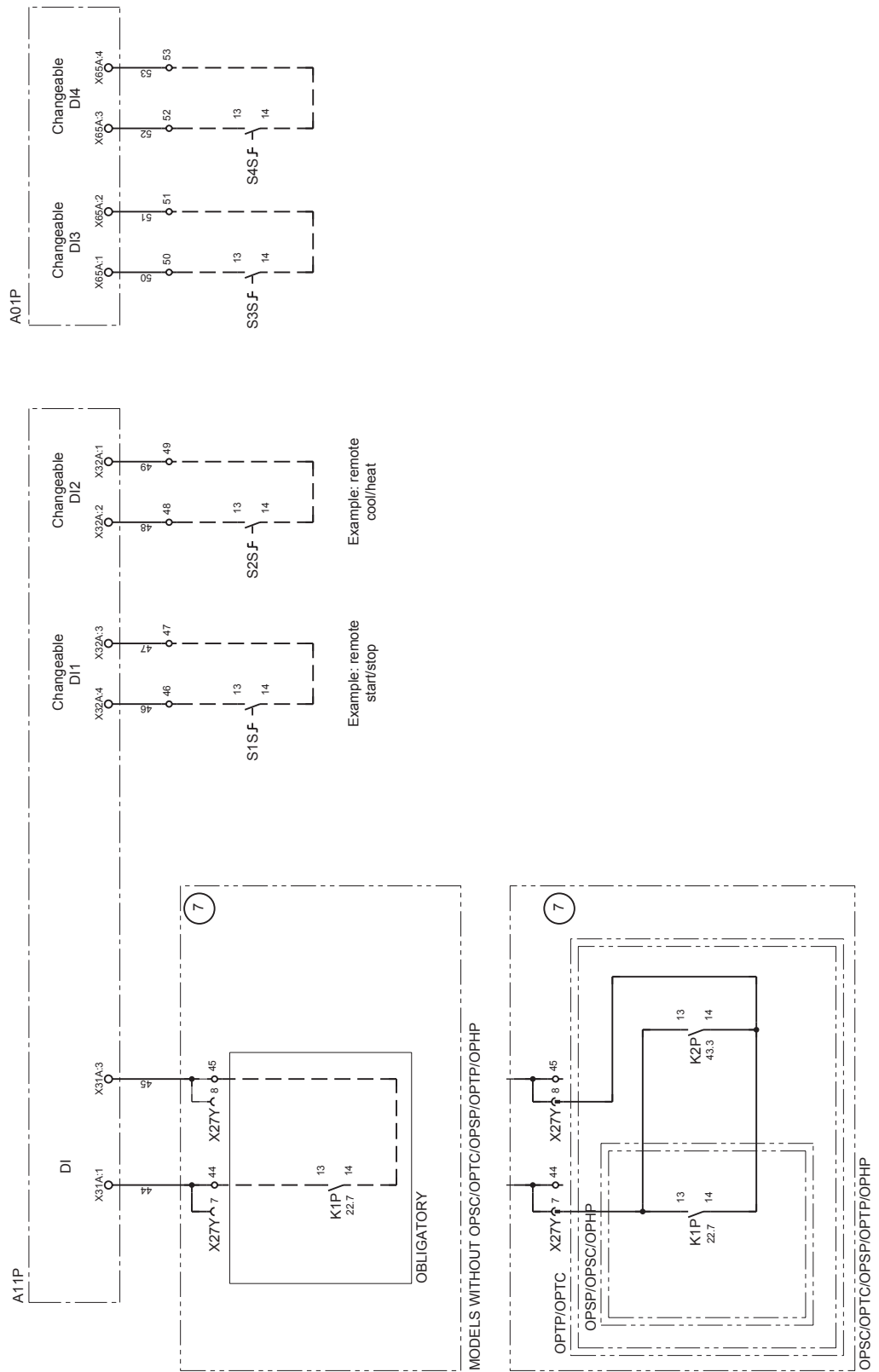

3.3.21 Fieldwiring changeable AI/AO

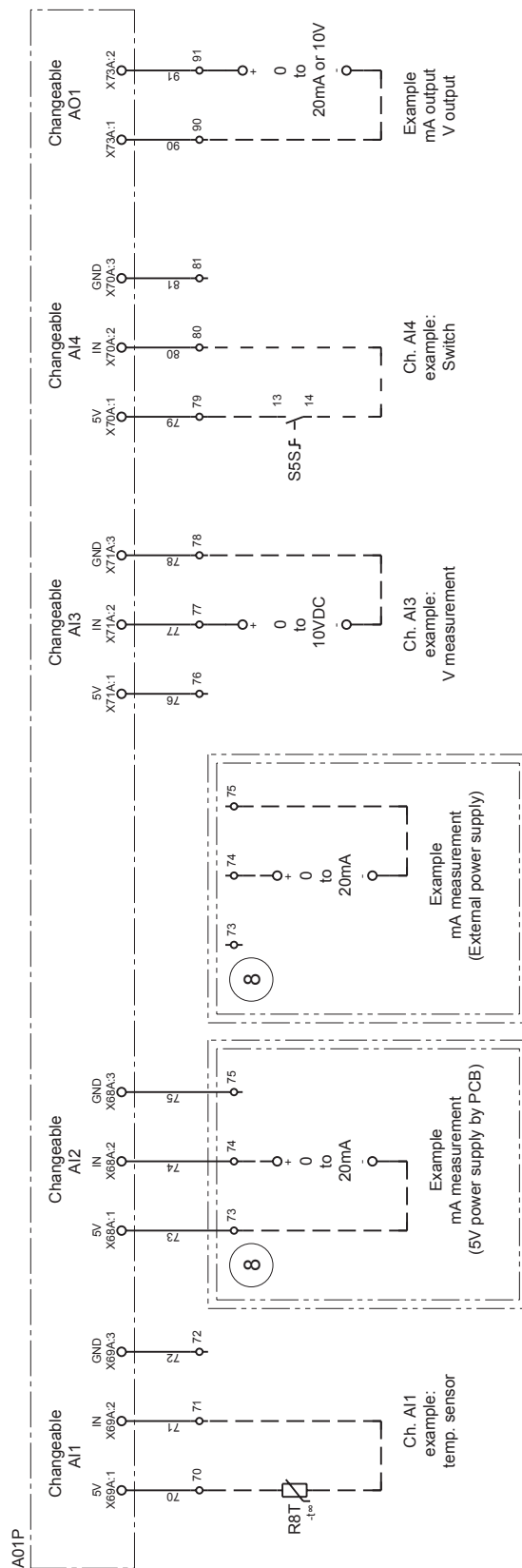

3.3.22 Fieldwiring DO, changeable DO

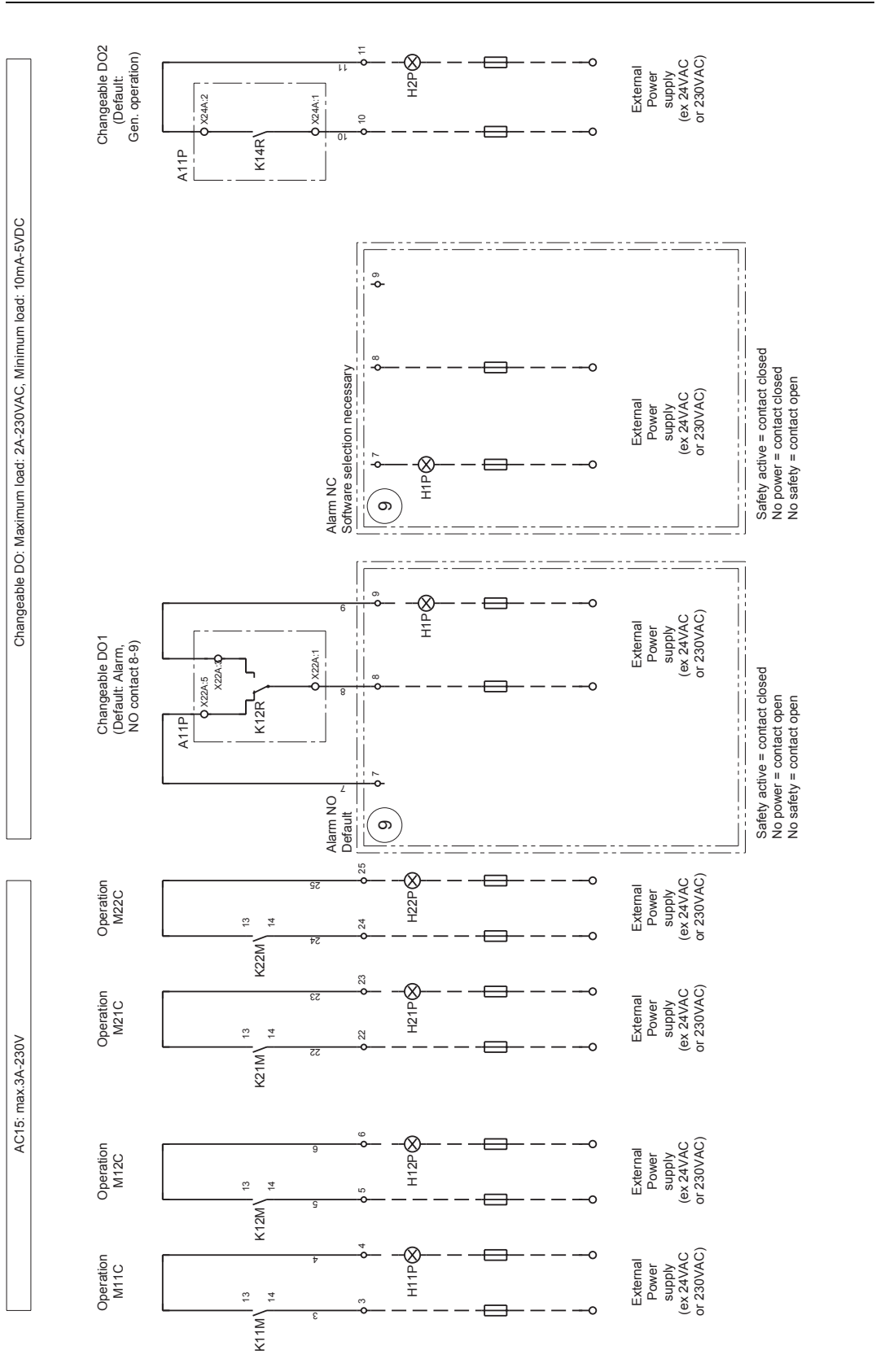

Ch. DO: Maximum load: 2A-230VAC, Minimum load: 10mA-5VDC

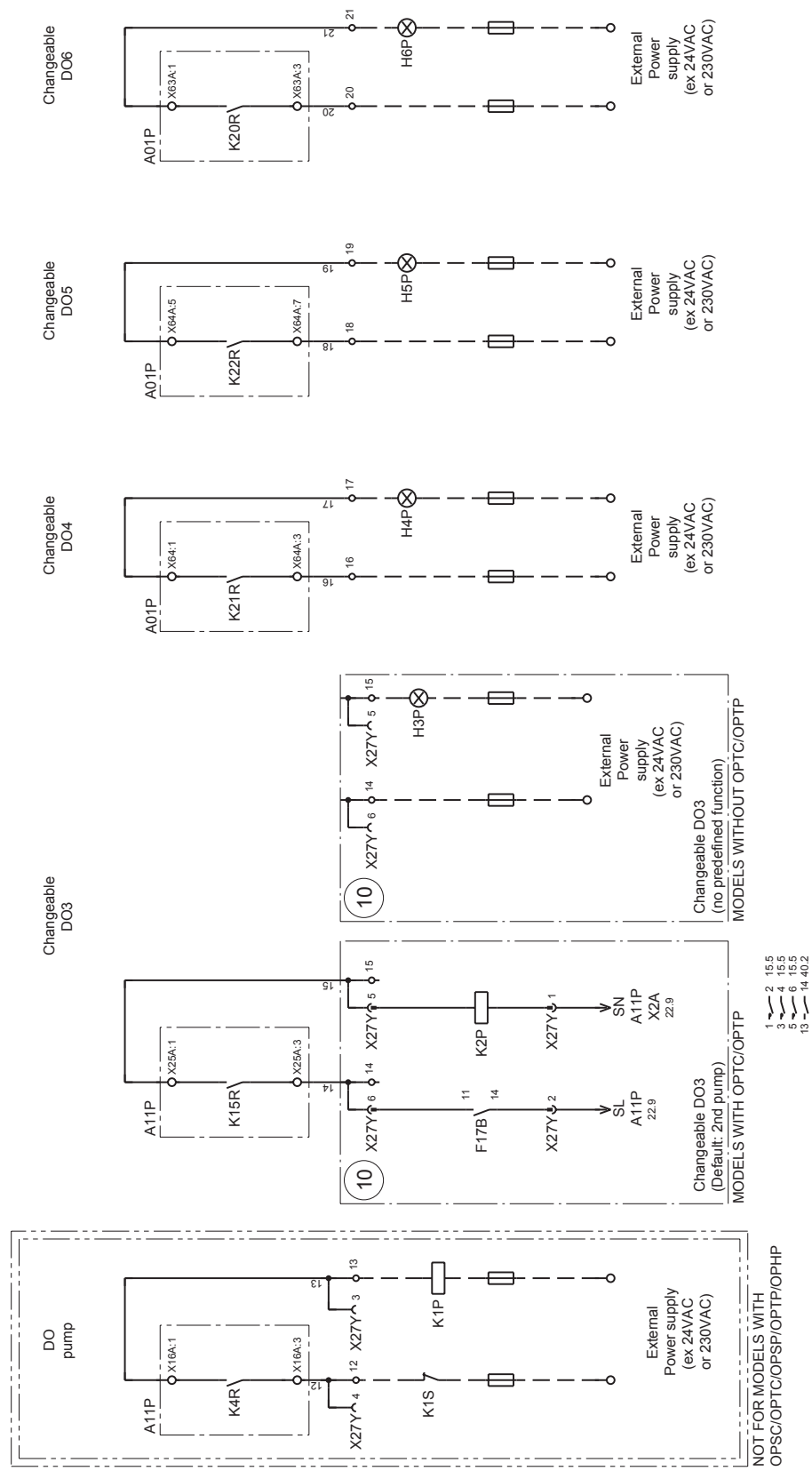

3.4 Wiring layout: EWAQ080-100DAYN(N-P-B) and EWYQ080-100DAYN(N-P-B) with OPIF

Introduction





This chapter gives a general overview of the PCB intercommunication, I/O overview, switchbox layout and wiring of the EWAQ080-100DAYN(N-P-B) and EWYQ080-100DAYN(N-P-B) with option inverter fans (OPIF).

Overview

This chapter contains the following topics:

Page description	Page
3.4.1 Notes	1–150
3.4.2 Legend	1–152
3.4.3 PCB interconnection diagram	1–157
3.4.4 PCB I/O overview & fuses	1–158
3.4.5 PCB changeable I/O overview	1–162
3.4.6 Unit outlook	1–163
3.4.7 Switchbox outlook (typical)	1–164
3.4.8 Main power supply	1–165
3.4.9 Trafo & PCB power supply	1–166
3.4.10 Compressor & fan	1–167
3.4.11 Circuit 1: control compressors	1–168
3.4.12 Circuit 1: control fans	1–169
3.4.13 Control circuit (DI 230V)	1–170
3.4.14 Control circuit and EEV	1–171
3.4.15 Circuit 1: sensors	1–172
3.4.16 Fieldwiring DI, changeable DI	1–173
3.4.17 Fieldwiring changeable AI/AO	1–174
3.4.18 Fieldwiring DO, changeable DO	1–175

3.4.1 Notes

L1, L2, L3	: Main terminals
1-99	: Fieldwiring terminals
100-199	: Factory upwiring terminals
200-	: Internal wiring terminals
U-Z	: Main terminals in compressor switchbox
_____	: Earth wiring
<u>15</u>	: Wire number 15
⊕15	: Terminals number 15
-----	: Field supply
	: Option
	: Not mounted in switchbox
	: Wiring depending on model
	: PCB
→**/12.2	: Connection ** continues on page 12 column 2
!	: Pin against miswiring
①	: Several wiring possibilities
N-model	: unit with no options included
Y1R, Y2R reversing valves are activated in cooling mode.	

Factory installed:	<input type="checkbox"/>	OP10	= Heater tape
	<input type="checkbox"/>	OP57	= A-meter, V-meter
	<input type="checkbox"/>	OPLN	= Low noise (OPIF+ Compressorhousing)
	<input type="checkbox"/>	OPTP	= Twinpump
	<input type="checkbox"/>	OPSC	= Single pump contactor
	<input type="checkbox"/>	OPTC	= Twin pump contactor
	<input type="checkbox"/>	OPIF	= Inverter fans for low ambient (-15°C)
	<input type="checkbox"/>	OPHP	= Hi ESP pump
	<input type="checkbox"/>	OPSP	= Single pump
	<input type="checkbox"/>	OPBT	= Buffertank
User installed:	<input type="checkbox"/>	EKACPG	= Address card including: -RS485 (Integrated modbus) -F1, F2 (DICN + DBACS Connection)
	<input type="checkbox"/>	EKRUPG	Remote used interface

Definitions:

- DI: Digital input
- DO: Digital output
- AI: Analog input
- AO: Analog output
- Ch: Changeable (function can be selected by the customer)

3.4.2 Legend

	Not included with standard unit	
	Not possible as option	Possible as option
Obligatory	#	##
Not obligatory	*	**

Part number		Description
A01P		PCB Extension
A02P	**	PCB Communication (EKACPG)
A4P		PCB wired remote controller
A5P	**	PCB wired remote controller (EKRUPG)
A11P, A21P		PCB main controller circuit 1, circuit 2
A13P, A23P	**	frequency inverter circuit 1, circuit 2 (OPIF)
A71P		PCB EEV driver
A72P		PCB EEV driver (only for EWYQ)
A73P		PCB EEV driver (only for EWYQ230-250)
B1PH, B2PH		high pressure sensor circuit 1, circuit 2
B1PL, B2PL		low pressure sensor circuit 1, circuit 2
DS1 (A*P)		PCB dipswitch
E1HS	**	switchbox heater with fan (OPIF) (only for EWAQ130-260 / EWYQ130-250)
E3H	**	heatertape (OP10)
E4H	**	heatertape (OP10) (only for OPSP/OPHP/OPTP)
E5H	*	fieldheater
E6H	**	buffertank heater (OP10) (only for OPBT)
E7H	**	switchbox heater (OPIF) (only for EWA/YQ80-100)
E11HC, E12HC		crankcase heater compressor circuit 1
E21HC, E22HC		crankcase heater compressor circuit 2
F1-F3	#	main fuses
F1U (A*P)		fuse PCB
F4, F5	#	fuses for heaters
F6B		autofuse for primary of TR1
F8B	**	autofuse for switchbox heater (OPIF)
F9B		autofuse for secondary of TR1
F11B, F12B		autofuse for compressors (M11C, M12C) (Not for EWA/YQ80-100)

Part number		Description
F14B, F24B		autofuse for fan motors circuit 1, circuit 2
F15B, F25B	**	autofuse for fan motors circuit 1, circuit 2 (OPIF)
F16B	**	autofuse for pump (K1P) (only for OPSP/OPHP/OPSC/OTPT/OPTC)
F17B	**	autofuse for pump (K2P) (only for OPTP/OPTC)
F21B, F22B		autofuse for compressors (M21C, M22C)
H1-6P	*	indication lamp for changeable digital outputs
H11P, H12P	*	indication lamp for operation compressor circuit 1 (M11C, M12C)
H21P, H22P	*	indication lamp for operation compressor circuit 1 (M21C, M22C)
HAP-HEP (A*P)		light emitting diode PCB
K1A, K2A		auxiliary relay for compressor safety circuit 1, circuit 2
K1P	##	pump contactor (only for OPSP/OPHP/OPSC/OTPT/OPTC)
K1S	*	overcurrent relay pump
K1R-K22R (A*P)		PCB relay
K2P	**	pump contactor (only for OPTP/ OPTC)
K3A		auxiliary relay for heater tape
K11M, K12M		compressor contactor for circuit 1
K13F, K14F		fancontactor for circuit 1
K13S, K14S		fan overcurrent relay for circuit 1
K15F		fancontactor for circuit 1 (Only for EWAQ80-100/180-210/240-260) (Only for EWYQ80-100/180-210/230-250)
K15S		fan overcurrent relay for circuit 1 (Only for EWAQ80-100/180-210/240-260) (Only for EWYQ80-100/180-210/230-250)
K16F		fancontactor for circuit 1 (Only for EWAQ80-100/240-260) (Only for EWYQ80-100/230-250)
K16S		fan overcurrent relay for circuit 1 (Only for EWAQ80-100/240-260) (Only for EWYQ80-100/230-250)
K21M, K22M		compressor contactor for circuit 2
K23F, K24F		fancontactor for circuit 2
K23S, K24S		fan overcurrent relay for circuit 2
K25F		fancontactor for circuit 2 (Only for EWAQ180-210/240-260) (Only for EWYQ180-210/230-250)

1

Part number		Description
K25S		fan overcurrent relay for circuit 2 (Only for EWAQ180-210/240-260) (Only for EWYQ180-210/230-250)
K26F		fancontactor for circuit 2 (Only for EWAQ240-260) (Only for EWYQ230-250)
K26S		fan overcurrent relay for circuit 2 (Only for EWAQ240-260) (Only for EWYQ230-250)
M1P	**	pump motor 1 (only for OPSP/OPHP/OPSC/OTPT/OPTC)
M2P	**	pump motor 2 (only for OPTP/OPTC)
M11C, M12C		compressor motors circuit 1
M13F, M14F		fan motors circuit 1
M15F		fan motors circuit 1 (Only for EWAQ80-100/180-210/240-260) (Only for EWYQ80-100/180-210/230-250)
M16F		fan motors circuit 1 (Only for EWAQ80-100/240-260) (Only for EWYQ80-100/230-250)
M21C, M22C		compressor motors circuit 2
M23F, M24F		fan motors circuit 2
M25F		fan motors circuit 2 (Only for EWAQ180-100/240-260) (Only for EWYQ180-100/230-250)
M26F		fan motors circuit 2 (Only for EWAQ240-260) (Only for EWYQ230-250)
M1F		switchbox fanmotor
Q1T	**	thermostat (OP10)
Q11C, Q12C		For EWAQ130/EWYQ130: thermal protector compressor circuit 1 For EWAQ80-100/150/180-210/240-260: For EWYQ80-100/150/180-210/230-250: electronic protection module compressor circuit 1
Q21C, Q22C		For EWAQ130/EWYQ130: thermal protector compressor circuit 2 For EWAQ150/180-210/240-260: For EWYQ150/180-210/230-250: electronic protection module compressor circuit 2

Part number		Description
R1T		ambient temperature sensor
R2T		inlet water temperature sensor
R3T		outlet water temperature sensor
R8T	*	temperature sensor for changeable analog input
R14T		suction temperature sensor circuit 1
R15T, R25T		discharge temperature sensor circuit 1
R16T		coil temperature sensor circuit 1 (only for EWYQ)
R17T		refrigerant piping temperature sensor circuit 1
R18T, R38T		heating suction temperature sensor circuit 1, circuit 2 (only EWYQ)
R28T, R48T		heating suction temperature sensor circuit 1, circuit 2
R26T		coil temperature sensor circuit 1 (only for EQWYQ80-100/230-250)
R34T		suction temperature sensor circuit 2
R35T, R45T		discharge temperature sensor circuit 2
R36T		coil temperature sensor circuit 2 (only for EWYQ)
R37T		refrigerant piping temperature sensor circuit 2
R46T		coil temperature sensor circuit 2 (only for EWYQ230-250)
S1A-S3A (A*P)		PCB dipswitch
S1L		flowswitch
S1M		main isolator switch
S1PH, S2PH		high pressure switch circuit 1, circuit 2
S1S-S5S	*	switch for changeable digital input (remote on/off, C/H, ...)
S1T	**	thermal contact (OPIF)
S2M	#	heatertape isolator switch
T1A	**	current transducer (OP57)
T1V	**	voltage transducer (OP57)
TR1		transfo control circuit (400V/230V)
TR1A	**	current measurement transfo (OP57)
V1C		Ferrite core
V1F, V2F	**	noise filter circuit 1, circuit 2 (OPIF) (Only for EWAQ130-150/180-210) (Only for EWYQ130-150/180-210)
V2C	**	Ferrite core (EKACPG)
X*A (A*P)		PCB terminal
X*Y		connector
X1M (A*P)		PCB terminal strip

1

Part number	Description
Y1R, Y2R	reverse valve circuit 1, circuit 2 (only EWYQ)
Y11E	electronic expansion valve cooling circuit 1
Y12E	electronic expansion valve heating circuit 1 (only EWYQ)
Y13E	electronic expansion valve heating circuit 1 (only EWYQ80-100/230-250)
Y21E	electronic expansion valve cooling circuit 2
Y22E	electronic expansion valve heating circuit 2 (only EWYQ)
Y23E	electronic expansion valve heating circuit 2 (only EWYQ 230-250)

3.4.3 PCB interconnection diagram

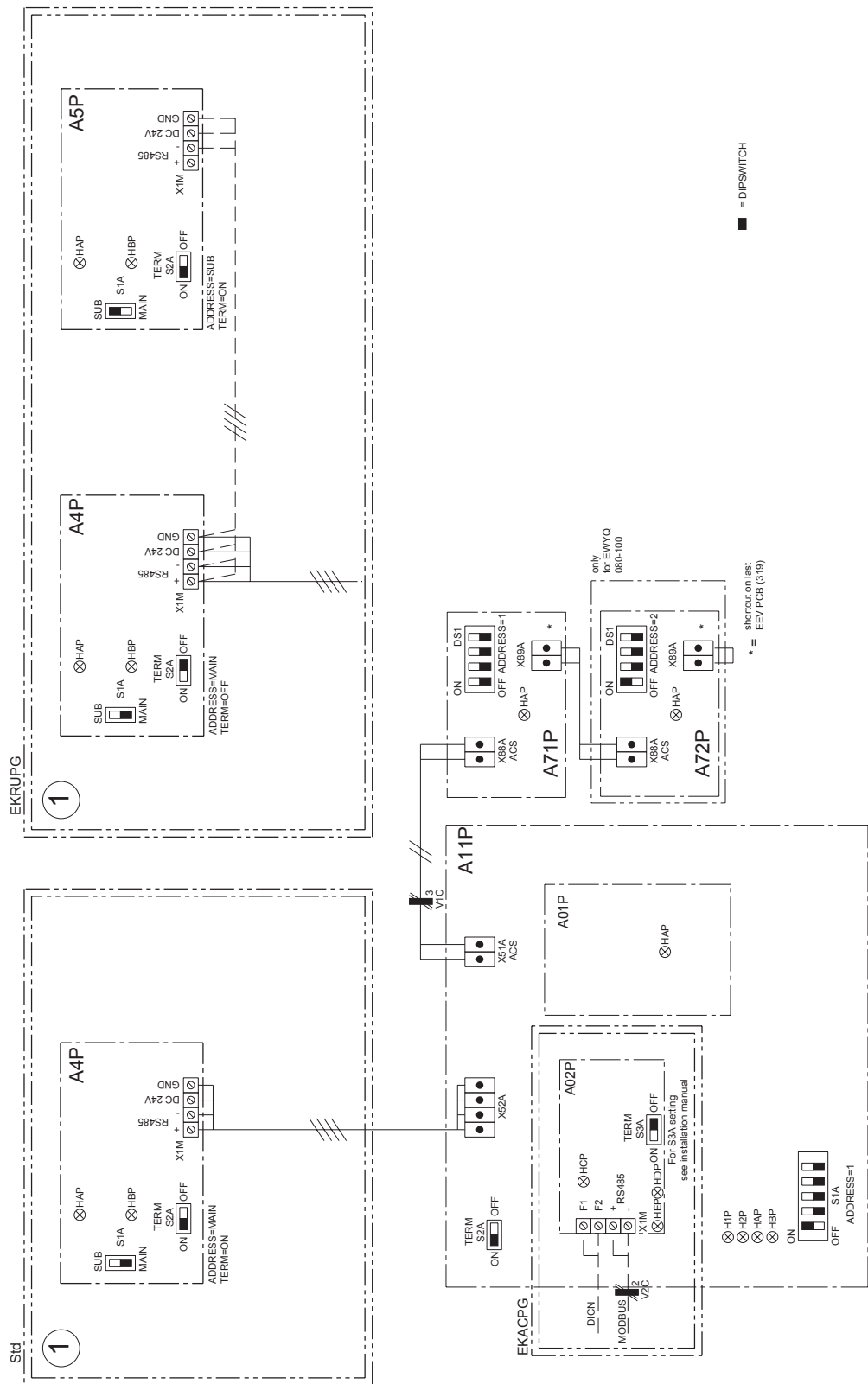

3.4.4 PCB I/O overview & fuses

Main PCB (A11P)	
X12A (1-3-5)	DI: Reverse phase detection (L1-L2-L3) c1
X4A	DI: High pressure switch c1
X5A	DI: Compressor interlock 1 c1
X6A	DI: Compressor interlock 2 c1
X7A	DI: Fan overcurrent relay Fanstep 1 c1
X8A	DI: Fan overcurrent relay Fanstep 2 c1
X9A	DI: Fan overcurrent relay Fanstep 3 c1
X27A	DI: Fan inv safety c1 (only for OPIF)
X29A (3-4)	not used
X30A	DI: Flow switch
X31A	DI: Pump interlock
X32A (3-4)	Ch DI 1: function not pre-defined
X32A (1-2)	Ch DI 2: function not pre-defined
X13A	DO: Compressor contactor 1 c1
X14A	DO: Compressor contactor 2 c1
X15A	DO: Heaters tape
X16A	DO: Pump contactor
X17A	DO: Reverse valve c1 (Only for EWYQ)
X19A (1-3)	DO: Fanstep 1 c1
X19A (5-7)	DO: Fanstep 2 c1
X20A	DO: Fanstep 3 c1
X22A	Ch DO1: "SAFETY + W. (NO)" (def)
X24A	Ch DO2: "GEN. OPERATION" (def)
X25A	Ch DO3: function not pre-defined
X33A	AI: Ambient sensor
X34A	AI: Inlet water sensor
X35A	AI: Outlet water sensor
X36A	AI: Suction temperature sensor c1
X37A	AI: Refrigerant piping temperature sensor c1
X38A	AI: Coil temperature sensor 1 c1 (only for EWYQ)
X39A	AI: Coil temperature sensor 2 c1 (only for EWYQ)
X40A	AI: Discharge temperature sensor 1 c1

X41A	AI: Discharge temperature sensor 2 c1
X42A	AI: High pressure sensor c1
X43A	AI: Low pressure sensor c1
X44A	AI: Current measurement (OP57)
X45A	AI: Voltage measurement (OP57)
HAP, HBP	LED (service monitor green)
H1P, H2P	LED (service monitor red)
S1A	dipswitch (address)
S2A	dipswitch (terminal resistor)

Extension PCB (A01P)	
X63A	Ch DO6: Function not pre-defined
X64A (1-3)	Ch DO4: Function not pre-defined
X64A (5-7)	Ch DO5: Function not pre-defined
X65A (1-2)	Ch DI3: Function not pre-defined
X65A (3-4)	Ch DI4: Function not pre-defined
X66A	AI: Heating suction temperature sensor 1 c1 (Only for EWYQ)
X67A	AI: Heating suction temperature sensor 2 c1 (Only for EWYQ)
X68A	Ch AI2: Function not pre-defined
X69A	Ch AI1: Function not pre-defined
X70A	Ch AI 4: Function not pre-defined
X71A	Ch AI3: Function not pre-defined
X72A (3-4)	AO: Fanspeed signal c1 (only for OPIF)
X73A	Ch AO1: Function not pre-defined
X74A (4-5)	not used
HAP, HBP	LED (service monitor green)

Wired remote controller PCB (A4P, A5P)	
HAP, HBP	LED (service monitor green)
S1A	dipswitch (address)
S2A	dipswitch (terminal resistor)

1

Communication PCB (A02P)	
HCP, HDP, HEP	LED (service monitor green)
S3A	dipswitch (terminal resistor)

EEV PCB (A71P)	
X86A	Y11E Electronic expansion valve
X87A	not used
HAP	LED (service monitor green)
DS1	dipswitch (address)

EEV PCB (A72P) (Only EWYQ)	
X86A	Y12E Electronic expansion valve (only EWYQ)
X87A	Y13E Electronic expansion valve (only EWYQ)
HAP	LED (service monitor green)
DS1	dipswitch (address)

	EWAQ80 EWYQ80	EWAQ100 EWYQ100
FUSES		
F1-F3	125gL/gG 500V	160gL/ gG 500V
F1U	T 5A/250V	T 5A/250V
F4, F5	10gL/250V	10gL/250V
Circuit breakers		
F8B (OPIF)	C 2A/250V	C 2A/250V
F9B	C 4A/250V	C 4A/250V
Circuit breaker and motor protector settings		
F6B	2,3A	2,3A
F11B	-	-
F12B	-	-
F16B (OPSP/OPSC/OPTP/OPTC)	4,8A	4,8A
F16B (OPHP)	12,0A	12,0A

F17B (OPTP/OPTC)	4,8A	4,8A
F14B	3,3A	3,3A
F15B (OPIF)	7,7A	7,7A
K13S-K16S	1,5A	1,5A

3.4.5 PCB changeable I/O overview

Refer to the installation manual for instructions how to configure changeable I/O.

Changeable digital input (4 available)
-None
-Status
-Dual setpoint
-Remote on-off
-Capacity limitation 25%, 50%, 75%, or setting
-Low noise (only for OPIF)
-Free cooling signal
-Fan forced on

Changeable analog output (1 available)
-None
-Unit capacity (mA, V)
-Details of types:
Type mA: 0..20mA / 4..20mA
Type V: 0-1V / 0-5V / 0-10V

Changeable digital output (6 or 5 available depending on unit)
-None (open)
-Closed
-2nd pump
-100% capacity
-Full capacity
-Free cooling
-General operation
-Safety + warning NO
-Safety + warning NC (only for ch DO1)
-Safety NO (excluding warning)
-Safety NC (excluding warning) (only for ch DO1)
-C1, C2 Safety NO
-Warning NO
-C1, C2 operation
-Cooling (only EWYQ)
-Heating (only EWYQ)
-Defrost (only EWYQ)

Changeable analog input (4 available)
-None
-Status (mA, V, NTC*, DI)
-Floating setpoint (mA, V, NTC*)
-Water temperature measurement (NTC*)
-Changeable DI, refer to Ch DI for possibilities (DI)
-Details of types:
Type mA: 0..20mA / 4..20mA
(internal 5V or external power supply)
Type V: 0-1V / 0-5V / 0-10V
Type DI: DI (5V detection)
*: for allowed NTC types and how to configure the software please contact your local dealer.

3.4.6 Unit outlook

TOP VIEW OF UNIT (FANS)

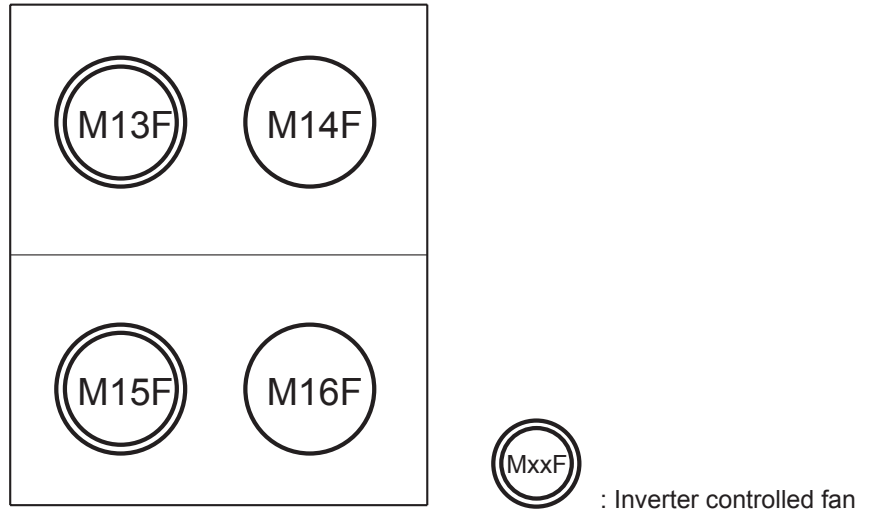

TOP VIEW OF UNIT (COMP+ SB)

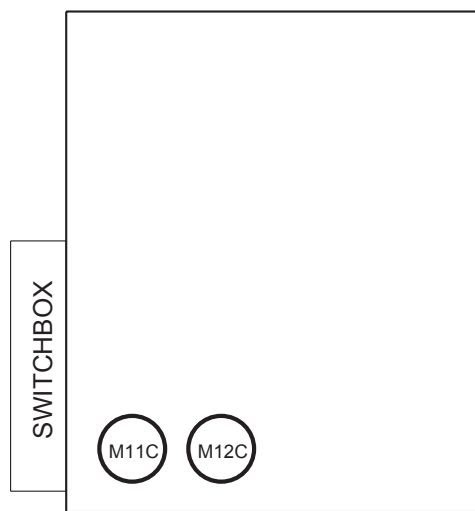

EWAQ 80-100
EWYQ 80-100

3.4.7 Switchbox outlook (typical)

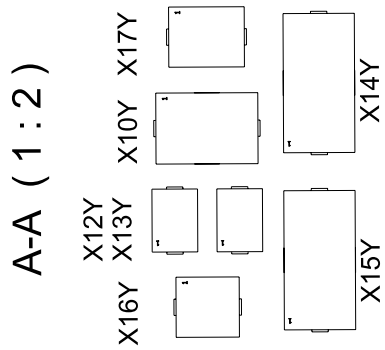
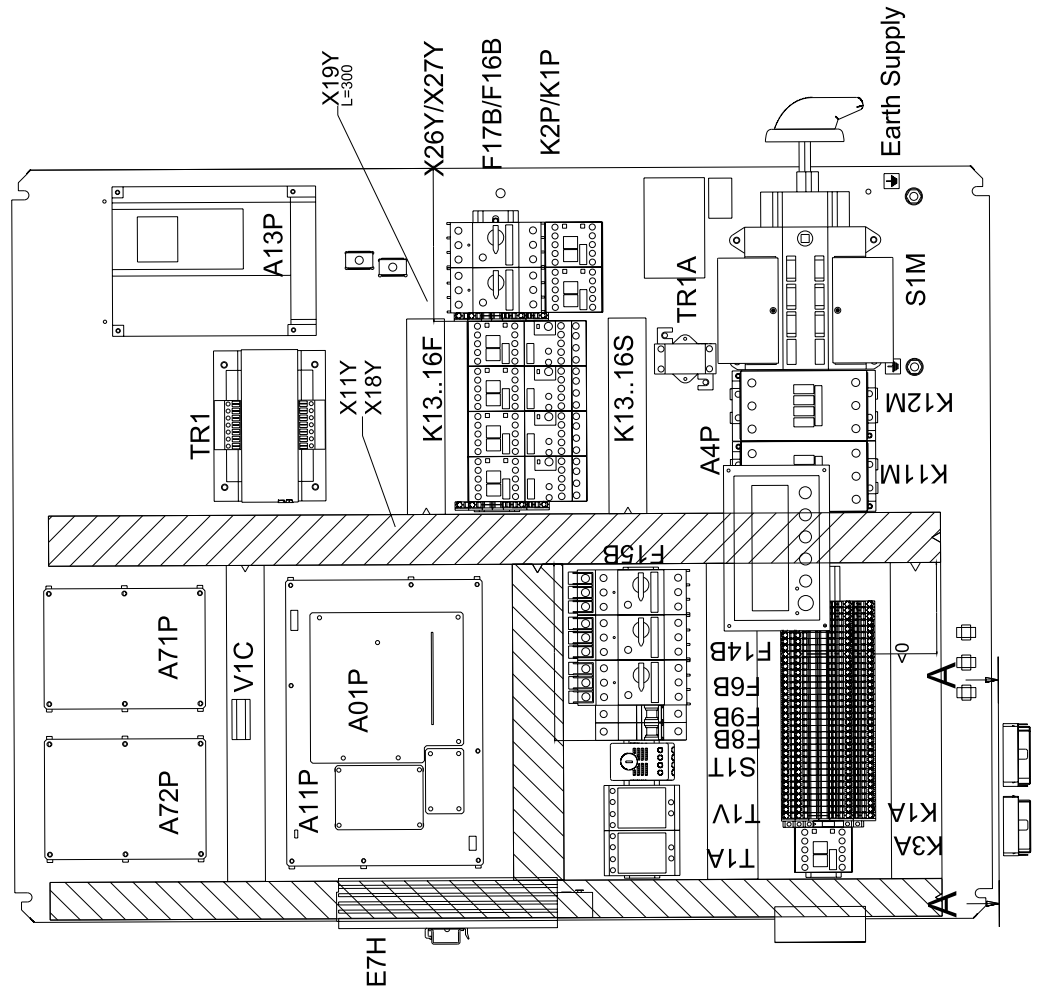

3.4.8 Main power supply

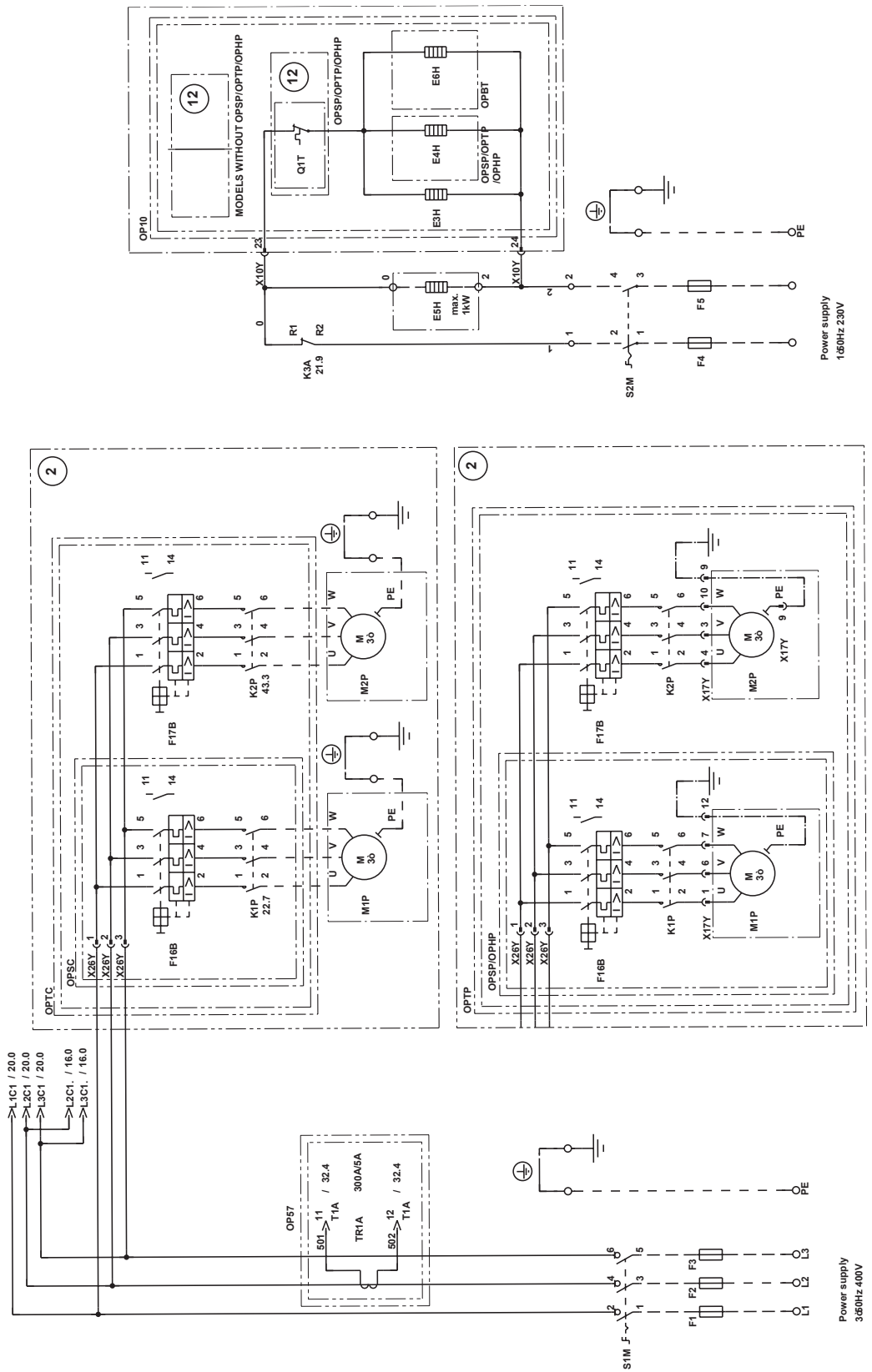

3.4.9 Trafo & PCB power supply

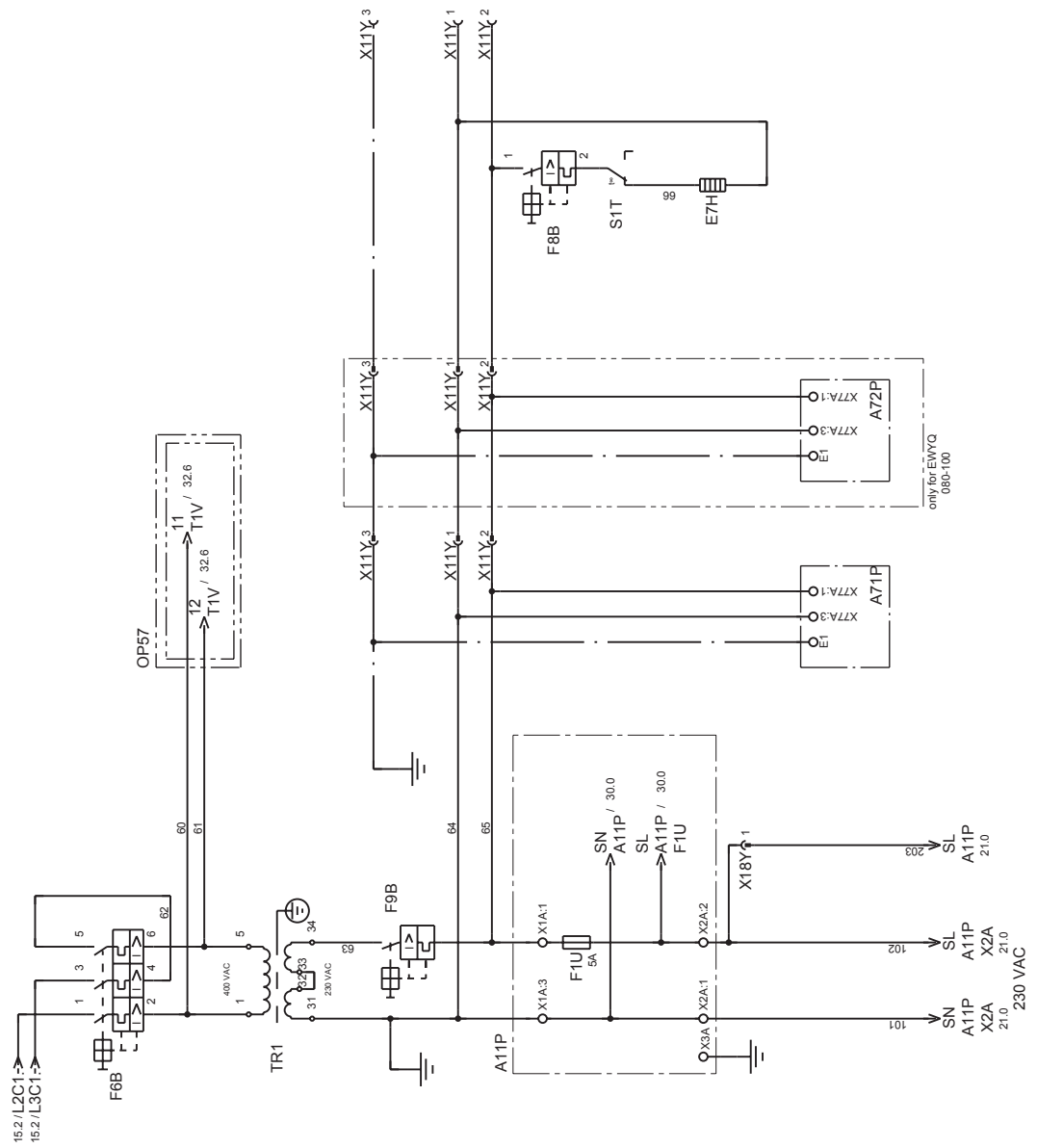

3.4.10 Compressor & fan

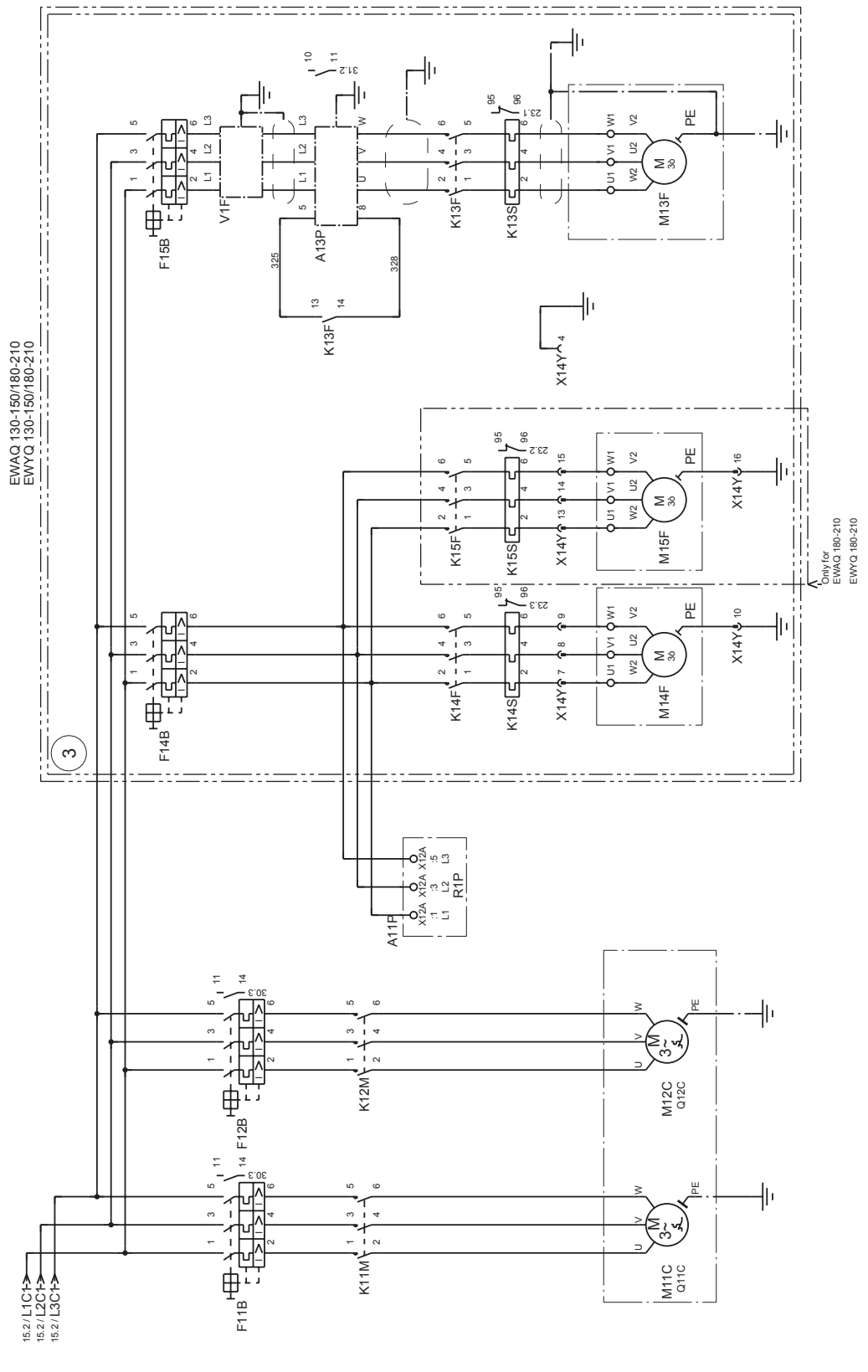

3.4.11 Circuit 1: control compressors

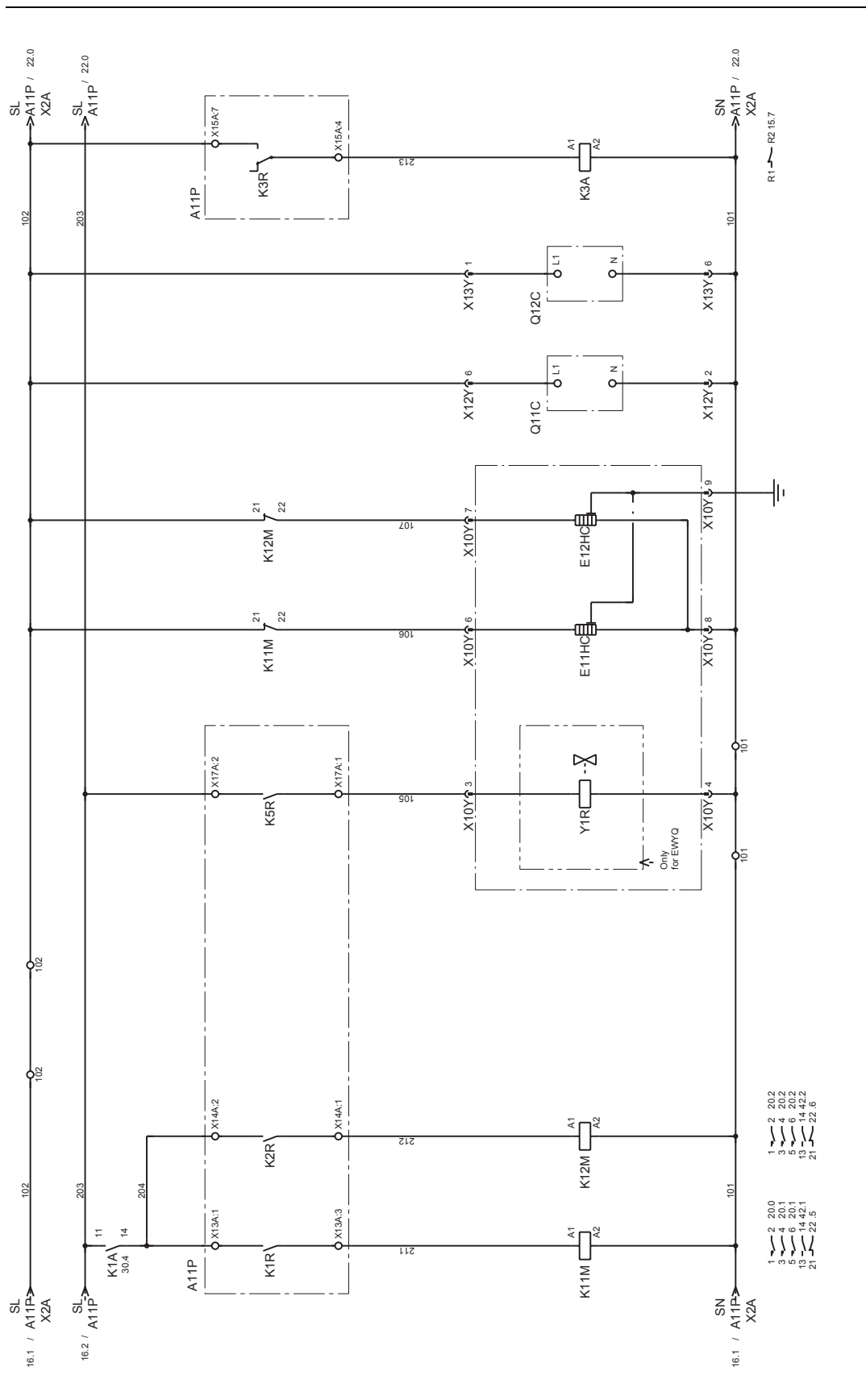

3.4.12 Circuit 1: control fans

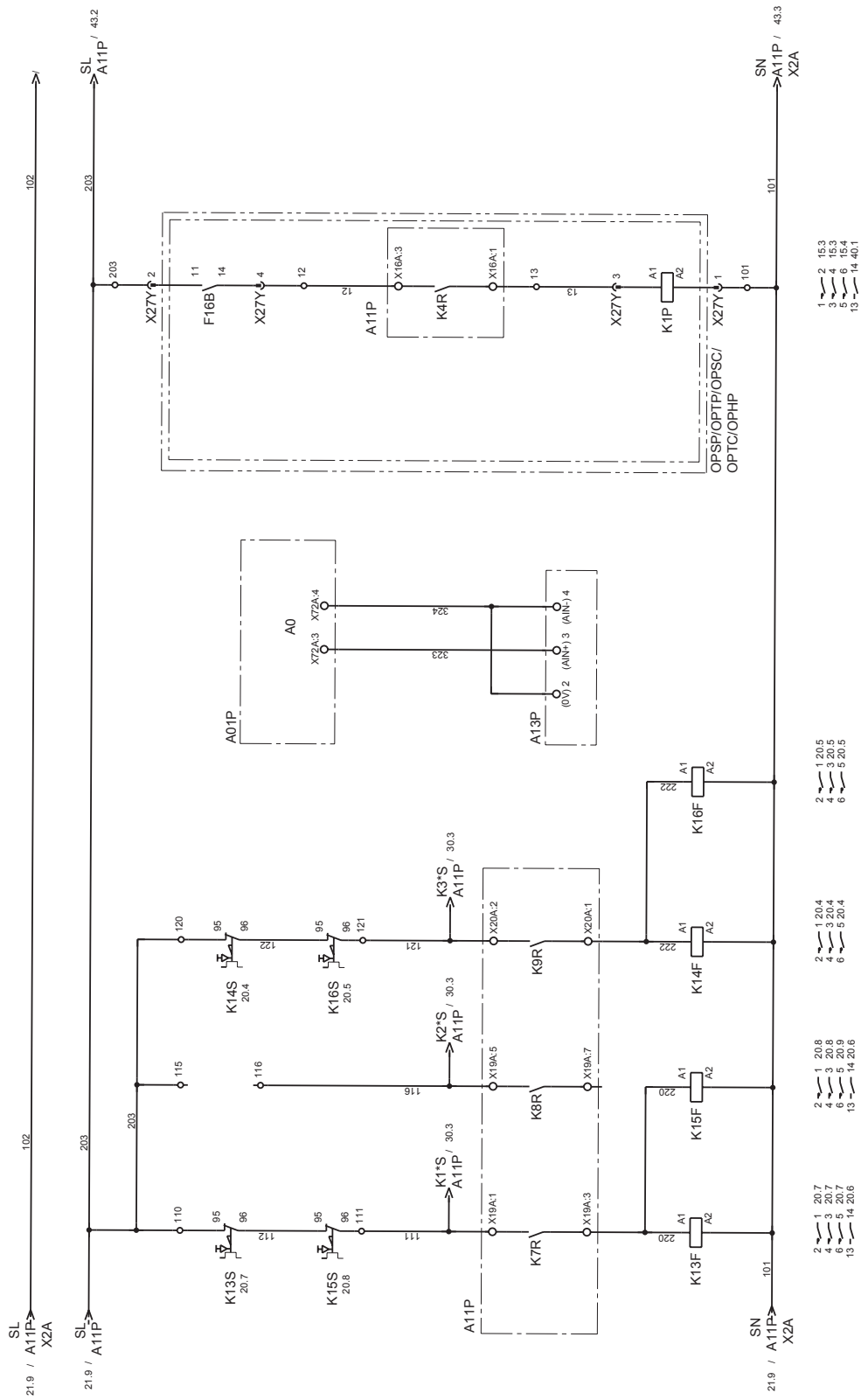

1

3.4.13 Control circuit (DI 230V)

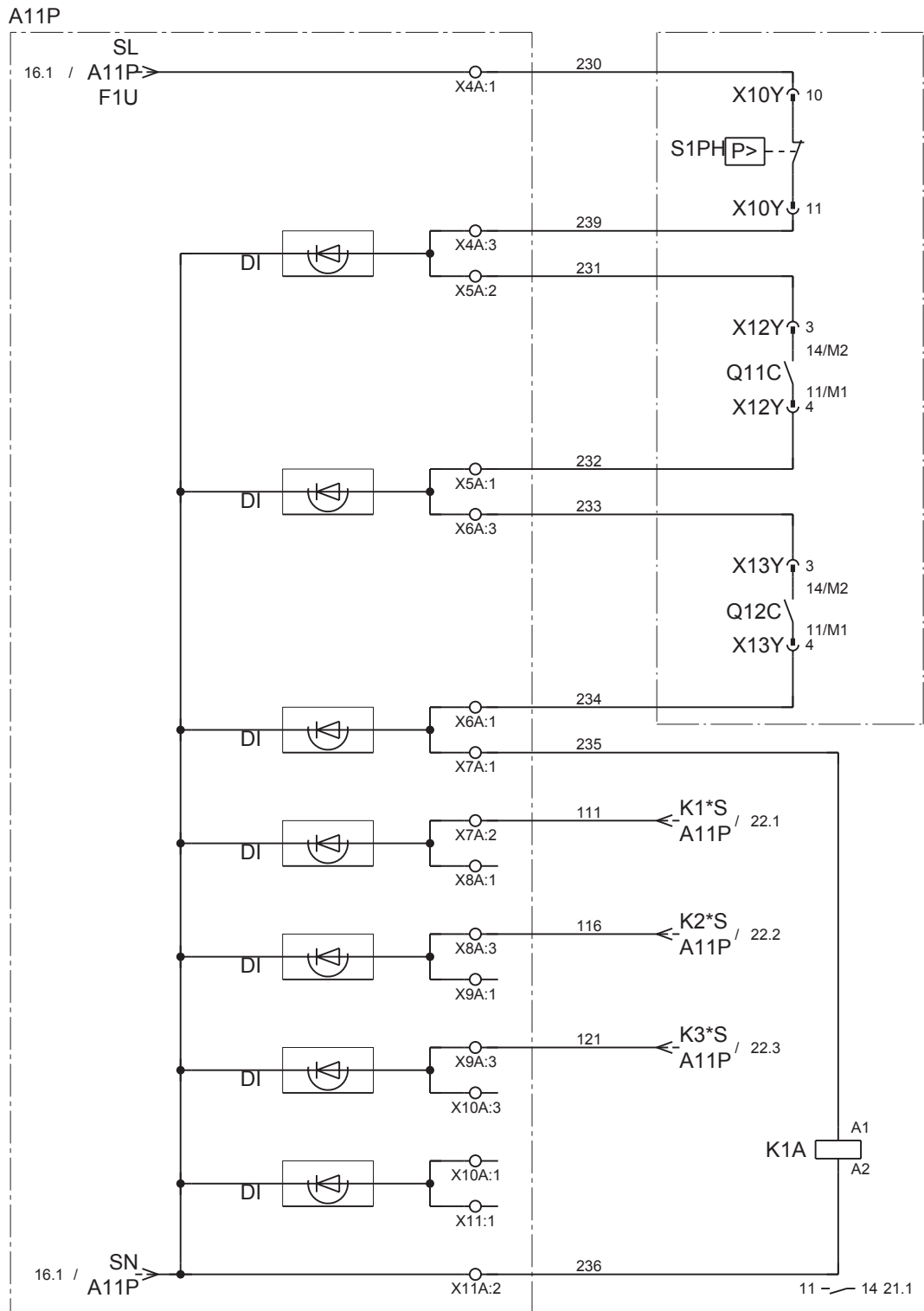

3.4.14 Control circuit and EEV

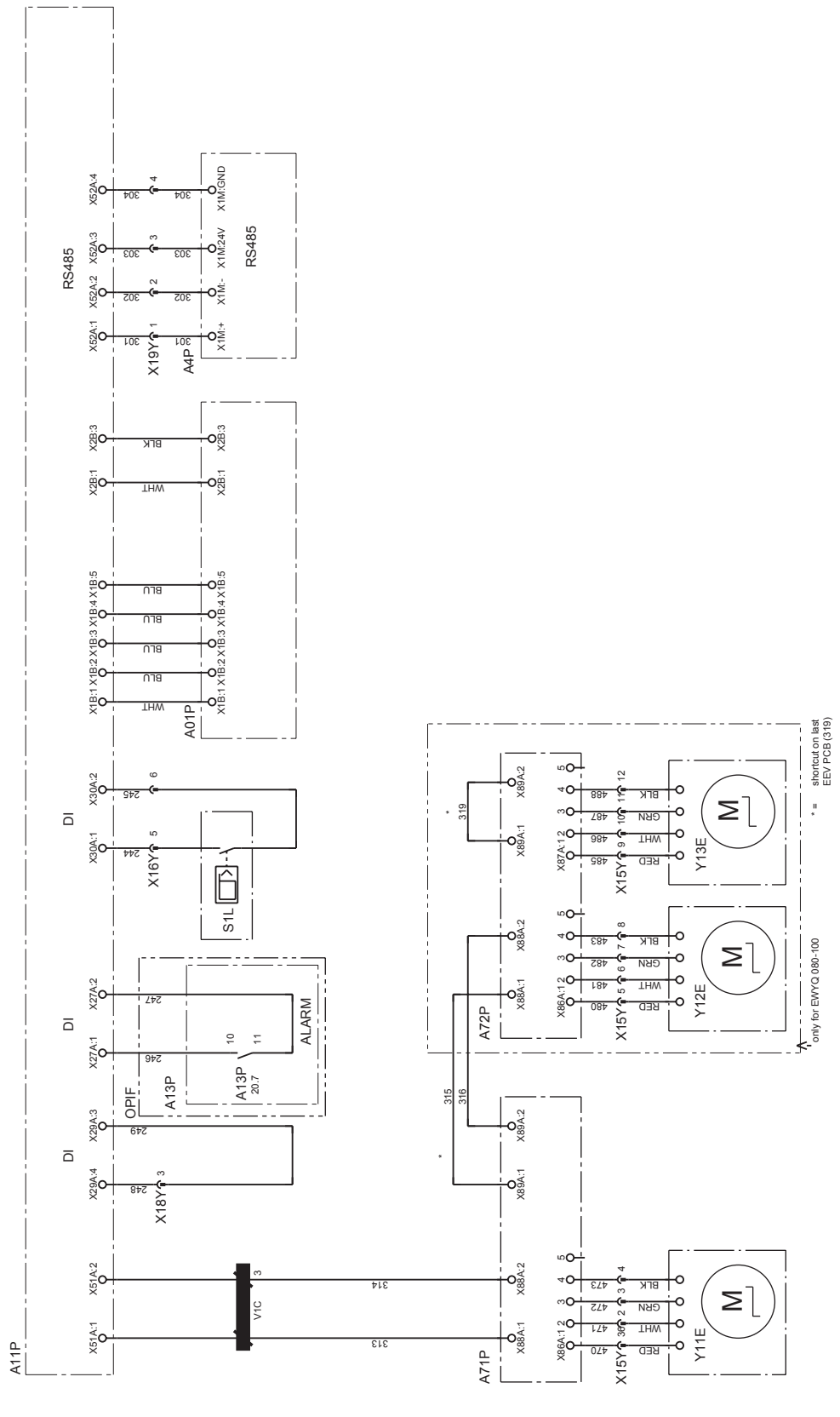

3.4.15 Circuit 1: sensors

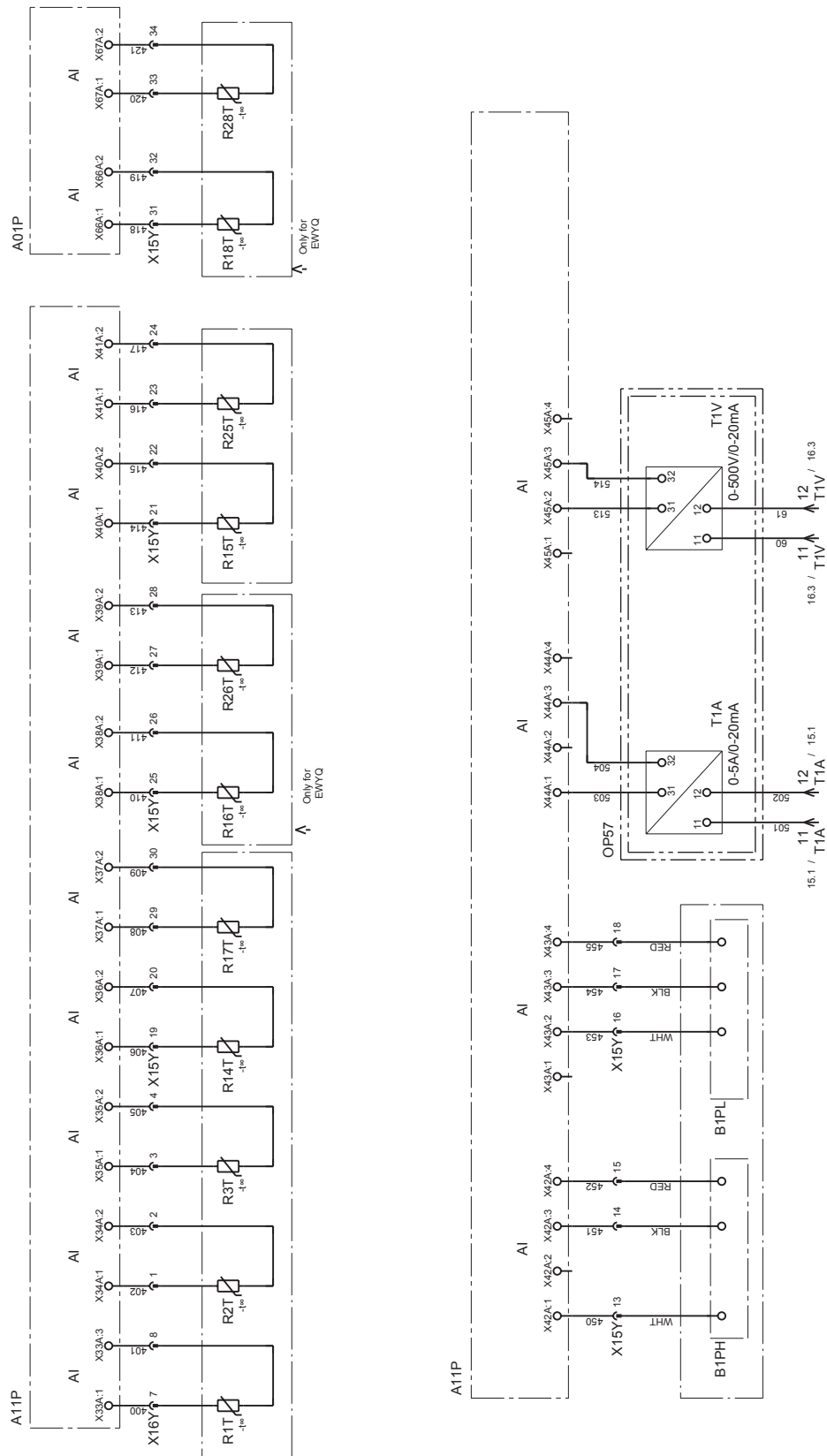

3.4.16 Fieldwiring DI, changeable DI

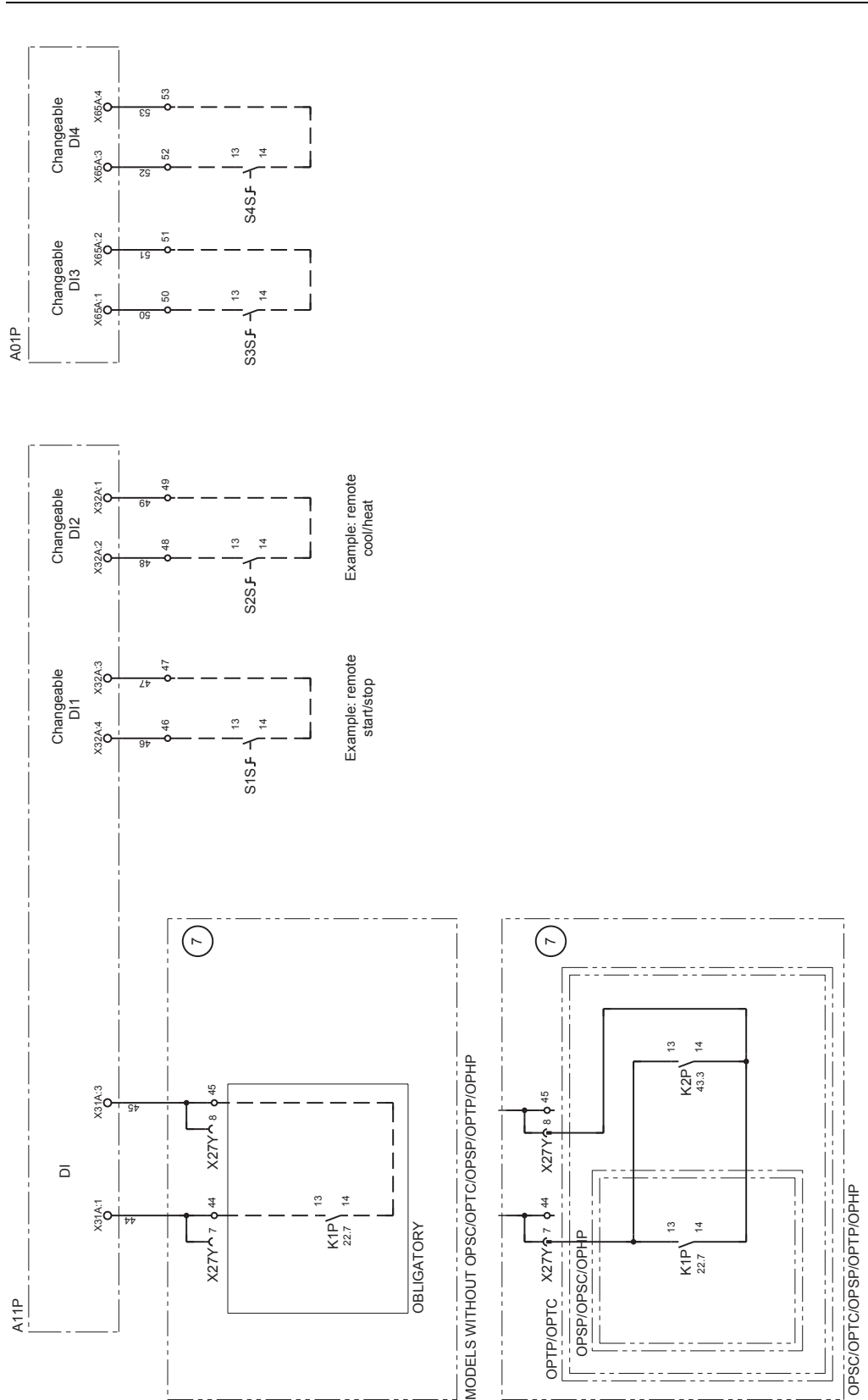

3.4.17 Fieldwiring changeable AI/AO

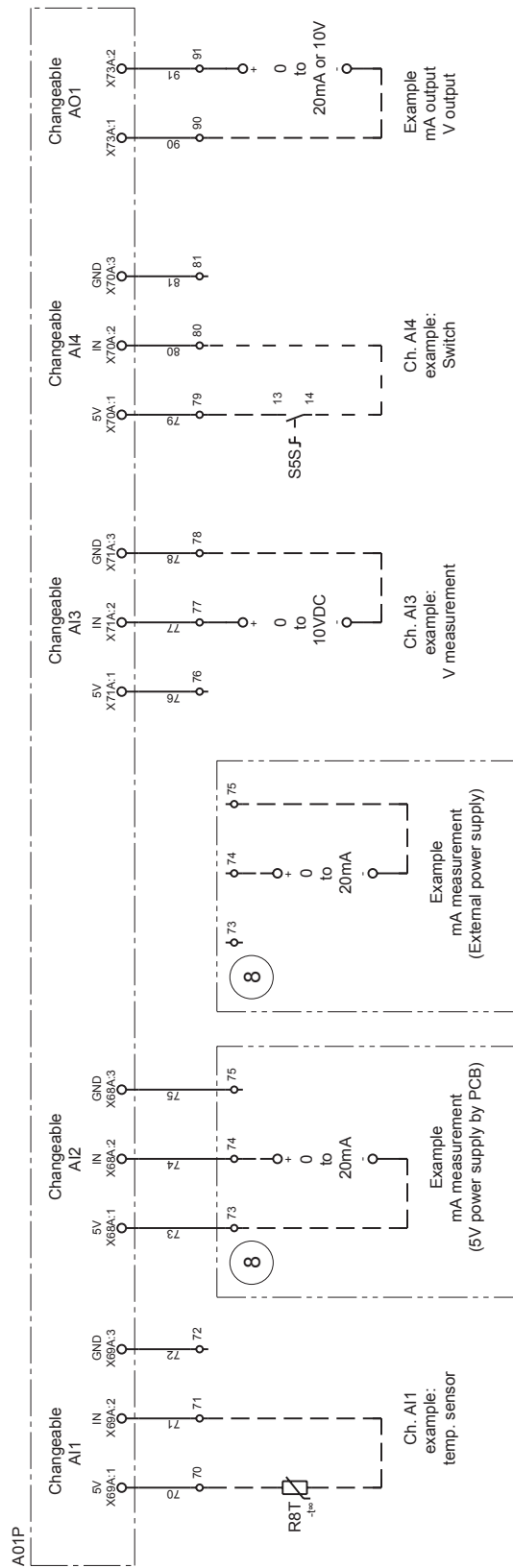

3.4.18 Fieldwiring DO, changeable DO

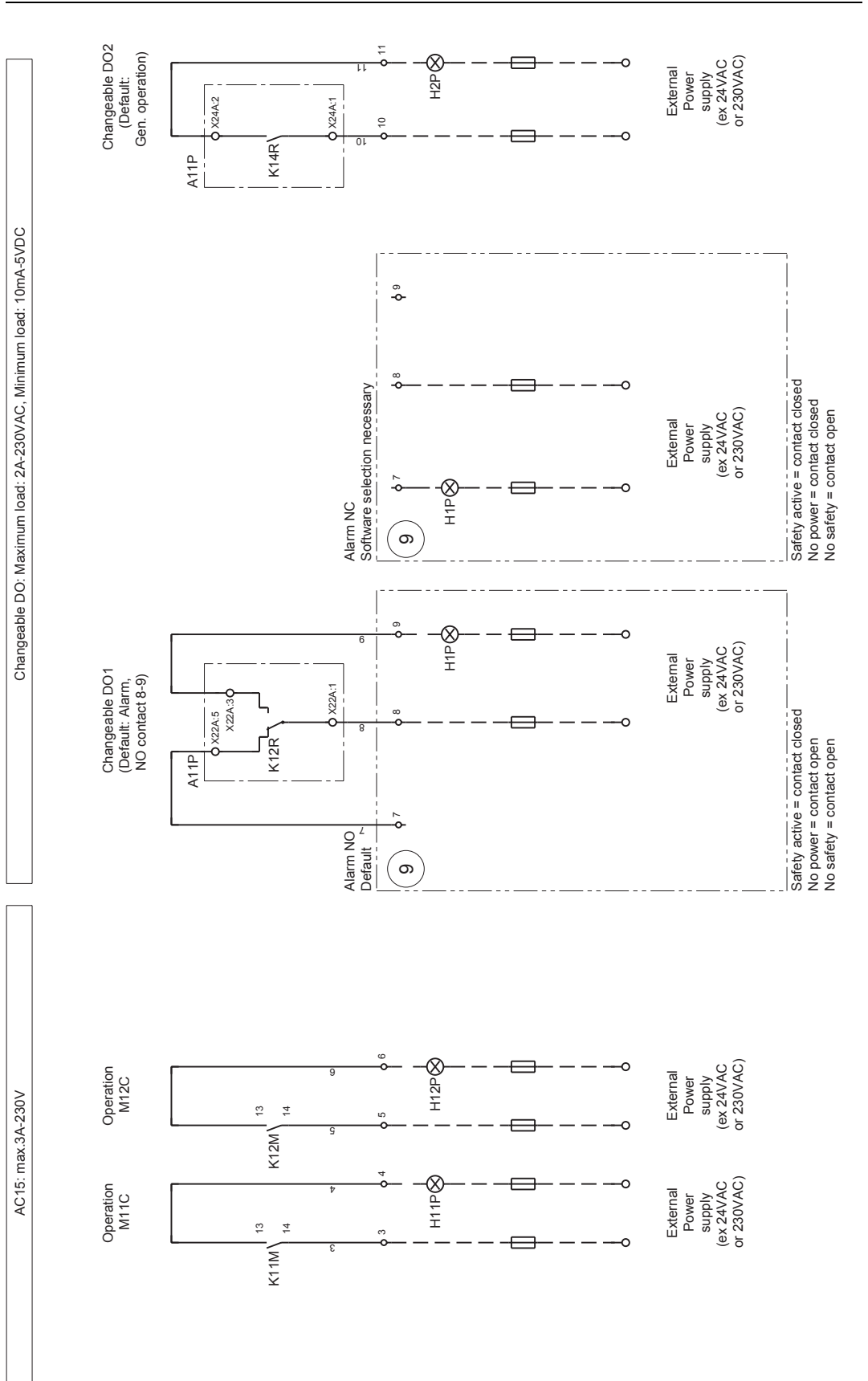

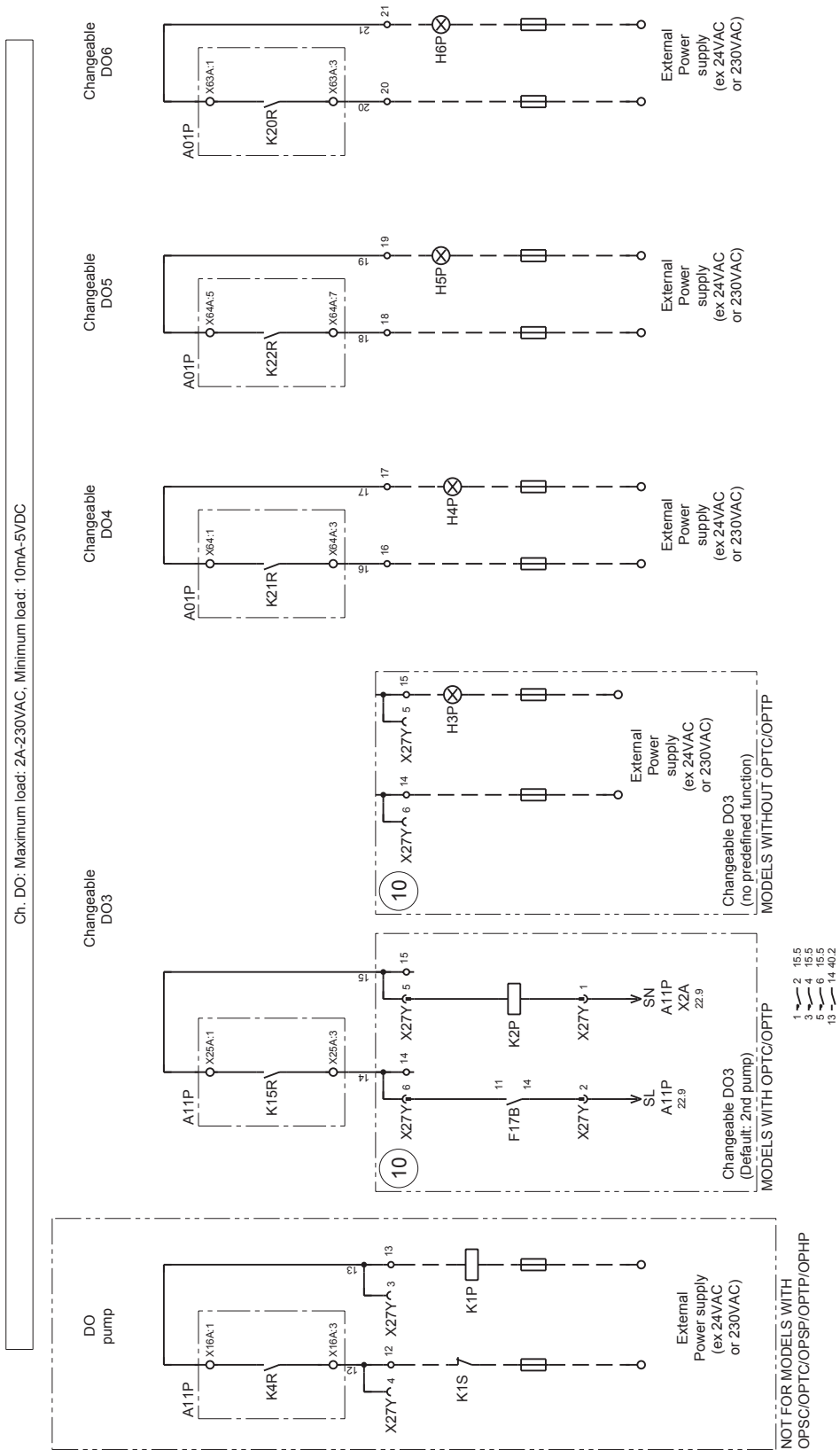

3.5 Wiring Layout : EWAQ130-260DAYN(N-P-B) and EWYQ130-250DAYN(N-P-B) with OPIF

Introduction





This chapter gives a general overview of the PCB intercommunication, I/O overview, switchbox layout and wiring of the EWAQ130-250DAYN(N-P-B) and EWYQ130-260DAYN(N-P-B) with option inverter fans (OPIF).

Overview

This chapter contains the following topics:

Page description	Page
3.5.1 Notes	1–178
3.5.2 Legend	1–180
3.5.3 PCB interconnection diagram	1–185
3.5.4 PCB I/O overview & fuses	1–186
3.5.5 PCB changeable I/O overview	1–191
3.5.6 Unit outlook	1–192
3.5.7 Switchbox outlook	1–193
3.5.8 Main power supply	1–194
3.5.9 Trafo & PCB power supply	1–195
3.5.10 Circuit 1: compressor & fan	1–196
3.5.11 Circuit 1: control compressors	1–198
3.5.12 Circuit 1: control fans	1–199
3.5.13 Circuit 2: compressor & fan	1–201
3.5.14 Circuit 2: control compressors	1–203
3.5.15 Circuit 2: control fans	1–204
3.5.16 Control circuit (DI 230V)	1–206
3.5.17 Control circuit and EEV	1–207
3.5.18 Circuit 1: sensors	1–208
3.5.19 Circuit 2: sensors	1–209
3.5.20 Fieldwiring DI, changeable DI	1–210
3.5.21 Fieldwiring changeable AI/AO	1–211
3.5.22 Fieldwiring DO, changeable DO	1–212

3.5.1 Notes

L1, L2, L3	: Main terminals
1-99	: Fieldwiring terminals
100-199	: Factory upwiring terminals
200-	: Internal wiring terminals
U-Z	: Main terminals in compressor switchbox
_____	: Earth wiring
<u>15</u>	: Wire number 15
⊙15	: Terminals number 15
-----	: Field supply
	: Option
	: Not mounted in switchbox
	: Wiring depending on model
	: PCB
—→**/12.2	: Connection ** continues on page 12 column 2
!	: Pin against miswiring
①	: Several wiring possibilities
N-model	: unit with no options included
Y1R, Y2R reversing valves are activated in cooling mode.	

Factory installed:	<input type="checkbox"/>	OP10	= Heater tape
	<input type="checkbox"/>	OP57	= A-meter, V-meter
	<input type="checkbox"/>	OPLN	= Low noise (OPIF+ Compressorhousing)
	<input type="checkbox"/>	OPTP	= Twinpump
	<input type="checkbox"/>	OPSC	= Single pump contactor
	<input type="checkbox"/>	OPTC	= Twin pump contactor
	<input type="checkbox"/>	OPIF	= Inverter fans for low ambient (-15°C)
	<input type="checkbox"/>	OPHP	= Hi ESP pump
	<input type="checkbox"/>	OPSP	= Single pump
	<input type="checkbox"/>	OPBT	= Buffertank
User installed:	<input type="checkbox"/>	EKACPG	= Address card including: -RS485 (Integrated modbus) -F1, F2 (DICN + DBACS Connection)
	<input type="checkbox"/>	EKRUPG	Remote used interface
Definitions:			
	DI:	Digital input	
	DO:	Digital output	
	AI:	Analog input	
	AO:	Analog output	
	Ch:	Changeable (function can be selected by the customer)	

3.5.2 Legend

	Not included with standard unit	
	Not possible as option	Possible as option
Obligatory	#	##
Not obligatory	*	**

Part number		Description
A01P		PCB Extension
A02P	**	PCB Communication (EKACPG)
A4P		PCB wired remote controller
A5P	**	PCB wired remote controller (EKRUPG)
A11P, A21P		PCB main controller circuit 1, circuit 2
A13P, A23P	**	frequency inverter circuit 1, circuit 2 (OPIF)
A71P		PCB EEV driver
A72P		PCB EEV driver (only for EWYQ)
A73P		PCB EEV driver (only for EWYQ230-250)
B1PH, B2PH		high pressure sensor circuit 1, circuit 2
B1PL, B2PL		low pressure sensor circuit 1, circuit 2
DS1 (A*P)		PCB dipswitch
E1HS	**	switchbox heater with fan (OPIF) (only for EWAQ130-260 / EWYQ130-250)
E3H	**	heatertape (OP10)
E4H	**	heatertape (OP10) (only for OPSP/OPHP/OPTP)
E5H	*	fieldheater
E6H	**	buffertank heater (OP10) (only for OPBT)
E7H	**	switchbox heater (OPIF) (only for EWA/YQ80-100)
E11HC, E12HC		crankcase heater compressor circuit 1
E21HC, E22HC		crankcase heater compressor circuit 2
F1-F3	#	main fuses
F1U (A*P)		fuse PCB
F4, F5	#	fuses for heaters
F6B		autofuse for primary of TR1
F8B	**	autofuse for switchbox heater (OPIF)
F9B		autofuse for secondary of TR1
F11B, F12B		autofuse for compressors (M11C, M12C,) (Not for EWA/YQ80-100)

Part number		Description
F14B, F24B		autofuse for fan motors circuit 1, circuit 2
F15B, F25B	**	autofuse for fan motors circuit 1, circuit 2 (OPIF)
F16B	**	autofuse for pump (K1P) (only for OPSP/OPHP/OPSC/OTPT/OPTC)
F17B	**	autofuse for pump (K2P) (only for OPTP/OPTC)
F21B, F22B		autofuse for compressors (M21C, M22C)
H1-6P	*	indication lamp for changeable digital outputs
H11P, H12P	*	indication lamp for operation compressor circuit 1 (M11C, M12C)
H21P, H22P	*	indication lamp for operation compressor circuit 2 (M21C, M22C)
HAP-HEP (A*P)		light emitting diode PCB
K1A, K2A		auxiliary relay for compressor safety circuit 1, circuit 2
K1P	##	pump contactor (only for OPSP/ OPHP/OPSC/OPTC)
K1S	*	overcurrent relay pump
K1R-K22R (A*P)		PCB relay
K2P	**	pump contactor (only for OPTP/ OPTC)
K3A		auxiliary relay for heater tape
K11M, K12M		compressor contactor for circuit 1
K13F, K14F		fancontactor for circuit 1
K13S, K14S		fan overcurrent relay for circuit 1
K15F		fancontactor for circuit 1 (Only for EWAQ80-100/180-210/240-260) (Only for EWYQ80-100/180-210/230-250)
K15S		fan overcurrent relay for circuit 1 (Only for EWAQ80-100/180-210/240-260) (Only for EWYQ80-100/180-210/230-250)
K16F		fancontactor for circuit 1 (Only for EWAQ80-100/240-260) (Only for EWYQ80-100/230-250)
K16S		fan overcurrent relay for circuit 1 (Only for EWAQ80-100/240-260) (Only for EWYQ80-100/230-250)
K21M, K22M		compressor contactor for circuit 2
K23F, K24F		fancontactor for circuit 2
K23S, K24S		fan overcurrent relay for circuit 2
K25F		fancontactor for circuit 2 (Only for EWAQ180-210/240-260) (Only for EWYQ180-210/230-250)

1

Part number		Description
K25S		fan overcurrent relay for circuit 2 (Only for EWAQ180-210/240-260) (Only for EWYQ180-210/230-250)
K26F		fancontactor for circuit 2 (Only for EWAQ240-260) (Only for EWYQ230-250)
K26S		fan overcurrent relay for circuit 2 (Only for EWAQ240-260) (Only for EWYQ230-250)
M1P	**	pump motor 1 (only for OPSP/OPHP/OPSC/OTPT/OPTC)
M2P	**	pump motor 2 (only for OPTP/OPTC)
M11C, M12C		compressor motors circuit 1
M13F, M14F		fan motors circuit 1
M15F		fan motors circuit 1 (Only for EWAQ80-100/180-210/240-260) (Only for EWYQ80-100/180-210/230-250)
M16F		fan motors circuit 1 (Only for EWAQ80-100/240-260) (Only for EWYQ80-100/230-250)
M21C, M22C		compressor motors circuit 2
M23F, M24F		fan motors circuit 2
M25F		fan motors circuit 2 (Only for EWAQ180-210/240-260) (Only for EWYQ180-210/230-250)
M26F		fan motors circuit 2 (Only for EWAQ240-260) (Only for EWYQ230-250)
M1F		switchbox fanmotor
Q1T	**	thermostat (OP10)
Q11C, Q12C		For EWAQ130/EWYQ130: thermal protector compressor circuit 1 For EWAQ80-100/150/180-210/240-260: For EWYQ80-100/150/180-210/230-250: electronic protection module compressor circuit 1
Q21C, Q22C		For EWAQ130/EWYQ130: thermal protector compressor circuit 2 For EWAQ150/180-210/240-260: For EWYQ150/180-210/230-250: electronic protection module compressor circuit 2

Part number		Description
R1T		ambient temperature sensor
R2T		inlet water temperature sensor
R3T		outlet water temperature sensor
R8T	*	temperature sensor for changeable analog input
R14T		suction temperature sensor circuit 1
R15T, R25T		discharge temperature sensor circuit 1
R16T		coil temperature sensor circuit 1 (only for EWYQ)
R17T		refrigerant piping temperature sensor circuit 1
R18T, R38T		heating suction temperature sensor circuit 1, circuit 2 (only EWYQ)
R28T, R48T		heating suction temperature sensor circuit 1, circuit 2 (only EWYQ80-100/230-250)
R26T		coil temperature sensor circuit 1(only for EQWYQ80-100/230-250)
R34T		suction temperature sensor circuit 2
R35T, R45T		discharge temperature sensor circuit 2
R36T		coil temperature sensor circuit 2 (only for EWYQ)
R37T		refrigerant piping temperature sensor circuit 2
R46T		coil temperature sensor circuit 2 (only for EWYQ230-250)
S1A-S3A (A*P)		PCB dipswitch
S1L		flowswitch
S1M		main isolator switch
S1PH, S2PH		high pressure switch circuit 1, circuit 2
S1S-S5S	*	switch for changeable digital input (remote on/off, C/H, ...)
S1T	**	thermal contact (OPIF)
S2M	#	heatertape isolator switch
T1A	**	current transducer (OP57)
T1V	**	voltage transducer (OP57)
TR1		transfo control circuit (400V/230V)
TR1A	**	current measurement transfo (OP57)
V1C		Ferrite core
V1F, V2F	**	noise filter circuit 1, circuit 2 (OPIF) (Only for EWAQ130-150/180-210) (Only for EWYQ130-150/180-210)
V2C	**	Ferrite core (EKACPG)
X*A (A*P)		PCB terminal
X*Y		connector
X1M (A*P)		PCB terminal strip

1

Part number	Description
Y1R, Y2R	reverse valve circuit 1, circuit 2 (only EWYQ)
Y11E	electronic expansion valve cooling circuit 1
Y12E	electronic expansion valve heating circuit 1 (only EWYQ)
Y13E	electronic expansion valve heating circuit 1 (only EWYQ80-100/230-250)
Y21E	electronic expansion valve cooling circuit 2
Y22E	electronic expansion valve heating circuit 2 (only EWYQ)
Y23E	electronic expansion valve heating circuit 2 (only EWYQ 230-250)

3.5.3 PCB interconnection diagram

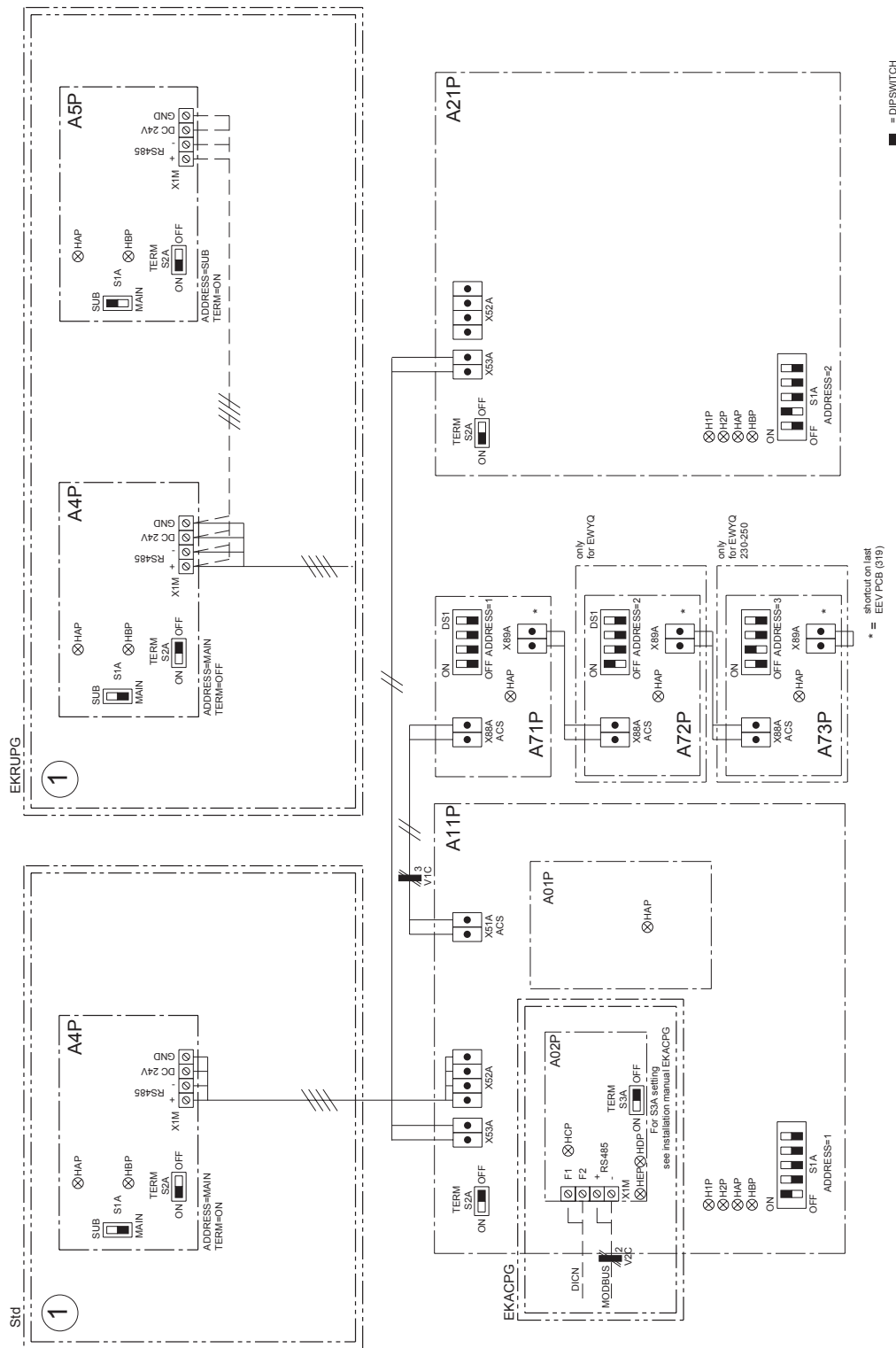

3.5.4 PCB I/O overview & fuses

Main PCB (A11P)	
X12A (1-3-5)	DI: Reverse phase detection (L1-L2-L3) c1
X4A	DI: High pressure switch c1
X5A	DI: Compressor interlock 1 c1
X6A	DI: Compressor interlock 2 c1
X7A	DI: Fan overcurrent relay Fanstep 1 c1
X8A	DI: Fan overcurrent relay Fanstep 2 c1
X9A	DI: Fan overcurrent relay Fanstep 3 c1
X27A	DI: Fan inv safety c1 (only for OPIF)
X29A (3-4)	not used
X30A	DI: Flow switch
X31A	DI: Pump interlock
X32A (3-4)	Ch DI 1: function not pre-defined
X32A (1-2)	Ch DI 2: function not pre-defined
X13A	DO: Compressor contactor 1 c1
X14A	DO: Compressor contactor 2 c1
X15A	DO: Heaters tape
X16A	DO: Pump contactor
X17A	DO: Reverse valve c1 (only for EWYQ)
X19A (1-3)	DO: Fanstep 1 c1
X19A (5-7)	DO: Fanstep 2 c1
X20A	DO: Fanstep 3 c1
X22A	Ch DO1: "SAFETY + W. (NO)" (def)
X24A	Ch DO2: "GEN. OPERATION" (def)
X25A	Ch DO3: function not pre-defined
X33A	AI: Ambient sensor
X34A	AI: Inlet water sensor
X35A	AI: Outlet water sensor
X36A	AI: Suction temperature sensor c1
X37A	AI: Refrigerant piping temperature sensor c1
X38A	AI: Coil temperature sensor 1 c1 (only for EWYQ)
X39A	AI: Coil temperature sensor 2 c1 (only for EWYQ)
X40A	AI: Discharge temperature sensor 1 c1

X41A	AI: Discharge temperature sensor 2 c1
X42A	AI: High pressure sensor c1
X43A	AI: Low pressure sensor c1
X44A	AI: Current measurement (OP57)
X45A	AI: Voltage measurement (OP57)
HAP, HBP	LED (service monitor green)
H1P, H2P	LED (service monitor red)
S1A	dipswitch (address)
S2A	dipswitch (terminal resistor)

Extension PCB (A01P)	
X63A	Ch DO6: Function not pre-defined
X64A (1-3)	Ch DO4: Function not pre-defined
X64A (5-7)	Ch DO5: Function not pre-defined
X65A (1-2)	Ch DI3: Function not pre-defined
X65A (3-4)	Ch DI4: Function not pre-defined
X66A	AI: Heating suction temperature sensor 1 c1 (Only for EWYQ)
X67A	AI: Heating suction temperature sensor 2 c1 (Only for EWYQ)
X68A	Ch AI2: Function not pre-defined
X69A	Ch AI1: Function not pre-defined
X70A	Ch AI 4: Function not pre-defined
X71A	ChAI3: Function not pre-defined
X72A (3-4)	AO: Fanspeed signal c1 (Only for OPIF)
X73A	ChAO1: Function not pre-defined
X74A (4-5)	AO: Fanspeed signal c2 (Only for OPIF)
HAP, HBP	LED (service monitor green)

Wired remote controller PCB (A4P, A5P)	
HAP, HBP	LED (service monitor green)
S1A	dipswitch (address)
S2A	dipswitch (terminal resistor)

1

Communication PCB (A02P)	
HCP, HDP, HEP	LED (service monitor green)
S3A	dipswitch (terminal resistor)

EEV PCB (A71P)	
X86A	Y11E Electronic expansion valve
X87A	Y21E Electronic expansion valve
HAP	LED (service monitor green)
DS1	dipswitch (address)

EEV PCB (A72P) (Only EWYQ)	
X86A	Y12E Electronic expansion valve (only EWYQ)
X87A	Y22E Electronic expansion valve (only EWYQ)
HAP	LED (service monitor green)
DS1	dipswitch (address)

Main PCB (A21P)	
X12A (1-3-5)	DI: Reverse phase detection (L1-L2-L3) c2
X4A	DI: High pressure switch c2
X5A	DI: Compressor interlock 1 c2
X6A	DI: Compressor interlock 2 c2
X7A	DI: Fan overcurrent relay Fanstep 1 c2
X8A	DI: Fan overcurrent relay Fanstep 2 c2
X9A	DI: Fan overcurrent relay Fanstep 3 c2
X27A	DI: Fan inv safety c2 (Only for OPIF)
X13A	DO: Compressor contactor 1 c2
X14A	DO: Compressor contactor 2 c2
X17A	DO: Reverse valve c2 (Only for EWYQ)
X19A (1-3)	DO: Fanstep 1 c2
X19A (5-7)	DO: Fanstep 2 c2
X20A	DO: Fanstep 3 c2
X34A	AI: Heating suction temperature sensor 1 c2 (Only for EWYQ)
X35A	AI: Heating suction temperature sensor 2 c2 (Only for EWYQ)

X36A	AI: Suction temperature sensor c2
X37A	AI: Refrigerant piping temperature sensor c2
X38A	AI: Coil temperature sensor 1 c2 (only for EWYQ)
X39A	AI: Coil temperature sensor 2 c2 (only for EWYQ)
X40A	AI: Discharge temperature sensor 1 c2
X41A	AI: Discharge temperature sensor 2 c2
X42A	AI: High pressure sensor c2
X43A	AI: Low pressure sensor c2
HAP, HBP	LED (service monitor green)
H1P, H2P	LED (service monitor red)
S1A	dipswitch (address)
S2A	dipswitch (terminal resistor)

EEV PCB (A73P) (Only EWYQ230-250)	
X86A	Y13E Electronic expansion valve (only EWYQ230-250)
X87A	Y23E Electronic expansion valve (only EWYQ230-250)
HAP	LED (service monitor green)
DS1	dipswitch (address)

	EWAQ130 EWYQ130	EWAQ150 EWYQ150	EWAQ180 EWYQ180	EWAQ210 EWYQ210	EWAQ240 EWYQ230	EWAQ260 EWYQ250
FUSES						
F1-F3	200gL/gG 500V	200gL/ gG 500V	250gL/gG 500V	250gL/gG 500V	300gL/gG 500V	355gL/gG 500V
F1U	T 5A/250V	T 5A/250V	T5A/250V	T5A/250V	T5A/250V	T5A/250V
F4, F5	10gL/250 V	10gL/250 V	10gL/250 V	10gL/250 V	10gL/250 V	10gL/250 V
Circuit breakers						
F8B (OPIF)	C 2A/250V	C 2A/250V	C 2A/250V	C 2A/250V	C 2A/250V	C 2A/250V
F9B	C 4A/250V	C 4A/250V	C 4A/250V	C 4A/250V	C 4A/250V	C 4A/250V
Circuit breaker and motor protector settings						
F6B	3A	3A	3A	3A	3A	3A
F11B, F22B	36A	40A	52A	52A	66A	66A
F12B, F21B	36A	40A	52A	52A	66A	66A

1

F16B (OPSP/ OPSC/ OPTP/OPTC) F16B (OPHP)	6,8A 12 A	6,8A 12 A	8,6A 16,3A	8,6A 16,3A	8,6A 16,3A	8,6A 16,3A
F17B (OPTP/ OPTC)	6,8A	6,8A	8,6A	8,6A	8,6A	8,6A
F14B, F24B	1,8A	2,5A	5,1A	5,1A	3,5 A	3,5 A
F15B, F25B (OPIF)	5,6A	7,9A	7,9A	7,9A	9,5A	9,5A
K13S-K16S K23S-K26S	1,6A	2,3A	2,3A	2,3A	1,6A	1,6A

3.5.5 PCB changeable I/O overview

Refer to the installation manual for instructions how to configure changeable I/O.

Changeable digital input (4 available)	Changeable analog output (1 available)
<ul style="list-style-type: none"> -None -Status -Dual setpoint -Remote on-off -Capacity limitation 25%, 50%, 75%, or setting -Low noise (only for OPIF) -Free cooling signal -Fan forced on 	<ul style="list-style-type: none"> -None -Unit capacity (mA, V) -Details of types: Type mA: 0..20mA / 4..20 mA Type V: 0-1V / 0-5V / 0-10V
Changeable digital output (6 or 5 available depending on unit)	Changeable analog input (4 available)
<ul style="list-style-type: none"> -None (open) -Closed -2nd pump -100% capacity -Full capacity -Free cooling -General operation -Safety + warning NO -Safety + warning NC (only for Ch DO1) -Safety NO (excluding warning) -Safety NC (excluding warning) (only for Ch DO1) -C1, C2 Safety NO -Warning NO -C1, C2 operation -Cooling (only EWYQ) -Heating (only EWYQ) -Defrost (only EWYQ) 	<ul style="list-style-type: none"> -None -Status (mA, V, NTC*, DI) -Floating setpoint (mA, V, NTC*) -Water temperature measurement (NTC*) -Changeable DI, refer to Ch DI for possibilities (DI) - Details of types: Type mA: 0..20mA / 4..20mA (internal 5V or external power supply) Type V: 0-1V / 0-5V / 0-10V Type DI: DI (5V detection) <p>*: for allowed NTC types and how to configure the software please contact your local dealer.</p>

3.5.6 Unit outlook

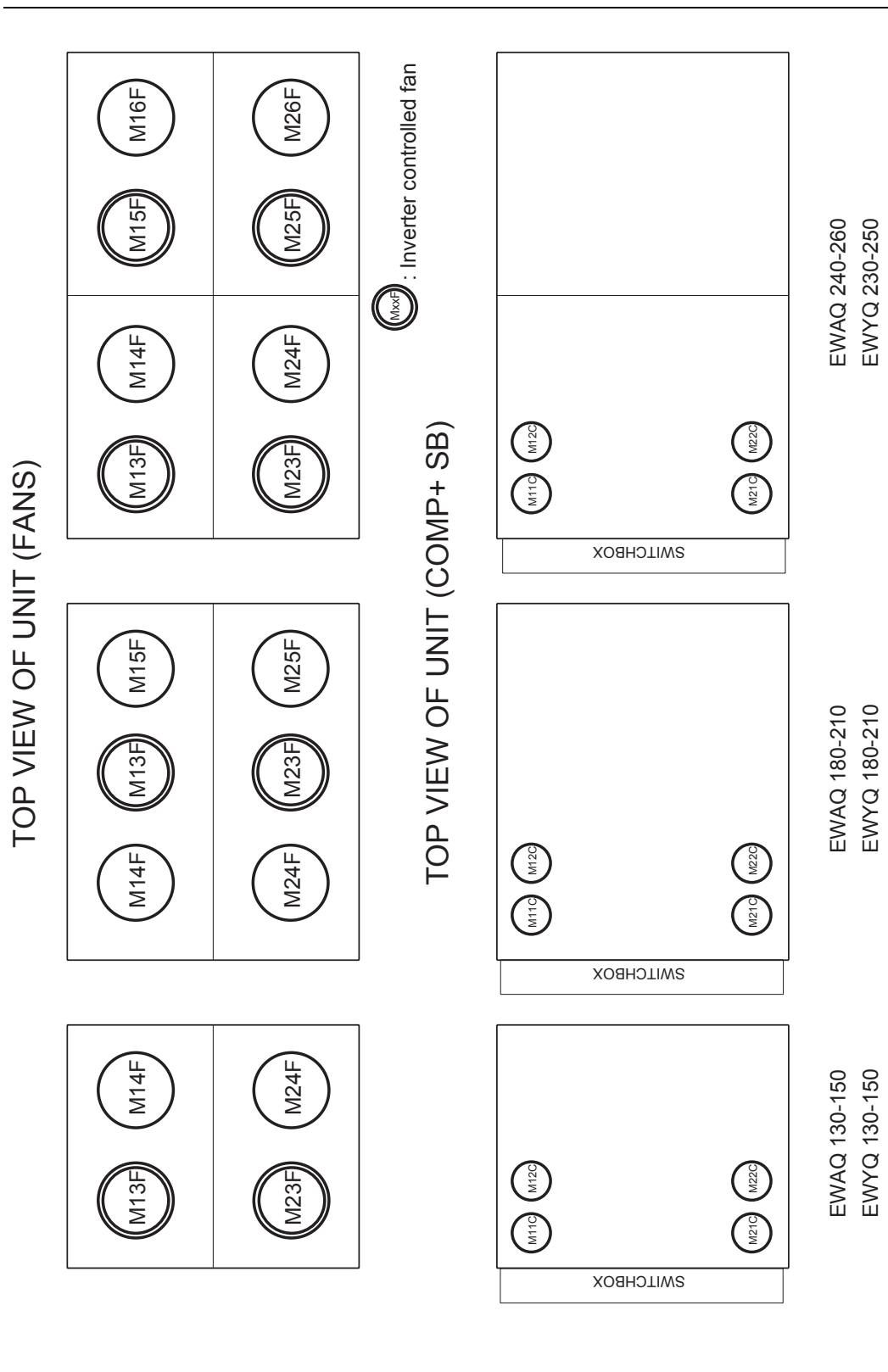

3.5.7 Switchbox outlook

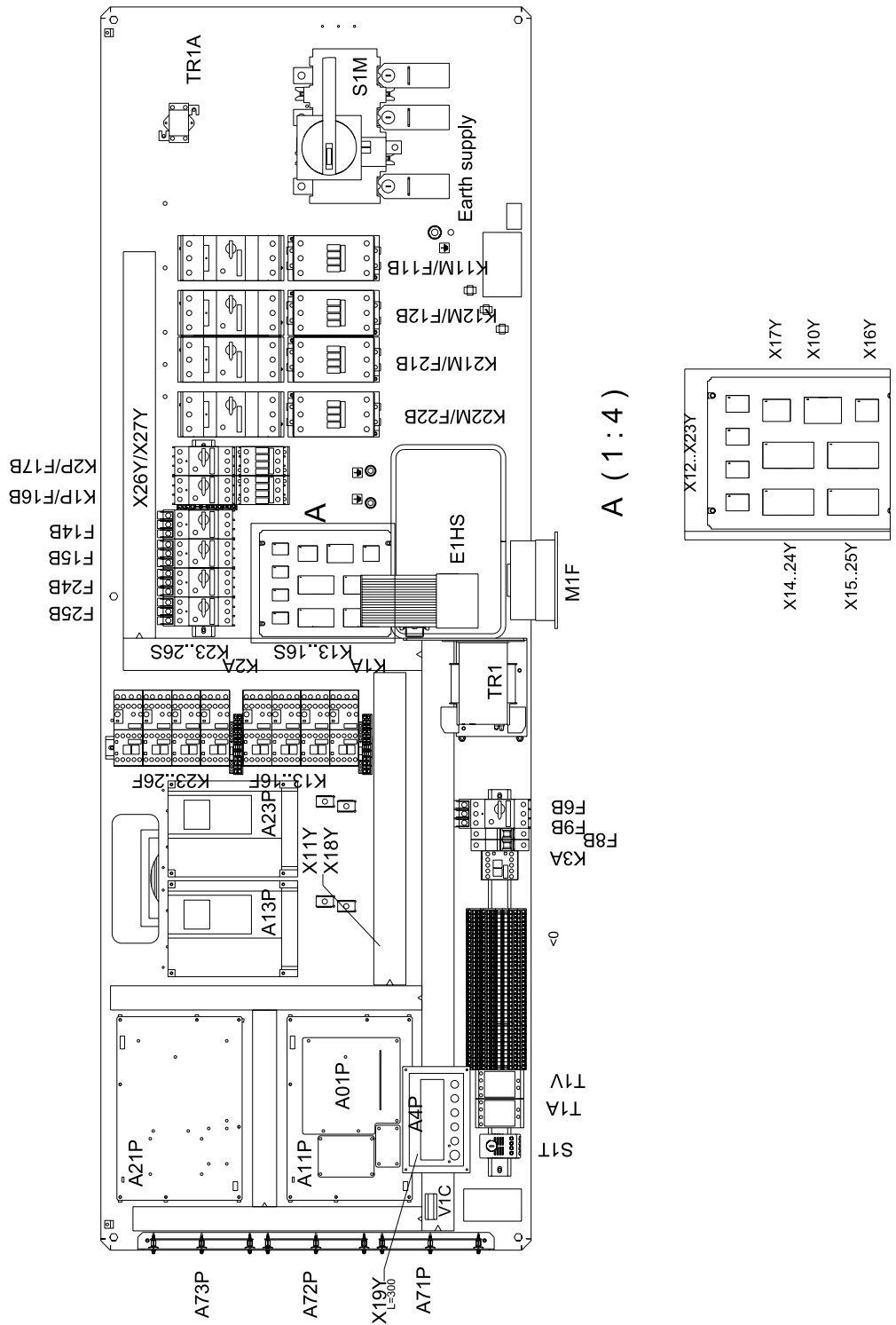

3.5.8 Main power supply

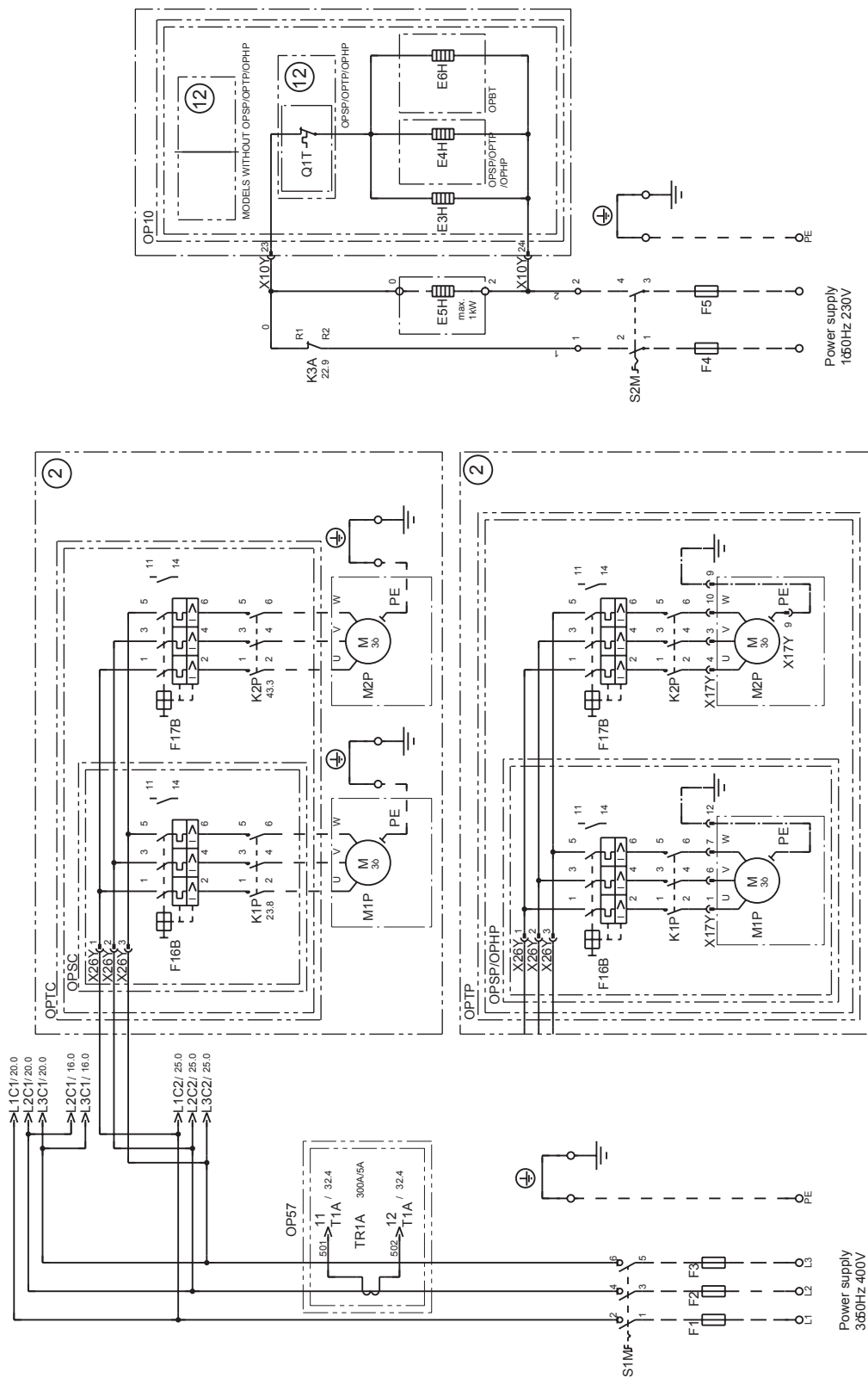

3.5.9 Trafo & PCB power supply

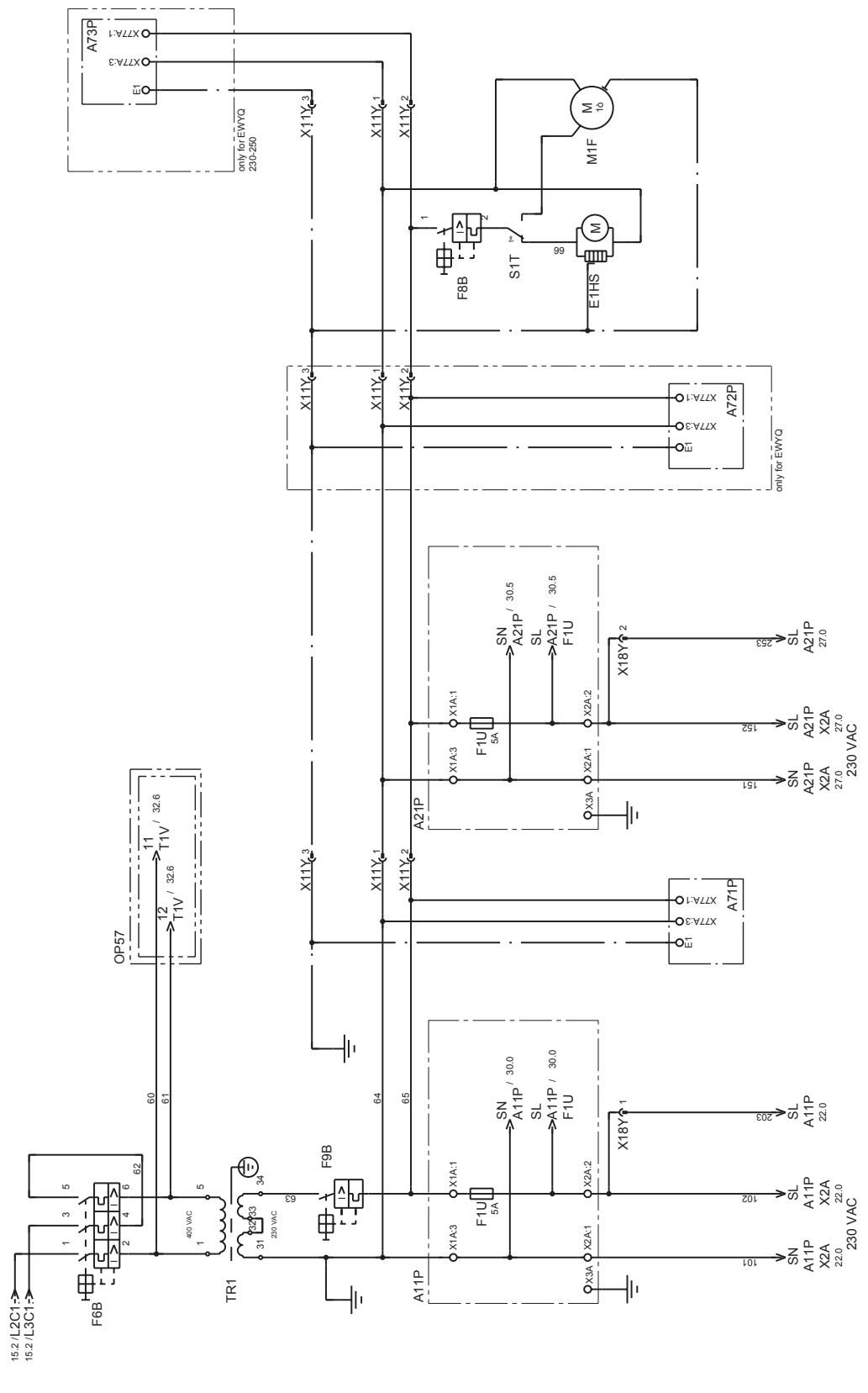

1

3.5.10 Circuit 1: compressor & fan

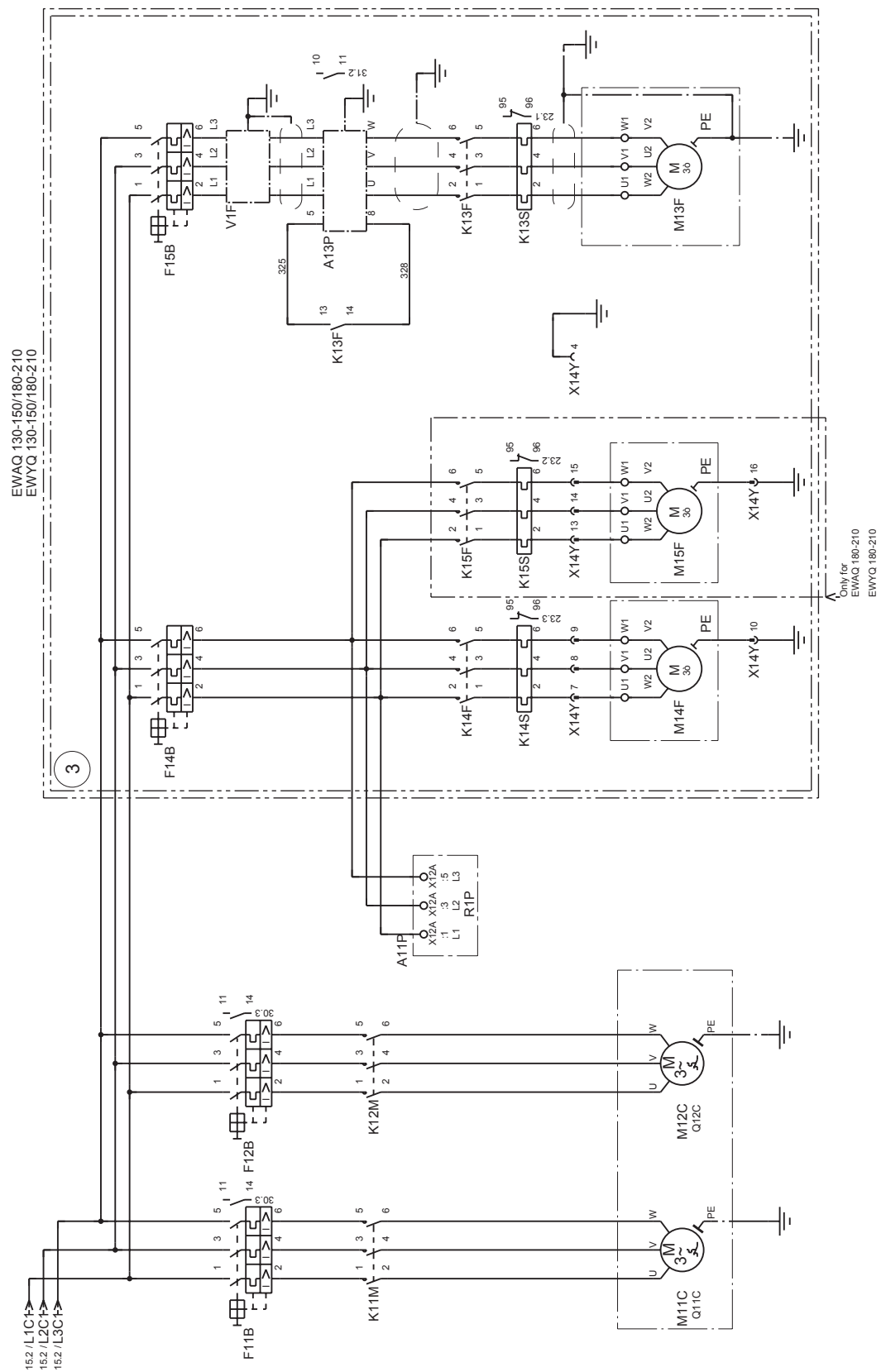

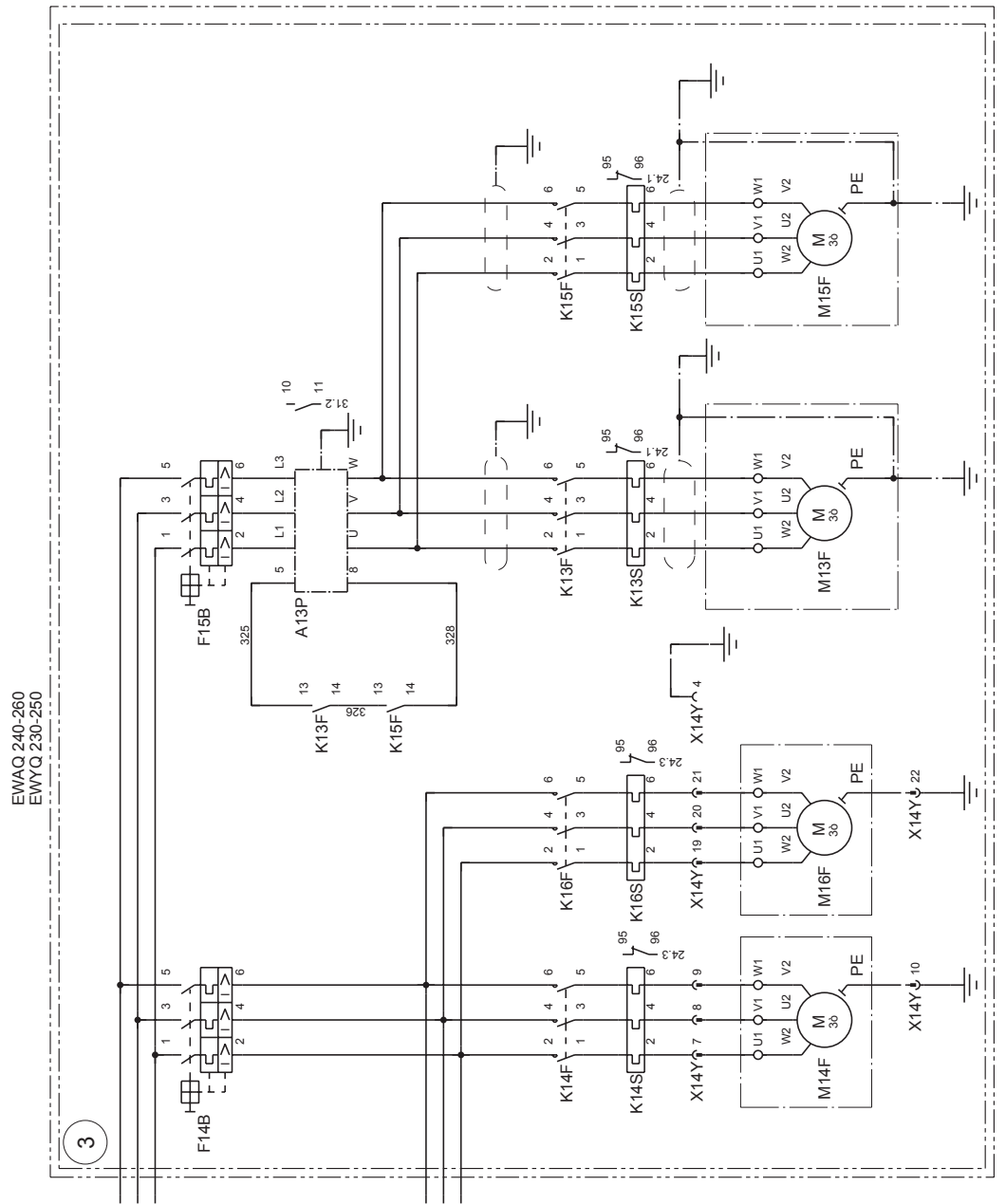

3.5.11 Circuit 1: control compressors

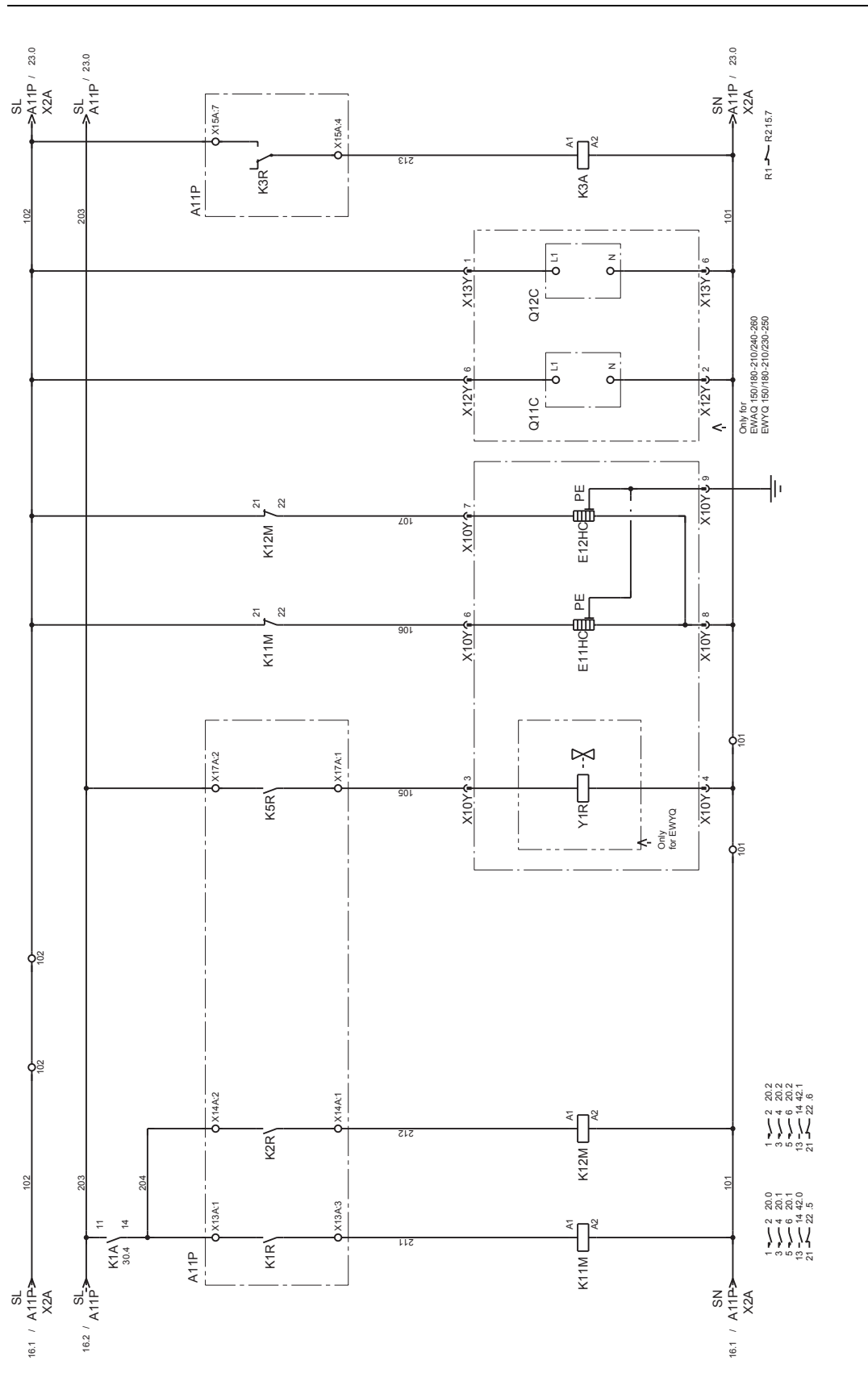

3.5.12 Circuit 1: control fans

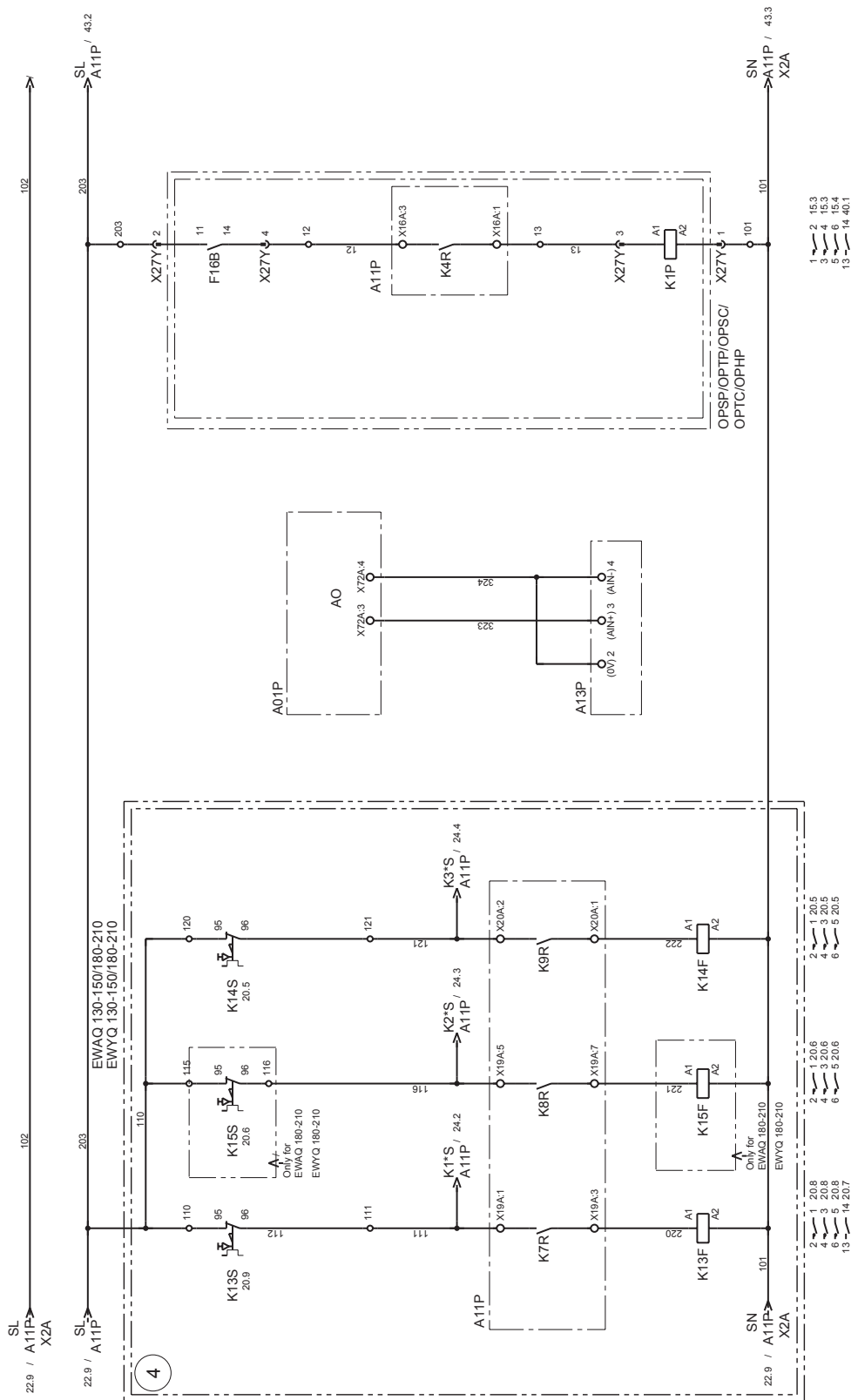

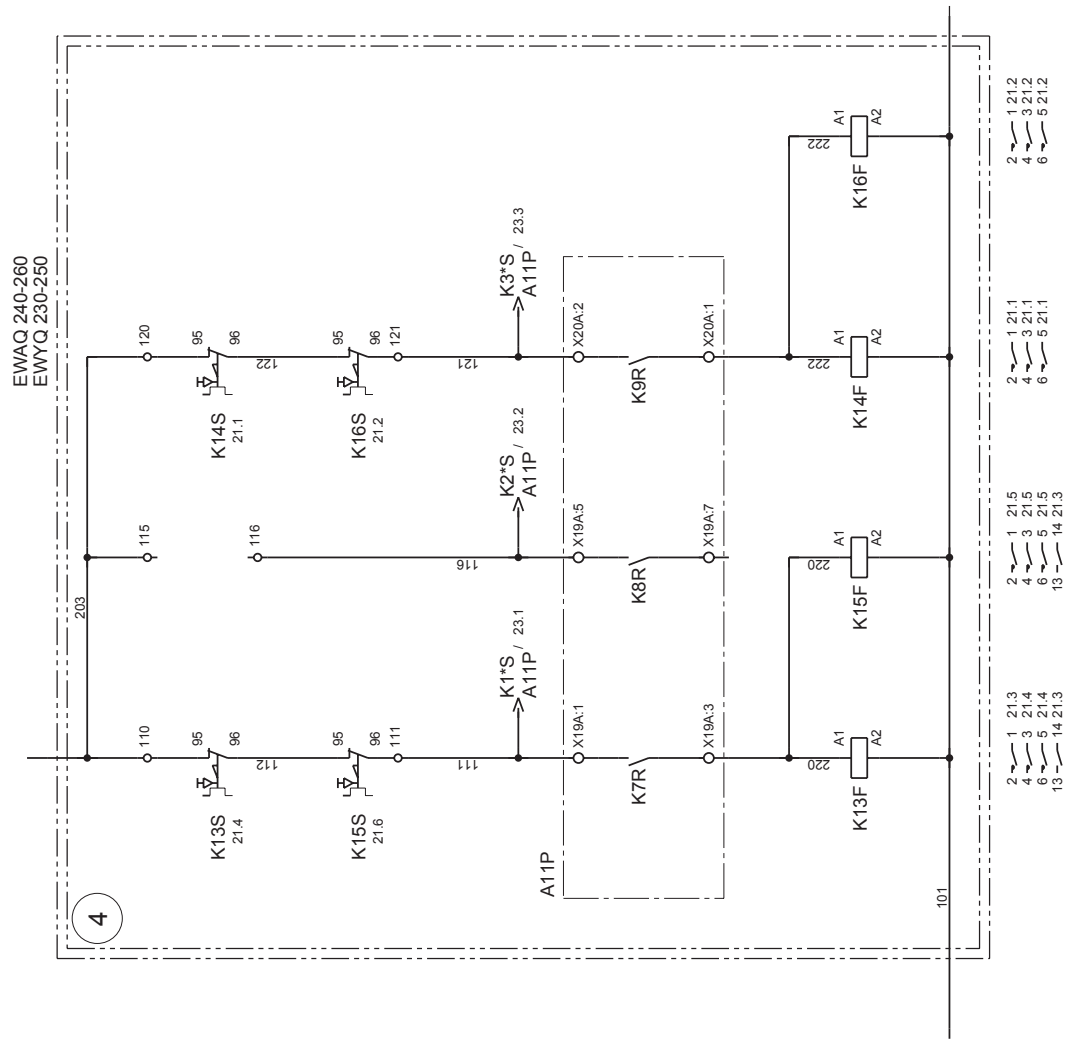

3.5.13 Circuit 2: compressor & fan

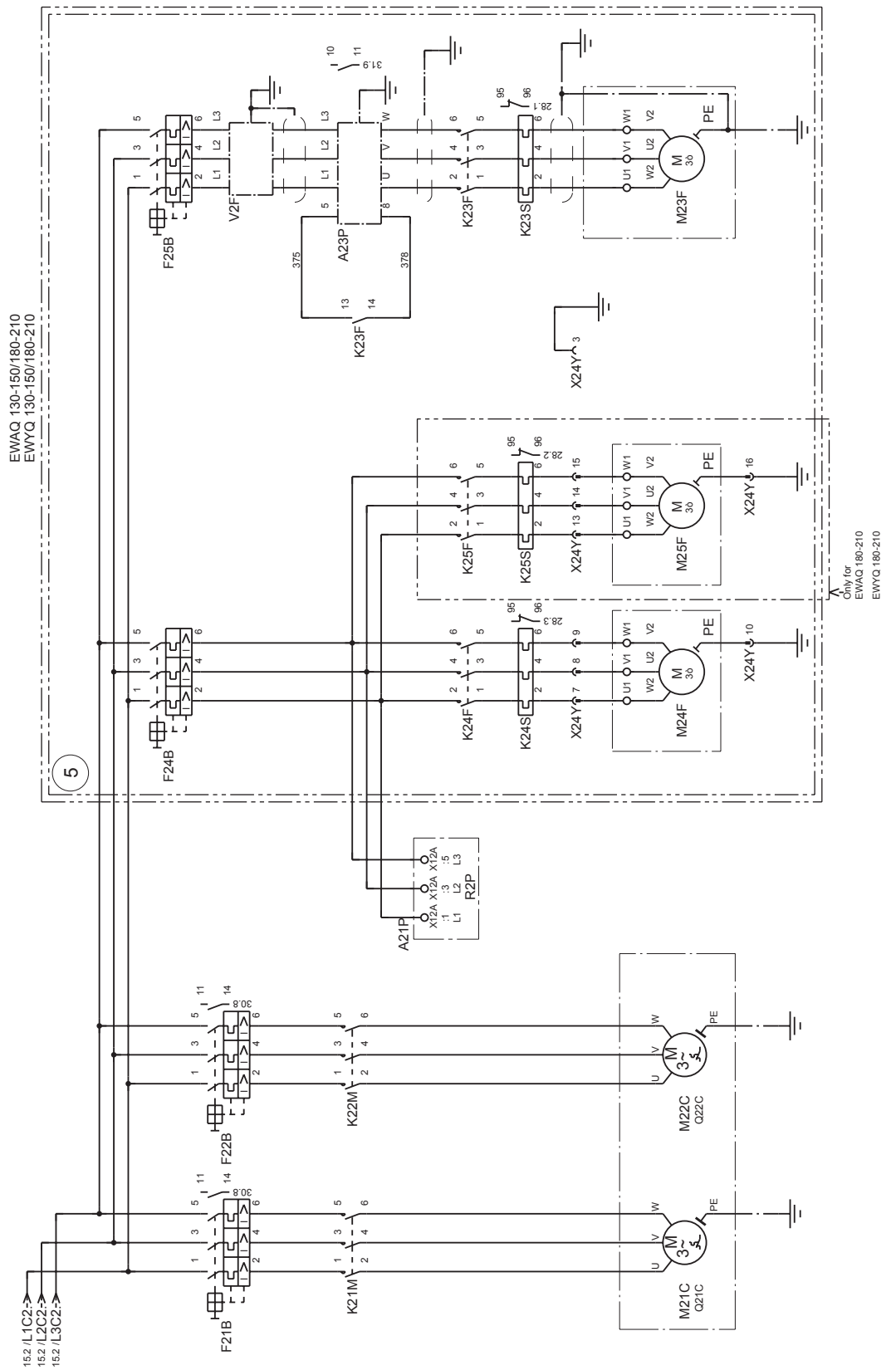

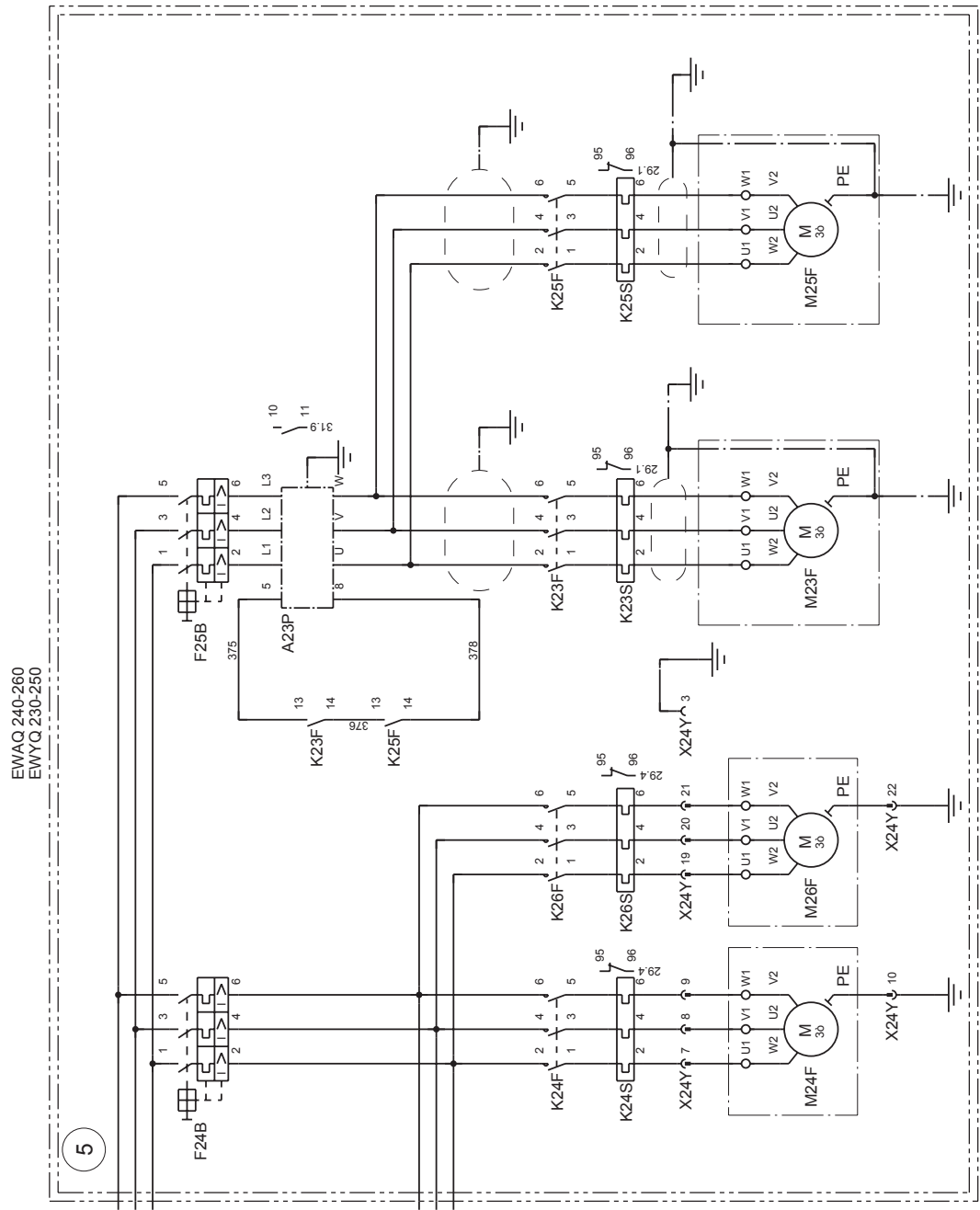

3.5.14 Circuit 2: control compressors

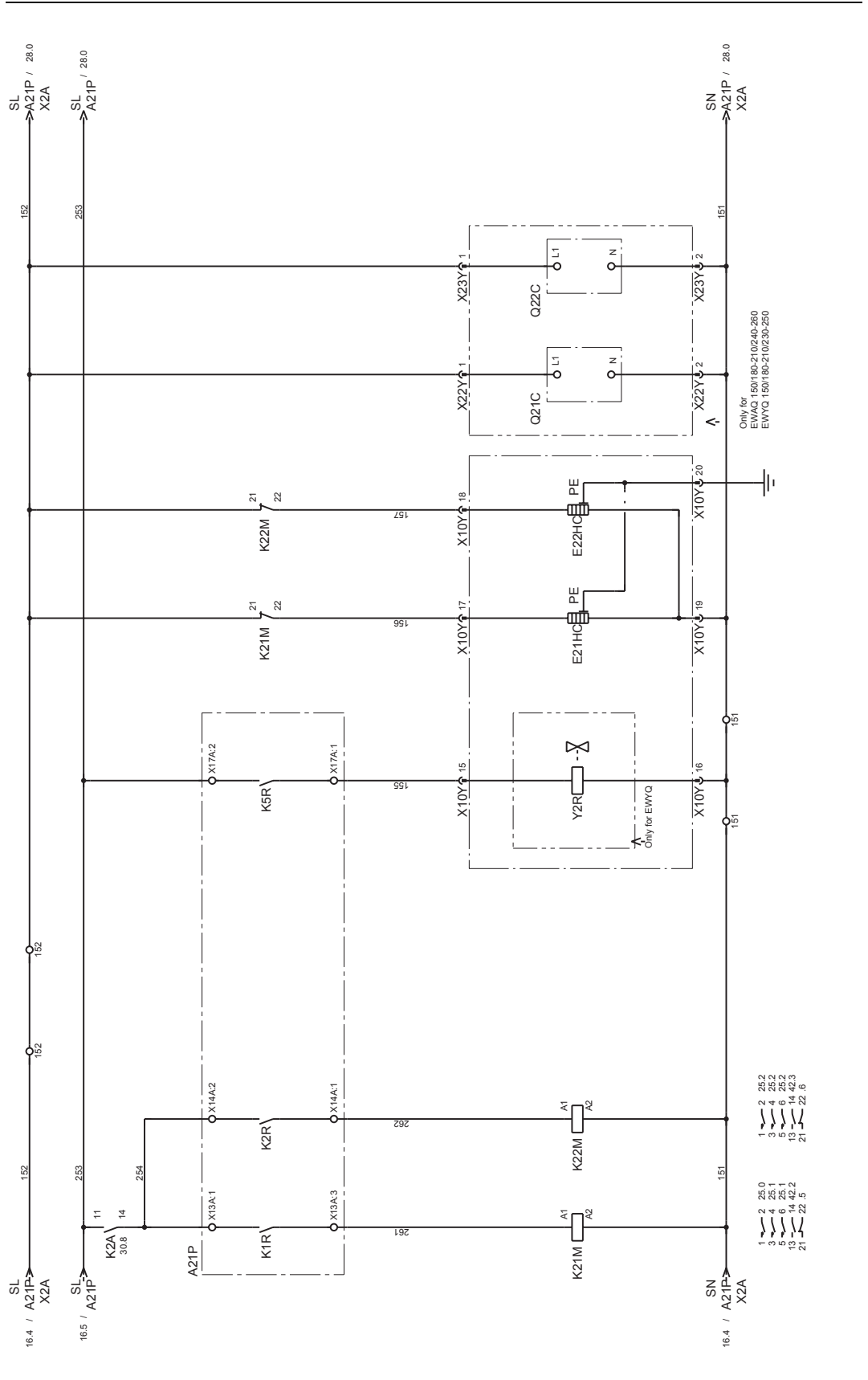

3.5.15 Circuit 2: control fans

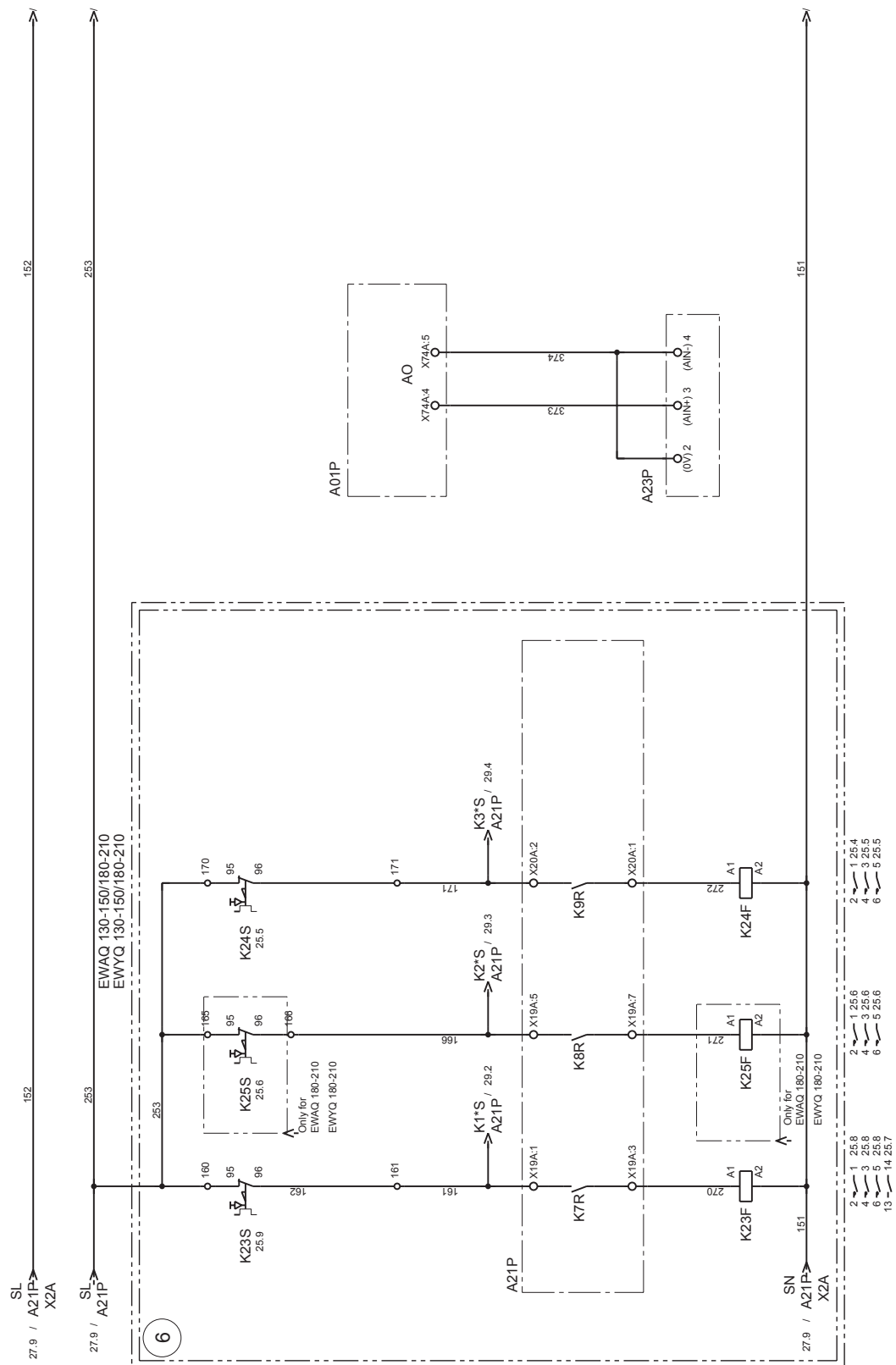

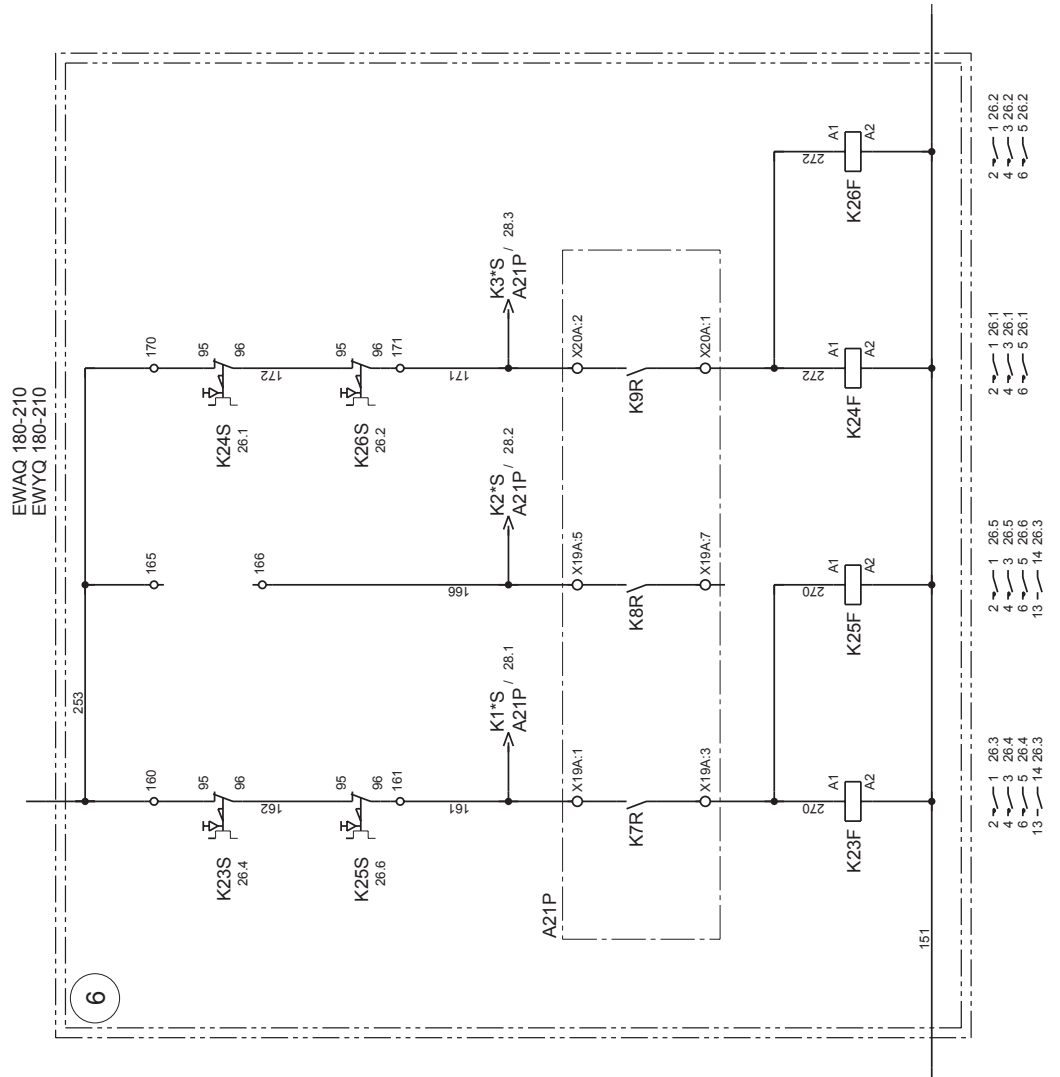

3.5.16 Control circuit (DI 230V)

1

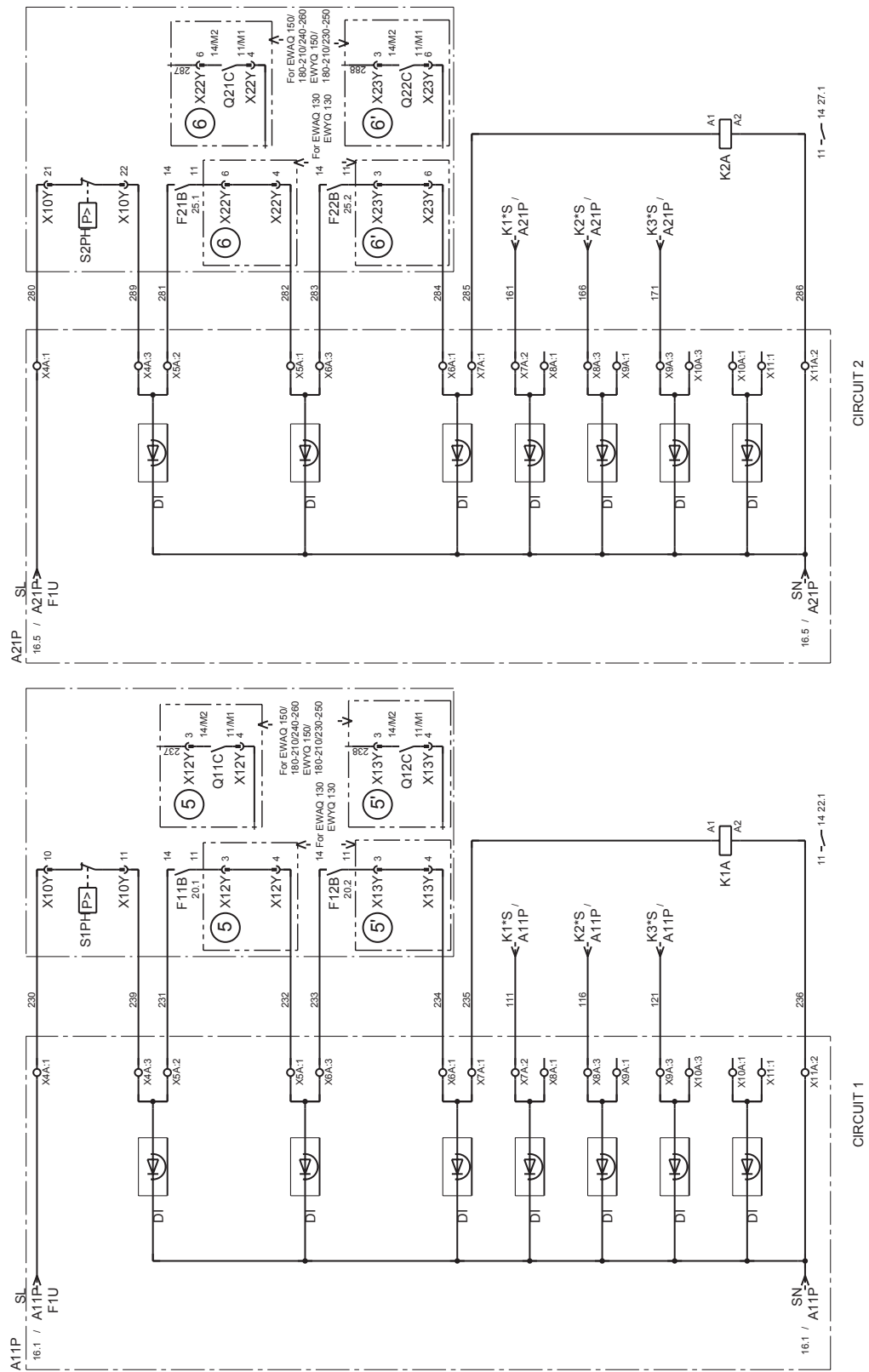

3.5.17 Control circuit and EEV

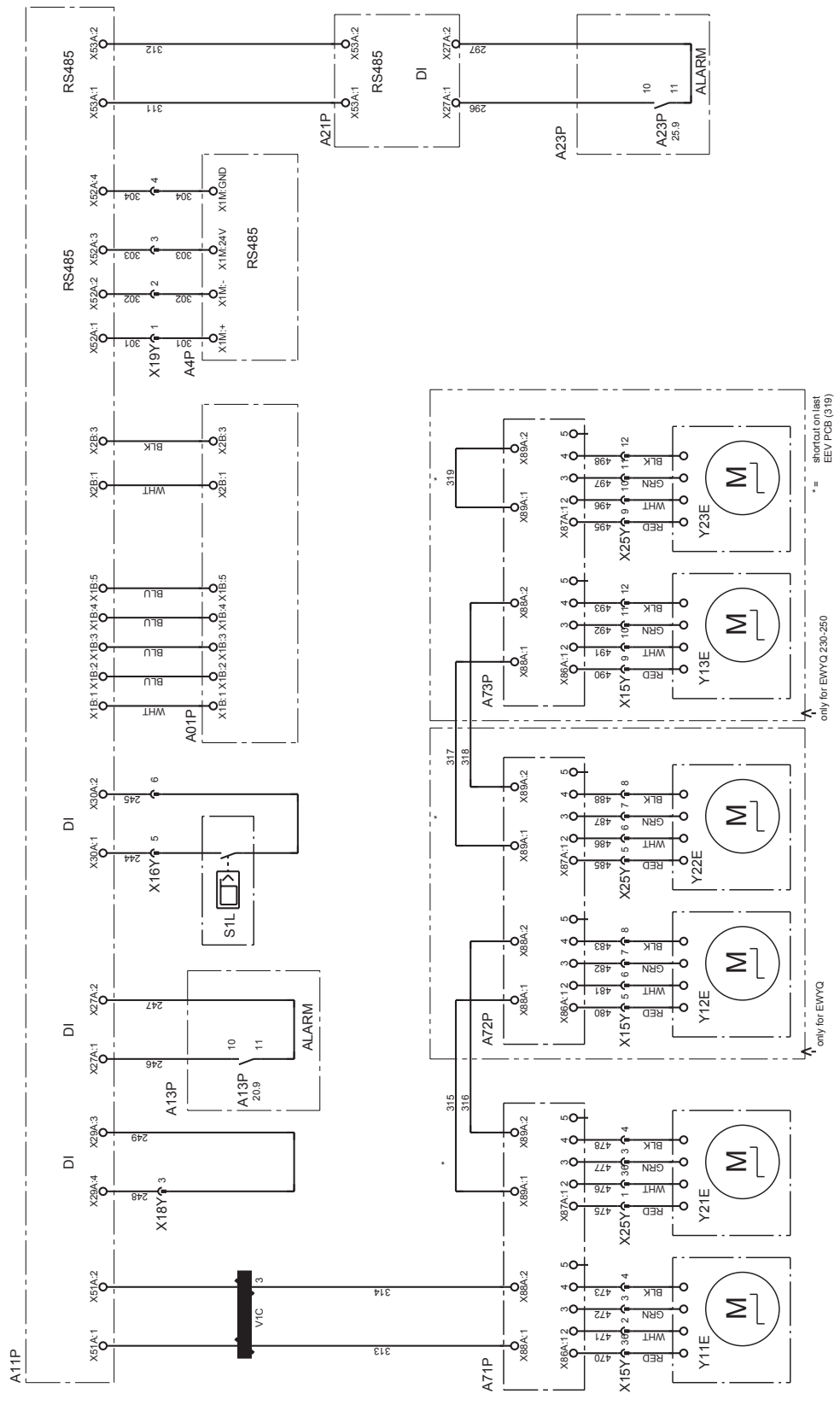

3.5.18 Circuit 1: sensors

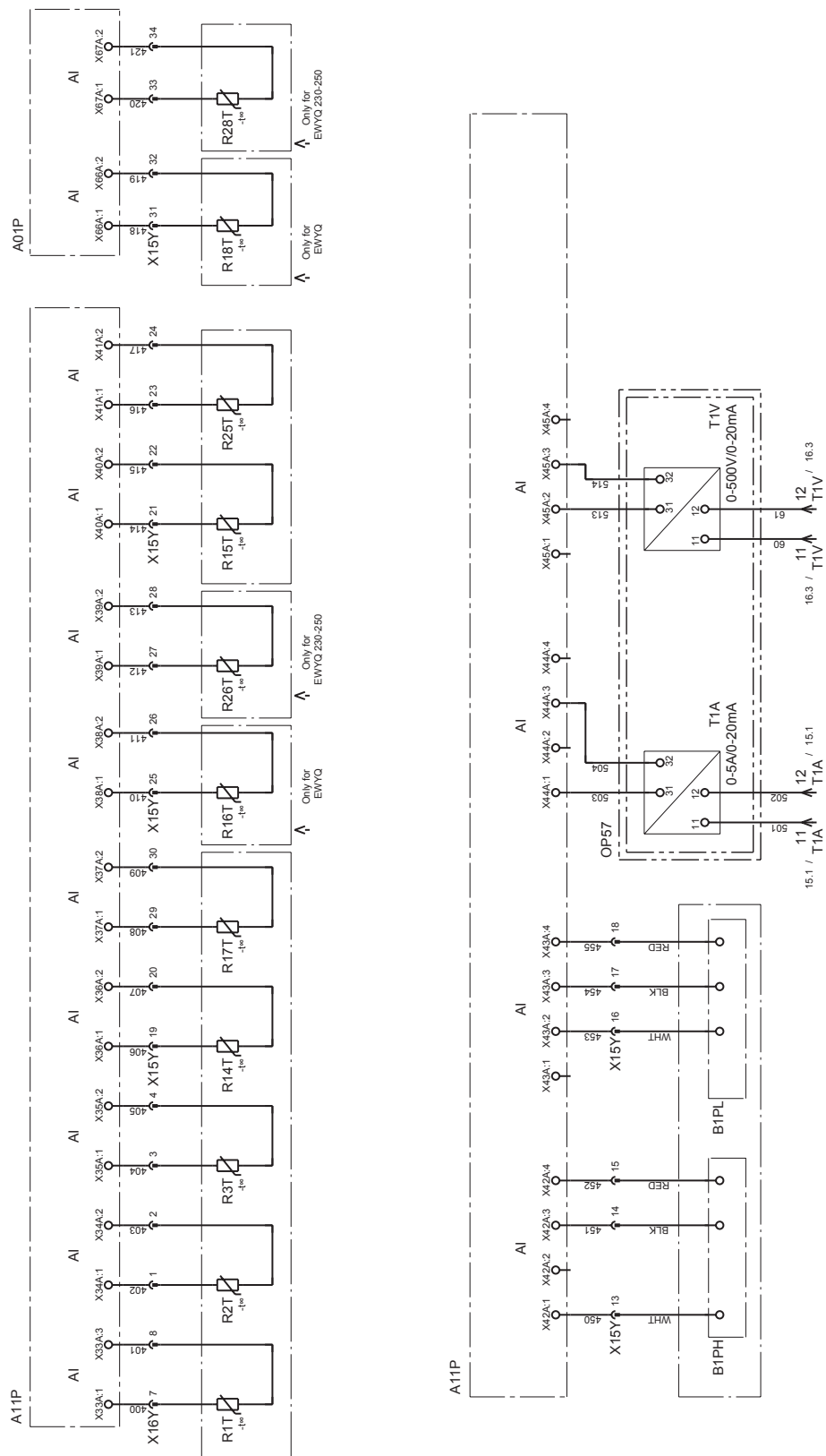

3.5.19 Circuit 2: sensors

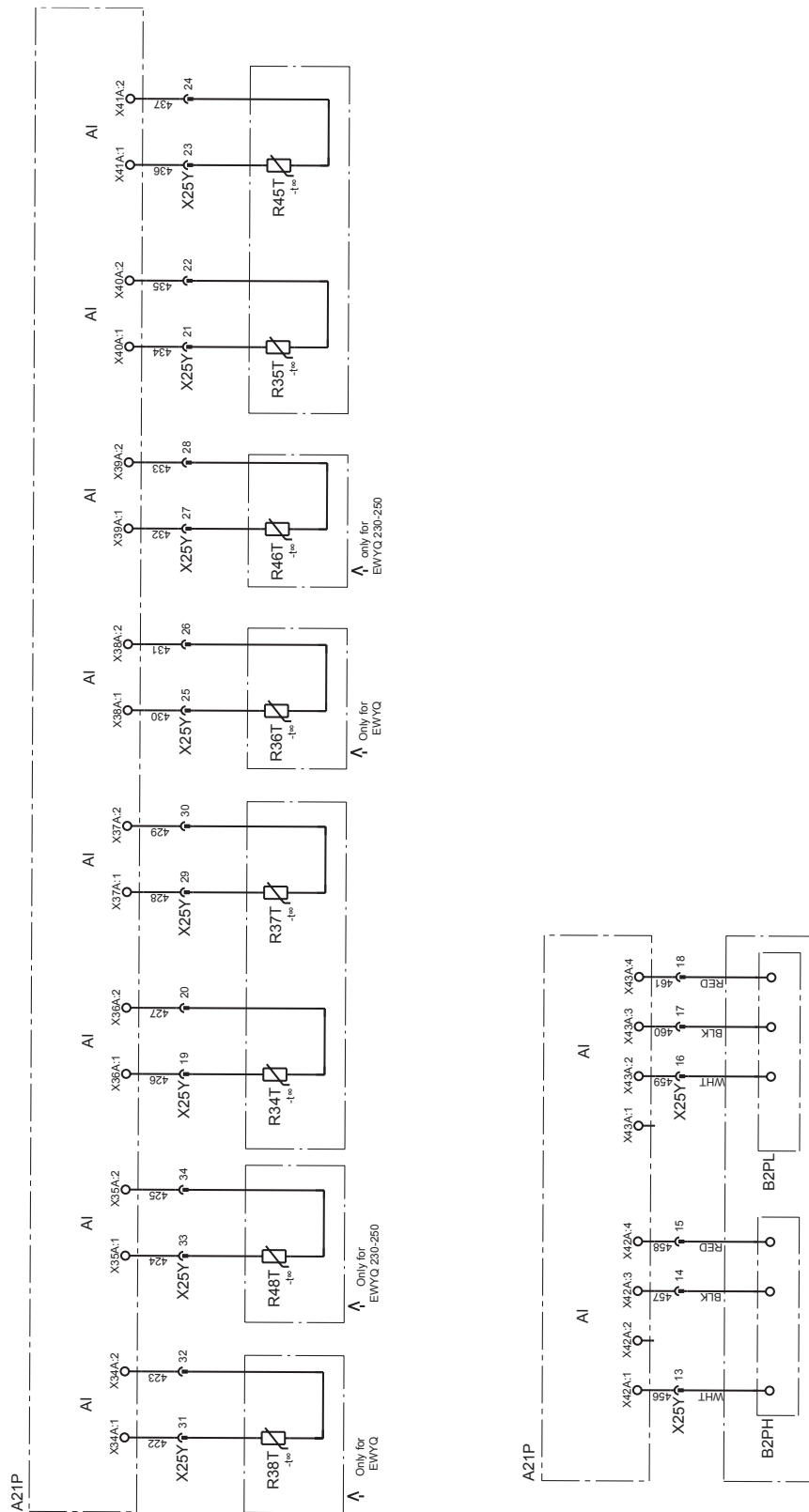

3.5.20 Fieldwiring DI, changeable DI

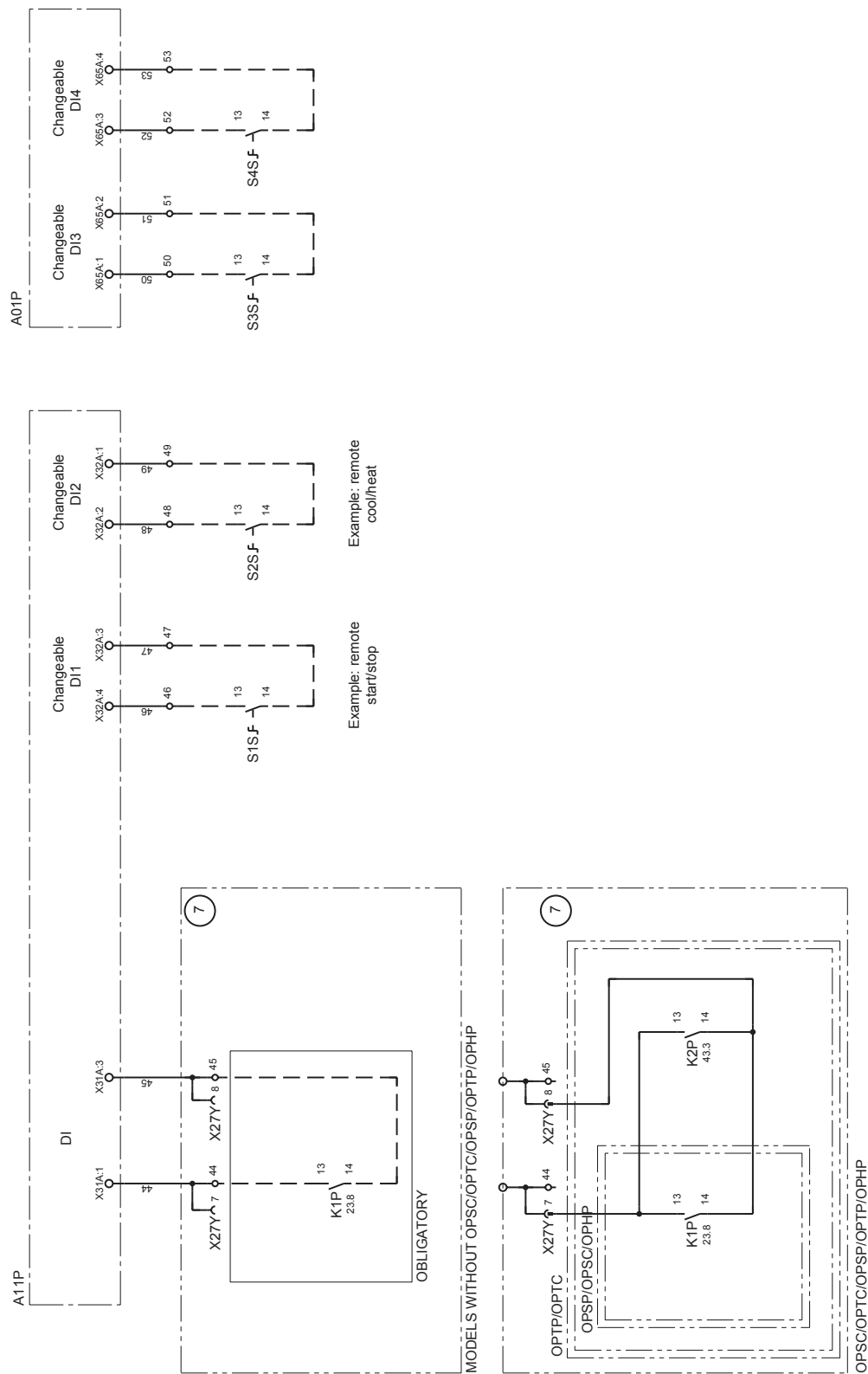

3.5.21 Fieldwiring changeable AI/AO

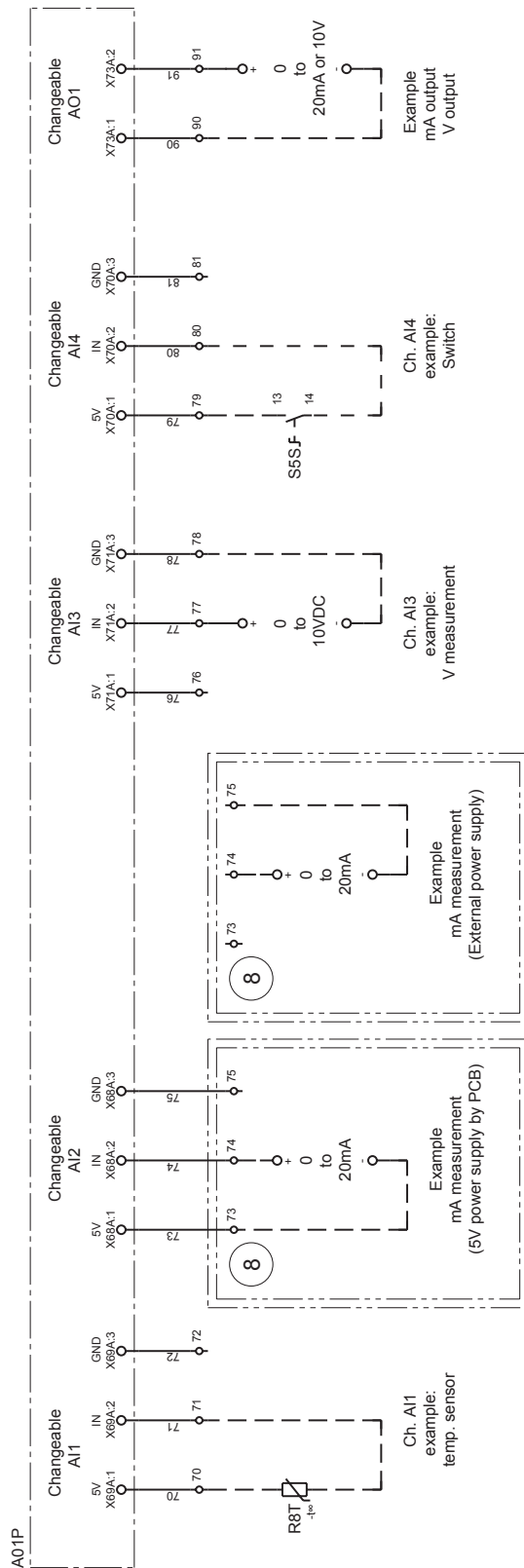

3.5.22 Fieldwiring DO, changeable DO

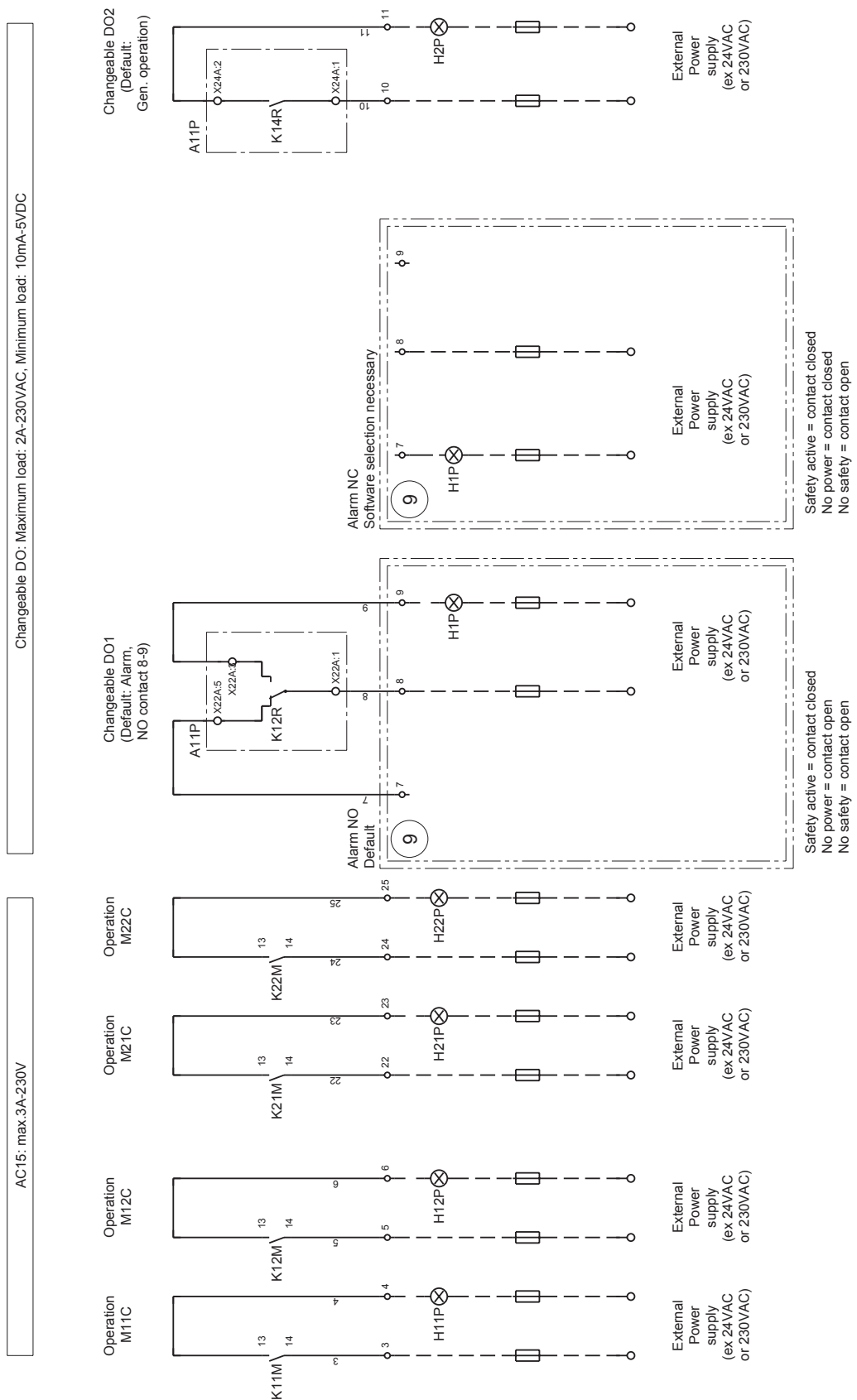

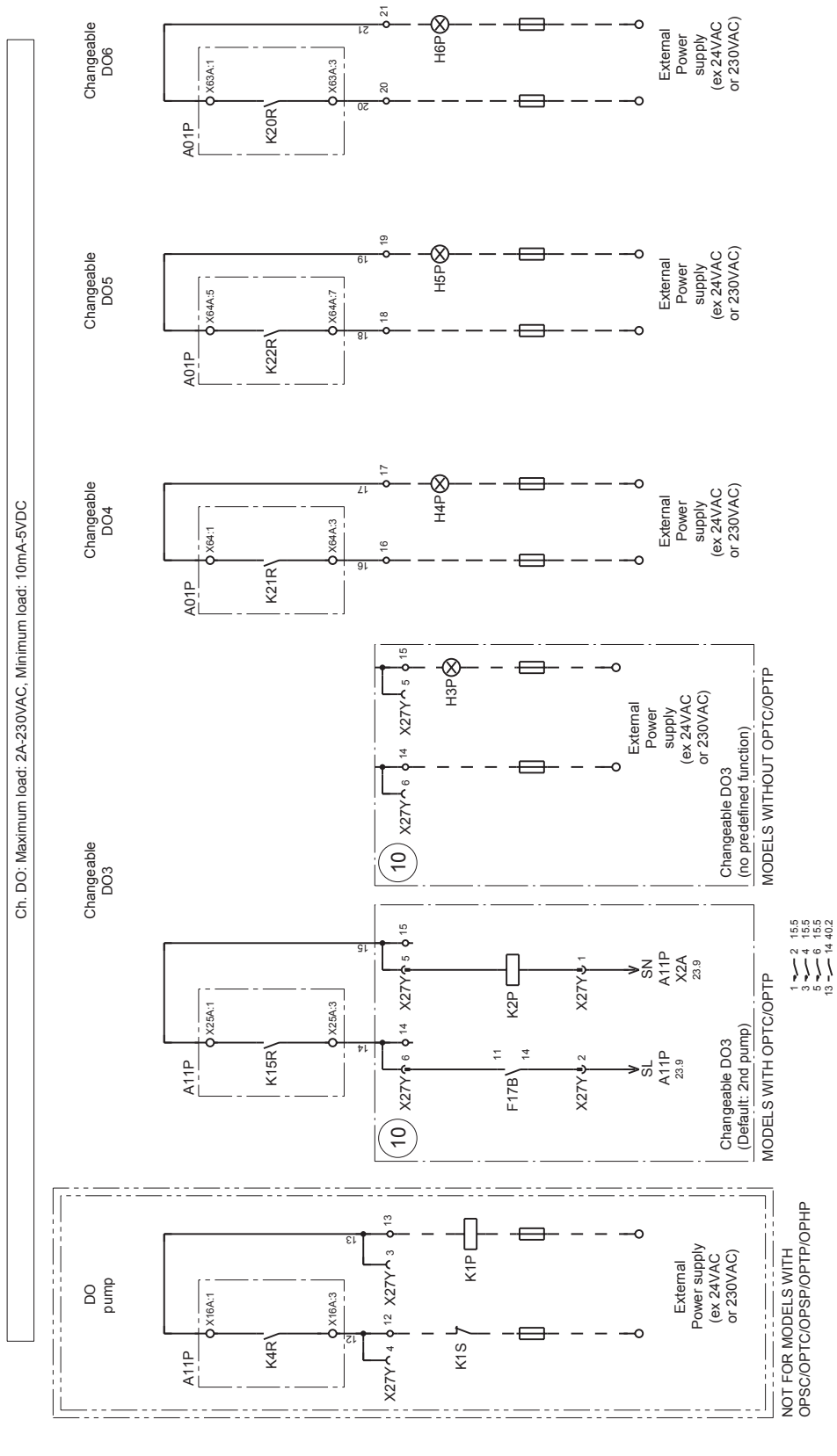

1

Part 2

Functional Description

Introduction

This part gives more detailed information on the functions and controls of the unit. This information is used as background information for troubleshooting. An extensive overview of the functioning of the controller is also given in this part. Knowledge of the controller is essential to gather information prior to servicing and troubleshooting.

What is in this part?

This part contains the following chapters:

Chapter	See page
1–Operation Range	2–3
2–The Digital Controller For Multiscroll Chillers	2–9
3–Functional Control for a Standalone Unit	2–105

2

1 Operation Range

1.1 What Is in This Chapter?

Introduction

This chapter contains the operation range of the different models. Understanding these operation ranges is vital when selecting a chiller or when diagnosing a malfunction that is related to the chiller operation range.

Overview

This chapter contains the following topics:

Topic	See page
1.2—Operational Range: EWAQ080-100-180-210-240-260DAYN(N-P-B)	2–4
1.3—Operational Range: EWAQ130-150DAYN(N-P-B)	2–5
1.4—Operational Range: EWYQ080-100-180-210-230-250DAYN(N-P-B)	2–6
1.5—Operational Range: EWYQ130-150DAYN(N-P-B)	2–7

1.2 Operational Range: EWAQ080-100-180-210-240-260DAYN(N-P-B)

Operational range The illustration below shows the operational range of the EWAQ080-100-180-210-240-260DAYN(N-P-B).

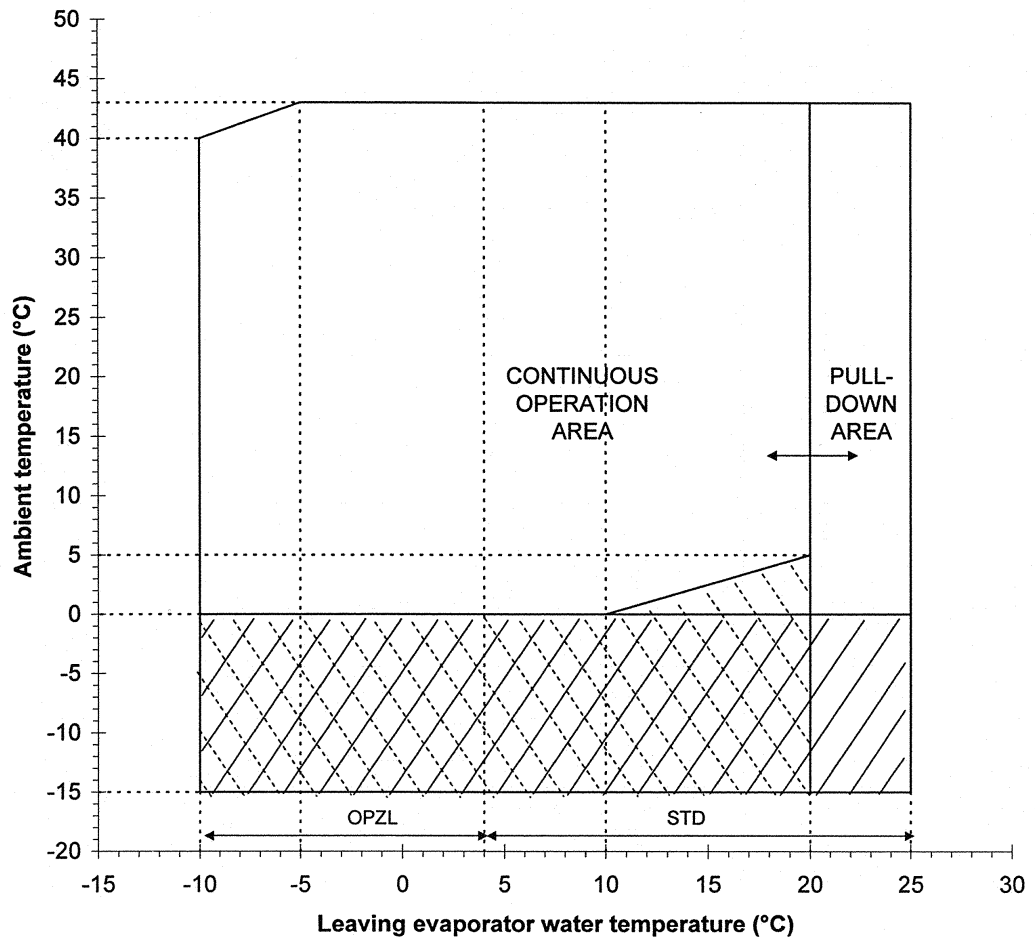

STD: Standard unit

OPZL: Leaving water evaporator from -10° to 4°C by use of glycol

Protect the water circuit against freezing by:



* OP10: heater tape

or

* Filling up the system with a glycol solution (only for unit without pump or unit with OPZL)



OPIF Option Inverter Fans EWAQ080-100-180-210-240-260

1.3 Operational Range: EWAQ130-150DAYN(N-P-B)

Operational range The illustration below shows the operational range of the EWAQ130-150DAYN(N-P-B).

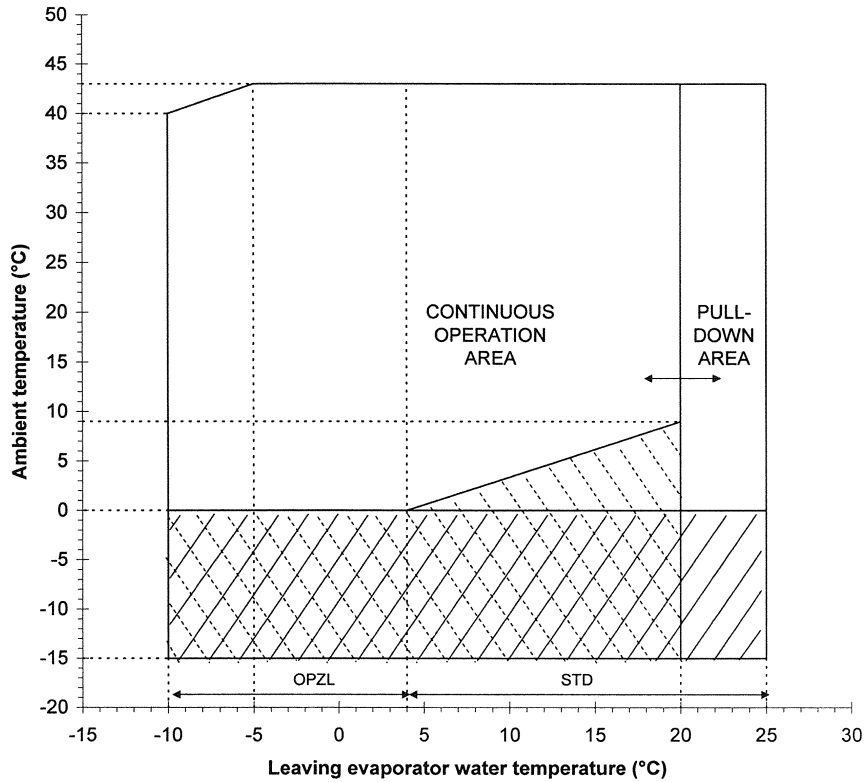

STD: Standard unit

OPZL: Leaving water evaporator from -10° to 4°C by use of glycol

Protect the water circuit against freezing by:



* OP10: heater tape

or

* Filling up the system with a glycol solution (only for unit without pump or unit with OPZL)



OPIF Option Inverter Fans EWAQ130-150

1.4 Operational Range: EWYQ080-100-180-210-230-250DAYN(N-P-B)

Operational range The illustration below shows the operational range of the EWYQ080-100-180-210-230-250DAYN(N-P-B).

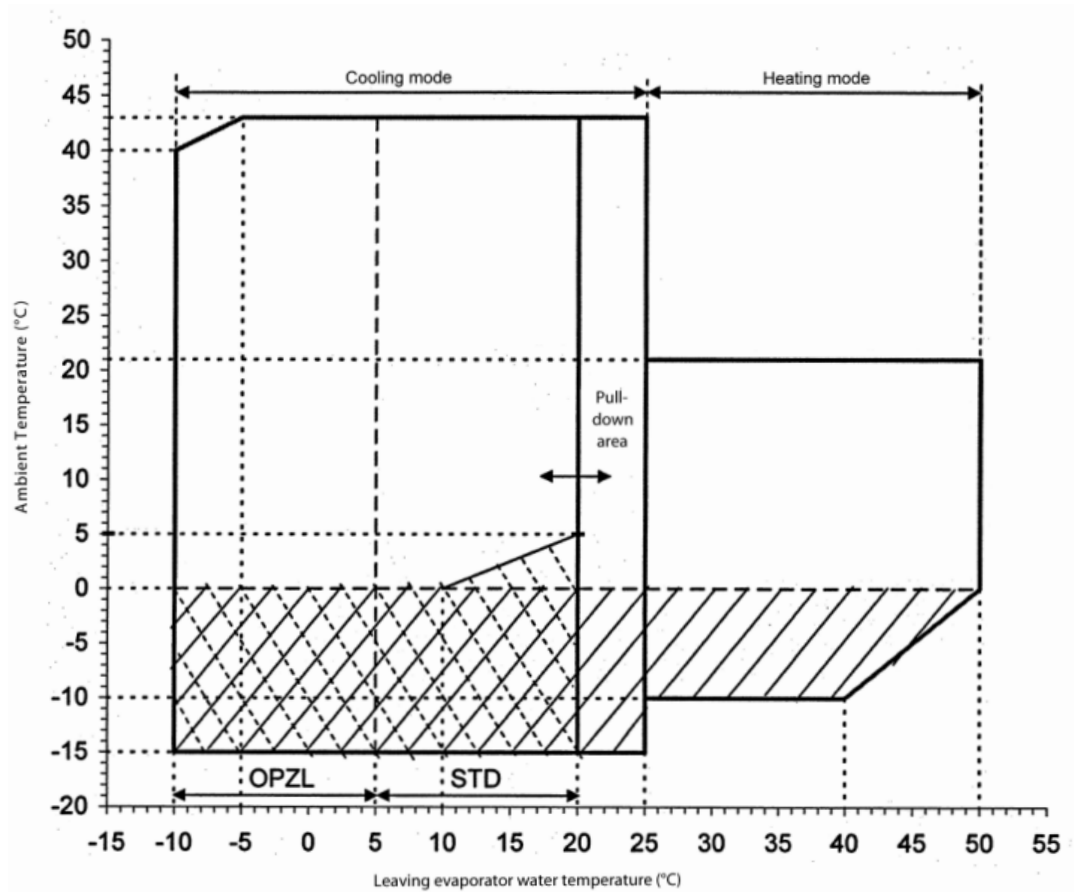

STD: Standard unit

OPZL: Leaving water evaporator from -10° to 5°C by use of glycol

Protect the water circuit against freezing by:



* OP10: heater tape

or

* Filling up the system with a glycol solution (only for unit without pump or unit with OPZL)



OPIF Option Inverter Fans EWYQ080-100-180-210-230-250

1.5 Operational Range: EWYQ130-150DAYN(N-P-B)

Operational range The illustration below shows the operational range of the EWYQ130-150DAYN(N-P-B).

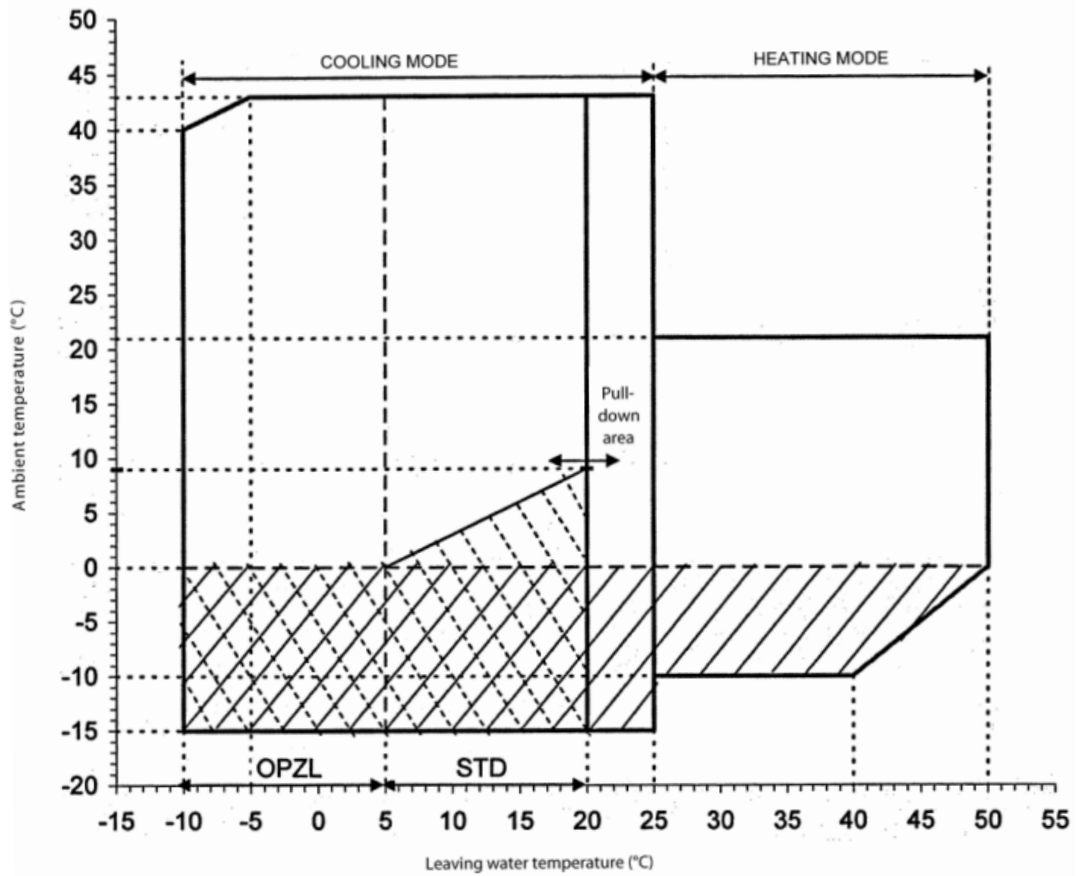

STD: Standard unit

OPZL: Leaving water evaporator from -10° to 5°C by use of glycol

Protect the water circuit against freezing by:



* OP10: heater tape

or

* Filling up the system with a glycol solution (only for unit without pump or unit with OPZL)



OPIF Option Inverter Fans EWYQ130-150

2

2 The Digital Controller For Multiscroll Chillers

2.1 What Is In This Chapter?

Introduction

In this chapter the practical use of the PCASO controller for multiscroll chillers will be explained.

Overview

This chapter contains the following topics:

Topic	See page
2.2–The Controller	2–10
2.3–Start/Stop, Cool/Heat and Temperature settings	2–12
2.4–Menu Overview	2–13
2.5–How to Read or Adjust Parameter Settings: the Programming Procedure	2–14
2.6–Read-out Menu	2–15
2.7–Set Points Menu	2–25
2.8–User Settings	2–26
2.9–Timers menu	2–43
2.10–Info menu	2–45
2.11–Input/Output Status Menu	2–48
2.12–User Password Menu	2–56
2.13–Network Menu	2–58
2.14–Cool / Heat Menu	2–60
2.15–Service Menu	2–61
2.16–Menu overview	2–102
2.17–Service menu overview	2–103

2.2 The Controller

Digital Controller

The EWAP080-260DAYN and EWYP080-250 DAYN units are equipped with a digital controller, offering a user-friendly way to configure, use and maintain the unit.

The digital controller consists of:

- Graphic LCD display
- 6 keys







Front Panel

The illustration below shows the front panel of the controller.





Keys



The table below contains an overview of the keys and their functions.

	key to start up or to shut down the unit
	key to enter the safeties menu or to reset an alarm
	key to enter the main menu or to return to the previous menu
	keys to scroll up or down through the screens of a menu or to raise, or lower a setting
	
	key to confirm a selection or a setting



How to switch between screens

Each menu contains a number of screens. You can switch between the screens, using the  or  keys. In the upper-left corner of the screen you will find a screen indicator, indicating whether there is a previous or next screen.

An overview is given in the table below:

The screen indicator	Indicates that you should do the following
^	First screen of the menu, press  to go to the next screen
v	Last screen of the menu, press  to go to the previous screen
+	either return to the previous or go to the next screen

Screen Detail

Each screen contains 4 lines which give information about a setting (a description and an entry field). The entry fields can be adjusted using the  and the  keys.

The cursor is marked by the sign "_". The cursor can be moved between the screen indicator and the entry fields using the  key.

The cursor can be moved directly to the screen indicator by pressing the  key.

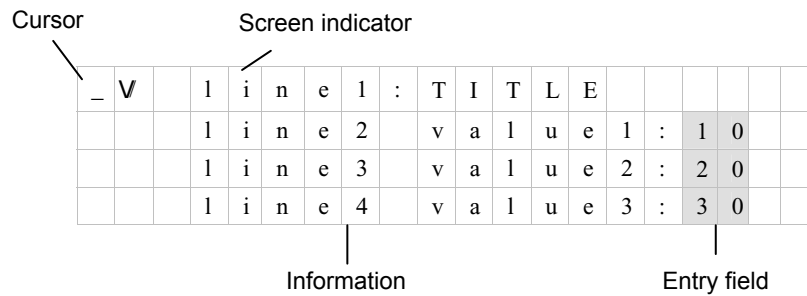

Remark: Make sure that the cursor is at the screen indicator position when scrolling through the screens. After changing a entry field push the  key to confirm the setting.

2.3 Start/Stop, Cool/Heat and Temperature settings

Power on

- The initialization takes 20 seconds.
- The controller automatically goes to the menu overview.

Remote start/stop

The procedure to start or stop the unit depends on the settings of the remote start/stop.

Remark: The remote start/stop is field supply.

How to start or stop

Local key	Remote Switch	Unit	⏻ LED
ON	ON	ON	ON
ON	OFF	OFF	Flashing
OFF	ON	OFF	OFF
OFF	OFF	OFF	OFF

How to cool or heat

To change from cooling to heating (or visa versa) you have to enter the Cooling/Heating menu through the main menu or a remote cool/heat signal can be used.

Remark: The remote cool/heat is field supply.

Temperature Setting

To adjust the inlet or outlet water temperature, go to the Set Points menu through the main menu.

2.4 Menu Overview

Introduction

This chapter gives an overview of the screens provided by the different menus.

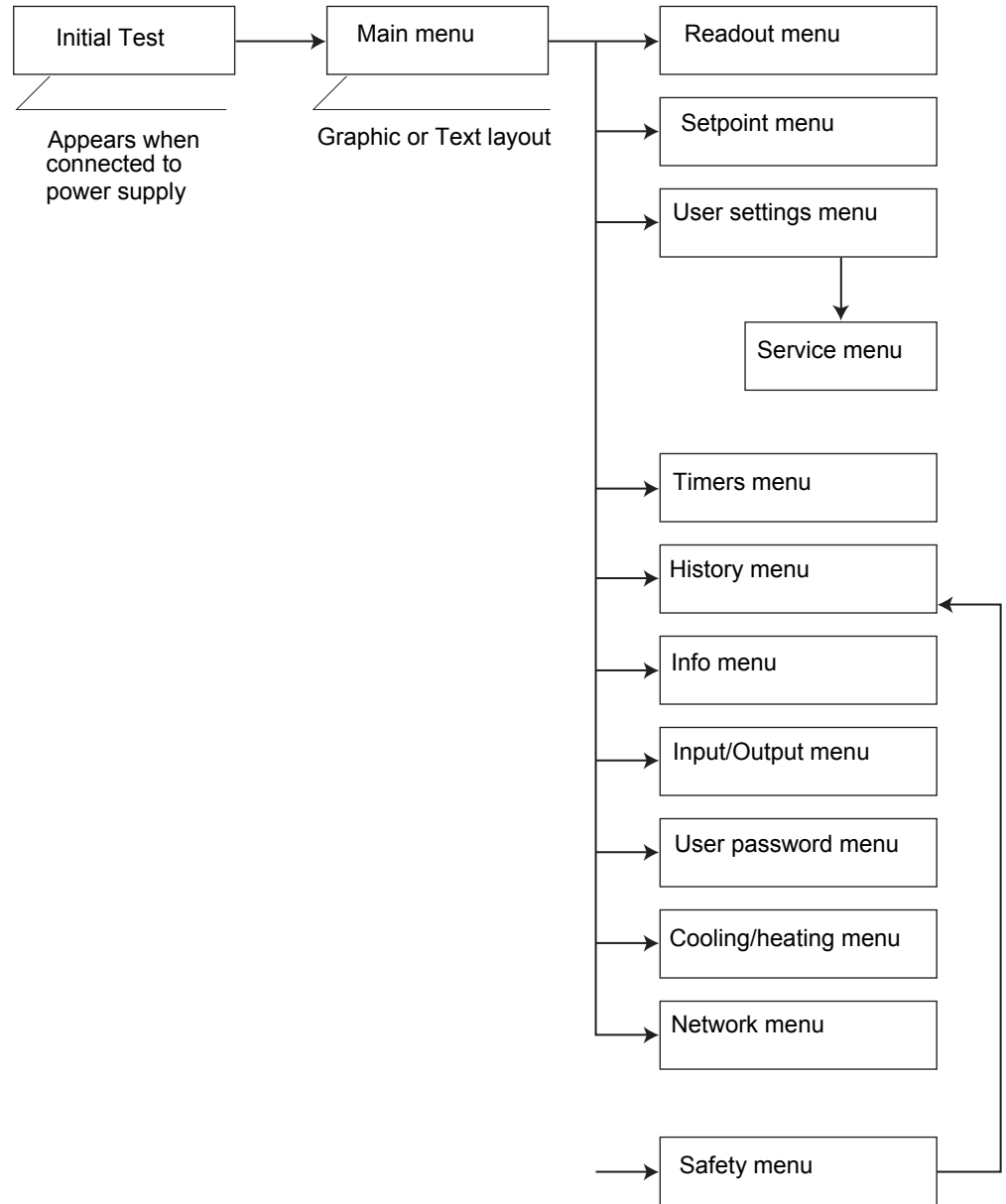

2.5 How to Read or Adjust Parameter Settings: the Programming Procedure

Programming Procedure

2

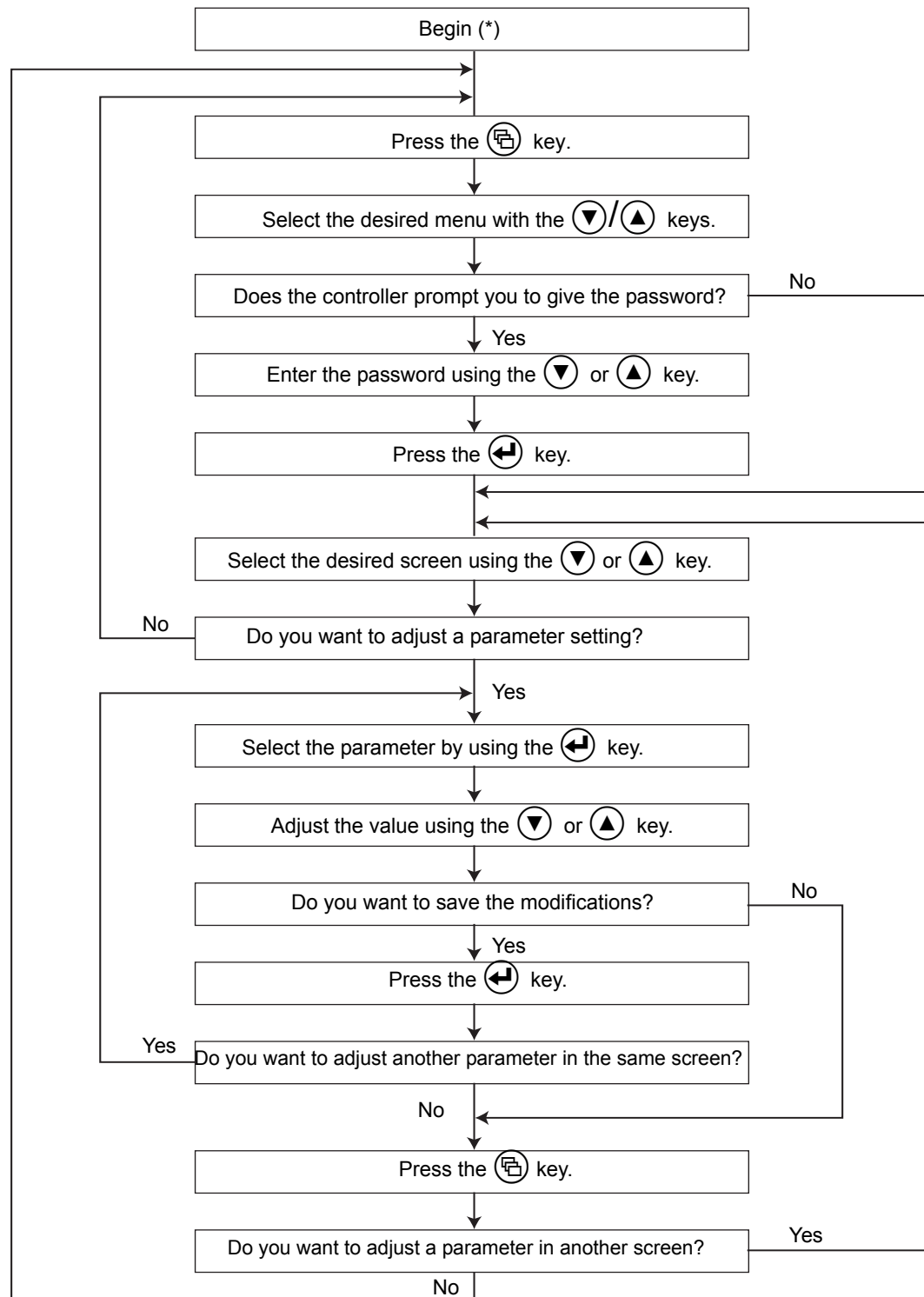

(*): The display shows the last screen used.

2.6 Read-out Menu

Operational information





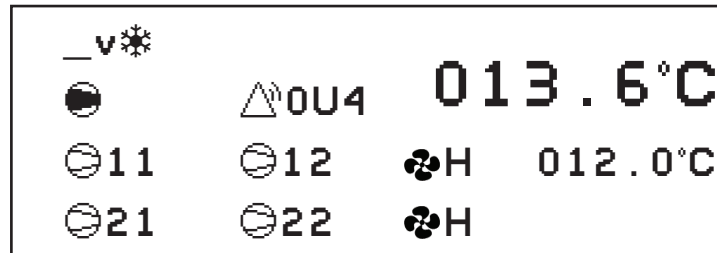

Using this menu you can read the operational information, such as the cooling set points, the inlet and outlet water temperature, the circuit status, etc. This menu allows access to several screens. The number of screens depends on the unit type and the options.

Screen 1

This screen shows the actual operational information about the status of the pump, the compressor, the fans and the temperature setpoint. This screen can be enabled or disabled in the service/advanced menu.

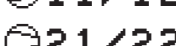

Legend:

-  cooling mode
-  heating mode
-  fan (**H** high or **L** low or % of inverter fan output)
-  low noise mode activated (only available when option OPIF is installed)
-  pump on
-  in case of dual pump control: pump 1/2 on
-  circuit 1 compressor 1/2 on
-  circuit 2 compressor 1/2 on
-  alarm and last occurred malfunction code (**OU4** in example)
- 13.6°C** actual temperature (inlet or outlet temperature depending on active mode)
- 12.0°C** temperature setpoint (inlet or outlet temperature depending on active mode)

Screen 2

This screen shows the actual operational information about the control mode, the inlet, outlet water temperature and ambient temperature.

```

_ ÷ COOL . INLSP1 : 012.0°C
      INLET WATER : 013.6°C
      OUTLET WATER : 007.0°C
      AMBIENT : 006.5°C
  
```

Display	Description
COOL	operation in cooling mode
HEAT	operation in heating mode
INLSP(1)(2)	inlet temperature setpoint 1 (or 2 in case of dual set-point setting)
OUTSP(1)(2)	outlet temperature setpoint 1 (or 2 in case of dual set-point setting)
INLET WATER	Actual inlet water temperature
OUTLET WATER	Actual outlet water temperature
AMBIENT	Actual ambient temperature

Remark: For a DICN system, the INLET WATER and OUTLET WATER values are the values of the individual unit, not of the system. Temperatures of the system can be consulted in the first screen of the network menu.

These screens show the actual operational information about the EEV control. They are only visible when they are enabled in the Service/EEV menu.

Screen 3

```

      C1 TEMP.READOUT
      SUCTION C1 : 007.4°C
      SUPERHEAT C1 : 007.3°C
      EEV PULS C1 : 0000PLS
  
```

Screen 4

```

C1 TEMP.READOUT
SUCTION H11:007.4°C
SUPERHEAT H11:007.3°C
EEV PULS H11:0000PLS
    
```

Screen 5

```

C1 TEMP.READOUT
SUCTION H12:007.4°C
SUPERHEAT H12:007.3°C
EEV PULS H12:0000PLS
    
```

Display	Description
C1 TEMP. READOUT	operational information EEV control of circuit 1
SUCTION C1	suction temp. in cooling mode of circuit 1
SUCTION H11	suction temp. in heating mode of compressor 1 of circuit 1
SUCTION H12	suction temp. in heating mode of compressor 2 of circuit 1
SUPERHEAT C1	actual superheat in cooling mode of circuit 1
SUPERHEAT H11	actual superheat in heating mode of coil 1 of circuit 1
SUPERHEAT H12	actual superheat in heating mode of coil 2 of circuit 1
EEV PULS C1	actual electronic expansion valve opening in cooling mode
EEV PULS H11	actual electronic expansion valve opening in heating mode of expansion valve of coil 1
EEV PULS H12	actual electronic expansion valve opening in heating mode of expansion valve of coil 2

These screens show the actual operational information about the EEV control. They are only visible when they are enabled in the service / EEV menu. The screens are only visible if the unit has 2 circuits.

Screen 6

C2 TEMP. READOUT
 SUCTION C2 : 007.4°C
 SUPERHEAT C2 : 007.3°C
 EEV PULS C2 : 0000PLS

Screen 7

C2 TEMP. READOUT
 SUCTION H21 : 007.4°C
 SUPERHEAT H21 : 007.3°C
 EEV PULS H21 : 0000PLS

Screen 8

C2 TEMP. READOUT
 SUCTION H22 : 007.4°C
 SUPERHEAT H22 : 007.3°C
 EEV PULS H22 : 0000PLS

Display	Description
C2 TEMP. READOUT	operational information EEV control of circuit 2
SUCTION C2	suction temp. in cooling mode of circuit 2
SUCTION H21	suction temp. in heating mode of compressor 1 of circuit 2
SUCTION H22	suction temp. in heating mode of compressor 2 of circuit 2
SUPERHEAT C2	actual superheat in cooling mode of circuit 2
SUPERHEAT H21	actual superheat in heating mode of coil 1 of circuit 2
SUPERHEAT H22	actual superheat in heating mode of coil 2 of circuit 2
EEV PULS C2	actual electronic expansion valve opening in cooling mode
EEV PULS H 21	actual electronic expansion valve opening in heating mode of expansion valve of coil 1
EEV PULS H22	actual electronic expansion valve opening in heating mode of expansion valve of coil 2

Screen 9

These screens show the actual operational information about the discharge temperature of circuits 1 and 2 for compressors 1 and 2.

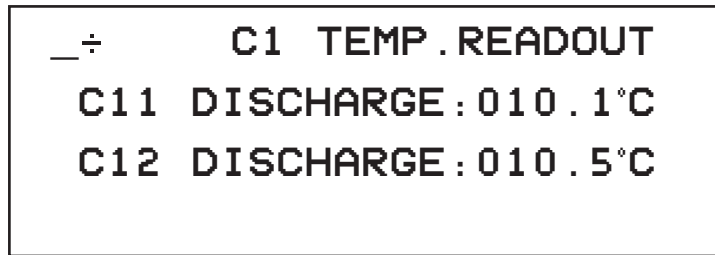

Screen 10

This screen is only visible if the unit has 2 circuits.

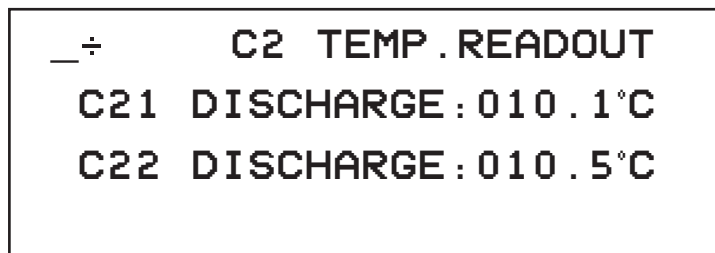

Display	Description
C1 TEMP. READOUT	discharge temperature readout of circuit 1
C2 TEMP. READOUT	discharge temperature readout of circuit 2
C11 DISCHARGE	discharge temperature compressor 1 of circuit 1
C12 DISCHARGE	discharge temperature compressor 2 of circuit 1
C21 DISCHARGE	discharge temperature compressor 1 of circuit 2
C22 DISCHARGE	discharge temperature compressor 2 of circuit 2

These screens show the actual operational information about the refrigerant temperature and the coil temperature.

Screen 11

__ ÷ C1 TEMP. READOUT
 C1 REFR : 000.0°C
 C11 COIL : 000.0°C
 C12 COIL : 000.0°C

Screen 12

This screen is only visible if the unit has 2 circuits.

__ ÷ C2 TEMP. READOUT
 C2 REFR : 000.0°C
 C21 COIL : 000.0°C
 C22 COIL : 000.0°C

Display	Description
C1 TEMP. READOUT	Temperature readout of circuit 1
C2 TEMP. READOUT	Temperature readout of circuit 2
C1 REFR.	Refrigerant temperature of circuit 1
C2 REFR.	Refrigerant temperature of circuit 2
C11 COIL	Temperature of coil 1 of circuit 1
C12 COIL	Temperature of coil 2 of circuit 1
C21	Temperature of coil 1 of circuit 2
C22	Temperature of coil 2 of circuit 2

Remark: Coil sensors are only present on EWYQ units.

These screens show the actual operational information about the high and low pressure and the fan output.

Screen 13

```

_÷ C1 ACT. PRESSURES
HP1:019.0b = 050.8°C
LP1:004.4b = -05.2°C
FAN1:OFF
    
```

Screen 14

This screen is only visible if the unit has 2 circuits.

```

_÷ C2 ACT. PRESSURES
HP2:019.0b = 050.8°C
LP2:004.4b = -05.2°C
FAN2:OFF
    
```

Display	Description
C1 ACT. PRESSURES	actual pressures of circuit 1
C2 ACT. PRESSURES	actual pressures of circuit 2
HP1: b = °C	actual high pressure and corresponding temperature
LP1: b = °C	actual low pressure and corresponding temperature
HP2: b = °C	actual high pressure and corresponding temperature
LP2: b = °C	actual low pressure and corresponding temperature
FAN1/FAN2	actual fan output OFF : OFF L : low speed M : medium speed H : high speed 000% : percentage of inverter fan output (only with OPIF)
LOW NOISE : N/Y	Indication if low noise mode is active at the moment (only with OPIF)

These screens show the actual status of the circuit 1 or circuit 2 compressors and the capacity of the unit.

Screen 15

_ ÷ **UNIT STATUS**

C11 : OFF SAFETY ACT .

C12 : OFF SAFETY ACT .

UNIT CAPACITY : 000%

This screen is only visible if the unit has 2 circuits.

Screen 16

_ ÷ **UNIT STATUS**

C21 : OFF SAFETY ACT .

C22 : OFF SAFETY ACT .

Display	Description
C11	status of compressor 1 of circuit 1
C12	status of compressor 2 of circuit 1
C21	status of compressor 1 of circuit 2
C22	status of compressor 2 of circuit 2
UNIT CAPACITY	percentage of the total unit capacity

Possible compressor status:

- **SAFETY ACT:** one of the circuit safety devices is activated.
- **FREEZEUP DIS:** the compressor is disabled by the freeze-up disable function.
- **FREEZEUP PR:** the freeze-up prevention is active.
- **DEFROST BUSY:** defrost is active on this circuit.
- **COMP PR:** the compressor protection function is active.
- **HP SETBACK:** the high pressure setback is active.
- **MIN.RUN.TIM.:** the minimum running time of the compressor is active.
- **LIMIT:** the compressor is limited by the limitation function.
- **STANDBY DICN:** when in a DICN configuration, the unit is in standby mode because there is sufficient current capacity to maintain set point.
- **UNIT OFF:** the unit is switched off.
- **AREC INLET:** the compressor will not start up when the inlet water temperature has not risen enough compared to the previous switch off of the compressor.
- **FREE COOLING:** the free cooling mode is active.
- **TIMER BUSY:** the actual value of one of the compressor timers is not zero.
- **PUMPLEAD TIM:** the compressor will wait to start up for as long as the pump lead timer is counting down.

Screen 17

This screen shows the actual operational information about the current (Ampère) and voltage of the unit.

This screen is only visible when the A-meter, V-meter (option OP57) is installed.

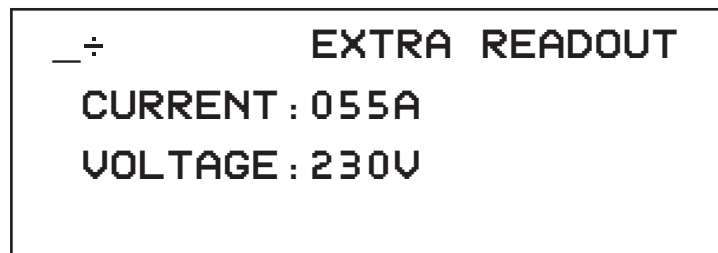

These screens show the actual operational information about the total running hours in cooling and heating mode and the number of compressor stops of each circuit, as well as the total running hours of the pumps.

Screen 18 & 19

CIRCUIT 1/ COMPRESSOR 1

```

_÷          EXTRA READOUT
C11RH:00000hCS:00000
C11C:00000h H:00000h
RHP1:00001hP2:00000h
    
```

CIRCUIT 1/ COMPRESSOR 2

```

_÷          EXTRA READOUT
C21RH:00000hCS:00000
C21C:00000h H:00000h
    
```

These screens are only visible if the unit has 2 circuits.

Screen 20 & 21

CIRCUIT 2/ COMPRESSOR 1

```

_÷          EXTRA READOUT
C12RH:00000hCS:00000
C12C:00000h H:00000h
    
```

CIRCUIT 2/ COMPRESSOR 2

```

_÷          EXTRA READOUT
C22RH:00000hCS:00000
C22C:00000h H:00000h
    
```

Display	Description
CxxRH: CS	RH: Total running hours of this circuit
	CS: Total compressor starts of this circuit
CxxC: H	C: Running hours in cooling mode
	H: Running hours in heating mode
RHP1: 2	RHP1: Running hours of pump 1
	P2: Running hours of pump 2

2.7 Set Points Menu

Screen: password

Depending on the settings in the user settings menu explained further on, you may need the user password to be able to enter the screens in this menu.

This screen will only appear if a password is required.

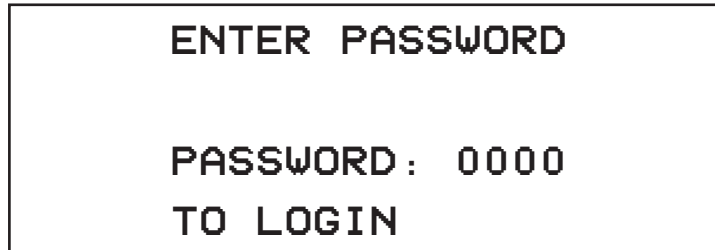

Remark: The units leave the factory with the user password set to "1234". This user password can be modified in the user password menu.

Setpoint Screen

This menu allows you to set the inlet/outlet water temperature of the evaporator/condenser of setpoint 1 and 2. These set points will not be active in the Manual Control Mode.

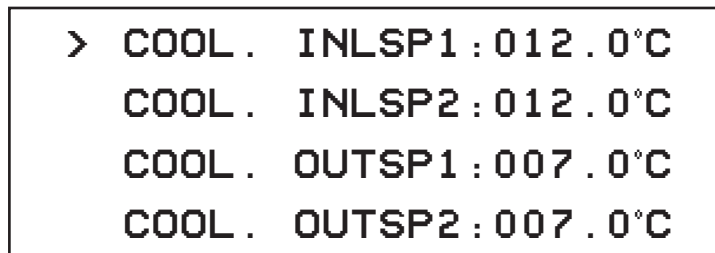

Display	Description
COOL	setpoints in cooling mode
HEAT	setpoints in heating mode
INLSP	inlet water temp. setpoint 1
INLSP	inlet water temp. setpoint 2 (dual setpoint)
OUTSP	outlet water temp. setpoint 1
OUTSP	outlet water temp. setpoint 2 (dual setpoint)

A ">" symbol is displayed in front of the active setpoint in this screen.

Remark: You can select setpoint 1 or 2 with a digital input from a switch. In the service menu you can select which digital input you want to use for this.

2.8 User Settings

User Settings Menu

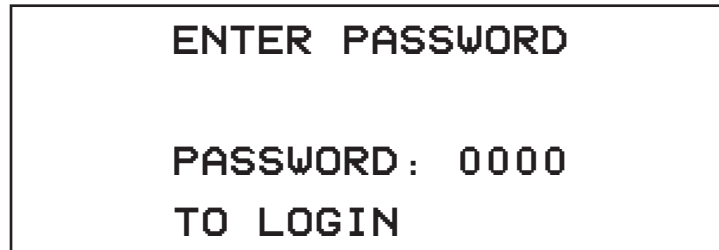

Password

You need the user password to enter this menu.



Remark: The units leave the factory with the user password set to "1234". This user password can be modified in the user password menu.

User Settings Menu

Use the  and  keys to scroll through the menu and press the  key to enter the submenu of your choice.

Topic	See page
2.8.1 Thermostat settings	2-27
2.8.2 Compressor settings	2-28
2.8.3 Fan Settings	2-29
2.8.4 Pump settings	2-31
2.8.5 Floating setpoint	2-32
2.8.6 Language	2-34
2.8.7 Time and Date	2-35
2.8.8 Free cooling	2-35
2.8.9 DICN	2-37
2.8.10 Advanced	2-38
2.8.11 Defrost	2-41
2.8.12 Service Menu	2-42

2.8.1 Thermostat settings

Thermostat

This screen allows modification of the control settings.

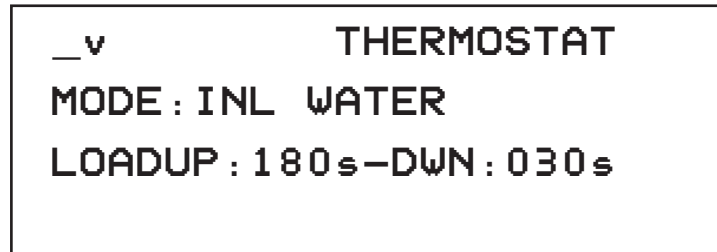

Possible settings MODE:

- INL WATER: inlet water control
- LOAD UP: 180s minimum load up time between 2 compressor starts
- DOWN : 30 s minimum load down time between 2 compressor stops
- OUTL WATER: outlet water control
- LOAD UP: 30s minimum load up time between 2 compressor starts
- DOWN: 15s minimum load down time between 2 compressor stops
- MANUAL CONTROL: manual control (no thermostat control active)

Remark: The load up and load down time changes according to the selected operation mode.

Manual Setting

This screen allows modification of the manual control settings.

This screen is only visible when MANUAL is selected as thermostat mode (see THERMOSTAT screen)

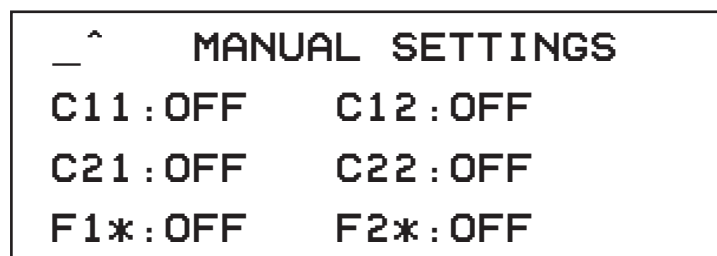

Possible settings C11 / C12 / C21 / C22:

- ON : compressor ON
- OFF : compressor OFF

Possible settings F1*/ F2*:

For standard fans:

OFF : All fans off
L : Low speed
M : Medium speed
H : High speed

Inverter fans (OPIF or OPLN)

000% : percentage of fan output

2.8.2 Compressor settings

Compr. Lead-Lag This screen allows modification of the compressor lead-lag settings:

```

_v      COMPR.LEAD-LAG
MODE: PRIORITY
PRIORITY:
        C11>C12>C21>C22
  
```

Possible settings MODE:

- **PRIORITY:** The user can select the sequence of the compressors to start.
 example:
 C11 > C12 : compressor 1 will start before compressor 2
- **AUTO :** The compressor lead-lag according to the running hours of the compressors

Compr. Cap. Limit This screen allows modification of the compressor capacity limitation settings.

```

^      COMPR.CAP.LIMIT
MODE: LIMIT SETTING
SET:  C11: OFF  C12: OFF
        C21: OFF  C22: OFF
  
```

Possible settings MODE:

- **NOT ACTIVE:** The compressor limitation function is disabled.
- **CHANG. DIG. INP.:** A changeable digital input can be used to enable/disable the compressor capacity limitation.
 - When there is no changeable digital input programmed as “CAP LIMIT SET”, no compressor capacity limits can be entered (not displayed)
 - When there is a changeable digital input programmed as “CAP LIMIT SET”,
 - the compressors can be disabled by selecting OFF.
 - the compressors can be enabled by selecting ON.
- **LIMIT SETTING:** The programmed limitation will be used without the need of an additional programmed DI.
 - the compressors can be disabled by selecting OFF.
 - the compressors can be enabled by selecting ON.

Remark: The compressors that are programmed as OFF will always remain off.

- **LIMIT 50%:** The total capacity of the unit will be limited on 50%

Remark: Lines 3 and 4 of the COMPR. CAP. LIMIT screen will not be displayed.

2.8.3 Fan Settings

Fan Low Noise

This screen allows modification of the fan low noise mode.

This screen is only visible when the option inverter fans (OPIF) or the option low noise (OPLN) has been installed.

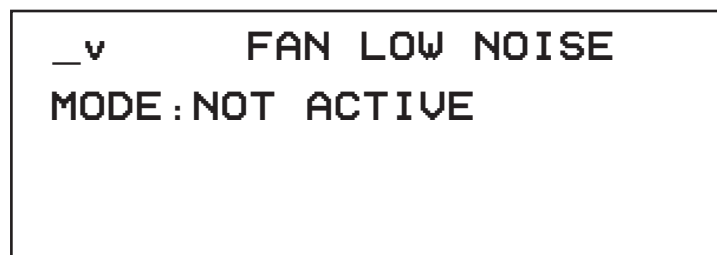

Possible settings MODE:

- **NOT ACTIVE** : fan low noise mode is disabled.
- **ACTIVE** : fan low noise mode is enabled.
- **CHANG.DIG.INP.** : fan low noise mode can be enabled/disabled with a changeable digital input, programmed in the service/fan menu.
- **DAILY SCHEDULE** : fan low noise mode can be enabled/disabled by means of a specified start and stop time.

This screen allows modification of the start and stop time of the fan low noise mode.

This screen is only visible when "DAILY SCHEDULE" is selected as fan low noise mode.

```

_v      FAN LOW NOISE
MODE: DAILY SCHEDULE
START: 20h00
STOP: 06h00

```

Settings:

START : start time of the low noise mode
STOP : stop time of the low noise mode

Fan forced ON

This screen allows modification of the fan forced ON function.

```

_      FAN FORCED ON
IF UNIT IS OFF THEN
ALL FANS: OFF

```

Possible settings :

- **OFF** : If the unit is OFF, then all the fans are OFF.
 - **ON** : If the unit is OFF, then all the fans are ON.
 - **CH. DIG. INP.** : If the unit is OFF, all the fans can be switched on by use of a changeable digital input, programmed in the service/fan menu (Fan Forced ON).
-

2.8.4 Pump settings

Pump Control

This screen allows modification of the pump control.

```

_v          PUMPCONTROL
PUMPLEADTIME      : 020s
PUMPLAGTIME       : 060s
DAILY ON:N        AT:00h00
  
```

Settings:

- PUMPLEADTIME** : Time the water pump will operate before starting up the chiller
- PUMPLAGTIME** : Time the water pump will keep running after stopping the chiller
- DAILY ON** : N: function disabled
: Y: activation of daily pump start
- AT** : Time of the daily ON function

Dual Pump

This screen allows modification of the dual pump control.

```

^          DUAL PUMP
MODE:AUTO ROTATION
OFFSET ON RH    : 048h
  
```

Possible settings MODE:

- **AUTO ROTATION** : the sequence of the pump start is done based on the running hours
- **PUMP1 > PUMP2** : pump 1 will always start first
- **PUMP2 > PUMP1** : pump 2 will always start first
- **OFFSET ON RH** : offset in running hours between pump1 and pump2 (only when auto-rotation is selected)

2.8.5 Floating setpoint

Floating Setpoint

This screen allows modification of the floating setpoint function. Different floating setpoint modes will give different screens.

— FLOATING SETPOINT
MODE: NOT ACTIVE

Possible modes :

- AMBIENT
- CH. AI SLOPE NTC
- CH. AI SLOPE V-A
- CH. AI MAX VALUE
- NOT ACTIVE

Floating Setpoint Ambient

This screen allows modification of the floating setpoint based on ambient temperature.

— FLOATING SETPOINT
MODE: AMBIENT
MAXPOS: 03.0°C NEG: 00.0°C
RF: 020.0°C SLOPE: 006.0°C

Settings:

MODE	:	Ambient, floating setpoint function based on ambient temperature
MAXPOS	:	Maximum value of positive floating setpoint correction
NEG	:	Maximum value of negative floating setpoint correction
RF	:	Reference value. At this ambient temperature there is no correction of the setpoint.
SLOPE	:	This parameter is necessary to draw the angle of the curve.

**Floating Setpoint
CH. AI . SLOPE NTC**

This screen allows modification of the floating setpoint, based on an additional NTC sensor, connected to an analogue input.

```

_          FLOATING SETPOINT
MODE:CH.AI SLOPE NTC
MAXPOS:03.0°C NEG:03.0°C
RF:020.0°C SLOPE:006.0°C
    
```

Settings:

- MODE** : Changeable analogue input slope NTC, floating setpoint based on an additional NTC sensor
- MAXPOS** : Maximum value of positive floating setpoint correction
- NEG** : Maximum value of negative floating setpoint correction
- RF** : Reference value. At this ambient temperature there is no correction of the setpoint.
- SLOPE** : This parameter is necessary to draw the angle of the curve.

Remark: When mode “CH. AI SLOPE NTC” is selected, a changeable analogue input needs to be programmed in the service/input output menu.

**Floating Setpoint
CH. AI . SLOPE V-A**

This screen allows modification of the floating setpoint based on an external voltage or current signal.

```

_          FLOATING SETPOINT
MODE:CH.AI SLOPE V-A
MAXPOS:03.0°C NEG:03.0°C
RF:020.0°C SLOPE:012.0°C
    
```

Settings:

- MODE** : Changeable analogue input slope V-A, floating setpoint based on an external voltage or current signal
- MAXPOS** : Maximum value of positive floating setpoint correction
- NEG** : Maximum value of negative floating setpoint correction
- RF** : Reference value. At this percentage of the input signal there is no correction of the setpoint.
- SLOPE** : This parameter is necessary to draw the angle of the curve.

Remark: When mode “CH. AI SLOPE V-A” is selected, a changeable analogue input needs to be programmed in the service/input output menu.

Floating Setpoint CH AI MAX VALUE

This screen allows modification of the floating setpoint based on an external voltage or current signal.

```

—          FLOATING SETPOINT
MODE: CH. AI MAX VALUE
MAXIMUM VALUE: 003.0°C
  
```

Settings:

- MODE** : Changeable analogue input maximum value, floating setpoint based on an external voltage or current signal
- MAXIMUM VALUE** : Maximum value of floating setpoint correction, value can be positive or negative

Remark: When mode “CH. AI MAX VALUE” is selected, a changeable analogue input needs to be programmed in the service/input output menu.

2.8.6 Language

Language

This screen allows modification of the language.

```

—          LANGUAGE
PRESS ENTER TO
CHANGE LANGUAGE :
ENGLISH
  
```

When entering this menu, just press ENTER to change the language. This is a loop function: when reaching the last selectable language you are sent back to the first.

2.8.7 Time and Date

Time and Date

This screen allows modification of the time and date.

```

—          TIME AND DATE
TIME: 22h35
DATE FORMAT: DD/MM/YY
DATE: WED   24/01/07
  
```

Settings:

- TIME** : To set the actual time
- DATE FORMAT** : To select date format
- DD/MM/YY
 - YY/MM/DD
- DATE** : To set the actual date

2.8.8 Free cooling

Free Cooling

This screen allows modification of the free cooling function. The different free cooling modes will give different screens.

```

—          FREE COOLING
MODE: NOT ACTIVE
  
```

Settings:

- AMBIENT
- INLET- AMBIENT
- CHANG. DIG. INP.
- NOT ACTIVE

Free Cooling Ambient

This screen allows modification of the free cooling based on ambient temperature.

```

—                FREE COOLING
MODE : AMBIENT
SP : 05.0°C    DIF : 01.0°C
PUMP : ON      LEAD : 000s
  
```

Settings:

MODE	:	AMBIENT, free cooling based on ambient temperature
SP	:	Define setpoint of free cooling
DIF	:	Setting of the free cooling difference
PUMP	:	Define if pump is ON/ OFF during free cooling operation
LEAD	:	Lead time of the evaporator water pump

Free Cooling Inlet-Ambient

This screen allows modification of the free cooling, based on the difference between inlet water temperature and ambient temperature.

```

—                FREE COOLING
MODE : INLET-AMBIENT
SP : 05.0°C    DIF : 050.0°C
  
```

Settings:

MODE	:	INLET-AMBIENT, free cooling based on the difference between inlet water temperature and ambient temperature
SP	:	Define setpoint of the free cooling
DIF	:	Setting of the free cooling difference

Remark: During free cooling, based on inlet-ambient, the pump contact is always closed.

**Free Cooling
Chang. Dig. Inp.**

This screen allows modification of the free cooling based on a digital input signal.

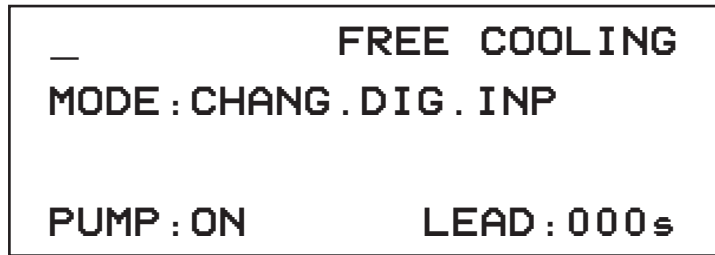

Settings:

- MODE** : CHANG.DIG.INP., free cooling based on a changeable digital input signal (example from an external thermostat)
- PUMP** : Define if pump is ON/OFF during free cooling operation
- LEAD** : Lead time of the evaporator water pump

2.8.9 DICN

DICN

This screen allows modifications of the DICN function.

This menu can only be entered when MS is selected in the service/DICN menu.

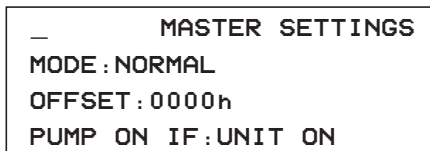

OR

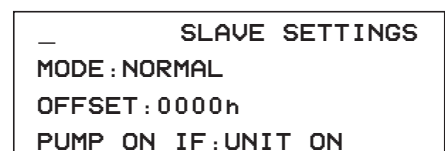

Settings:

MODE (Parameter can be set on each unit)

<ul style="list-style-type: none"> ■ NORMAL: 	Unit is part of the DICN setup
<ul style="list-style-type: none"> ■ STANDBY: 	<ul style="list-style-type: none"> ■ A unit with mode “STANDBY” will only be able to loadup if: <ul style="list-style-type: none"> -a safety is present on a unit in the DICN setup. OR -all other units are on 100% capacity (possible to disable). ■ In case more than 1 unit has “STANDBY” setting, the actual standby will be calculated (based on running hours). <p>Remark: all units can be put on “STANDBY”, in which case the DICN will calculate which unit will be the actual standby.</p>
<ul style="list-style-type: none"> ■ DISCONN. ON/OFF 	A unit with mode “DISCONNECT ON/OFF” can be put on/off independently from the DICN on/off status (setpoint & other network parameters are still controlled on DICN level) and unit can be put in manual mode.

OFFSET : The offset time defines the target difference in running hours between one unit and another unit.

PUMP ON IF :

- UNIT IS ON: pump of individual unit will run if unit is on
- COMPR ON: pump of individual unit will only run if the compressor of that unit is on

2.8.10 Advanced

Advanced

This screen allows modification of the advanced password settings.

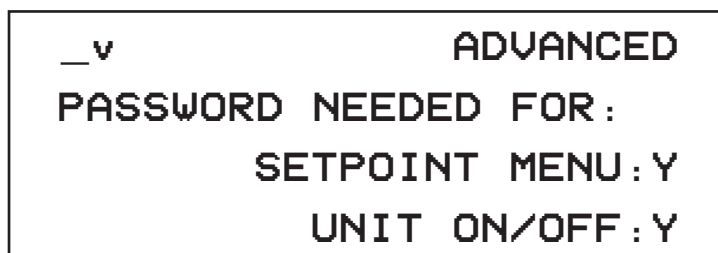

Settings:

PASSWORD NEEDED FOR:

- SETPOINT MENU** : Y: User password is needed to enter the setpoint menu
N: no password is needed to enter the setpoint menu
- UNIT ON/ OFF** : Y: user password is needed to switch the unit ON or OFF
N: no password is needed to switch the unit ON or OFF

When a password is needed to switch the unit ON or OFF, the following screen will be displayed while pushing the ON/OFF button.

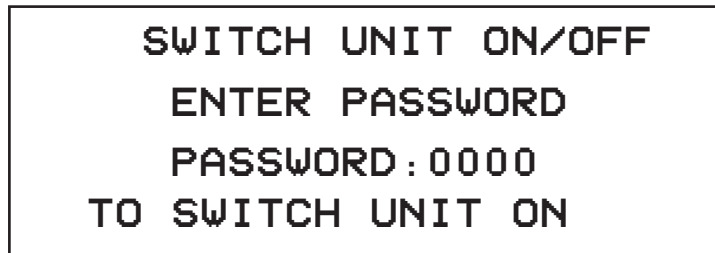

When the password is entered, the unit will switch ON/ OFF.

This screen allows modification of the advanced main menu, logout timer and buzzer settings.

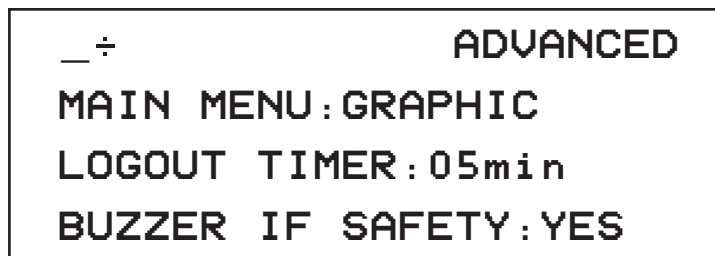

Settings:

- MAIN MENU** : set to GRAPHIC to let the main menu show the graphical symbols or to TEXT to let the main menu show the names of the menus.

Main menu Graphic →

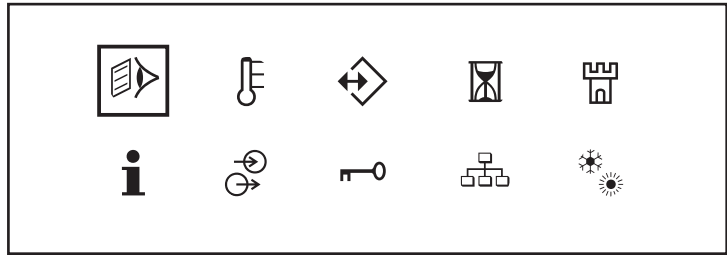

Main menu Text→

> READOUT MENU
 SETPOINTS MENU
 USERSETTINGS MENU
 TIMERS MENU
 HISTORY MENU
 INFO MENU
 I/O STATUS MENU
 LOGIN/LOGOUT MENU
 NETWORK MENU
 COOL/HEAT MENU

- **LOGOUT TIMER** : Set the time for automatic log out, between 01 and 30 minutes.
- **BUZZER IF SAFETY** : To activate or deactivate the buzzer sound when an error occurs.

This screen allows modification of the advanced backlight and graphic readout settings.

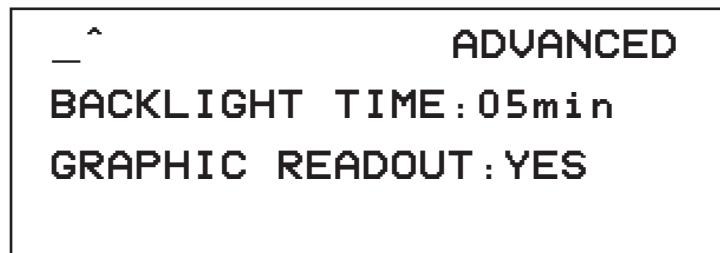

Settings:

- BACKLIGHT TIME** : to define the time (between 01 and 30 minutes) the light of the controller display will stay on after the last manipulation of the controller buttons.
- GRAPHIC READOUT** : to define if the graphical representation of the first screen of the read out menu is present or not.

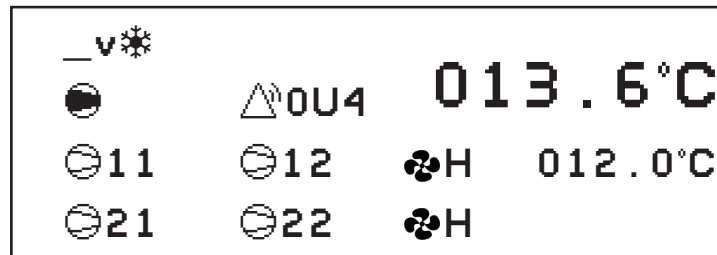

2.8.11 Defrost

Manual Defrost

This screen allows activation of a manual defrost.

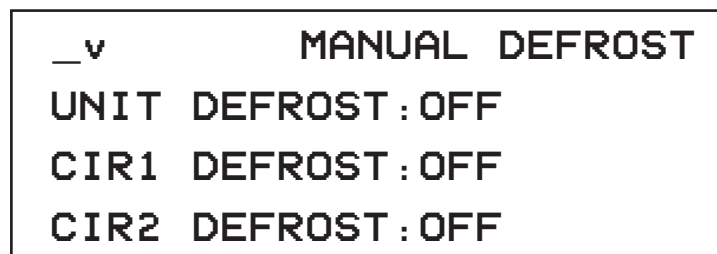

Settings:

- UNIT/CIR1/CIR2 DEFROST** : OFF: No manual defrost is requested
ON : manual defrost is requested and busy
- Unit defrost** : Both circuits will execute a defrost cycle, due to one circuit defrost control, the 2nd circuit defrost will only start after the defrost finish of the 1st circuit.
- Circuit defrost** : Only this circuit will execute a defrost cycle.

Remark: If manual defrost is chosen (for 1 circuit/2 circuits)

- If condition of defrost is satisfied → start defrost AND → indicate ON for manual defrost
- If condition of defrost is not satisfied → return to OFF indication and ignore manual defrost order

Defrost Timer

This screen allows modification of the minimum time between 2 defrost cycles of the same circuit.

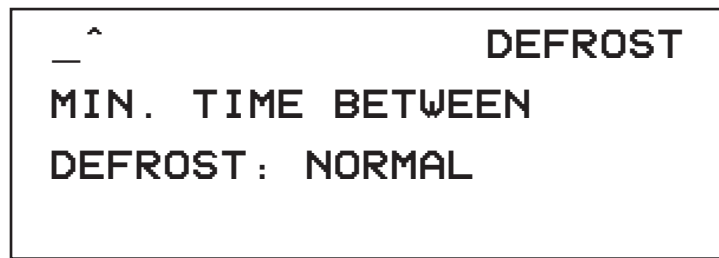

MIN. TIME BETWEEN DEFROST : Minimum time between 2 defrost cycles of the same circuit in order to keep heating capacity and prevent frequent defrosting.

Settings:

NORMAL : Normal start value, default 30 min, (range 20~120 min)
SHORT : Short start value, default 10min, (range 1~20min)

2.8.12 Service Menu**Operational information**

The service menu is accessible through the last screen of the user settings menu. To enter the service menu you need the service password. Please contact your distributor for this password. It is only possible to access the service menu when the unit is "OFF". Only a qualified engineer is allowed to access this menu.

You need the password to access this menu.

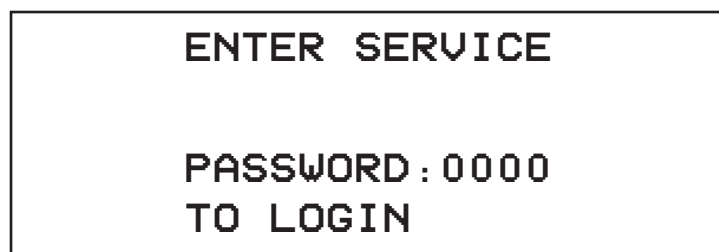

2.9 Timers menu

Software Timers Using this menu, the actual software timers can be read out. This menu displays three screens.

General Timers This screen shows the actual value of the general timers:

```

_v          GENERAL TIMERS
LOADUP : 000s-DWN : 000s
PUMPLEAD      : 000s
FLOWSTOP      : 00s
    
```

Display	Description
LOADUP	<ul style="list-style-type: none"> ■ LOADUP: starts counting when a thermostat step change has occurred. During the countdown, the unit is not able to go to a higher thermostat step.
DWN	<ul style="list-style-type: none"> ■ LOADDOWN: starts counting when a thermostat step change has occurred. During the countdown, the unit is not able to go to a lower thermostat step.
PUMPLEAD	<ul style="list-style-type: none"> ■ FLOWSTART-20sec: counts down when the water flow through the evaporator is continuous and the unit is in standby. During the countdown, the unit cannot start up.
PUMPLAG	<ul style="list-style-type: none"> ■ Counts down after the unit is switched off. During the pump lag time (60s) the pump will keep running after the chiller has stopped. (appears when PUMPLEAD TIME = 0)
FLOWSTOP	<ul style="list-style-type: none"> ■ FLOWSTOP-5 sec: starts counting when the water flow through the evaporator stops after the flowstart timer has reached zero. If the water flow has not restarted during the countdown, the unit will shut down.

Compressor Timers These screens show the actual value of the compressor timers.

```

_÷          COMPRESSOR TIMERS
GRD11 : 000s  12 : 000s
AREC11 : 000s  12 : 000s
M.RT11 : 000s  12 : 000s
    
```

```

_^          COMPRESSOR TIMERS
GRD21 : 000s  22 : 000s
AREC21 : 000s  22 : 000s
M.RT21 : 000s  22 : 000s
    
```

Display	Description
GRD 11/12/21/22	■ GUARDTIMER (180 sec): starts counting when the compressor (circuit 1/2) has been shut down. During the countdown, the compressor cannot be restarted.
AREC 11/12/21/22	■ ANTIRECYCLING (300 sec): starts counting when the compressor (circuit1/2) has started. During the countdown, the compressor cannot be restarted.
M.RT 11/12/21/22	■ MINIMUM RUNNING TIME (120 sec) : starts counting when the compressor has started. During the countdown, the compressor will not be switched off by the thermostat function.

2.10 Info menu

Introduction

Using this menu, the additional information about the unit can be consulted.

Time info

This screen shows the actual time and date.

```

_v                TIME INFO
TIME: 22h05
DATE: WED        24/01/07
    
```

Display	Description
TIME	Actual time
DATE	Actual day and date

Unit info

This screen shows the unit type.

```

_÷                UNIT INFO
UNIT:AW-RH-250 C:SCL
CIR:2 EVAP:1 COILC:2
EEV:P REF:R410A
    
```

Display	Description
UNITTYPE: XX-XX-XX	The first two letters tell that the unit is air cooled, the following two give the type of unit and the number indicates the capacity power of the unit.
C:	Indicates the type of the compressor. SCL : scroll
CIRC: EVAP: COILC:	Indicates the quantity of circuits, the evaporators and whether 1 or 2 coils are present per circuit.
EEV	Indicates the type of electronic expansion valve. P : PCASO EEV
REFRIGERANT: XXXX	Refrigerant type : R410 a

Remark: unit type explanation:

AW : Air-water cooled
CO : Cooling only
RH : Heat pump (refrigerant)

Unit info

This screen shows the unit type and options.

```

_ ÷                UNIT INFO
FAN: ST VA:Y    2PUMP:Y
HEATERTAPE:Y
FAN DO ST:2 DO    INV:2
  
```

Display	Description
FAN	Indicates the type of the fans: ST : ON/OFF fans INV : ON/OFF fans and inverter fans (OPIF or OPLN)
VA	Indicates if the Volt-Ampere option is present on the unit.
2PUMP	Indicates if the option dual pump is present on the unit
FAN DO ST	Indicates the digital outputs for the ON/OFF (standard) fans.
DO INV	Indicates the digital outputs for the inverter fans.

Software Info

This screen shows the software version.

```

_ ^                SW INFO
MAIN:SP1710C117 V2.3
EXT.:SP1559A019
REM.:SP1734C046
  
```

Display	Description
V2.3	Software version 2.3
MAIN	Software file for main PCB
EXT.	Software file for extension PCB
REM.	Software file for remote controller PCB

2.11 Input/Output Status Menu

Introduction

Using this menu you can read the status of the digital inputs and the status of the relay outputs.

Digital Inputs

This screen shows the status of the emergency stop and the flow switch.

```

_v      DIGITAL INPUTS
EMERGENCY STOP :OK
FLOWSWITCH:FLOW OK
  
```

Display	Description
EMERGENCY STOP	Status of emergency stop
FLOWSWITCH	Status of flow switch

Digital Inputs

This screen shows the status of the heater tape, pump interlock and pump.

```

÷      DIG. INP/OUTPUTS
HEATER TAPE :OFF
PUMPINTERLOCK :CLOSED
PUMP :ON
  
```

Display	Description
HEATER TAPE	Status of the heater tape (if present)
PUMPINTERLOCK	Status of the pumpinterlock
PUMP	Status of the pump

Digital Inputs

This screen shows the status of the reverse phase protection, high pressure switch and overcurrent relay of the compressors in circuit 1.

```

_ ÷      DIGITAL INPUTS
C1 REV.PH.PROT. :OK
C1  HIGH PR.SW. :OK
INT.L C11:OK C12:OK
    
```

Display	Description
C1 REV. PH. PROT.	Status of the reverse phase protection of circuit 1
C1 HIGH PR. SW.	Status of the high pressure switch of circuit 1
INT. L. C11: C12	Status of the compressor interlock of compressors 1 and 2 of circuit 1

Digital Inputs

This screen shows the status of the fan overcurrent of each fanstep of circuit 1.

```

_ ÷      DIGITAL INPUTS
C1 FAN OVERC.ST1:OK
C1 FAN OVERC.ST2:OK
C1 FAN OVERC.ST3:NOK
    
```

Display	Description
C1 FAN OVERC. ST1	Status of fan overcurrent of fanstep 1 of circuit 1
C1 FAN OVERC. ST2	Status of fan overcurrent of fanstep 2 of circuit 1
C1 FAN OVERC. ST3	Status of fan overcurrent of fanstep 3 of circuit 1

Remark: When the unit has standard ON/OFF fans, 3 fan steps are present. When the unit has inverter and ON/OFF fans, only fan step 1 or 1 and 3 are present (depending on unit size).

Digital Inputs

This screen shows the status of the reverse phase protection, high pressure switch and overcurrent relay of the compressors in circuit 2.

```

_ ÷      DIGITAL INPUTS
C2 REV.PH.PROT. :OK
C2  HIGH PR.SW. :OK
INT.L C21:OK  C22:OK
  
```

Display	Description
C2 REV.PH. PROT.	Status of the reverse phase protection of circuit 2
C2 HIGH PR. SW.	Status of the high pressure switch of circuit 2
INT. L C21: C22:	Status of the compressor interlock of compressors 1 and 2 of circuit 2

Digital inputs

This screen shows the status of the fan overcurrent of each fanstep of circuit 2.

```

_ ÷      DIGITAL INPUTS
C2 FAN OVERC.ST1:OK
C2 FAN OVERC.ST2:OK
C2 FAN OVERC.ST3:NOK
  
```

Display	Description
C1 FAN OVERC. ST1	Status of fan overcurrent of fanstep 1 of circuit 2
C1 FAN OVERC. ST2	Status of fan overcurrent of fanstep 2 of circuit 2
C1 FAN OVERC. ST3	Status of fan overcurrent of fanstep 3 of circuit 2

Remark: When the unit has standard ON/OFF fans, 3 fan steps are present. When the unit has Inverter and ON/OFF fans, only fan steps 1 or 1 and 3 are present (depending on unit size).

Compressor Outputs

This screen shows the status of the compressor outputs.

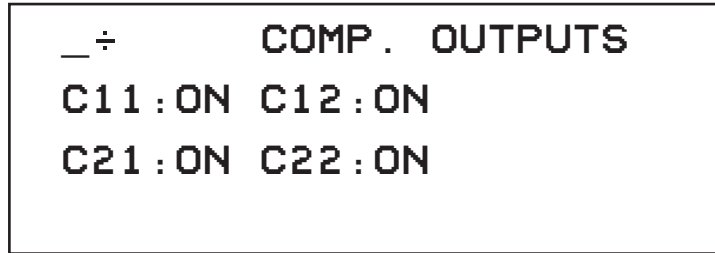

Display	Description
C11	Compressor 1 status of circuit 1
C12	Compressor 2 status of circuit 1
C21	Compressor 1 status of circuit 2
C22	Compressor 2 status of circuit 2

Fan Inputs/Outputs

This screen shows the status of the relay outputs of the fans from circuit 1.

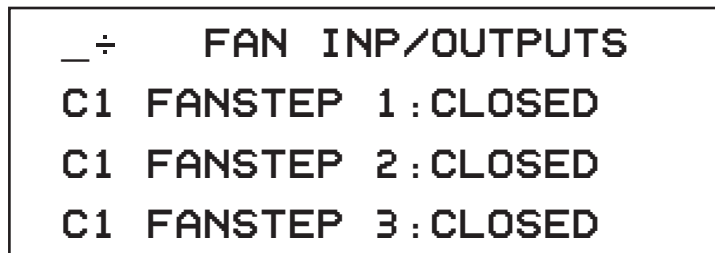

Display	Description
C1 FANSTEP 1	Indicates the status of the fan contactor of circuit 1
C1 FANSTEP 2	Indicates the status of the fan contactor of circuit 1
C1 FANSTEP 3	Indicates the status of the fan contactor of circuit 1

Remark: When the unit has standard ON/OFF fans, 3 fan steps are present. When the unit has inverter and ON/OFF fans, only fan steps 1 or 1 and 3 are present (depending on unit size).

Fan Input/Outputs

This screen shows the status of the relay outputs of the fans from circuit 2.

```

_ ÷ FAN INP/OUTPUTS
C2 FANSTEP 1 : CLOSED
C2 FANSTEP 2 : CLOSED
C2 FANSTEP 3 : CLOSED

```

Display	Description
C2 FANSTEP 1	Indicates the status of the fan contactor of circuit 2
C2 FANSTEP 2	Indicates the status of the fan contactor of circuit 2
C2 FANSTEP 3	Indicates the status of the fan contactor of circuit 2

Remark: When the unit has standard ON/OFF fans, 3 fan steps are present. When the unit has inverter and ON/OFF fans, only fan steps 1 or 1 and 3 are present (depending on unit size).

Changeable Digital Inputs

This screen shows the status of the digital inputs.

```

_ ÷ CHANG. DIG. INPUTS
DI1 NONE
DI2 NONE
DI3 NONE

```

Display	Description
DI1	Changeable digital input 1 + status of input
DI2	Changeable digital input 2 + status of input
DI3	Changeable digital input 3 + status of input

Changeable Digital Inputs/Outputs

This screen shows the status of the digital inputs and outputs.

```

    _ ÷ CHANG.  DIG.  INPUTS
    DI4  NONE
    DO1  SAFETY+W. (NO)   : 0
    DO2  GEN. OPERATION   : 0
    
```

Display	Description
DI4	Changeable digital input 4 + status of input
DO1	Changeable digital output 1 + status of output
DO2	Changeable digital output 2 + status of output

Changeable Digital Outputs

This screen shows the status of the digital outputs.

```

    _ ÷ CHANG.  INP/OUTPUTS
    DO3  NONE  (OPEN)
    DO4  NONE  (OPEN)
    DO5  NONE  (OPEN)
    
```

Display	Description
DO3	Changeable digital output 3 + status of output
DO4	Changeable digital output 4 + status of output
DO5	Changeable digital output 5 + status of output

Changeable Digital Outputs

This screen shows the status of the digital output and analogue input.

```

_ ÷ CHANG .   INP/OUTPUTS
DO6 NONE (OPEN)
AI1 NONE
AI2 NONE
  
```

Display	Description
DO6	Changeable digital output 6 + status of output
AI1	Changeable analogue input 1 + value of input
AI2	Changeable analogue input 2 + value of input

Changeable Analogue Inputs

This screen shows the status of the analogue inputs and outputs.

```

_ ÷ CHANG .   INP/OUTPUTS
AI3 NONE
AI4 NONE
AO1 NONE
  
```

Display	Description
AI3	Changeable analogue input 3 + value of input
AI4	Changeable analogue input 4 + value of input
AO1	Changeable analogue output 1 + value of output

Communication

This screen shows the status of the communication lines.

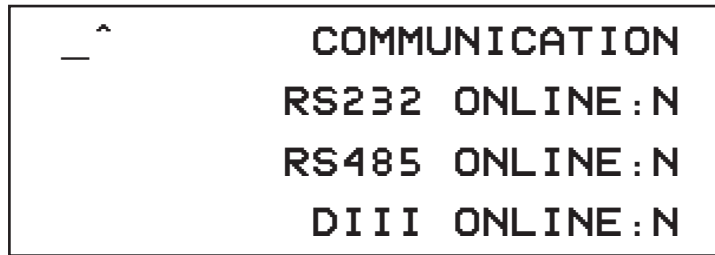

Display	Description
RS232 ONLINE	Indicates if the RS232 communication line is active.
RS485 ONLINE	Indicates if the RS485 communication line is active.
DIII ONLINE	Indicates if the DIII communication line is active.

2.12 User Password Menu

Password

The user password is used to protect access to :

- the user settings menu
- the set points menu (if selected in the USER/ADVANCED menu)
- the user password menu

The password is a 4-digit number between "0000" and "9999".

The units leave the factory with user password "1234". The service password overrides the user password (in case you don't know or have forgotten the user password).

Enter Password

In this screen the USER or SERVICE password must be entered to access the user password menu.

Use the  and  keys to select the password.

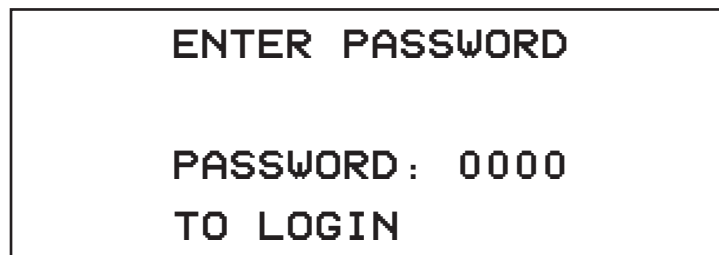



Log in/ Log out

In this screen the user can log out of the controller.

When a password is entered to enter a menu, the user is logged on at this password level for a specified time (USER/ADVANCED menu). When the controller is not touched for "LOGOUT" time, the controller will automatically log out. A password is needed again to access the menus.



Display	Description
LOGINSTATUS :	Indication of password level. USER: User is logged in with user password SERVICE: User is logged in with service password
LOGOUT	Select to log out of the controller. NO: Remain logged on with the current password level.
	YES: Log out of the controller. The password will be requested again to enter a menu.

In this screen you can change the password. Use the  and  keys to select the new password.

```

_ ^ LOGIN/LOGOUT MENU
      CHANGE PASSWORD
NEW PASSWORD: 0000
CONFIRM: 0000
    
```

Display	Description
NEW PASSWORD :	To set a new password
CONFIRM :	To confirm the new password

2.13 Network Menu

The network menu is only accessible when MS OPTION is set to "YES" in the SERVICE/DICN menu.

Network

This screen shows the temperatures of the network (DICN) system.

```

_v                NETWORK
COOL .  INLSP1 : 012.0°C
INLET WATER : 013.6°C
    
```

Display	Description
COOL	Cooling operation is selected.
HEAT	Heating operation is selected.
INLSP1/ INLSP2	Gives the setpoint you selected to use (dual setpoint if selected) INLSP1 : inlet water setpoint 1 INLSP2 : inlet water setpoint 2 (dual setpoint)
INLET WATER	Inlet temperature of the inlet water on the master unit

Network Overview

This screen shows the status and capacity of all the units in the DICN network.

```

^M : NORMAL      CAP : 000%
SL1 : NORMAL     CAP : 000%
SL2 : NORMAL     CAP : 000%
SL3 : NORMAL     CAP : 000%
    
```

Display	Description	Possible settings
"M:	Displays status of Master (as selected in USER/DICN settings menu)	NORMAL/STANDBY/DISCONN/SAFETY
CAP: %	Displays the capacity of the master	
SL1:	Displays status of the slave (as selected in USER/DICN settings menu)	NORMAL/STANDBY/DISCONN/SAFETY
CAP: %	Displays the capacity of the slave 1	
SL2:	Displays status of the slave (as selected in USER/DICN settings menu)	NORMAL/STANDBY/DISCONN/SAFETY
CAP: %	Displays the capacity of the slave 2	
SL3:	Displays status of the slave (as selected in USER/DICN settings menu)	NORMAL/STANDBY/DISCONN/SAFETY
CAP: %	Displays the capacity of the slave 3	

2.14 Cool / Heat Menu

Password

You need the user password to enter this menu.



ENTER PASSWORD

PASSWORD: 0000

TO LOGIN

Cooling/ Heating

This screen allows you to choose between cooling and heating.

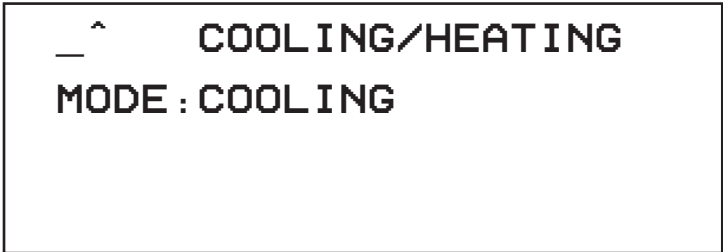

_ ^ COOLING/HEATING
MODE : COOLING

Possible Mode:

Cooling mode: Thermostat function on evaporator

Heating mode: Thermostat function on condenser

2.15 Service Menu

Operational Information

The service menu is accessible through the last screen of the user settings menu. To enter the service menu you need the service password. Please contact your distributor for this password. It is only possible to access the service menu when the unit is "OFF".

Password

You need the password to enter this menu.

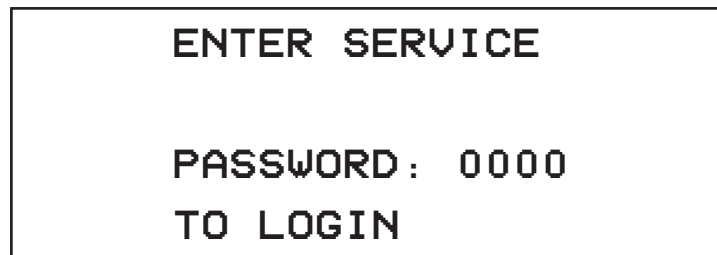

Remark: When the unit is operating, it is not possible to enter the service menu.

Service Setting Menu

Use the and keys to scroll through the menu and press the key to enter the submenu of your choice.

Topic	See page
2.15.1 Thermostat	2-62
2.15.2 Compressor	2-63
2.15.3 Fan	2-65
2.15.4 Pump	2-68
2.15.5 EEV	2-69
2.15.6 Input Output	2-78
2.15.7 Communication	2-85
2.15.8 DICN	2-88
2.15.9 Safety	2-90
2.15.10 History	2-97
2.15.11 Advanced	2-97
2.15.12 Defrost	2-99

2.15.1 Thermostat

Thermostat settings for V2.1

This screen allows modification of the thermostat settings for software version V2.1.

— THERMOSTAT

STEPLENGTH

A : 04 . 0°C C : 00 . 4°C

RESTART COND . : A x 2

Settings:

- A** : Step difference value, used for the thermostat function
- C** : Step length value, used for the thermostat function
- RESTART COND** : Restart condition parameter, used to restart the unit after a forced thermo off in outlet mode.

Possible settings:

- A x 1
- A x 2
- A x 3
- A x 4

Remark: The restart condition parameter A in this function is the same as the programmed step difference value A.

Thermostat settings for V2.2 or higher

This screen allows modification of the thermostat settings for software version V2.2.

— THERMOSTAT

STEPLENGTH

A : 04 . 0°C C : 00 . 4°C

RESTART COND . : 4 . 0°C x 2

Settings:

- A** : Step difference value, used for the thermostat function
- C** : Step length value, used for the thermostat function
- RESTART COND** : Restart condition parameter (default 4°C), used to restart the unit after a normal thermo off in outlet mode.

Restart condition value x 2: Restart condition parameter (default 2), used to restart the unit after a forced thermo off in outlet mode.

Possible settings:

Restart condition value x 1

Restart condition value x 2

Restart condition value x 3

Restart condition value x 4

2.15.2 Compressor

Compressor Start

This screen allows modification of the fan on lag time.



Setting:

FAN ON LAG TIME : Time delay between switching unit/fans ON and compressor start

These screens allow modification of the total compressor running hours, cool/heat running hours and compressor starts.

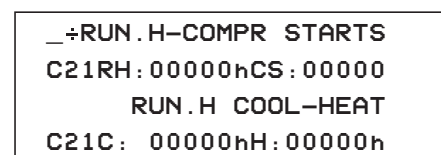
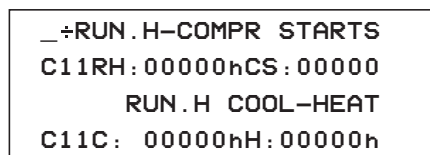

These screens are only visible if the unit has 2 circuits.

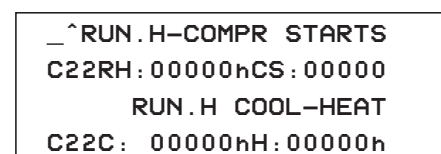
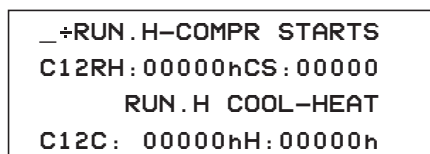

Settings:

RUN. H-COMPR. STARTS	:	Title, running hours and compressor starts
CxxRH	:	Define or change total running hours of this compressor
CS	:	Define or change total compressor starts of this compressor
RUN. H COOL-HEAT	:	Title, running hours in cooling and heating mode
CxxC	:	Define or change running hours in cooling mode of this compressor
H	:	Define or change running hours in heating mode of this compressor

- Remark:**
- These parameters need to be entered (changed) when replacing a PCB or compressor.
 - Running hours COOL/HEAT are only visible with EWYQ units.
-

2.15.3 Fan

Fan Control Ambient

This screen allows modification of the ambient fan control used during the startup of the chiller.

```

_v          FAN CONTROL
AMBIENT TIMER : 070s
AMBIENT SETP A : 15.0°C
AMBIENT SETP B : 05.0°C
    
```

Settings:

- AMBIENT TIMER** : Time when the fan control based on ambient temperature is used at the startup of a circuit
- AMBIENT SETP A** : Setpoint for high fan speed used in ambient fan control
- AMBIENT SETP B** : Setpoint for medium fan speed used in ambient fan control

Fan Control

This screen allows modification of the fan high pressure setpoints.

```

_v          FAN CONTROL
FANST .    A : 18.9b/28.0b
FANST .    B1 : 32.4b
FANST .    B2 : 27.5b/35.0b
    
```

Settings:

- FANST. A** : High pressure setpoint for fan control
 - First value: setpoint used for standard ON/OFF fans and units with inverter fans
 - Second value: setpoint used for inverter fans working in LOW NOISE mode
- FANST. B1** : High pressure setpoint for fan control with standard ON/OFF fans
- FANST B2** : High pressure setpoint for fan control
 - First value: setpoint used for standard ON/OFF fans and units with inverter fans
 - Second value: setpoint used for inverter fans working in LOW NOISE mode

Fan Control

This screen allows modification of the fan high pressure setpoints.

— ^ **FAN CONTROL**

FANST. B3 : 35.0b/37.0b

UNLOAD CONST : 02.6b

COMPAR. PRESSURE : 01.9b

Settings:

- FANST. B3** : High pressure setpoint for fan control
- First value: setpoint used for standard ON/OFF fans and units with inverter fans
- Second value: setpoint used for inverter fans working in LOW NOISE mode
- UNLOAD CONST** : Parameter used to calculate the high pressure fan switching point if 1 compressor of this circuit is in operation.
- COMPAR. PRESSURE** : Parameter to specify extra condition for fan up/down.

Fan Control Anti-hunting

This screen allows modification of the anti-hunting timer and reset conditions.

— ÷ **FAN CONTROL**

HUNTING PR TIM : 0720s

RESET CONDTEMP : 02.0°C

RESET CONDAMB. : 03.0°C

Settings:

- HUNTING PR TIME** : When a fanstep changes with ± 1 fanstep and it becomes the same fanstep within HUNTING PR TIME, then the anti-hunting function will be enabled.
- ON/OFF fans: 720s
- Inv. fans: 240s
- RESET CONDITION TEMP** : When outlet water temp. rises with 2°C, the anti-hunting function will be reset.
- RESET CONDITION AMBIENT** : When the ambient temp. rises with 3°C, the anti-hunting function will be reset.

Fan Control Timers This screen allows modification of the fan timers.

```

    _ ^          FAN CONTROL
    COMPRESSION RATIO: 1.6
    LOADUP TIM: 0015s
    LOADDOWN TIM: 0090s
    
```

Settings:

- COMPRESSION RATIO** : Used for pressure difference surveillance control
- LOADUP TIM** : Load up time, minimum time between 2 fan up steps
- LOADDOWN TIM** : Load down time, minimum time between 2 fan down steps

Remark: Different default timers are used for ON/OFF and inverter fans

- LOADUP TIME** : ON/OFF fans: 90s
Inv. fans: 15s
- LOADDOWN TIME** : ON/OFF fans: 180s
Inv. fans: 90s

Fan inverter Frequency This screen allows modification of the fan inverter frequency for each fan step.

```

          FAN INV FREQ
    ST4 : 50HZ      ST3 : 45HZ
    ST2 : 30HZ      ST1 : 20HZ
    
```

Settings:

- ST1** : Frequency used for inverter fan step 1
- ST2** : Frequency used for inverter fan step 2
- ST3** : Frequency used for inverter fan step 3
- ST4** : Frequency used for inverter fan step 4

2.15.4 Pump

Pump Control

This screen allows modification of the manual pump control and the pump running hours.

```

—          PUMPCONTROL
MAN . PUMP : OFF  2ND : OFF
RUNN .  HOURS
RHP1 : 00000hP2 : 00000h
  
```

Settings:

- MAN. PUMP** : Manual switching on pump 1 or 2
- RUNN. HOURS RHP1/
P2** : Running hours of pump 1 and pump 2. When the software is updated or the PCB is replaced, these running hours have to be entered in the new configuration.

Remark: When the manual pump control is activated, the pump will switch OFF (disable manual control) when you leave the Service menu.

Pump Control with low water temperature

This screen allows modification of the pump control with low water temperatures when unit is switched off.

```

—          PUMPCONTROL
IF UNIT OFF AND LOW
WATER TEMP THEN PUMP
: OFF
  
```

Settings:

- OFF** : Pump function is disabled (default setting)
- ON** : Pump function is enabled.

Remark: This screen is only visible when no heater tape is installed.

2.15.5 EEV

This menu allows modification of the EEV settings. The EEV parameter values used in the following screens are not the same for all units. Each unit has his own parameters and should not be changed.

EEV Control

This screen allows modification of the EEV additional screen setting.

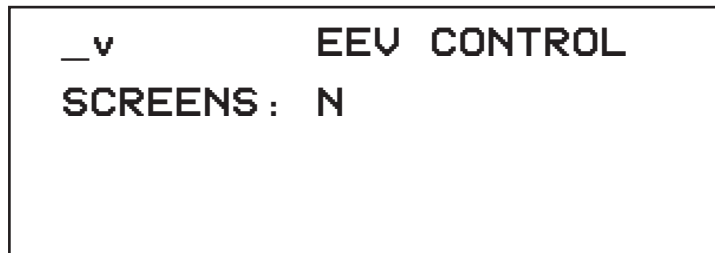

Setting:

SCREENS : Used to select whether the additional EEV screens in the Readout menu have to be displayed or not. (C1/C2 Temp readout screen)

EEV Control Steps

This screen allows modification of the EEV step pulses.

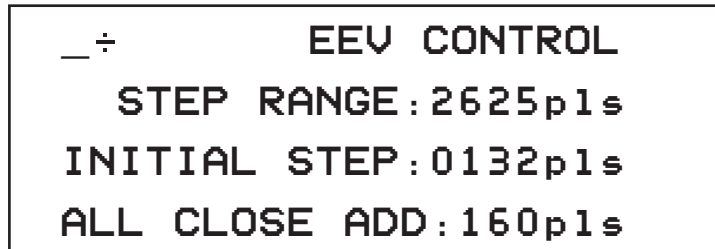

Settings:

- **STEP RANGE** : Upper limit of max. opening pulses of EV (0~2625 pls)
- **INITIAL STEP** : Open- closing steps during initialisation process at power-on
- **ALL CLOSED ADD** : Additional pulses added to the close pulses.
 - Close pulses at power on: 2625 + 160 = 2785
 - Close pulses at compressor stop: current output pulses + 160

**EEV Control Adjust
Cool / Heat**

This screen allows modification of the adjust cool/heat pulses.

```

_ ÷          EEV CONTROL
ADJUST COOL : 0800p1s
ADJUST HEAT : 0300p1s
SAMPLING TIME : 003s

```

Settings:

- ADJUST COOL** : After the initializing process, if the compressor starts up in cooling mode, it goes to the specified output for the electronic expansion valve. After reaching above ADJUST COOL EV opening, it will go to normal superheat control.
- ADJUST HEAT** : After the initializing process, if the compressor starts up in heating mode, it goes to the specified output for the electronic expansion valve. After reaching above ADJUST HEAT EV opening, it will go to normal superheat control.
- SAMPLING TIME** : Sampling time for the expansion valve control.

**Low Ambient EEV
Control**

This screen allows modification of the Low Ambient function.

```

_ ÷          EEV CONTROL
LOW AMB . CONDITION
ADJUST HEAT : 150p1s
HEAT AMB . CONST : 005 . 0°C

```

Settings:

- ADJUST HEAT** : After initializing process, if the compressor starts up in heating mode and the ambient temperature is below the HEAT AMB. CONST setpoint, it goes to the specified output for the electronic expansion value. After reaching above ADJUST HEAT EV opening, it will go to normal superheat control.
- HEAT AMB. CONST** : Ambient setpoint for the low ambient condition function.

Superheat Control

These screens allow modification of the superheat control.

```

_÷      EEV CONTROL
TRANSIENT TIME:300s
KP COOL DRY:01.6
KP HEAT DRY:02.2
    
```

```

_÷      EEV CONTROL
TIP COOL DRY:002s
TIP HEAT DRY:003s
    
```

```

_÷      EEV CONTROL
KP COOL WET:01.8
KP HEAT WET:02.6
    
```

```

_÷      EEV CONTROL
KP COOL WET:002s
KP HEAT WET:003s
    
```

```

_÷      EEV CONTROL
KP COOL NORMAL:03.0
KP HEAT NORMAL:03.0
    
```

```

_÷      EEV CONTROL
KP COOL NORMAL:020s
KP HEAT NORMAL:015s
    
```

Remark: Do not change these parameters because they have a direct influence on the superheat control.

EEV Feed Forward Control Ambient Setpoints

```

_÷      EEV CONTROL
FF CONTROL TIME:03s
COOL AMB.CONST:005.0°C
HEAT AMB.CONST:005.0°C
    
```

Settings:

- FF CONTROL TIME** : If the compressor load changes during thermostat control, the controller will change the EV opening after the "FF CONTROL TIME".
- COOL AMB. CONST** : Ambient setpoint in cooling mode for the feed forward control when the compressor load goes up or down.
- HEAT AMB. CONST** : Ambient setpoint in heating mode for the feed forward control when the compressor load goes up or down.

EEV Normal Feed Forward Control

This screen allows modification of the EEV FF control in cooling mode.

```

__ ÷ COOL EEV CONTROL

FF NORMAL UP : 1 . 3
FF NORMAL DOWN : 1 . 5

```

Settings:

- FF CONTROL UP** : If the compressor load goes up, the controller will change the EEV opening.
- Output pulses= Current pulses x "FF CONTROL UP"
- FF CONTROL DOWN** : If the compressor load goes down, the controller will change the EEV opening.
- Output pulses= Current pulses / "FF CONTROL DOWN"

EEV Low Ambient Feed Forward Control

This screen allows modification of the EEV FF control in cooling mode with low ambient temperatures.

```

__ ÷ COOL EEV CONTROL

FF LOW AMB . UP : 1 . 1
FF LOW AMB . DOWN : 1 . 2

```

Settings:

- FF LOW AMB. UP** : If the compressor load goes up AND the ambient temperature is below the COOL AMB. CONST setpoint, the controller will change the EEV opening.
- Output pulses= Current pulses x "FF LOW AMB. UP"
- FF LOW AMB. DOWN** : If the compressor load goes down AND the ambient temperature is below the COOL AMB. CONST setpoint, the controller will change the EEV opening.
- Output pulses= Current pulses / "FF LOW AMB. DOWN"

EEV Feed Forward Control

This screen allows modification of the EEV FF control in Heating mode.

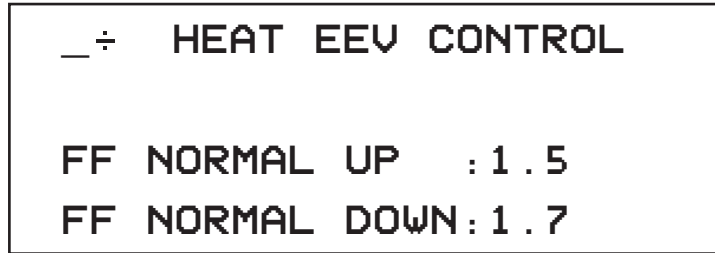

Settings:

- FF CONTROL UP** : If the compressor load goes up, the controller will change the EEV opening.
Output pulses= Current pulses x “FF CONTROL UP”
- FF CONTROL DOWN** : If the compressor load goes down, the controller will change the EEV opening.
Output pulses= Current pulses / “FF CONTROL DOWN”

EEV Feed Forward Low Ambient Control

This screen allows modification of the EEV FF control in cooling heating with low ambient temperatures.

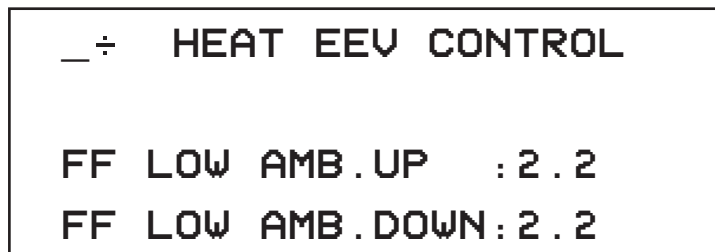

Settings:

- FF LOW AMB. UP** : If the compressor load goes up AND the ambient temperature is below the HEAT AMB. CONST setpoint, the controller will change the EEV opening.
Output pulses= Current pulses x “FF LOW AMB. UP”
- FF LOW AMB. DOWN** : If the compressor load goes down AND the ambient temperature is below the HEAT AMB. CONST setpoint, the controller will change the EEV opening.
Output pulses= Current pulses / “FF LOW AMB. DOWN”

Superheat Limits of C1 in Cooling

This screen allows modification of the upper and lower limit of the suction superheat of circuit 1 in cooling mode.

_ ÷ EEV CONTROL

C1SH L LIM COOL : 04.0°C

C1SH U LIM COOL : 08.5°C

Settings:

C1 SH L LIM COOL : Superheat lower limit in cooling mode for circuit 1

C1 SH U LIM COOL : Superheat upper limit in cooling mode for circuit 1

Remark: The suction super heat target changes according to the discharge super heat. However, this between an upper and lower superheat limit.

Superheat Limits of C1 in Heating

This screen allows modification of the upper and lower limit of the suction superheat of circuit 1 in heating mode.

_ ÷ EEV CONTROL

C1SH L LIM HEAT : 03.0°C

C1SH U LIM HEAT : 08.0°C

Settings:

C1 SH L LIM HEAT : Superheat lower limit in heating mode for circuit 1

C1 SH U LIM HEAT : Superheat upper limit in heating mode for circuit 1

Remark: The suction super heat target changes according to the discharge super heat. However, this between an upper and lower superheat limit.

Superheat Limits of C2 in Cooling

This screen allows modification of the upper and lower limit of the suction superheat of circuit 2 in cooling mode.

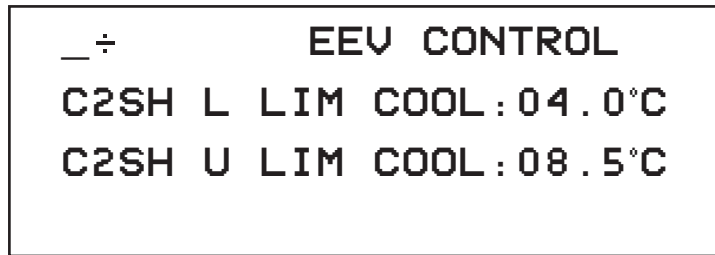

Settings:

- C2 SH L LIM COOL** : Superheat lower limit in cooling mode for circuit 2
- C2 SH U LIM COOL** : Superheat upper limit in cooling mode for circuit 2

Remark: The suction super heat target changes according to the discharge super heat. However, this between an upper and lower superheat limit.

Superheat Limits of C2 in Heating

This screen allows modification of the upper and lower limit of the suction superheat of circuit 2 in heating mode.

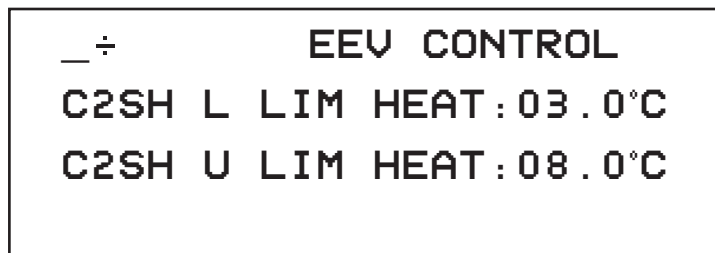

Settings:

- C2 SH L LIM HEAT** : Superheat lower limit in heating mode for circuit 2
- C2 SH U LIM HEAT** : Superheat upper limit in heating mode for circuit 2

Remark: The suction super heat target changes according to the discharge super heat. However, this between an upper and lower superheat limit.

EEV Fan Up/Down Control

This screen allows modification of the EEV fan up/down control.

```

_ ÷          EEV CONTROL
FAN DOWN PLS : 050p1s
FAN UP PLS  : 200p1s
  
```

Settings:

- FAN DOWN PLS** : When the Fan step goes DOWN, immediately close EV with 20 pulses.
- FAN UP PLS** : When the Fan step goes UP, immediately open EV with 20 pulses.

EEV Low Pressure Control

This screen allows modification of the EEV Low Pressure Control in cooling mode.

```

_ ÷          EEV CONTROL
LP PR. SETP COOL : 2.3b
LP PR. RESET COOL : 3.0b
LP ADD COOL : 0200p1s
  
```

Settings:

- LP PR. SETP COOL** : When the LP drops below LP PR. SETP COOL (2.3 bar)
→add 200 pulses to the actual electronic expansion valve position.
- LP PR. RESET COOL** : When the LP rises back above LP PR. RESET COOL (3.0 bar)
→reset the function and stop adding additional pulses.
- LP ADD COOL** : Additional pulses that will be added when the low pressure is below the low pressure prevention setpoint in Cooling mode.

EEV Low Pressure Control

This screen allows modification of the EEV Low Pressure Control in heating mode.

```

    _ ^      EEV CONTROL
    LP PR.SETP HEAT:2.3b
    LP PR.RESET HEAT:3.0b
    LP ADD HEAT:0200p1s
    
```

2

Settings:

- LP PR. SETP HEAT** : When the LP drops below LP PR. SETP HEAT (2.3 bar)
→add 200 pulses to the actual electronic expansion valve position.
- LP PR. RESET HEAT** : When the LP rises back above LP PR. RESET HEAT (3.0 bar)
→reset the function and stop adding additional pulses.
- LP ADD HEAT** : Additional pulses that will be added when the low pressure is below the low pressure prevention setpoint in Heating mode.

2.15.6 Input Output

Unit Options

This screen allows modification of the options installed on the unit.

```

_v          UNIT OPTIONS
FAN:ST     VA:N 2PUMP:N
HEATERTAPE:N
CONFIRM? N
  
```

Settings:

- | | | |
|-----------------------|---|--|
| FAN | : | ST: Fantype is ON/OFF fans |
| | : | INV: Fantype is a combination of ON/OFF fans and Inverter fans |
| VA:N/Y | : | Select if Volt-Ampere meters (option) is installed. |
| | | When Y is selected, an additional screen will appear in the readout menu. |
| 2PUMP:Y/N | : | Select if 2nd pump is installed |
| HEATERTAPE:Y/N | : | Select if heatertape is installed |
| CONFIRM? | : | <ul style="list-style-type: none"> • Confirm settings, when an option setting has been changed. When a setting has been changed without confirmation → the 0UA: OP. NOT CONFIRMED alarm will be displayed and can only be reset after confirmation. • When a main PCB has been changed or reprogrammed with new software, the OU4: OP. NOT CONFIRMED will be displayed and can only be reset after confirmation. |

Changeable Digital Inputs

This screen allows modification of the changeable digital inputs.

```

_÷  CHANG.  INP/OUTPUTS
DI1:NONE
DI2:NONE
DI3:NONE
  
```

Settings:

- DI1** : To set the digital input 1
- DI2** : To set the digital input 2
- DI3** : To set the digital input 3

When programming this input, check the field wiring to see if it has been installed correctly.

Possible settings for Chang. Dig. Inputs

- None
- Status
- Dual setpoint
- Remote ON/OFF
- Remote Cool/Heat
- Cap. Limit 25% (only double circuit)
- Cap. Limit 50%
- Cap. Limit 75% (only double circuit)
- Cap. Limit Set
- Free cooling request
- Low noise (only with inverter fans)
- Fan forced on

Changeable Digital Input and Outputs

This screen allows modification of the changeable digital input and outputs.

```

_ ÷  CHANG.  INP/OUTPUTS
DI4 : NONE
DO1 : SAFETY+W. (NO)
DO2 : GEN. OPERATION
  
```

Settings:

- DI4** : To set the digital input 4
- DO1** : To set the digital output 1
- DO2** : To set the digital output 2

When programming this input or one of these outputs, check the field wiring to see if the input/output has been installed correctly.

Possible settings for Chang. Dig. Outputs

- None (open)
- Closed
- 2nd pump
- 100% capacity
- Full capacity
- Free cooling
- Gen. Operation
- Safety+W (NO) / Safety + W (NC)
- Safety (NO) / Safety (NC)
- C1/C2 safety
- Warning
- C1/C2 operation
- 0% capacity
- Cooling
- Heating
- Defrost

Changeable Digital Outputs

This screen allows modification of the changeable digital outputs.

```
__ ÷  CHANG .  INP/OUTPUTS
DO3 : NONE  (OPEN)
DO4 : NONE  (OPEN)
DO5 : NONE  (OPEN)
```

Settings:

DO3 : To set the digital output 3
DO4 : To set the digital output 4
DO5 : To set the digital output 5

When programming this output, check the field wiring to see if the output has been installed correctly.

Changeable Digital Output and Analogue Input

This screen allows modification of the changeable digital output and analogue inputs.

```

_ ÷  CHANG.  INP/OUTPUTS
DO6 : NONE  (OPEN)
AI1 : NONE
AI1 TYPE : 0-20mA

```

Settings:

- DO6** : To set the digital output 6
- AI1** : To set the analogue input 1
- AI1 TYPE** : To set the type of the analogue input 1

When programming this digital output or analogue input, check the field wiring to see if the output or analogue input has been installed correctly.

The changeable analogue inputs can be programmed as analogue inputs OR as digital inputs.

1. Select the analogue input status
2. Specify the type of the used signal

Possible settings analogue inputs

- None
- Status
- Floating setpoints
- Temperature

Possible settings analogue input as digital input

- DI STATUS
- DI REM. COOL / HEAT
- DI CAP LIM 25% / 50% / 75%
- DI CAP LIM SET
- DI FREE COOLING

Remark: The digital input will close when a 5 V DC signal is given to the controller.

Changeable Analogue Inputs

These screens allow modification of the analogue inputs.

```

_÷ CHANG. INP/OUTPUTS
AI2 : NONE
AI2 TYPE : 0-20mA
AI3 : NONE

```

```

_÷ CHANG. INP/OUTPUTS
AI3 TYPE : 0-20mA
AI4 : NONE
AI4 TYPE : 0-20mA

```

Settings:

- AI2** : To set the analogue input 2
- AI2 TYPE** : To set the type of the analogue input 2
- AI3** : To set the analogue input 3
- AI3 TYPE** : To set the type of the analogue input 3
- AI4** : To set the analogue input 4
- AI4 TYPE** : To set the type of the analogue input 4

When programming this analogue input, check the field wiring to see if the input has been installed correctly.

Changeable Analogue Output

This screen allows modification of the analogue output.

```

_÷ CHANG. INP/OUTPUTS
AO1 : NONE
AO1 TYPE : 0-20mA

```

Settings:

- AO1** : To set the analogue output 1
- AO1 TYPE** : To set the type of the analogue output 1

Possible settings for the analogue output.

- None
- Unit capacity

**Sensor Offset For
Software V2.1**

This screen allows modification of the sensor offset for software version V2.1.

```

_ ÷ NTC/PR. SENSORS
SELECT: PCB1 AI1
NTC: TYPE1
OFFSET: 0.0°C

```

Settings:

- SELECT: PCB1 AI1** : All the sensors (temp. and press.) connected to the PCB1, PCB2 or expansion boards can be selected.
- NTC** : This will display the type of sensor.
- OFFSET** : An offset can be done for this sensor.

**Sensor Offset For
Software V2.2 or
higher**

This screen allows modification of the sensor offset for software version V2.2.

```

_ ÷ NTC/PR. SENSORS
SEL: MAINPCB1 AI X33A
NTC: TYPE1
OFFSET: 0.0°C

```

Settings:

- SEL: MAINPCB AI X33A** : All the sensors (temp. and press.) connected to the PCB1, PCB2 or expansion boards can be selected.
- NTC** : This will display the type of sensor.
- OFFSET** : An offset can be done for this sensor.

2.15.7 Communication

Communication PCB Information

This screen shows additional information about the extension PCB, communication PCB and communication P1 P2 PCB.

```

_v      COMMUNICATION
EXT . PCB : 4SSR+HIC
COMM . PCB : DIII+SER
COMM.P1P2 PCB : NONE
    
```

Display	Description
EXT. PCB	Extension PCB with 4 solid state relays and hybrid type (PCB with Analogue outputs)
COMM. PCB	Communication PCB with DIII and serial communication
COMM. P1 P2 PCB	None (not used)

EEV PCB Information

This screen shows additional information about the EEV PCB.

```

_÷      COMMUNICATION PCB
EEV . PCB : UNI POLAR
    
```

Display	Description
EEV. PCB	UNI POLAR, PCB type used for EEV control.

Serial Communication Parameters

This screen allows modification of the serial communication parameters.

```

_ ÷ COMMUNICATION PCB
RS232 : NONE
BR : 19200bps
  
```

Parameters for the RS232 communication:

- Not used in multiple scroll units.

BNS Communication Parameters

This screen allows modification of the communication PCB parameters (BMS settings)

```

_ ÷ COMMUNICATION PCB
RS485 : NONE   ADDR : 01
BR : 19200bps
PARITY : EVEN (1STOPb)
  
```

Settings:

- | | | |
|---------------|---|---|
| RS485 | : | <ul style="list-style-type: none"> ■ NONE: communication disabled ■ MODBUS : MODBUS communication enabled |
| ADDR | : | Address of the unit in the BMS system |
| BR | : | Indicates the speed of communication
(19200/9600/4800/2400/1200) |
| PARITY | : | <ul style="list-style-type: none"> ■ NONE (2 stop bit) ■ EVEN (1stop bit) ■ ODD (1 stop bit) |

**D III
Communication
Parameters**

This screen allows modification of the communication PCB parameters (DICN settings, ...).

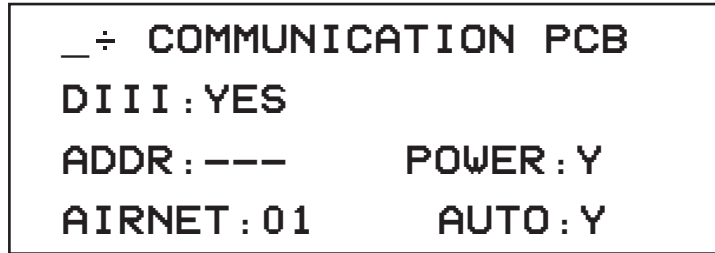

2

Settings:

- D III:** : ■ YES: D III communication enabled
 : ■ No : D III communication disabled
- ADDR** : ■ ---: No address selected
 : ■ "1-00" to "8-15": address selected
- POWER** : ■ If a D-BACS device is present (iManager, ...) DIII power parameter: "N" on all units
 : ■ If no D-BACS device is present → only for DICN DIII power parameter: "Y" on only 1 unit (Master unit)
- AIRNET** : Airnet address (1-64)
- AUTO** : ■ YES: Chiller send information automatic to Airnet
 : ■ NO: Airnet must request chiller data each time

Remark: The DICN functionality can be used in combination with the D-BACS functionality.

This screen allows modification of the BMS control setting.

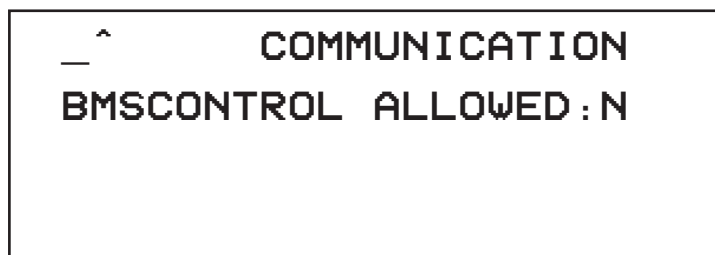

Settings:

- BMS CONTROL ALLOWED** : ■ If set to Y (yes), the unit can be commanded and configured from a supervisory system.
 : ■ If set to N (no), the supervisory system can only read out values but cannot modify them.

2.15.8 DICN

DICN settings

This screen allows modification of the DICN settings.

```

_v      DICN SETTING
MS OPTION:N
UNIT:MASTER
NR OF SLAVES:1

```

Settings:

- MS OPTION** : N: DICN is disabled
Y: DICN is enabled
- UNIT** : **MASTER**: unit is selected as master unit
SLAVE: unit is selected as slave unit
- NR OF SLAVES** : The number of slaves in the system has to be defined. (only on the master unit)

Remark: NR OF SLAVES will only be visible when the unit is programmed as MASTER unit.

Slave addresses

This screen allows modification of the slave addresses.

```

÷      DICN SETTING
ADD SL1:---

```

Settings:

Only on MASTER unit

- **ADD SL1** : Specify the D III address programmed in slave 1
- **ADD SL2** : Specify the D III address programmed in slave 2 (if present)
- **ADD SL3** : Specify the D III address programmed in slave 3 (if present)

Example: ADD SL1:1-01

Master Settings

This screen allows modification of the master unit settings.

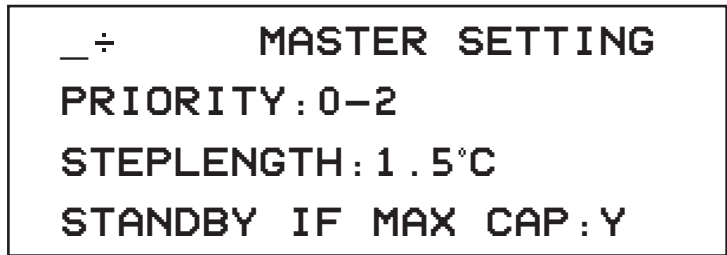

Settings:

- PRIORITY: 0-2** : Select Unit priority - stepL Priority
- STEPLENGTH: 1.5°** : parameter used in the formula to calculate the loading priority
- STANDBY IF MAX CAP** : **N:** When all “normal” units are at maximum capacity
 → standby unit will start up to reach the setpoint.
Y: When all “normal” units are at maximum capacity
 → standby unit will not start up (only on error on other units)

DICN Thermostat

This screen allows modification of the DICN thermostat settings.

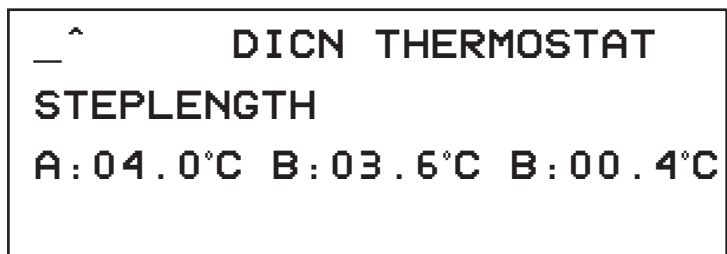

Step length settings:

- A** : Step difference value A, used for the DICN thermostat function
- B** : Step difference value B, used for the DICN thermostat function
- C** : Step difference value C, used for the DICN thermostat function

Remark: DICN thermostat control is only possible on Inlet control.

2.15.9 Safety

MOW and no flow settings

This screen allows modification of the minimum outlet water setpoint and the flow alarm.

_v SAFETY

MIN. OUTL. WATER : 005.0°C

IF NO FLOW AFTER

PUMPLEADTIME : ALARM

Settings:

- MIN. OUTL. WATER** : The minimum outlet water can be selected in this menu. When using glycol, this setting has to be changed. Units with OPZL (glycol operation) have special software with a lower MOW setpoint range.
- IF NO FLOW AFTER PUMPLEADTIME** : **ALARM:** The unit will go into alarm and manual reset is needed.
- STANDBY:** The unit will wait to start until the flow is resorted.

HP Setback and Inverter Fan Mask Settings

This screen allows modification of the high pressure setback and the inverter fan mask time.

_÷ SAFETY

HPSETB : 37.4b DIFF : 0.4b

MASK INVFAN SAF : 120s

Settings:

- HPSETB** : High pressure set back safety. When the HP rises above the setpoint, the unit will switch OFF 1 compressor of this circuit.
- DIFF** : When the high pressure setback is active and the pressure drops below HPSETB-DIFF, normal operation and compressor can be added.
- MASK INVFAN SAF** : Mask time of the inverter fan safety. The inverter safety will be displayed after 120sec.

Remark: MASK INVFAN SAF will only be visible when the unit has OPIF or OPLN.

Reset Safety Setting

This screen allows modification of the reset safety setting.

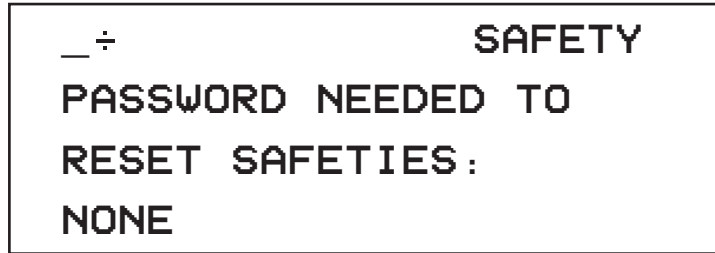

Settings:

Select if a password is needed to reset a safety

- NONE** : No password is needed to reset a safety.
- USER PASSWORD** : User password is needed to reset a safety
- SERVICE PASSWORD** : Service password is needed to reset a safety.

Fan Overcurrent Setting For V2.1

This screen allows modification of the fan overcurrent safety for software version V2.1.

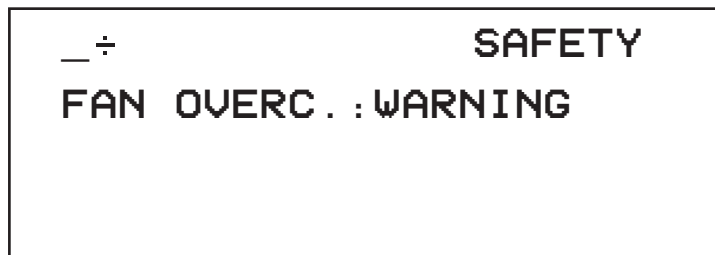

Settings:

FAN OVERC.:

- WARNING** : When a fan overcurrent occurs, a warning will be displayed, but the unit will continue operation.
- SAFETY** : When a fan overcurrent occurs, a safety will be displayed and the circuit will be switched off.

**Fan Overcurrent
Setting For V2.2**

This screen allows modification of the fan overcurrent safety for software version V2.2.

```

_ ÷                SAFETY
FAN OVERC. : WARNING
FREEZE UP OW : DIS&SAF
  
```

Settings:**FAN OVERC.:**

WARNING:	When a fan overcurrent occurs, a warning will be displayed, but the unit will continue operation.
SAFETY:	When a fan overcurrent occurs, a safety will be displayed and the circuit will be switched off.
<u>FREEZE UP OW:</u>	Freeze up safety on outlet water temperature
DIS&SAF	Use the same logic as the freeze up safety on refrigerant gas temperature (second time in 30 min → alarm).
DISABLE	Same function as software version V2.1. Unit will shut down on freeze up but will restart automatic and no alarm is displayed.

**Unit Status during
Safety**

This screen allows modification of the unit status when a safety is active.

```

_ ÷                SAFETY
IF UNITSAFETY THEN
PUT UNIT OFF : NO
  
```

Settings:**IF UNIT SAFETY THEN PUT UNIT OFF:**

YES:	Normal function. The after safety unit has to be restarted.
NO:	Used with D-bacs control. When the unit switches off the after safety, there is a possibility that the safety can not be seen by the D-bacs control.

Warning Settings

This screen allows modification of the setting if during the high pressure set back function or the compressor protection function, a warning has to be displayed.

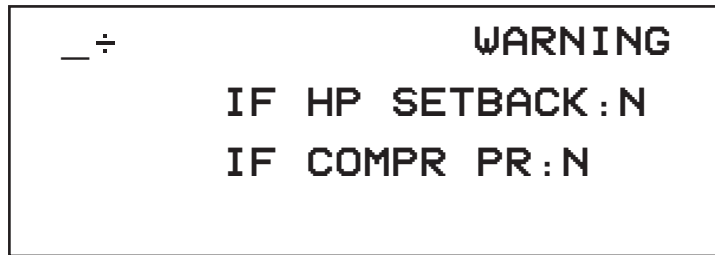

Settings:

IF HP SETBACK:

N: If the unit is in the HP setback function, no warning will be displayed

Y: If the unit is in the HP setback function, a warning will be displayed

IF COMPR PR:

N: If the unit is in the compressor protection function, no warning will be displayed.

Y: If the unit is in the compressor protection function, a warning will be displayed.

High Discharge Safety Settings

This screen allows modification of the high discharge temperature setpoint.

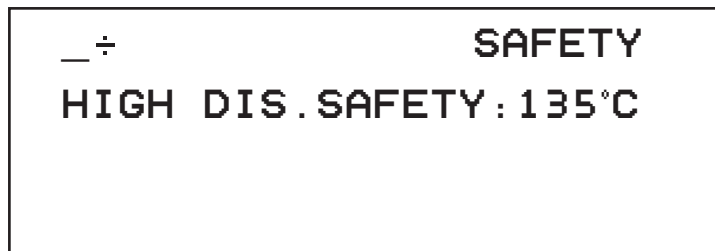

Settings:

HIGH DIS. SAFETY : When the discharge temperature of a compressor rises above the setpoint, the circuit will shut down and a HIGH DISCHARGE TEMP. ERROR will be displayed.

LP Setpoint and Mask Timers

This screen allows modification of the low pressure alarm setpoint and the low pressure mask timers.

_ ÷ SAFETY

LP SETP. C: 1.2b H: 0.5b

FAN LP MASK: 030s

COMPR LP MASK: 030s

Settings:**LP SETPOINT:**

If the low pressure drops below the LP setpoint → stop the unit immediately on LP Error.

- **Cooling mode:** 1,2 bar
- **Heating mode:** 0,5 bar

FAN LP MASK: Mask time of 30sec from fan switching (only fan Load up)

COMPR LP MASK: Mask time of 30sec from 1st compressor start-up (no masking at 2nd compressor start)

Freeze-up Settings

This screen allows modification of the freeze-up safety settings.

_ ÷ FREEZE UP SAFETY

FREEZE UP DIS: 004.0°C

RESET: 005.0°C

Settings:**FREEZE UP DIS:**

Freeze-up disabling setpoint, used for:

- Freeze-up protection = FREEZE UP DIS setpoint
- Freeze-up Prevention = FREEZE UP DIS setpoint +0,5°C

RESET:

Reset value of freeze-up prevention / protection

- Freeze-up protection : Above RESET value, possible to reset freeze-up safety
- Freeze-up prevention : Above RESET value, back to normal thermostat control

Anti-freeze Function

This screen allows modification of the anti-freeze function by pump operation and refrigerant temperature.

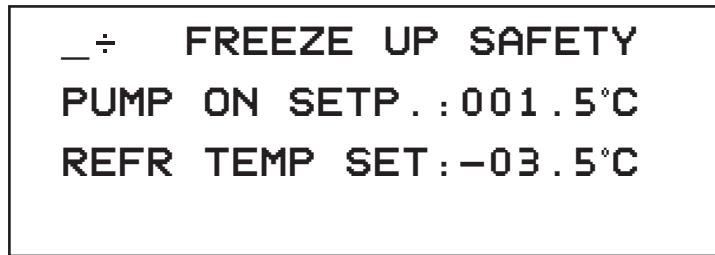

Settings:

- PUMP ON SETP** : Setpoint of the anti-freeze function by pump operation
- REFR TEMP SET** : Setpoint of the anti-freeze function by refrigerant gas temperature

Discharge Gas Safety

These screens allow modification of the discharge gas safety.

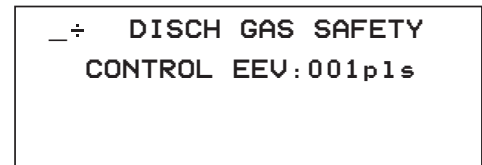
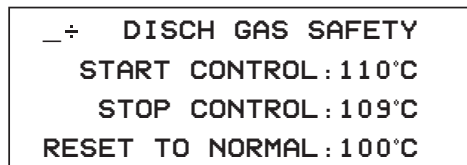

Settings:

- START CONTROL** : Setpoint of the discharge gas safety, start of adding extra EXV opening
- STOP CONTROL** : Setpoint of the discharge gas stop condition, stop of adding extra EXV opening
- RESET TO NORMAL** : Reset setpoint of the discharge gas safety, stop of the function and switching back to normal EEV control.
- CONTROL EEV** : Setting of the additional pulses that will be added to the EXV opening during the discharge gas safety function

Compressor and Unit Restart Timers

This screen allows modification of the compressor timers and unit restart timer.

— ^ **RESTART SAFETY**

GRD : 03m AREC : 005m

RESTART POWER ON : 030s

REF GRD EXTEND : 12m

Settings:

GRD	:	Guard timer setting
AREC	:	Anti recycling timer setting
RESTART POWER ON	:	When the unit is powered up after a power failure / main switch, the unit can restart (automatic restart) after 30 sec.
REF GRD EXTEND	:	Refrigerant guard extend timer, when unit is switched off on refrigerant gas temperature safety. The compressor can only restart after 12 min (default).

2.15.10 History

Extra screen

This screen allows modification of the extra screen parameter that enables or disables the history logging function.

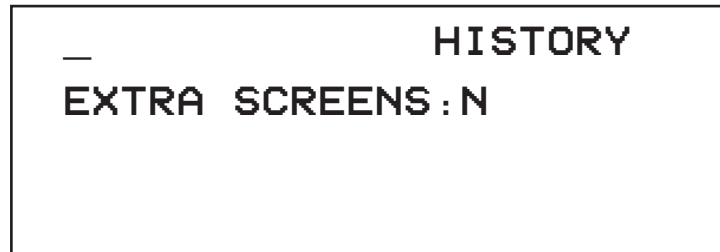

Settings:

EXTRA SCREENS :

Enable or disable the history logging function

N: Log data will not be displayed in the history menu.

Y: Log data will be displayed in the history menu.

2.15.11 Advanced

Auto Restart

This screen allows modification of the auto restart function.

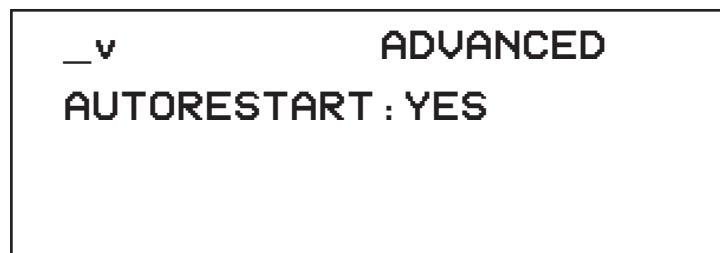

Settings:

Auto re-start:

YES: The unit will re-start after a power failure.

NO: The unit will not re-start after a power failure. Manual re-start is needed on the controller.

**Simulation
Parameters**

This screen allows modification of the simulation function, used on simulation boards.

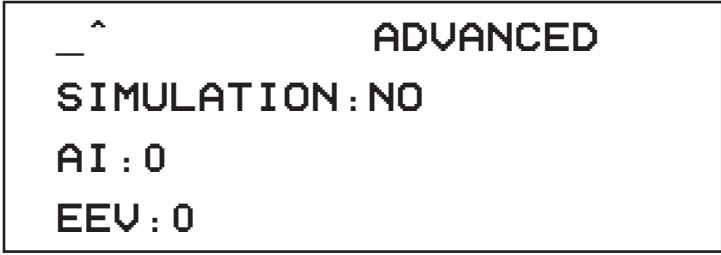

```
  ^
  _  ADVANCED
SIMULATION:NO
AI:0
EEV:0
```

Settings:■ **SIMULATION:**

NO: Use of software on real unit

YES: Use of software on simulation board

■ **AI:**

0: Use on real unit

1: Use on simulation board

■ **EEV:**

0: Use on real unit

1: Use on simulation board

2.15.12 Defrost

This screen allows modification of the defrost start condition and defrost timers.

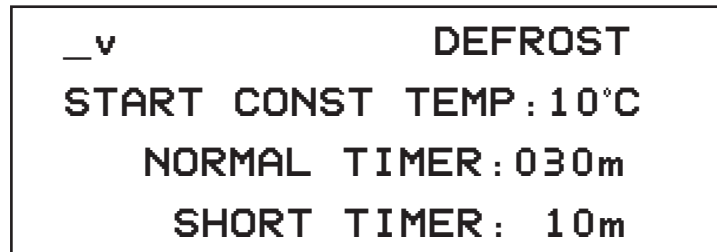

Settings:

- START CONST TEMP** : Setting used in the formula to calculate if defrost cycle is requested.
- NORMAL TIMER** : Minimum normal time between 2 defrost cycles of the same circuit.
- SHORT TIMER** : Minimum short time between 2 defrost cycles of the same circuit.

Remark: The selection of NORMAL or SHORT timer can be done in the USER/defrost screens.

This screen allows modification of the defrost lead time.

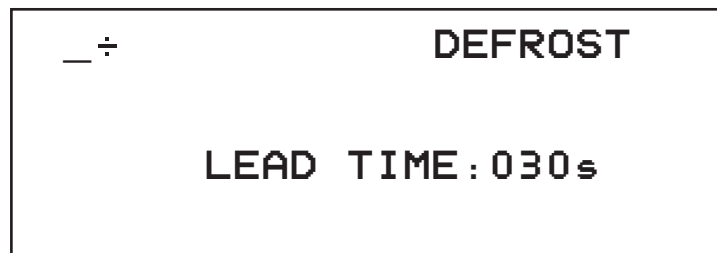

Settings:

- LEAD TIME** : Time between the actual defrost start and the moment the defrost start conditions were met.

This screen allows modification of the defrost parameters.

_ ÷ DEFROST

START EEV: 0200p1s

START KEEP TIME: 005s

RESET COIL TEMP: 20°C

Settings:

- START EEV** : Start opening of the EEV by switching from heating to cooling mode during the defrost cycle.
- START KEEP TME** : Time when the START EEV pulses are used before normal cooling EEV control is active.
- RESET COIL TEMP** : Stop condition of the defrost cycle based on the coil temperature.

This screen allows modification of the defrost stop conditions.

_ ÷ DEFROST

START EEV: 0200p1s

START KEEP TIME: 005s

RESET COIL TEMP: 20°C

Settings:

- RESET SET PR** : Stop condition of the defrost cycle based on the high pressure.
- RESET OUTL TEMP** : Stop condition of the defrost cycle based on the outlet water temperature.

Defrost settings

This screen allows modification of the defrost settings.

```
  ^
  —  DEFROST
      INITIAL EEV:0200p1s
      INITIAL TIME:030s
      EEV KEEPTIME:030s
```

Settings:

- | | | |
|----------------------|---|---|
| INITIAL EEV | : | Initial EEV pulses used in the defrost function |
| INITIAL TIME | : | Initial time used in the defrost function |
| EEV KEEP TIME | : | Time when the EEV already completely opens before switching 4-way valve |

2.16 Menu overview

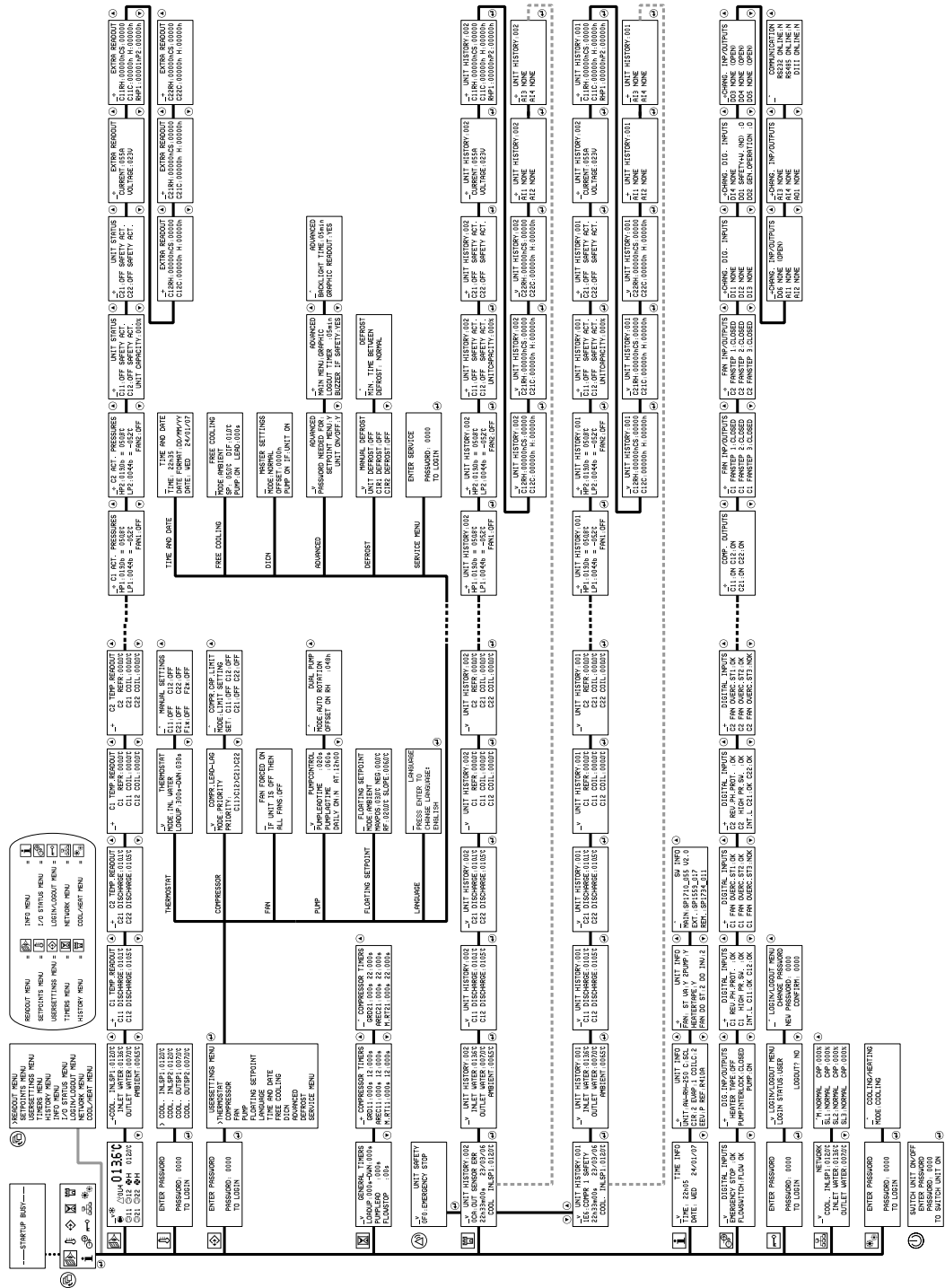

2.17 Service menu overview

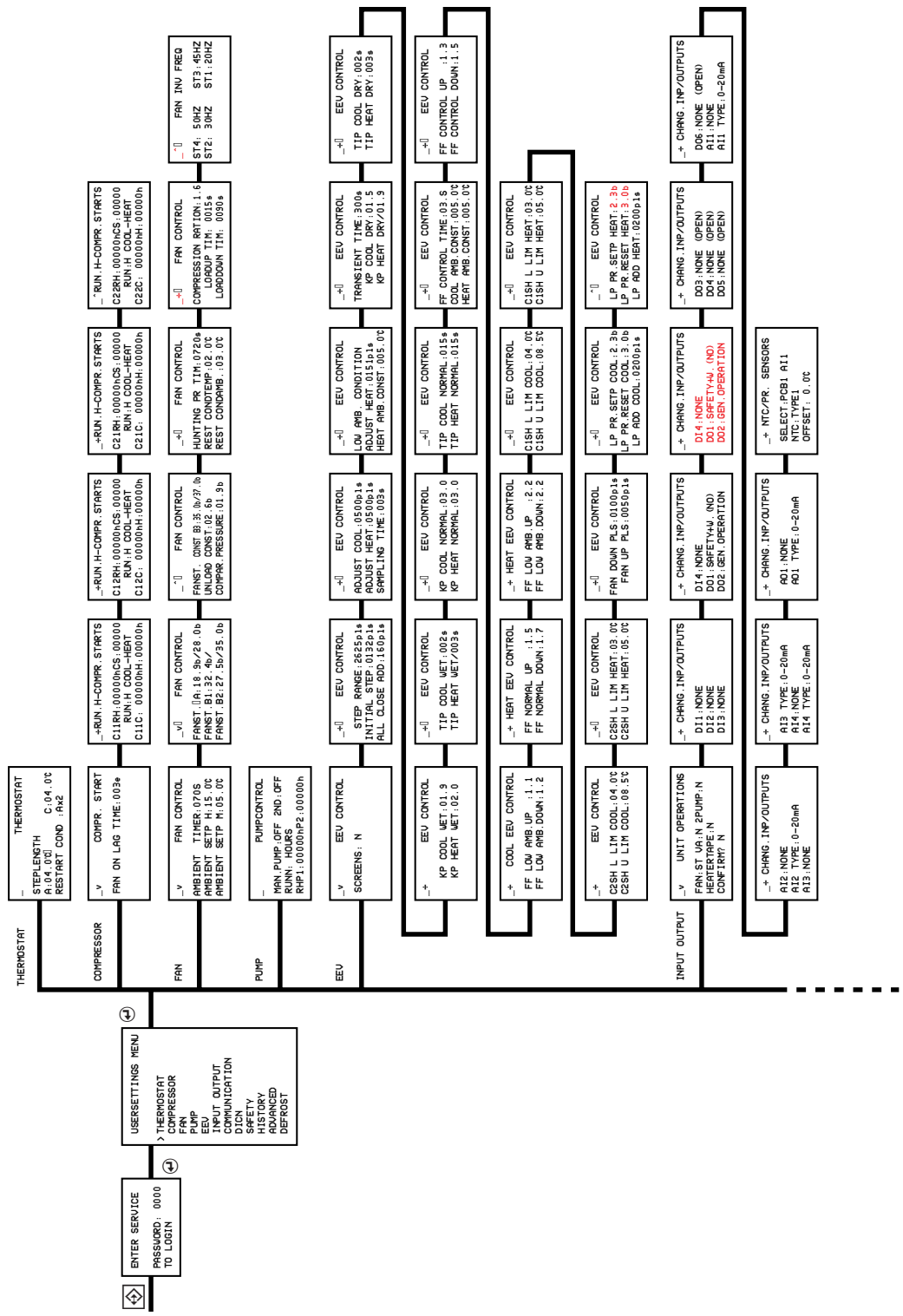

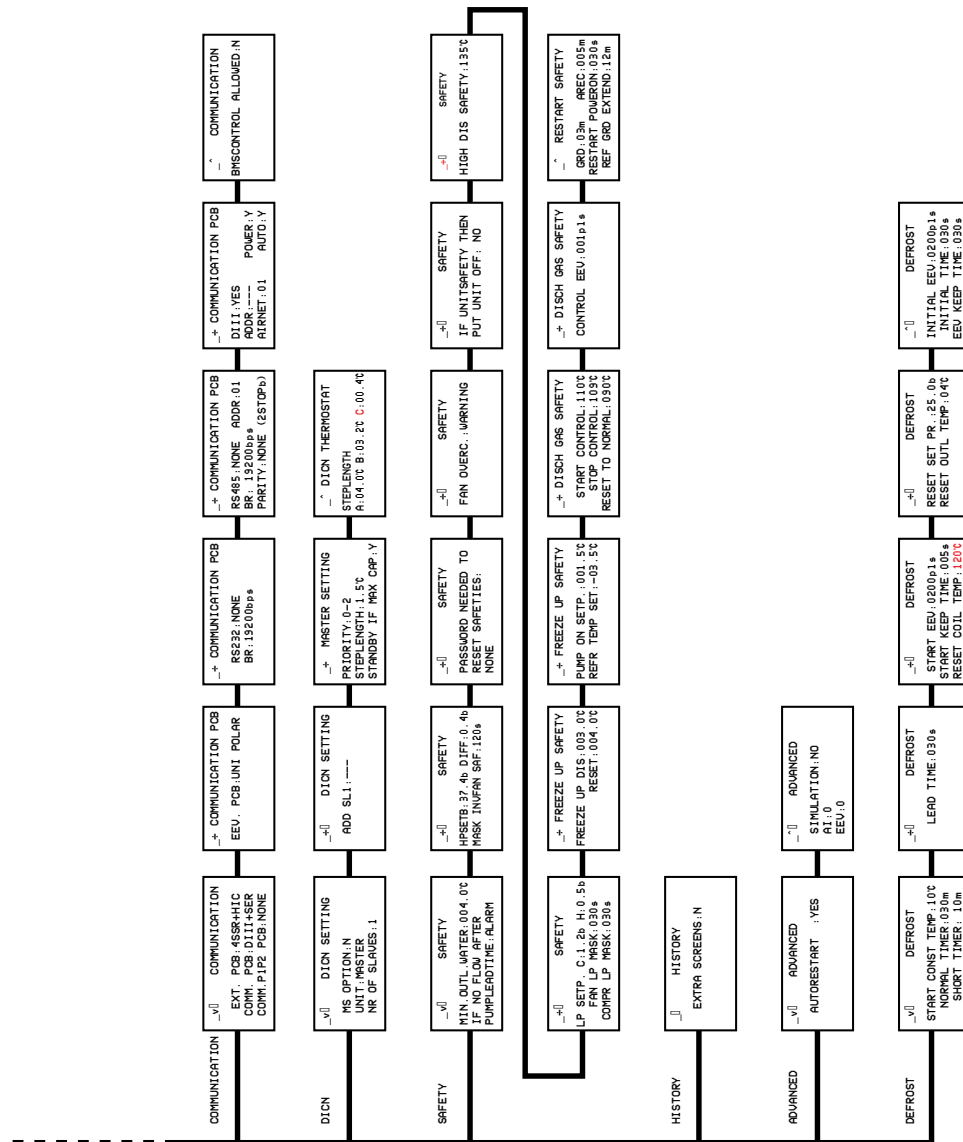

3 Functional Control for a Standalone Unit

3.1 What Is in This Chapter?

Introduction

This chapter will give more detailed information about the functions used to control the system. Understanding these functions is vital when diagnosing a malfunction, which is related to functional control.

Overview

This chapter contains the following topics:

Topic	See page
3.2–Operation Flowchart	2–106
3.3–On/Off Management	2–107
3.4–Thermostat Control	2–108
3.5–Manual Control	2–114
3.6–Compressor Control	2–115
3.7–Fan Control	2–119
3.8–Pump Control	2–128
3.9–Floating Setpoint	2–129
3.10–Free Cooling	2–133
3.11–Superheat control	2–137
3.12–Changeable digital inputs	2–140
3.13–Changeable digital outputs	2–141
3.14–Changeable analogue inputs	2–142
3.15–Changeable analogue outputs	2–143
3.16–DICN Basic Setup (=master/slave system)	2–144
3.17–BMS Function	2–153
3.18–Freeze-up Control	2–157
3.19–Discharge gas safety	2–163
3.20–Password Function	2–164
3.21–History logging	2–165
3.22–Defrost management	2–166
3.23–Reversing valve	2–171
3.24–Low pressure bypass	2–172
3.25–Simulation	2–173

3.2 Operation Flowchart

Cooling only

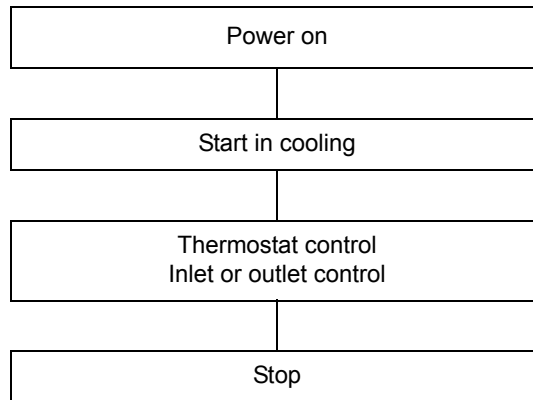

Heat pump

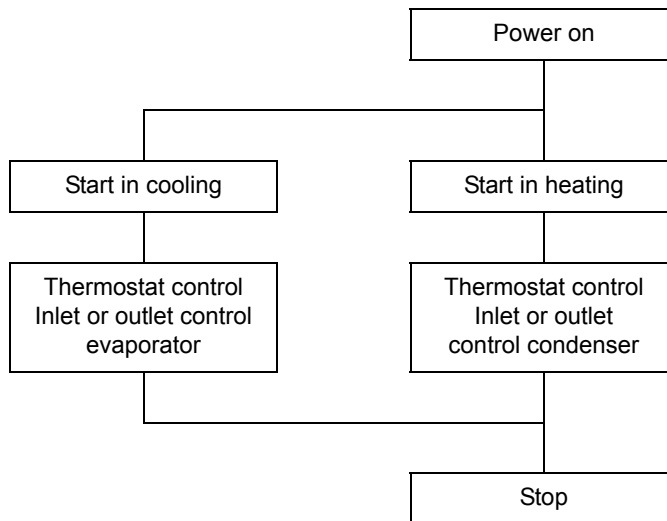

2

3.3 On/Off Management

Introduction

There are three ways of switching the unit on and off:

- Through the local key of the controller.
- Through the BMS.

The last command, of these two, determines the status of the local key.

- Through a remote switch. The remote switch gives an on/off signal to one of the changeable digital inputs of the controller.

If the remote switch function is used, then an AND function with the first two commands determines the on/off status of the unit.

Power on

- The initialization takes 20 seconds.
- The controller automatically goes to the menu overview or operation informative screen.

Remark:

An auto restart function is integrated. This means that the on/off status is remembered after a power failure of the unit. This function can be disabled in the service/advanced menu.

Remote on/off

The procedure to switch the unit on/off depends on the settings of the changeable inputs/outputs. These settings can be made in the service input output menu.

Remark:

- The remote on/off switch is field supply.
- When the remote switch is "OFF" it is not possible to switch the unit on with the controller.

On/off status

This table gives an overview of the status of the unit and LEDs in applications with a remote switch. In case there's no remote switch the status of the unit only depends on the status of the local key.

Local key	Remote Switch	Unit	LED
ON	ON	ON	ON
ON	OFF	OFF	Flashing
OFF	ON	OFF	OFF
OFF	OFF	OFF	OFF

3.4 Thermostat Control

Introduction

The thermostat control is used to generate a load -up or load-down according to the active thermostat, if the load-up respectively load-down timer is finished (this means gone to "0").

The thermostat can be set to regulate on different signals:

- Signal from the water sensor at the inlet of the evaporator.
- Signal from the water sensor at the outlet of the evaporator.
- Signal from the water sensor at the inlet of the condenser (only for EWYQ).
- Signal from the water sensor at the outlet of the condenser (only for EWYQ).

There are several possible functions for the thermostat control:

- Cooling: inlet evaporator control.
- Cooling: outlet evaporator control.
- Heating: inlet condenser control (only for EWYQ).
- Heating: outlet condenser control (only for EWYQ).
- External analog signal. (0 - 1V, 0 - 10V, 4 -20 mA, 0 - 20 mA).
- Floating setpoint.

Mode change over

Modechange inlet/outlet:

- From Manual to inlet/outlet (or reverse): switch off all compressors.
- From inlet to outlet (or reverse): switch off all compressors.

Modechange cooling/heating:

- From cooling to heating (or reverse): switch off all compressors.

Thermostat timers and actions

- If the temperature is below the setpoint, the thermostat control will check every LOADDOWN TIMER (example for cooling mode).
According to the deviation to the setpoint, no action, load up, load down is required.
- If the temperature is above the setpoint, the thermostat control will check every LOADUP TIMER (example for cooling mode).
According to the deviation to the setpoint, no action, load up, load down is required.

Default and limit values

	Default value				
		Units 1 circuit	Units 2 circuit	Lower Limit	Upper Limit
INLET CONTROL					
Step difference - a	(K)	4.0 (*)	2.0 (*)	—	—
Steplength - c	(K)	0.2 (*)		—	—
Loadup timer	(sec)	180		15	300
Loaddown timer	(sec)	30		15	300
Setpoint cooling	(°C)	12.0		7.0	23.0
Setpoint heating	(°C)	40		20.0	45.0

(*) can only be modified in the service menu.

OUTLET CONTROL	Default value				
		Units 1 circuit	Units 2 circuit	Lower Limit	Upper Limit
Step difference - a	(K)	4.0 (*)	2.0 (*)	—	—
Steplength - c	(K)	0.2 (*)		—	—
Loadup timer	(sec)	30		15	300
Loaddown timer	(sec)	15		15	300
Setpoint cooling	(°C)	7.0		5.0	20.0
Setpoint heating	(°C)	45.0		25.0	50.0

Inlet control for cooling mode

The illustration below shows the thermostat inlet control in cooling mode.

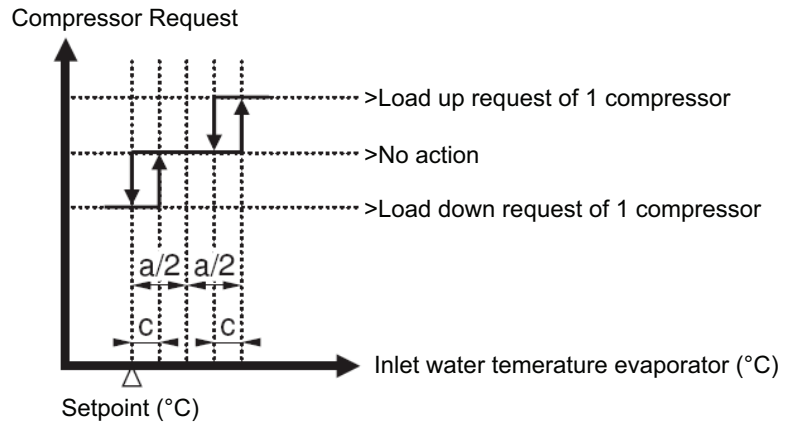

Inlet Control for the Heating Mode

The illustration below shows the thermostat inlet control in heating mode.

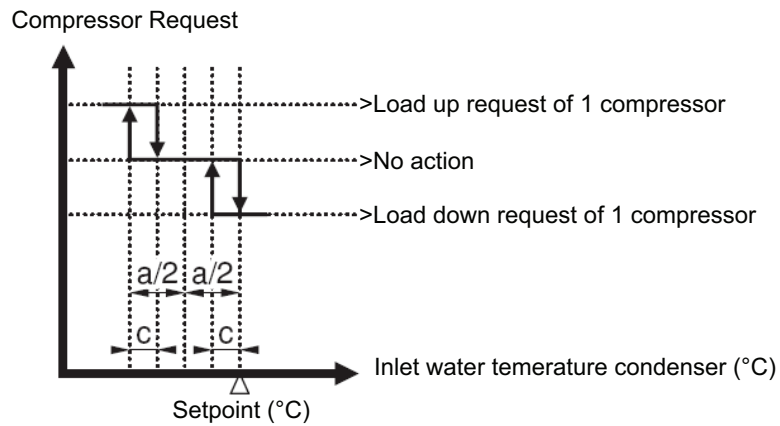

2

Restart conditions for inlet control

Remark:

The EWYQ080DAYN* has a modified control in heating mode when ambient temperature is less than or equal to 5 °C.

- If ambient temperature is lesser than or equal to 5 °C, then two compressors always run together (30 seconds between the startup of the first compressor and the second compressor).

Restart conditions from normal thermo OFF or forced thermo OFF.

When after thermo OFF, all below conditions are met, the compressor can be restarted.

The start conditions are:

- Restart prevention timer has counted down.
- Load up signal is given by controller (thermostat).
- Inlet water temperature is \geq inlet water setpoint + A (cooling).
- Inlet water temperature is \geq to inlet water setpoint - A (heating).

Remark:

Parameter A= Restart condition value programmed in the service/thermostat menu.

Outlet control for cooling mode

The illustration below shows the thermostat outlet control in cooling mode.

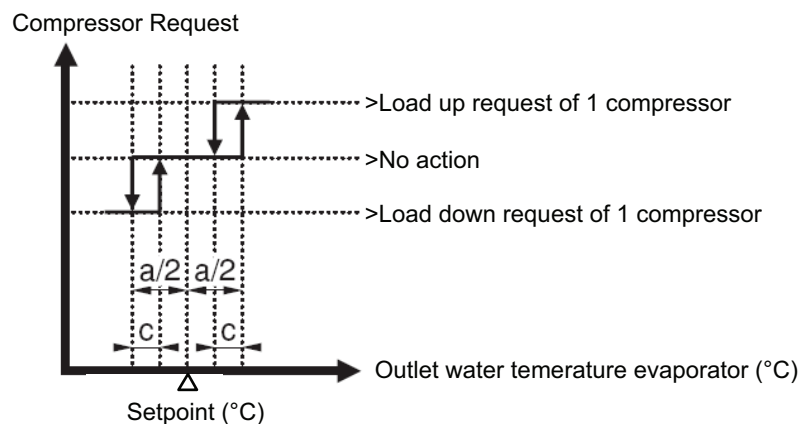

Outlet control for heating mode

The illustration below shows the thermostat outlet control in heating mode.

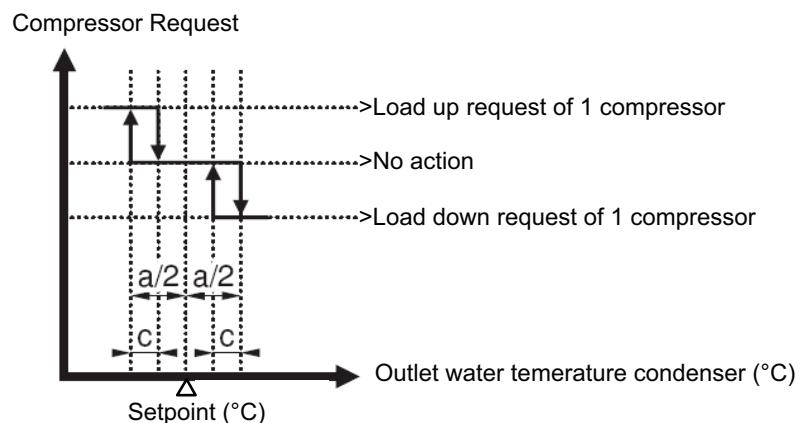

Restart conditions for outlet control version 2.1
Restart conditions after normal thermo off for software version 2.1.

After NORMAL thermo off, AND below conditions are met, the compressor can be restarted.

Start conditions:

- Restart Prevention timer has counted down.
- Load up signal is given by controller (thermostat).
- Inlet water temp.during previous thermo-off + Stl A °C is \leq current inlet water temp. (Cooling)
- Inlet water temp.during previous thermo-off - Stl A °C \geq current inlet water temperature (Heating).
Stl A : Thermostat differential value.

However, for below conditions, the start condition of inlet water temperature + Stl A °C is invalid and the unit will start immediately if:

- Water temperature setpoint has changed ± 1 °C or more.
- Forcing "thermo ON" order has been input from user interface.
- Inlet thermistor has abnormality and other circuit is in alarm.

Remark:

Parameter A= Step difference value programmed in the service/thermostat menu.

Restart conditions after forced thermo-OFF

After FORCING Thermo-off, AND below conditions are met, the compressor can be restarted.

- Re-start prevention timer has been counted down.
 - Outlet setpoint + (Stl A °C x B) \leq current outlet water temperature. (Cooling)
 - Outlet setpoint _ (Stl A °C X B) \geq current outlet water temperature. (Heating)
Stl A : Step difference value.
B= 2 : Differential expansion constant Changeable : 1~ 4.
-

FORCED thermo off conditions:

- Outlet water temperature below FREEZE up DIS setpoint forcing thermo-off.
- Refrigerant temperature below REFR TEMP setpoint forcing thermo-off.

Restart conditions for outlet control version 2.2

Restart conditions after normal thermo-OFF for software version 2.2.

After NORMAL thermo-off, AND below conditions are met, the compressor can be restarted.

Start conditions :

- Timer has counted down
- Load up signal is given by controller (thermostat)
- Inlet water temperature during previous thermo-off + restart condition °C is \leq current inlet water temp (cooling).
- Inlet water temperature during previous thermo-off minus restart conditions °C is \geq current inlet water temperature (heating).

Restart conditions: restart condition differential value programmed in the service/thermostat menu.

However, for below conditions, condition of inlet water temperature + restart condition °C is invalid and the unit will start immediately if:

- Water temperature setpoint has changed ± 1 °C or more.
- Forcing "thermo ON" order has been input from user interface.
- Inlet thermistor has abnormality and other circuit is in alarm.

Restart conditions after forced thermo off

After FORCING thermo off, AND below conditions are met, the compressor can be restarted.

Start conditions:

- Re-start prevention timer has been counted down.
- Outlet setpoint + restart conditions x 2 is \leq current outlet water temperature (cooling).
- Outlet setpoint - restart conditions x 2 is \geq current outlet water temperature (heating).

Restart condition: restart condition in differential value programmed in the service/thermostat menu.

2 : differential expansion constant changeable 1 ~ 4 programmed in the service/thermostat menu.

Forced thermo-off conditions

- Outlet water temperature below FREEZE UP DIS setpoint forcing thermo-off.
- Refrigerant temperature below REFR TEMP setpoint forcing thermo off.

Startup sequence

The unit startup sequence is described in the following schematic overview.

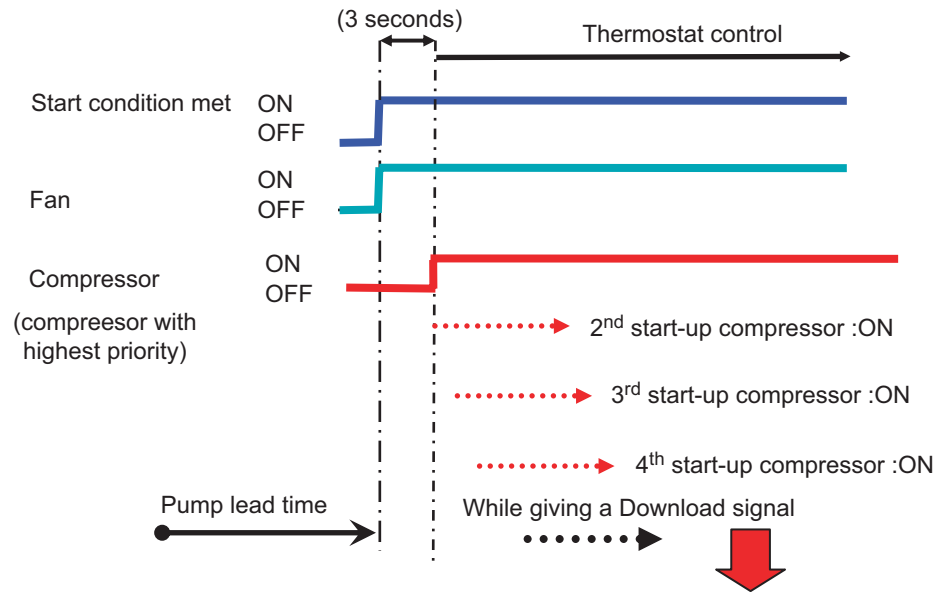

- If there is a Download signal, turn off the designated compressor after duration of “Compressor minimum running time”.
- If only the first compressor is running, after duration of the “Compressor minimum running time” Thermo-OFF.

Remote cooling or heating

Only applicable on heat pump units.

This function allows switching from cooling to heating mode through a remote switch connected to one of the digital inputs.

For details about the possible settings of the digital inputs refer to the chapters about the changeable digital inputs and the service menu.

Dual setpoint

This function allows switching between two set-points, with a switch.

The actual setpoint can also be influenced by the floating setpoint function.

The set-points can be set in the according menu, refer to the chapter about the set-points menu.

For details about the possible settings of the digital inputs refer to the chapters about the changeable digital inputs and the service menu.

3.5 Manual Control

Introduction

Only available on standalone unit or in disconnected mode. This function must only be used for testing of the unit, e.g. during commissioning or trouble shooting.

Description

This function allows setting the compressors & fans to fixed capacity steps, without thermostat control. In manual mode freeze-up prevention, defrost, high pressure setback and low noise operation are not active.

In manual mode the load-up and load-down timers are not active.

Manual mode versus thermostat mode

The following table shows the difference between manual and automatic mode:

If...	Then there is...
Manual capacity control (=fixed capacity step control)	<ul style="list-style-type: none"> ■ No thermostat control, the unit is set to fixed steps manually. ■ No defrost control. ■ No low noise operation. ■ No freeze up prevention. ■ No HP setback.
Thermostat control	An inlet/outlet thermostat control.

When changing from manual to thermostat control all compressors will shut down before operating in thermostat mode.

Manual pump control

In the service menu it is possible to switch on the pump manually, when the unit is off. This makes it possible to check the operation of the pump.

3.6 Compressor Control

Lead Lag control

Introduction

The lead lag control mode determines which circuit/compressor starts up first in case of a capacity demand. It prevents the unit from always starting up the same circuit or compressor.

Possible modes:

- Auto : the controller decides which compressor starts first.
- Priority : the user can select the sequence of the compressor starts (fixed)

Remark : the different modes can be selected in the user/compressor menu.

Lead Lag in Auto Mode

When the lead lag control is done automatically, the software calculates the differences in operation time between the compressors.

Start up priority in Auto Mode

At first, power on:

Start up priority compressor : cir 1-1 -> cir 2-1* -> cir 1-2 -> cir 2-2 *

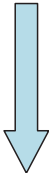
Sequence	Status	Start-up priority
	0 compressors running	Compressor with least running hours
	1 compressor running	Compressor with least running hours of the other circuit
	2 compressors running*	Compressor with least running hours
	3 compressors running*	Start compressor 4.

Remark : (*) is not applicable for 30hp and 40hp unit.

Reason : There are only 2 compressors (1 circuit) for 30hp and 40hp unit.

Stop priority in Auto Mode

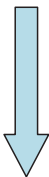
Sequence	Status	Start-up priority
	4 compressors running*	Compressor with most running hours
	3 compressor running*	Compressor with the most running hours of the circuit with two compressors running
	2 compressors running	Compressor with the most running hours
	1 compressors running	Stop compressor.

Remark : (*) is not applicable for 30hp and 40hp unit.

Reason : There are only 2 compressors (1 circuit) for 30hp and 40hp unit.

In case running hours has the same value for several compressors in start/stop priority. Start up priority compressor : cir1-1 -> cir 2-1* -> cir1-2 -> cir2-2* (stop priority is opposite).

Capacity Limitation

This function allows you to limit the capacity of the chiller. Depending on the adjusted mode, it is possible to control the capacity limitation via remote digital input or software.

The limitation setting can be set in the user/compressor menu. In manual mode this function is not active.

■ **Changeable digital input**

To activate the remote digital input mode, program one of the changeable digital inputs to “CAP. LIMIT SET” in the service. Input output menu and connect the limitation switch to the right remote digital input terminal.

When a changeable digital input is programmed, the compressor capacity limit mode can be programmed as CHANG. DIG. INP and the limitation can be entered.

Remark : when no changeable digital input is programmed as CAP. LIMIT SET, no limitation can be set (not displayed on the screen).

■ **Limit Setting**

To activate the limit setting function, the compressor capacity limit mode can be programmed as LIMIT SETTING and the limitations can be entered.

■ **Limit 50%**

To activate the Limit 50% function, the compressor capacity limit mode can be programmed as LIMIT 50% and the unit will be limit to 50% capacity.

Re start prevention timers

Introduction

Delay timers are implemented to prevent the compressor from restarting after a shutdown. Three different timers are present.

- **Guard timer:**
Delay timer to prevent compressor from restarting after a shutdown (default 3 minutes). Only if AREC timer is already on 0s.
- **Anti recycling timer:**
AREC timer is used to limit the starts per hour, means counting after starting the compressor. For scroll compressor the default value is 5 min.
- **Minimum running time:**
Delay timer to prevent switching off compressor after start-up. During the countdown the compressor will not be switched off by the thermostat function.

Functional description

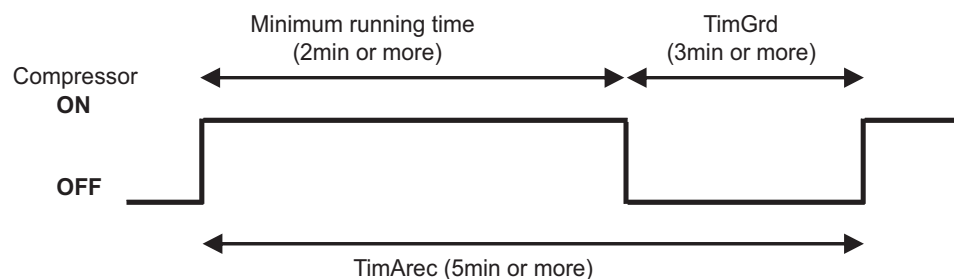

Compressor’s minimum running time has to be larger than or equal to 2 min. However, stop immediately at unit stop (On/off button pushed when unit is on)

OR

Forced thermo OFF (Freeze-up prevention, low pressure protection etc.)

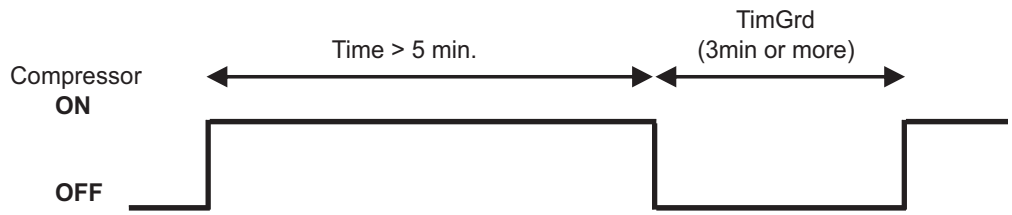

Extension of restart prevention timer

During restart after FORCED Thermo OFF due to anti-freeze by refrigerant gas temperature or leaving water, the restart compressor timer value (REF GRD EXTEND) is 12 minutes (default).

This “REF GRD EXTEND” value can be changed in the service/safety menu.

Protection control of compressor running area during heating

Introduction

When the compressor is operating in heating mode, a compressor protection function will avoid that the compressor works out of operation area.

Function

When two compressors are in operation of this circuit:

- If activation condition 1 or 2 is satisfied for 120 seconds:

Reduce 1 compressor immediately.

When 1 compressor is in operation of this circuit

- If activation condition 1 or 2 is satisfied for 300 seconds:

Switch off this circuit immediately (thermo off).

Activation conditions

Activation conditions

1 $T_e < T_c + c$ ($c = -67^\circ\text{C}$)

OR

2 $T_e < d$ ($d = -20^\circ\text{C}$)

Te: Evaporating temperature.

Tc: Condensation temperature.

Recovery conditions

In case compressors went from 2 to 1 running compressor: next compressor start-up will be when condition 3 and 4 are satisfied.

3 $T_e > T_c + c + a$ ($a = 4^\circ\text{C}$).

AND

4 $T_e > d + b$ ($b = 4^\circ\text{C}$).

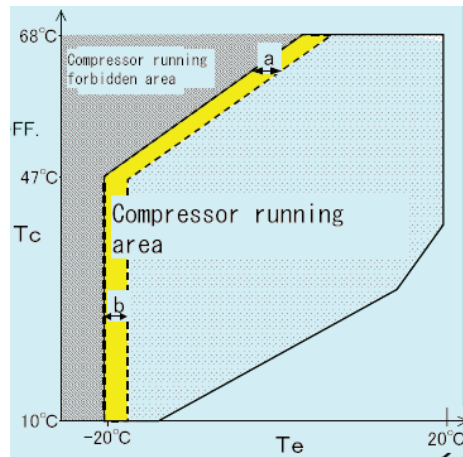

Remark:

- 5 This control is bypassed for 30 seconds at 1st compressor start-up after thermo-OFF.
- 6 During the defrost control, this function is disabled.
- 7 This control is bypassed for 120 seconds after defrost recovery.
- 8 After the recovery condition, compressor guard timer is valid.
- 9 When 1 compressor is running and condition 1 or 2 is met, no load up is allowed during the 300 sec timer (timer busy).

Warning indication

In the Service/Safety menu, the compressor protection warning (COMPR PR Setting) can be enabled or disabled.

- When the warning is enabled.
 - Compressor status will indicate : COMP PR.
 - Warning indication is displayed on the controller.
- When the warning is disabled.
 - Compressor status will indicate: COMP PR.
 - No warning on the controller.

3.7 Fan Control

Purpose

To regulate the high pressure.

There are two different methods used to control the HP.

- Fan control based on ambient control: only at start-up, of each circuit, for the first 70 seconds (default).
- Fan control based on high pressure value, when fan ambient control is finished.

Schematic overview

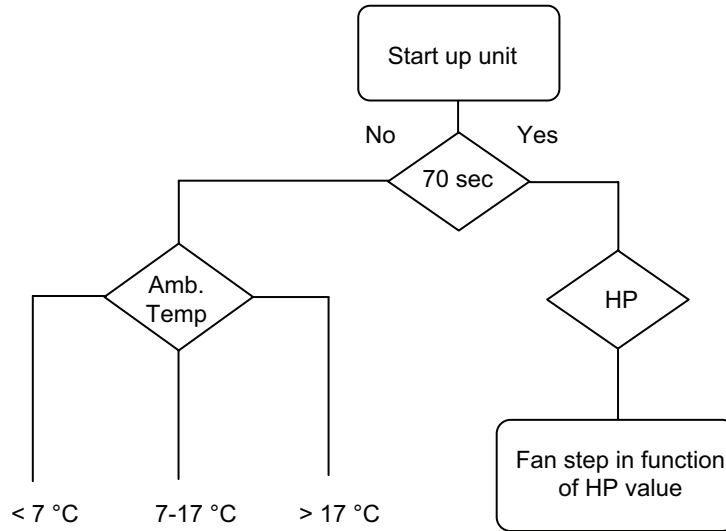

Fan control based on Ambient Temperature with Standard Fans

Ambient based control for standard fans

During the first 70 seconds (default), after startup of a circuit, the fan control is based on the ambient temperature. After this timer the fan control changes to high pressure control, based on high pressure value.

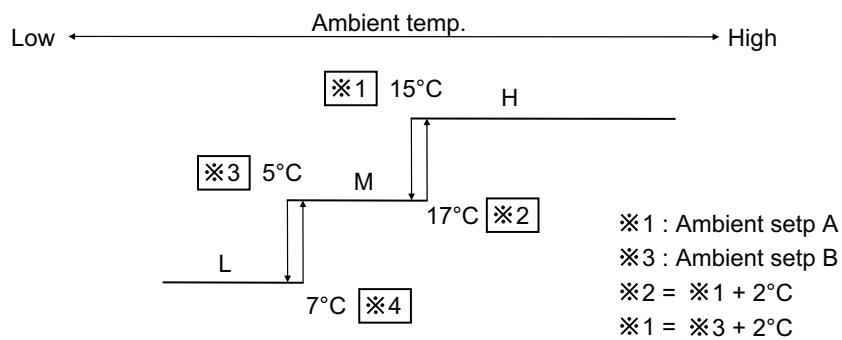

Parameter * 1 and * 3 can be changed in the Service/Fan menu.

Fan control based on high pressure with standard fans

High pressure based control for standard fans.

After the first 70 seconds (default) fan control is based on high pressure value.

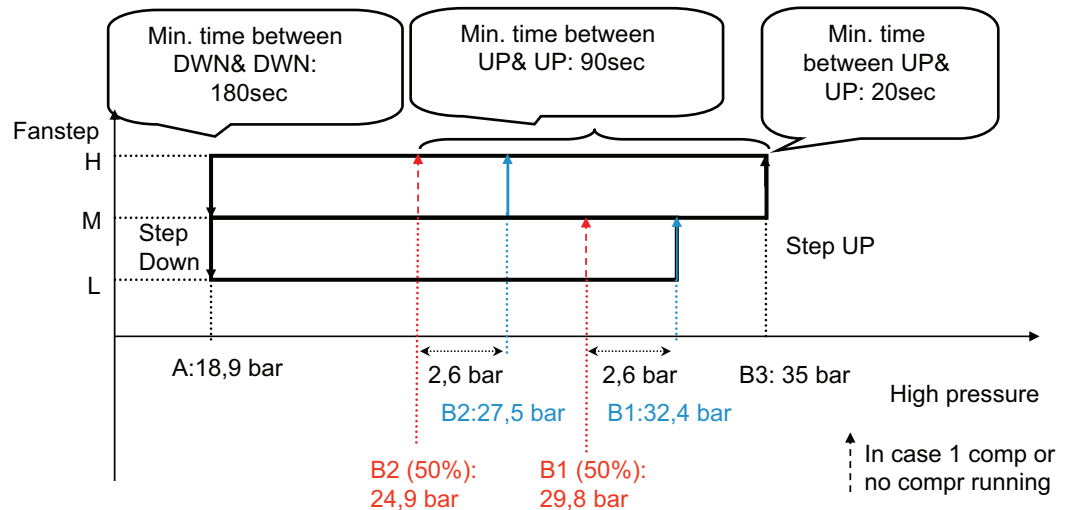

Remark:

There are different switching points for fan up depending if 1 or 2 compressors are running in that circuit.

The parameters for the fan regulation can be changed in the Service/Fan menu.

High pressure control: Fanstep up/down by pressure A/B1/B2

- $HP \leq A$: if below setpoint for 10 sec then 1 fanstep DOWN
- $HP \geq B1$ or $B2$: 1 fanstep UP.
 - Min time for next fan step up 90sec.
 - Min time for next fan down 180 sec
 During these timer no fanstep up or down is allowed.
 - If 1 compressor is running or no compressor running, then:
 - $B1(50\%)=B1-2,6b$ & $B2(50\%)=B2 - 2, 6b$.
 - Extra condition For Fanstep up, Compare present High pressure and High pressure from 30 sec before (memorize and compare with sampling time of 5 sec.), Fanstep up is only allowed if there is a rise of 1,9 bar or more.
 - Extra condition For Fanstep down, Compare present High pressure and High pressure from 30 sec before, Fanstep down is only allowed if there is a drop of 1,9 bar or more.

High pressure control: Fanstep up/down by pressure B3

- (Avoid problem of Fan up decline because of minimum time up condition.)
- $HP \geq B3$. 1 fanstep up.
 - Minimum time between fanstep up (by B1/B2 or B3) and next fan step up (by B3) is 20 sec.

Fan control based on Ambient Temperature with inverter fans

Ambient based control for inverter fans.

During the first 70 seconds (default value), after startup of a circuit, the fan control is based on the ambient temperature. After this timer the fan control changes to high pressure control based on high pressure control.

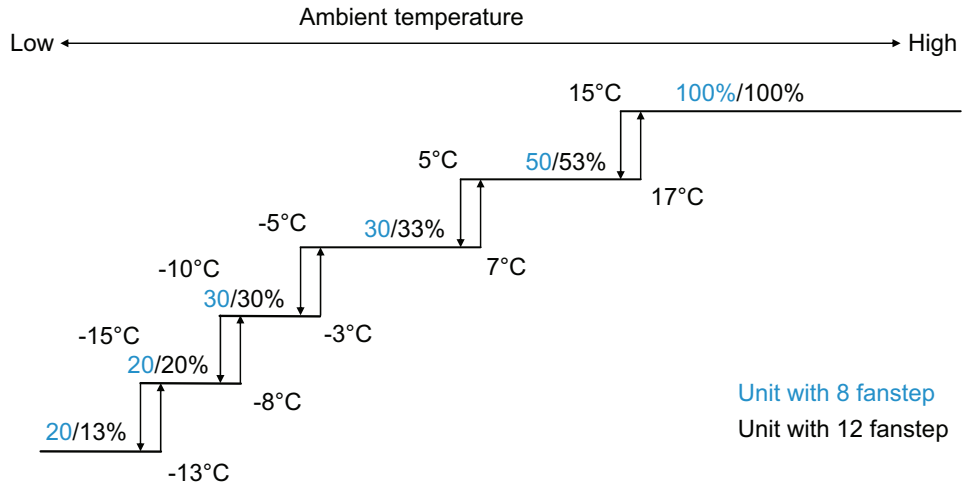

※ 1 : Ambient setpoint A

※ 2 : ※ 1 + 2°C

※ 3: Ambient Setpoint B

※ 4: ※ 3 + 2 °C

Parameter ※ 1 and ※ 3 can be changed in the service/fan menu.

Fan control based on high pressure with inverter fans

High pressure based control for inverter fans.

After the first 70 seconds (default) fan control is based on high pressure value.

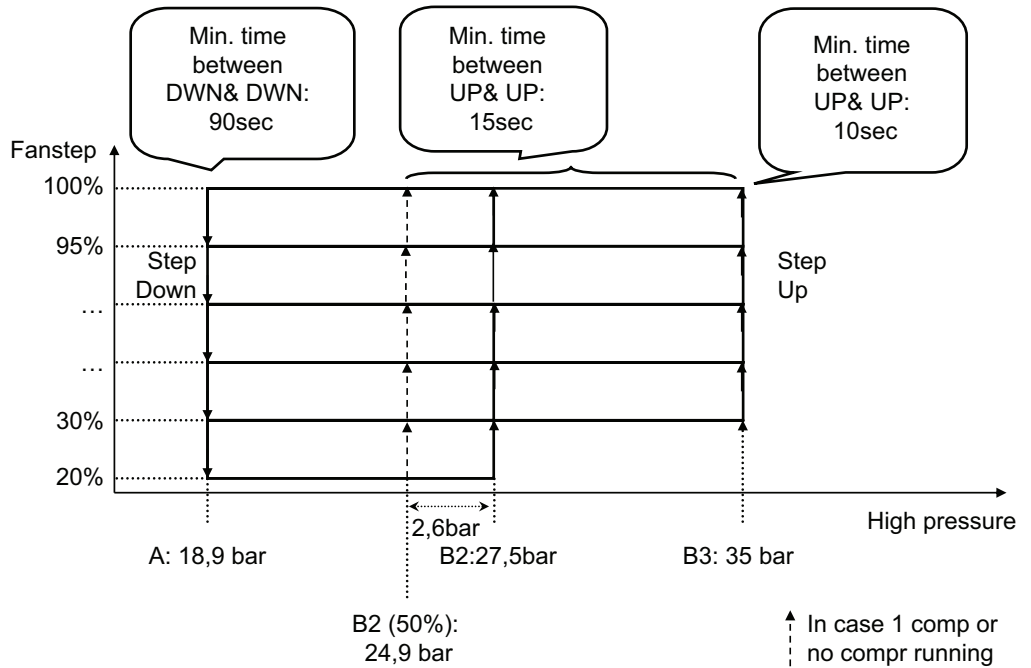

Remark:

There are different switching points for fan up depending if 1 or 2 compressors are running in that circuit.

The parameters for the fan regulation can be changed in the Service/Fan menu.

High pressure control: Fanstep up/down by pressure A/B1/B2

- $HP \leq A$: if below setpoint for 10 sec then 1 fanstep DOWN
 - $HP \geq B1$ or $B2$: 1 fanstep UP.
 - Min time for next fan step up 15sec.
 - Min time for next fan down 90sec.
- During these timer no fanstep up or down is allowed.
- If 1 compressor is running or no compressor running, then:
 $B1(50\%)=B1-2,6b$ & $B2(50\%)=B2 - 2, 6b$.
- Extra condition For Fanstep up, Compare present High pressure and High pressure from 30 sec before (memorize and compare with sampling time of 5 sec.), Fanstep up is only allowed if there is a rise of 1,9 bar or more.
- Extra condition For Fanstep down, Compare present High pressure and High pressure from 30 sec before, Fanstep down is only allowed if there is a drop of 1,9 bar or more.

High pressure control: Fanstep up/down by pressure B3

- (Avoid problem of Fan up decline because of minimum time up condition.)
- $HP \geq B3$. 1 fanstep up.
 - Minimum time between fanstep up (by B1/B2 or B3) and next fan step up (by B3) is 10 sec.

Low noise mode with inverter fans

Low noise is only possible when inverter fans are installed.

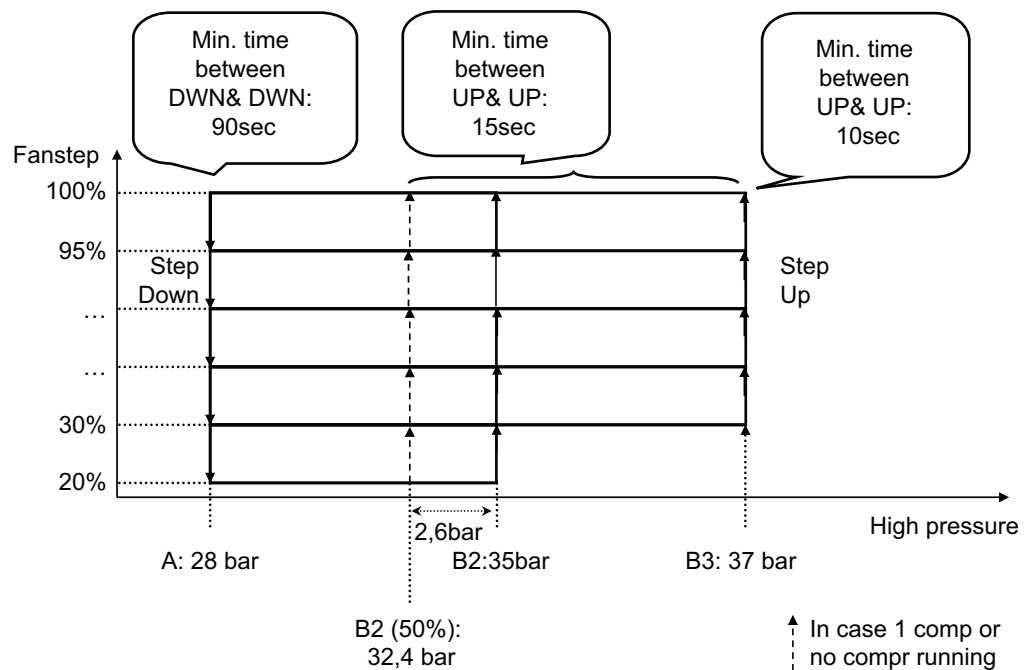

The fan control in low noise mode is the same as standard inverter control. Only the setpoints A/B2/B3 are different (higher value). These parameters can be changed in the service/fan menu.

This function can be activated by a changeable input or a daily schedule.

Example of low noise operation with daily schedule.

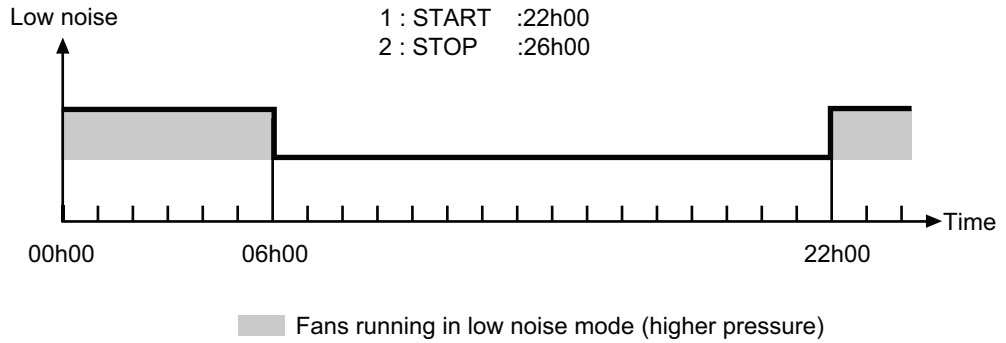

Anti hunting control

When the fanstep modifies with ± one fanstep and it becomes again the same fanstep within 720 seconds, then :

- the B3 = 35 bar condition is required for the next fanstep up (Reason: Pressure differential bigger than estimated).
Anti-hunting will prevent frequently switching between two fan steps.

Reset anti-hunting control.

Anti-hunting control will be reset (normal fan control) if one of the following conditions is fulfilled:

- unit stop/ Thermo OFF
- 1,5 hour after start of anti-hunting control.
- outlet water temperature rise: +2°C or more (HP rise due to LP rise).
- Ambient temperature rise : 1 comp step up (HP rise due to load rise).
- Comp step drop : 1 compr step down (Deferential drop due to load drop).
- Example :

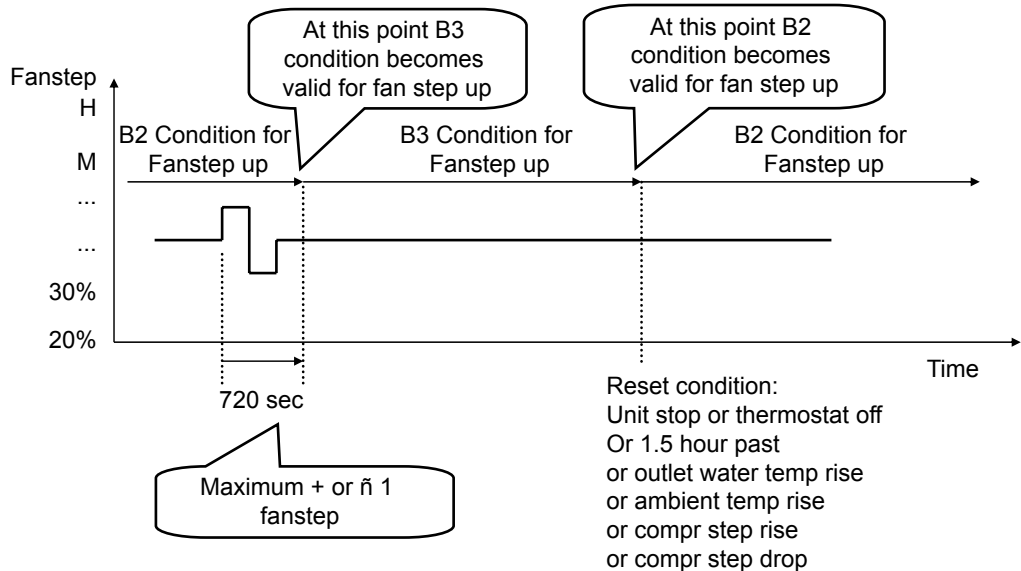

Pressure difference surveillance control

The fan control will make a fan step down if the compression ratio of a circuit is too low, this to create a bigger compression ratio.

Make a fanstep down in case of below condition.

$$1.6 \geq (\text{Compression ratio (HP+1.92)} / (\text{LP+1.92})) : \text{For 30 sec or more.}$$

Also in this case the minimum time between fanstep down and next fanstep down of 180sec is valid. This would mean that after the 180sec the ratio is compared with the ratio with 30 sec before.

2

When a fanstep down is executed by the pressure diff surveillance control, then fanstep up is not allowed unless one of following conditions is met:

- Unit stop/Thermo off
- 1.5 hr after start of this forbidden area.
- Water temp. drop : -2°C (bigger pressure difference due to LP drop).
- Rise of outdoor temp.: +3 °C or more (bigger pressure difference due to HP rise).

Fan control in heating mode

Fan management : heating mode

- Fanstep = 100 % (step)
- Fanstep = 100 % (inverter fans)

Fan output for inverter fans

Fanstep output for 50-60Hp units

Fanstep		K13F K23F	K14F K24F
	%		
8	100	50Hz	ON
7	95	45Hz	ON
6	80	30Hz	ON
5	70	20Hz	ON
4	50	50Hz	OFF
3	45	45Hz	OFF
2	30	30Hz	OFF
1	20	20Hz	OFF

Changeover on/off fan & Fan inv

Fanstep output for 70-80Hp units

Fanstep		K14F K24F	K13F K23F	K15F K25F
	%			
12	100	ON	50 Hz	ON
11	96	ON	45 Hz	ON
10	86	ON	30 Hz	ON
9	79	ON	20 Hz	ON
8	66	ON	50 Hz	OFF
7	63	ON	45 Hz	OFF
6	53	ON	30 Hz	OFF
5	46	ON	20 Hz	OFF
4	33	OFF	50 Hz	OFF
3	30	OFF	45 Hz	OFF
2	20	OFF	30 Hz	OFF
1	13	OFF	20 Hz	OFF

Changeover on/off fan & Fan inv

Changeover on/off fan & Fan inv

Fanstep output for 30-40 Hp and 90-100 Hp units. Circuit 2 is not present with 30-40Hp units.

Fanstep		K13F K23F	K14F K24F	K15F K25F	K16F K26F
	%				
8	100	50 Hz	ON	50 Hz	ON
7	95	45 Hz	ON	45 Hz	ON
6	80	30 Hz	ON	30 Hz	ON
5	70	20 Hz	ON	20 Hz	ON
4	50	50 Hz	OFF	50 Hz	OFF
3	45	45 Hz	OFF	45 Hz	OFF
2	30	30 Hz	OFF	30 Hz	OFF
1	20	20 Hz	OFF	20 Hz	OFF

Changeover
on/off fan &
Fan inv

2

3.7.1 High pressure setback

Description

This is a safety prevention function, when high pressure is near to the high pressure switch setpoint. The unit will load-down one compressor to prevent that the unit trips on high pressure switch.

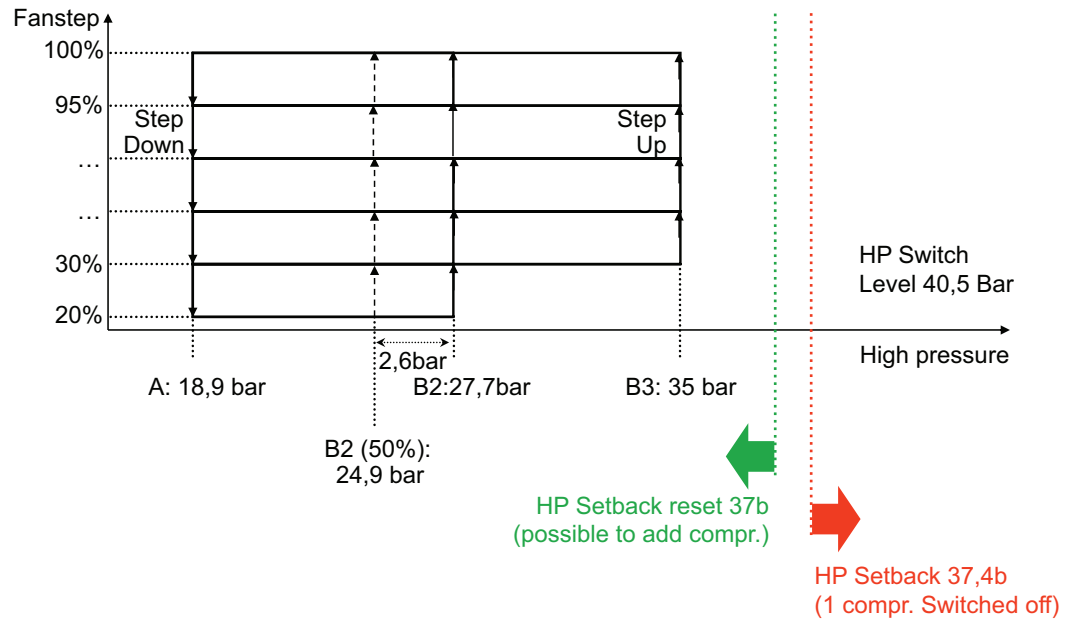

3.8 Pump Control

Introduction

To prevent the chiller to start up without flow, safety checks are performed.

First there is a check to make sure that water flows through the system.

If a second evaporator pump is installed a second safety check is performed: the double evaporator pump control, in case of failure of one pump the other one takes over.

Another advantage of this control is the fact that the system switches from one pump to the other in case failure during operation.

Pump lead/lag time

The PUMPCONTROL of the user settings menu allows the user to define the pump-lead time and pump-lag time.

Daily pump startup

The user will get the choice to perform a pump start every day to prevent obstruction of the pump and to increase its lifetime. Everyday at pump start time, which can be set in the user/pump menu, the pump will be started automatically for a short period (5s) if the unit is off.

If dual pump control is selected by changeable digital output, then it is also possible to start up this pump in the service/pump menu.

Dual evaporator pump control

When dual pump control is allowed an extra digital output is needed (see Service Menu). In total four choices will be possible: one pump (default), two pumps with automatic rotation (by running hours and with a certain offset), priority pump 1 and priority pump 2.

When the dual evaporator pump control is set in automatic rotation, the software calculates the differences in operation time between the two pumps. When this time exceeds the chosen offset time, the pump will shut down and the other pump will start up, during this the unit keeps running. The switchover will happen immediately, there is no transition time.

Remark: In case two pumps are present and the running pump fails then the unit is stopped and started up again with the other pump. When the first pump fails a visible warning will be given. The failed pump can not start up before this warning is reset. If the running pump fails while the other pump is already in warning a unit alarm will be given.

3.9 Floating Setpoint

3.9.1 Floating Setpoint - Ambient Mode

Introduction

The ambient mode can be used to modify the setpoint in function of the ambient temperature. The user is able to choose to use the floating setpoint or not. The result of using the ambient mode is that the unit will be used more efficiently and that the modified setpoint will be displayed under the normal setpoint. The floating setpoint parameters and function can be set in the user floating setpoint settings menu.

Function description

Example ambient = 17.5°C

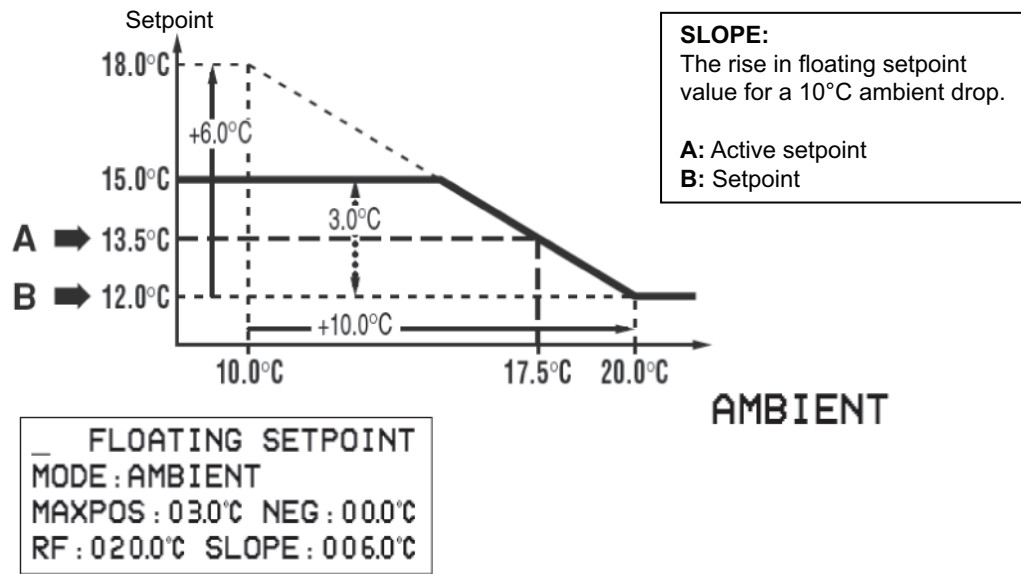

Explanation

When in cooling mode the load of the unit drops (by drop in outdoor temperature), then the setpoint will be changed upwards by the floating setpoint value. Because of this the unit will evaporate at a higher temperature and thus the performance of the unit will be better.

Remark: When you use the floating setpoint, the value of the setpoint on the readout and set point menu can be different. The readout screen will show the calculated value and the setpoint screen the set value.

3.9.2 Floating Setpoint - changeable analogue input slope NTC

Introduction

The CH. AI SLOPE NTC mode can be used to modify the setpoint in function of the NTC sensor which is connected to a changeable analogue input (and programmed) the user is able to choose to use the floating setpoint or not. The result of using the CH. AI. SLOPE NTC mode is that the unit will change setpoint according to the measured temperature. The floating setpoint parameters and functions can be set in the user/floating setpoint menu.

Functional description

Example temperature = 17.5°C

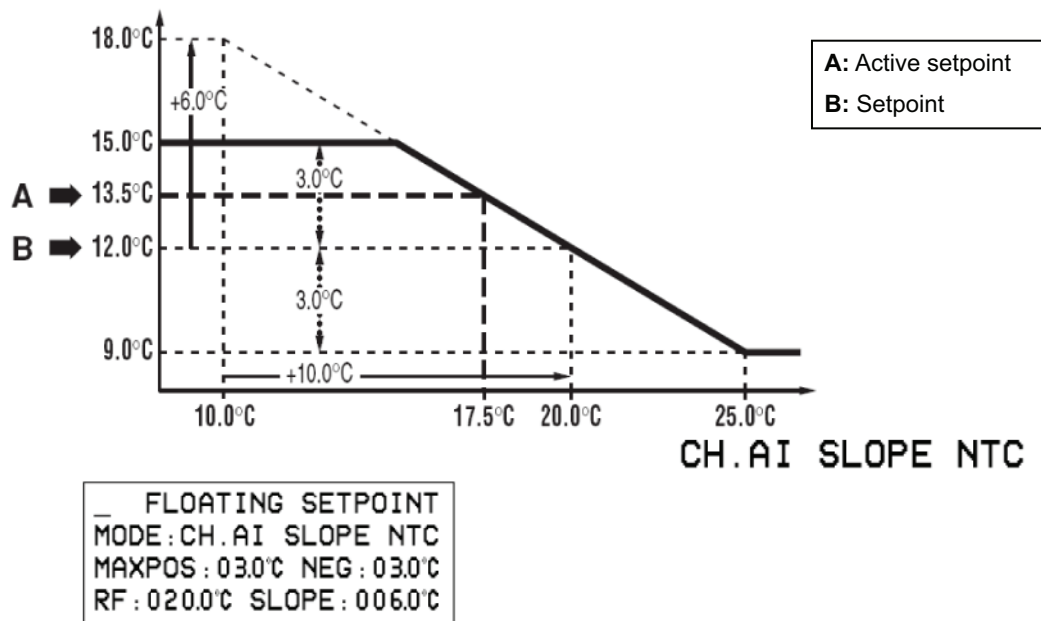

Explanation

When the temperature measured with the NTC sensor is 20 °C (reference), then the original setpoint will be used. When the measured temperature rises, the active setpoint will change downwards. When the measured temperature drops, the active setpoint will change upwards.

Remark: when you use the floating setpoint, the value of the setpoint on the readout and setpoint menu can be different. The readout screen will show the calculated value and the setpoint screen the set table.

3.9.3 Floating Setpoint - AI SLOPE V-A

Introduction

The AI SLOPE V-A mode can be used to modify the setpoint in function of an external voltage or current (mA) signal connected to a changeable analogue input (and programmed). The user is able to choose to use the floating setpoint or not. The result of using the CH.AI. SLOPE V-A mode is that the unit will change setpoint according to the external signal. The floating setpoint parameters and functions can be set in the user/floating setpoint menu.

Functional Description

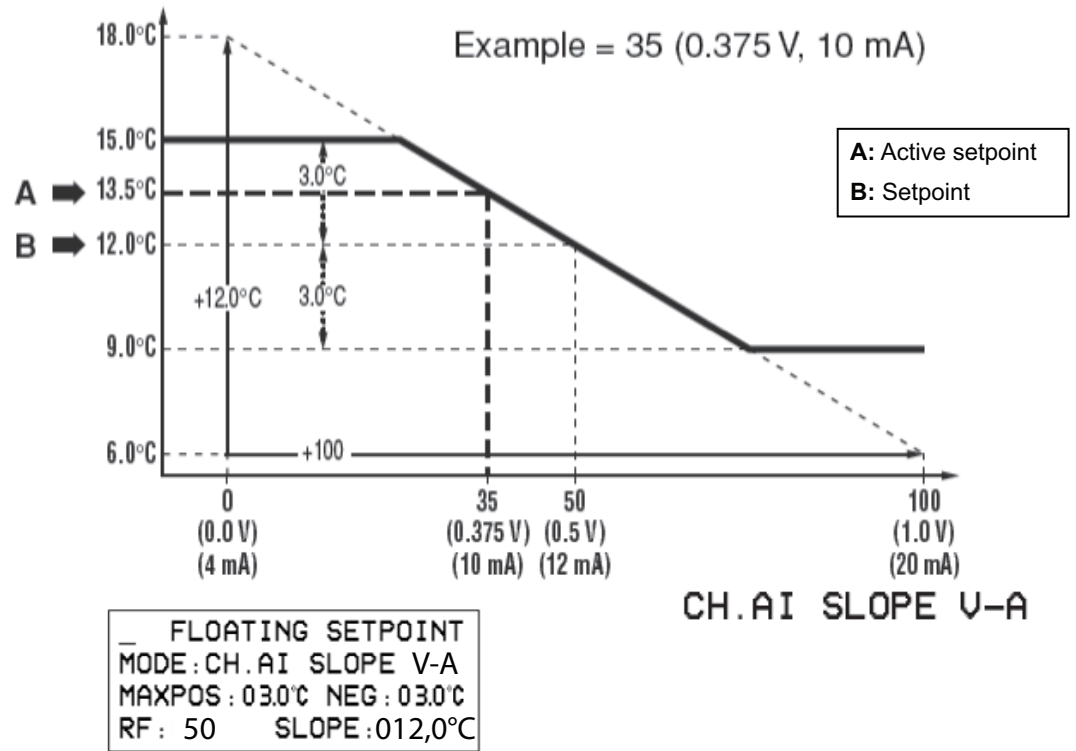

Explanation

When the external signal is 50% of the maximum signal value (reference), then the original setpoint will be used. When the external signal value rises, the active setpoint will change downwards. When the external signal value drops, the active setpoint will change upwards.

With the MAXPOS and NEG values the maximum and minimum limit of the active setpoint is specified.

Remark : When you use the floating setpoint, the value of the setpoint on the readout and setpoint menu can be different. The readout screen will show the calculated value and the setpoint screen set value.

3.9.4 Floating setpoint - CH AI MAX VALUE

Introduction

The CH AI MAX VALUE mode can be used to modify the setpoint in function of an external signal. The user is able to choose to use the floating setpoint or not. The result of using the CH AI MAX VALUE mode is that the unit will change setpoint according to the external signal. The floating setpoint parameter and functions can be set in the user/floating setpoint menu.

Functional description

Example = 50 (0.5 V, 12 mA)

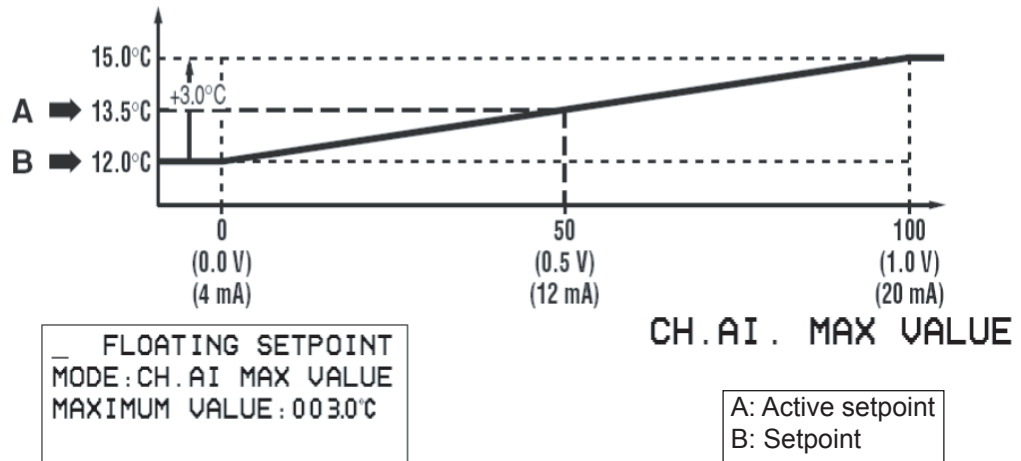

Explanation

When the external signal is at maximum value, the actual setpoint will be the setpoint plus the maximum value. When the external signal is at minimum value, the actual setpoint will be equal to the setpoint. Between the minimum and maximum external signal, the actual setpoint will change according to the signal.

Remark : when you use the floating setpoint, the value of the setpoint on the readout and setpoint menu can be different. The readout screen will show the calculated value and the setpoint screen the set value.

3.10 Free Cooling

Introduction

When ambient temperature is low, cool water can be made easily by direct heat exchange with ambient air. Free cooling can work on ambient or difference between inlet water temperature and ambient temperature.

When free cooling is activated a 3 way valve will be closed.

Free cooling can only be used if the changeable digital output "free cooling" is selected in the service Input/Output menu.

Free cooling function is only active if unit is on.

It is possible to work with indirect or direct free cooling on ambient temperature.

With indirect free cooling the water of the load circulates through a separate heat exchanger instead of through the chiller. A second water circuit circulates through the other side of that heat exchanger. In direct free cooling it is the water from the load that is directly cooled by the ambient air.

3.10.1 Free cooling on Ambient Temperature

Indirect and direct free cooling

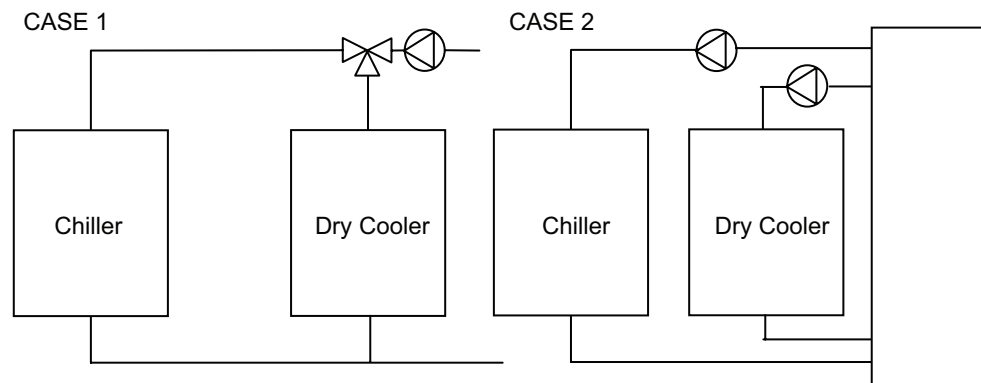

Free cooling on ambient :

- When free cooling becomes active, turn off compressors and close DI to e.g. energize 3 way valve (case 1) or pump (case 2) to dry cooler.
- When deactivation of free cooling, there is a lead timer to startup the compressors (as to give 3 way valve time to de-energize and go to chiller).
- When Free cooling is active, it is possible to select if the pump contact must be closed or open (case 1 : closed / case 2 : open).

Functional description

Depending on the settings and according to the function below free cooling is requested or not.

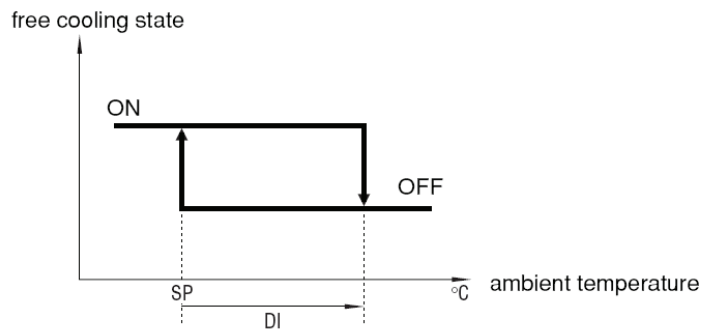

Free cooling	default	minimum	maximum
SP (°C)	5.0°C	-30.0°C	25.0°C
DI (°C)	1.0°C	1.0°C	5.0°C

Free cooling on ambient:

- When free cooling is active, turn off compressors.
- When deactivation of free cooling, there is a lead timer to startup the compressors.
- When free cooling is active, it is possible to select if the pump contact must be closed or open.

3.10.2 Free cooling on inlet evaporator - ambient

Functional description

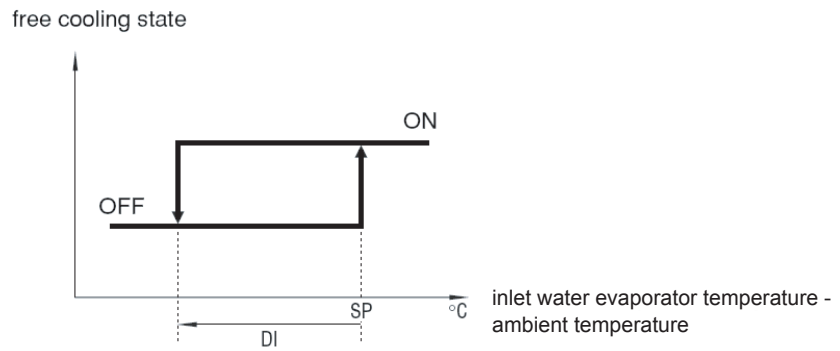

Free cooling		default	minimum	maximum
SP	(°C)	5.0°C	1.0°C	20.0°C
DI	(°C)	5.0°C	1.0°C	10.0°C

Free cooling on difference between inlet and ambient temperature

- Compressors are not turned off (also no lead timer).
- Pump contact always on.

3.10.3 Free cooling on changeable digital input

**Free cooling on
CHANG. DIG.INP**

- When free cooling is active, turn off compressors
 - When deactivation of free cooling, there is a lead timer to startup the compressors.
 - When free cooling is active, it is possible to select if the pump contact must be closed or open.
-

3.11 Superheat control

Introduction

Electronic expansion values are used to control the superheat. Depending from the unit and model 1 or 3 expansion values are used per circuit.

- EWAQ BO-150 DAYN(N-P-B): one condenser coil per circuit and one electronic expansion value per circuit
 EWYQ 130-150 DAYN(N-P-B): one condenser coil per circuit and two electronic expansion valve per circuit.
 One for cooling and one for heating mode.
- EWAQ080-100-180-210-240-260 DAYN(N-P-B):
 two condenser coils per circuit and one electronic expansion valve per circuit.
- EWYQ080-100-180-210-240-250DAYN(N-P-B):
 two condenser coils per circuit and three electronic expansion valves per circuit. One in cooling mode and two in heating mode.

Example: piping principal for EWY080-100-180-210-240-250 DAYN(N-P-B) in cooling mode.

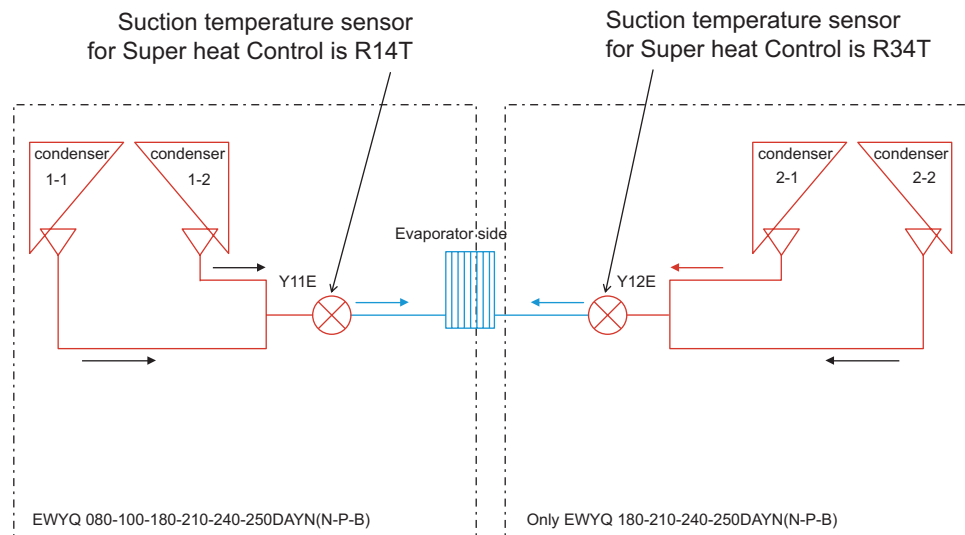

2

Example : piping principle for EWYQ080-100-180-210-240-250 DAYN(N-P-B) in heating mode.
 (WYQ080-100-180-210-240-250 DAYN(N-P-B); only EWYQ180-210-240-250 DAYN(N-P-B).

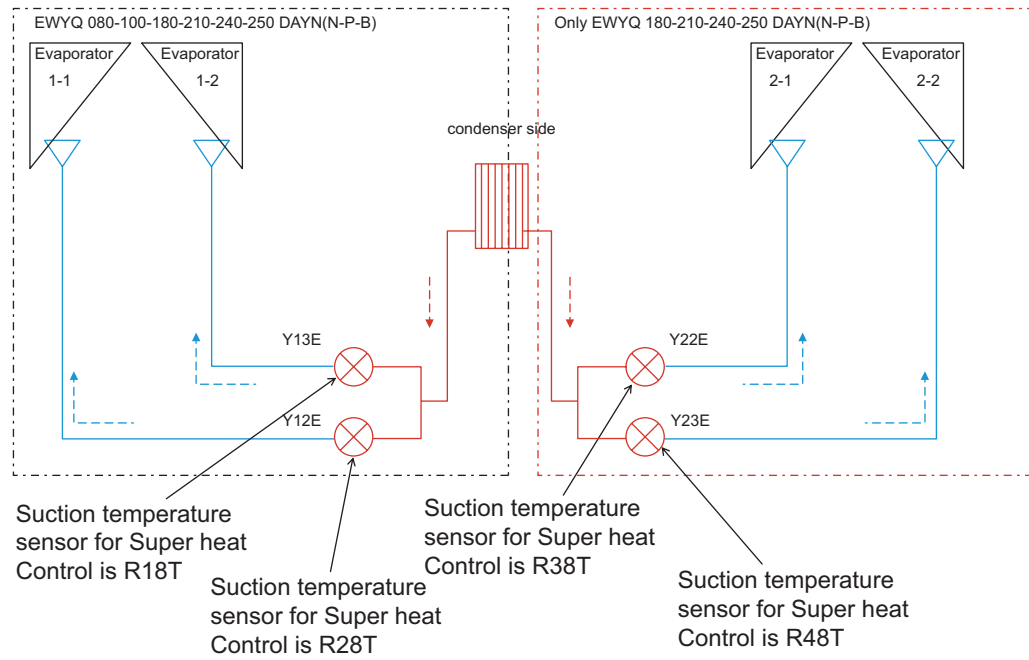

Remark: only during heating mode, two expansive valves are used per circuit. For the prevention of air heat exchanger drift during heating mode, each air heat exchanger does individual suction SH control.

Variable control condition

The electronic expansion valve control is done by a variable control. The suction superheat value will be changed according to the discharge superheat. This between the upper and lower limit specified in the controller. Same superheat control in cooling and heating mode, however other limit values are used.

	Variable control condition	
a	If Discharge SH < 20°C, continuous for 3 minutes. Raise the target suction SH with 0.5°	Judge when 1 compressor is satisfied (Reset the timer then).
b	If discharge SH > C, continuous for 3 minutes. Drop the target suction SH with 0.5°	Judge when 1 compressor is satisfied (Reset the timer then).

If a and b conditions are both satisfied at the same time give priority to control a

(Discharge SH = Discharge thermistor temperature - Saturated gas temperature for high pressure)

Additional EVV Functions

- Adjust cool/heat function

After initializing process, if compressor starts up in cooling or heating mode, it goes to the specified output (service/EEV menu) for electronic expansion value. After reaching the ADJUST COOL/ADJUST HEAT EV Opening, it will go to normal superheat control.

Low ambient condition function

- Low ambient condition.

After initializing process, if the compressor starts up in heating mode and the ambient temperature is below the COOL or HEAT AMB. CONST setpoint, it goes to the specified output for the electronic expansion valve. After reaching above ADJUST COOL/HEAT EV opening, it will go to normal superheat control.

FF control on comp. capacity

Feed forward control for compressor loading/unloading. If the compressor load goes up or down, the controller will change (open/close) the electronic expansion valve opening. Different values are used in cooling or heating mode.

FF control or ambient

Feed forward control on low ambient.

If the compressor load goes up or down AND the ambient temperature is below the COOL/HEAT AMB. CONST setpoint, the controller will change the EEV opening.

Fan down/up control

When the fan stage changes:

- drastic change of high pressure will happen
- drastic shortage/Excess of capacity for expansion valve occurs.

Therefore, an adjustment of the electric expansion valve opening will be done.

Low pressure control

EVV low pressure control: when the LP drops below the setpoint, additional pulses will be given to the electronic expansion valve to prevent that the circuit trips on LP safety.

3.12 Changeable digital inputs

Introduction

4 changeable digital inputs are available and can be assigned to 12 different functions in the service menu.

Functions overview

Possible settings for changeable digital inputs.

- When NONE is selected
 - No function is allocated to this changeable input.
- When STATUS is selected:
 - In the I/O menu the status of Changeable input (connected switch) can be displayed (open/closed).
- When DUAL SETPOINT is selected:
 - A digital input (voltage free contact) can be used to switch between 2 specified setpoints.
 - Open contact --> Setpoint 1.
- When REMOTE ON/OFF is selected:
 - A digital input (voltage free contact) can be used to switch the unit ON and OFF.
 - Closed contact --> chiller ON.
 - Remote ON/OFF has priority on "unit ON/OFF password" (no password needed when Remote on/off is selected)
- When FAN FORCED ON is selected :
 - A digital input (voltage free contact) van be used to switch on the fans of the unit (by use of changeable input).
- When CAP. LIMIT 25% / 50% / 75 % / SET is selected :
 - A digital input (voltage free contact) can be used to limit the maximum capacity of the unit.

	30-40 HP	50-100 HP	Remarks
Lim 25	-	25%	1 comp is running
Lim 50	50%	50%	2 comps running
Lim 75	-	75%	3 comps running
Lim SET	User can select number of compressors running		

- In case Limit Set mode is selected, each compressor must be defined (C11/C12/C21/C22).
 - OFF: These compressors will always be switched off
 - ON : These compressors will still be used by the thermostat according to the required load.
- When LOW NOISE is selected : (only if OPIF is installed)
 - A digital input (voltage free contact) can be used to switch on the Low noise mode.
- When FREE COOLING REQ is selected:
 - A digital input (voltage free contact) can be used to switch on the Free cooling mode.



3.13 Changeable digital outputs

Introduction	6 changeable digital outputs are available and can be assigned to 20 different functions in the service menu.
Function overview	<p>Possible settings for changeable digital outputs</p> <ul style="list-style-type: none"> ■ When NONE (OPEN) is selected: -The digital output will open. ■ When Close is selected: - The digital output will close. ■ When 2ND PUMP is selected: - The digital output will indicate (close) the status of the second pump. ■ When 100% capacity is selected: - The digital output will indicate (close) when the unit is working at 100 percent capacity. ■ When FULL CAPACITY is selected: - The digital output will indicate (close) when the unit is working at maximum capacity, example reached 100% capacity or reached maximum capacity because of safety limitation. ■ When FREE COOLING is selected: - The digital output will close when the free cooling mode is active. ■ When GENERAL OPERATION is selected: -The digital output will indicate (close) when the unit is active. ■ When SAFETY+W(NO) is selected -The digital output will indicate (close) when a safety or warning is active. (Normal open contact) ■ When SAFETY+W(NC) is selected: -The digital output will indicate (close) when a safety or warning is active. (normal closed contact) ■ When SAFETY (NO) is selected: - The digital output will indicate (close) when a safety is active (normal open contact). ■ When SAFETY (NC) is selected: -The digital output will indicate (close) when a safety is active (normal closed contact). ■ When C1 or C2 SAFETY is selected: -The digital output will indicate (close) when a safety is active for the specified circuit. ■ When WARNING is selected: -The digital output will indicate (close) when a warning is active. ■ When C1 or C2 OPERATION is selected: - The digital output will indicate (close) when the specified circuit is active. ■ When COOLING or HEATING or DEFROST is selected: - The digital output will indicate (close) when the unit is in Cooling/Heating or Defrost. ■ When 0% CAPACITY is selected: -The digital output will indicate (close) when the unit capacity is 0%

3.14 Changeable analogue inputs

Introduction

Four changeable analogue inputs are available and can be assigned to four different functions in the service menu.

Function overview

Possible settings for changeable analogue inputs.

- None
 - No status function is allocated to this analogue input.
- Status
 - Displays the analogue input value in the I/O menu.
- Floating Setpoints
 - Select the signal type used for the floating setpoint function.
- Temperature
 - An additional temperature sensor can be connected to the controller and will be displayed in the I/O menu (only NTC type can be selected).

Possible analogue input types:

- 0-20 mA
- 4-20 mA
- 0-1V
- 0-5V
- 0-10V
- NTC Type1
- NTC Type2
- NTC Type3
- NTC Type4

The analogue input can also be programmed as a digital input.

Possible settings analogue inputs:

- Digital inputs
 - DI STATUS
 - DI REM COOL/HEAT
 - DI CAP.LIM 25%/50%/75%
 - DI CAP LIM SET
 - DI FREE COOLING

When a DI signal is selected the AI type will automatically go to DIGITAL INP. Type.
- Remark : The digital input will close when an 5Vdc signal is given to the controller.

3.15 Changeable analogue outputs

Introduction

One analogue output is available and can be assigned to the unit capacity output function.

Function overview

Possible settings analogue outputs:

- None
 - No function is allocated to this analogue input
- Unit capacity
 - Displays the analogue output value in the I/O menu, and give the selected signal on the AO.

Possible analogue output types.

- 0-20mA
 - 4-20mA
 - 0-1V
 - 0-5V
 - 0-10V
-

3.16 DICN Basic Setup (=master/slave system)

A site with units installed in a DICN configuration will operate as one big chiller with different water circuits installed in parallel. We can virtually speak about a DICN unit instead of a site with different chillers.

The DICN-unit can only be controlled via inlet water. DICN can only be used if option kit EKACPG (addresscord) is installed.

Up wiring

Connection and setup of a DICN system (option kit EKACPG)

For a system with chillers in a DICN configuration, the chillers have to be connected as shown in the figure below.

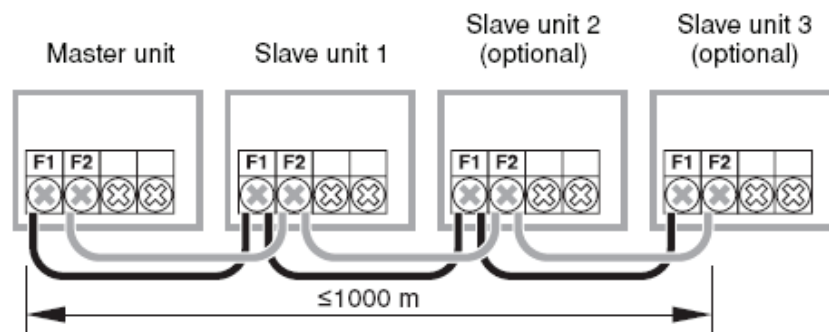

Make the F1/F2 connection for DIII communication using a 0.75~1.25 mm² 2-wire cable (maximum of 1000 m from start to end).

For units in a DICN configuration, be sure to provide every chiller with its own flow switch, and be sure to interlock with the pump that is serving the chiller.

Addresses in DICN Setup

The addresses of the unit (pcb, EEV driver, controller) don't change when the units are used as standalone or in a DICN system.

DICN (network): Overview

Introduction

DICN = Daikin Integrated Chiller Network
Also referred to as master-slave system.

Remark: In a DICN system (Master-Slave), all the PCASO-controllers must have the same software, bios, and boot version!

Function description

To activate the DICN function MS Option must be set to "Yes" in the Service/DICN menu. In the user settings menu of the master it must also be specified how many slave units are connected. When activated, this function will transfer all parameters to the different units through F1/F2 communication line.

In DICN setup (when MS option is yes): the different units can be put in "normal" or "standby" mode or in disconnected ON / OFF mode. When the mode is disconnected the unit selected will operate as standalone units.

Remark: If the master is down (= no power) then a network safety is activated and all units will work as standalone (no parameters are transferred), and they will work with their own setting in the controller.

Overview of possibilities

Basic principles:

- Maximum four units can be combined in one DICN system.
- Possible to combine all EWAQ-DAYN in one DICN.
- Possible to combine all EWYQ-DAYN in one DICN.

Important:

- It is not possible to combine Pco or Pco² and PCASO controllers in one DICN system.
- When the user enters the service menu, the DIII communication stops.
- When the user leaves the service menu, the DIII communication restarts.
- It takes 10 minutes before DIII communication is fully re-established.
If communication fails after 10 minutes, the network safety error message "OU4:PCB COMM. PROBLEM" appears.

DICN thermostat function in cooling

The illustration below shows the thermostat inlet control in cooling mode for a DICN network.

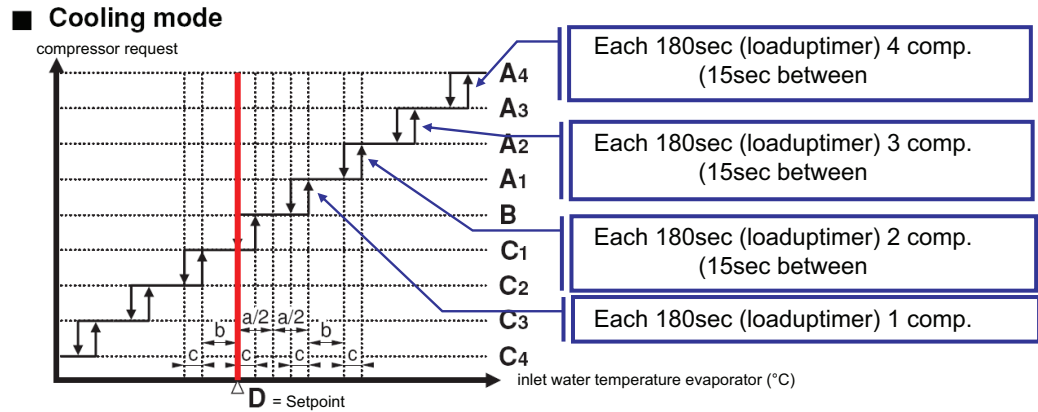

- A1~A4** Load up request of 1~4 compressors
- B** No action
- C1~C4** Load down request of 1~4 compressors
- D** Inlet setpoint

DICN: ONLY INLET CONTROL !!!!!!!!!!!

- Loadup request of 1 compressor: request to add one additional compressor.
- Loadup request of 2 compressors: request to add 2 additional compressors (with interval of 15 seconds in between).
- The maximum number of compressors that can possibly be added in 1 request is limited to the total number of units that are present in the DICN setup.
- Example: A DICN Setup with two units meets load up requests of maximum two compressors at a time.

Default and limit values

Inlet control		Default value	Lower limit	Upper limit
Step difference -a	(K)	4.0(*)	----	----
Step difference -b	(K)	3.6(*)	----	----
Step difference -c	(K)	0.4(*)	----	----
Loadup timer	(sec)	180	15	300
Loaddown timer	(sec)	180	15	300
Setpoint cooling	(°C)	12.0	7.0	23.0
Setpoint heating	(°C)	40.0	20.0	45.0

Practical example:

■ Cooling mode

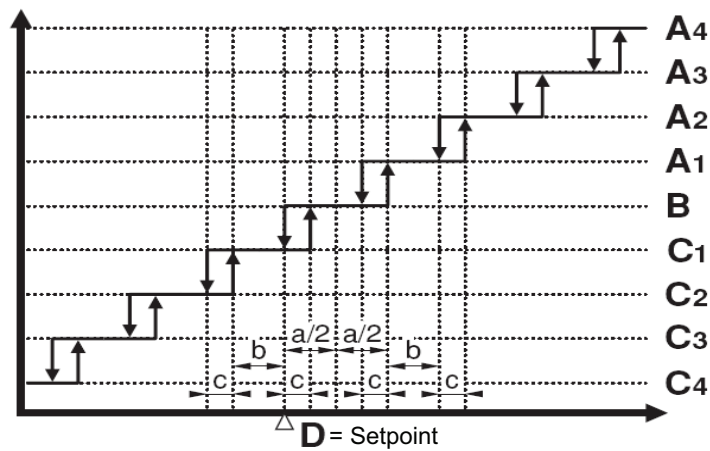

Condition	Result	
If evaporator inlet temperature (Master) --> active inlet setpoint +A	Loadup request A1	Loadup is executed and loadup timer is put on maximum.
If evaporator inlet temperature (Master) --> active inlet setpoint + A +B +C	Loadup request A2	Loadup nr1 is executed and loadup timer is put on maximum. Loadup nr2 is executed and loadup timer - 15 sec.
If evaporator inlet temperature (Master) --> active inlet setpoint + A + 2x(B+C)	Loadup request A3	Loadup nr1 is executed and loadup&loaddown timer is put on maximum. Loadup nr2 is executed at loadup timer - 15 sec Loadup nr3 is executed at loadup timer - 30 sec

DICN Thermostat function in heating

The illustration below shows the thermostat inlet control in heating mode for a DICN network.

■ Heating mode

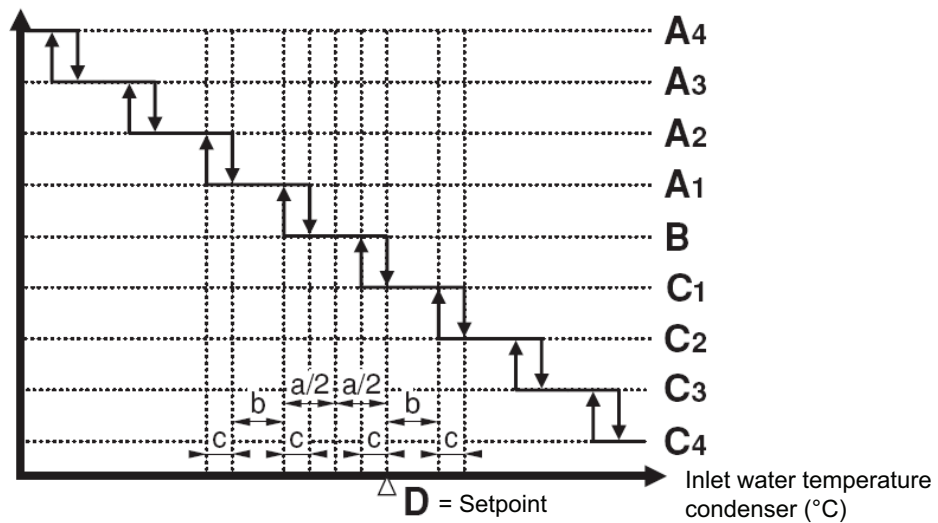

A1 ~A4 Load up request of 1~ 4 compressors

B no action

C1~C4 load down request of 1~ 4 compressors.

D Inlet setpoint.

Remark: The EWYQ080DAYN* has a modified control in heating mode when the ambient temperature is $\leq 5\text{ }^{\circ}\text{C}$.

- If the ambient temperature $\leq 5\text{ }^{\circ}\text{C}$ and the master makes a request to load up a EWYQ080 or EWYQ100 unit, then the 2 compressors of this unit will start up (30 sec between the startup of the first compressor and the second compressor).

Settings on the controller

DICN settings for the PCASO controller

Remark: The remote start/stop, is the same as with individual units. In case of DICN, the remote start/stop to be used, is the one from then master unit. In case of a disconnect unit, you must use the remote start-stop of this unit.

STEP 1 : Go to the Service menu, submenu communication.

	Unit 1 Master	Unit 2 Slave 1	Unit 3 Slave 2	Unit 4 Slave 3
DIII :	YES	YES	YES	YES
ADDR :	1-00	1-01	1-02	1-03
POWER :	Y	N	N	N

- 1 Enable the DIII communication on each chiller
- 2 Specify a different address for each chiller
- 3 Enable the power parameter on one chiller in the DICN network (Master).

STEP 2 : Go to the service menu, submenu DICN.

	Unit 1 Master	Unit 2 Slave 1	Unit 3 Slave 2	Unit 4 Slave 3
MS OPTION :	Y ^(*)	Y	Y	Y
UNIT :	MASTER	SLAVE	SLAVE	SLAVE
NR OF SLAVES :	3	-	-	-

(*) The master unit must be set as last in row, otherwise set to N and back to Y.

- 1 Enable Master-Slave option on each chiller.
- 2 Specify the unit as master or slave.
- 3 Specify the number of slaves (only on master unit).

STEP 3: Go to the Service menu, submenu DICN

Specify address of slave 1/2/3, same address as programmed in step 1.

	Unit 1 Master	Unit 2 Slave 1	Unit 3 Slave 2	Unit 4 Slave 3
ADD SL1 :	1-01	-	-	-
ADD SL2 :	1-02	-	-	-
ADD SL3 :	1-03	-	-	-

STEP 4: Go to the service menu, submenu DICN

	Unit 1 Master	Unit 2 Slave 1	Unit 3 Slave 2	Unit 4 Slave 3
PRIORITY	0-2	0-2	0-2	0-2
STEPLength	1.5°C	1.5°C	1.5°C	1.5°C
STANDBYIF MAX CAP	N	N	N	N

STEP 5: Go to the user menu, submenu DICN

- 1 Specify the unit priority - stepL priority.
- 2 Specify the steplength parameter used in the steplength priority function.
- 3 Specify if unit has to start or stay in standby when normal units in DICN system run at 100% and the setpoint is not reached yet.

Remark: Unity priority - stepL Priority

- The first digit of the Master Slave Priority refers to the Unit priority. With this digit you can give each unit a certain start up priority.
- The second digit refers to the Step Length priority. This setting reacts only on load up steps and avoids that one of the DICN units goes into freeze-up alarm because the common leaving water is still to high.

Explanation of Unit priority - stepL Priority Settings

There is a possibility to put a priority parameter in the service menu. This parameter is standard set on 2 and can be changed from 0 till 4. The setting reacts only on load up steps and avoid that one of the DICN unit goes into freeze-up alarm.

Load up priority result:

If an unit has an $LWE < MOW + Stepl\ priority * steplength$, than it has a lower priority than the rest.

EXAMPLE: LWE setpoint = 6°C

C11:ON C12:ON C11:ON C12:OFF C11:OFF C12:OFF C11:OFF C12:OFF
 C21:ON C22:ON C21:ON C22:OFF C21:OFF C22:OFF C21:OFF C22:OFF

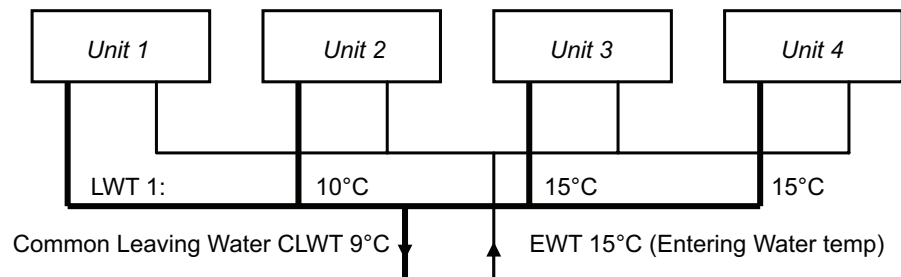

Without Priority Parameter

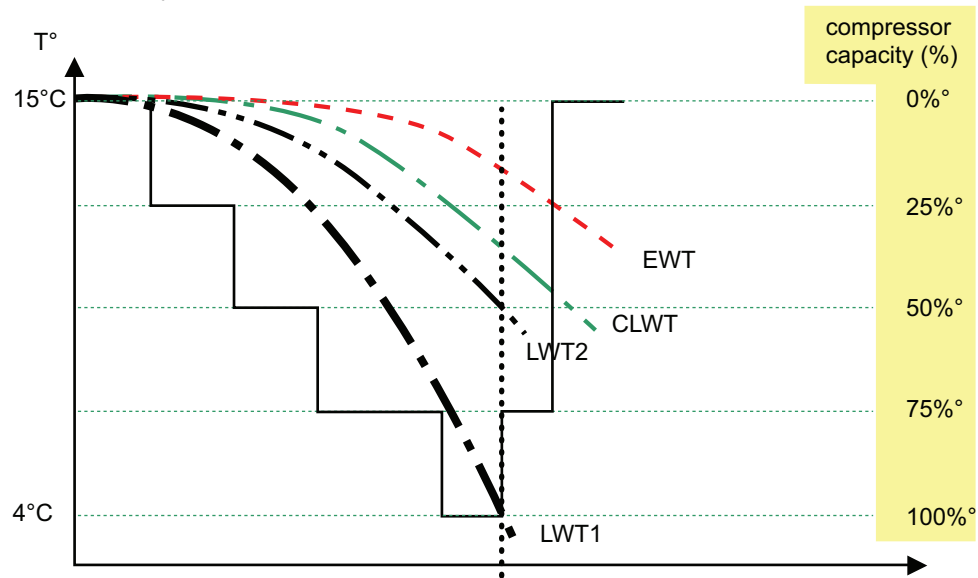

LWT1 = leaving water temperature unit 1.
 LWT2 = leaving water temperature unit 2.
 CLWT = common leaving water temperature DICN system.
 EWT = Entering water temperature.

With priority parameter

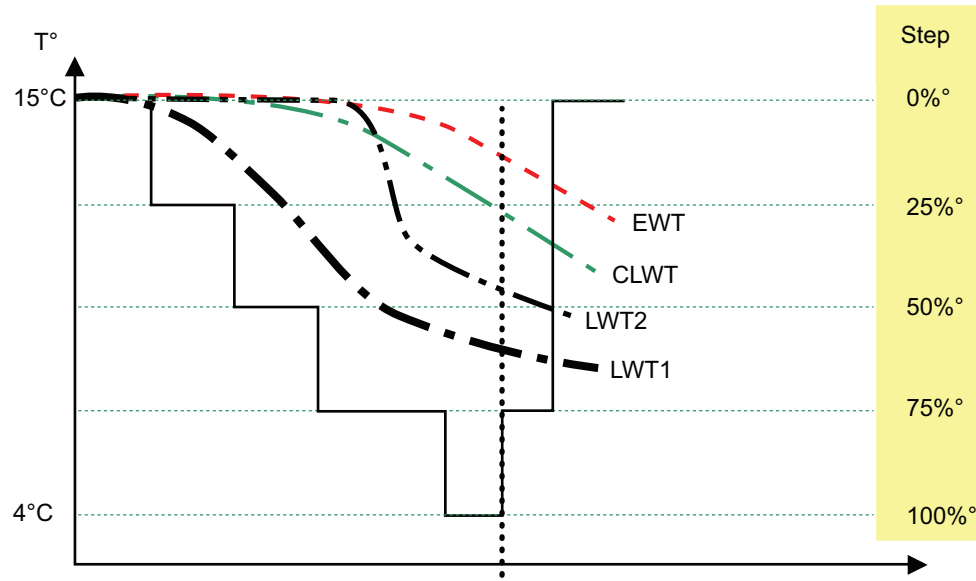

If unit 1 gets priority 3 then we get : $If LWE < 4 + (3 * 1.5)$

If $LWE < 8.5$ then this unit gets a lower priority than the other units.

For units with more than 2 circuits, the individual lead/lag setting of a unit to determine the priority of the circuits - remain valid. Every unit should be configured as either a "NORMAL", "STANDBY" or "DISCONNECT" unit. This setting will be mentioned on the display of each chiller.

Description of the different operation modes and settings.

MODE: NORMAL

The network controls the unit. Loading and unloading is decided by the central control of the network. Putting this unit ON or OFF will also put all other units ON or OFF, unless their status is "DISCONNECT ON/OFF".

Changing CONTROL SETTINGS or THERMOSTAT SETTINGS on this unit, will apply to all other units. MANUAL CONTROL on such a unit is not possible.

MODE: STANDBY

The unit is considered as a "NORMAL" unit and its function is then also similar to a unit defined as "NORMAL", but this unit however, will only come into operation if:

- another unit is in alarm (unit safety or circuit safety)
- another unit is in "DISCONNECT ON/OFF" mode
- the setpoint is not reached when all other units have been running on 100% capacity. This condition can be disabled in the service/DICN menu, standby if MAXCAP.

If more than one unit is defined as STANDBY, only 1 of the units will be really standby. The number of running hours will decide the unit that is really standby.

Also, more than 1 unit (up to 4) can be defined as a "STANDBY" unit. In that case, only the unit which is most near to its target running hours will be considered as a "STANDBY" unit. This means, if a customer wants to have 1 particular unit always to be in "off" mode (except for alarm or capacity shortage of the other chillers), then he only has to define this 1 unit as "STANDBY".

But if a customer wants to have more than 1, or even all chillers to be a standby unit alternately (each on its turn), then more than 1 or all chillers should be defined as "STANDBY".

MODE: DISCONNECT

DISCONNECT: Units which are defined as "DISCONNECTED", can be put "ON/OFF" or set to MANUAL MODE independent from the other units. This can be very useful e.g. in case of servicing. When changing to "NORMAL" or "STANDBY", the unit becomes part of the system again.

OFFSET

The OFFSET time defines the target difference in running hours between one unit and another unit with OFFSET:0000 h. This value is important for maintenance purposes. The difference in setting among different units should be high enough as to avoid servicing of the units all at the same time. The lower and upper limits are 0 and 9000 hours respectively. The default value is 0 hours.

For units with 2 circuits, the individual lead/lag setting is valid as to determine the priority of the circuits.

E.g. if following setting is made:

Unit 1 = 0 h
Unit 2 = 1000 h
Unit 3 = 2000 h
Unit 4 = 2000 h

Then unit 3 and 4 will be operated most. They will get priority in operation as to reach 2000 running hours more than unit 1. Unit 1 will be the unit with the lowest running hours.

PUMP ON IF

Set if the pump must operate as long as the chiller is ON (UNIT ON), or during compressor on condition only (COMPR ON).

- When UNIT ON is selected, the voltage free contact S9L will remain closed as long as the chiller is ON.
The pump of individual unit will run if unit is on.
- When COMPR ON is selected, the voltage free contact S9L will remain closed as long as the compressor is ON.

Remark: If no pumpcontact is closed (ex all pump on if "COMPR ON" & no request to loadup) then turn on the pumpcontact of the unit with highest priority. (This is needed because the temperature sensor must be able to measure the correct water temperature).

3.17 BMS Function

Introduction

BMS stands for Building Management Systems. These systems were developed for centralized overview and control of technical installation for complete sites.

The Daikin BMS option makes it possible to connect the Daikin chillers to a larger control system. The necessary tools for this communication are the Gateway and the address card.

In this chapter we will give a short overview of the possibilities and settings for the BMS function. For more detailed information we refer to the service manual “BMS option for Daikin” air cooled chillers with scroll compressor.

BMS integration with MODBUS protocol (kit EKACPG per chiller)

Modbus protocol.

Setup:

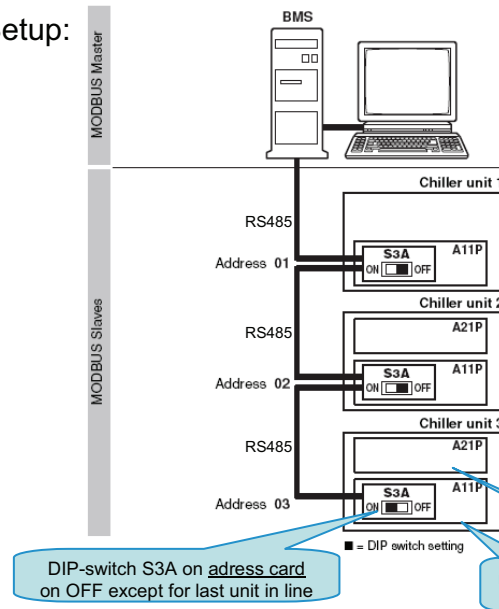

Functions:

Monitor and Control:

- On-Off
- Thermostat (setpoints, mode)
- Capacity limit
- Low noise
- ...

Monitor:

- Error (active/not active, code, type)
- Unitcapacity
- Compressor, fan status
- All inputs/outputs (incl all sensors)
- ...

Full list of variables that can be read and/or written: see operation manual of address card or BMS Service Manual ESIE 07-09.

Maximum 32 chillers

BMS integration with BACnet/IP protocol

BACnet/IP Protocol

Option 1: via RS485-port on address cards EKACPG and kit EKBNPG.

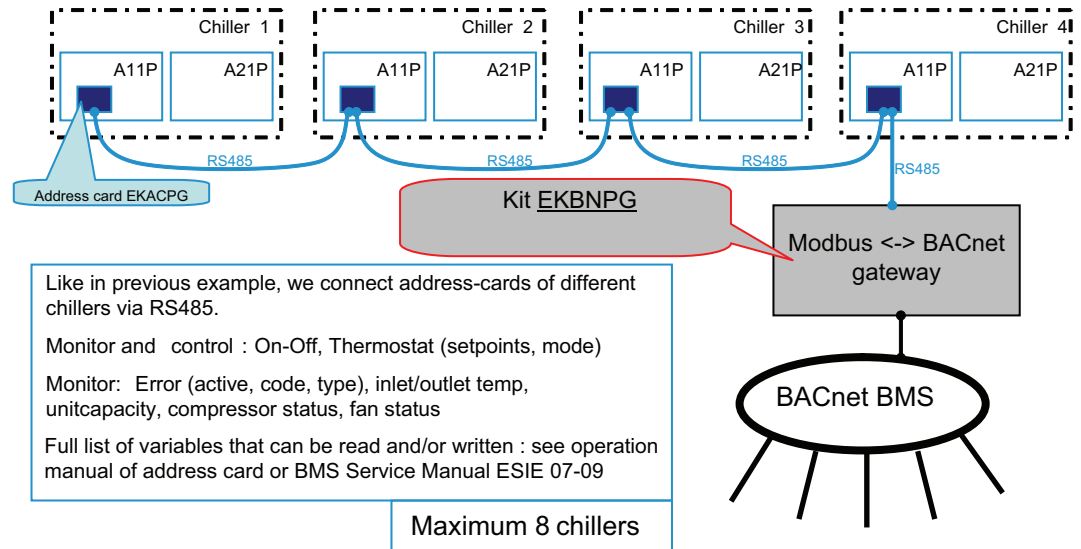

BMS integration with LON protocol

LON protocol

Option 1: via RS485-port on address cards EKACPG and kit EKLNPG.

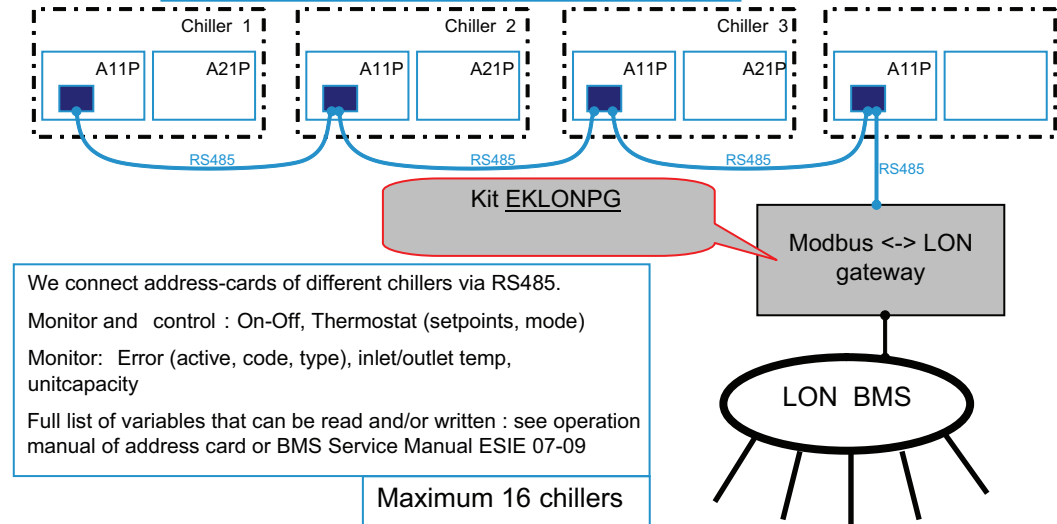

Example of BMS Modbus Setup

STEP 1 : Up-Wiring

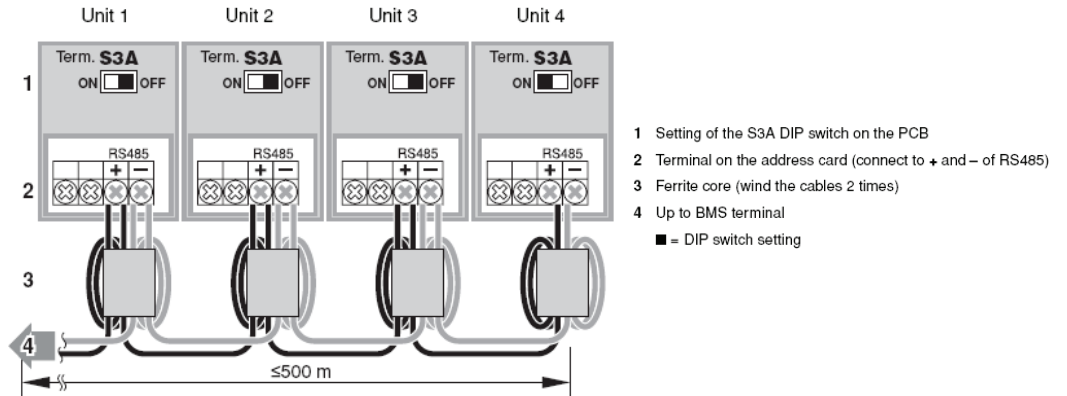

STEP 2 : DIP switch settings (S3A)

Example:

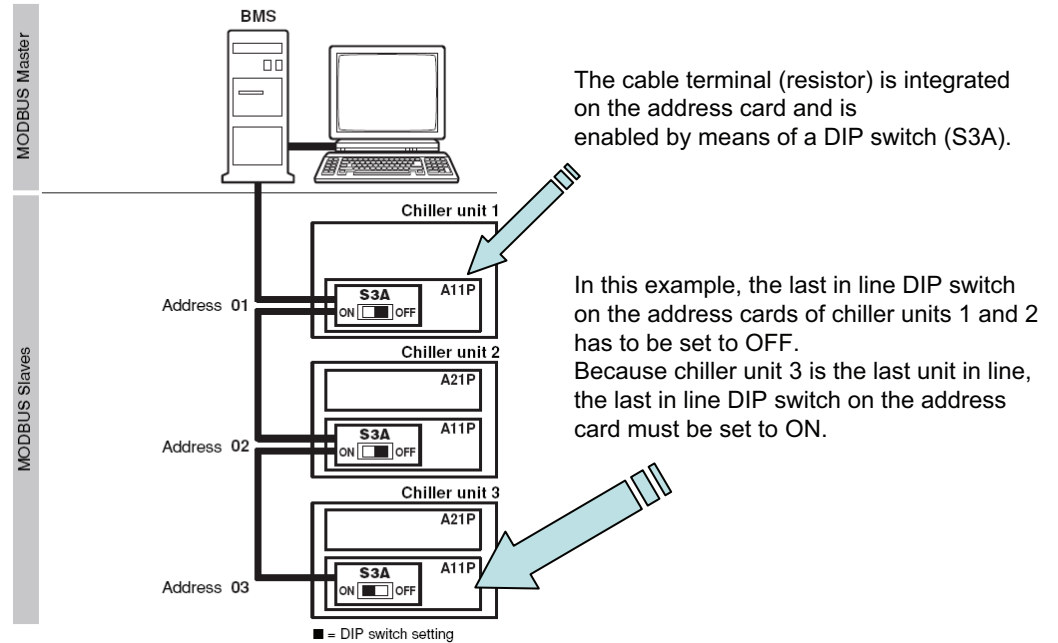

2

STEP 3: Go to the Service menu, Submenu communication (Communication fourth screen).

	Unit 1	Unit 2	Unit 3	...
RS485	MODBUS	MODBUS	MODBUS	MODBUS
ADDR : (Address)	01	02	03	...
BR : (Baudrate)	19200	19200	19200	19200
PARITY :	EVEN (1 STOPb)	EVEN (1 STOPb)	EVEN (1 STOPb)	EVEN (1 STOPb)

- 1 Specify the address of the chiller in the BMS system.
- 2 Specify the communication speed, baudrate.
- 3 Specify the parity and stop bit for the communication.

Go to the Service menu, submenu.

STEP 4: Communication (sixth screen)

	Unit 1	Unit 2	Unit 3	...
BMS CONTROL ALLOWED :	Y	Y	Y	Y

- 1 Enable or disable if BMS control is allowed or not (possible to read or to read and write).

3.18 Freeze-up Control

Introduction

Freeze-up control is used to protect the evaporator against accidentally freezing.

Three protections are present :

- 1 Anti-freeze function on water temperature (thermistor).
 - Anti-freeze prevention.
 - Anti-freeze protection.
- 2 Anti-freeze function by pump control OR heater tape.
- 3 Anti-freeze function by refrigerant gas temp (function only in cooling mode).

3.18.1 Anti-Freeze function or inlet/outlet water temperature

Freeze-up prevention

Freeze-up prevention will request a load-down when the temperature of the evaporator outlet water gets below the freeze-up disable setpoint +0.5 °C. If 1 compressor is reduced immediately, reset the load up/down timers (and start recounting). After reducing 1 compressor in operation, when the temperature is still in this area, reduce 1 more compressor after 15 seconds. Repeat this until only 1 compressor remains in operation. If only 1 compressor remains on, do not execute this procedure.

Characteristics	Freeze-up prevention
Control device	Sensor
Diagram name	R3T, R4T
Activation	When 2 or more compressors are in operation AND If leaving water temperature < FREEZE UP DIS + 0.5 °C.
Result	Load down compressor every 15 seconds until 1 compressor is in operation.
Reset Result	If leaving water temperature > RESET value Normal mode.

Freeze-up protection for software version 2.1

When the evaporator outlet water temperature sinks below Freeze-up disable setpoint freeze-up protection is activated and the unit is shut down. When the temperature rises above the reset setpoint, protection is reset and the unit will work in its initial mode after compressor timers. The compressor will go back to the necessary capacity step, depending on the load-up possible status.

Characteristics	Freeze-up prevention
Control device	Sensor
Diagram name	R3T, R4T
Activation Result	Leaving water temperature < FREEZE UP DIS Unit disabled
Reset	Reset when leaving water temperature rises above MOW setpoint.

Important : No alarm is displayed after freeze-up protection. Unit will restart after the REF GRD EXTEND timer (12 min).

Functional description

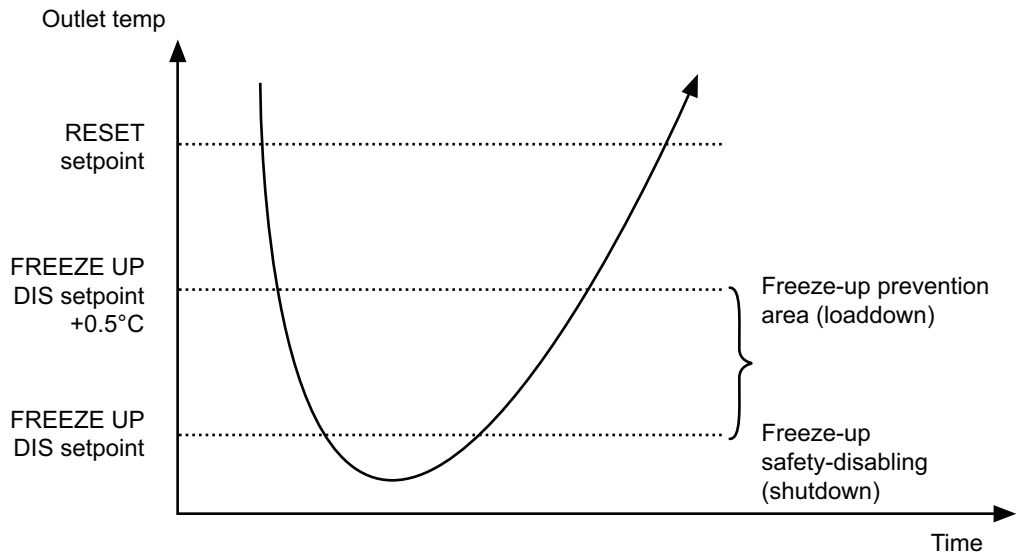

- Loadup not possible area : if outlet water is lower then MOW then loadup is not possible.
- Freeze-up prevention area : if outlet water temperature is lower then freeze up DIS + 0.5°C then unload 1 compressor, as long as the outlet water temp is too low and until 1 compressor is in operation.
- Freeze-up safety disabling area: unit will shutdown.

Freeze-up protection for software version 2.2 or higher

When the evaporator outlet water temperature sinks below freeze-up disable setpoint, protection is activated and the unit is shut down. When the temperature rises above the reset setpoint the freeze-up protection is reset and the unit will work in its initial mode after compressor timers. The compressor will go back to the necessary capacity step, depending on the load-up possible status. A maximum number of freeze-up protections per 30 min can be set in the service/safety menu. When the unit exceeds this number in less than 30 minutes, an alarm will be activated.

Characteristics	Freeze-up prevention
Control device	Sensor
Diagram name	R3T, R4T
Activation	Leaving water temperature < FREEZE UP DIS
Result	Unit disabled, after
Reset	Reset when leaving water temperature rises above MOW setpoint.

Remark:

- A selection of the freeze-up safety can be made in the :
 - FREEZE UP OW: DISABLE, freeze-up function as described in software version 2.1.
 - FREEZE UP OW: DIS & SAF, freeze up function as described above.
- When Freeze-up safety is active, the controller will display "O4A: Freeze UP" alarm.

Functional description

2

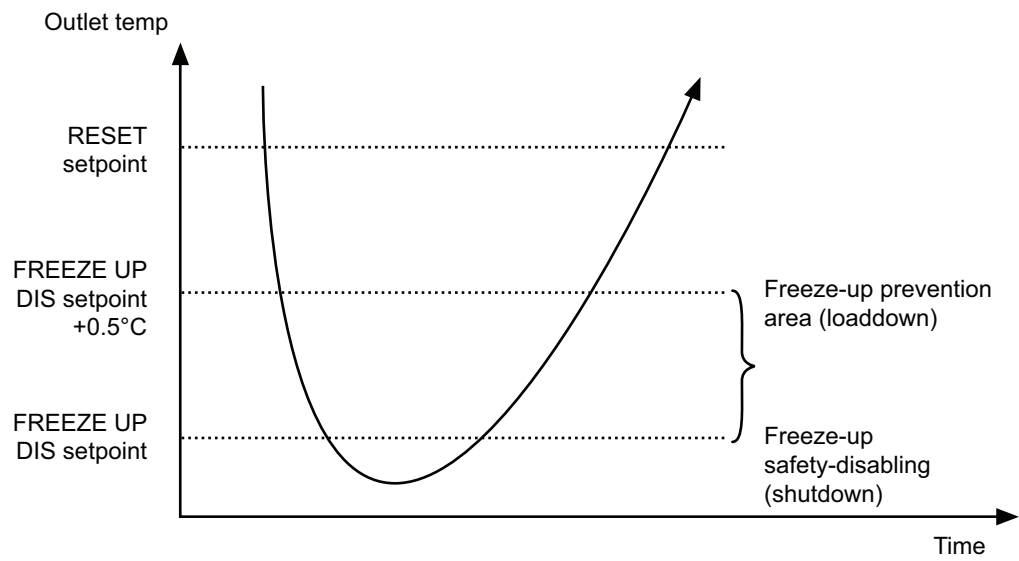

- Loadup not possible area : if outlet water is lower then MOW then loadup is not possible.
- Freeze-up prevention area : if outlet water temperature is lower then FREEZE UP DIS + 0.5°C then unload 1 compressor, as long as the outlet water temp is too low and until 1 compressor is in operation.
- Freeze-u safety disabling area: unit will shutdown.

3.18.2 Anti-freeze function by pump control OR heater tape

Anti-freeze by pump operation

Only when no heater tape is present (OP10 not installed).

Activation :

- If water temperature of inlet/outlet is \leq PUMP ON SETP. °C
- AND
- pump is off

Action:

Turn on pump.

Reset :

Reset function if water temperature gets \geq reset setpoint.

Anti-freeze by heater tape

Only when heater tape is present (OP10 installed).

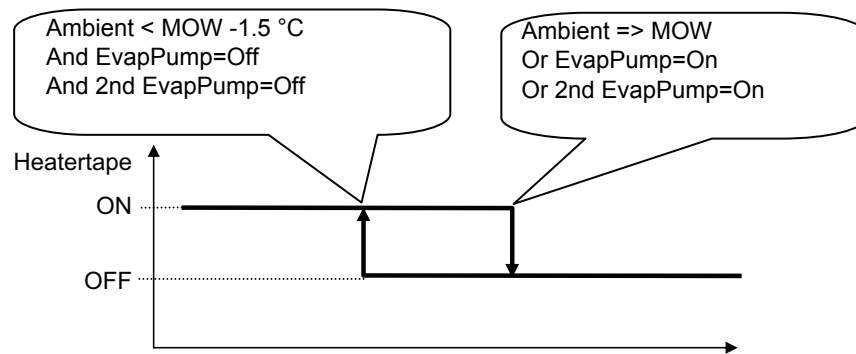

Activation:

- If ambient temperature is \leq MOW -1.5 °C.
- AND evaporator pump is OFF
- AND 2nd evaporator pump is OFF

Action:

Turn on evaporator heater tape

Reset:

- If ambient temperature is \geq MOW.
- OR evaporator pump is ON.
- OR 2nd evaporator pump is ON.

3.18.3 Anti-freeze function by refrigerant gas temperature

Function only in
cooling

Activation :

If refrigerant gas temperature is \leq REFR TEMP SET continuously for 10 seconds.

Action:

- Switch off/on the unit (first time in 30 min --> no alarm).
- If above condition is satisfied twice in 30 minutes --> switch off unit on alarm.

Reset:

Reset possible if refrigerant temperature rises above -2.5 °C.

This control will be masked during below operation status.

60 sec from first compressor start-up of each circuit.

3.19 Discharge gas safety

Introduction

The discharge gas safety is used to protect the compressor.

Activation

When the discharge gas temperature gets above the "START CONTROL (°C)" till the discharge temperature drops below STOP CONTROL (°C).

Action

Open EV (Electric expansion valve) with CONTROL EEV(PLS) every sampling time 10 sec.

Reset

Reset if discharge gas temperature becomes less than "RESET TO NORMAL" value or discharge gas super heat becomes 25°C or less, return to the normal EV control.

Remarks : If 2 compressors are operated per circuit, Judge the one with the highest discharge gas temperature for EV opening, and to return to normal EV control, judge on the one with the lowest gas temperature.

3.20 Password Function

Introduction

A user password can be chosen, in the user password menu, to protect the user settings.

In the user advanced menu it can be chosen whether a password is needed to change the setpoint.

In the service/safety menu you can choose if a password is needed to reset safeties. This password can be either the user password either the service password.

When the user is logged in with a password, this password will be remembered. When the controller is not touched for a specified time "LOGOUT TIMER" (user advanced menu), the controller will automatically logout and password is needed again to enter the menu.

The user can find back in the password menu with which password he is logged on and he can also manually log off.

Overview of possibilities

A user password is used to protect the user parameters. This password can be set in the user password menu.

A service password is used to protect the service parameters; this password is factory set and cannot be changed.

Possible to enter with Menu		User password	Service password
		1234 (default)	Contact your distributor for this password (fixed)
1.	Setpoint menu (only if Setpoint password is enabled in the user advanced menu)	Yes	Yes
2.	User settings menu	Yes	Yes
3.	Service menu	No	Yes
4.	User password menu	Yes	Yes
Additionally: depending on the status of the "password needed to reset safety" parameter in the service menu.			
5.	Possible to reset a safety in safety menu if user password is required	Yes	Yes
6.	Possible to reset a safety in safety menu if service password is required	No	Yes



3.21 History logging

Introduction

Before a safety happened a number of data (Logs default 5) has been recorded (LogTime: default with 10 sec between), this logging data is only available of the last safety that happened and the data will only be displayed in the history menu, if the History Extra screens = "Y" in the service menu.

This logging data will be continuously stored in the RAM memory, when the safety happens the data will be copied into the flash memory (Flash memory: This type of memory will keep all data, even when power is put off).

Functional description

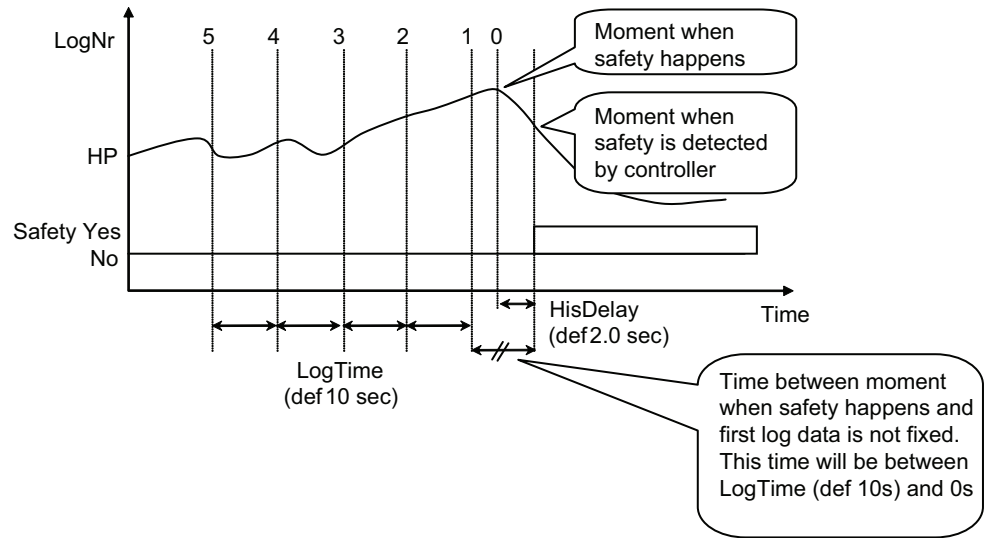

Logging data indication:
 00: History at moment of last error
 01 ~05: Logging data from the moment before error

```

    History number
    _v 00 UNIT HISTORY: 022
    1E6: COMPR 1 SAFETY
    22h33m00s 23/03/06
    COOL. INLSP1: 012.0°C
    
```

To consult the log data:

- 1 Enable history extra screens : Y
- 2 Enter History menu
- 3 Go to last error
- 4 Press Down to consult logging data 1 2 3 4 and 5.

3.22 Defrost management

3.22.1 Introduction

For dual circuit units, each refrigerant circuit will enter defrost function separately. The defrost cycle will only occur on the circuit that needs it. The other circuit will continue its normal operation when required.

In heating mode, the defrost will be executed when the following conditions are met:

- Manual defrost is requested.
 - The temperature sensors reach a certain value.
-

3.22.2 Manual defrost

If below conditions are met during compressor operation in heating mode, a manual defrost can be selected from the user menu.

Only possible if:

- 1 The user requests a manual defrost via the controller.
- 2 $T_r < 10^{\circ}\text{C}$ (or when thermistor abnormality : $T_a < 7^{\circ}\text{C}$)

Remark : in case of coil thermistor error, condition is based on ambient temperature.

No defrost forbid timer active when manual defrost is selected.

Unit defrost setting: If manual defrost starting conditions are satisfied for both circuits, 2nd circuit defrost will only start after defrost finish of 1st circuit. During 1st circuit defrost, defrost finish conditions for 2nd circuit are not evaluated, so 2nd circuit defrost is guaranteed.

Remark : manual defrost can be requested in the user/defrost menu.

T_r : coil temperature.

T_a : ambient temperature.

3.22.3 Automatic defrost

Defrost forbidden timer

Defrost forbidden timer.

This is the minimum time between 2 defrost cycles in order to keep the heating capacity and to prevent frequent defrosting.

- The timer can be
 - Normal startvalue (def 30 min, range 20 - 120 min).
 - Short start value (default 10 min, range 1 - 20 min).
- If timer is not on 0, the defrost cycle cannot be started.
- The timer starts counting from previous defrost finished.
- In case of a safety stop, the timer starts counting.
- In case of thermostat-OFF, counter does not reset and keeps on counting.
- If during countdown of the timer, timer selection is modified from normal to short, and the already time past is larger than the short timer value ==> timer is put on 0.

Defrost start conditions

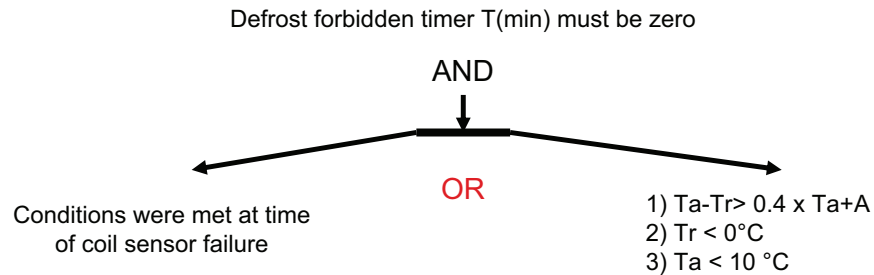

A = "start const temp", default 12 °C (can be changed between 5 - 25°C).

Ta = ambient temperature sensor

Tr = coil sensor
 (in case of EWYQ230/250 : lowest temperature of 2 coil temperature sensors = Tr)

During compressor operation, above conditions should be met for 5 min before defrost will start. If less than 5 minutes, re-detect again.

Defrost start condition at sensor failure

When an abnormality occurs concerning the coil sensor, this is defined as Alarm Level. Defrost conditions will be as stated below.

	TR1 (Coil sensor)	TR 2 (coil sensor)	Defrost start conditions
For 50 ~80 HP	Normal operation	Not present	Standard defrost cycle
	Abnormality	Not present	$T_a < 7^{\circ}\text{C}$
For 30-40-90-100 HP	Normal operation	Normal operation	Standard defrost cycle
	Normal operation	Abnormality	$T_a - Tr1 \geq 0.4 \times T_a + A$ and $Tr1 < 0^{\circ}\text{C}$
	Abnormality	Normal operation	$T_a - Tr2 \geq 0.4 \times T_a + A$ and $Tr2 < 0^{\circ}\text{C}$
	Abnormality	Abnormality	$T_a < 7^{\circ}\text{C}$

Defrost STOP conditions

When one of the below conditions is met, recovery of the defrost cycle will occur:

- 1 $Tr > \text{RESET COIL TEMP}$ (default 20°C , range 3 - 20°C)
- 2 $HP < \text{RESET SET PR}$ (default 25 bar, range 21 - 30 bar)
- 3 $T_{\text{leavingwater}} < \text{RESET OUTL TEMP}$ (default 4°C , range 3 - 20°C)
- 4 In case the defrosting time exceeds 10 min.

Defrost stop condition at sensor abnormality

When an abnormality occurs concerning the coil sensor, this is defined as Alarm Level. Defrost conditions will be as stated below.

	TR1 (Coil sensor)	TR 2 (coil sensor)	Defrost start conditions
For 40 - 80 HP	Normal operation	Not present	$Tr \geq 20^{\circ}\text{C}$
	Abnormality	Not present	Timer recovery 10 min.
For 30-90-100 HP	Normal operation	Abnormality	$Tr1 \geq 20^{\circ}\text{C}$
	Abnormality	Normal operation	$Tr2 \geq 20^{\circ}\text{C}$
	Abnormality	Abnormality	Time recovery 10 min.

Actions during defrost start

Actions during start and execution of the defrost cycle.

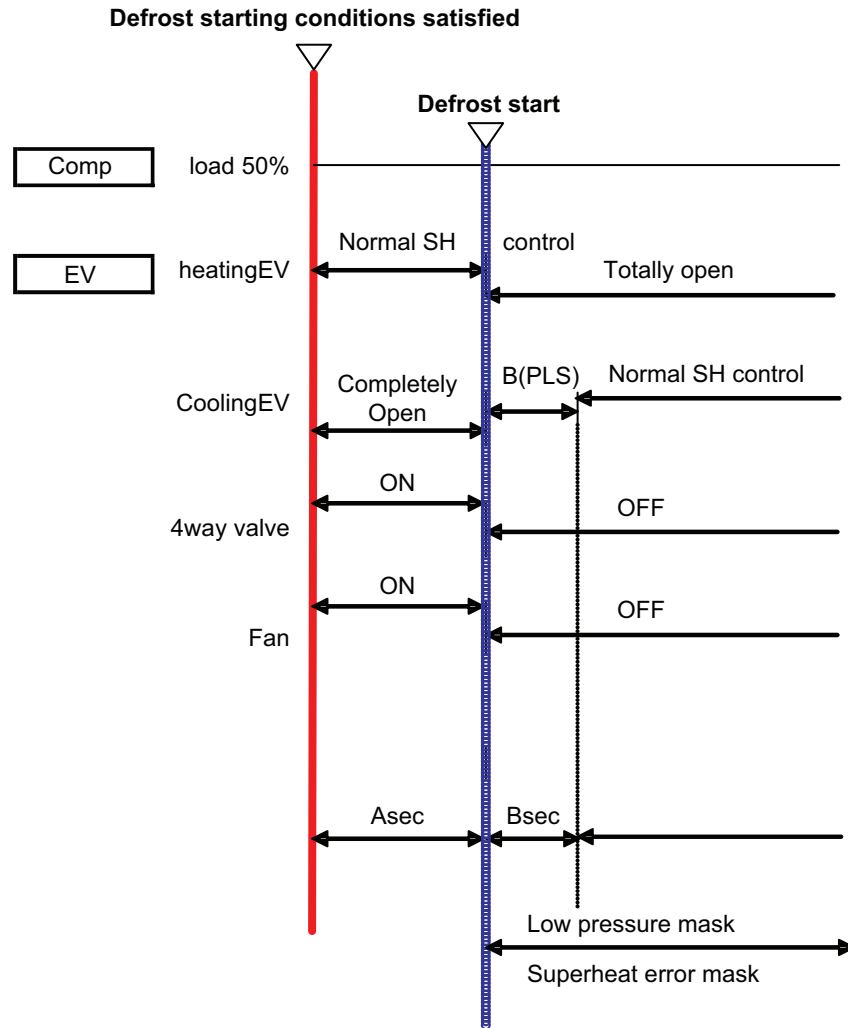

- 1 DEFROST CONDITIONS SATISFIED.
- 2 Only 1 compressor in operation of this circuit during defrost.
- 3 Open Cooling EV completely.
- 4 30 seconds (A) normal SH control (heating) before defrost start.
- 5 DEFROST START.
- 6 Switch 4way valve and close heating EV totally.
- 7 Turn OFF fans.
- 8 Open Cooling EV with "initial pulses" 200pls (B pls) for 5 sec (B sec)
- 9 Continue normal SH control (cooling)
- 10 Mask low pressure protection control and superheat error during defrost.

Remark : the EWYQ080DAYN* has a modified control during defrost.

- If the unit is starting a defrost cycle, then keep the number of running compressors.
 - If 1 compressor is running then 1 compressor defrost.
 - If 2 compressors are running then 2 compressor defrost.

Startup control after defrost recovery

2

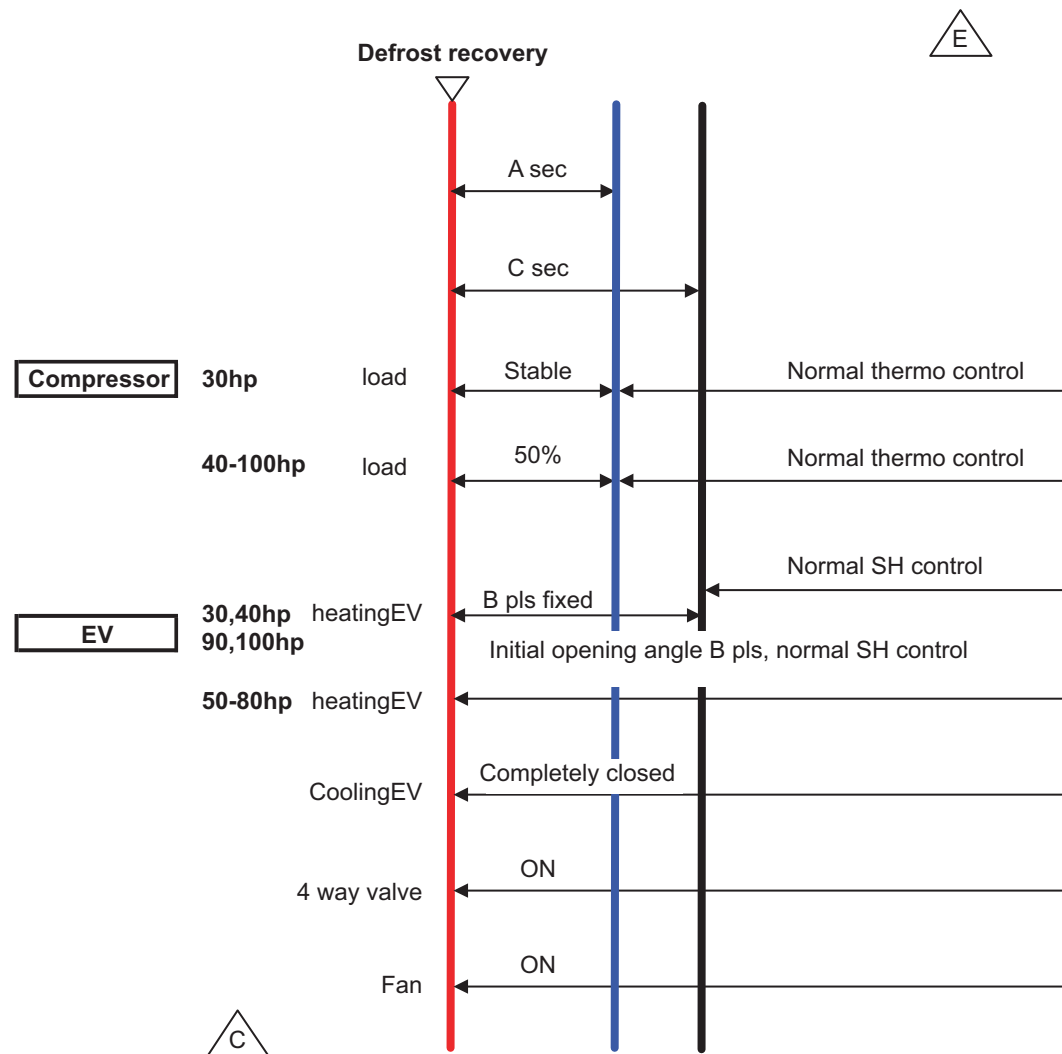

- 1 Defrost recovery conditions satisfied.
- 2 For 40 - 100 Hp units: only 1 compressor in operation of this circuit during defrost recovery.
For 30 Hp units: keep the same number of compressors as used in the defrost function.
- 3 Energize 4-way valve.
- 4 Close cooling EV completely.
- 5 Turn fans ON.
- 6 For 30, 40, 90, 100 Hp units: EV opening for heating is defined as B(pls) for "C" sec (EEV KEEP TIME), after this timer change to normal SH control.
For 50, 80 Hp units: EV opening for heating is defined as B(pls) and direct start with normal SH control (EEV KEEP TIME is defined as 0 sec).
- 7 For 40 - 100 Hp units: after switching 4-way valve, keep 1 compressor running for "A" sec, after this timer, change to normal heating mode.
For 30 Hp units: keep the same number of compressors for "A" sec, after this timer, change to normal heating mode.

Remark :

- In case of "A" sec timer < "C" sec timer then FF CONTROL function is invalid and not used when a compressor is added.
- In case of "A" sec timer ≥ "C" sec timer then FF CONTROL function is valid and used when a compressor is added.

3.23 Reversing valve

This digital output function allows switching a reversing valve.

REMOTE COOL/HEAT:

- Digital input open = Heating
- Digital input closed = Cooling

Remark : if remote cooling/heating is chosen by digital input then it is not possible any more to change by controller or via Supervisor system.

- Four way valve relay is:
 - energized during heating mode
 - not energized during cooling mode.
- When switching cooling <--> heating during operation :
 - 1 Thermostat OFF
 - 2 Restart unit + change status of 4 way valve (by (de) energizing the relay).

The four way valve status is changed at the same time of compressor start-up.

3.24 Low pressure bypass

To avoid low pressure during startup of the unit or fan shifting (Fan up) the low pressure error is disabled for a certain time.

The low pressure bypass can be set in the service safety menu.

FAN LP MASK : 30s (default)

Low pressure mask after switching to a higher fanstep.

COMPR LP MASK : 30 s (default)

Low pressure mask from first compressor start of a circuit (no masking at second compressor start).

3.25 Simulation

This is an operation mode for the controller in a simulation board because then the actual unit and components are replaced by electrical and electronic components. These components would not allow correct operation of the controller if it was in normal mode.

This mode can only be used on simulation boards.

Possible settings (Service/Advanced menu):

■ Simulation setting:

Simulation parameter	Application
Simulation = NO	actual unit
Simulation = YES	simulation board is selected

■ AI Setting:

Simulation parameter	Application
AI = 0	actual unit = actual sensors are used on the analog inputs
AI = 1	simulation board (all analog inputs use potentiometers = NTC)

■ DIS. EEV Setting:

Simulation parameter	Application
DIS. EEV = 0	actual unit with EEV driver
DIS. EEV = 1	If no EEV driver is connected to the simulation board this parameter should be put on 1. This will disable the EEV control on the controller.

2

Part 3

Troubleshooting

Introduction

When a problem occurs, all possible faults have to be checked. This chapter gives a general idea of where to look for faults. Furthermore the general procedures for refrigeration circuit repair and for electrical circuit repair are explained.

Remark

Not all repair procedures are described. Some procedures are considered common practice.

What is in this part?

This part contains the following chapters:

Chapter	See page
1–Overview of Fault Indications and Safeties	3–3
2–Checking the Temperature Sensors	3–25
3–Reset procedure	3–31
4–Procedure for Software Upload	3–33
5–Procedure for main PCB changing	3–43
6–Procedure for extension PCB changing	3–47
7–Procedure for controller changing	3–49
8–Procedure for EEV PCB changing	3–51
9–Procedure for compressor replacement : Suction washer	3–53
10–Procedure for Compressor Oil Fill or Oil Drain	3–55
11–Compressor electrical connections and wiring	3–57
12–Procedure to Clear the Refrigerant Circuit in Case of Frozen Evaporators	3–59

3

1 Overview of Fault Indications and Safeties

1.1 What Is in This Chapter?

Introduction

In the first stage of trouble shooting sequence it is important to interpret the fault indication on the controller display. This will help you to find the cause of the problem.









Overview

This chapter contains the following topics:

Topic	See page
1.2–What happens in the Event of an Alarm?	3–4
1.3–What to do in the Event of an Alarm?	3–5
1.4–Overview of Unit Safeties	3–6
1.5–Overview of Circuit Safeties	3–11
1.6–Overview of Network Safeties	3–19
1.7–Overview of Warnings	3–21
1.8–Overview of Start Problems	3–23

1.2 What happens in the Event of an Alarm?







The units are equipped with three kinds of safety devices.

	Unit alarm	Circuit alarm	Network alarm	Warnings
Function	Protects the unit in general	Protects the individual circuit	Is activated when a communication problem occurs	Dual pump safety
Description	<ul style="list-style-type: none"> ■ All compressors are shut down. ■ The red LED above the  key lights up 	<ul style="list-style-type: none"> ■ The compressors of the corresponding circuit are shut down. ■ The red LED above the  key lights up 	<ul style="list-style-type: none"> ■ The units of the network will operate as standalone. ■ The red LED above the  key lights up 	<ul style="list-style-type: none"> ■ No action is taken, the units keep operating. ■ The red LED above the  key lights up
Action to take	Press  to acknowledge the alarm	Press  to acknowledge the alarm	Press  to acknowledge the alarm	Press  to acknowledge the warning
Display example	OAE:FLOW HAS STOPPED OU1:REVERSE PHASE PR	1CA:OUT E SENSOR ERR 1EO:GENERAL SAFETY 1A4:FREEZE -UP PROT.	0U4:PCB COMM.PROBLEM	0AE:FLOW HAS STOPPED

3

1.3 What to do in the Event of an Alarm?

In event of an alarm or a warning, the following must be done:

Step	Action	Result
1	Press  to acknowledge the alarm.	<ul style="list-style-type: none"> ■ The  LED lights up ■ A unit, circuit or network, safety is displayed.
2	Find the cause of the alarm and correct it.	The system is repaired.
3	The cause of the alarm was found and corrected.	The  LED starts blinking. Now it is possible to reset.
4	Press  to reset the alarm.	<ul style="list-style-type: none"> ■ The  LED goes out and the alarm screen is deactivated. ■ The main menu screen is displayed automatically. <p><u>Remark:</u> if in the service menu the option "password needed to reset safeties" is activated, you will be asked to enter the correct password to reset the safety.</p> <p><u>Remark:</u> After resetting the alarm it is possible to consult the safety information by using the history menu.</p>
5	If all circuits were shutdown, switch the unit on by pressing  .	The unit starts again.

1.4 Overview of Unit Safeties

Introduction

This section provides useful information for diagnosing and correcting certain troubles which may occur in the unit.

Before starting the troubleshooting procedure, carry out a thorough visual inspection of the unit and look for obvious defects such as loose connections or defective wiring.

When carrying out an inspection on the supply panel or on the switch box of the unit, always make sure that the circuit breaker of the unit is switched off.

Unit safety overview

	MESSAGE SAFETY MENU
UNIT SAFETY	0AE:FLOW HAS STOPPED
	0AE:PUMPINTERLOCK
	0A4:FREEZE UP
	0A9:EEV PCB COMM ERR
	0A9:EEV PCB ERR
	0C9:INL SENSOR ERR
	0CA:OUT SENSOR ERR
	0H9:AMB T SENSOR ERR
	0U4:EXTPCB COMM.ERR
	0U4:MAINPCB COMM.ERR
	0U5:PCB COMM.PROBLEM

Unit Safety description

OAE : FLOW HAS STOPPED

Purpose:

- To prevent that chiller start up without flow.
- To stop chiller when there is no flow.

Symptom: Flowswitch is activated		
POSSIBLE CAUSES	CORRECTIVE ACTION	CONSEQUENCE
No water flow for 5 seconds continuously or too low water flow.	Check the water pump filler and the water circuit for obstructions.	Unit switched off.
RESET : After finding the cause, the flowswitch is reset automatically, but the controller still needs to be reset.		

OAE : PUMPINTERLOCK

Purpose:

- Detect if pump works or not.

Symptom: Pump interlock contact is open		
POSSIBLE CAUSES	CORRECTIVE ACTION	CONSEQUENCE
The pump interlock contact is not closed.	Make sure a pump interlock contract is wired correctly and closed when the pump starts operating.	Unit switched off
RESET : Only if a pump contractor is present: Switch the black handle on the pump fuse inside the switchbox and reset the controller.		

OA4: FREEZE UP

Purpose:

- To prevent freezing of the evaporator.

Symptom: Freeze-up protection is activated		
POSSIBLE CAUSES	CORRECTIVE ACTION	CONSEQUENCE
Water flow too low.	Increase the water flow.	In case outlet water temperature becomes too low. Software version 2.2 or higher. Freeze-up disable, unit will switch off, no safety, unit will restart if water temperature is above reset setpoint and compressor timers are on 0. After second (default) freeze up disable within 30 min alarm is displayed and manual reset of the controller is needed.
Inlet temperature to the evaporator is too low.	Increase the inlet water temperature.	
Flow switch is not working or no water flow.	Check the flow switch and the water pump.	
RESET : After water temperature rises, above the RESET value, this safety resets automatically, but the controller still needs to be reset.		
Refrigerant temperature becomes too low (=def -3.5 °C)	Check the water flow and filter.... (No good heat exchange in the evaporator).	Unit switched off.
RESET: After refrigerant temperature rise, above -3.5 °C, this safety resets automatically, but the controller still needs to be reset.		

OA9: EEV PCB COMM ERR

OA9: EEV PCB ERR

Purpose:

- Indicate if there is no communication with the EEV-PCB.

Symptom: EEV driver is not operating		
POSSIBLE CAUSES	CORRECTIVE ACTION	CONSEQUENCE
The EEV driver is not operating, no communication with the EEV PCB.	Check the power supply to the EEV driver. Check if the address setting by DIP-switch is according to the wiring diagram.	Unit switched off.
RESET : After finding the cause and communication is restored, error can be reset on the controller.		

OC9: INL SENSOR ERR

OCA: OUT SENSOR ERR

OH9 : AMB T SENSOR ERR

Purpose:

- Detect if sensor is broken or not good connected (open OR short circuit).

Symptom: Sensor error		
POSSIBLE CAUSES	CORRECTIVE ACTION	CONSEQUENCE
The sensor is broken or not correctly wired (open or short circuit).	Check if the wiring is according to the wiring diagram.	<ul style="list-style-type: none"> ■ If value is too high (above range) ==> display "+ER". ■ If value is too low (below range) ==> display "-ER".
RESET : Possible to reset (manual) if the value is within range.		

OU3 : REMOCON SW ERR

Purpose:

- Indicate if there is no communication with the remote controller.

Symptom: The alarm message shows REMOCON SW ERR		
POSSIBLE CAUSES	CORRECTIVE ACTION	CONSEQUENCE
The software for the wired remote controller (A4P or A5P) is corrupt or absent.	Check if the wiring to the main PCB (A11P) is according to the wiring diagram. Check if the "address setting" and the "terminator resistor setting" by DIP-switch is according to the setting mentioned in the wiring diagram.	Unit switched off and no controller readout.
RESET : After finding the cause and communication is restored, error can be reset on the controller.		

OU4:EXTPCB COMM.ERR

Purpose:

- Indicate if there is no communication with the Extension PCB (the extension PCB A01P cannot be found).

Symptom: The alarm message shows EXT PCB COMM. ERR		
POSSIBLE CAUSES	CORRECTIVE ACTION	CONSEQUENCE
The extension PCB (A01P) cannot be found.	Check if the wiring to the extension PCB (A01P) is according to the wiring diagram	Unit switched off.
RESET : After finding the cause and communication is restored, error can be reset on the controller.		

OU4:MAINPCB COMM. ERR

Purpose:

- Indicate if there is no communication with the main PCB 2 (double circuit).

Symptom: The alarm message shows MAINPCB COMM. ERR		
POSSIBLE CAUSES	CORRECTIVE ACTION	CONSEQUENCE
The main PCB of circuit 2 (A21P) cannot be found	Check if the wiring to the main PCB of circuit 2 (A21P) is according to the wiring diagram. Check if the “address setting” and the “terminator resistor setting” by DIP-switch is according to the setting mentioned in the wiring diagram.	Unit switched off.
RESET : After finding the cause and communication is restored, error can be reset on the controller.		

OU5: PCB COMM PROBLEM

Purpose:

- Indicate if there is no communication with the wired remote controller A4P (or A5P, EKRUPG) and the main PCB.

Symptom: The alarm message shows PCB COMM. PROBLEM		
POSSIBLE CAUSES	CORRECTIVE ACTION	CONSEQUENCE
The wired remote controller (A4P or A5P (EKRUPG)) has no correct communication with the main PCB (A11P)	Check if the wiring to the main PCB (A11P) is according to the wiring diagram. Check if the “address setting” and the “terminator resistor setting” by DIP-switch is according to the setting mentioned in the wiring diagram.	Unit switched off.
RESET : After finding the cause and communication is restored, error can be reset on the controller.		

3

1.5 Overview of Circuit Safeties

Circuit safeties overview

CIRCUIT SAFETY 1/2	1/2 53:FAN OVERC. ST1
	1/2 53:FAN OVERC. ST2
	1/2 53:FAN OVERC. ST3
	1/2 A9:EEV ERR
	1/2 A9:SUPERHEAT ERR
	1/2 E3:HIGH PRESSURE SW
	1/2 E4:LOW PRESSURE
	1/2 E6:COMPR 1 SAFETY
	1/2 E6:COMPR 2 SAFETY
	1/2 F3:HIGH DISCH TEMP1
	1/2 F3:HIGH DISCH TEMP2
	1/2 J3:DISCHSENSOR ERR1
	1/2 J3:DISCHSENSOR ERR2
	1/2 J5:REFR SENSOR ERR
	1/2 J5:SUCTSENSOR ERR
	1/2 J5:SUCTSENSOR ERRH1
	1/2 J5:SUCTSENSOR ERRH2
	1/2 JA:HP SENSOR ERR
	1/2 JC:LP SENSOR ERR
	1/2 U1:REV PHASE PROT

Remark:

- For circuit 1 error code starts with 1.
- For circuit 2 error code starts with 2.

Circuit Safeties

153/253 : FAN OVERC. 1/2/3

Purpose

- To avoid overheating of the fan motor

Symptom: Fan overcurrent is activated		
POSSIBLE CAUSES	CORRECTIVE ACTION	CONSEQUENCE
Mechanical failure (fan is blocked)	Check that the fan rotates freely.	Warning or safety displayed on the controller. When warning is selected unit will continue operation.
Air flow in the unit too low or outdoor temperature too high.	Clean the air heat exchanger properly.	
RESET : Push the blue button on the fan fuse inside the switchbox and reset the controller.		

1A9/2A9 EEV ERR

Purpose

- Detect when standalone EEV driver gives error

Symptom: EEV driver is not operating		
POSSIBLE CAUSES	CORRECTIVE ACTION	CONSEQUENCE
The EEV driver is not operating. No communication with the EEV PCB.	Check the power supply to the EEV driver. Check if the address setting by DIP-switch is according to the wiring diagram.	Circuit switched off.
RESET : After finding the cause and communication is restored, error can be reset on the controller.		

1A9/2A9 SUPERHEAT ERR

Purpose

- Protection compressor against liquid pumping or overheating of compressor.

Symptom: Superheat temperature is not correct.		
POSSIBLE CAUSES	CORRECTIVE ACTION	CONSEQUENCE
Superheat temperature is too high. SH C1/C2 larger than or equal to 15 °C for 300 sec.	Check if the unit has enough refrigerant (no foaming visible in sight glass). Check if the suction temperature sensor of the EEV driver is in the holder in the suction tube and not hanging loose.	Circuit switched off.
Superheat temperature is too low. SH C1/C2 smaller than or equal to 0°C for 300 sec.	Check if the EEV driver or the control motor of the EEV is wired correctly and operating. Check if the suction temperature sensor of the EEV driver is reading the right temperature.	
The sensed suction temperature is more than 2°C higher than the entering water temperature of the evaporator (+2°C) for 300 sec.	Check if the suction temperature sensor of the controller is in its holder and not hanging loose.	
RESET : After finding the cause, error can be reset on the controller.		

1E3/2E3 HIGH PRESSURE SW

Purpose

- Detect high pressure switch activation on a refrigerant circuit (HP higher as 40.5 bar).

Symptom: High-pressure switch and high pressure setback.		
POSSIBLE CAUSES	CORRECTIVE ACTION	CONSEQUENCE
Condenser fan does not operate properly	Check that the fans turn freely. Clean if necessary.	Circuit switched off.
Dirty or partially blocked condenser	Remove any obstacle and clean condenser coil using brush and blower.	
Inlet air temperature of the condenser is too high.	The air temperature measured at the inlet of the condenser may not exceed 43°C.	
Fan turning in the wrong direction.	Two phases of the power supply to the fan motor must be inverted (by a licensed electrician).	
RESET : After pressure rise, this safety resets automatically (if HP is below 30,2 b), but the controller still needs to be reset.		

1E4/2E4 LOW PRESSURE

Purpose

- A low pressure measurement is used to control the low pressure. The setting is depending if the unit is a glycol application or not.

Symptom: Low pressure.		
POSSIBLE CAUSES	CORRECTIVE ACTION	CONSEQUENCE
Water flow to water heat exchanger too low.	Increase the water flow.	Circuit switched off.
Shortage of refrigerant	Check for leaks and refill refrigerant if necessary.	
Unit is working out of its operation range.	Check the operation conditions of the unit.	
Inlet temperature to the water heat exchanger is too low.	Increase the inlet water temperature.	
Dirty evaporator.	Clean the evaporator, or call your local dealer.	
Low pressure safety setting too high.	Refer to the installation manual "Customization in the service menu", paragraph "Setting of the minimum outlet water temperature" for correct values.	
Flowswitch is not working or no water flow.	Check the flowswitch and the water pump.	
RESET : After pressure rise, this safety resets automatically, but the controller still needs to be reset. Reset is possible when LP > LP setpoint + 0.2 bar.		

1E6/2E6 COMPR 1/2 SAFETY

Purpose

- Protection of the compressor if the compressor motor coil temperature is too high because the compressor motor takes (demands/needs) too much current and is not sufficiently cooled by refrigerant.

3

Symptom: Compressor safety (only for SJ161-4)		
POSSIBLE CAUSES	CORRECTIVE ACTION	CONSEQUENCE
Failure of one of the phases.	Check fuses on the supply panel or measure the supply voltage.	Circuit switched off.
Voltage too low.	Measure the supply voltage.	
The unit is working out of its range.	Make sure the unit operates within its operating range.	
Overload of motor.	Reset. If the failure persists, call your local dealer.	
There is a short circuit.	Check the wiring.	
RESET : Pull the black handle on the compressor fuse inside the switch box and reset the controller.		

3

Symptom: Compressor safety (only for SJ180-4-SJ240-4 and SJ300-4)		
POSSIBLE CAUSES	CORRECTIVE ACTION	CONSEQUENCE
The compressor motor coil temperature is too high because the compressor motor takes (demands/needs) too much current and is not sufficiently cooled by refrigerant.	Make sure there are no refrigerant leaks. After repairing leaks, charge the unit with additional refrigerant until the sight glass in the liquid line shows no foaming.	Circuit switched off.
	Make sure the unit operates within its operating range (too high ambient or too high water temperature).	
	Make sure the compressor motor is not locked.	
RESET : After temperature decrease, a 5 minute delay is activated. After this delay the relay in the electronic protection module (EPM) is pulled in. The controller needs to be reset manually.		
Failure of one of the phases.	Check fuses on the supply panel or measure the supply voltage.	Circuit switched off.
Voltage too low.	Measure the supply voltage.	
The unit is working out of its range.	Make sure the unit operates within its operating range.	
Overload of motor.	Reset. If the failure persists, call your local dealer.	
The compressor is running in reverse phase (only for SJ240-SJ300)	Check the wiring.	
There is a short circuit	Check the wiring	
RESET : Pull the black handle on the compressor fuse inside the switch box and reset the controller.		

1F3/2F3 HIGH DISCH TEMP 1/2

Purpose

- Detect when discharge temperature becomes too high.
Discharge temperature < High discharge safety setpoint.

Symptom: Low pressure.		
POSSIBLE CAUSES	CORRECTIVE ACTION	CONSEQUENCE
Unit is working outside the operation range.	Check the operation condition of the unit.	Circuit switched off.
The unit is undercharged.	Check if there are no refrigerant leaks. After repairing leaks, charge the unit with additional refrigerant until the sight glass in the liquid line shows no foaming.	
RESET : After temperature decrease, the safety resets automatically but the controller still needs to be reset.		

1J3/2J3 DISCH SENSOR ERR 1/2

1J5/2J5 REFR SENSOR ERR 1/2

1J5/2J5 SUCT SENSOR ERR 1/2

1J5/2J5 SUCT SENSOR ERRH 1/2

Purpose:

- Detect if sensor is broken or not good connected (open OR short circuit).

Symptom: Sensor error		
POSSIBLE CAUSES	CORRECTIVE ACTION	CONSEQUENCE
The sensor is broken or not correctly wired (open or short circuit).	Check if the wiring is according to the wiring diagram.	<ul style="list-style-type: none"> ■ If value is too high (above range) ==> display "+ER". ■ If value is too low (below range) ==> display "-ER".
RESET : Possible to reset (manual) if the value is within range.		

1JA/2JA HP SENSOR ERR

1JC/2JC LP SENSOR ERR

Purpose

- Detect if sensor is broken or not good connected (sensor out of range).

Symptom: Sensor error		
POSSIBLE CAUSES	CORRECTIVE ACTION	CONSEQUENCE
The sensor is broken or not correctly wired. If value is out of voltage range: <ul style="list-style-type: none"> ■ If value < min value (0.08V) ■ If value > max value (4.92 V). 	Check if the wiring is according to the wiring diagram	<ul style="list-style-type: none"> ■ If value is too high (above range) ==> display "+ER". ■ If value is too low (below range) ==> display "-ER". Circuit switched off.
RESET : Possible to reset (manual) if the value is within range.		

1U1/2U1 REV PHASE PROT

Symptom: Reverse phase protector is activated.		
POSSIBLE CAUSES	CORRECTIVE ACTION	CONSEQUENCE
Two phases of the power supply are connected in the wrong phase position.	Invert two phases of the power supply (by licensed electrician).	Unit switched off.
One phase is not connected properly.	Check the connection of all phases.	
Voltage too low.	Measure the supply voltage.	
RESET : After inverting two phases or fixing the power supply cables properly, the protector is reset automatically, but the controller still needs to be reset.		

3

1.6 Overview of Network Safeties

Network Safety Overview

NETWORK SAFETY	OC9 : INL SENSOR ERR
	OU4 : PCB COMM. PROBLEM
	OU4 : SW VERSION ERR

Network Safety

OC9 INL SENSOR ERR

Purpose

- Detect if sensor is broken or not good connected (open OR short circuit).

Symptom: Sensor error		
POSSIBLE CAUSES	CORRECTIVE ACTION	CONSEQUENCE
The sensor is broken or not correctly wired (open or short circuit).	Check if the wiring is according to the wiring diagram.	<ul style="list-style-type: none"> ■ If value is too high (above range) ==> display "+ER". ■ If value is too low (below range) ==> display "-ER".
RESET : Possible to reset (manual) if the value is within range.		

OU4: PCB COMM. PROBLEM

Purpose

- Indicate if there is no communication with the communication PCB

Symptom: The NETWORK SAFETY alarm message shows PCB COMM. PROBLEM		
POSSIBLE CAUSES	CORRECTIVE ACTION	CONSEQUENCE
The unit cannot be found by the DICN system (EKACPG)	Check if the wiring is according to the wiring diagram. <ul style="list-style-type: none"> ■ Make sure all the units in the DICN system are powered up. ■ Make sure that the correct number of slave units is defined in the master unit. ■ Make sure that the correct unit address setting is defined in each unit (refer to the installation manual). 	<ul style="list-style-type: none"> ■
RESET: After finding the cause and communication is restored, error can be reset on the controller.		

OU4 : SW VERSION ERR

Purpose

- Indicate if there is a conflict in software versions in the DICN system.

Symptom: The NETWORK SAFETY alarm message shows SW VERSION ERR		
POSSIBLE CAUSES	CORRECTIVE ACTION	CONSEQUENCE
All units in the DICN system (EKACPG) do not have the same software version.	Check the software version of each unit. Call your local dealer in case a software upgrade is necessary.	
RESET: After finding the cause and software is upgraded, error can be reset on the controller.		

3

1.7 Overview of Warnings

Unit warnings overview

UNIT WARNING	0AE:FLOW HAS STOPPED	5.2
	0C9:INL SENSOR ERR	7
	1/2 E3:HP SETBACK	5.7
	1/2 E6:COMPR PR	5.13
	1/2 53:FAN OVERC. ST1	5.4
	1/2 53:FAN OVERC. ST2	5.4
	1/2 53:FAN OVERC. ST3	5.4

Unit warning description

OAE : FLOW HAS STOPPED

Purpose

- Detect if one motor of the twin pump is broken

Symptom: Flowswitch is activated		
POSSIBLE CAUSES	CORRECTIVE ACTION	CONSEQUENCE
No water flow for 5 seconds continuously.	Check the water pump filter and the water circuit for obstructions.	Unit switched off and restart after pump lead of other pump.
RESET: After finding the cause, the flowswitch is reset automatically, but the controller still needs to be reset.		

Remark : only when twin pump is installed.

0C9 : INL SENSOR ERR

Purpose

- Detect if sensor is broken or not good connected (open OR Short circuit)

Symptom: Sensor error		
POSSIBLE CAUSES	CORRECTIVE ACTION	CONSEQUENCE
The sensor is broken or not correctly wired (open or short circuit).	Check if the wiring is according to the wiring diagram.	<ul style="list-style-type: none"> ■ If value is too high (above range) ==> display "+ER". ■ If value is too low (below range) ==> display "-ER".
RESET : Possible to reset (manual) if the value is within range.		

1E3/2E3 : HP SETBACK

Purpose

- Detect high pressure setback on a refrigerant circuit.

Symptom: High pressure switch and high pressure setback		
POSSIBLE CAUSES	CORRECTIVE ACTION	CONSEQUENCE
Condenser fan does not operate properly	Check that the fans turn freely. Clean if necessary.	Unload compressor till only 1 compressor is in operation.
Dirty or partially blocked condenser.	Remove any obstacle and clean condenser coil using brush and blower.	
Inlet air temperature of the condenser is too high.	The air temperature measured at the inlet of the condenser may not exceed 43°C.	
Fan turning in the wrong direction.	Two phases of the power supply to the fan motor must be inverted (by a licensed electrician).	
RESET: After pressure decrease this warning automatically resets.		

1E6/2E6 COMPR PR

Purpose

- Protection of the compressor if the compressor is working outside the operation range.

Symptom: Compressor protection (function of controller) is activated		
POSSIBLE CAUSES	CORRECTIVE ACTION	CONSEQUENCE
Compressor is working outside the operation range	Check the operation condition of the compressor. "Protection control of compressor running area during heating" on page 2-117.	Circuit is switched off.
RESET: When the temperature has returned to normal, the controller resets automatically.		

153/253 : FAN OVERC. 1/2/3

Purpose

- To avoid overheating of the fan motor.

Symptom: Fan overcurrent is activated		
POSSIBLE CAUSES	CORRECTIVE ACTION	CONSEQUENCE
Mechanical failure (fan is blocked)	Check that the fan rotates freely.	Warning or safety displayed on the controller, when warning is selected unit will continue operation.
Air flow in the unit too low or outdoor temperature too high.	Clean the air heat exchanger properly.	
RESET: Push the blue button on the fan fuse inside the switchbox and reset the controller.		

1.8 Overview of Start Problems

Introduction

When a safety device was activated, stop the unit and find out why the safety device was activated before resetting it. Under no circumstances safety devices may be bridged or changed to a value other than the factory setting.

Symptom 1: The unit does not start, but the ON LED lights up.

Possible causes	Corrective action
The temperature setting is not correct.	Check the controller setpoint.
The flowchart timer is still running	The unit will start after approximately 15 seconds. Make sure that water is flowing through the evaporator.
The circuit cannot start up	Refer to Symptom 5: The circuit does not start up.
Unit is in manual mode (all compressors at 0%)	Check on the controller
Power supply failure	Check the voltage on supply panel.
Blown fuse or interrupted protection device.	Inspect fuses and protection devices. Replace by fuses of the same size and type.
Loose connections.	Inspect connections of the field wiring and the internal wiring of the unit. Tighten all loose connections.
Shorted or broken wires.	Test circuits using a tester and repair if necessary.

Symptom 2: The unit does not start, but the ON LED is flashing.

Possible causes	Corrective action
The remote ON/OFF input is enabled and the remote switch is off.	Put the remote switch on or disable the remote ON/OFF input.

Symptom 3: The unit does not start and the ON LED does not light up.

Possible causes	Corrective action
The unit is in failure mode.	Check safety devices.
One of the following safety devices is activated: <ul style="list-style-type: none"> ■ Flowswitch (S8L, S9L). ■ Emergency Stop. 	Check safety devices.

Symptom 4 : Unit stops soon after operation.

Possible Causes	Corrective Action
One of the safety devices is activated.	Check safety devices.
Voltage is too low.	Test the voltage in the supply panel and, if necessary, in the electrical compartment of the unit (voltage drop due to supply cables is too high).

Symptom 5: The circuit does not start up.

Possible causes	Corrective action
One of the following safety devices is activated: <ul style="list-style-type: none"> ■ Compressor thermal protector (Q*M) ■ Overcurrent relay (K*S) ■ Discharge thermal protector ■ Low pressure ■ High pressure switch (S*PH) ■ Reverse phase protector ■ Freeze-up 	Check on the controller if the safety device is active.
The anti-recycling timer is still active	The circuit can only start up after approximately 5 minutes.
The Guard timer is still active.	The circuit can only start up after approximately 3 minutes.
The circuit is limited to 0%	Check the enable/disable capacity limitation remote contact.

3

2 Checking the Temperature Sensors

Introduction

If the cause of the problem is related to the temperature sensors, the sensors should be checked prior to changing the PCB or an output device.

Temperature Sensors

In multiple scroll software, four different types of NTP temp sensors are programmed. On the unit, only NTC type 1 and 2 are actually used. In this chapter, the resistance/temp table is described.

How to check

To check the temperature sensors, proceed as follows:

Step	Action
1	Disconnect the sensor from the PCB.
2	Measure the temperature and the resistance value.
3	Check whether the measured values correspond with the values in the appropriate table.

Temperature Sensor Types

The table below contains the four different sensor types programmed in the controller.

Type	Also used in the following units
Type 1: PF-46 F (ST8602/8603/8604 use PB-46F)	Temp Sensor Sky Air/VRV/ DENV scroll chillers
Type 2: ST 8606	Discharge sensor Sky Air / VRV
Type 3: PB-43	Water temp DIL screw chillers
Type 4: Carel Sensor	Water temp DENV scroll and screw chillers

Temperature Sensor List

The table below contains the list with the sensor name and the sensor type used in the unit.

Part number	Description	
R1T	ambient temperature sensor	Type 1
R2T	inlet water temperature sensor	Type 1
R3T	outlet water temperature sensor	Type 1

Part number		Description	
R8T	*	temperature sensor for changeable analog input	Type 1 or 2 or 3 or 4 (Configurable in the service input/output menu)
R14T		suction temperature sensor circuit 1	Type 1
R15T, R25T		discharge temperature sensor circuit 1	Type 2
R16T		coil temperature sensor circuit 1 (Only for EWYQ)	Type 1
R17T		refrigerant piping temperature sensor circuit 1	Type 1
R18T, R38T		heating suction temperature sensor circuit 1, circuit 2 (only EWYQ)	Type 1
R28T, R48T		heating suction temperature sensor circuit 1, circuit 2 (only EWYQ 80-100/230-250)	Type 1
R26T		coil temperature sensor circuit 1 (only for EWYQ 80-100/230-250).	Type 1
R34T		suction temperature sensor circuit 2	Type 1
R35T, R45T		discharge temperature sensor circuit 2	Type 2
R36T		coil temperature sensor circuit 2 (only for EWYQ)	Type 1
R37T		refrigerant piping temperature sensor circuit 2	Type 1
R46T		coil temperature sensor circuit 2 (only for EWYQ230-250)	Type 1

* Not included with standard unit (not possible as option + not obligatory).

2.1 Temperature and resistance characteristics of thermistor type 1

Temp.-resistance The table below contains the temperature resistance values of sensor type 1.

Temp. (°C)	Resistance (kΩ)	
	At x.0°C	At x.5°C
-20	197.81	192.08
-19	186.53	181.16
-18	175.97	170.94
-17	166.07	161.36
-16	156.80	152.38
-15	148.10	143.96
-14	139.94	136.05
-13	132.28	128.63
-12	125.09	121.66
-11	118.34	115.12
-10	111.99	108.96
-9	106.03	103.18
-8	100.41	97.73
-7	95.14	92.61
-6	90.17	87.79
-5	85.49	83.25
-4	81.08	78.97
-3	76.93	74.94
-2	73.01	71.14
-1	69.32	67.56
0	65.84	64.17
1	62.54	60.96
2	59.43	57.94
3	56.49	55.08
4	53.71	52.38
5	51.09	49.83
6	48.61	47.42
7	46.26	45.14
8	44.05	42.98
9	41.95	40.94
10	39.96	39.01
11	38.08	37.18
12	36.30	35.45
13	34.62	33.81

Temp. (°C)	Resistance (kΩ)	
	At x.0°C	At x.5°C
14	33.02	32.25
15	31.50	30.77
16	30.06	29.37
17	28.70	28.05
18	27.41	26.78
19	26.18	25.59
20	25.01	24.45
21	23.91	23.37
22	22.85	22.35
23	21.85	21.37
24	20.90	20.45
25	20.00	19.56
26	19.14	18.73
27	18.32	17.93
28	17.54	17.17
29	16.80	16.45
30	16.10	15.76
31	15.43	15.10
32	14.79	14.48
33	14.18	13.88
34	13.59	13.31
35	13.04	12.77
36	12.51	12.25
37	12.01	11.76
38	11.52	11.29
39	11.06	10.84
40	10.63	10.41
41	10.21	10.00
42	9.81	9.61
43	9.42	9.24
44	9.06	8.88
45	8.71	8.54
46	8.37	8.21
47	8.05	7.90

Temp. (°C)	Resistance (kΩ)	
	At x.0°C	At x.5°C
48	7.75	7.60
49	7.46	7.31
50	7.18	7.04
51	6.91	6.78
52	6.65	6.53
53	6.41	6.53
54	6.65	6.53
55	6.41	6.29
56	6.18	6.06
57	5.95	5.84
58	5.74	5.43
59	5.14	5.05
60	4.96	4.87
61	4.97	4.70
62	4.62	4.54
63	4.46	4.38
64	4.30	4.23
65	4.16	4.08
66	4.01	3.94
67	3.88	3.81
68	3.75	3.68
69	3.62	3.56
70	3.50	3.44
71	3.38	3.32
72	3.27	3.21
73	3.16	3.11
74	3.06	3.01
75	2.96	2.91
76	2.86	2.82
77	2.77	2.72
78	2.68	2.64
79	2.60	2.55
80	2.51	2.47
—		

2.2 Temperature and resistance characteristics of thermistor type 2

Temp-resistance

The table below contains the temperature resistance values of the sensor type 2.

T°C	(kΩ)		T°C	(kΩ)		T°C	(kΩ)	
	0.0	0.5		0.0	0.5		0.0	0.5
0	640.44	624.65	50	72.32	70.96	100	13.35	13.15
1	609.31	594.43	51	69.64	68.34	101	12.95	12.76
2	579.96	565.78	52	67.06	65.82	102	12.57	12.38
3	552.00	538.63	53	64.60	63.41	103	12.20	12.01
4	525.63	512.97	54	62.24	61.09	104	11.84	11.66
5	500.66	488.67	55	59.97	58.87	105	11.49	11.32
6	477.01	465.65	56	57.80	56.75	106	11.15	10.99
7	454.60	443.84	57	55.72	54.70	107	10.83	10.67
8	433.37	423.17	58	53.72	52.84	108	10.52	10.36
9	413.24	403.57	59	51.98	50.96	109	10.21	10.06
10	394.16	384.98	60	49.96	49.06	110	9.92	9.78
11	376.05	367.35	61	48.19	47.33	111	9.64	9.50
12	358.88	350.62	62	46.49	45.67	112	9.36	9.23
13	342.58	334.74	63	44.86	44.07	113	9.10	8.97
14	327.10	319.66	64	43.30	42.54	114	8.84	8.71
15	312.41	305.33	65	41.79	41.06	115	8.59	8.47
16	298.45	291.73	66	40.35	39.65	116	8.35	8.23
17	285.18	278.80	67	38.96	38.29	117	8.12	8.01
18	272.58	266.51	68	37.63	36.98	118	7.89	7.78
19	260.60	254.72	69	36.34	35.72	119	7.68	7.57
20	249.00	243.61	70	35.11	34.51	120	7.47	7.36
21	238.36	233.14	71	33.92	33.35	121	7.26	7.16
22	228.05	223.08	72	32.78	32.23	122	7.06	6.97
23	218.24	213.51	73	31.69	31.15	123	6.87	6.78
24	208.90	204.39	74	30.63	30.12	124	6.69	6.59
25	200.00	195.71	75	29.61	29.12	125	6.51	6.42
26	191.53	187.44	76	28.64	28.16	126	6.33	6.25
27	183.46	179.57	77	27.69	27.24	127	6.16	6.08
28	175.77	172.06	78	26.79	26.35	128	6.00	5.92
29	168.44	164.90	79	25.91	25.49	129	5.84	5.76
30	161.45	158.08	80	25.07	24.66	130	5.69	5.61
31	154.79	151.57	81	24.26	23.87	131	5.54	5.46
32	148.43	145.37	82	23.48	23.10	132	5.39	5.32
33	142.37	139.44	83	22.73	22.36	133	5.25	5.18
34	136.59	133.79	84	22.01	21.65	134	5.12	5.05
35	131.06	128.39	85	21.31	20.97	135	4.98	4.92
36	125.79	123.24	86	20.63	20.31	136	4.86	4.79
37	120.76	118.32	87	19.98	19.67	137	4.73	4.67
38	115.95	113.62	88	19.36	19.05	138	4.61	4.55
39	111.35	109.13	89	18.75	18.46	139	4.49	4.44
40	106.96	104.84	90	18.17	17.89	140	4.38	4.32
41	102.76	100.73	91	17.61	17.34	141	4.27	4.22
42	98.75	96.81	92	17.07	16.80	142	4.16	4.11
43	94.92	93.06	93	16.54	16.29	143	4.06	4.01
44	91.25	89.47	94	16.04	15.79	144	3.96	3.91
45	87.74	86.04	95	15.55	15.31	145	3.86	3.81
46	84.38	82.75	96	15.08	14.85	146	3.76	3.72
47	81.16	79.61	97	14.62	14.40	147	3.67	3.62
48	78.09	76.60	98	14.18	13.97	148	3.58	3.54
49	75.14	73.71	99	13.76	13.55	149	3.49	3.45
50	72.32	70.96	100	13.35	13.15	150	3.41	3.37

2.3 Temperature and Resistance characteristics of Thermistor Type 3

Introduction The thermistors in use have the following temperature (°C) to resistance (K Ω) characteristics.

Explanation X-Axis: indicates tens digit (°C).

Y-Axis : Indicates ones digit (°C).

In the case of -9°C characteristics : -10 + 1 = -9.

Therefore, see the characteristics (K Ω) at the intersection of -10 (tens digit) and 1 (ones digit).

Similarly, in the case of 12°C characteristics : 10 + 2 = 12.

Therefore, see the characteristics (K Ω) at the intersection of 10 (tens digit) and 2 (ones digit).

The table below contains the temperature resistance values of sensor type 3.

Temp.-resistance

	-10	0	10	20	30	40	50
0	48.5	30.0	19.2	12.7	8.6	6.0	4.3
1	46.1	28.6	18.4	12.2	8.3	5.8	4.1
2	43.9	27.4	17.6	11.7	8.0	5.6	4.0
3	41.8	26.2	16.9	11.2	7.7	5.4	3.9
4	39.8	25.0	16.2	10.8	7.4	5.2	3.7
5	38.0	23.9	15.5	10.4	7.1	5.0	3.6
6	36.2	22.9	14.9	10.0	6.9	4.9	3.5
7	34.5	21.9	14.3	9.6	6.6	4.7	3.4
8	32.9	20.9	13.7	9.3	6.4	4.5	3.3
9	31.4	20.1	13.2	8.9	6.2	4.4	3.2

Example: characteristics at -9°C

	-10	0	10
0	↓		
1	→	46.1	
2			

Example: characteristics at 12°C

	-10	0	10
0			↓
1			↓
2		→	17.6

2.4 Temperature and resistance characteristics of thermistor type 4.

Temp.-resistance The table below contains the temperature resistance values of sensor type 4.

Temp. (°C)	Resistance (kΩ)		
	Maximum	Standard	Minimum
-50	344.40	329.20	314.70
-49	324.70	310.70	297.20
-48	306.40	293.30	280.70
-47	289.20	277.00	265.30
-46	273.20	261.80	250.60
-45	258.10	247.50	237.20
-44	244.00	234.10	224.60
-43	230.80	221.60	212.70
-42	218.50	209.80	201.50
-41	206.80	198.70	191.00
-40	195.90	188.40	181.10
-39	185.40	178.30	171.59
-38	175.50	168.90	162.00
-37	166.20	160.10	154.10
-36	157.50	151.80	140.20
-35	149.30	144.00	138.80
-34	141.60	136.60	131.80
-33	134.40	129.70	125.20
-32	127.60	123.20	118.90
-31	121.20	117.10	113.10
-30	115.10	111.30	107.50
-29	109.30	105.70	102.20
-28	103.80	100.40	97.16
-27	98.63	95.47	92.41
-26	93.75	90.80	87.93
-25	89.15	86.39	83.70
-24	84.82	82.22	79.71
-23	80.72	78.29	75.93
-22	76.85	74.58	72.36
-21	73.20	71.07	68.99
-20	69.74	67.74	65.80
-19	66.42	64.54	62.72
-18	63.27	61.52	59.81
-17	60.30	58.66	57.05
-16	57.49	55.95	54.44
-15	54.83	53.39	51.97
-14	52.31	50.96	49.83
-13	49.93	48.66	47.12
-12	47.67	46.48	45.31
-11	45.53	44.41	43.32
-10	43.50	42.25	41.43
-9	41.54	40.56	39.59
-8	39.68	38.76	37.85
-7	37.91	37.05	36.20
-6	36.24	35.43	34.03
-5	34.65	33.89	33.14
-4	33.14	32.43	31.73
-3	31.71	31.04	30.39
-2	30.35	29.72	29.11
-1	20.00	28.47	27.89
0	27.83	27.28	26.74
1	26.64	26.13	25.62
2	25.51	25.03	24.55
3	24.24	23.99	23.54

Temp. (°C)	Resistance (kΩ)		
	Maximum	Standard	Minimum
4	23.42	22.99	22.57
5	22.45	22.05	21.66
6	21.52	21.15	20.78
7	20.64	20.29	19.95
8	19.80	19.40	19.15
9	19.00	18.70	18.40
10	18.24	17.96	17.67
11	17.51	17.24	16.97
12	16.80	16.55	16.31
13	16.13	15.90	15.87
14	15.50	15.28	15.06
15	14.89	14.68	14.48
16	14.31	14.12	13.93
17	13.75	13.57	13.40
18	13.22	13.06	12.89
19	12.72	12.56	12.41
20	12.23	12.09	11.95
21	11.77	11.63	11.07
22	11.32	11.20	11.07
23	10.90	10.78	10.60
24	10.49	10.38	10.27
25	10.10	10.00	9.90
26	9.73	9.63	9.52
27	9.38	9.28	9.18
28	9.04	8.94	8.84
29	8.72	8.62	8.52
30	8.41	8.31	8.21
31	8.11	8.01	7.91
32	7.82	7.72	7.62
33	7.55	7.45	7.35
34	7.28	7.19	7.09
35	7.03	6.94	6.84
36	6.79	6.69	6.60
37	6.56	6.46	6.37
38	6.33	6.24	6.15
39	6.12	6.03	5.94
40	5.92	5.82	5.73
41	5.72	5.63	5.54
42	5.53	5.43	5.35
43	5.34	5.25	5.17
44	5.16	5.08	4.99
45	4.99	4.91	4.82
46	4.83	4.74	4.66
47	4.67	4.59	4.51
48	4.52	4.44	4.36
49	4.38	4.30	4.22
50	4.24	4.16	4.08
51	4.10	4.02	3.95
52	3.97	3.90	3.82
53	3.84	3.77	3.69
54	3.72	3.65	3.57
55	3.61	3.53	3.46
56	3.49	3.42	3.35
57	3.39	3.31	3.24

Temp. (°C)	Resistance (kΩ)		
	Maximum	Standard	Minimum
58	3.28	3.21	3.14
59	3.18	3.11	3.04
60	3.09	3.02	2.95
61	2.99	2.92	2.86
62	2.90	2.83	2.77
63	2.81	2.75	2.69
64	2.73	2.66	2.60
65	2.65	2.58	2.52
66	2.57	2.51	2.45
67	2.49	2.43	2.37
68	2.42	2.36	2.30
69	2.35	2.29	2.24
70	2.28	2.22	2.17
71	2.21	2.16	2.10
72	2.15	2.10	2.04
73	2.09	2.04	1.98
74	2.03	1.98	1.93
75	1.97	1.92	1.87
76	1.92	1.87	1.82
77	1.86	1.81	1.78
78	1.81	1.76	1.71
79	1.76	1.71	1.68
80	1.71	1.66	1.62
81	1.66	1.62	1.57
82	1.62	1.57	1.53
83	1.57	1.53	1.49
84	1.53	1.49	1.44
85	1.49	1.45	1.40
86	1.45	1.41	1.37
87	1.41	1.37	1.33
88	1.37	1.33	1.29
89	1.34	1.30	1.26
90	1.30	1.26	1.22
91	1.27	1.23	1.19
92	1.23	1.20	1.16
93	1.20	1.16	1.13
94	1.17	1.13	1.10
95	1.14	1.10	1.07
96	1.11	1.08	1.04
97	1.08	1.05	1.01
98	1.05	1.02	0.99
99	1.03	0.99	0.96
100	1.00	0.97	0.94
101	0.98	0.94	0.91
102	0.95	0.92	0.89
103	0.93	0.90	0.87
104	0.91	0.87	0.84
105	0.88	0.85	0.82
106	0.86	0.83	0.80
107	0.84	0.81	0.78
108	0.82	0.79	0.76
109	0.80	0.77	0.74
110	0.78	0.75	0.73
—			

3 Reset procedure

3.1 Introduction

For all safeties, a login with the user password (default) is required to reset a safety.

User password is mentioned in the operation manual.

Service password is known by the service technician.

3.2 Login/Logout

When a user is logged in with the password equal to the password needed to reset safeties, no password will be asked to reset a safety.

Login function:

- Without a login (ex. At startup= no password in login menu), then a limited menus are available.
 - A user can login with the user password, then all menus with user parameters are available.
 - A service man can login with the service password, then all menus with user/service parameters are available.
 - A login can be done in login/logout menu OR if password is requested at first screen of protected menu.
 - A logout is possible in the login/logout menu.
 - An automatically logout (jump to the first screen in readout menu) is done if no buttons are pushed for 5 minutes (default)
- 1 Warnings ==> no password is required to reset a warning (remark: warning is always logged in history menu).
 - 2 Switch main power off will remember active safeties.
 - 3 Number of reset: if the same error happens 3 times in 1 hour then the level to reset is put 1 level higher.
Default case: in case reset safety is protected by user password ==> 1 level higher means service password. In case reset safety is protected by no password ==> 1 level higher means user password.
Remark : not in case reset safety is already protected by service password.
 - 4 A backup reset password is present ==> Only possible to reset safeties (meaning no actual login value).
This backup reset password is based on a calculation result on the number of safeties that are present in the history.
(Example: number of safeties in history. 50 ==> result calculation : 3398)
This means it can only be used 1 time, because next time the number of history will be different.

4 Procedure for Software Upload

4.1 What is in this chapter

Overview

This chapter contains the following topics:

Topic	See page
4.2–Overview hardware software/Source files	3–34
4.3–Software upload procedure: PCASOfash	3–35
4.4–Installation of PCASOfash Software	3–40
4.5–Overview of most common problems	3–41

4.2 Overview hardware software/Source files

3

1. Hardware	Laptop PC (windows 2000 or windows xp)		
	Serial cable: DENV part number: 999480P Description: "RS-232C Cable included driver assy"		
			
	This cable exists out of 2 pieces: RS-232C Cable incl drive assy		
	Adapter cable with label "R" (Remark: Similar cables of VRV have labels "A", instead of "R")		Use in combination with PCASOfash software
	Remark: A USB / RS232 can be used to connect the serial cable to a USB port.		
2. Software	Power supply (230VAC)		
	SW program	Source files	Source files example
	PCASOfash	Main PCB Logic file (*.lgc) Remocon PCB Logic file (*.lgc) Language file (*.lng) Parameter file (*.par)	Multiple scroll chillers: sp1710_XXX.lgc SP1734_XXX.lgc SP1734_XXX.lng 4PW30697-X-XX.par

4.3 Software upload procedure: PCASOfash

Introduction



The upload of the parameters can be executed on **Main PCB nr 1 only**.

The upload of the Software and parameters can be executed on **Main PCB nr 1 only**. After this the software is distributed by the Main PCB nr 1 towards the Main PCB nr 2, the extension PCB and towards the Main and sub remocon.

(If PCASOfash is not installed yet: refer to chapter “install software PCASOfash”)

**PCASOfash:
manual upload**

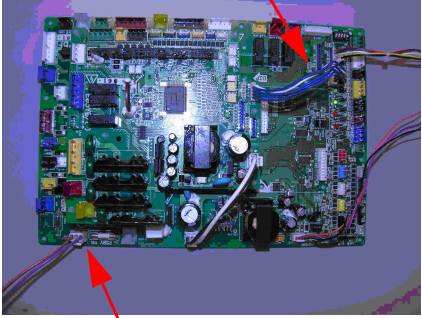
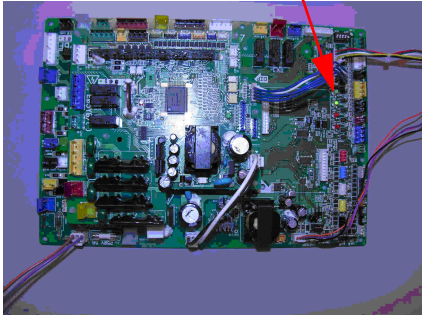
Remark: all lgc and lng and par files should be put in 1 directory!

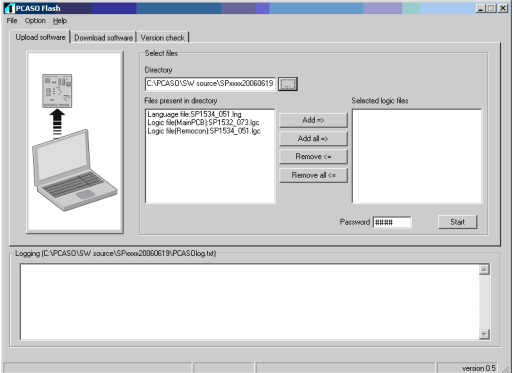
Action	Result
<p>Connect wires:</p> <p>Communication: X49A ⇔ RS-232C Cable incl drive assy+ adapter cable with label “R”</p> <p>Power: X1A ⇔ 230V</p> <p>Remark: PCB should be continuously powered.</p> <p style="text-align: center;">X49A Serial communication</p>  <p style="text-align: center;">X1A power (230V)</p>	<p>Result:</p> <p>HAP is blinking</p> <p>Remark: In case HAP is continuously On, then the wrong adapter cable is used.</p> <p style="text-align: center;">HAP</p> 
<p>2. Start PCASOfash.exe</p> 	<p>Result: PCASO flash main window</p>  <p>By default: “Upload software sheet” is selected</p>

3

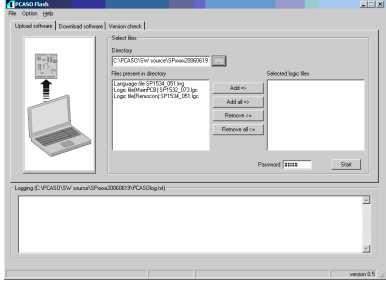
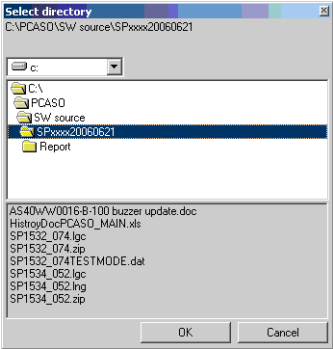
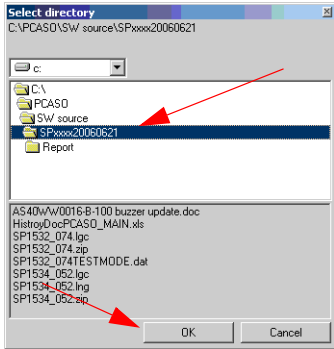
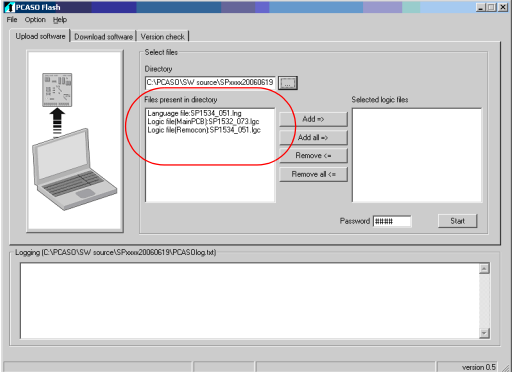
Action	Result
<p>3. Select directory by pushing "..."</p> 	<p>Result:</p>  <p>(Remark: all the files present in a directory are continuously shown)</p>
<p>4. select correct directory and push OK</p> <p>(Remark: all the files present in a directory are continuously shown)</p> 	<p>Result: All lgc and lng files in the selected directory are shown.</p> 

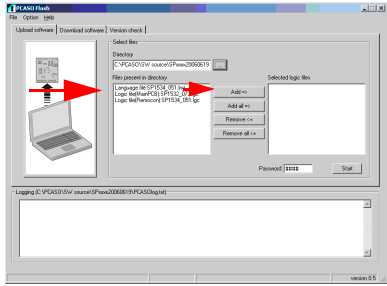
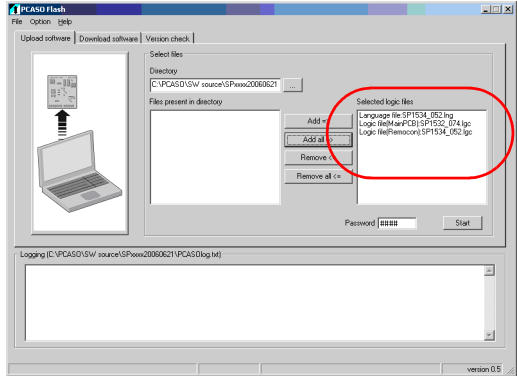
Action	Result
<p data-bbox="432 271 852 327">4. Select files to be uploaded and push “Add=>”</p>  <p data-bbox="432 689 852 745">(Or in case all files can be uploaded push “Add all =>”)</p> <p data-bbox="432 779 852 864">(Remark: if correct software is already present, then it is possible only to select a parameter file)</p>	<p data-bbox="895 271 1437 304">Result: A selection of files to be uploaded is made.</p> 

3

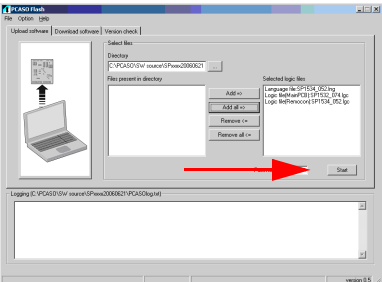
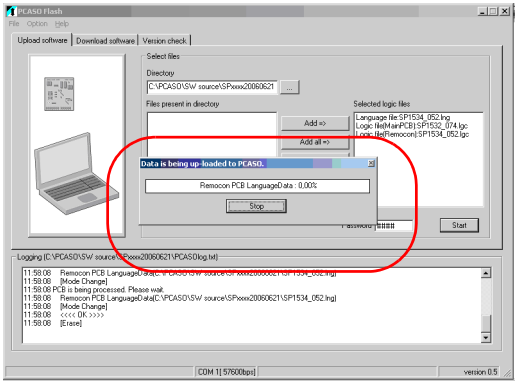
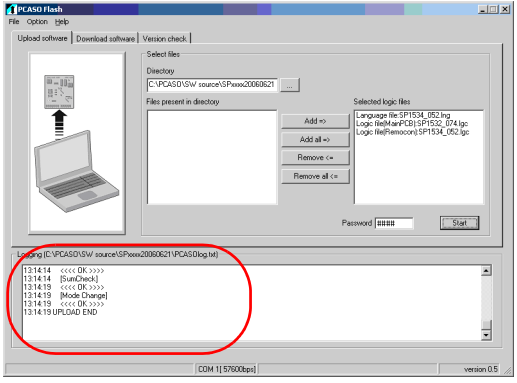
Action	Result
<p>6. Push Start</p>  <p>(Remark: default password is 0000 and must not be modified)</p>	<p>Result:</p>  <p>A pop-up window will show progress and progress is recorded in logging-area. During upload:</p> <ul style="list-style-type: none"> ■ MainRemocon display: “-PCB SW UPLOAD BUSY-” ■ SubRemocon display: “-PCB SW UPLOAD BUSY-” (if present)
	<p>Result should be OK at the end. (Remark: Upload by PCASOfash can take up to +- 4 min.) (Remark: if result is OK, then communication cable can be removed)</p> 
	<p>If uploading ended correctly</p> <p>then Main PCB nr 1 will automatically distribute software towards Main PCB nr 2 (if present)</p> <ul style="list-style-type: none"> ■ MainRemocon display “----STARTUP BUSY----” ■ SubRemocon display “----STARTUP BUSY----” (if present)
	<p>After this Main PCB nr 1 will automatically distribute software towards Remocon PCB Main (if present):</p> <ul style="list-style-type: none"> ■ MainRemocon display “-REM.SW UPLOAD BUSY-” ■ SubRemocon display “----STARTUP BUSY----” (if present)

Action	Result
	After this then Main PCB nr 1 will automatically distribute software towards Remocon PCB Sub (if present) <ul style="list-style-type: none"> ■ MainRemocon display “----STARTUP BUSY----“ ■ SubRemocon display “-REM.SW UPLOAD BUSY-“
	After this the normal initialization procedure will start <ul style="list-style-type: none"> ■ MainRemocon display “----STARTUP BUSY----“ ■ SubRemocon display “----STARTUP BUSY----“
	When distribution and initialization procedure ended normally then readout screen is shown on display of remocon <ul style="list-style-type: none"> ■ MainRemocon display: Readout screen ■ SubRemocon display: Readout screen
	Remark: The distribution and initialization can take up to +-16 min.

4.4 Installation of PCASOfash Software

Only needed if software is not yet present on PC.

Remark: Only possible to install if user has administrator rights.

Necessary files: PCASOfash0xx.msi. (xx depending on version)

- To install PCASOfash software: execute PCASOfash0xx.msi.
Select Each time Next when required.
Remark: When “Error 1913” message is shown, select OK (this has no influence on the good functioning of the software)

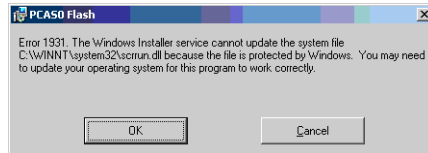

- To install a newer PCASOfash software, it is required to first remove the existing PCASOfash software as follows: execute PCASOfash0xx.msi.
Select “Remove PCAS0 flash” and push next.



3

4.5 Overview of most common problems

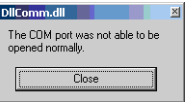
PCASO flash	
Symptom	Possible cause
1. Not possible to start upload	<ul style="list-style-type: none"> ■ No connection to Main PCB nr 1 ■ Main PCB nr 1 has no power ■ Wrong adapter cable is used. ("R" label)
2. Upload stops after certain %	<ul style="list-style-type: none"> ■ Serial connection has been cut
3. 	<ul style="list-style-type: none"> ■ ex. Debugmonitor is also running => close program ■ Visa software is running (can be checked status bar next to time)=> close program
4. After upload never display on remocon or continuously "STARTUP BUSY"	<ul style="list-style-type: none"> ■ Remocon has been uploaded with wrong mot file. ■ Remocon Main and Sub have same address (ex. Main & Main or Sub & Sub)
5. Not possible to select the different software files from different directories	<ul style="list-style-type: none"> ■ The different software files should be put in one directory.

3

5 Procedure for main PCB changing

5.1 Changing the main PCB

To change the Main PCB nr1 (circuit 1) or Main PCB nr 2 (circuit 2), proceed as follows:

Step	Action
1	Turn off the power supply.
2	Remove the connections of the old PCB.
3	Remove the old PCB, also remove the extension PCB if present (only on Main PCB of circuit 1) and communication PCB if present.
4	Place the new PCB in the same way as the old PCB, also place back the extension PCB and communication PCB, if present in the same way.
5	Reconnect the PCB.

5.2 Configuration of Main PCB nr 1

To start the configuration of Main PCB nr 1, proceed as follows:

Step	Action
1	Set the address dipswitch S1A to the right address, Main PCB nr. & (circuit 1) : address 1.
2	Upload the software to Main PCB nr 1, see "Installation of PCASOfash Software" on page 3–40.
3	After programming switch on/off power supply.
4	Wait until the Main PCB nr 1 has finished the automatic distribution of software towards Main PCB nr 2 (if present) and Main.Sub Remocon display.
5	After this the normal initialization procedure will start. Main Remocon displays : "----- STARTUP BUSY -----"
6	If Inverterfans/VA meter/2 pump or heatertape is present on the unit, enter the service/input output menu and enable the unit options. Confirm after changing unit options.

5.3 Configuration of Main PCB nr 2

To start the configuration of Main PCB nr 2, proceed as follows :

Step	Action
1	Set the address dipswitch SIA to the right address. Main PCB nr 2 (circuit 2) : address 2.
2	Switch on the power supply.
3	The Main PCB nr 1 will automatically distribute the software towards Main PCB nr 2.
4	After this the normal initialization procedure will start. Main Remocon displays: “----- STARTUP BUSY -----”.

3

6 Procedure for extension PCB changing

6.1 Changing the extension PCB

To change the extension PCB, proceed as follows:

Step	Action
1	Turn off the power supply.
2	Remove the connections of the old PCB.
3	Remove the old PCB.
4	Place the new PCB in the same way as the old PCB.
5	Reconnect the PCB.

6.2 Configuration of the extension PCB

When the extension PCB is replaced, no software has to be uploaded and no parameters have to be set. The main PCB will upload the software to the extension PCB.

3

7 Procedure for controller changing

7.1 Changing the Main Controller

To change the Main Controller or Subcontroller display, proceed as follows:

Step	Action
1	Turn off the power supply.
2	Remove the 4 wires on the back of the controller.
3	Place the new controller in the same way as the old controller.
4	Reconnect the 4 wires on the back of the controller.

7.2 Configuration of the Main Controller

To start the configuration of the Main Controller, proceed as follows:

Step	Action
1	Set the address dipswitch S1A to "MAIN".
2	<p>If no sub controller is connected :</p> <ul style="list-style-type: none"> ■ Set the Term dipswitch S2A to "ON". <p>If a sub controller is connected :</p> <ul style="list-style-type: none"> ■ Set the Term dipswitch S2A to "OFF".
3	Switch on the power supply.
4	The Main PCB nr 1 will automatically distribute the software towards the controller. Main controller will display "----- STARTUP BUSY -----" during distribution.
5	After this, the normal initialization procedure will start. Main Remocon displays: "----- STARTUP BUSY -----".

7.3 Configuration of the Sub Controller

To start the configuration of the subcontroller, proceed as follows:

Step	Action
1	Set the address dipswitch S1A to "SUB".
2	Set the Term dipswitch S2A to "ON".

Step	Action
3	Switch on the "power supply".
4	The main PCB nr 1 will automatically distribute the software towards the controller. Subcontroller will display " ----- REM. SW UPLOAD BUSY -----" during distribution.
5	After this, the normal initialization procedure will start. Sub Remocon displays : "----- STARTUP BUSY -----".

8 Procedure for EEV PCB changing

8.1 Changing the EEV PCB

To change the EEVPCB, proceed as follows:

Step	Action
1	Turn off the power supply.
2	Remove the connections of the old PCB.
3	Remove the old PCB.
4	Place the new PCB in the same way as the old PCB.
5	Reconnect the PCB.

8.2 Configuration of EEV PVB

To start the configuration of the EEV PCB, proceed as follows:

Step	Action
1	Set the address dipswitch DS1 to the right address : <ul style="list-style-type: none"> ■ A7IP : address 1. ■ A72P : address 2 (only for EWYQ). ■ A73P : address 3 (only for EWYQ 230-250).

3

9 Procedure for compressor replacement : Suction washer

9.1 Introduction

To maintain an equal oil level in 2 compressors, a suction washer is used (in some compressor setup). Therefore it is very important that the right suction washer is used during a compressor replacement.

9.2 Use of Suction Washer

1) C/O unit

When the two tandem compressors are unequal, a restrictor is mounted in the suction of the smallest compressor in order to create a pressure drop in the suction and in such way, when the compressors are in operation, maintain an equal oil level in the 2 compressors. Without this ring, the oil level would be higher in the biggest compressor and in some conditions cause too low oil level in the smallest compressor (especially applications with low LWE and high ambient).

Overview

Cooling only unit	Smallest compressor	Biggest compressor
Equal compressors	No suction washer needed.	
Unequal compressors	Suction washer installed.	No suction washer installed.

2) H/P unit

When the two tandem compressors are unequal, a restrictor is mounted in the suction of the smallest compressor, also when the two tandem compressors are equal a restrictor is mounted in the compressor that is closed to the 4-way valve (special piping is causing small pressure drop) in such way, when the compressors are in operation, maintain an equal oil level in the 2 compressors. Without the ring, the oil level would be higher in one of the compressors and in some conditions cause to low oil level in the compressor that is close to the 4-way valve (especially applications with low LWE and high ambient).

Overview

Heatpump only unit	Smallest compressor	Biggest compressor
Equal compressors	Suction washer needed in compressor that is closed to the 4-way valve	
Unequal compressors	Suction washer installed.	No suction washer installed.

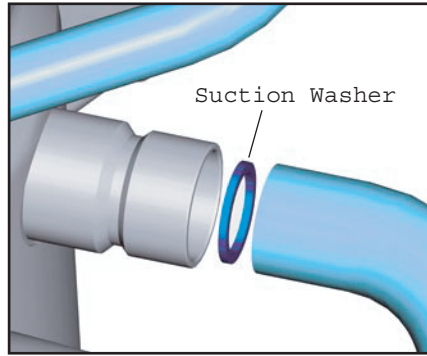

The table below contains an overview of the compressor configuration and the used suction washer (if needed) for the cooling only units.

3

Cooling only unit	
Compressor Configuration	Conclusion
SJ161-SJ161	No restriction
SJ180-SJ180	No restriction
SJ180-SJ240	Use a 31 mm restrictor on SJ 180
SJ240-SJ240	No restriction
SJ240-SJ300	Use a 31 mm restrictor on SJ 240
SJ300-SJ300	No restriction

The table below contains an overview of the compressor configuration and the used suction washer for the heat pump unit.

Heat pump unit	
Compressor Configuration	Conclusion
SJ161-SJ161	Use a 27 mm restrictor on compressor positioned on the 4 way valve side.
SJ180-SJ180	Use a 31 mm restrictor on compressor positioned on the 4 way valve side.
SJ180-SJ240	Use a 31 mm restrictor on SJ180 compressor.
SJ240-SJ240	Use a 31 mm restrictor on compressor positioned on the 4 way valve side.
SJ240-SJ300	Use a 31 mm restrictor on SJ240 compressor.
SJ300-SJ300	Use a 31 mm restrictor on compressor positioned on the 4 way valve side.

10 Procedure for Compressor Oil Fill or Oil Drain

10.1 Introduction

An oil fill connection and oil drain connection are present on the compressor to fill or drain the compressor oil in an easy way.

10.2 Compressor connections

Sight glass

All Performer® SJ scroll compressors come equipped with a sight glass which may be used to determine the amount and condition of the oil contained within the sump.

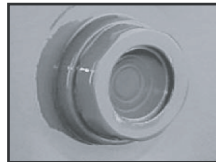

Schrader

The oil fill connection and gauge port is 1/4" male flare connector incorporating a schrader valve.

Oil drain

The oil drain connection allows oil to be removed from the sump for changing, testing, etc. The fitting contains an extension tube into the oil sump to more effectively remove the oil. The connection is a female 1/4" NPT fitting and is mounted on SJ180-240-300 models only.

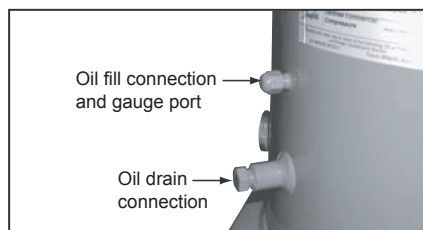

Procedure

To drain the oil :

- 1 Remove the refrigerant from the system (or separate the compressor from the system by use of the suction and discharge valve if present).
- 2 Open the oil drain connection.
- 3 Use the oil fill connection to pressurize the compressor.

To fill the oil :

- 1 Use the oil fill connection to vacuum the compressor.
- 2 Use the oil fill connection to suck the oil in the compressor.

3

11 Compressor electrical connections and wiring

11.1 Electrical connections for SJ161

Electrical power is connected to the compressor terminals by diameter 4,8 mm (3/16") screws. The maximum tightening torque is 3 Nm. Use a 1/4" ring terminal on the power leads.

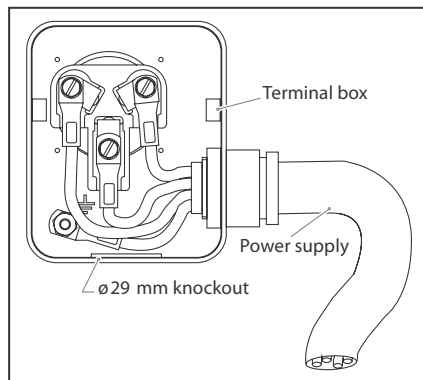

11.2 Electrical connections SJ180

Electrical power is connected to the compressor terminals by diameter 4,8 mm (3/16") screws. The maximum tightening torque is 3Nm. Use a 1/4" ring terminal on the power leads.

The protection rating of the terminal box is IP54.

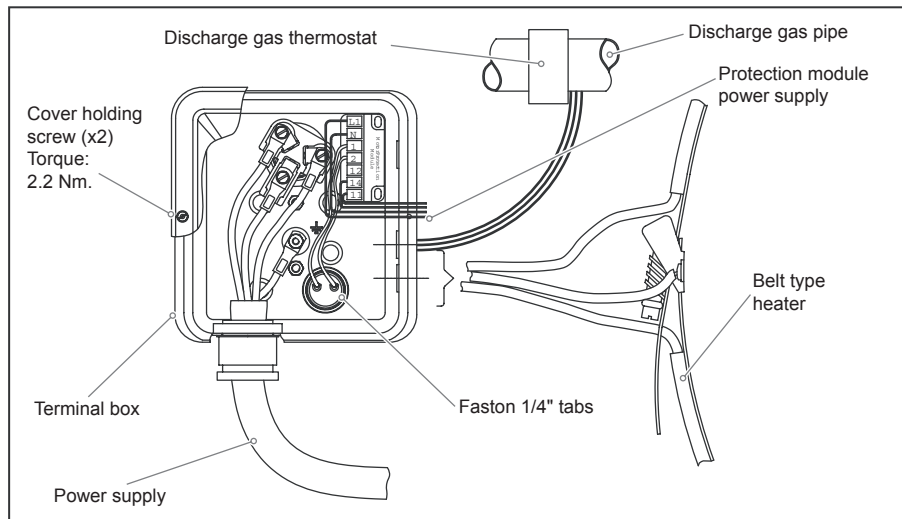

11.3 Electronic protection module wiring

The motor protection module comes preinstalled within the terminal box and has pre-wired thermistor connections. The module must be connected to a power supply of the appropriate voltage.

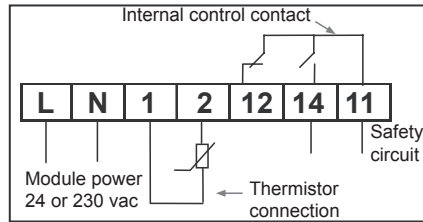

11.4 Electrical connections for SJ240-300

Electrical power is connected to the compressor terminals by the diameter 4.8 mm (3/16") screws. The maximum tightening torque is 3 Nm. Use a 1/4" ring terminal on the power leads.

The protection rating of the terminal box is IP54.

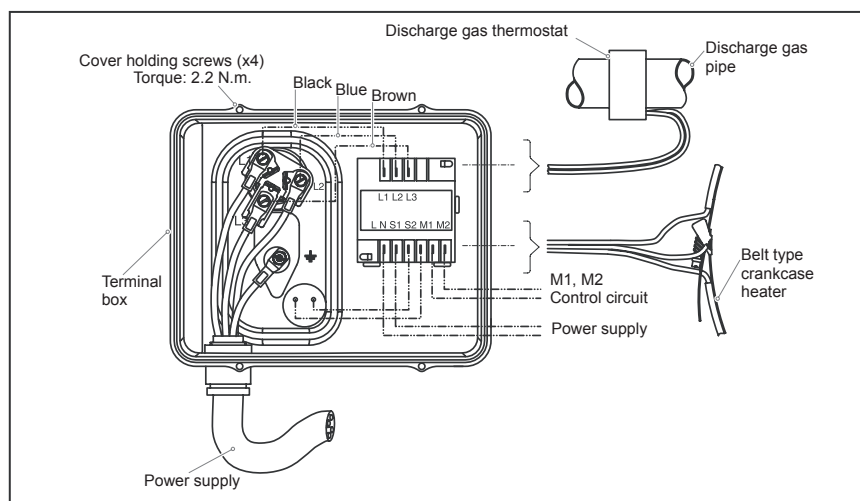

11.5 Electronic protection module wiring

The motor protection module comes preinstalled within the terminal box. Phase sequence protection connections and thermistor connections are pre-wired. The module must be connected to a power supply of the appropriate voltage.

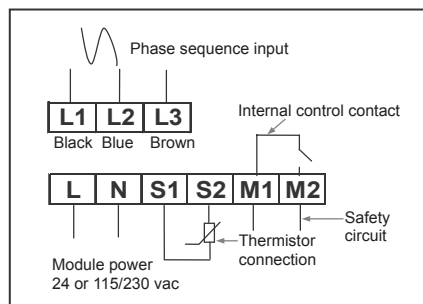

12 Procedure to Clear the Refrigerant Circuit in Case of Frozen Evaporators

If water is detected in the refrigerant circuit after a evaporator damage, the following procedure should be executed to clear the system.

3

Step	Action
1	<p>Cleaning & drying refrigerant circuit.</p> <p>Cleaning components:</p> <ul style="list-style-type: none"> ■ Suction and liquid line. <p>Replace components:</p> <ul style="list-style-type: none"> ■ Sight glass ■ Drier filter element by high density filter ■ Compressor oil <p>Actions:</p> <ul style="list-style-type: none"> ■ Drill a hole in the bottom of the condenser headers to remove water. ■ Braze the drilled holes. ■ Blow dry N₂ trough all the pipes. ■ Drain compressor oil ■ Vacuum the whole installation: <p>Check on a regular base the condition of the oil of the vacuum pump. If the vacuum oil becomes milky, it should be replaced by new vacuum oil. The crankcase heater must be activated. It is advisable to connect a second heater tape at the suction of the compressor.</p> <ul style="list-style-type: none"> ■ Stop the vacuum and purge with dry nitrogen. ■ Restart the vacuum of the installation; check after a couple of hours the condition of the vacuum oil. If OK the unit can be recharged. ■ Charge the unit with R410A. ■ Start the unit & re-commissioning. ■ After 24 hours replace HD filter by new HD filter & replace compressor oil. ■ Check oil contamination with measuring kit. ■ After 48 hours replace HD filter by normal filter drier + check sight glass and pressures.
2	<p>Find the cause of this evaporator breakdown and take the necessary actions to prevent recurrence in the future.</p>

3

Part 4

Commissioning and Test Run

Introduction

Commissioning and test run are well known practices in service engineering. This part contains a systematic approach on test run checks and test values, which guarantees a high quality installation and operation of the units.

What is in this part?

This part contains the following chapters:

Chapter	See page
1-Pre-Test Run Checks	4-3

4

1 Pre-Test Run Checks

1.1 What Is in This Chapter?

Introduction

This chapter contains checks you have to carry out before every test run.

Overview

This chapter contains the following topics:

Topic	See page
1.2–General Checks	4–5
1.3–Water Piping Checks	4–6
1.4–Water Pressure Drop through Evaporator: EWAQ080-100DAYN (N-P-B)	4–11
1.5–Water Pressure Drop through Evaporator: EWAQ130-210DAYN(N-P-B)	4–12
1.6–Water Pressure Drop through Evaporator: EWAQ240-260DAYN (N-P-B)	4–13
1.7–Water Pressure Drop through Evaporator: EWYQ080-100DAYN (N-P-B)	4–14
1.8–Water Pressure Drop through Evaporator: EWYQ130-210DAYN(N-P-B)	4–15
1.9–Water Pressure Drop through Evaporator: EWYQ230-250DAYN(N-P-B)	4–16
1.10–Unit pressure drop : EWAQ080-100DAYNN Standard Model	4–17
1.11–Unit pressure drop : EWAQ130-210DAYNN Standard Model	4–19
1.12–Unit pressure drop : EWAQ240-260DAYNN Standard Model	4–21
1.13–Unit pressure drop : EWYQ080-100DAYNN Standard Unit	4–23
1.14–Unit pressure drop : EWYQ130-210DAYNN Standard Unit	4–25
1.15–Unit pressure drop : EWYQ230-250DAYNN Standard Unit	4–27
1.16–External Static Unit Pressure: EWAQ080-100 DAYN (P-B)	4–29
1.17–External Static Unit Pressure: EWAQ130-210 DAYN (P-B)	4–31
1.18–External Static Unit Pressure: EWAQ240-260DAYN (P-B)	4–32
1.19–External Static Unit Pressure: EWYQ080-100DAYN (P-B)	4–34
1.20–External Static Unit Pressure: EWYQ130-210DAYN (P-B)	4–35
1.21–External Static Unit Pressure: EWYQ230-250DAYN (P-B)	4–36
1.22–External Static Unit Pressure: EWAQ080-100DAYN (OPHP)	4–37
1.23–External Static Unit Pressure: EWAQ130-210DAYN (OPHP)	4–39
1.24–External Static Unit Pressure: EWAQ240-260DAYN (OPHP)	4–40
1.25–External Static Unit Pressure: EWYQ080-100DAYN (OPHP)	4–41
1.26–External Static Unit Pressure: EWYQ130-210DAYN (OPHP)	4–43

Topic	See page
1.27–External Static Unit Pressure: EWYQ230-250DAYN (OPHP)	4–45
1.28–Electrical Checks	4–46
1.29–Field wiring connection diagram : EWAQ/EWYQ 080-260 DAYN*	4–47

1.2 General Checks

Checklist

The table below contains the general checklist.

Step	Check whether...
1	There is external damage.
2	The unit is properly supported and/or has a proper foundation.
3	The unit is installed horizontally with a deviation of maximum 1°.
4	Anti-vibration pads are required.
5	Check for remaining metal dust or burrs. Metal dust or burrs from grinding or drilling in the metal parts during construction facilitates the rust process and shortens the lifetime of the unit.
6	The operator has received the operation manual.
7	The installer has received the installation manual.
8	The air volume over the coil is adequate; there is no blockage (from paper, plastic...) or air short circuit due to wrong positioning.

1.3 Water Piping Checks

Checklist

The table below contains the water piping checklist.

Step	Check whether...
1	The factory mounted water filter is clean.
2	The water volume is within the limits.
3	There is adequate water flow.
4	The water quality meets the standards.
5	The water piping is properly insulated.
6	Measurement points for temperature and pressure are available on the water circuit.
7	The flow switch, pump interlock and pump are properly working.
8	Air purge points are installed on the high parts of the water piping.
9	Drain taps are installed at the low points of the water piping.
10	Other parts of the water circuit are properly mounted and installed (e.g. buffer tank, expansion tank...).
11	Vibration compensators are mounted at the water connections if the unit is positioned on anti-vibration pads.

Water volume, flow and pressure

The table below shows the operation range of water volume and water flow for proper operation of the unit.

Chiller type	Evaporator		
	Minimum water volume	Minimum water flow	Maximum water flow
EWAQ080DAYN*	358 l	115 l/min	459 l/min
EWAQ100DAYN*	470 l	151 l/min	602 l/min
EWAQ130DAYN*	295 l	188 l/min	756 l/min
EWAQ150DAYN*	341 l	218 l/min	871 l/min
EWAQ180DAYN*	522 l	261 l/min	1043 l/min
EWAQ210DAYN*	599 l	300 l/min	1198 l/min
EWAQ240DAYN*	529 l	339 l/min	1355 l/min
EWAQ260DAYN*	569 l	364 l/min	1456 l/min
EWYQ080DAYN*	393 l	110 l/min	503 l/min
EWYQ100DAYN*	511 l	143 l/min	654 l/min
EWYQ130DAYN*	334 l	195 l/min	854 l/min
EWYQ150DAYN*	370 l	208 l/min	946 l/min
EWYQ180DAYN*	446 l	262 l/min	1141 l/min
EWYQ210DAYN*	504 l	302 l/min	1290 l/min
EWYQ240DAYN*	578 l	331 l/min	1479 l/min

Evaporator			
EWYQ250DAYN*	629 l	361 l/min	1611 l/min

The water pressure should not exceed the maximum working pressure of 10bar.

Calculation of the minimum water volume

The calculation method below is based on the fact that the water volume in a chiller should be large enough to prevent the compressor from excessive cycling. Sufficient water volume gives a certain inertia to the system, so that:

- Water (or glycol) temperature does not drop too fast when the unit turns ON.
- Water (or glycol) temperature does not rise too fast when the unit turns OFF.

$$V = \frac{0,5 \times Q \times t}{2 \times \rho \times d \times C_w} \quad [\text{m}^3]$$

with:

Notation	Dimension	Description	Default
V	[m ³]	Required system volume	—
Q	[W]	Cooling capacity at the lowest capacity step of each chiller in the system	—
t	[s]	Minimum cycling time allowed by the compressor	300 s
ρ	[kg/m ³]	Specific mass of the fluid	$\rho_{\text{water}} = 1000 \text{ kg/m}^3$
d	[K]	Thermostat step difference	$d_{\text{inlet water control}} = 4 \text{ K}$
C_w	[J/kgK]	Specific heat capacity of the fluid	$C_{w, \text{water}} = 4186 \text{ J/kgK}$

Water quality

The table below contains the required water quality specifications. It is a table from the JRA (Japanese Refrigerant Assdated GL-02-1994.

Items (1) (5)			Cooling water (3)			Cooled water		Heated water (2)				Tendency if out of criteria	
			Circulating system		Once flow			Low temperature		High temperature			
			Circulating water	Supply water (4)		Flowing water	Circulating water (below 20°C)	Supply water (4)	Circulating water (20°C ~ 60°C)	Supply water (4)	Circulating water (60°C ~ 80°C)		Supply water (4)
Items to be controlled	pH	at 25°C	6.5~8.2	6.0~8.0	6.8~8.0	6.8~8.0	6.8~8.0	7.0~8.0	7.0~8.0	7.0~8.0	7.0~8.0	corrosion + scale	
	Electrical conductivity	(mS/m) at 25°C		below 80	below 30	below 40	below 40	below 30	below 30	below 30	below 30 below 30	corrosion + scale	
	Chloride ion	mgCl ⁻ /l	below 200	below 50	below 50	below 50	below 50	below 50	below 50	below 50	below 30	below 30	corrosion
	Sulfate ion	(mgSO ₄ ²⁻ /l)	below 200	below 50	below 50	below 50	below 50	below 50	below 50	below 50	below 30	below 30	corrosion
	M-alkalinity (ph 4.8)	(mgCaCO ₃ /l)	below 100	below 50	below 50	below 50	below 50	below 50	below 50	below 50	below 50	below 50	scale
	Total hardness	(mgCaCO ₃ /l)	below 200	below 70	below 70	below 70	below 70	below 70	below 70	below 70	below 70	below 70	scale
	Calcium hardness	(mgCaCO ₃ /l)	below 150	below 50	below 50	below 50	below 50	below 50	below 50	below 50	below 50	below 50	scale
	Silica ion	(mgSiO ₂ /l)	Below 50	Below 30	Below 30	Below 30	Below 30	Below 30	Below 30	Below 30	Below 30	Below 30	scale
Items to be referred to	Iron	(mgFe/l)	Below 1.0	Below 0.3	Below 1.0	Below 1.0	Below 0.3	Below 1.0	Below 0.3	Below 1.0	Below 0.3	Corrosion + scale	
	Copper	(mgCu/l)	below 0.3	below 0.1	below 1.0	below 1.0	below 0.1	below 1.0	below 0.1	below 1.0	below 0.1	corrosion	
	Sulfide ion	(mgS ²⁻ /l)	not detectable	not detectable	not detectable	not detectable	not detectable	not detectable	not detectable	not detectable	not detectable	not detectable	corrosion
	Ammonium ion	(mgNH ₄ ⁺ /l)	below 1.0	below 0.1	below 1.0	below 1.0	below 0.1	below 0.3	below 0.1	below 0.1	below 0.1	below 0.1	corrosion
	Remaining chloride	(mgCl/l)	below 0.3	below 0.3	below 0.3	below 0.3	below 0.3	below 0.25	below 0.3	below 0.1	below 0.1	below 0.3	corrosion
	Free carbide	(mgCO ₂ /l)	below 4.0	below 4.0	below 4.0	below 4.0	below 4.0	below 0.4	below 4.0	below 0.4	below 0.4	below 4.0	corrosion
	Stability index		6.0 ~ 7.0	---	---	---	---	---	---	---	---	---	corrosion and scale

4

(2) In case of using heated water (more than 40°C), corrosion is generally noticeable. Especially when the iron material is in direct contact with water without any protection shields. It is desirable to give the valid measures for corrosion e.g. chemical measure.

(3) In the cooling water using hermetic cooling tower, closed circuit water is according to heated water standard and scattered water is according for cooling water standard.

(4) Supply water is considered drink water, industrial water and ground water except for genuine water, neutral water and soft water.

(5) The above mentioned items are representable items in corrosion and scale cases.

1.4 Water Pressure Drop through Evaporator: EWAQ080-100DAYN (N-P-B)

Water pressure drop

The illustration below shows the water pressure drop through evaporator for EWAQ080-100DAYN (N-P-B).

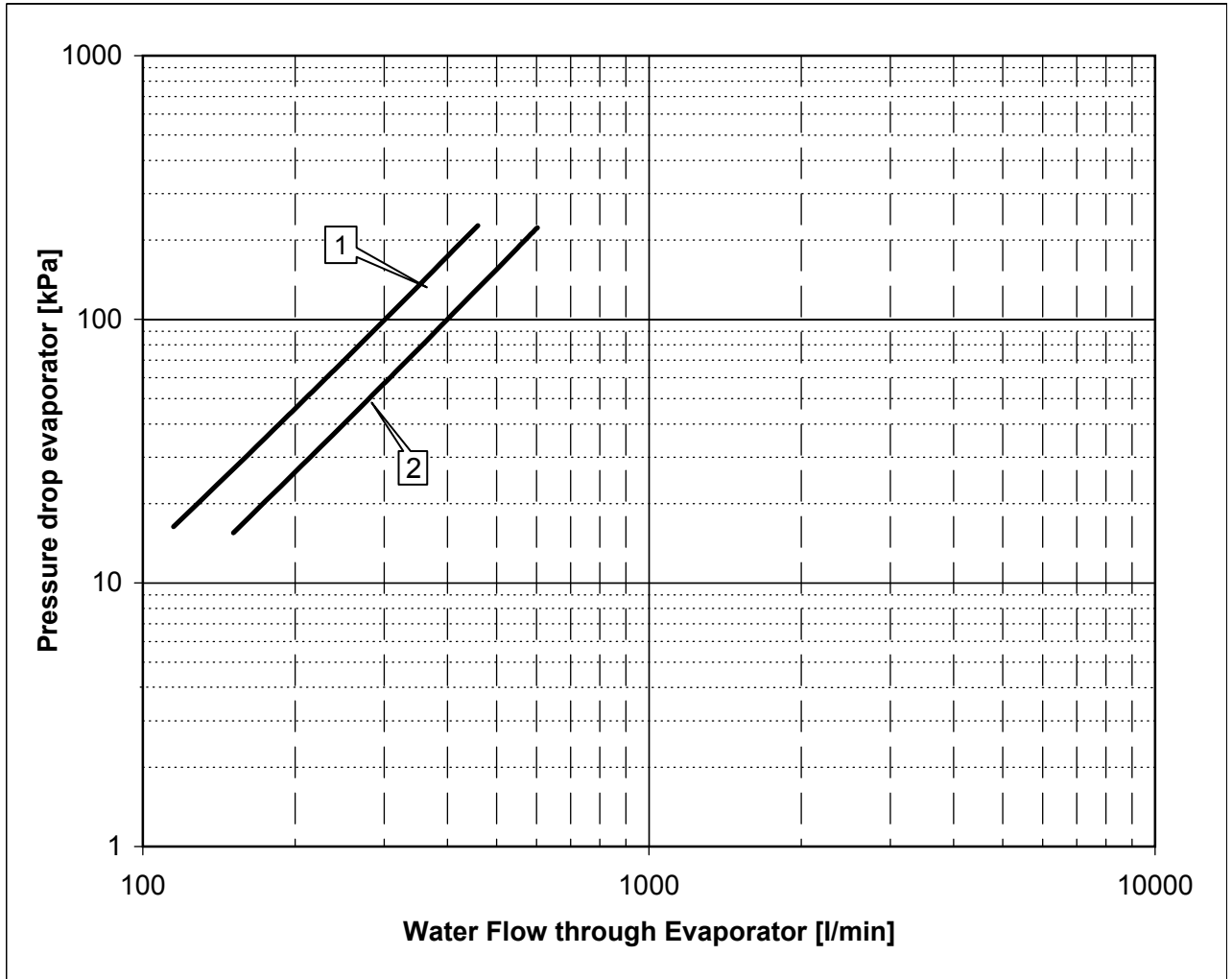

4

Symbols

The table below describes the symbols.

Symbol	Description
(1)	For EWAQ080DAYN*
(2)	For EWAQ100DAYN*

Selecting a flow outside the curves can cause damage to or malfunction of the unit. See also minimum and maximum allowed water flowrange. See "Technical Specifications: EWAQ080-260DAYN" on page 1-5.

1.5 Water Pressure Drop through Evaporator: EWAQ130-210DAYN(N-P-B)

Water pressure drop

The illustration below shows the water pressure drop through evaporator for EWAQ130-210DAYN(N-P-B).

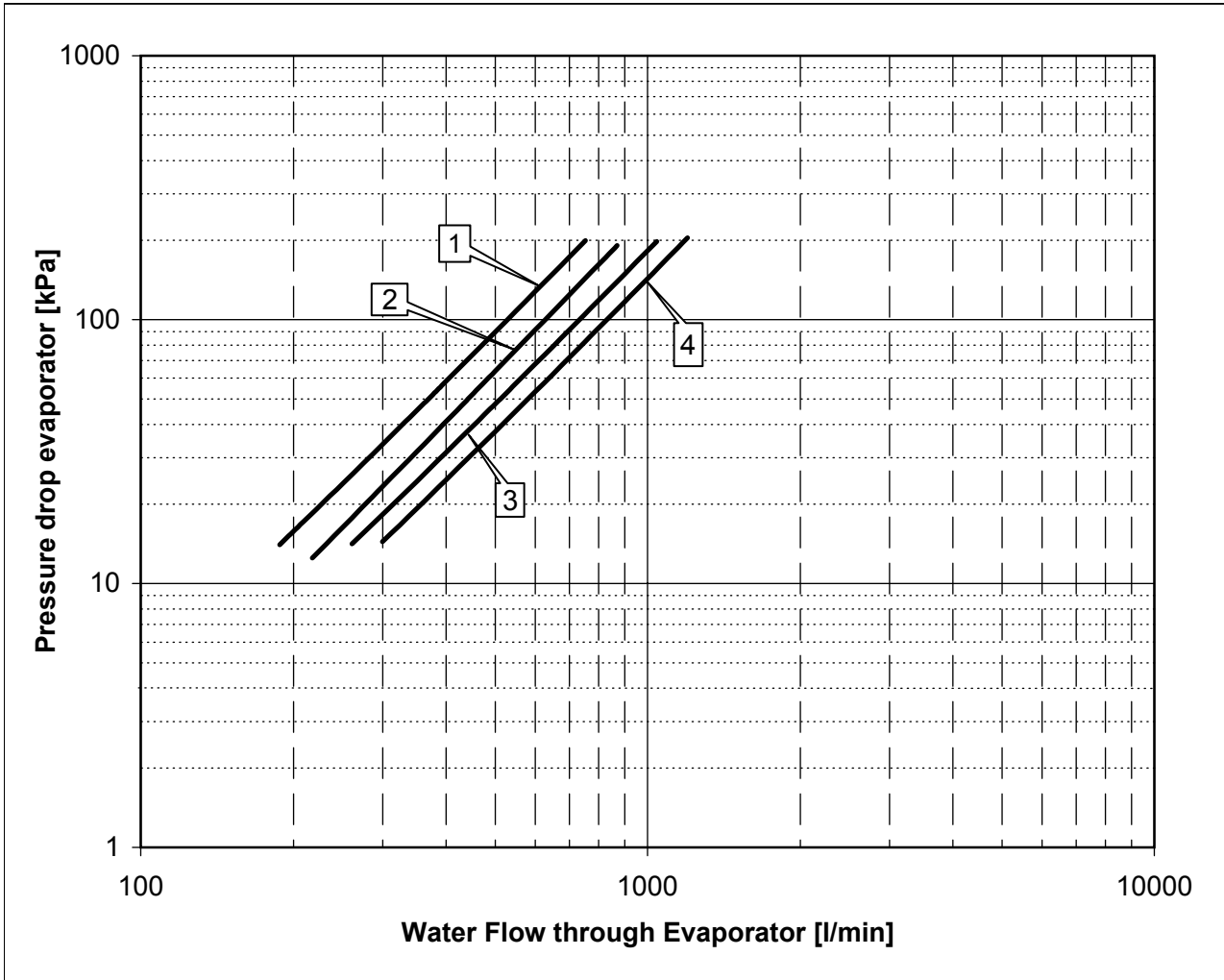

4

Symbols

The table below describes the symbols.

Symbol	Description
(1)	For EWAQ130DAYN*
(2)	For EWAQ150DAYN*
(3)	For EWAQ180DAYN*
(4)	For EWAQ210DAYN*

Selecting a flow outside the curves can cause damage to or malfunction of the unit. See also minimum and maximum allowed water flowrange. See "Technical Specifications: EWAQ080-260DAYN" on page 1-5.

1.6 Water Pressure Drop through Evaporator: EWAQ240-260DAYN (N-P-B)

Water pressure drop

The illustration below shows the water pressure drop through evaporator for EWAQ240-260DAYN (N-P-B).

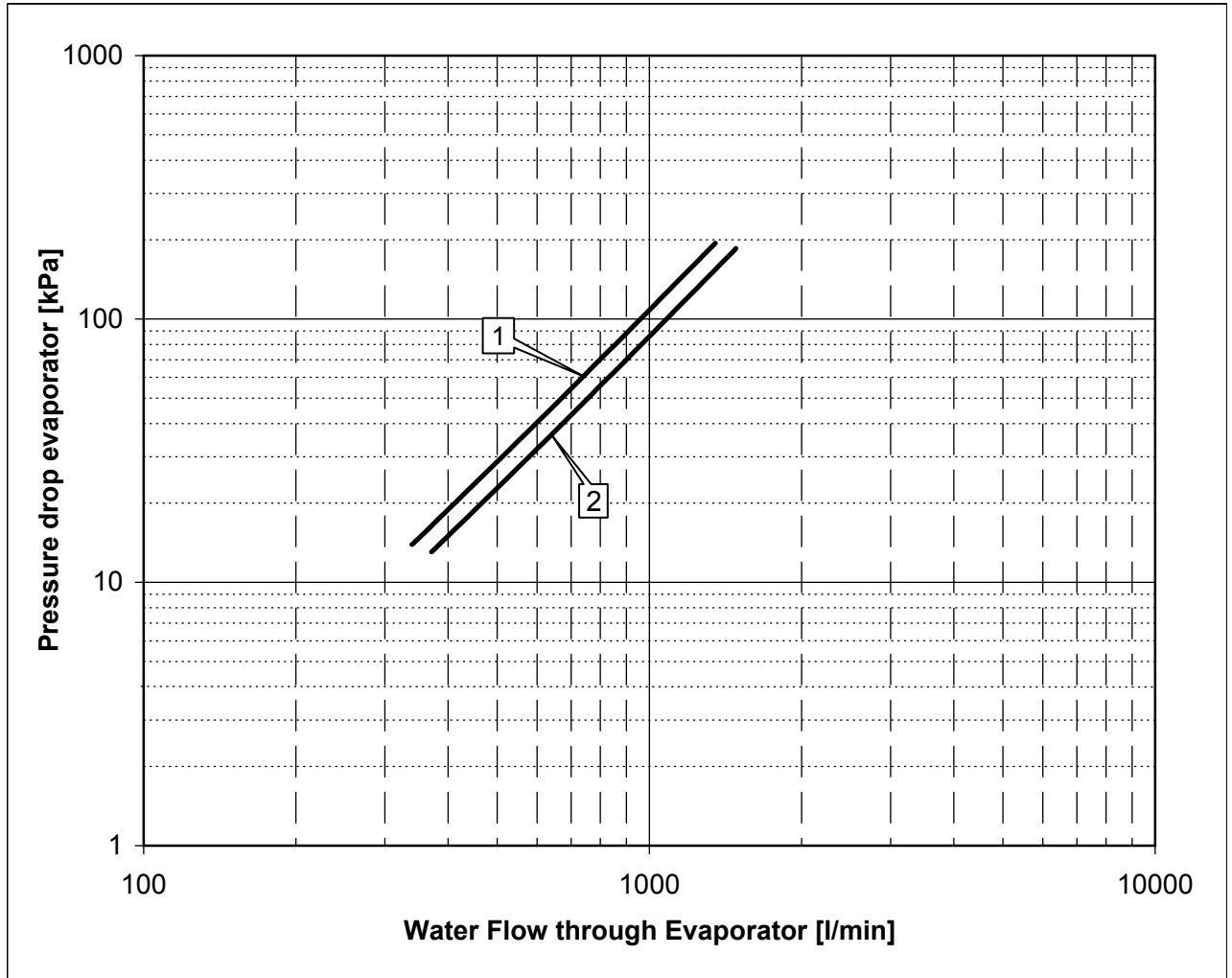

4

Symbols

The table below describes the symbols.

Symbol	Description
(1)	For EWAQ240DAYN*
(2)	For EWAQ260DAYN*
(3)	

Selecting a flow outside the curves can cause damage to or malfunction of the unit. See also minimum and maximum allowed water flowrange. See "Technical Specifications: EWAQ080-260DAYN" on page 1–5.

1.7 Water Pressure Drop through Evaporator: EWYQ080-100DAYN (N-P-B)

Water pressure drop

The illustration below shows the water pressure drop through evaporator for EWYQ080-100DAYN (N-P-B)

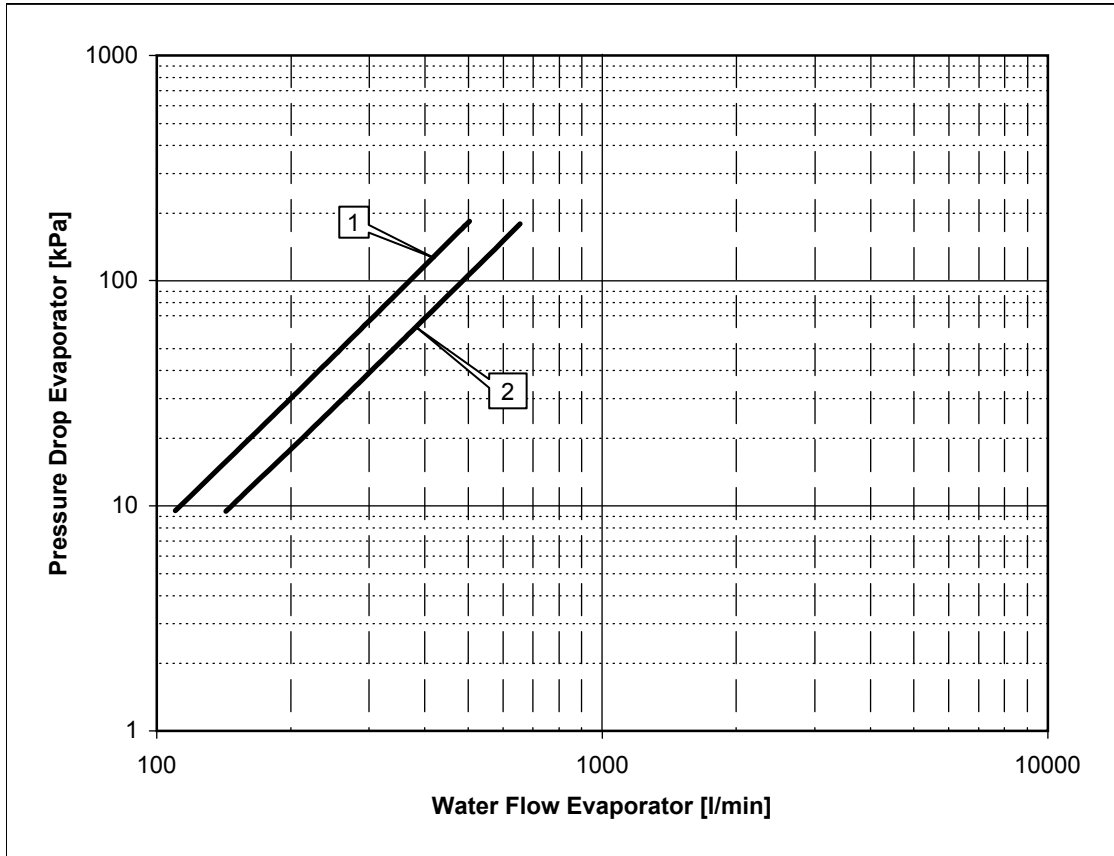

4

Symbols

The table below describes the symbols.

Symbol	Description
(1)	For EWYQ080DAYN*
(2)	For EWYQ100DAYN*

Selecting a flow outside the curves can cause damage to or malfunction of the unit. See also minimum and maximum allowed water flowrange. See "Technical Specifications for options: EWAQ080-100DAYN" on page 1–8.

1.8 Water Pressure Drop through Evaporator: EWYQ130-210DAYN(N-P-B)

Water pressure drop

The illustration below shows the water pressure drop through evaporator for EWYQ130-210DAYN(N-P-B).

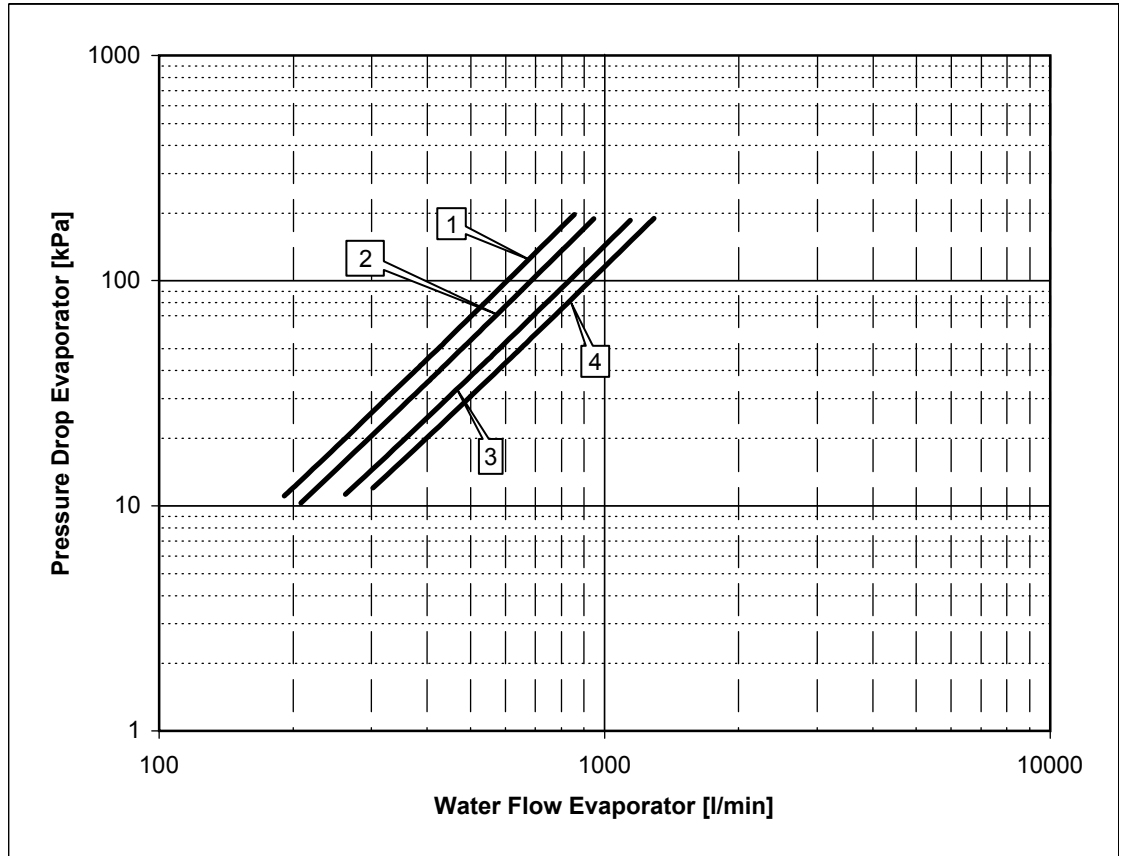

4

Symbols

The table below describes the symbols.

Symbol	Description
(1)	For EWYQ130DAYN*
(2)	For EWYQ150DAYN*
(3)	For EWYQ180DAYN*
(4)	For EWYQ210DAYN*

Selecting a flow outside the curves can cause damage to or malfunction of the unit. See also minimum and maximum allowed water flowrange. See "Technical Specifications for options: EWAQ180-210DAYN" on page 1–10.

1.9 Water Pressure Drop through Evaporator: EWYQ230-250DAYN(N-P-B)

Water pressure drop

The illustration below shows the water pressure drop through condenser for EWYQ230-250DAYN(N-P-B).

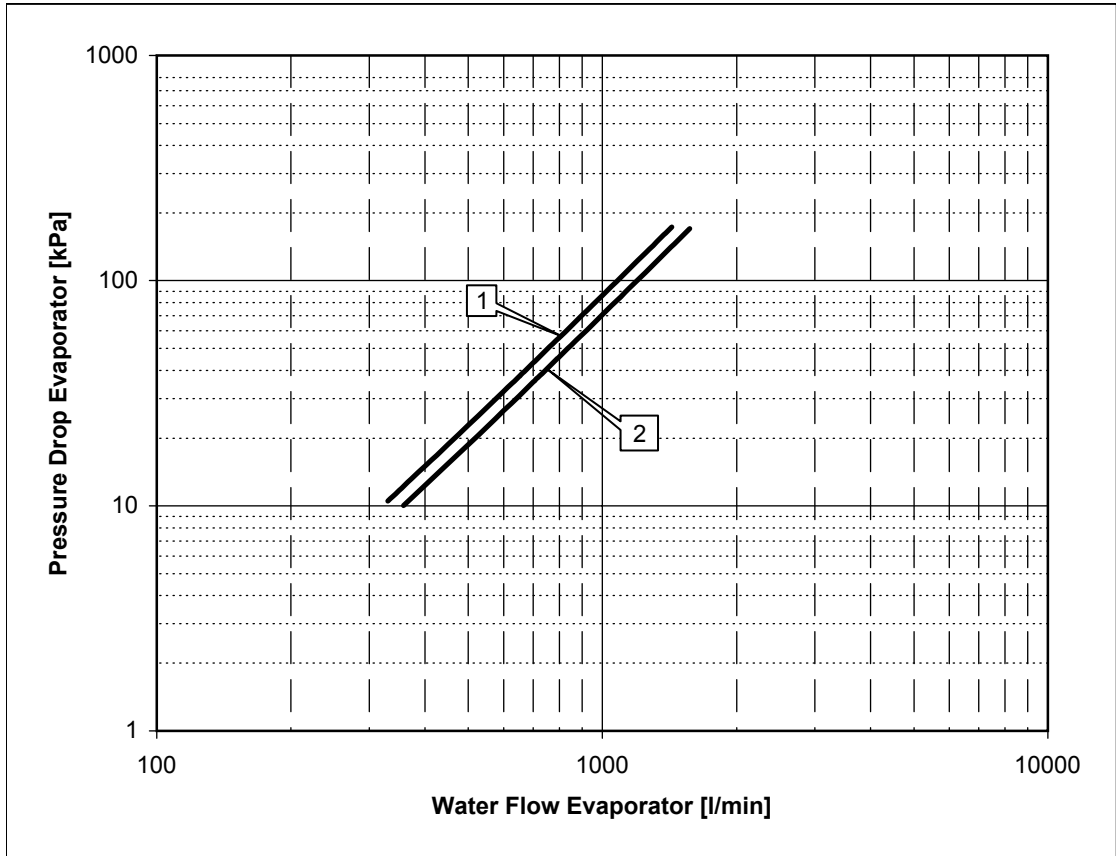

4

Symbols

The table below describes the symbols.

Symbol	Description
(1)	For EWYQ230DAYN*
(2)	For EWYQ250DAYN*

Selecting a flow outside the curves can cause damage to or malfunction of the unit. See also minimum and maximum allowed water flowrange. See "Technical Specifications for options: EWAQ130-150DAYN" on page 1–9.

1.10 Unit pressure drop : EWAQ080-100DAYNN Standard Model

Unit pressure drop The illustration below shows the water pressure drop through evaporator for EWAQ080-100DAYNN Standard Model.

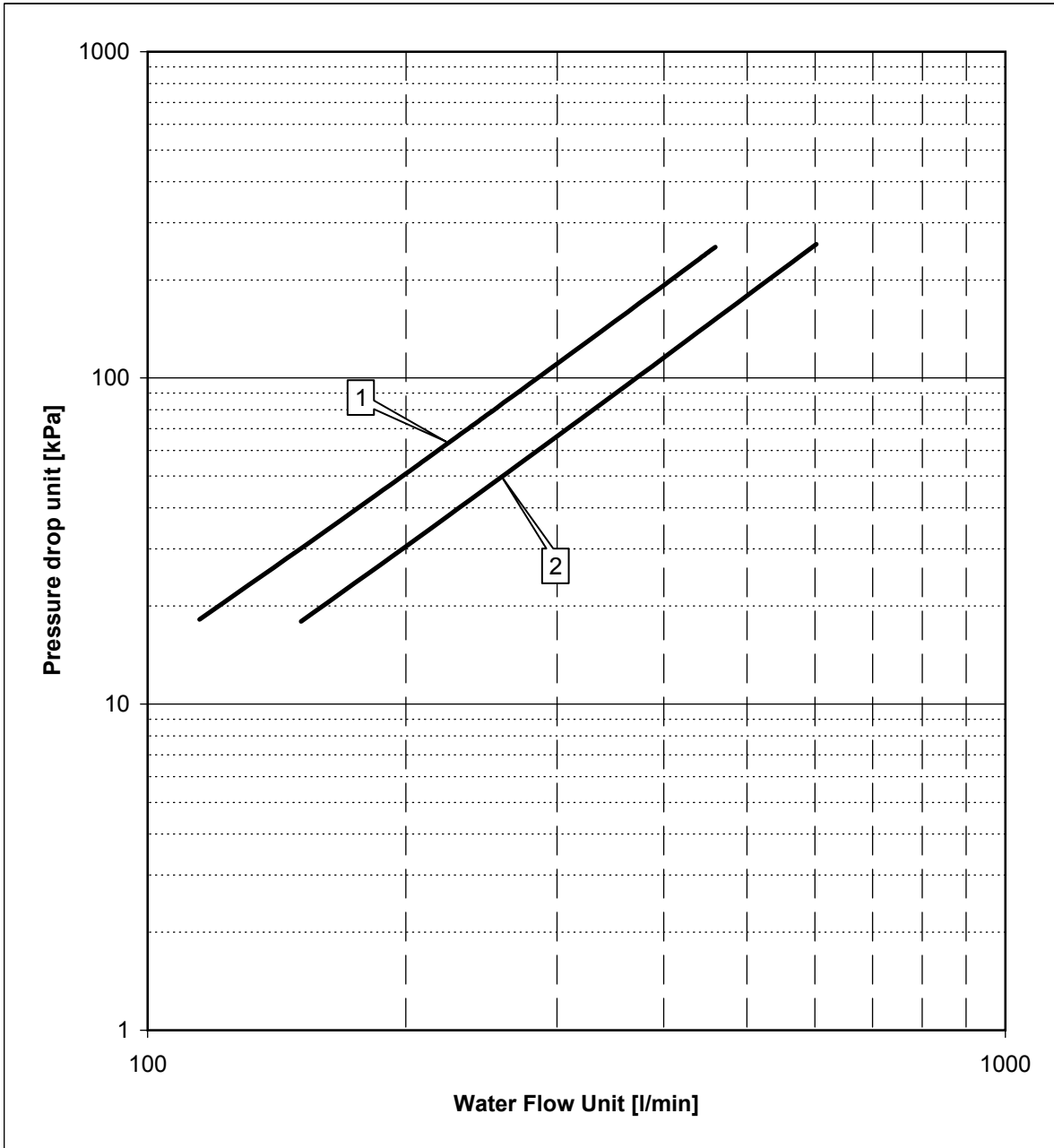

4

Symbols

The table below describes the symbols.

Symbol	Description
(1)	For EWAQ080DAYNN Standard Model
(2)	For EWAQ100DAYNN Standard Model

Selecting a flow outside the curves can cause damage to or malfunction of the unit. See also minimum and maximum allowed water flowrange. See "Technical Specifications: EWAQ080-260DAYN" on page 1–5.

1.11 Unit pressure drop : EWAQ130-210DAYNN Standard Model

Unit pressure drop The illustration below shows the water pressure drop through evaporator for EWAQ130-210DAYNN Standard Model.

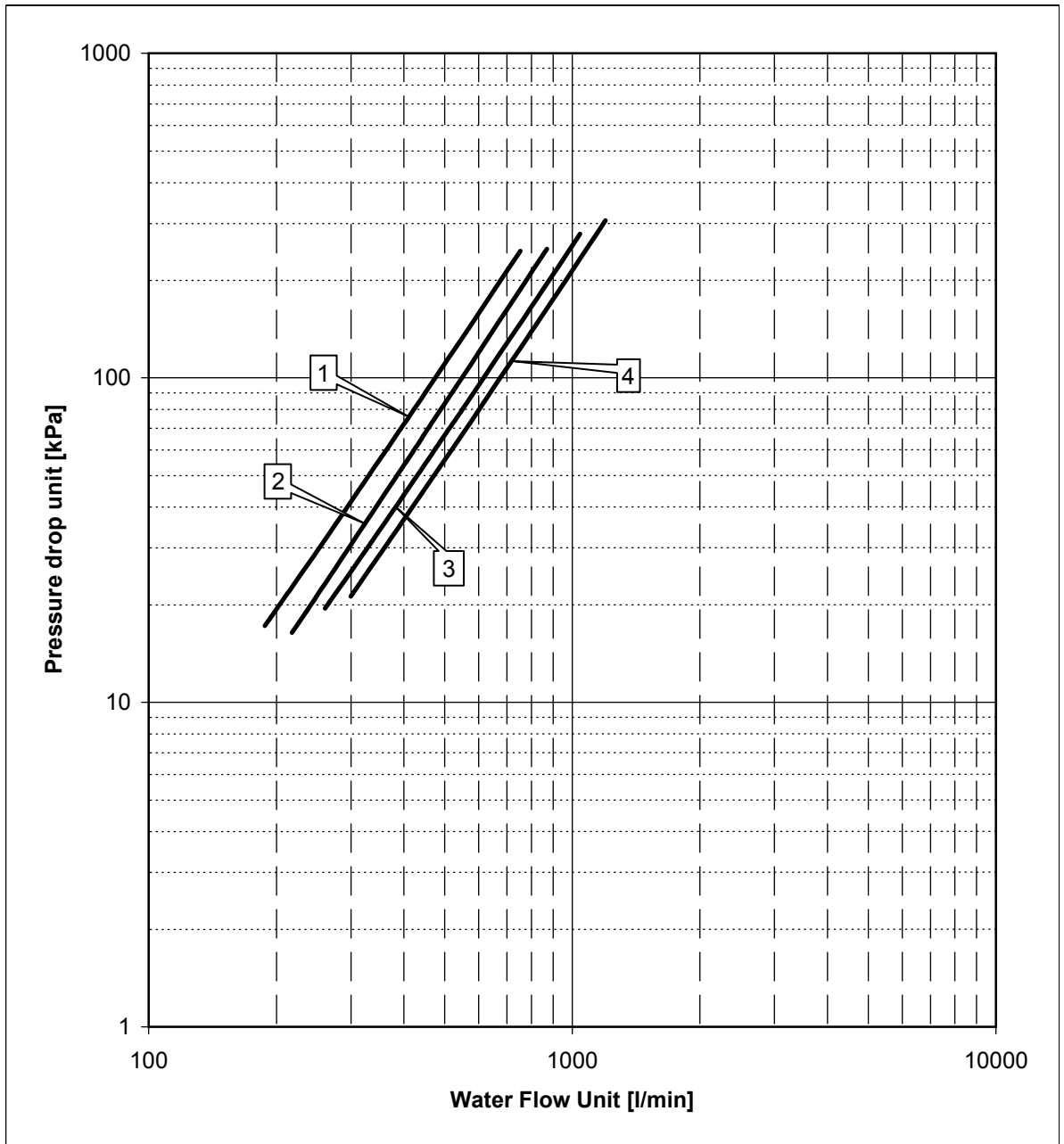

Symbols

The table below describes the symbols.

Symbol	Description
(1)	For EWAQ130DAYNN Standard Model
(2)	For EWAQ150DAYNN Standard Model
(3)	For EWAQ180DAYNN Standard Model

Symbol	Description
(4)	For EWAQ210DAYNN Standard Model

Selecting a flow outside the curves can cause damage to or malfunction of the unit. See also minimum and maximum allowed water flowrange. See "Technical Specifications: EWAQ080-260DAYN" on page 1–5.

1.12 Unit pressure drop : EWAQ240-260DAYNN Standard Model

Unit pressure drop The illustration below shows the water pressure drop through evaporator for EWAQ240-260DAYNN Standard Model.

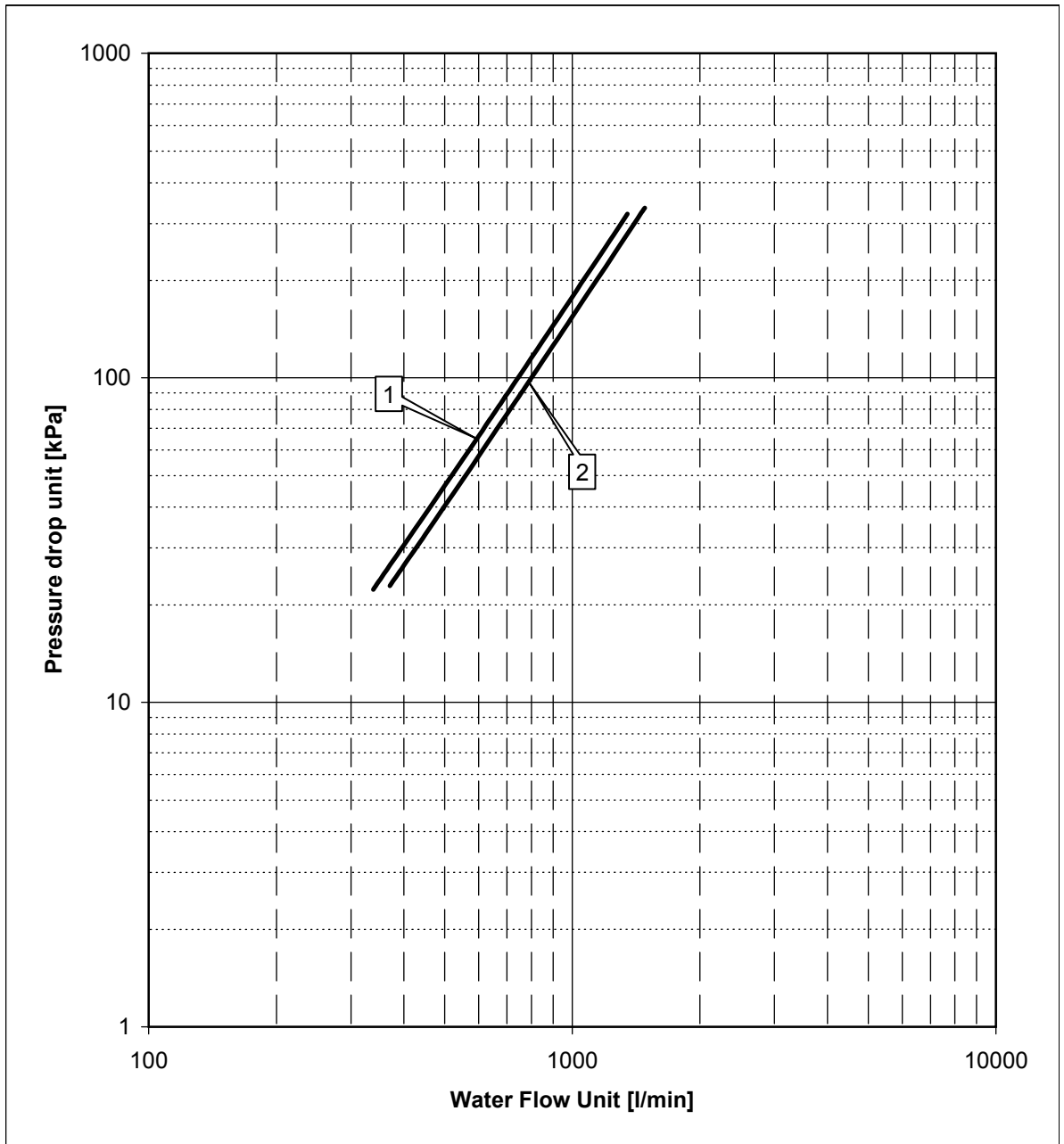

Symbols

The table below describes the symbols.

Symbol	Description
(1)	For EWAQ240DAYNN Standard Model
(2)	For EWAQ260DAYNN Standard Model

Selecting a flow outside the curves can cause damage to or malfunction of the unit. See also minimum and maximum allowed water flowrange. See "Technical Specifications: EWAQ080-260DAYN" on page 1–5.

1.13 Unit pressure drop : EWYQ080-100DAYNN Standard Unit

Unit pressure drop The illustration below shows the water pressure drop through evaporator for EWAQ240-260DAYNN Standard Model.

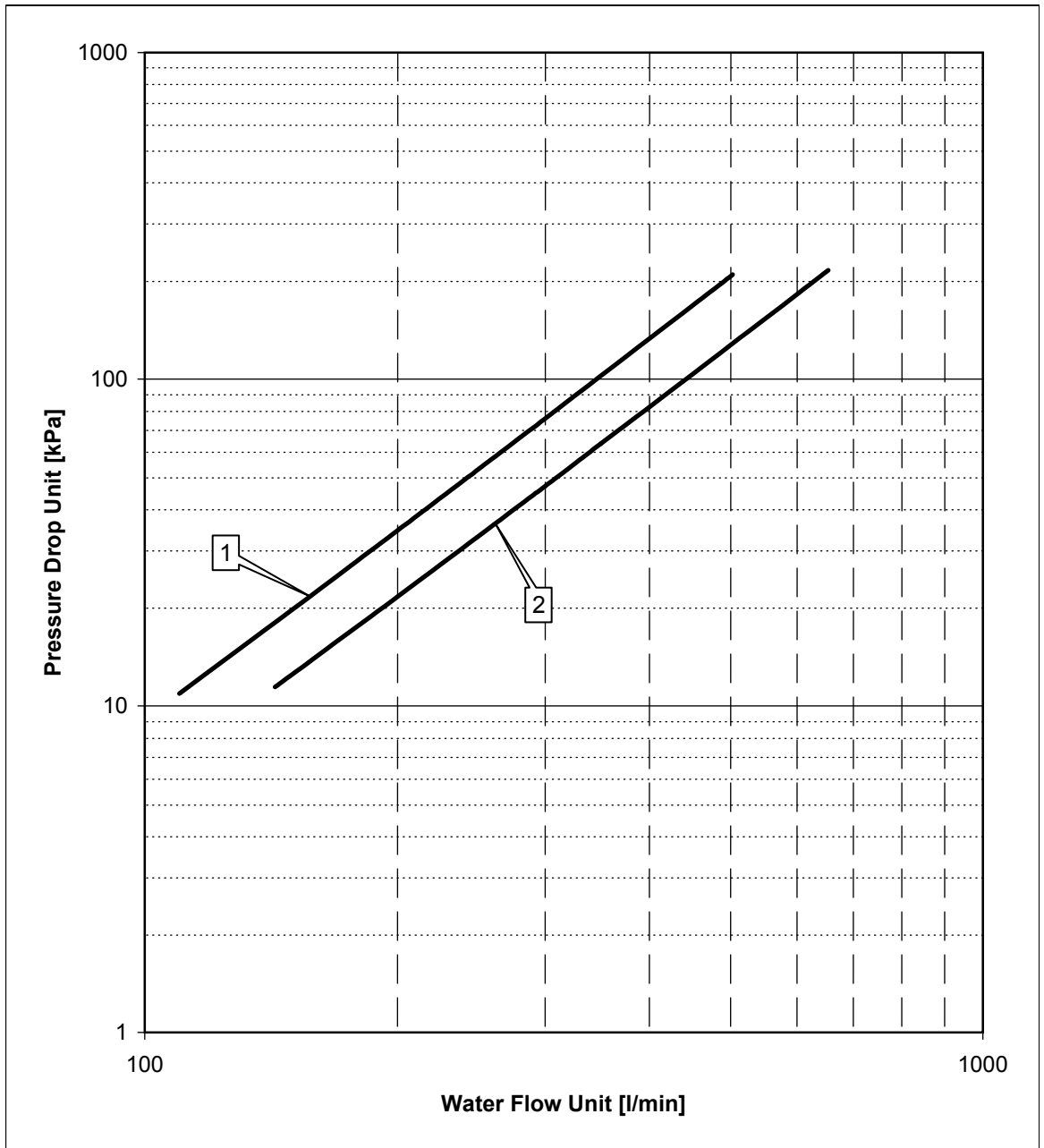

Symbols

The table below describes the symbols.

Symbol	Description
(1)	For EWYQ080DAYNN Standard Unit
(2)	For EWYQ100DAYNN Standard Unit

Selecting a flow outside the curves can cause damage to or malfunction of the unit. See also minimum and maximum allowed water flowrange. See "Technical Specifications: EWYQ080-250DAYN" on page 1–12.

1.14 Unit pressure drop : EWYQ130-210DAYNN Standard Unit

Unit pressure drop The illustration below shows the water pressure drop through evaporator for EWYQ130-210DAYNN Standard Unit.

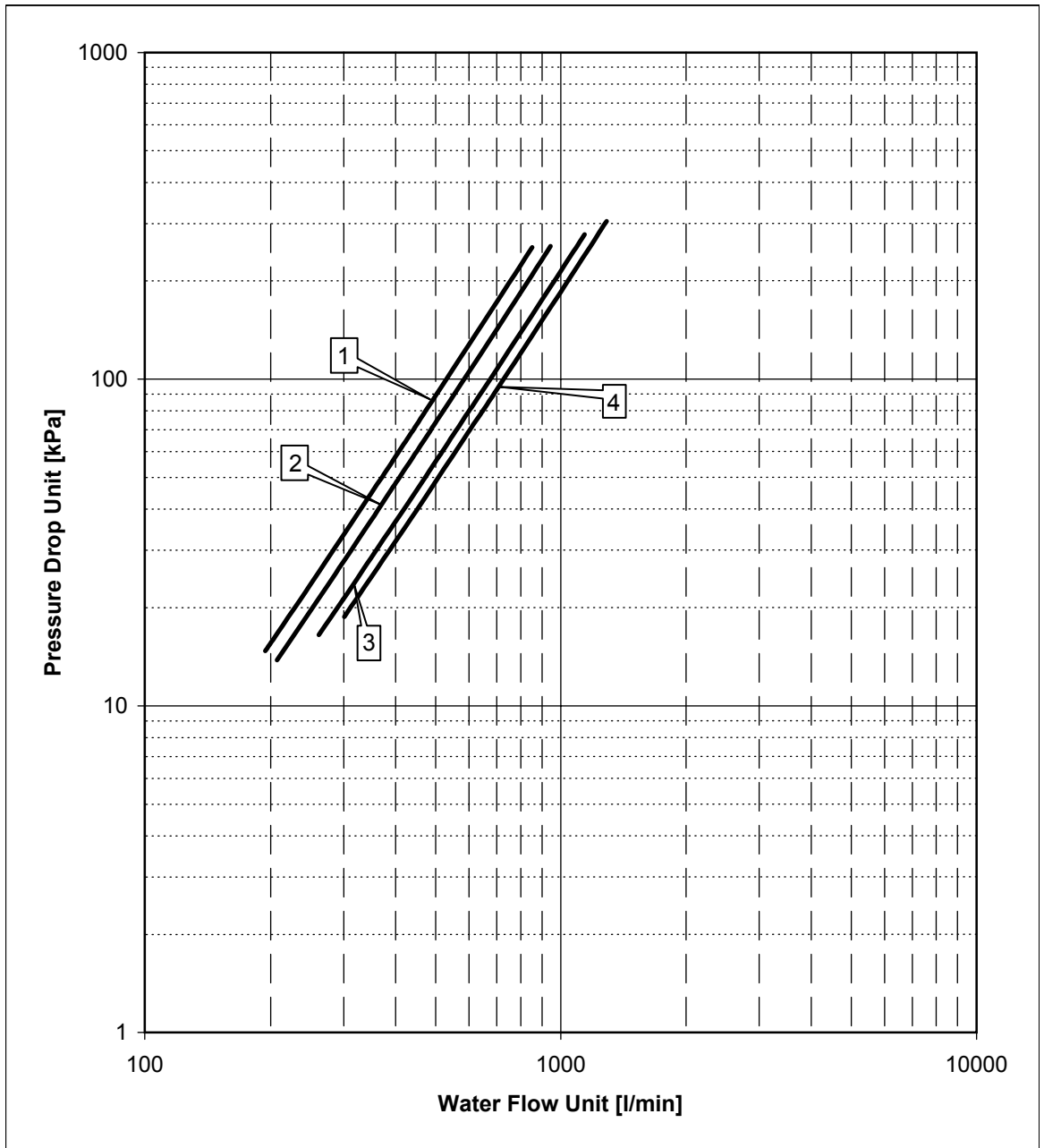

Symbols

The table below describes the symbols.

Symbol	Description
(1)	For EWYQ130DAYNN Standard Unit
(2)	For EWYQ150DAYNN Standard Unit
(3)	For EWYQ180DAYNN Standard Unit

Symbol	Description
(4)	For EWYQ210DAYNN Standard Unit

Selecting a flow outside the curves can cause damage to or malfunction of the unit. See also minimum and maximum allowed water flowrange. See "Technical Specifications: EWYQ080-250DAYN" on page 1–12.

1.15 Unit pressure drop : EWYQ230-250DAYNN Standard Unit

Unit pressure drop The illustration below shows the water pressure drop through evaporator for EWYQ230-250DAYNN Standard Unit.

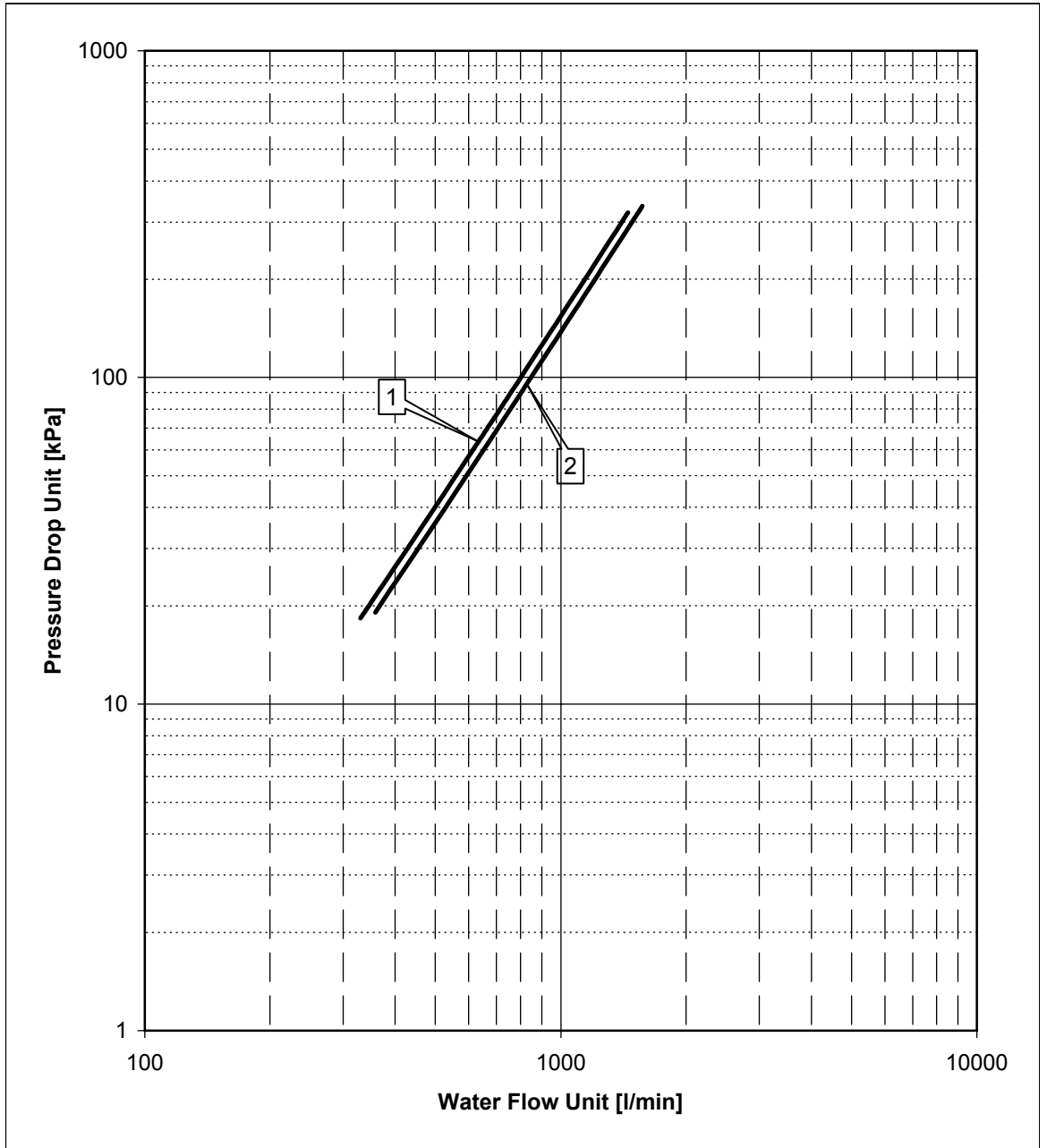

Symbols

The table below describes the symbols.

Symbol	Description
(1)	For EWYQ230DAYNN Standard Unit
(2)	For EWYQ250DAYNN Standard Unit

Selecting a flow outside the curves can cause damage to or malfunction of the unit. See also minimum and maximum allowed water flowrange. See "Technical Specifications: EWYQ080-250DAYN" on page 1–12.

1.16 External Static Unit Pressure: EWAQ080-100 DAYN (P-B)

External Static Pressure

The illustration below shows the water pressure drop through evaporator for EWAQ080-100 DAYN (P-B).

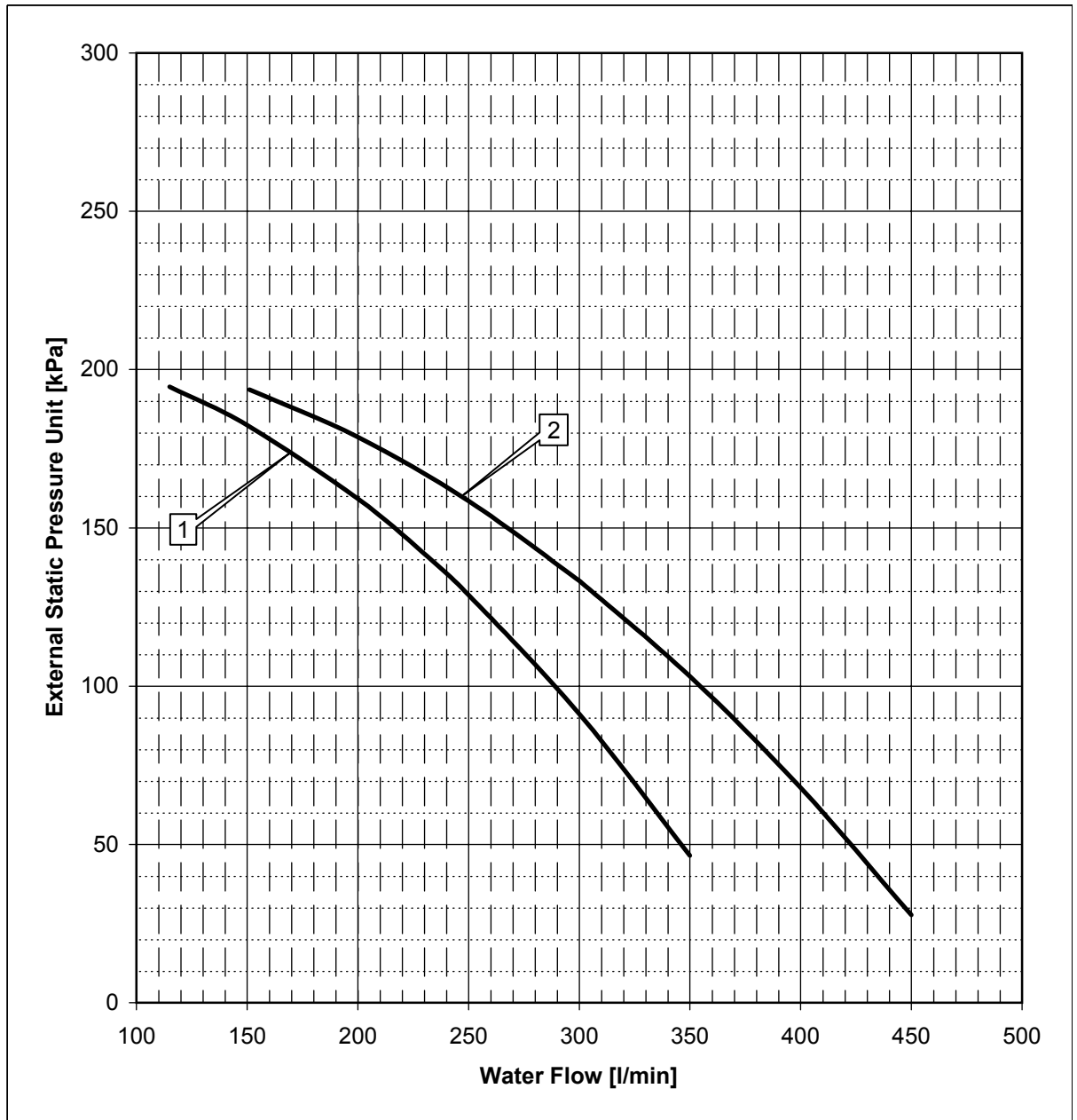

Symbols

The table below describes the symbols.

Symbol	Description
(1)	For EWAQ080DAYN* + 0PSP
(2)	For EWAQ100DAYN* + 0PSP

Selecting a flow outside the curves can cause damage to or malfunction of the unit. See also minimum and maximum allowed water flowrange. See "Technical Specifications: EWAQ080-260DAYN" on page 1–5.

1.17 External Static Unit Pressure: EWAQ130-210 DAYN (P-B)

External Static Pressure

The illustration below shows the water pressure drop through evaporator for EWAQ130-210 DAYN (P-B).

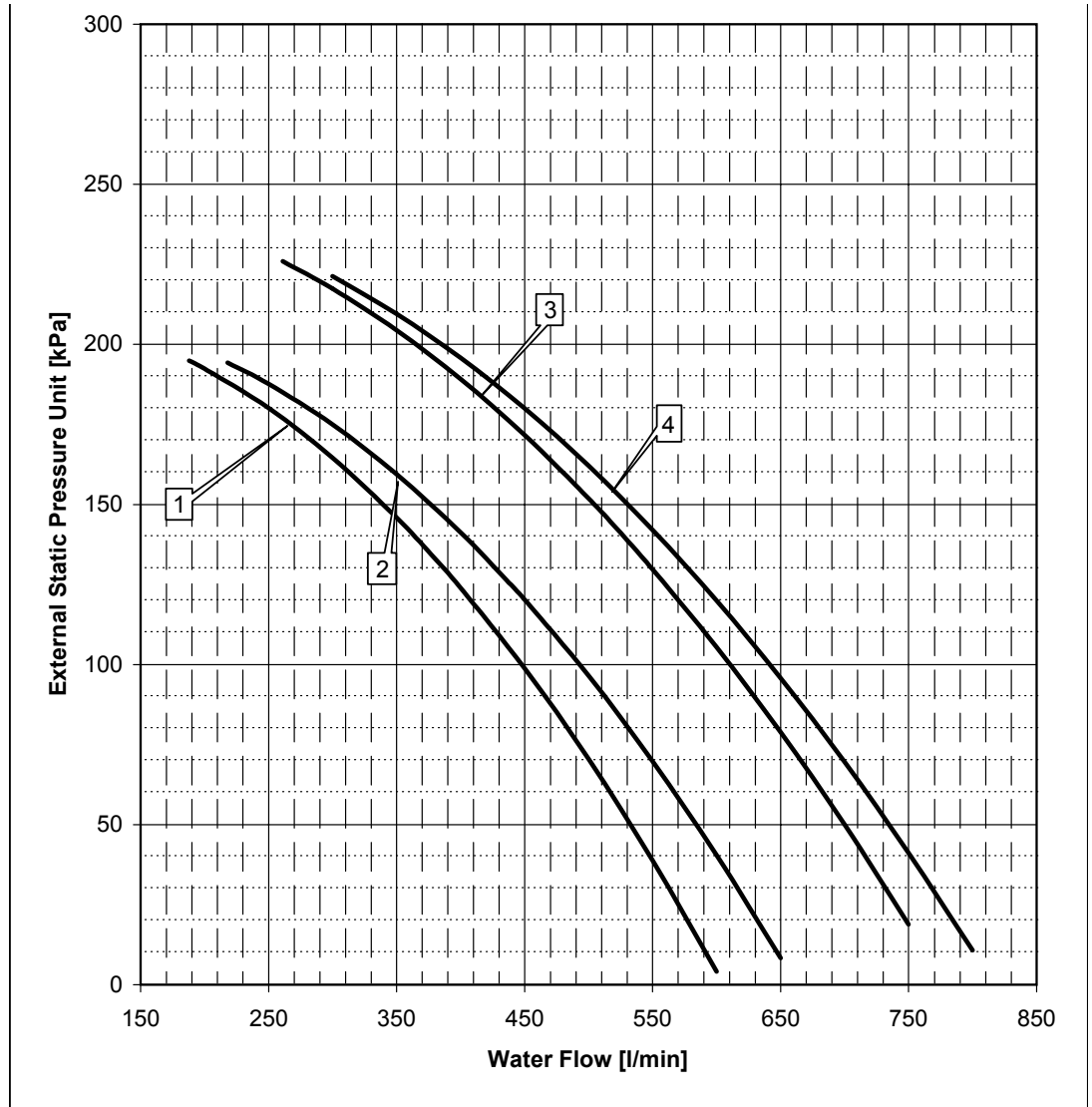

4

Symbols

The table below describes the symbols.

Symbol	Description
(1)	EWAQ130 DAYN*+0PSP
(2)	EWAQ150 DAYN*+0PSP
(3)	EWAQ180 DAYN*+0PSP
(4)	EWAQ210 DAYN*+0PSP

Selecting a flow outside the curves can cause damage to or malfunction of the unit. See also minimum and maximum allowed water flowrange. See "Technical Specifications: EWAQ080-260DAYN" on page 1-5.

1.18 External Static Unit Pressure: EWAQ240-260DAYN (P-B)

External Static Pressure

The illustration below shows the water pressure drop through evaporator for EWAQ240-260DAYN (P-B).

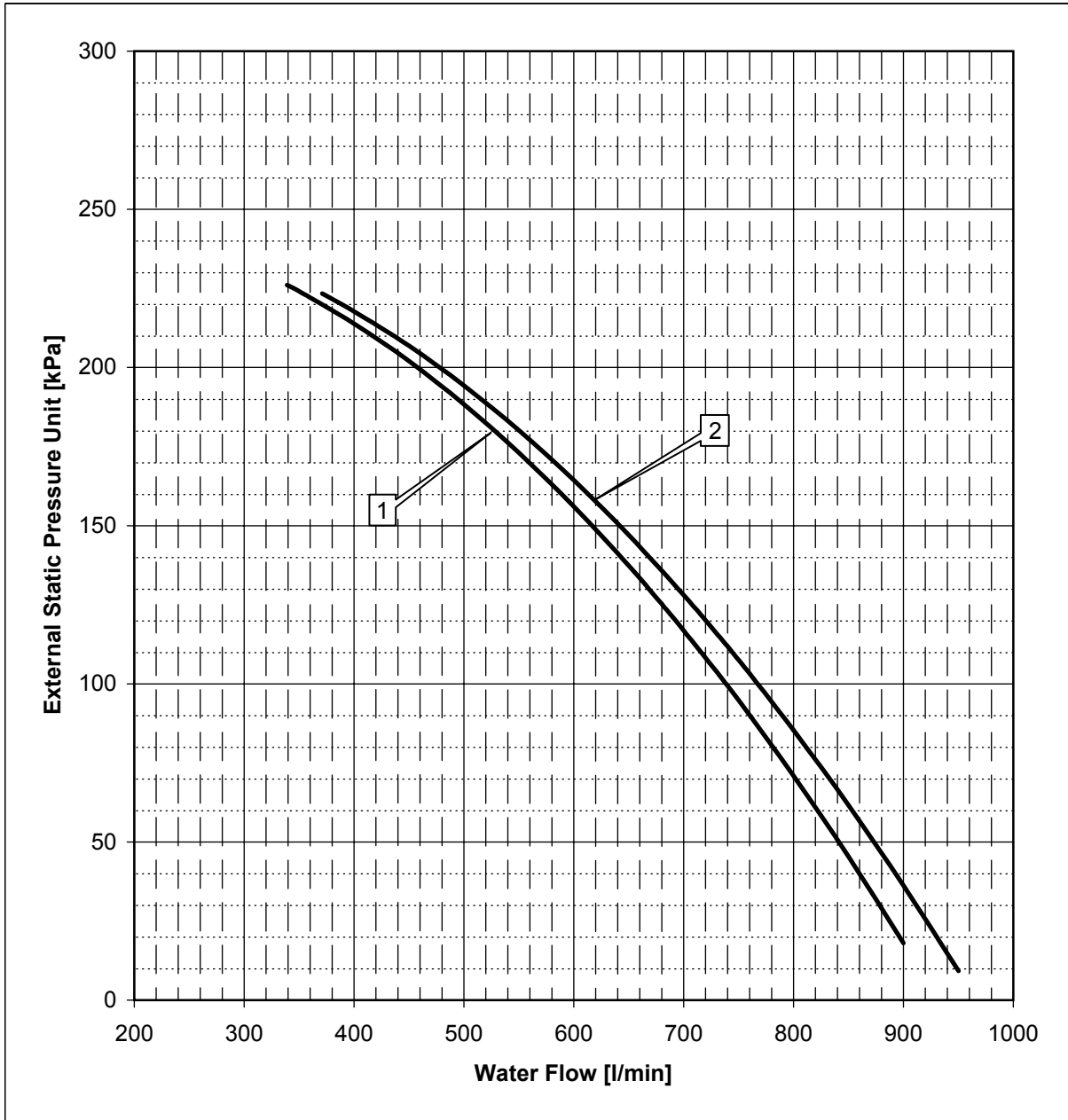

Symbols

The table below describes the symbols.

Symbol	Description
(1)	EWAQ240 DAYN*+0PSP
(2)	EWAQ260 DAYN*+0PSP

Selecting a flow outside the curves can cause damage to or malfunction of the unit. See also minimum and maximum allowed water flowrange. See "Technical Specifications: EWAQ080-260DAYN" on page 1–5.

1.19 External Static Unit Pressure: EWYQ080-100DAYN (P-B)

External Static Pressure

The illustration below shows the water pressure drop through evaporator for EWYQ080-100DAYN (P-B).

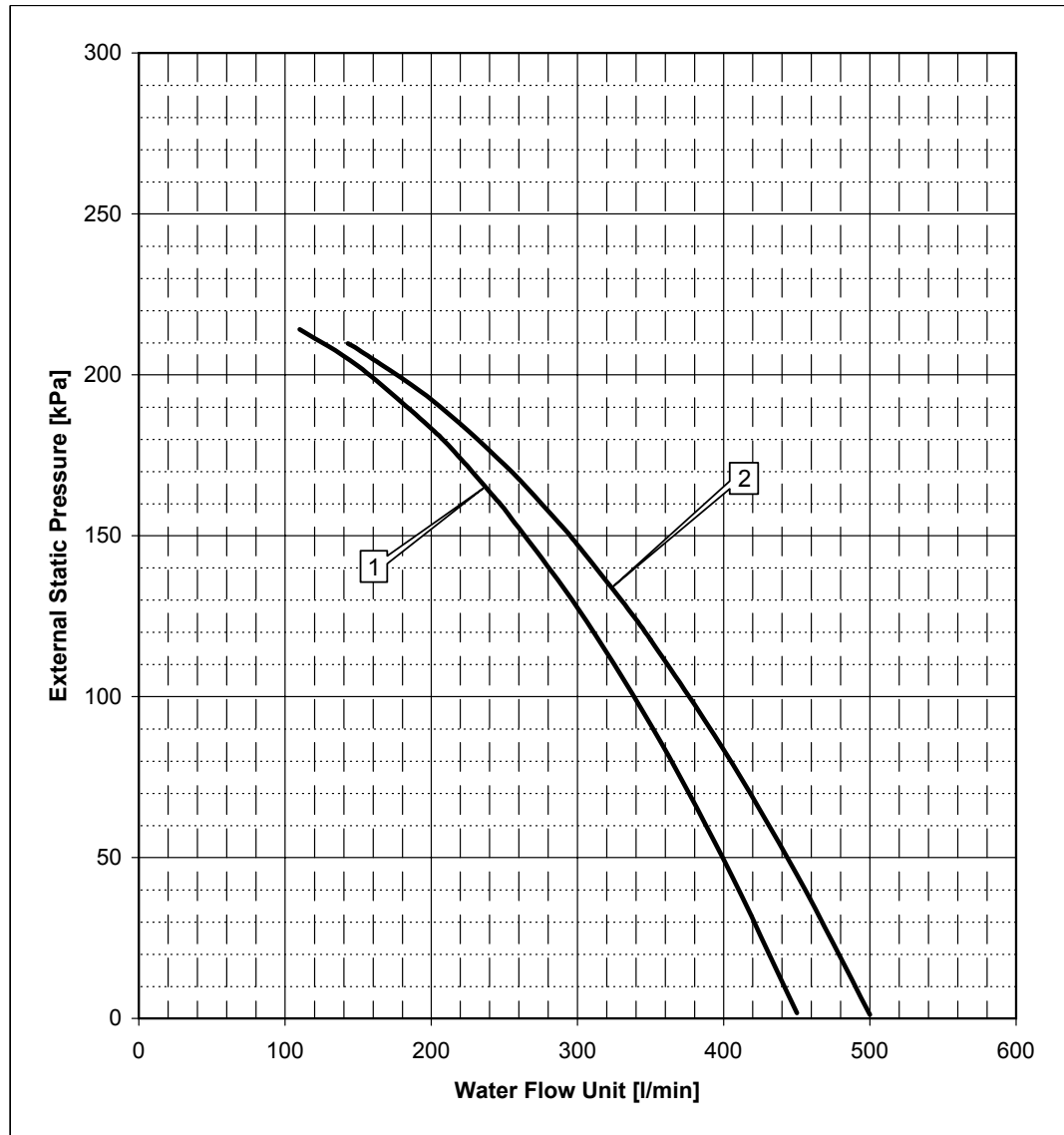

Symbols

The table below describes the symbols.

Symbol	Description
(1)	EWYQ080 DAYN*+0PSP
(2)	EWYQ100 DAYN*+0PSP

Selecting a flow outside the curves can cause damage to or malfunction of the unit. See also minimum and maximum allowed water flowrange. See "Technical Specifications: EWYQ080-250DAYN" on page 1–12.

4

1.20 External Static Unit Pressure: EWYQ130-210DAYN (P-B)

External Static Pressure

The illustration below shows the water pressure drop through evaporator for EWYQ130-210DAYN (P-B).

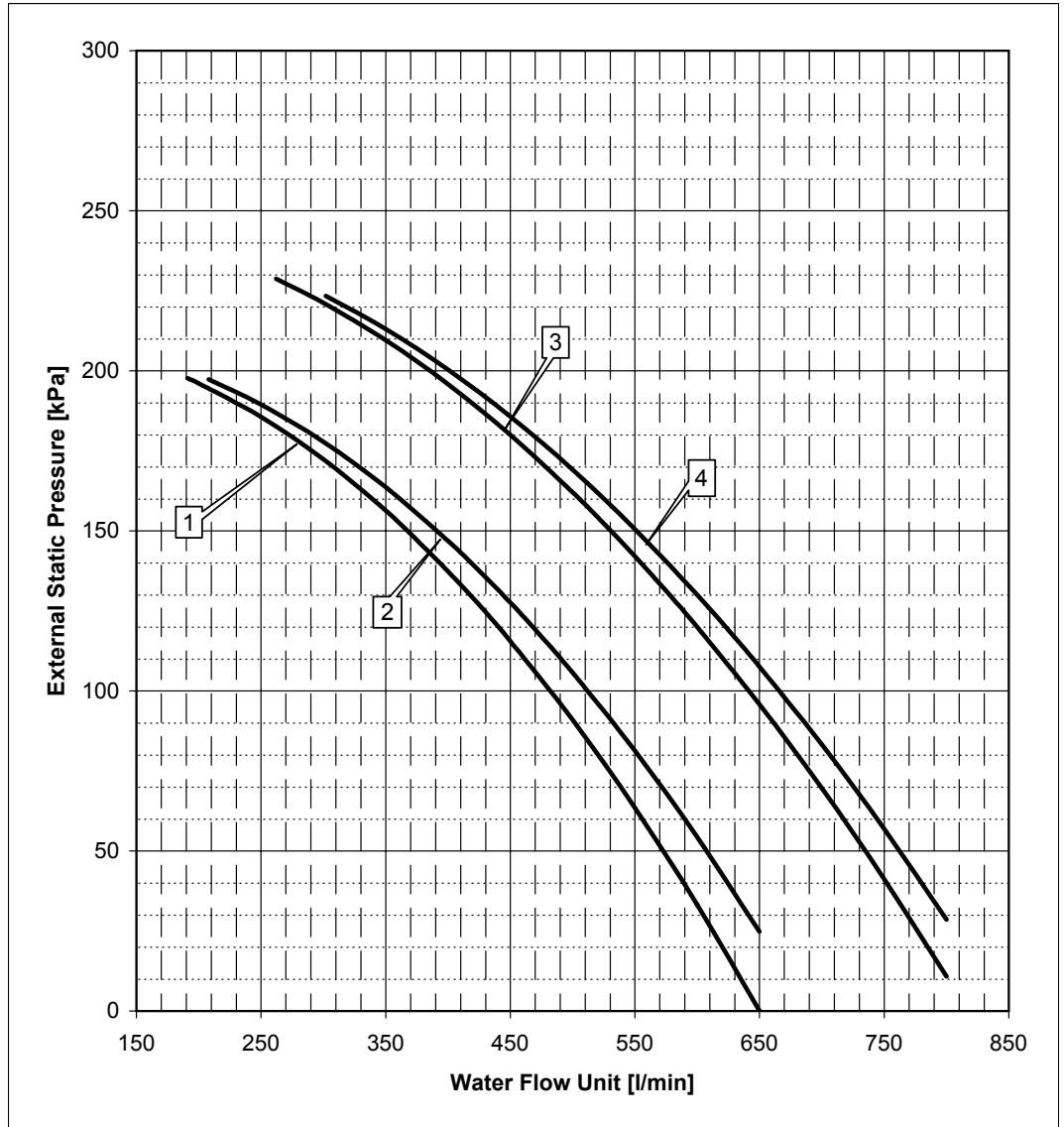

Symbols

The table below describes the symbols.

Symbol	Description
(1)	EWYQ130 DAYN*+0PSP
(2)	EWYQ150 DAYN*+0PSP
(3)	EWYQ180 DAYN*+0PSP
(4)	EWYQ210 DAYN*+0PSP

Selecting a flow outside the curves can cause damage to or malfunction of the unit. See also minimum and maximum allowed water flowrange. See "Technical Specifications: EWYQ080-250DAYN" on page 1–12.

1.21 External Static Unit Pressure: EWYQ230-250DAYN (P-B)

External Static Pressure

The illustration below shows the water pressure drop through evaporator for EWYQ230-250DAYN (P-B).

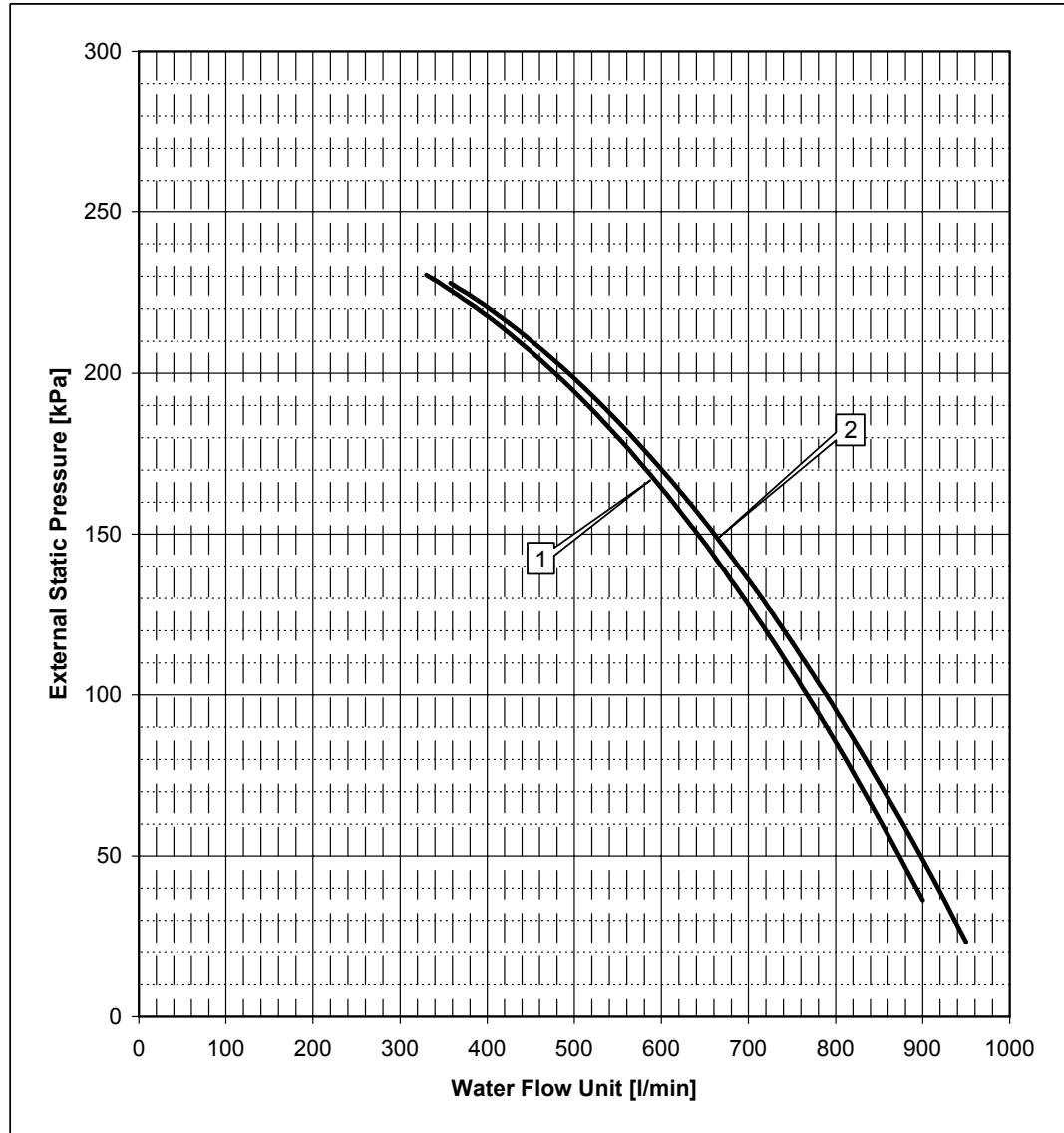

Symbols

The table below describes the symbols.

Symbol	Description
(1)	EWYQ230 DAYN*+0PSP
(2)	EWYQ250 DAYN*+0PSP

Selecting a flow outside the curves can cause damage to or malfunction of the unit. See also minimum and maximum allowed water flowrange. See "Technical Specifications: EWYQ080-250DAYN" on page 1–12.

4

1.22 External Static Unit Pressure: EWAQ080-100DAYN (OPHP)

External Static Pressure

The illustration below shows the water pressure drop through evaporator for EWAQ080-100DAYN (OPHP).

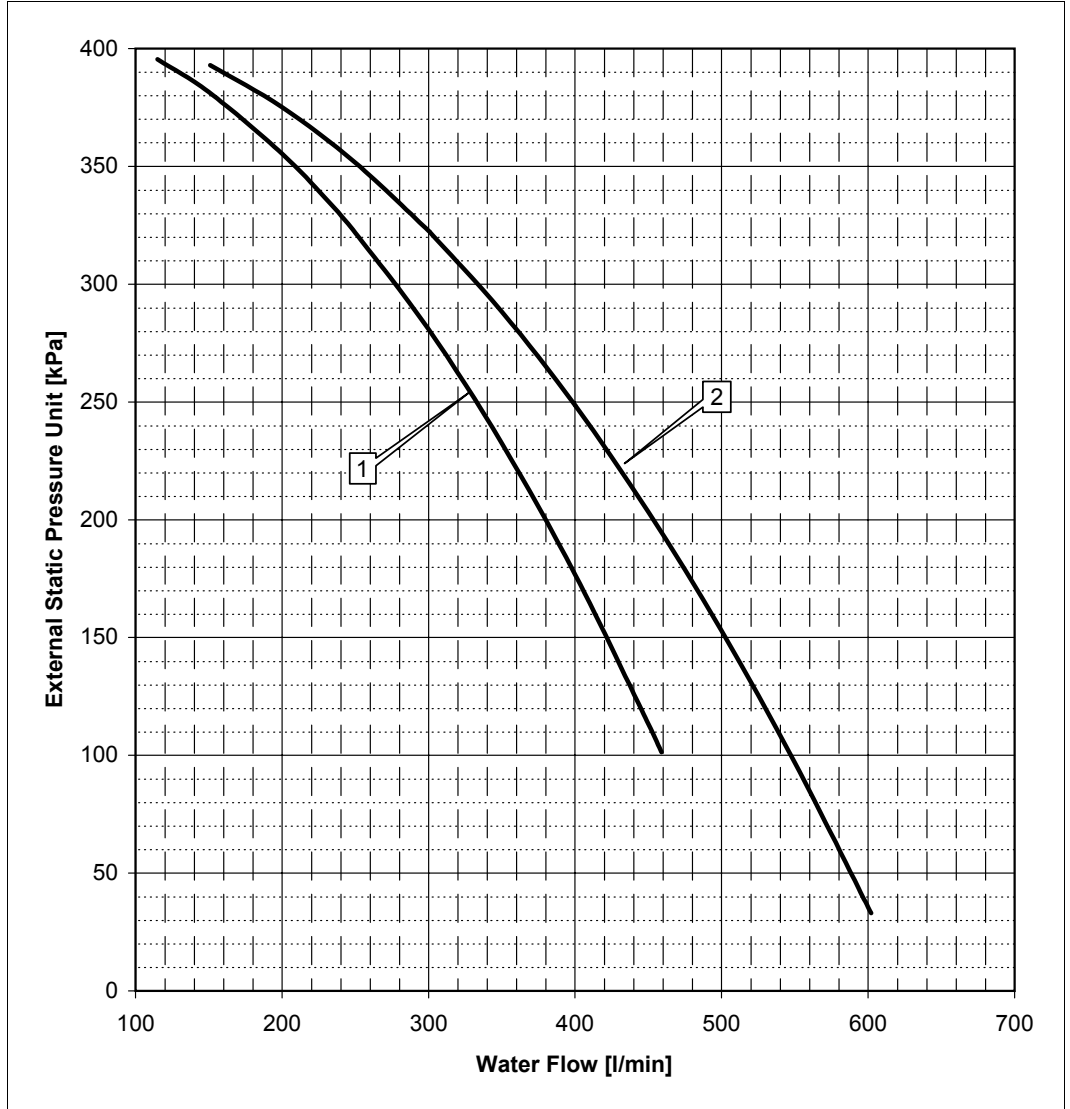

4

Symbols

The table below describes the symbols.

Symbol	Description
(1)	EWAQ080 DAYN*+0PSP

Symbol	Description
(2)	EWAQ100 DAYN*+0PSP

Selecting a flow outside the curves can cause damage to or malfunction of the unit. See also minimum and maximum allowed water flowrange. See "Technical Specifications: EWAQ080-260DAYN" on page 1–5.

1.23 External Static Unit Pressure: EWAQ130-210DAYN (OPHP)

External Static Pressure

The illustration below shows the water pressure drop through evaporator for EWAQ130-210DAYN (OPHP).

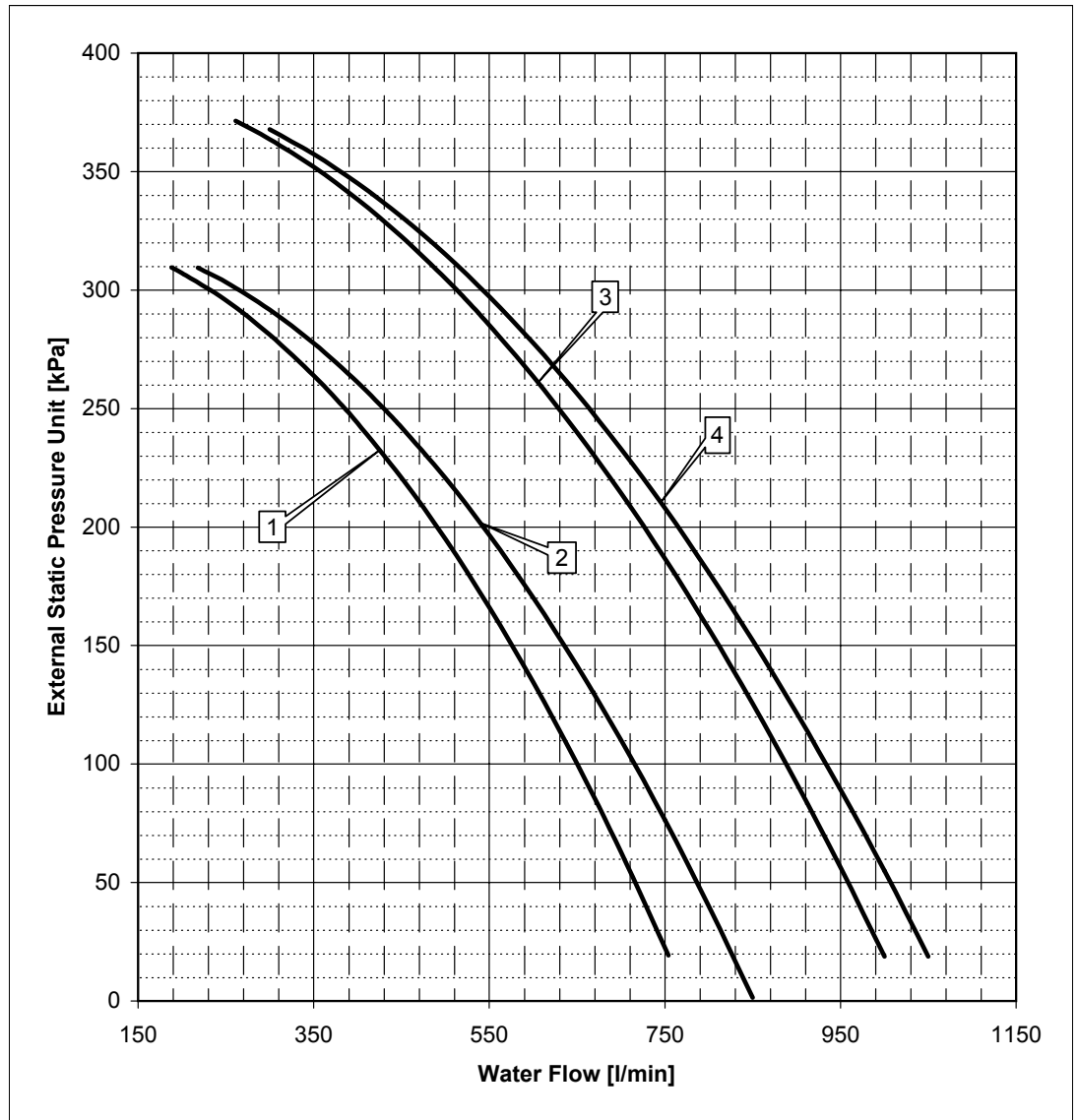

4

Symbols

The table below describes the symbols.

Symbol	Description
(1)	EWAQ130 DAYN*+0PSP
(2)	EWAQ150 DAYN*+0PSP
(3)	EWAQ180 DAYN*+0PSP
(4)	EWAQ210 DAYN*+0PSP

Selecting a flow outside the curves can cause damage to or malfunction of the unit. See also minimum and maximum allowed water flowrange. See "Technical Specifications: EWAQ080-260DAYN" on page 1–5.

1.24 External Static Unit Pressure: EWAQ240-260DAYN (OPHP)

External Static Pressure

The illustration below shows the water pressure drop through evaporator for EWAQ240-260DAYN (OPHP).

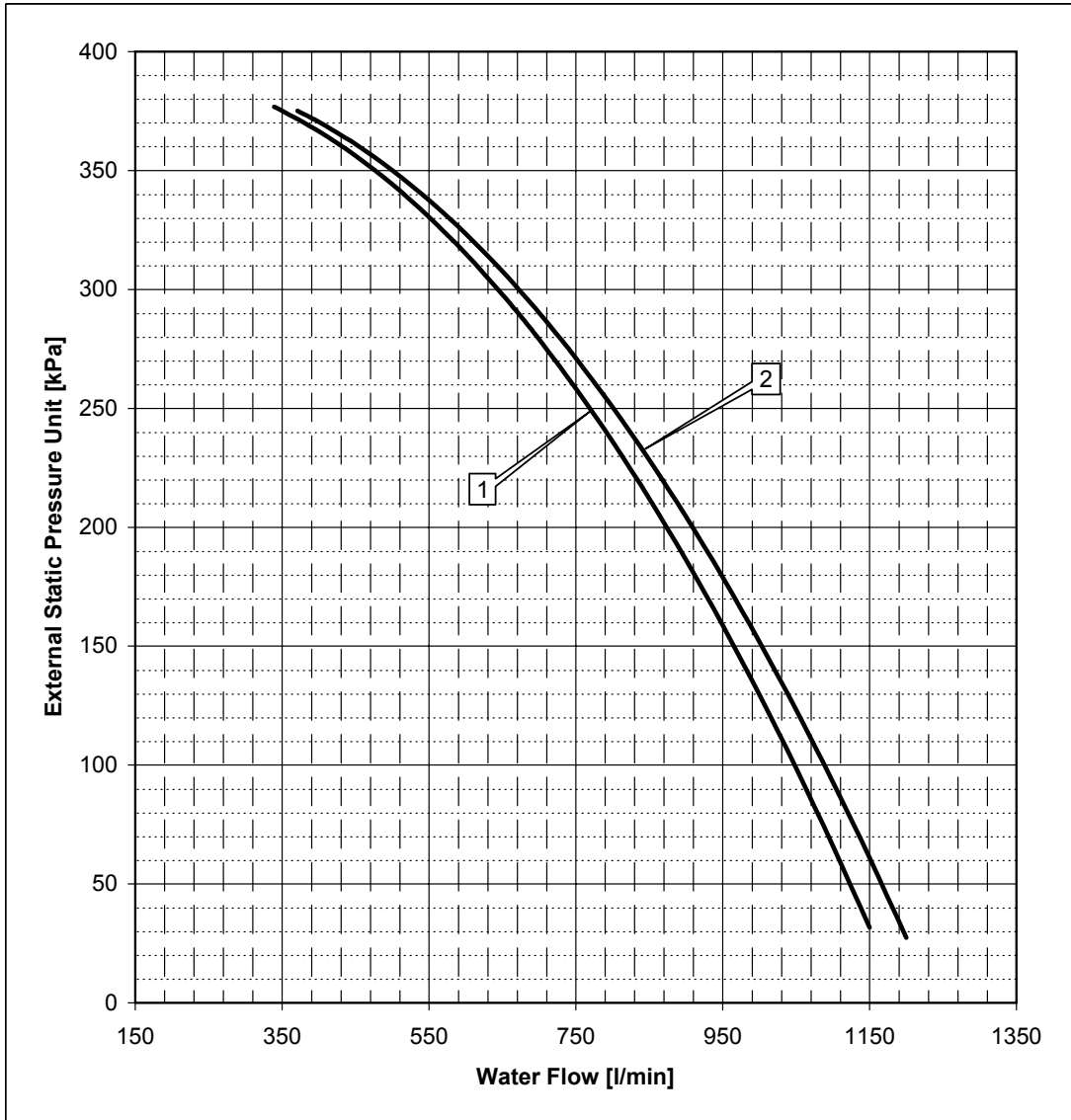

Symbols

The table below describes the symbols.

Symbol	Description
(1)	EWAQ240 DAYN*+0PSP
(2)	EWAQ260 DAYN*+0PSP

Selecting a flow outside the curves can cause damage to or malfunction of the unit. See also minimum and maximum allowed water flowrange. See "Technical Specifications: EWAQ080-260DAYN" on page 1–5.

4

1.25 External Static Unit Pressure: EWYQ080-100DAYN (OPHP)

External Static Pressure

The illustration below shows the water pressure drop through evaporator for EWYQ080-100DAYN (OPHP).

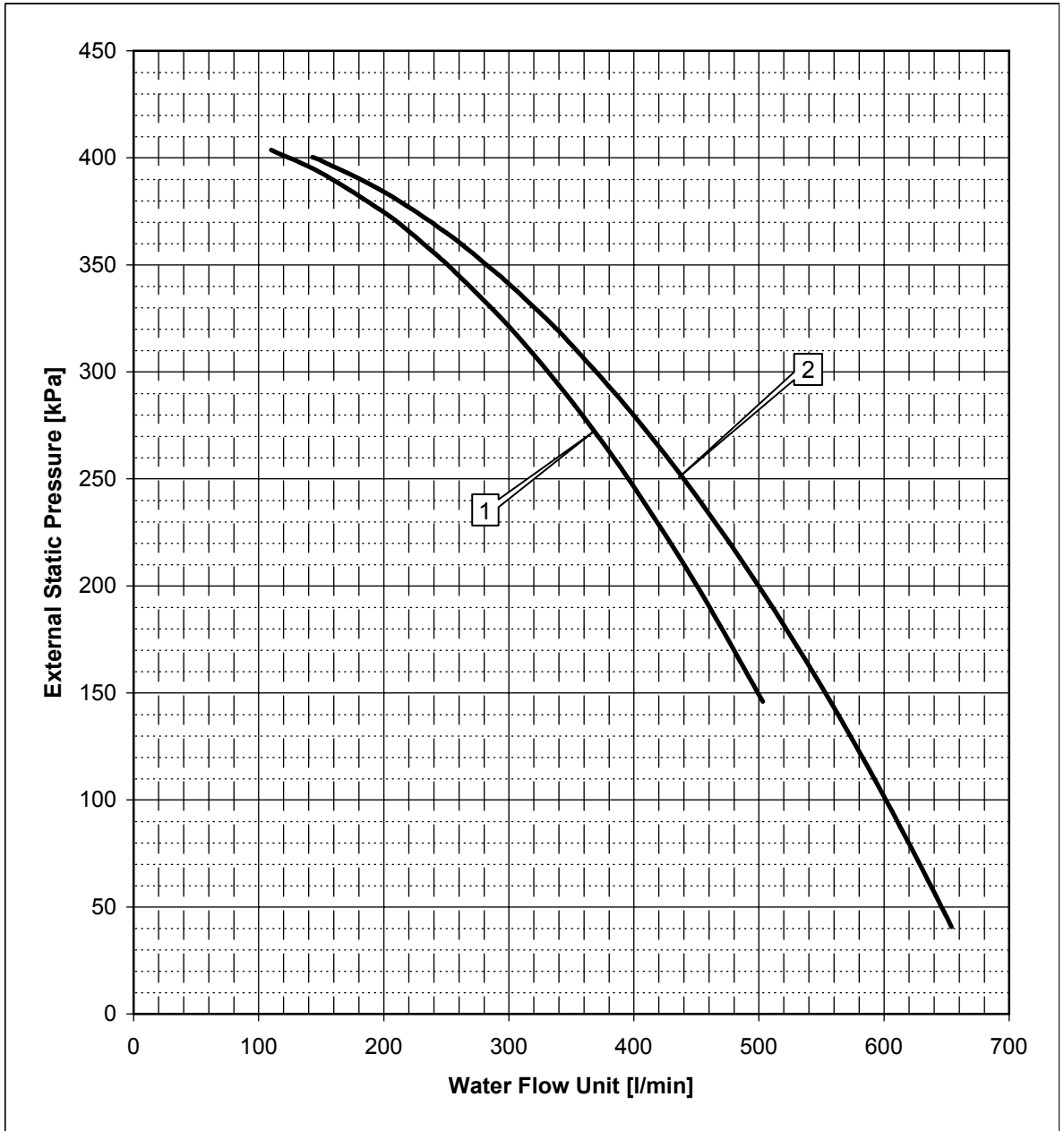

Symbols

The table below describes the symbols.

Symbol	Description
(1)	EWYQ080 DAYN*+0PSP
(2)	EWYQ100 DAYN*+0PSP

Selecting a flow outside the curves can cause damage to or malfunction of the unit. See also minimum and maximum allowed water flowrange. See "Technical Specifications: EWYQ080-250DAYN" on page 1–12.

1.26 External Static Unit Pressure: EWYQ130-210DAYN (OPHP)

External Static Pressure

The illustration below shows the water pressure drop through evaporator for EWYQ130-210DAYN (OPHP).

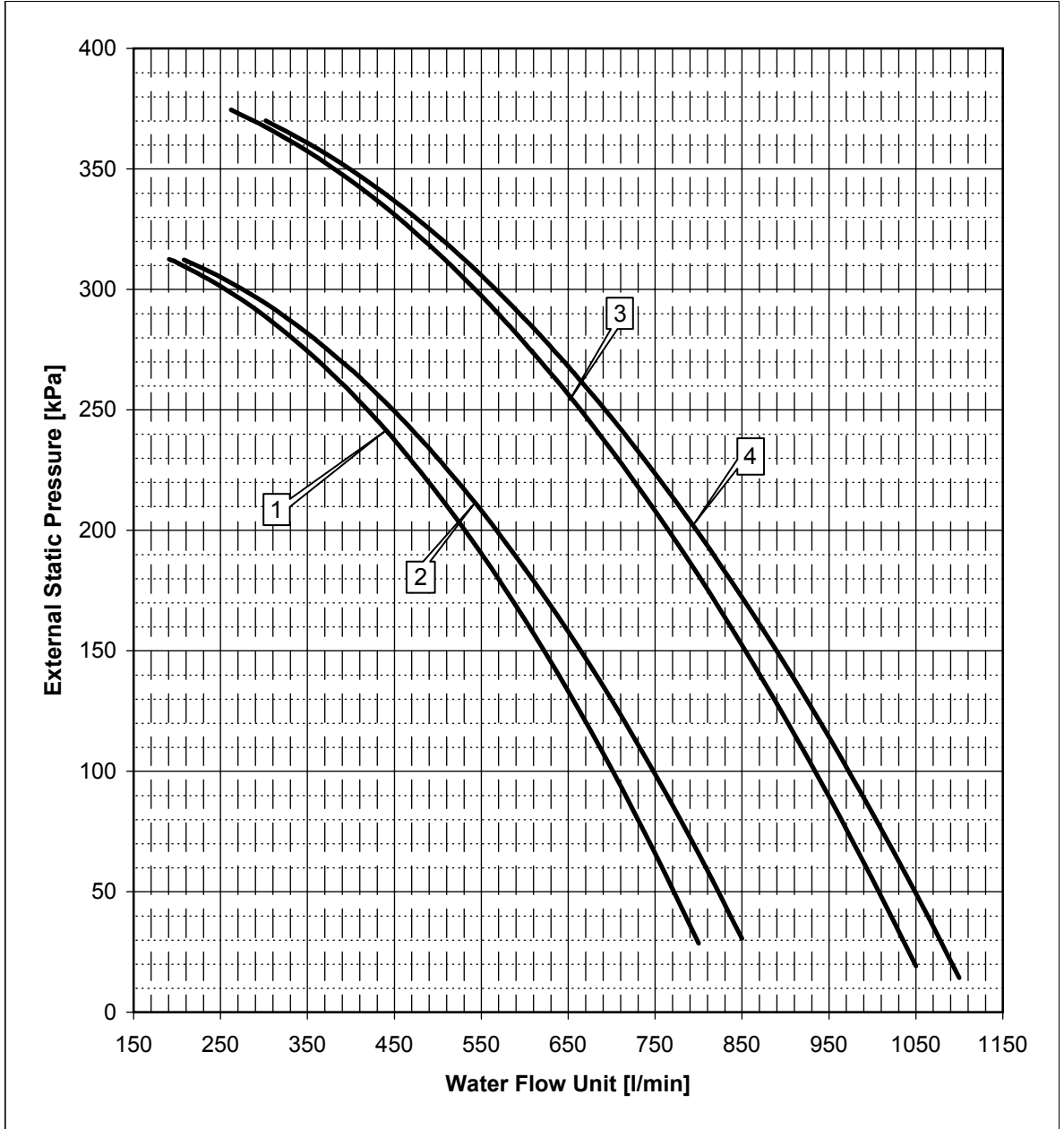

4

Symbols

The table below describes the symbols.

Symbol	Description
(1)	EWYQ130 DAYN*+0PSP
(2)	EWYQ150 DAYN*+0PSP
(3)	EWYQ180 DAYN*+0PSP
(4)	EWYQ210 DAYN*+0PSP

Selecting a flow outside the curves can cause damage to or malfunction of the unit. See also minimum and maximum allowed water flowrange. See "Technical Specifications: EWYQ080-250DAYN" on page 1–12.

1.27 External Static Unit Pressure: EWYQ230-250DAYN (OPHP)

External Static Pressure

The illustration below shows the water pressure drop through evaporator for EWYQ230-250DAYN (OPHP).

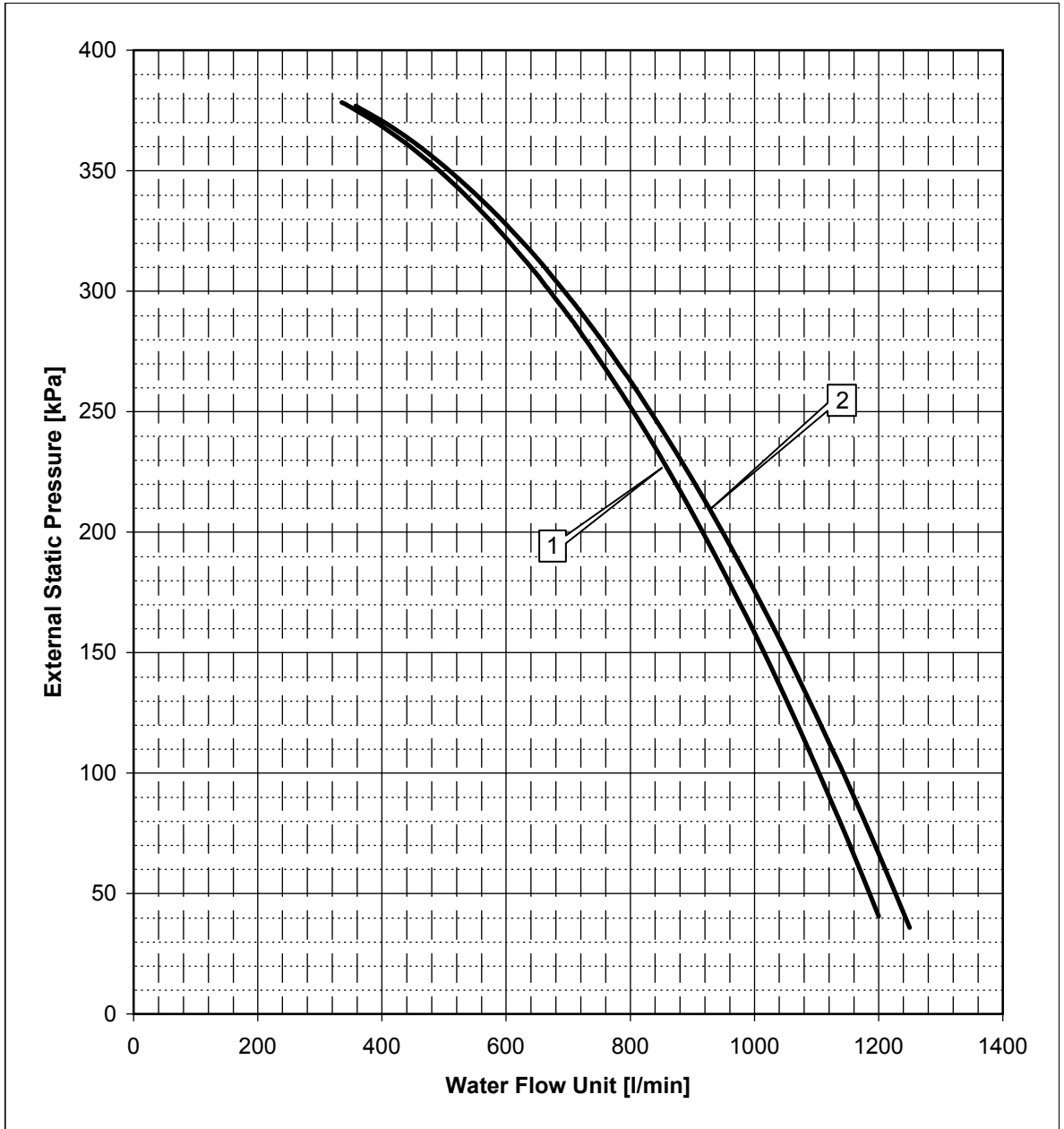

Symbols

The table below describes the symbols.

Symbol	Description
(1)	EWYQ230 DAYN*+0PSP
(2)	EWYQ250 DAYN*+0PSP

Selecting a flow outside the curves can cause damage to or malfunction of the unit. See also minimum and maximum allowed water flowrange. See "Technical Specifications: EWYQ080-250DAYN" on page 1–12.

1.28 Electrical Checks

Checklist

The table below contains the electrical checklist.

Step	Check whether...
1	The main fuses, earth leak detector and main isolator are installed.
2	The main power supply voltage deviates less than 10% from the nominal value.
3	The flow switch and pump contact are properly wired.
4	The optional wiring for pump control is installed.
5	The optional wiring for remote start/stop is installed. Make sure that the controller is correctly programmed.
6	The optional wiring for remote cool/heat is installed. Make sure that the controller is correctly programmed.

1.29 Field wiring connection diagram : EWAQ/EWYQ 080-260 DAYN*

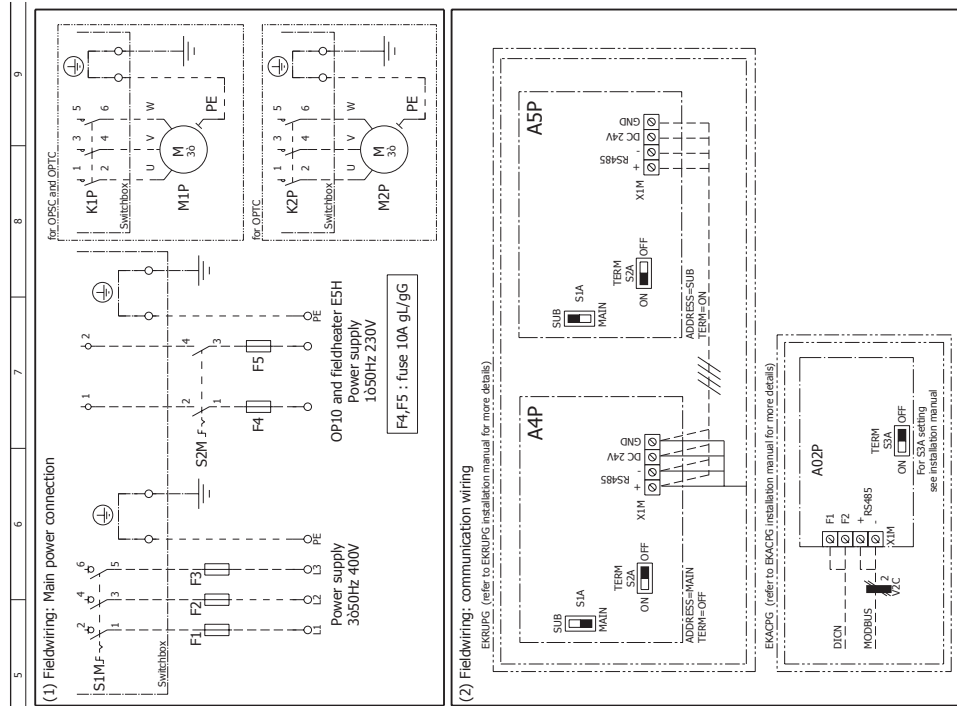

Translation of this legend can be found in the installation manual.

Obligatory	*
Not obligatory	#
Not included with standard unit	~
Possible as option	**
Not possible as option	###

LEGEND

--- : Field wiring
 (1) : Several wiring possibilities
 [] : Dipswitch set on left position

Part number	Description
A02P	** Communication PCB (EKACPG)
A4P	** PCB wired remote controller
A5P	** PCB wired remote controller (EKRLUPG)
E5H	* fieldheater
F1,F2,F3	# main fuses
F4,F5	# fuses for heaters
H1P	* indication lamp
H2,H3,H4,H5	* indication lamp, alarm signal (default NO)
H23,H4,H5,6P	* indication lamp for changeable digital outputs
K1P	** pump contactor (Only OPSP/OPHP/OPPC/OPPT/OPTC)
K2P	** pump contactor (Only OPSP/OPHP/OPPC/OPPT/OPTC)
K1S	* overcurrent relay pump (PIB unit or OPSC)
M1P	* pump motor 1 (Only for OPTR/OPTC)
M2P	* pump motor 2 (Only for OPTR/OPTC)
OP10	* heater tap switch
S1M	* main isolator switch
S12,S4,S5	* switch for changeable analog input
S2M	# heater tap isolator switch
V2C	** ferrite core (EKACFG)

Options (factory installed)
 OPSP = Single pump
 OPPT = Twin pump
 OPSC = Single pump contactor
 OPTC = Twin pump contactor
 OPHP = HIESP pump
 OPF = Inverter fans

Options (user installed)
 EKACPG = Address card including
 - Release (integrated mecbusa)
 - FI,F2 (DICH + DBACS connection)
 EKRLUPG = Remote user interface

N,model = unit with no options included
 Ch. = Changeable

Changeable I/O possible functions

Refer to the installation manual for instructions how to configure changeable I/O

Changeable digital input (4 available)	Changeable analog output (1 available)
<ul style="list-style-type: none"> None Status Dual setpoint Remote on-off Capacity limitation 26%, 60%, 76% or setting Low noise (only for OPPIF) Free cooling signal Fan forced on 	<ul style="list-style-type: none"> None Unit Capacity (mA/V) Details of types: <ul style="list-style-type: none"> Type mA: 0...20mA / 4...20mA Type V: 0-1V / 0-5V / 0-10V
Changeable digital output (6 or 5 available depending on unit)	Changeable analog input (4 available)
<ul style="list-style-type: none"> None (open) Speed 2-wire pump 100% capacity Full capacity Free cooling General operation Safety/warning NO Safety/warning NC (only for Ch DO 1) Safety NO (excluding warning) Safety NC (excluding warning) (only for Ch DO 1) CI/2 Safety NO Warning NO Warning NC Cooling (only EWYQ) Heating (only EWYQ) Defrost (only EWYQ) 	<ul style="list-style-type: none"> None Status (mA/V/NTC; DI) Water setpoint (mA/V/NTC) Water temperature measurement (NTC) Changeable DI (refer to Ch DI for possibilities (DI)) Details of types: <ul style="list-style-type: none"> Type mA: 0...20mA / 4...20mA (internal 5V or external power supply) Type V: 0-1V / 0-5V / 0-10V Type DI: DI (6V detection) <p>* : for allowed NTC types and how to configure the software please contact your local dealer.</p>

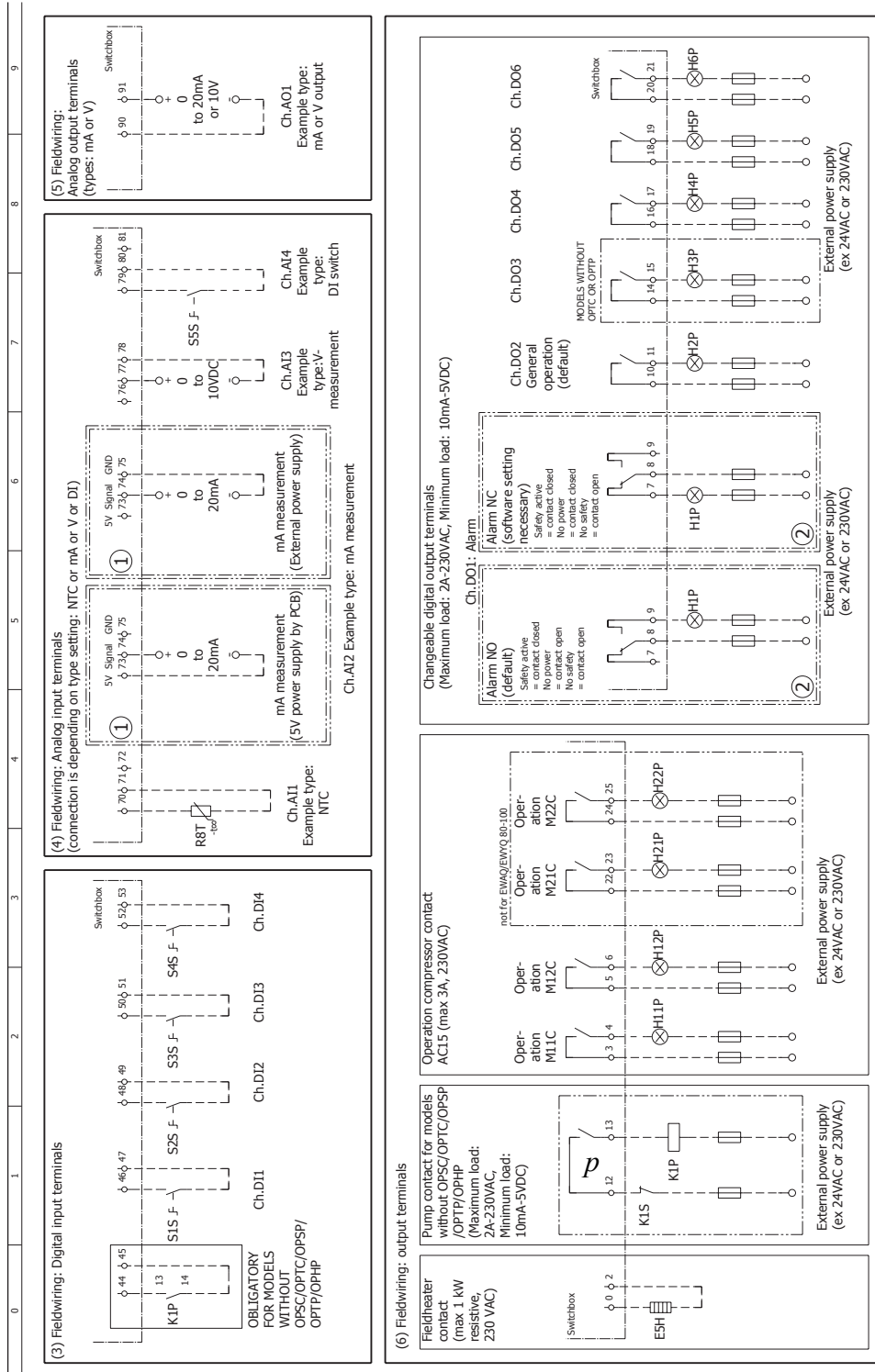

Part 5

Maintenance

Introduction

Preventive maintenance should be set up for operation at maximum capacity or to avoid damage. The following chapters explain how to or when to maintain the units.

It is also applicable on other types of Daikin chillers.

What is in this part?

This part contains the following chapters:

Chapter	See page
1–Maintenance	5–3

5

1 Maintenance

1.1 What Is in This Chapter

Introduction

As shown in the table below, we have grouped the maintenance in maintenance of the main parts (condenser, compressor and evaporator) and periodical checks.

Precautions

Correct choices and decisions have to be made before any maintenance is done. Opening the refrigerant circuit may cause a loss of refrigerant or lead to system contamination.

- Avoid high gas concentrations.
While the heavy concentration of the refrigerant gas will remain on the floor level, good ventilation is a must.
- Avoid all contact with open fires or hot surfaces.
By high temperatures, the refrigerant gas R410A may decompose into irritating and poisonous gas. Avoid skin and hand contact with the liquid refrigerant and protect your eyes against liquid splashes.

Overview

This chapter covers the following topics:

Topic	See page
1.2–Maintenance of the Main Parts	5–4
1.3–Maintenance of the Control Devices	5–6
1.4–Periodical Checks	5–7

1.2 Maintenance of the Main Parts

Preventive maintenance

A program of scheduled maintenance should be set up and followed. The items mentioned are to be used as a guide and must be used in combination with sound electrical and refrigeration workmanship to ensure trouble free operation and performance.

Unit Casing

Follow the below instructions to check the unit casing.

Check if...	If not, then...
The paint of the unit casing is intact.	Touch-up with paint.
All plate work is screwed down in position.	Screw the plate work down in position.

Compressor

Follow the instructions below to check the compressor:

- Check crankcase heater operation. Switch of the compressor and carefully touch the crankcase heater area by hand.

No operation can cause compressor damage when the ambient temperature reaches a low temperature.

Evaporator and condenser

Follow the instructions below to check the evaporator and condenser:

- Inspect the water and condenser after the first operating season. This condition indicates the required frequency of cleaning and also whether water treatment is needed in the chilled water circuit.
- Check the air plugs and drain plugs to prevent or detect water leakage.
- Check pressure-drop and water flow.
- Record temperature difference between water in/out temperature.
- Inspect evaporator insulation. If damaged, repair.
- Inspect water and refrigerant connections.
- If the evaporator heater-tape is installed, check operation by direct power connection and hand-touch.
- Brush cleaning. Abnormal high condensing-pressures are an indication for periodic cleaning.

Unit switchbox

Follow the instructions below to check the unit switchbox:

- Check all power connections for tightness.
- Check compressor motor terminals.
- Inspect wiring for any signs of overheating (discolouring).
- Remove all dust and debris from the switchbox. Replaced coils and components should not be left in the unit control panel.
- Check all field-wired terminals.

Expansion valve

The expansion valve will allow the correct amount of refrigerant to enter the evaporator to match the cooling load (by keeping a constant superheat). Follow the instructions below to check the expansion valve.

- Check the superheat setting.
- Inspect the LP sensor operation (offset). Compare the controller valve with a pressure gauge.
- Inspect the suction temperature sensor (offset). Compare the controller valve with a temperature probe.

Flow switch and pump interlock

Follow the instructions below to check the flow switch and the pump interlock.

- Check operation by ohmmeter after disconnecting the wires to the field terminals and simulating flow and no-flow conditions.
 - Inspect the flow-switch for possible corrosion (glycol applications). Check electrical connections for shunts or bridges.
-

1.3 Maintenance of the Control Devices

Preventive maintenance

A program of scheduled maintenance should be set up and followed. The items mentioned are to be used as a guide and must be used in combination with sound electrical and refrigeration workmanship to ensure trouble free operation and performance.

1.4 Periodical Checks

Electrical checks

The table below contains the electrical checks.

Inspection checks and actions	Remarks
Check that all electrical wiring is properly connected and securely tightened.	—
Check the electrical components for damage or loss.	—
Check if the power supply corresponds with the identification label of the unit.	—
Check the operation of the circuit breaker and the earth leak detector of the local supply panel.	—
Check the operation of the safety devices.	No operation can cause damage of the unit.

Refrigerant checks

The table below contains the refrigerant checks.

Inspection checks and actions	Remarks
Check the refrigerant circuit. <ul style="list-style-type: none"> ■ If the unit leaks, contact your dealer. 	—

Water checks

The table below contains the water checks.

Inspection checks and actions	Remarks
Check the water condition. <ul style="list-style-type: none"> ■ Drain the water from the air release plug. ■ If the water is dirty, replace all the water in the system. 	Dirty water causes a cooling capacity drop as well as corrosion of the water heat exchanger and pipe.
Check the water connection.	—
Check the water velocity.	—
Check the function of the flow switch.	The evaporator can freeze up if the flow switch is not able to operate.
Make sure that there is no air mixed in the water pipes.	Even if air is removed at the beginning, air can sometimes enter later. Bleed therefore the system regularly.
Check the water filter.	—

Noise checks

The table below contains the noise checks.

Inspection checks and actions	Remarks
Check for any abnormal noise. <ul style="list-style-type: none">■ Locate the noise producing section and search the cause.■ If the cause of the noise cannot be located, contact your dealer.	—

Part 6

Appendix

Introduction History of the software

What is in this part? This part contains the following chapters:

Chapter	See page
1-Appendix	6-3

6

1 Appendix

1.1 What Is in This Chapter

Introduction History of the software

Overview This chapter covers the following topics:

Topic	See page
1.2–History of the Software	6–4

1.2 History of the Software

C

Components Water side	
EWAQ-EWYQ-DAYN(N-P-B)	1-85

D

DICN (network)	2-145
----------------------	-------

E

Electrical Checks	4-46
Electrical Specifications	
EWAQ080~260DAYN	1-19
EWAQ130~150DAYN	1-21
EWAQ180~210DAYN	1-22
Electrical Specifications for options	
EWAQ080~100DAYN	1-20
EWAQ080-100DAYN	1-20
EWAQ180~210DAYN	1-22
EWAQ 080~ 260 DAYN	
description	i-i
EWYQ 080~250 DAYN	
description	i-i
External Static Unit Pressure	
EWAQ080-100DAYN (OPHP)	4-37
EWAQ080-100DAYN (P-B)	4-29
EWAQ130-210DAYN (OPHP)	4-39
EWAQ130-210DAYN (P-B)	4-31
EWAQ240-260DAYN (OPHP)	4-40
EWAQ240-260DAYN (P-B)	4-32
EWYQ080-100DAYN (OPHP)	4-41
EWYQ080-100DAYN (P-B)	4-34
EWYQ130-210DAYN (OPHP)	4-43
EWYQ130-210DAYNN (P-B)	4-35
EWYQ230-250DAYN (OPHP)	4-45
EWYQ230-250DAYN (P-B)	4-36

F

Floating setpoint - Ambient mode	2-129
Free cooling on ambient temperature	2-133
Functional Diagram Refrigeration Circuit	
EWAP400~540MBYNN	1-80
EWAQ130~150DAYN(N-P-B)	1-70
EWAQ240=260DAYN(N-P-B)	1-72
EWYQ080~100DAYN(N-P-B)	1-76
EWYQ130~210DAYN(N-P-B)	1-78
EWYQ230~250DAYN(N-P-B)	1-80
EWYQ230-250DAYN(N-P-B)	1-80
Functional Diagram Water Piping	
EWAQ-EWYQ-DAYN(N-P-B)	1-84

G

General Checks	4-5
----------------------	-----

H

High pressure setback	2-127
History of the software	6-4
How to read or adjust parameter settings	2-14

M

Maintenance of the Control Devices	5-6
Maintenance of the Main Parts	5-4, 6-4
Manual control	2-114
Menu overview	2-13

O

On/Off management	2-107
Operation flowchart	2-106
Operational Range	
EWAQ080-100-180-210-240-260DAYN(N-P-B)	2-4
EWAQ130~150DAYN(N-P-B)	2-5
EWYQ080-100-180-210-230-250DAYN(N-P-B)	2-6
EWYQ130~150DAYN(N-P-B)	2-7
Optional equipment for EWYQ~DAYN(N-P-B)	1-33
Outlook Drawing	
EWAQ080~100DAYN(N)	1-34
EWYQ180~210DAYN(N)	1-58
Overview of network safeties	3-19
Overview of the circuit safeties	3-11
Overview of the unit safeties	3-6
Overview of warnings	3-21

P

Password function	2-164
Periodical Checks	5-7
Pump control	2-128

R

Read-out menu	2-15
---------------------	------

S

Set Points Menu	2-25
Start/Stop, Cool/Heat and Temperature settings	2-12

T

Technical Specifications	
EWAQ080~100DAYN	1-8
EWAQ080~260DAYN	1-5
EWAQ130~150DAYN	1-9
EWAQ180~210DAYN	1-10
EWAQ240~260DAYN	1-11
EWTP110~540MBYNN	1-12
EWYQ230~250DAYN	1-18

Technical specifications for options	
EWYQ180~210DAYN	1-17
The Controller	2-10
Thermostat control	2-108
Thermostat settings	2-27

U

Unit Pressure Drop	
EWAQ080-100DAYNN	4-17
EWAQ130-210DAYNN	4-19
EWAQ240-260DAYNN	4-21
EWYQ080-100DAYNN	4-23
EWYQ130-210DAYNN	4-25
EWYQ230-250DAYNN	4-27
User Settings	2-26

W

Water Piping Checks	4-6
Water Pressure Drop through Evaporator	
EWAQ080-100DAYN (N-P-B)	4-11
EWAQ130-210DAYN (N-P-B)	4-12
EWAQ240-260DAYN (N-P-B)	4-13
EWYQ080-100DAYN (N-P-B)	4-14
EWYQ130-210DAYN (N-P-B)	4-15
Water Pressure Drop through evaporator	
EWYQ230-250DAYN (N-P-B)	4-16
What happens in the event of an alarm	3-4
What to do in the event of an alarm	3-5
Wiring Layout	
EWAQ080=100DAYN(N-P-B) and EWYQ080=100DAYN(N-P-B) with OPIF	1-149
EWAQ080~100DAYN(N-P-B) and EWYQ080~100DAYN(N-P-B) standard unit	1-88
EWAQ130=260DAYN(N-P-B) and EWYQ130=250DAYN(N-P-B) standard unit	1-116

