



ESIE07-11



Service Manual

**EWAP 800-C18AJYNN
EWAP 850-C18AYNN/A**

Air-cooled chillers and heat recovery chillers

Table of Contents

1 Introduction

1.1	About This Manual	i-i
1.2	Nomenclature.....	i-ii

Part 1 System Outline

1 General Outline

1.1	What Is in This Chapter?	1-3
1.2	Technical Specifications: EWAP-AJYNN	1-4
1.3	Technical Specifications: EWAP-AJYNN/A	1-8
1.4	Electrical Specifications: EWAP-AJYNN.....	1-12
1.5	Electrical Specifications: EWAP-AJYNN/A	1-14
1.6	Outlook Drawing: EWAP-AJYNN	1-16
1.7	Outlook Drawing: EWAP-AJYNN/A	1-38
1.8	Capacity tables EWAP-AJYNN	1-60
1.9	Capacity tables EWAP-AJYNN + OPRN + OPLN.....	1-64
1.10	Capacity tables EWAP-AJYNN/A	1-67
1.11	Capacity tables EWAP-AJYNN/A + OPRN + OPLN	1-70
1.12	Correction Factors	1-73
1.13	Heat recovery ratings.....	1-74
1.14	Sound level data	1-81

Part 2 Functional Description

1 Operation Range

1.1	What Is in This Chapter?	2-3
1.2	Operational Range: EWAP-AJYNN	2-4
1.3	Operational Range: EWAP-AJYNN with option OPRN/OPLN.....	2-6
1.4	Operational Range: EWAP-AJYNN/A	2-8
1.5	Operational Range: EWAP-AJYNN/A with option OPRN/OPLN.....	2-10

2 The Digital Controller

2.1	What Is in This Chapter?	2-13
2.2	System Architecture	2-14
2.3	Customer Interfaces	2-15
2.4	Display and Keypad	2-24

3 Functional Control

3.1	What Is In This Chapter?	2-77
3.2	ON / OFF Management	2-79
3.3	Thermostat Control	2-80
3.4	Setpoint Reset of the Chilled Water	2-85
3.5	Return Water Reset	2-88
3.6	Freeze-up Control	2-89
3.7	Enable Soft Load	2-91
3.8	Unit Load Limiting	2-92
3.9	Start Up With High Evaporator Water Temperature	2-93
3.10	Ambient Lockout	2-94
3.11	Pump Control	2-95
3.12	Auto Restart after Power Failure Function	2-96
3.13	Liquid Injection	2-97
3.14	Economizer Function	2-98
3.15	EXV Pre Opening	2-99
3.16	Compressor Configuration	2-100
3.17	Compressor Management	2-101
3.18	High Pressure Setback	2-103
3.19	LP Prevention	2-104
3.20	Capacity Control	2-105
3.21	Pump Down Configuration at Compressor Stop	2-108
3.22	Pressure Safeties	2-109
3.23	LP alarm delay	2-111
3.24	Oil Management Safeties	2-112
3.25	Head Pressure Control	2-114
3.26	Heat Recovery Microprocessor Control	2-118
3.27	Heat Recovery Operation	2-119
3.28	Heat Recovery Microprocessor Set-up	2-120

Part 3 Troubleshooting

1 Overview of Fault Indications and Safeties

1.1	What Is in This Chapter?	3-3
1.2	What to do in the Event of an Alarm?	3-4
1.3	Overview of Safeties	3-5

2 Checking the Inputs and Outputs

2.1	What is in This Chapter?.....	3-7
2.2	List of Digital Inputs.....	3-8
2.3	List of Analog Inputs	3-9
2.4	List of Digital Outputs.....	3-10
2.5	List of Analog Outputs.....	3-11
2.6	List of Input and Output Channels of the Expansion Board # 1 (Option Econo- mizer)	3-12

3 Procedure for Software Upload/Download

3.1	What is in This Chapter?.....	3-13
3.2	Copy from the Software Key to pCO ²	3-14
3.3	Copy from pCO ² to the Software Key	3-15
3.4	Installation of Winload32 on the PC and Programming a Controller.....	3-16
3.5	Copy Software from WinLoad32 to the Software key	3-31

4 Procedure to Protect Compressor in Case of Frozen Evaporator

4.1	What is in This Chapter?.....	3-33
4.2	Procedure to Protect Compressor in Case of Frozen Evaporator.....	3-34

5 Procedure to Clear the Refrigerant Circuit in Case of Frozen Evaporators

5.1	What Is in This Chapter?	3-35
5.2	Procedure to Clean the Refrigerant Circuit in Case of Frozen Evaporators	3-36

6 Procedure for the Changing and Configuration of the Display

6.1	What Is in This Chapter?	3-37
6.2	Changing the Display.....	3-38
6.3	Configuration Procedure for the pLan Settings.....	3-39

7 Procedure for the Changing and Configuration of the PCO² (“I/O Board”)

7.1	What Is in This Chapter?	3-41
7.2	Changing the PCO ² controller	3-42

8 Procedure for the Changing of the Electronic Expansion Valve Driver

8.1	What is in This Chapter?	3-43
8.2	Changing the Expansion Valve Driver	3-44

9 Procedure for the Changing and Configuration of the Expansion I/O Board (Optional)

9.1	What is in This Chapter?	3-45
9.2	Changing the PCO ² Expansion Board	3-46

10 Manual Upload or Download Control Test Procedure

10.1	What is in This Chapter?	3-47
10.2	Manual Upload or Download Control Test Procedure	3-48

11 Troubleshooting Chart

11.1	What is in This Chapter?	3-49
11.2	Troubleshooting Chart	3-50

12 Prestart System Checklist

12.1	What is in This Chapter?	3-55
12.2	Prestart System Checklist.....	3-56

Part 4 Commissioning and Test Run

1 Pre-Test Run Checks

1.1	What Is in This Chapter?	4-3
1.2	General Checks	4-4
1.3	Water Piping Checks	4-5
1.4	Water Pump Diagram	4-7
1.5	Evaporator Pressure Drop: EWAP-AJYNN and EWAP-AJYNN/A.....	4-8
1.6	Pressure Drop for Partial Heat Recovery.....	4-10
1.7	Pressure Drop for Full Heat Recovery	4-11
1.8	Water Flow and Pressure Drop Precautions.....	4-12
1.9	Electrical Checks	4-13

Part 5 Maintenance

1 Maintenance

1.1	What Is in This Chapter	5-3
1.2	System Maintenance	5-4
1.3	Preventive Maintenance Schedule	5-8
1.4	Start-up and Shut-down	5-9
1.5	Seasonal Shut-down	5-10
1.6	Maintenance Shut-down	5-11
1.7	Periodical Checks	5-12

1 Introduction

1.1 About This Manual

Target group	This service manual is intended for and should only be used by qualified engineers.
Purpose of this manual	This service manual contains all the information you need to carry out the necessary repair and maintenance tasks for the EWAP800-C18AJYNN and EWAP850-C18AJYNN/A.
6 different lines	EWAP- AJYNN line is available with two different efficiencies in order to satisfy every kind of requirement. Acoustic flexibility down to 72,5 dBA thanks to different noise level versions.
4 different lines	EWAP-AJYNN line is available with two different efficiencies in order to satisfy every kind of requirement. Acoustic flexibility down to 72,5 dBA thanks to different noise level versions: <ul style="list-style-type: none"> ■ Standard efficiency with EER up to 2,35. <ul style="list-style-type: none"> ■ EWAP-AJYNN (80,5 / 81,5 dBA) ■ EWAP-AJYNN + OPRN (75 / 77 dBA) ■ EWAP-AJYNN + OPLN (72,5 / 73,5 dBA) ■ High efficiency with EER up to 2,69. <ul style="list-style-type: none"> ■ EWAP-AJYNN/A (80,5 / 81,5 dBA) ■ EWAP-AJYNN/A + OPRN (75 / 77 dBA) ■ EWAP-AJYNN/A + OPLN (72,5 / 73,5 dBA)
OPRN-option	Reduced noise option: Standard version with additional base frame for compressors and oil separators installed on rubber isolators to eliminate the vibrations. Discharge flexible pipes and condenser fans rotating at fixed low speed.
OPLN-option	Low noise option: The main components are the same of the OPRN version (same cooling capacity) but to reduce the sound level the compressors, the oil separators and delivery and suction pipes are located inside a cabinet which is sound insulated with highly absorbent acoustic material. Discharge flexible pipes and condenser fans rotating at fixed low speed are supplied as standard.

1.2 Nomenclature

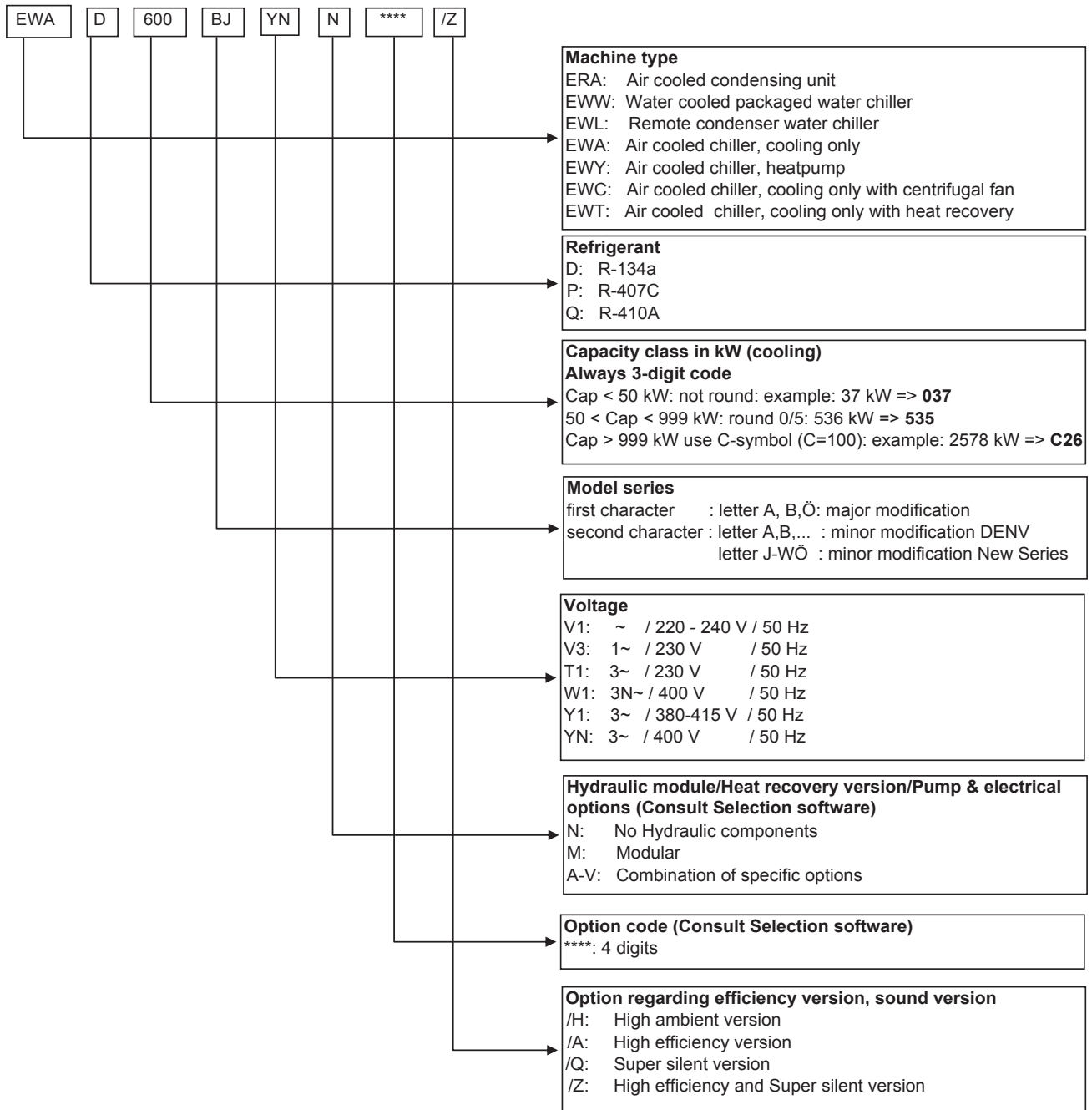

Part 1

System Outline

Introduction

This part contains an outline of all the relevant elements in the EWAP800-C18AJYNN and EWAP850-C18AJYNN/A installation.

What is in this part?

This part contains the following chapters:

Chapter	See page
1 General Outline	1-3

1

1 General Outline

1.1 What Is in This Chapter?

Introduction

This chapter contains the following information:

- Technical specifications
- Electrical specifications
- Correction factors
- Outlook drawings: Outlook, dimensions, installation and service space.

Overview

This chapter contains the following topics:

Topic	See page
1.2 Technical Specifications: EWAP-AJYNN	1–4
1.3 Technical Specifications: EWAP-AJYNN/A	1–8
1.4 Electrical Specifications: EWAP-AJYNN	1–12
1.5 Electrical Specifications: EWAP-AJYNN/A	1–14
1.6 Outlook Drawing: EWAP-AJYNN	1–16
1.7 Outlook Drawing: EWAP-AJYNN/A	1–38
1.8 Capacity tables EWAP-AJYNN	1–60
1.9 Capacity tables EWAP-AJYNN + OPRN + OPLN	1–64
1.10 Capacity tables EWAP-AJYNN/A	1–67
1.11 Capacity tables EWAP-AJYNN/A + OPRN + OPLN	1–70
1.12 Correction Factors	1–73
1.13 Heat recovery ratings	1–74
1.14 Sound level data	1–81

1.2 Technical Specifications: EWAP-AJYNN

Technical specifications

The table below contains the technical specifications.

MODEL				EWAP800AJY NN	EWAP900AJY NN	EWAP950AJYNN	EWAPC10AJY N	EWAPC11AJYNN	EWAPC12AJY N
Capacity (Eurovent conditions specified in notes)	Cooling	Nominal	kW	790	875	944	1026	1092	1158
Capacity Steps			%	stepless 12.5-100	stepless 12.5-100	stepless 12.5-100	stepless 12.5-100	stepless 12.5-100	stepless 8.3-100
Nominal input (Eurovent conditions specified in notes)	Cooling		kW	340	373	405	442	476	507
EER				2.32	2.34	2.33	2.32	2.29	2.28
ESEER				2.87	2.90	2.89	2.88	2.84	2.90
Casing	Colour			RAL7032					
Dimensions	Unit	Height	mm	2520	2520	2520	2520	2520	2520
		Width	mm	6210	7110	7110	8010	8010	9170
		Depth	mm	2230	2230	2230	2230	2230	2230
Weight	Unit		kg	5165	5425	5555	5795	5905	7990
	Operating weight		kg	5430	5710	5840	6070	6180	8270
Water heat exchanger	Minimum water volume in the system (Formula)			The minimum water content per unit should be calculated with a certain approximation using this simplified formula: $Q=35.83 \times (P(kW) / \Delta T (^{\circ}C)) \times (1/N)$ where: Q= minimum water content per unit expressed in litres. P= minimum cooling capacity of the unit expressed in kW. ΔT = evaporator entering / leaving water temperature difference expressed in $^{\circ}C$ N= Number of compressors. For more accurate determination of water, it is advisable to contact the designer of the plant.					
Air heat exchanger	Type			Lanced fins - internally spiral wound tubes					
Water Heat Exchanger	Type			Shell and tube					
	Minimum water volume in the system		l	278	271	271	256	256	263
	Water flow rate	Min	l/min	882	1090	1096	1371	1373	1212
		Nominal	l/min	2265	2508	2706	2941	3130	3320
	Max	l/min	2788	3445	3465	4337	4341	3833	
Nominal water pressure drop	Cooling	Heat exchanger	kPa	66	53	61	46	52	75
Water Heat Exchanger	Model	Quantity		1	1	1	1	1	1
Fan	Type			Helical					
	Drive			Direct drive					
	Diameter		mm	800	800	800	800	800	800
	Nominal air flow		m ³ /min	3978	4314	4644	4974	5304	5970
	Model	Quantity		12	13	14	15	16	18
		Speed	rpm	860	860	860	860	860	860
		Motor Output	W	2000	2000	2000	2000	2000	2000
Discharge direction			Vertical						

Compressor	Type			Semi-hermetic single screw compressor					
	Refrigerant oil charge		l	28	28	28	28	28	28
	Model	Quantity		2	2	2	2	2	2
		Speed	rpm	2950	2950	2950	2950	2950	2950
Sound Level	Sound power	Cooling	dBA	101	102	102	103	103	103
	Sound Pressure	Cooling	dBA	80.5	80.5	81	81	81	81
	Sound Pressure + OPRN		dBA	75.0	75.0	75.5	76.0	76.0	76.5
	Sound Pressure +OPLN		dBA	72.5	72.5	72.5	72.5	72.5	73.0
Refrigerant circuit	Refrigerant type			R-407C					
	Refrigerant charge		kg	120	130	140	150	160	180
	No of circuits			2	2	2	2	2	3
	Refrigerant control			Electronic expansion valve					
Piping connections	Evaporator water inlet/outlet			Victaulic, diameter 219.1mm					
Safety Devices				High pressure (pressure switch)					
				Low pressure (pressure switch)					
				Condensation fan magneto-thermal					
				High discharge temperature on the compressor					
				Phase monitor					
				Star/delta transition failed					
				Low delta pressure between suction and discharge					
				Low pressure ratio					
				High oil pressure drop					
				Low oil pressure					
Notes				Nominal cooling capacity and power input are based on 12/7°C entering/ leaving water temp. and 35°C air ambient temp. Power input is for the whole unit.					

MODEL				EWAPC13AJYNN	EWAPC14AJYNN	EWAPC15AJYNN	EWAPC16AJYNN	EWAPC17AJYNN	EWAPC18AJYNN
Capacity (Eurovent conditions specified in notes)	Cooling	Nominal	kW	1284	1354	1426	1516	1583	1650
Capacity Steps			%	stepless 8.3-10	stepless 8.3-10	stepless 8.3-10	stepless 8.3-10	stepless 8.3-10	stepless 8.3-10
Nominal input (Eurovent conditions specified in notes)	Cooling		kW	546	578	609	647	682	717
EER				2.35	2.34	2.34	2.34	2.32	2.30
ESEER				2.98	2.98	2.97	2.98	2.95	2.93
Casing	Colour			RAL7032					
Dimensions	Unit	Height	mm	2520	2520	2520	2520	2520	2520
		Width	mm	10070	10070	10970	10970	11870	11870
		Depth	mm	2230	2230	2230	2230	2230	2230
Weight	Unit		kg	8305	8435	8890	8905	9155	9265
	Operating weight		kg	8775	8905	9360	9350	9600	9710

1

Water heat exchanger	Minimum water volume in the system (Formula)		The minimum water content per unit should be calculated with a certain approximation using this simplified formula: $Q=35.83 \times (P(kW) / \Delta T (^{\circ}C)) \times (1/N)$ where: Q= minimum water content per unit expressed in litres. P= minimum cooling capacity of the unit expressed in kW. ΔT = evaporator entering / leaving water temperature difference expressed in $^{\circ}C$ N= Number of compressors. For more accurate determination of water, it is advisable to contact the designer of the plant.						
Air heat exchanger	Type		Lanced fins - internally spiral wound tubes						
Water Heat Exchanger	Type		Shell and tube						
	Minimum water volume in the system	l	432	432	432	419	419	419	
	Water flow rate	Min	l/min	1614	1626	1642	2357	2359	2365
		Nominal	l/min	3681	3882	4088	4346	4538	4730
Max		l/min	5104	5141	5192	7453	7460	7479	
Nominal water pressure drop	Cooling	Heat exchanger	kPa	52	57	62	34	37	40
Water Heat Exchanger	Model	Quantity	1	1	1	1	1	1	
Fan	Type		Helical						
	Drive		Direct drive						
	Diameter	mm	800	800	800	800	800	800	
	Nominal air flow	m ³ /min	6300	6636	7440	7296	7632	7962	
	Model	Quantity		19	20	22	22	23	24
		Speed	rpm	860	860	860	860	860	860
		Motor Output	W	2000	2000	2000	2000	2000	2000
	Discharge direction		Vertical						
Compressor	Type		Semi- hermetic single screw compressor						
	Refrigerant oil charge	l	28	28	28	28	28	28	
	Model	Quantity		3	3	3	3	3	3
		Speed	rpm	2950	2950	2950	2950	2950	2950
Sound Level	Sound power	Cooling	dBA	104	104	104	104	104	104
	Sound Pressure	Cooling	dBA	81.5	81.5	81.5	81.5	81.5	81.5
	Sound Pressure + OPRN		dBA	76.0	76.0	76.5	76.5	77.0	77.0
	Sound Pressure +OPLN		dBA	72.5	73.0	73.0	73.0	73.5	73.5
Refrigerant circuit	Refrigerant type		R-407C						
	Refrigerant charge	kg	190	200	210	220	230	240	
	No of circuits		3	3	3	3	3	3	
	Refrigerant control		Electronic expansion valve						
Piping connections	Evaporator water inlet/outlet		Victaulic, diameter 273mm						

Safety Devices	High pressure (pressure switch)
	Low pressure (pressure switch)
	Condensation fan magneto-thermal
	High discharge temperature on the compressor
	Phase monitor
	Star/delta transition failed
	Low delta pressure between suction and discharge
	Low pressure ratio
	High oil pressure drop
	Low oil pressure
Notes	Nominal cooling capacity and power input are based on 12/7°C entering/ leaving water temp. and 35°C air ambient temp. Power input ids for the whole unit.

1.3 Technical Specifications: EWAP-AJYNN/A

Technical specifications

The table below contains the technical specifications.

MODEL				EWAP850AJ YNN/A	EWAP900AJ NN/A	EWAP950AJ N/A	EWAP10AJ N/A	EWAP11AJ N/A	EWAP12AJ NN/A
Capacity (Eurovent conditions specified in notes)	Cooling	Nominal	kW	854	954	1028	1124	1196	1253
Capacity Steps			%	stepless 12.5-100	stepless 12.5-100	stepless 12.5-100	stepless 12.5-100	stepless 12.5-100	stepless 8.3-100
Nominal input (Eurovent conditions specified in notes)	Cooling		kW	319	354	386	424	458	476
EER				2.67	2.69	2.66	2.65	2.61	2.63
ESEER				3.20	3.24	3.21	3.21	3.17	3.24
Casing	Colour			RAL7032					
Dimensions	Unit	Height	mm	2520	2520	2520	2520	2520	2520
		Width	mm	8010	8910	8910	9810	9810	11870
		Depth	mm	2230	2230	2230	2230	2230	2230
Weight	Unit		kg	5900	6170	6290	6525	6645	9050
	Operating weight		kg	6185	6440	6560	6780	6900	9320
Water heat exchanger	Minimum water volume in the system (Formula)			The minimum water content per unit should be calculated with a certain approximation using this simplified formula: $Q=35.83 \times (P(kW) / \Delta T (^{\circ}C)) \times (1/N)$ where: Q= minimum water content per unit expressed in litres. P= minimum cooling capacity of the unit expressed in kW. ΔT = evaporator entering / leaving water temperature difference expressed in $^{\circ}C$ N= Number of compressors. For more accurate determination of quantity of water, it is advisable to contact the designer of the plant.					
Air heat exchanger	Type			Lanced fins - internally spiral wound tubes					
Water Heat Exchanger	Type			Shell and tube					
	Minimum water volume in the system		l	271	256	256	270	270	278
	Water flow rate	Min	l/min	1084	1351	1374	1169	1176	1560
		Nominal	l/min	2448	2735	2947	3222	3429	3592
Max		l/min	3428	4271	4345	3696	4934	4934	
Nominal water pressure drop	Cooling	Heat exchanger	kPa	51	41	46	76	85	53
Water Heat Exchanger	Model	Quantity		1	1	1	1	1	1
Fan	Type			Helical					
	Drive			Direct drive					
	Diameter		mm	800	800	800	800	800	800
	Nominal air flow		m ³ /min	5310	5640	5970	6300	6636	7962
	Model	Quantity		16	17	18	19	20	24
		Speed	rpm	860	860	860	860	860	860
		Motor Output	W	2000	2000	2000	2000	2000	2000
Discharge direction			Vertical						

Compressor	Type			Semi-hermetic single screw compressor					
	Refrigerant oil charge		l	28	28	28	28	28	28
	Model	Quantity		2	2	2	2	2	2
		Speed	rpm	2950	2950	2950	2950	2950	2950
Sound Level	Sound power	Cooling	dBA	102	102	103	103	103	104
	Sound Pressure	Cooling	dBA	80.5	80.5	81	81	81	81
	Sound Pressure + OPRN		dBA	75.0	75.0	75.5	76.0	76.5	76.5
	Sound Pressure +OPLN		dBA	72.5	72.5	72.5	72.5	72.5	73.0
Refrigerant circuit	Refrigerant type			R-407C					
	Refrigerant charge		kg	160	170	180	190	200	240
	No of circuits			2	2	2	2	2	3
	Refrigerant control			Electronic expansion valve					
Piping connections	Evaporator water inlet/outlet			Victaulic, diameter 219.1mm					
Safety Devices				High pressure (pressure switch)					
				Low pressure (pressure switch)					
				Condensation fan magneto-thermal					
				High discharge temperature on the compressor					
				Phase monitor					
				Star/delta transition failed					
				Low delta pressure between suction and discharge					
				Low pressure ratio					
				High oil pressure drop					
				Low oil pressure					
Notes				Nominal cooling capacity and power input are based on 12/7°C entering/ leaving water temp. and 35°C air ambient temp. Power input ids for the whole unit.					
				Unit C17 and C18 are longer than 14000 mm so beware of special transportation required.					

MODEL				EWAPC13AJ YNN/A	EWAPC14AJY NN/A	EWAPC15JYNN/ A	EWAPC16JYNN /A	EWAPC17JYNN/ A	EWAPC18JYNN N/A
Capacity (Eurovent conditions specified in notes)	Cooling	Nominal	kW	1357	1427	1497	1595	1644	1729
Capacity Steps			%	stepless 8.3-100					
Nominal input (Eurovent conditions specified in notes)	Cooling		kW	512	542	575	611	654	678
EER				2.65	2.63	2.60	2.61	2.51	2.55
ESEER				3.28	3.26	3.22	3.24	3.12	3.18
Casing	Colour			RAL7032					
Dimensions	Unit	Height	mm	2520	2520	2520	2520	2520	2520
		Width	mm	12770	12770	13670	13670	14570	14570
		Depth	mm	2230	2230	2230	2230	2230	2230
Weight	Unit		kg	9505	9625	10060	10075	10410	10470
	Operating weight		kg	9980	10100	10530	10520	10860	10920

1

Water heat exchanger	Minimum water volume in the system (Formula)		The minimum water content per unit should be calculated with a certain approximation using this simplified formula: $Q=35.83 \times (P(kW) / \Delta T (^{\circ}C)) \times (1/N)$ where: Q= minimum water content per unit expressed in litres. P= minimum cooling capacity of the unit expressed in kW. ΔT = evaporator entering / leaving water temperature difference expressed in $^{\circ}C$ N= Number of compressors. For more accurate determination of quantity of water, it is advisable to contact the designer of the plant.						
Air heat exchanger	Type		Lanced fins - internally spiral wound tubes						
Water Heat Exchanger	Type		Shell and tube						
	Minimum water volume in the system	l	432	432	432	419	419	419	
	Water flow rate	Min	l/min	1629	1643	1634	2346	2356	2390
		Nominal	l/min	3890	4091	4291	4572	4713	4957
Max		l/min	5153	5195	5166	7417	7452	7559	
Nominal water pressure drop	Cooling	Heat exchanger	kPa	57	62	69	38	40	43
				Model	Quantity	1	1	1	1
Fan	Type		Helical						
	Drive		Direct drive						
	Diameter	mm	800	800	800	800	800	800	
	Nominal air flow	m3/min	8292	8622	9468	9288	9618	9948	
	Model	Quantity		25	26	28	28	29	30
		Speed	rpm	860	860	860	860	860	860
		Motor Output	W	2000	2000	2000	2000	2000	2000
Discharge direction		Vertical							
Compressor	Type		Semi- hermetic single screw compressor						
	Refrigerant oil charge	l	28	28	28	28	28	28	
	Model	Quantity		3	3	3	3	3	3
		Speed	rpm	2950	2950	2950	2950	2950	2950
Sound Level	Sound power	Cooling	dBA	104	104	105	105	105	105
	Sound Pressure	Cooling	dBA	81.5	81.5	81.5	81.5	81.5	81.5
	Sound Pressure + OPRN		dBA	76.0	76.0	76.5	76.5	77.0	77.0
	Sound Pressure +OPLN		dBA	66.5	67.0	67.5	67.5	67.5	67.5
Refrigerant circuit	Refrigerant type		R-407C						
	Refrigerant charge	kg	250	260	270	280	290	300	
	No of circuits		3	3	3	3	3	3	
	Refrigerant control		Electronic expansion valve						
Piping connections	Evaporator water inlet/outlet		Victaulic, diameter 273mm						

Safety Devices	High pressure (pressure switch)
	Low pressure (pressure switch)
	Condensation fan magneto-thermal
	High discharge temperature on the compressor
	Phase monitor
	Star/delta transition failed
	Low delta pressure between suction and discharge
	Low pressure ratio
	High oil pressure drop
	Low oil pressure
Notes	Nominal cooling capacity and power input are based on 12/7°C entering/ leaving water temp. and 35°C air ambient temp. Power input is for the whole unit.
	Unit C17 and C18 are longer than 14000 mm so beware of special transportation required.

1

1.4 Electrical Specifications: EWAP-AJYNN

Electrical specifications

The table below contains the electrical specifications.

MODEL			EWAP800AJY NN	EWAP900AJY NN	EWAP950AJY N	EWAPC10AJY N	EWAPC11AJY N	EWAPC12AJY NN	
Power supply	Name		YN						
	Phase		3	3	3	3	3	3	
	Frequency	Hz	50	50	50	50	50	50	
	Voltage		V	400	400	400	400	400	400
	Voltage Tolerance	Minimum	%	-10%					
		Maximum	%	+10%					
Unit	Starting current		A	1050	1054	1116	1120	1165	1265
	Nominal Running Current Cooling		A	517	561	673	729	780	796
	Maximum Running Current		A	647	703	767	833	896	963
	Max unit current for wires sizing		A	668	728	788	848	908	1002
Fan	Phase		3	3	3	3	3	3	
	Voltage		V	400	400	400	400	400	400
	Nominal Running Current Cooling		A	48	52	56	60	64	72
Compressor	Phase		3	3	3	3	3	3	
	Voltage		V	400	400	400	400	400	400
	Voltage Tolerance	Minimum	%	-10%					
		Maximum	%	+10%					
	Maximum Running Current		A	599	651	711	773	832	891
	Starting method		Star-delta						
Notes			Allowed voltage tolerance +- 10%. Voltage unbalance between phases must be within +- 3%						
			Max unit starting current: Starting current of biggest compressor + 75% of nominal absorbed current of the other compressor + fans current.						
			Max unit current for wires sizing: compressor FLA (Full Load Ampere) + fans current.						

MODEL			EWAPC13AJ YNN	EWAPC14AJ NN	EWAPC15AJY N	EWAPC16AJY N	EWAPC17AJY N	EWAPC18AJY NN	
Power supply	Name		YN						
	Phase		3	3	3	3	3	3	
	Frequency	Hz	50	50	50	50	50	50	
	Voltage		V	400	400	400	400	400	400
	Voltage Tolerance	Minimum	%	-10%					
		Maximum	%	+10%					

Unit	Starting current		A	1248	1344	1402	1405	1489	1491
	Nominal Running Current Cooling		A	823	864	1012	1070	1122	1173
	Maximum Running Current		A	1026	1082	1152	1222	1285	1347
	Max unit current for wires sizing		A	1062	1122	1186	1242	1302	1362
Fan	Phase			3	3	3	3	3	3
	Voltage		V	400	400	400	400	400	400
	Nominal Running Current Cooling		A	76	80	88	88	92	96
Compressor	Phase			3	3	3	3	3	3
	Voltage		V	400	400	400	400	400	400
	Voltage Tolerance	Minimum	%	-10%					
		Maximum	%	+10%					
	Maximum Running Current		A	950	1002	1064	1134	1193	1251
	Starting method			Star-delta					
Notes				Allowed voltage tolerance +- 10%. Voltage unbalance between phases must be within +- 3%					
				Max unit starting current: Starting current of biggest compressor + 75% of nominal absorbed current of the other compressor + fans current.					
				Max unit current for wires sizing: compressor FLA (Full Load Ampere) + fans current.					

1.5 Electrical Specifications: EWAP-AJYNN/A

Electrical specifications

The table below contains the electrical specifications.

MODEL			EWAP850AJ YNN/A	EWAP900AJY NN/A	EWAP950AJYN N/A	EWAPC10AJYN N/A	EWAPC11AJYN N/A	EWAPC12AJY NN/A	
Power supply	Name		YN						
	Phase		3	3	3	3	3	3	
	Frequency	Hz	50	50	50	50	50	50	
	Voltage	V	400	400	400	400	400	400	
	Voltage Tolerance	Minimum	%	-10%					
Maximum		%	+10%						
Unit	Starting current		A	1051	1055	1125	1129	1172	1259
	Nominal Running Current Cooling		A	477	523	652	707	757	710
	Maximum Running Current		A	660	723	782	853	920	984
	Max unit current for wires sizing		A	684	744	804	864	924	1026
Fan	Phase		3	3	3	3	3	3	
	Voltage	V	400	400	400	400	400	400	
	Nominal Running Current Cooling		A	64	68	72	76	80	96
Compressor	Phase		3	3	3	3	3	3	
	Voltage	V	400	400	400	400	400	400	
	Voltage Tolerance	Minimum	%	-10%					
		Maximum	%	+10%					
	Maximum Running Current		A	596	655	710	777	840	888
Starting method		Star-delta							
Notes			Allowed voltage tolerance +- 10%. Voltage unbalance between phases must be within +- 3%						
			Max unit starting current: Starting current of biggest compressor + 75% of nominal absorbed current of the other compressor + fans current.						
			Max unit current for wires sizing: compressor FLA (Full Load Ampere) + fans current.						

MODEL			EWAPC13AJ YNN/A	EWAPC14AJY NN/A	EWAPC15AJYN N/A	EWAPC16AJY NN/A	EWAPC17AJY NN/A	EWAPC18AJY NN/A	
Power supply	Name		YN						
	Phase		3	3	3	3	3	3	
	Frequency	Hz	50	50	50	50	50	50	
	Voltage	V	400	400	400	400	400	400	
	Voltage Tolerance	Minimum	%	-10%					
Maximum		%	+10%						
Unit	Starting current		A	1232	1332	1406	1407	1486	1489
	Nominal Running Current Cooling		A	756	796	972	1023	1078	1121
	Maximum Running Current		A	1048	1106	1168	1235	1296	1365
	Max unit current for wires sizing		A	1086	1146	1210	1266	1322	1386

Fan	Phase		3	3	3	3	3	3	
	Voltage		V	400	400	400	400	400	
	Nominal Running Current Cooling		A	100	104	112	112	120	
Compressor	Phase		3	3	3	3	3	3	
	Voltage		V	400	400	400	400	400	
	Voltage Tolerance	Minimum	%	-10%					
		Maximum	%	+10%					
	Maximum Running Current		A	948	1002	1056	1123	1184	1245
	Starting method		Star-delta						
Notes			Allowed voltage tolerance +- 10%. Voltage unbalance between phases must be within +- 3%.						
			Max unit starting current: Starting current of biggest compressor + 75% of nominal absorbed current of the other compressor + fans current.						
			Max unit current for wires sizing: compressor FLA (Full Load Ampere) + fans current.						

1

1.6 Outlook Drawing: EWAP-AJYNN

EWAP800AJYNN

The illustration below shows the outlook, the dimensions and the installation and service space of the unit (mm).

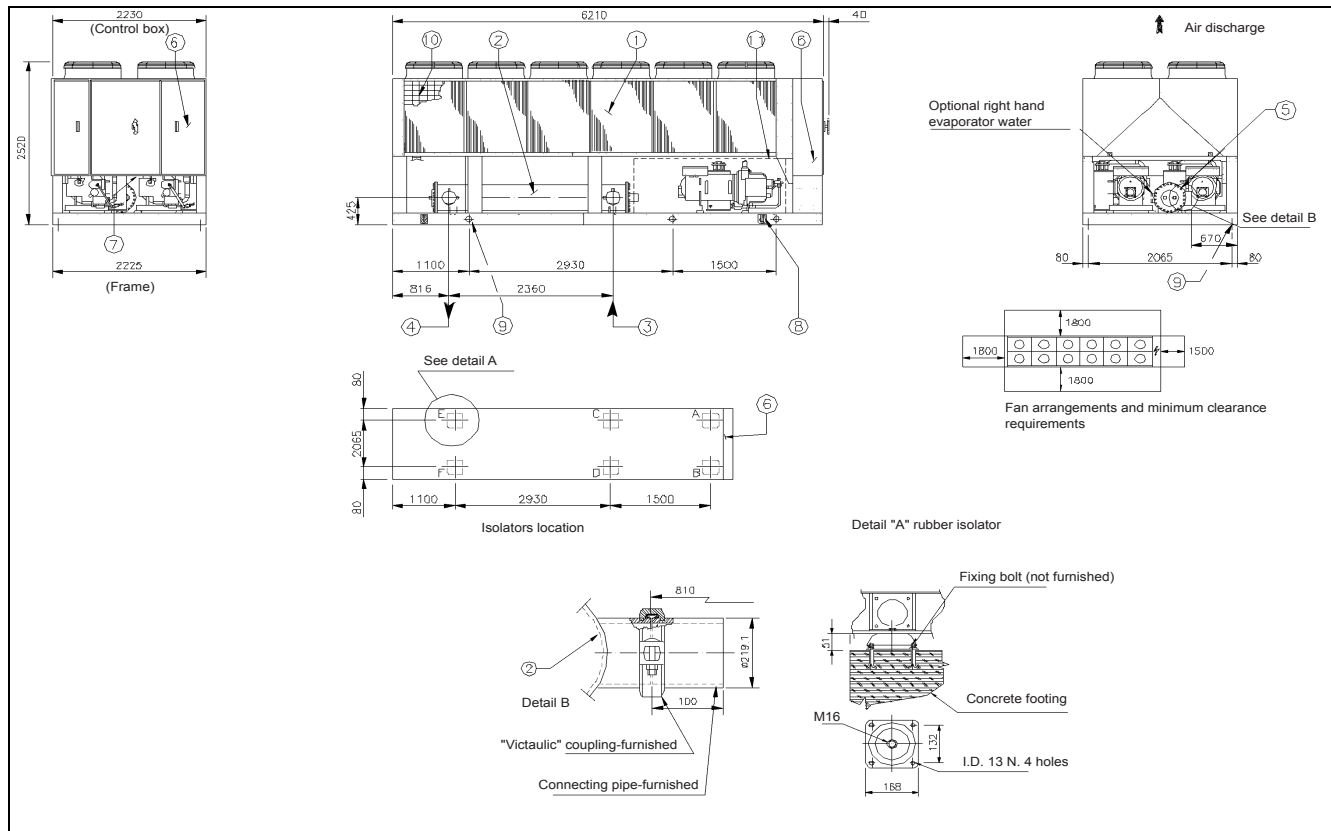

Components

The table below lists the components.

No.	Component
1	Condenser coil
2	Evaporator
3	Evaporator water inlet
4	Evaporator water outlet
5	Victaulic connections for 219.1 O.D. tube
6	Operating and control panel
7	360x150 slot for power and control panel connection
8	4 lifting shackles
9	6 isolator mounting holes 25 mm DIA
10	Coil protection guards (optional)
11	Compressors enclosure (optional)

Version	Condenser type	Weight KG		Isolators load KG					
		Shipping	Operating	A	B	C	D	E	F
EWAP800AJYNN+ OPRN	Aluminium	5365	5630	1080	1165	870	935	760	820
EWAP800AJYNN	Acrylic coated								
EWAP800AJYNN+ OPLN	Aluminium	5805	5870	1140	1225	930	995	760	820
	Acrylic coated								
EWAP800AJYNN EWAP800AJYNN+ OPLN EWAP800AJYNN+ OPRN	Rubber isolators	Type (q/ty)		786011-h (6Pz.)					

EWAP900AJYNN

The illustration below shows the outlook, the dimensions and the installation and service space of the unit (mm).

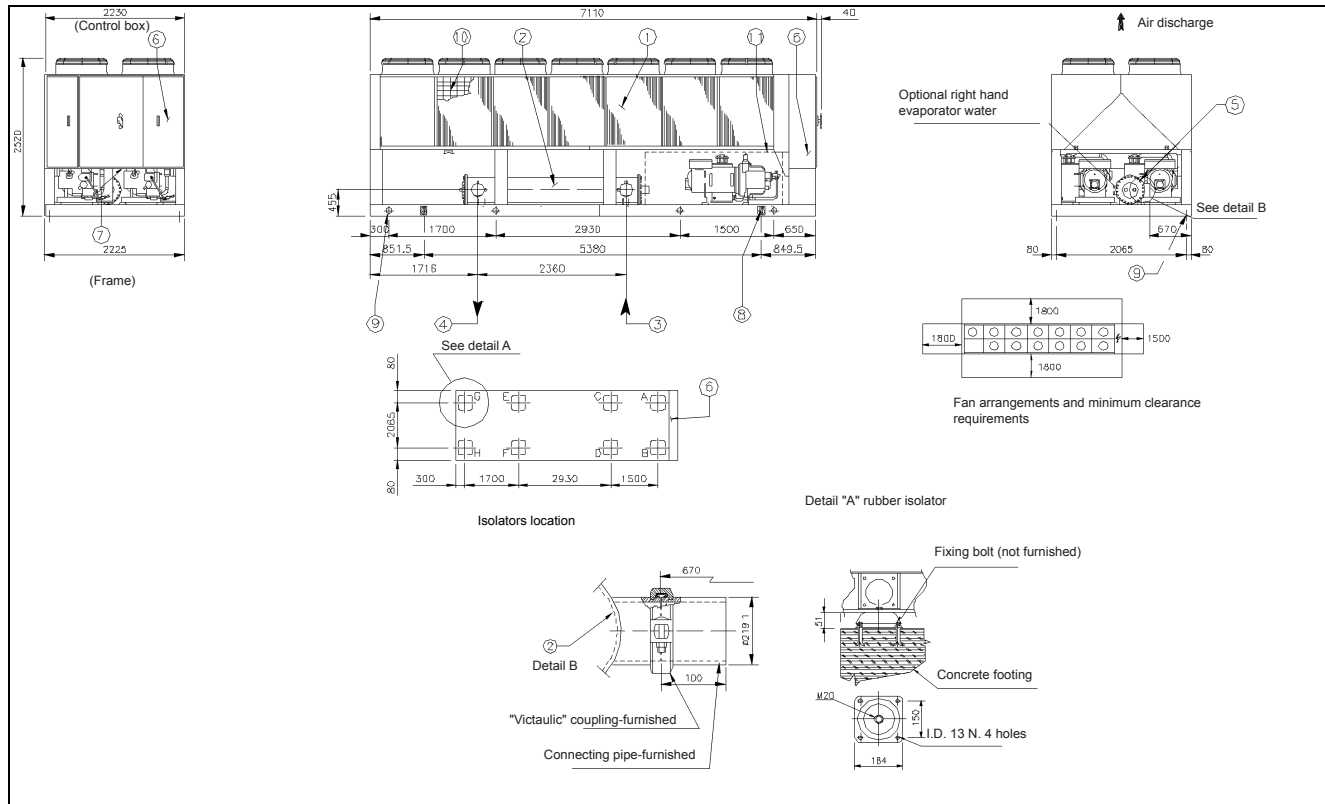

Components

The table below lists the components.

No.	Component
1	Condenser coil
2	Evaporator
3	Evaporator water inlet
4	Evaporator water outlet
5	Victaulic connections for 219.1 O.D. tube
6	Operating and control panel
7	360x150 slot for power and control panel connection
8	4 lifting shackles
9	8 isolator mounting holes 25 mm DIA
10	Coil protection guards (optional)
11	Compressors enclosure (optional)

Version	Condenser type	Weight KG		Isolators load KG							
		Shipping	Operating	A	B	C	D	E	F	G	H
EWAP900AJYNN	Aluminium	5625	5910	1020	1115	840	915	675	695	330	320
EWAP900AJYNN+OPRN	Acrylic coated										
EWAP900AJYNN+OPLN	Aluminium	5885	6150	1080	1175	900	975	675	895	330	320
	Acrylic coated										
EWAP900AJYNN EWAP900AJYNN+OPRN EWAP900AJYNN+OPLN	Rubber isolators	Type (q/ty)		786010-m (4Pz.)				786010-w (4Pz.)			

EWAP950AJYNN

The illustration below shows the outlook, the dimensions and the installation and service space of the unit (mm).

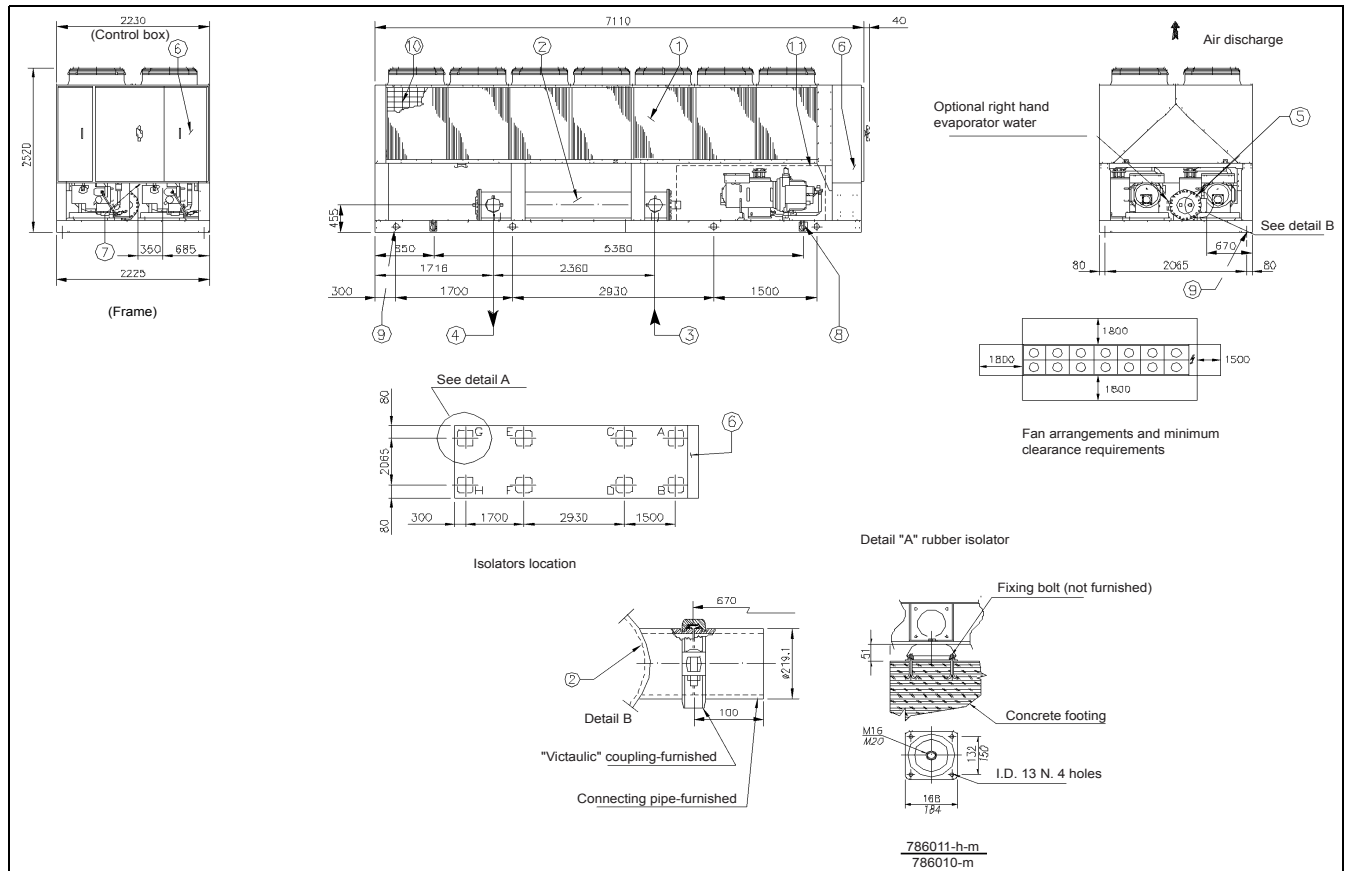

Components

The table below lists the components.

No.	Component
1	Condenser coil
2	Evaporator
3	Evaporator water inlet
4	Evaporator water outlet
5	Victaulic connections for 219.1 O.D. tube
6	Operating and control panel
7	360x150 slot for power and control panel connection
8	4 lifting shackles
9	8 isolator mounting holes 25 mm DIA.
10	Coil protection guards (optional)
11	Compressor enclosure (optional)

Version	Condenser type	Weight KG		Isolators load KG							
		Shipping	Operating	A	B	C	D	E	F	G	H
EWAP950AJYNN	Aluminium	5755	6040	1020	1115	840	915	690	745	345	370
EWAP950AJYNN+OPRN	Acrylic coated										
EWAP950AJYNN+OPLN	Aluminium	5995	6280	1080	1175	900	975	690	745	345	370
	Acrylic coated										
EWAP950AJYNN EWAP950AJYNN+OPRN EWAP950AJYNN+OPLN	Rubber isolators	Type (q/ty)		786010-m (2Pz.)		786011-h (4Pz.)				786011-m (2Pz.)	

EWAPC10AJYNN

The illustration below shows the outlook, the dimensions and the installation and service space of the unit (mm).

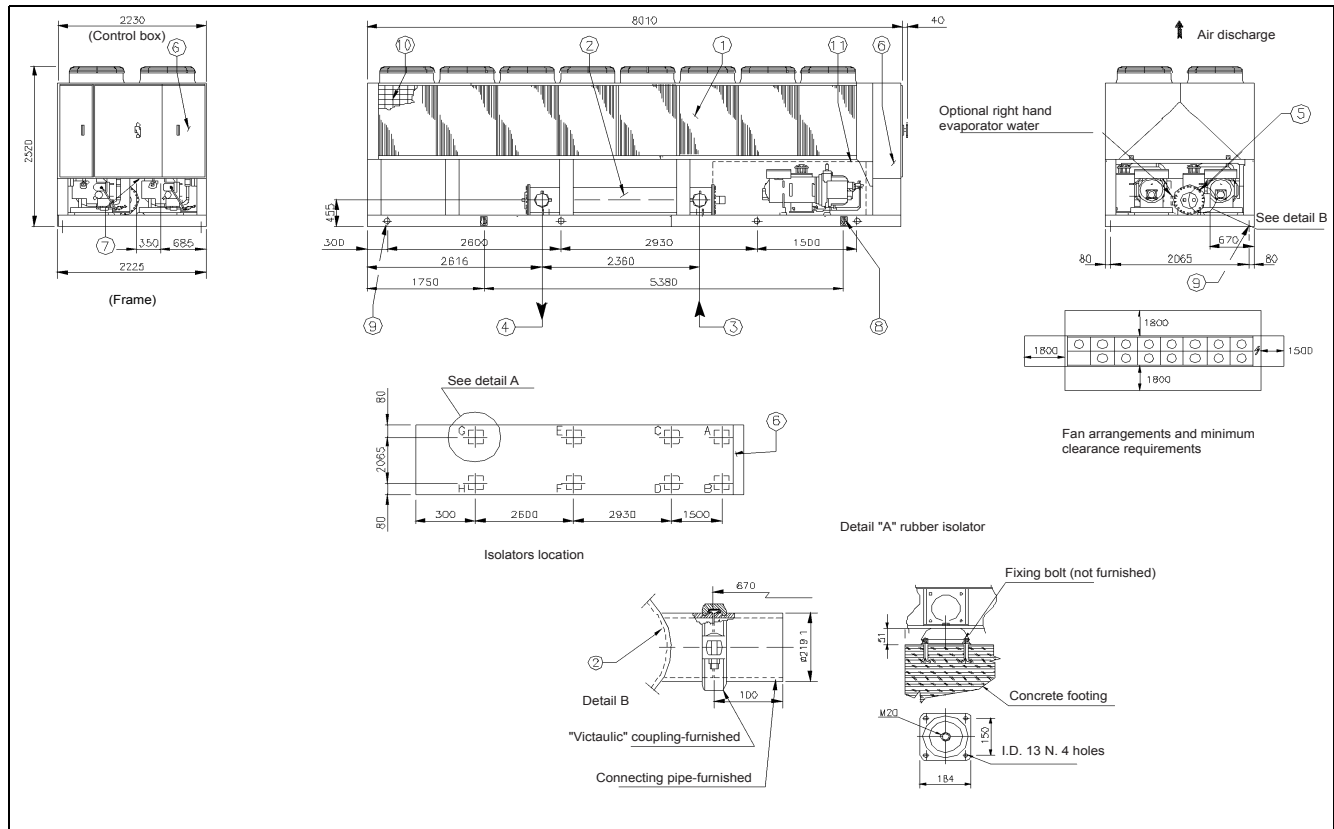

Components

The table below lists the components.

No.	Component
1	Condenser coil
2	Evaporator
3	Evaporator water inlet
4	Evaporator water outlet
5	Victaulic connections for 219.1 O.D. tube
6	Operating and control panel
7	360x150 slot for power and control panel connection
8	4 lifting shackles
9	8 isolator mounting holes 25 mm DIA
10	Coil protection guards (optional)
11	Compressors enclosure (optional)

Version	Condenser type	Weight KG		Isolators load KG							
		Shipping	Operating	A	B	C	D	E	F	G	H
EWAPC10AJYNN	Aluminium	5995	6270	1065	1150	875	950	735	750	380	365
EWAPC10AJYNN +OPRN	Acrylic coated										
EWAPC10AJYNN +OPLN	Aluminium	6235	6510	1125	1210	935	1010	735	750	380	365
	Acrylic coated										
EWAPC10AJYNN EWAPC10AJYNN +OPRN EWAPC10AJYNN +OPLN	Rubber isolators	Type (q/ty)		786010-m (4Pz.)				786010-w (4Pz.)			

EWAPC11AJYNN

The illustration below shows the outlook, the dimensions and the installation and service space of the unit (mm).

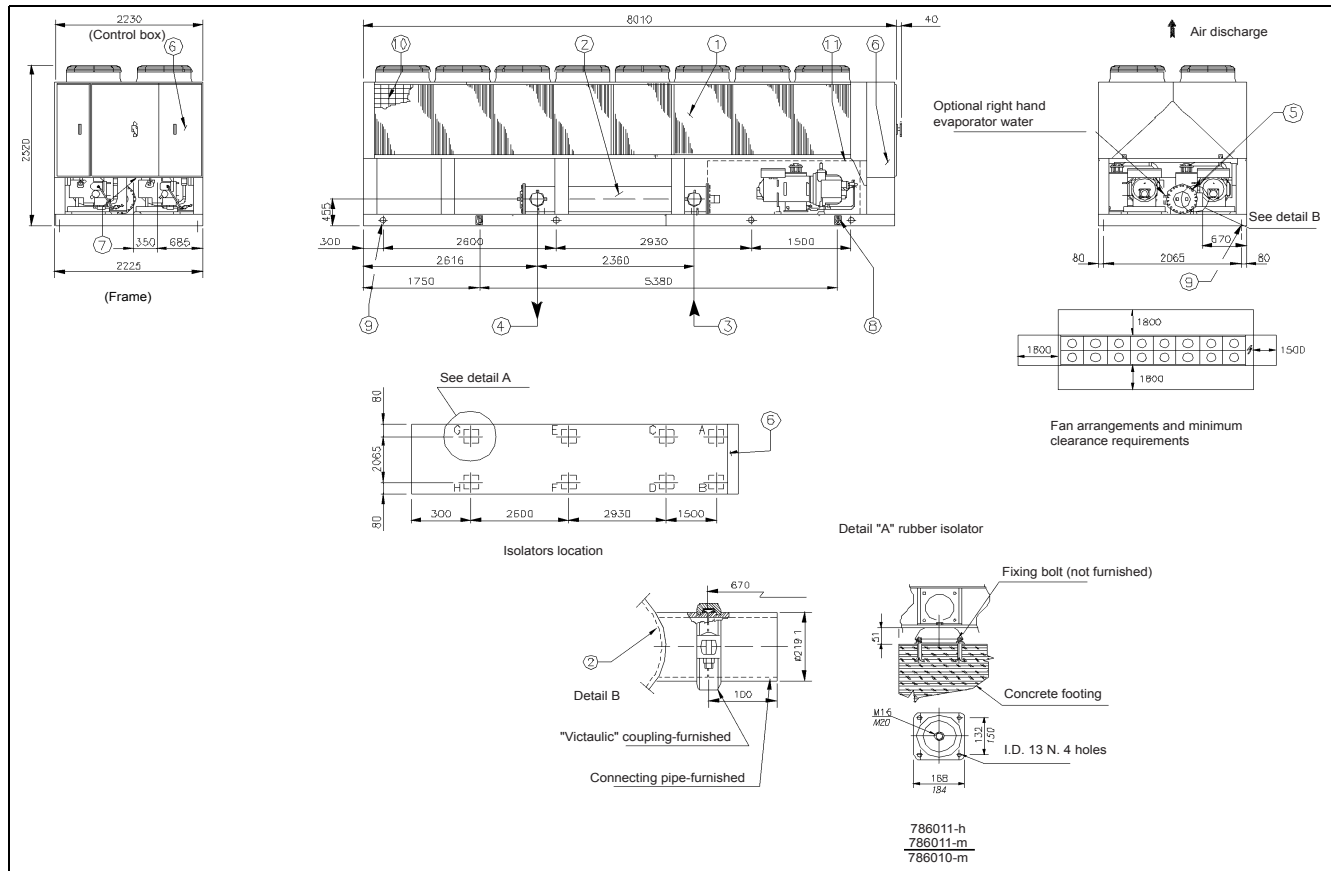

Components

The table below lists the components.

No.	Component
1	Condenser coil
2	Evaporator
3	Evaporator water inlet
4	Evaporator water outlet
5	Victaulic connections for 219.1 O.D. tube
6	Operating and control panel
7	360x150 slot for power and control panel connection
8	4 lifting shackles
9	8 isolator mounting holes 25 mm DIA
10	Coil protection guards (optional)
11	Compressor enclosure (optional)

Version	Condenser type	Weight KG		Isolators load KG							
		Shipping	Operating	A	B	C	D	E	F	G	H
EWAPC11AJYNN	Aluminium	6105	6380	1065	1150	875	950	740	800	385	415
EWAPC11AJYNN +OPRN	Acrylic coated										
EWAPC11AJYNN +OPLN	Aluminium	6345	6820	1125	1210	935	1010	740	800	385	415
	Acrylic coated										
EWAPC11AJYNN +OPRN EWAPC11AJYNN +OPLN	Rubber isolators	Type (q/ty)		786010-m (2Pz.)		786011-h (4Pz.)				786011-m (2Pz.)	

1

EWAPC12AJYNN

The illustration below shows the outlook, the dimensions and the installation and service space of the unit (mm).

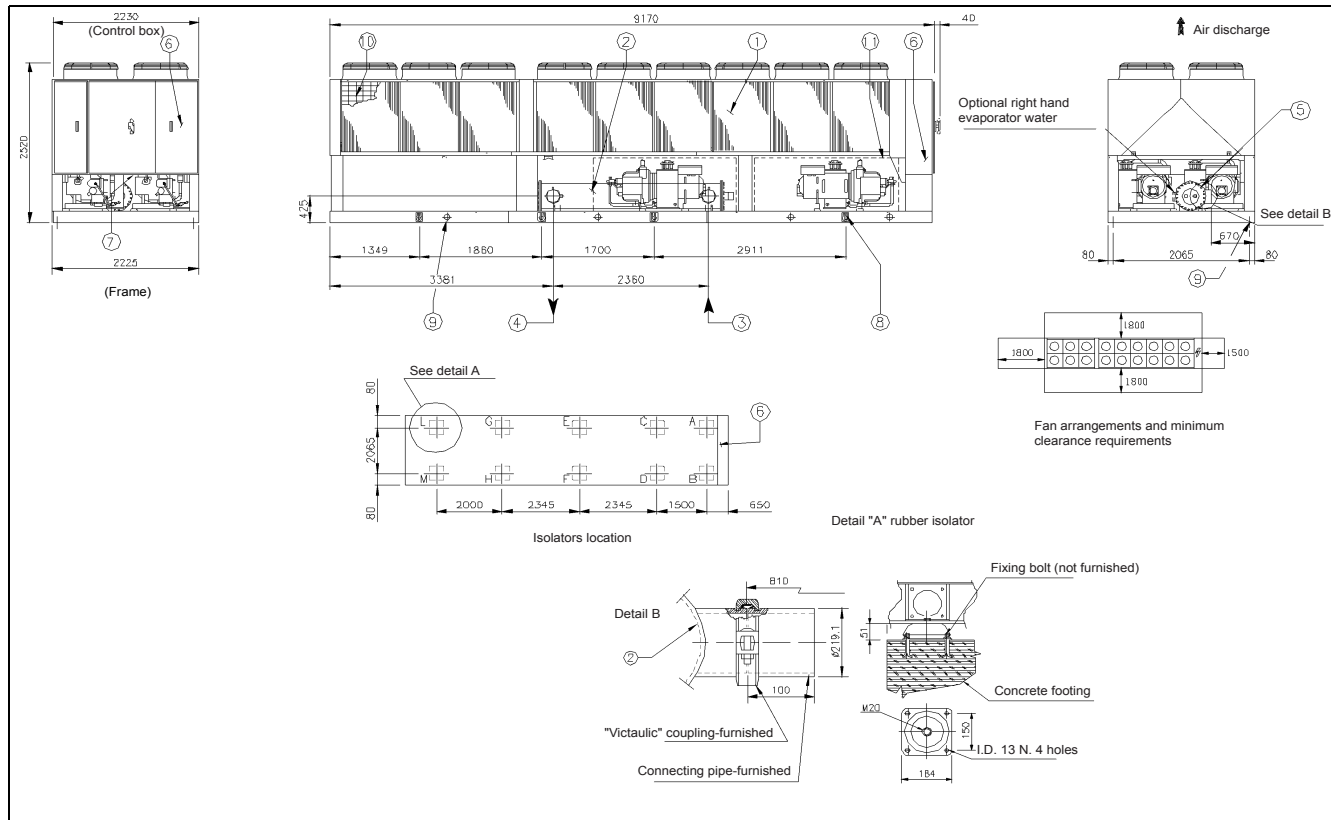

Components

The table below lists the components.

No.	Component
1	Condenser coil
2	Evaporator
3	Evaporator water inlet
4	Evaporator water outlet
5	Victaulic connections for 219.1 O.D. tube
6	Operating and control panel
7	360x150 slot for power and control panel connection
8	8 lifting shackles
9	10 isolator mounting holes 25 mm DIA
10	Coil protection guards (optional)
11	Compressors enclosure (optional)

Version	Condenser type	Weight KG		Isolators load KG									
		Ship- ping	Oper- ating	A	B	C	D	E	F	G	H	L	M
EWAPC12AJ YNN	Aluminium	8010	8290	1200	1200	965	965	1130	1130	370	370	480	480
EWAPC12AJ YNN+OPRN	Acrylic coated												
EWAPC12AJ YNN+OPLN	Aluminium	8370	8650	1260	1260	1045	1045	1170	1170	370	370	480	480
	Acrylic coated												
EWAPC12AJ YNN	Rubber isolators	Type (q/ty)		786010-m (6Pz.)					786010-w (4Pz.)				
EWAPC12AJ YNN+OPRN													
EWAPC12AJ YNN+OPLN													

1

EWAPC13AJYNN

The illustration below shows the outlook, the dimensions and the installation and service space of the unit (mm).

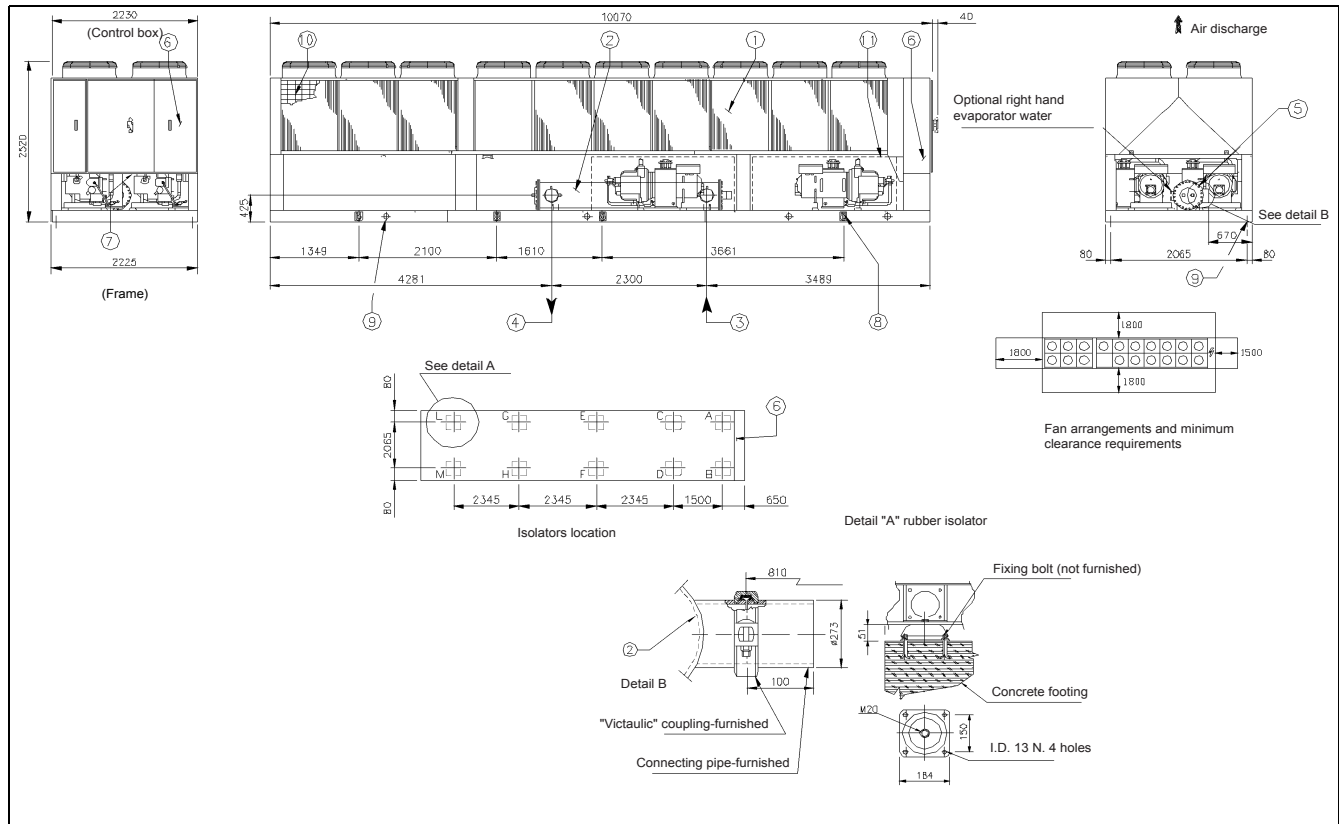

Components

The table below lists the components

No.	Component
1	Condenser coil
2	Evaporator
3	Evaporator water inlet
4	Evaporator water outlet
5	Victaulic connections for 219.1 O.D. tube
6	Operating and control panel
7	360x150 slot for power and control panel connection
8	8 lifting shackles
9	10 isolator mounting holes 25 mm DIA
10	Coil protection guards (optional)
11	Compressors enclosure (optional)

Version	Condenser type	Weight KG		Isolators load KG									
		Ship- ping	Oper- ating	A	B	C	D	E	F	G	H	L	M
EWAPC13AJ YNN	Aluminium	8610	9080	1265	1265	1015	1015	1215	1215	475	475	570	570
	Acrylic coated												
EWAPC13AJ YNN+OPRN	Aluminium	8970	9440	1325	1325	1095	1095	1255	1255	475	475	570	570
	Acrylic coated												
EWAPC13AJ YNN	Rubber isolators	Type (q/ty)	786010-m (6Pz.)	786010-w (4Pz.)									
EWAPC13AJ YNN+OPRN													
EWAPC13AJ YNN+OPLN													

EWAPC14AJYNN

The illustration below shows the outlook, the dimensions and the installation and service space of the unit (mm).

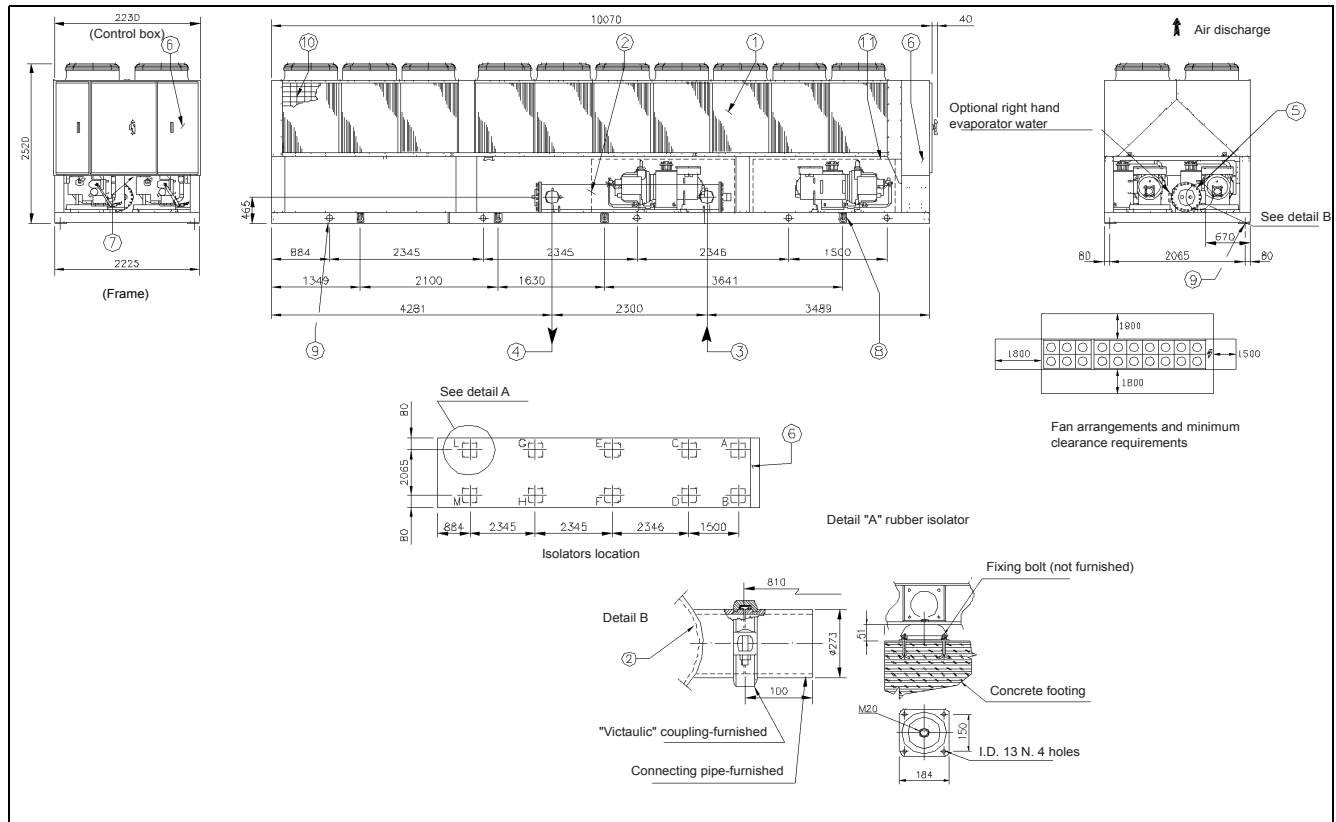

Components

The table below lists the components.

No.	Component
1	Condenser coil
2	Evaporator
3	Evaporator water inlet
4	Evaporator water outlet
5	Victaulic connections for 219.1 O.D. tube
6	Operating and control panel
7	360x150 slot for power and control panel connection
8	8 lifting shackles
9	10 isolator mounting holes 25 mm DIA
10	Coil protection guards (optional)
11	Compressors enclosure (optional)

Version	Condenser type	Weight KG		Isolators load KG									
		Ship-ping	Oper-ating	A	B	C	D	E	F	G	H	L	M
EWAPC14AJ YNN	Aluminium	8740	9210	1265	1265	1015	1015	1215	1215	525	525	585	585
EWAPC14AJ YNN+OPRN	Acrylic coated												
EWAPC14AJ YNN+OPLN	Aluminium	9100	9570	1325	1325	1095	1095	1255	1255	525	525	585	585
	Acrylic coated												
EWAPC14AJ YNN	Rubber isola-tors	Type (q/ty)		786010-m (6Pz.)				786010-w (4Pz.)					
EWAPC14AJ YNN+OPRN													
EWAPC14AJ YNN+OPLN													

EWAPC15-16AJYN
N

The illustration below shows the outlook, the dimensions and the installation and service space of the unit (mm).

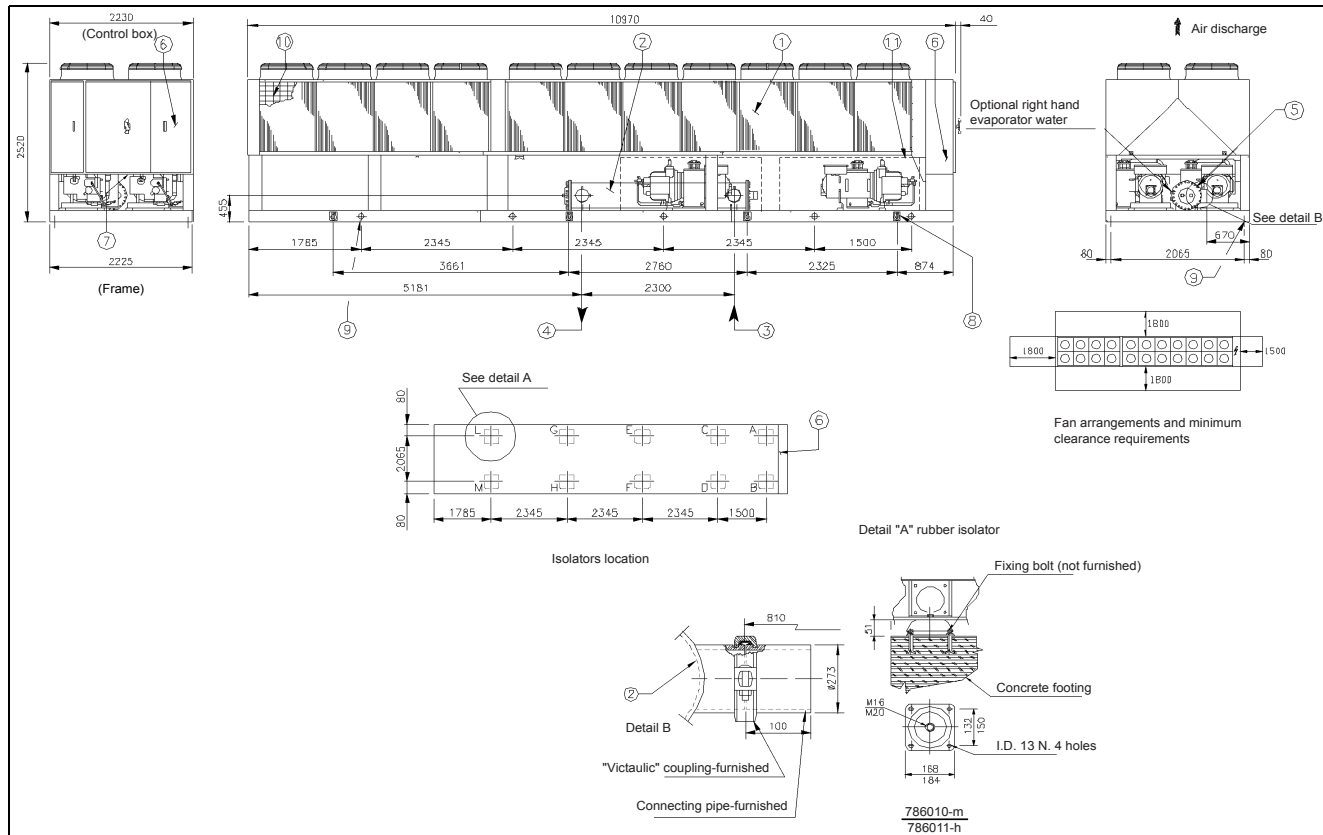

Components

The table below lists the components.

No.	Component
1	Condenser coil
2	Evaporator
3	Evaporator water inlet
4	Evaporator water outlet
5	Victaulic connections for 219.1 O.D. tube
6	Operating and control panel
7	360x150 slot for power and control panel connection
8	8 lifting shackles
9	10 isolator mounting holes 25 mm DIA
10	Coil protection guards (optional)
11	Compressors enclosure (optional)

Version	Condenser type	Weight KG		Isolators load KG									
		Ship-ping	Oper-ating	A	B	C	D	E	F	G	H	L	M
EWAPC15-16A JYNN	Aluminium	9205	9650	1220	1220	985	985	1195	1195	530	530	895	895
	Acrylic coated												
EWAPC15-16A JYNN+OPRN	Aluminium	9565	10010	1280	1280	1065	1065	1235	1235	530	530	895	895
	Acrylic coated												
EWAPC15-16A JYNN	Rubber iso-lators	Type (q/ty)		786010-m (6Pz.)				786011-h (4Pz.)					
EWAPC15-16A JYNN+OPRN													
EWAPC15-16A JYNN+OPLN													

EWAPC17AJYNN

The illustration below shows the outlook, the dimensions and the installation and service space of the unit (mm).

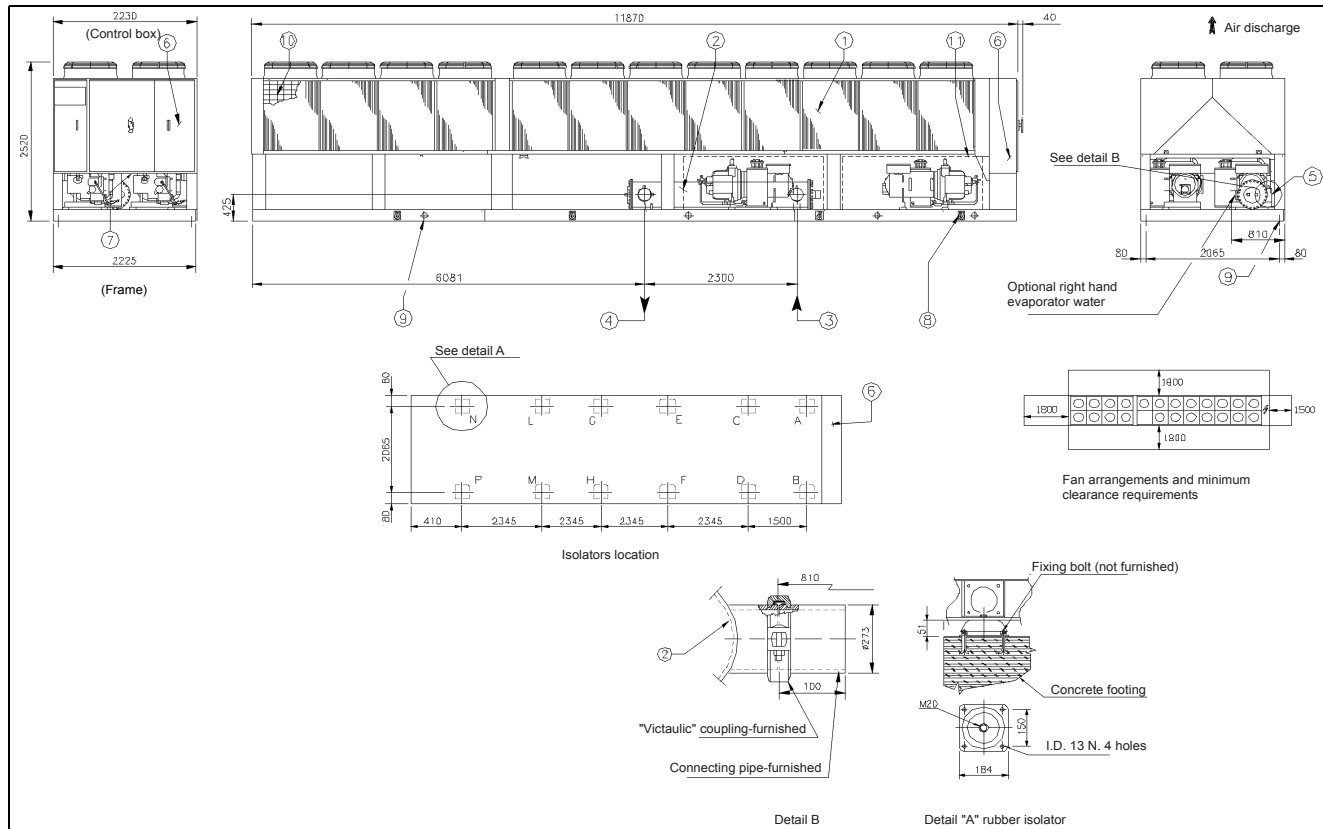

Components

The table below lists the components.

No.	Component
1	Condenser coil
2	Evaporator
3	Evaporator water inlet
4	Evaporator water outlet
5	Victaulic connections for 219.1 O.D. tube
6	Operating and control panel
7	360x150 slot for power and control panel connection
8	8 lifting shackles
9	12 isolator mounting holes 25 mm DIA
10	Coil protection guards (optional)
11	Compressors enclosure (optional)

Version	Con- denser type	Weight KG		Isolators load KG											
		Ship- ping	Oper- ating	A	B	C	D	E	F	G	H	L	M	N	P
EWAPC1 7AJYNN	Alumin- ium	9455	9900	1165	1165	955	955	1300	13 00	485	485	495	49 5	550	55 0
EWAPC1 7AJYNN+ OPRN	Acrylic coated														
EWAPC1 7AJYNN+ OPLN	Alumin- ium	9815	10260	1225	1225	103 5	1035	1340	13 40	485	485	495	49 5	550	55 0
	Acrylic coated														
EWAPC1 7AJYNN EWAPC1 7AJYNN+ OPRN EWAPC1 7AJYNN+ OPLN	Rubber isolators	Type (q/ty)		786010-m (6Pz.)						786010-w (6Pz.)					

EWAPC18AJYNN

The illustration below shows the outlook, the dimensions and the installation and service space of the unit (mm).

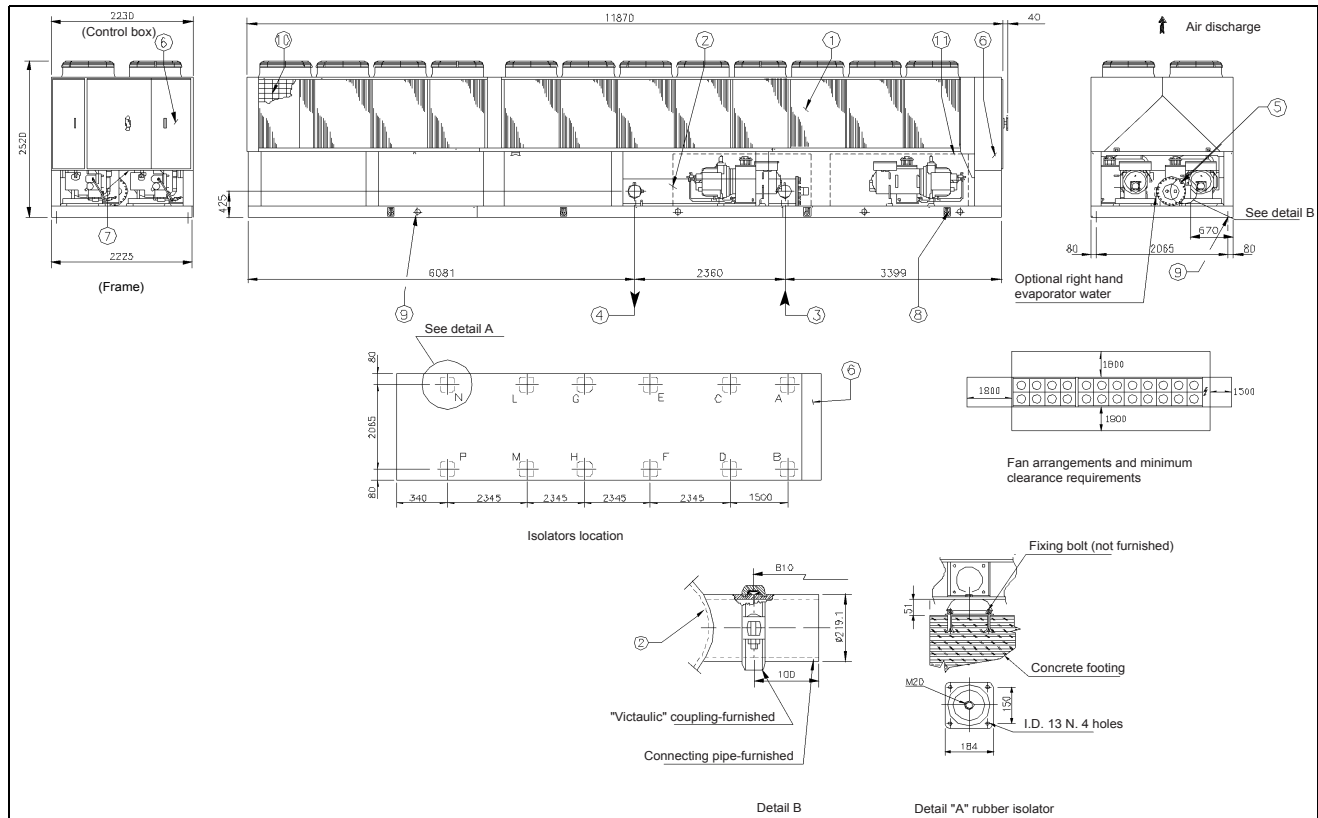

Components

The table below lists the components.

No.	Component
1	Condenser coil
2	Evaporator
3	Evaporator water inlet
4	Evaporator water outlet
5	Victaulic connections for 219.1 O.D. tube
6	Operating and control panel
7	360x150 slot for power and control panel connection
8	8 lifting shackles
9	12 isolator mounting holes 25 mm DIA
10	Coil protection guards (optional)
11	Compressors enclosure (optional)

Version	Con- denser type	Weight KG		Isolators load KG											
		Ship- ping	Operat- ing	A	B	C	D	E	F	G	H	L	M	N	P
EWAPC18AJ YNN	Aluminium	9565	10010	116	116	955	95	130	13	52	525	510	51	550	55
EWAPC18AJ YNN+OPRN	Acrylic coated			5	5		5	0	00	5			0		
EWAPC18AJ YNN+OPLN	Aluminium	9925	10370	122	122	103	10	134	13	52	525	510	51	550	55
	Acrylic coated			5	5	5	35	0	40	5			0		
EWAPC18AJ YNN EWAPC18AJ YNN+OPRN EWAPC18AJ YNN+OPLN	Rubber isolators	Type (q/ty)		786010-m (6Pz.)						786010-w (6Pz.)					

1

1.7 Outlook Drawing: EWAP-AJYNN/A

EWAP850AJYNN/A

The illustration below shows the outlook, the dimensions and the installation and service space of the unit (mm).

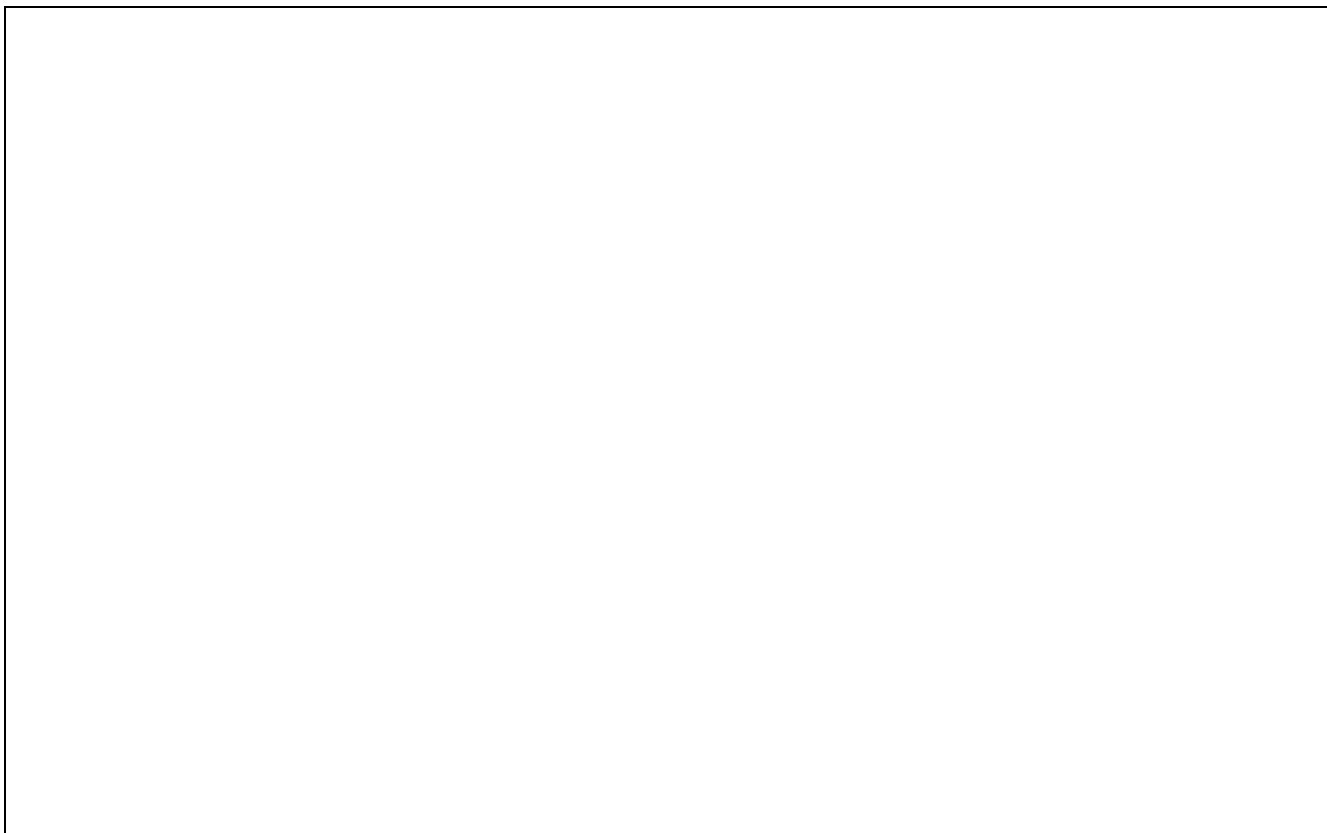

Components

The table below lists the components.

No.	Component
1	Condenser coil
2	Evaporator
3	Evaporator water inlet
4	Evaporator water outlet
5	Victaulic connections for 219.1 O.D. tube
6	Operating and control panel
7	360x150 slot for power and control panel connection
8	8 lifting shackles
9	8 isolator mounting holes 25 mm DIA
10	Coil protection guards (optional)
11	Compressors enclosure (optional)

Version	Condenser type	Weight KG		Isolators load KG							
		Shipping	Operating	A	B	C	D	E	F	G	H
EWAP850AJYNN/A	Aluminium	5625	5910	1020	1115	840	915	675	695	330	320
EWAP850AJYNN/A +OPRN	Acrylic coated										
EWAP850AJYNN/A +OPLN	Aluminium	5885	6150	1080	1175	900	975	675	895	330	320
	Acrylic coated										
EWAP850AJYNN/A EWAP850AJYNN/A +OPRN EWAP850AJYNN/A +OPLN	Rubber isolators	Type (q/ty)		786010-m (4Pz.)				786010-w (4Pz.)			

EWAP900AJYNN/A

The illustration below shows the outlook, the dimensions and the installation and service space of the unit (mm).

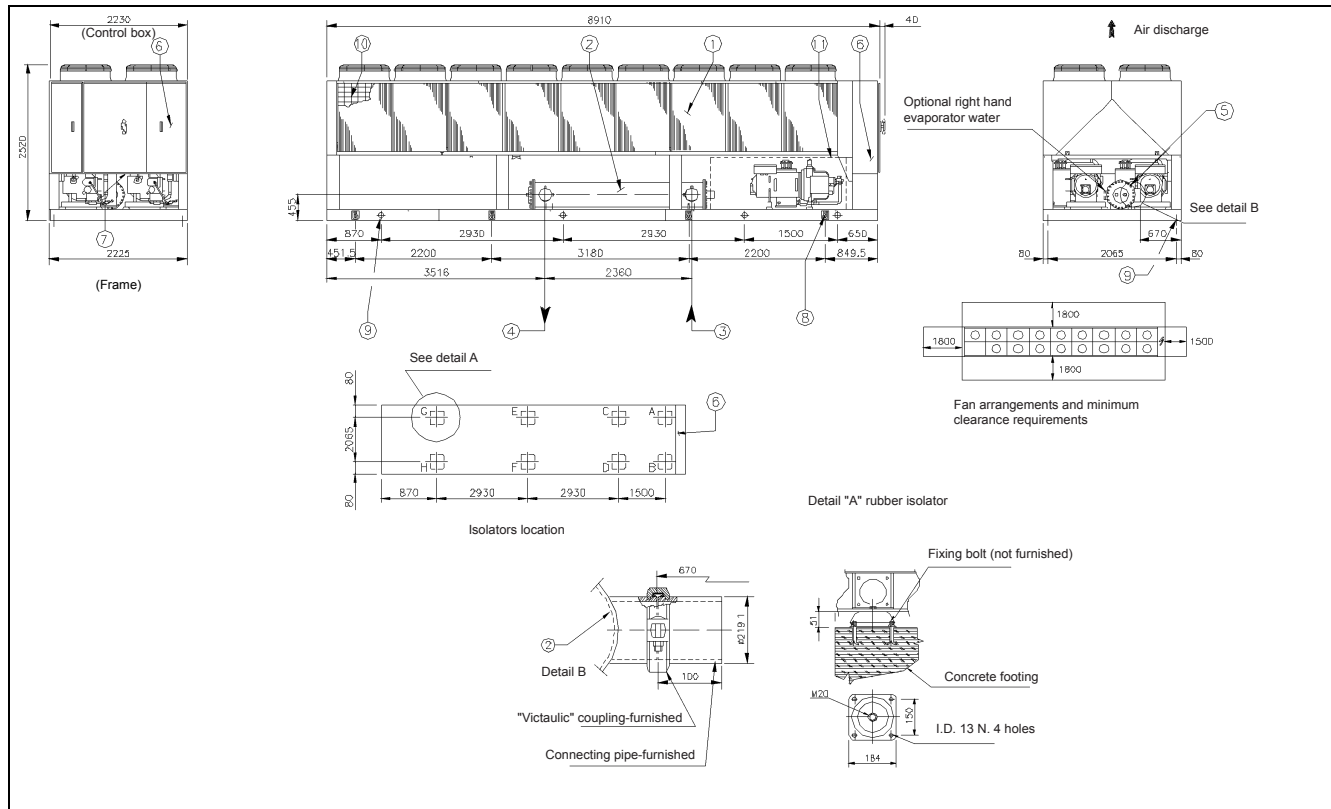

Components

The table below lists the components.

No.	Component
1	Condenser coil
2	Evaporator
3	Evaporator water inlet
4	Evaporator water outlet
5	Victaulic connections for 219.1 O.D. tube
6	Operating and control panel
7	360x150 slot for power and control panel connection
8	8 lifting shackles
9	8 isolator mounting holes 25 mm DIA
10	Coil protection guards (optional)
11	Compressors enclosure (optional)

Version	Condenser type	Weight KG		Isolators load KG							
		Shipping	Operating	A	B	C	D	E	F	G	H
EWAP900AJYNN/A	Aluminium	6370	6640	1115	1195	900	970	675	685	550	550
EWAP900AJYNN/A +OPRN	Acrylic coated										
EWAP900AJYNN/A	Aluminium	6610	6880	1175	1255	960	1030	675	685	550	550
EWAP900AJYNN/A +OPLN	Acrylic coated										
EWAP900AJYNN/A EWAP900AJYNN/A +OPRN EWAP900AJYNN/A +OPLN	Rubber isolators	Type (q/ty)		786010-m (4Pz.)				786010-w (4Pz.)			

1

EWAP950AJYNN/A

The illustration below shows the outlook, the dimensions and the installation and service space of the unit (mm).

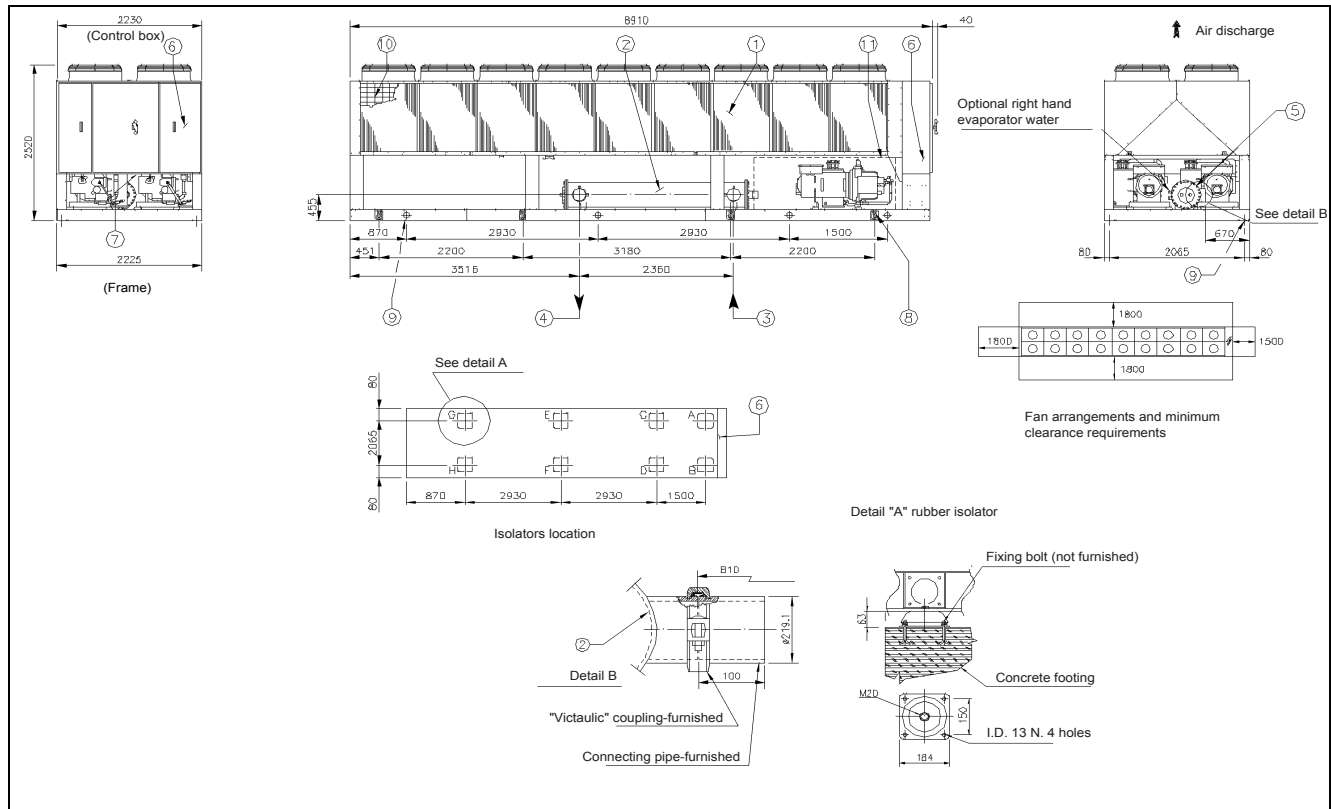

Components

The table below lists the components.

No.	Component
1	Condenser coil
2	Evaporator
3	Evaporator water inlet
4	Evaporator water outlet
5	Victaulic connections for 219.1 O.D. tube
6	Operating and control panel
7	360x150 slot for power and control panel connection
8	8 lifting shackles
9	8 isolator mounting holes 25 mm DIA
10	Coil protection guards (optional)
11	Compressors enclosure (optional)

Version	Condenser type	Weight KG		Isolators load KG							
		Shipping	Operating	A	B	C	D	E	F	G	H
EWAP950AJYNN/A	Aluminium	6490	6760	1115	1195	900	970	685	735	560	600
EWAP950AJYNN/A +OPRN	Acrylic coated										
EWAP950AJYNN/A	Aluminium	6730	7000	1175	1255	960	1030	685	735	560	600
EWAP950AJYNN/A +OPLN	Acrylic coated										
EWAP950AJYNN/A EWAP950AJYNN/A +OPRN EWAP950AJYNN/A +OPLN	Rubber isolators	Type (q/ty)		786010-m (4Pz.)				786010-w (4Pz.)			

EWAPC10AJYNN/A

The illustration below shows the outlook, the dimensions and the installation and service space of the unit (mm).

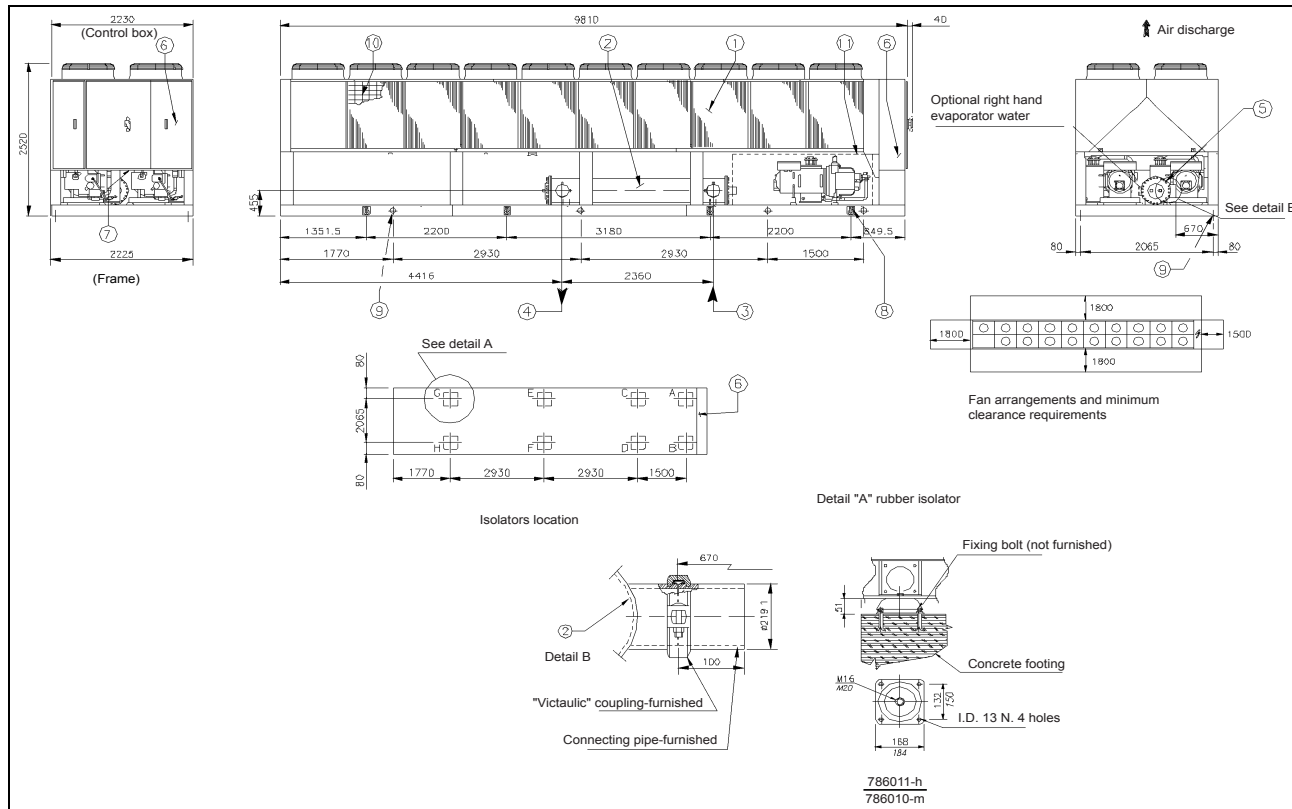

Components

The table below lists the components.

No.	Component
1	Condenser coil
2	Evaporator
3	Evaporator water inlet
4	Evaporator water outlet
5	Victaulic connections for 219.1 O.D. tube
6	Operating and control panel
7	360x150 slot for power and control panel connection
8	8 lifting shackles
9	8 isolator mounting holes 25 mm DIA
10	Coil protection guards (optional)
11	Compressors enclosure (optional)

Version	Condenser type	Weight KG		Isolators load KG							
		Shipping	Operating	A	B	C	D	E	F	G	H
EWAPC10AJYNN/A	Aluminium	6725	6980	1075	1155	885	955	845	865	600	600
EWAPC10AJYNN/A +OPRN	Acrylic coated										
EWAPC10AJYNN/A	Aluminium	6965	7220	1135	1215	945	1015	845	865	600	600
EWAPC10AJYNN/A +OPLN	Acrylic coated										
EWAPC10AJYNN/A EWAPC10AJYNN/A +OPRN EWAPC10AJYNN/A +OPLN	Rubber isolators	Type (q/ty)		786010-m (4Pz.)				786011-h (4Pz.)			

1

EWAPC11AJYNN/A

The illustration below shows the outlook, the dimensions and the installation and service space of the unit (mm).

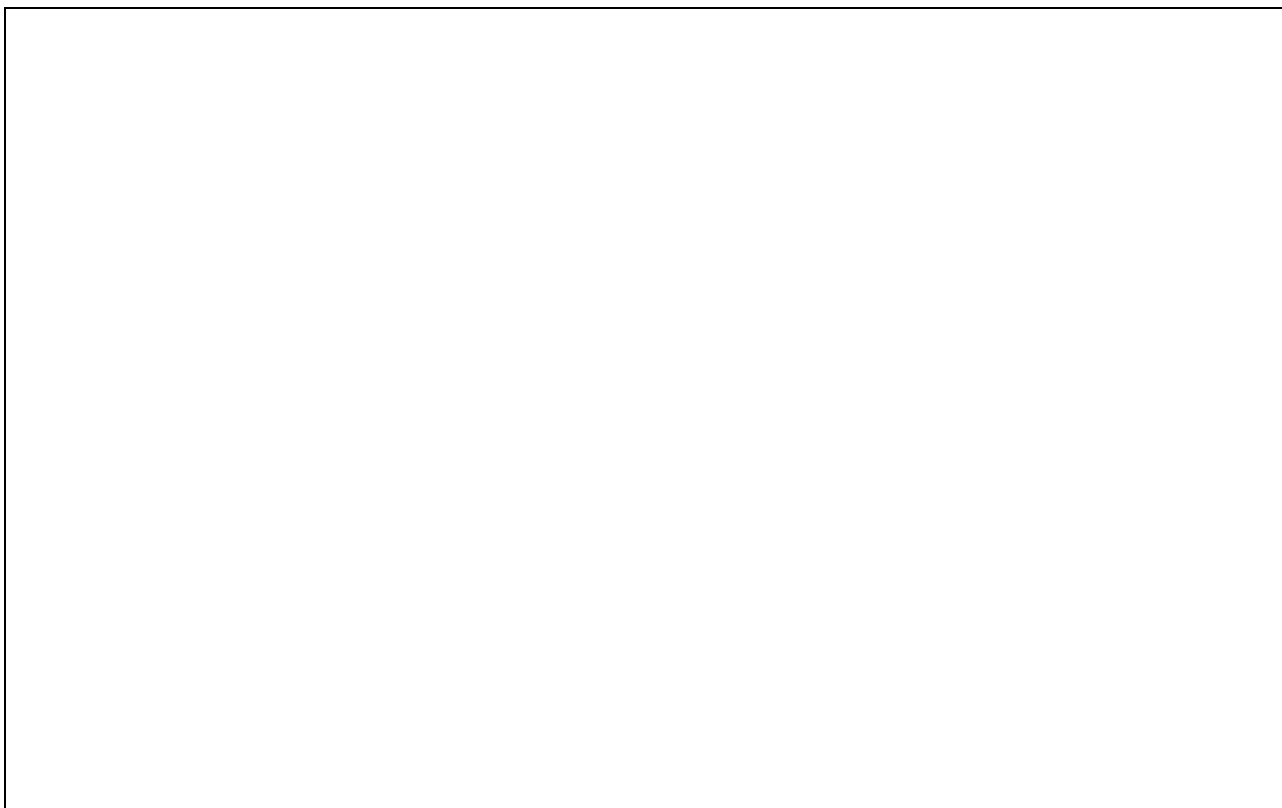

Components

The table below lists the components.

No.	Component
1	Condenser coil
2	Evaporator
3	Evaporator water inlet
4	Evaporator water outlet
5	Victaulic connections for 219.1 O.D. tube
6	Operating and control panel
7	360x150 slot for power and control panel connection
8	8 lifting shackles
9	8 isolator mounting holes 25 mm DIA
10	Coil protection guards (optional)
11	Compressors enclosure (optional)

Version	Condenser type	Weight KG		Isolators load KG							
		Shipping	Operating	A	B	C	D	E	F	G	H
EWAPC10AJYNN/A	Aluminium	6725	6980	1075	1155	885	955	845	865	600	600
EWAPC10AJYNN/A +OPRN	Acrylic coated										
EWAPC10AJYNN/A +OPLN	Aluminium	6965	7220	1135	1215	945	1015	845	865	600	600
	Acrylic coated										
EWAPC10AJYNN/A EWAPC10AJYNN/A +OPRN EWAPC10AJYNN/A +OPLN	Rubber isolators	Type (q/ty)		786010-m (4Pz.)				786010-w (4Pz.)			

EWAPC12AJYNN/A

The illustration below shows the outlook, the dimensions and the installation and service space of the unit (mm).

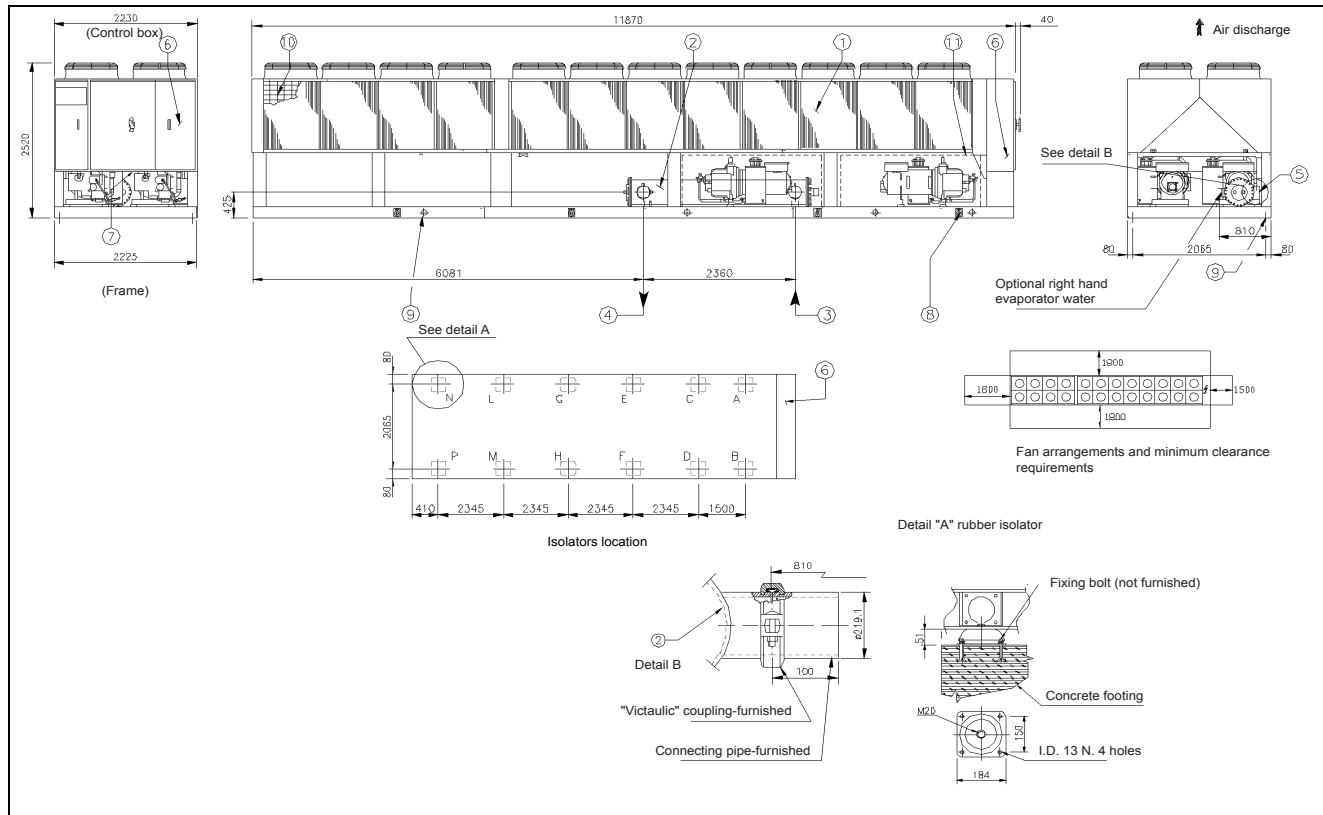

Components

The table below lists the components.

No.	Component
1	Condenser coil
2	Evaporator
3	Evaporator water inlet
4	Evaporator water outlet
5	Victaulic connections for 219.1 O.D. tube
6	Operating and control panel
7	360x150 slot for power and control panel connection
8	8 lifting shackles
9	12 isolator mounting holes 25 mm DIA
10	Coil protection guards (optional)
11	Compressors enclosure (optional)

Version	Con- denser type	Weight KG		Isolators load KG											
		Ship- ping	Operat- ing	A	B	C	D	E	F	G	H	L	M	N	P
EWAPC12AJY NN/A	Alumin- ium	9350	9620	115	115	955	95	112	11	51	515	510	51	550	55
EWAPC12AJY NN/A+OPRN	Acrylic coated			5	5		5	5	25	5				0	
EWAPC12AJY NN/A+OPLN	Alumin- ium	9710	9980	121	121	103	10	116	11	51	515	510	51	550	55
	Acrylic coated			5	5	5	35	5	65	5				0	
EWAPC12AJY NN/A EWAPC12AJY NN/A+OPRN EWAPC12AJY NN/A+OPLN	Rubber isolators	Type (q/ty)		786010-m (6Pz.)						786010-w (6Pz.)					

1

EWAPC13AJYNN/A

The illustration below shows the outlook, the dimensions and the installation and service space of the unit (mm).

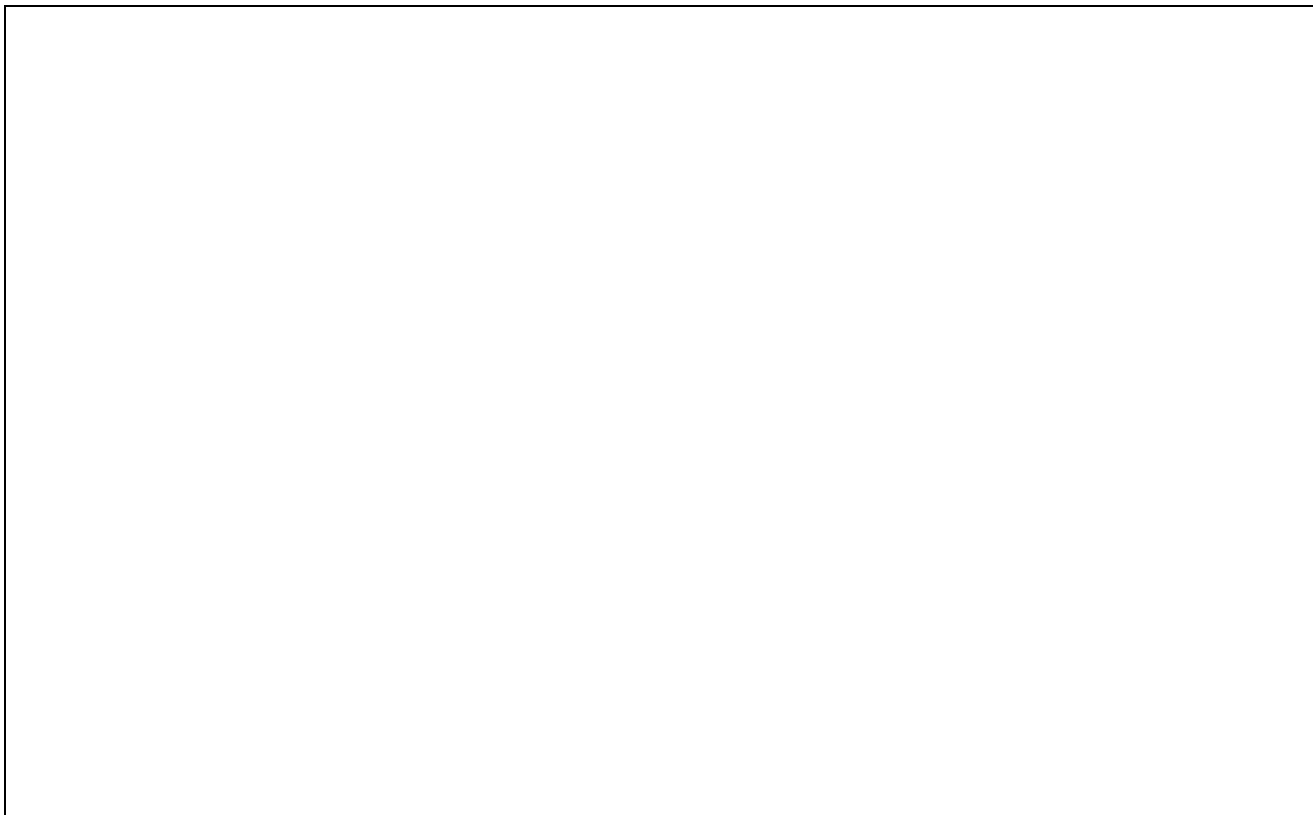

Components

The table below lists the components.

No.	Component
1	Condenser coil
2	Evaporator
3	Evaporator water inlet
4	Evaporator water outlet
5	Victaulic connections for 219.1 O.D. tube
6	Operating and control panel
7	360x150 slot for power and control panel connection
8	8 lifting shackles
9	12 isolator mounting holes 25 mm DIA
10	Coil protection guards (optional)
11	Compressors enclosure (optional)

Version	Con- denser type	Weight KG		Isolators load KG											
		Ship- ping	Operat- ing	A	B	C	D	E	F	G	H	L	M	N	P
EWAPC13AJYN N/A	Alumin- ium	9350	9620	115	115	955	95	112	11	51	515	510	51	550	55
EWAPC13AJYN N/A+OPRN	Acrylic coated			5	5		5	5	25	5				0	
EWAPC13AJYN N/A+OPLN	Alumin- ium	9710	9980	121	121	103	10	116	11	51	515	510	51	550	55
	Acrylic coated			5	5	5	35	5	65	5				0	
EWAPC13AJYN N/A EWAPC13AJYN N/A+OPRN EWAPC13AJYN N/A+OPLN	Rubber isolators	Type (q/ty)		786010-m (4Pz.)						786010-m (4Pz.)					

EWAPC14AJYNN/A

The illustration below shows the outlook, the dimensions and the installation and service space of the unit (mm).

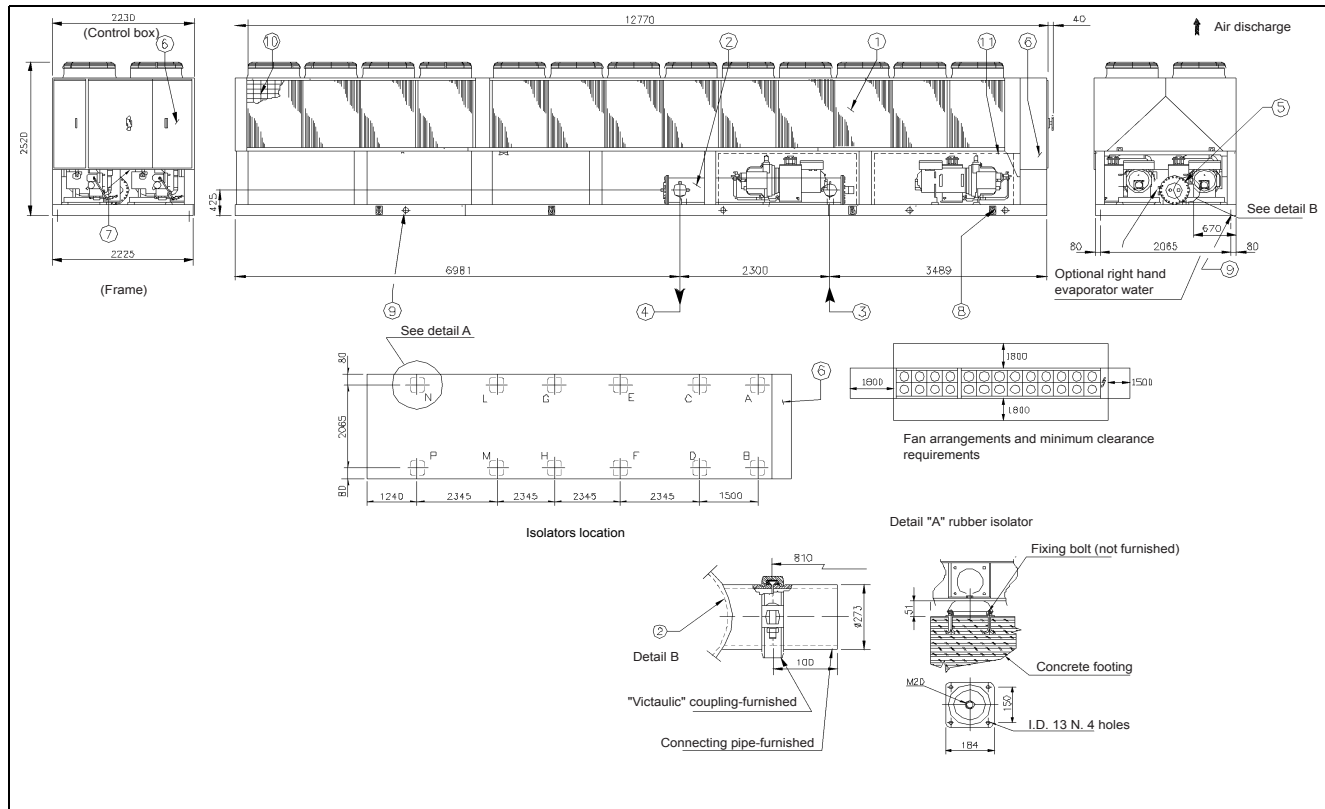

Components

The table below lists the components.

No.	Component
1	Condenser coil
2	Evaporator
3	Evaporator water inlet
4	Evaporator water outlet
5	Victaulic connections for 219.1 O.D. tube
6	Operating and control panel
7	360x150 slot for power and control panel connection
8	8 lifting shackles
9	12 isolator mounting holes 25 mm DIA
10	Coil protection guards (optional)
11	Compressors enclosure (optional)

Version	Con- denser type	Weight KG		Isolators load KG											
		Ship- ping	Operat- ing	A	B	C	D	E	F	G	H	L	M	N	P
EWAPC14AJYN N/A	Alumin- ium	9925	10400	114	114	955	95	138	13	57	570	510	51	640	64
EWAPC14AJYN N/A+OPRN	Acrylic coated			0	0		5	5	85	0				0	
EWAPC14AJYN N/A+OPLN	Alumin- ium	10285	10760	120	120	103	10	142	14	57	570	510	51	640	64
	Acrylic coated			0	0	5	35	5	25	0				0	
EWAPC14AJYN N/A EWAPC14AJYN N/A+OPRN EWAPC14AJYN N/A+OPLN	Rubber isolators	Type (q/ty)		786010-m (6Pz.)						786010-w (6Pz.)					

EWAPC15-16AJYN
N/A

The illustration below shows the outlook, the dimensions and the installation and service space of the unit (mm).

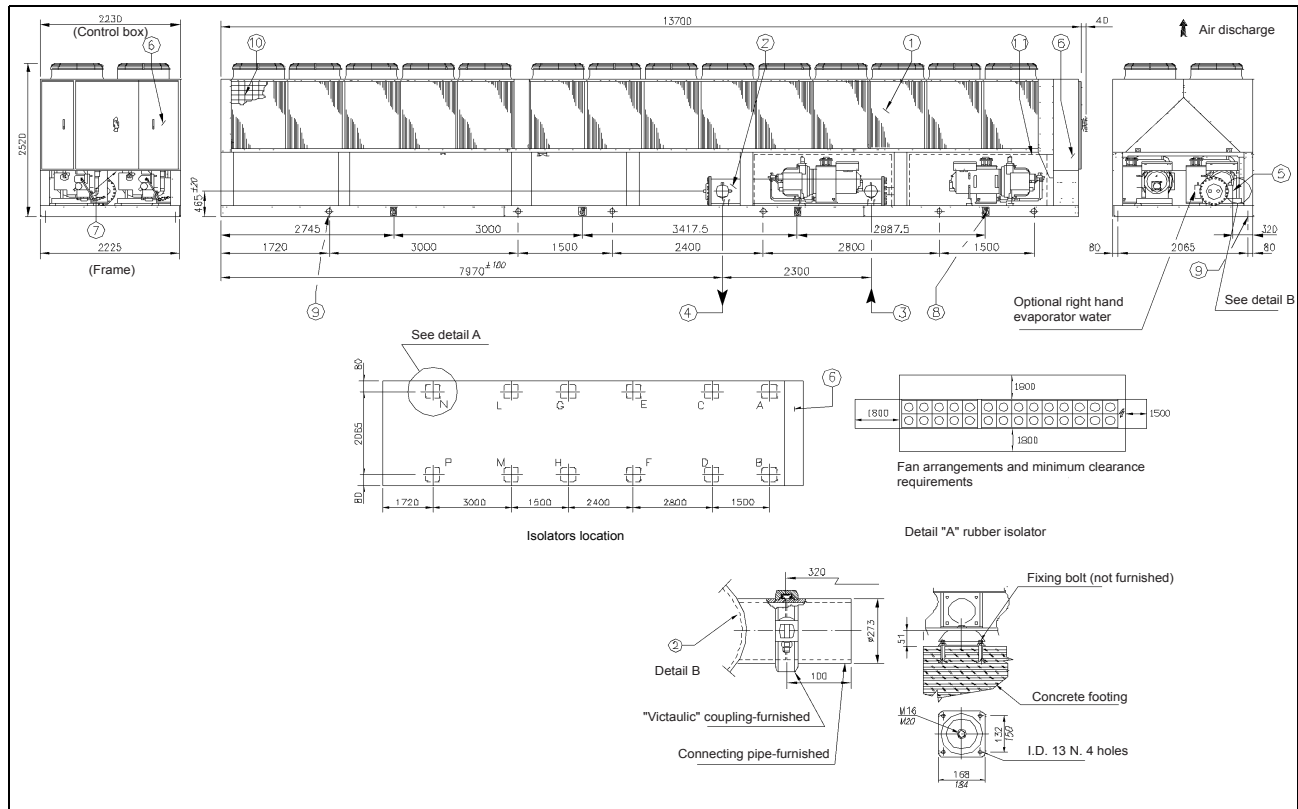

Components

The table below lists the components.

No.	Component
1	Condenser coil
2	Evaporator
3	Evaporator water inlet
4	Evaporator water outlet
5	Victaulic connections for 273 O.D. tube
6	Operating and control panel
7	360x150 slot for power and control panel connection
8	8 lifting shackles
9	12 isolator mounting holes 25 mm DIA
10	Coil protection guards (optional)
11	Compressors enclosure (optional)

Version	Condenser type	Weight KG		Isolators load KG											
		Ship-ping	Operat-ing	A	B	C	D	E	F	G	H	L	M	N	P
EWAPC15-1 6AJYNN/A	Aluminium	10360	10830	117	117	120	12	126	12	64	640	430	43	705	70
EWAPC15-1 6AJYNN/A+ OPRN	Acrylic coated			5	5	0	00	5	65	0				0	
EWAPC15-1 6AJYNN/A+ OPLN	Aluminium	10720	11190	123	123	128	12	130	13	64	640	430	43	705	70
	Acrylic coated			5	5	0	80	5	05	0				0	
EWAPC15-1 6AJYNN/A EWAPC15-1 6AJYNN/A+ OPRN EWAPC15-1 6AJYNN/A+ OPLN	Rubber iso-lators	Type (q/ty)		786010-m (6Pz.)						786011-h (6Pz.)					

1

EWAPC17AJYNN/A

The illustration below shows the outlook, the dimensions and the installation and service space of the unit (mm).

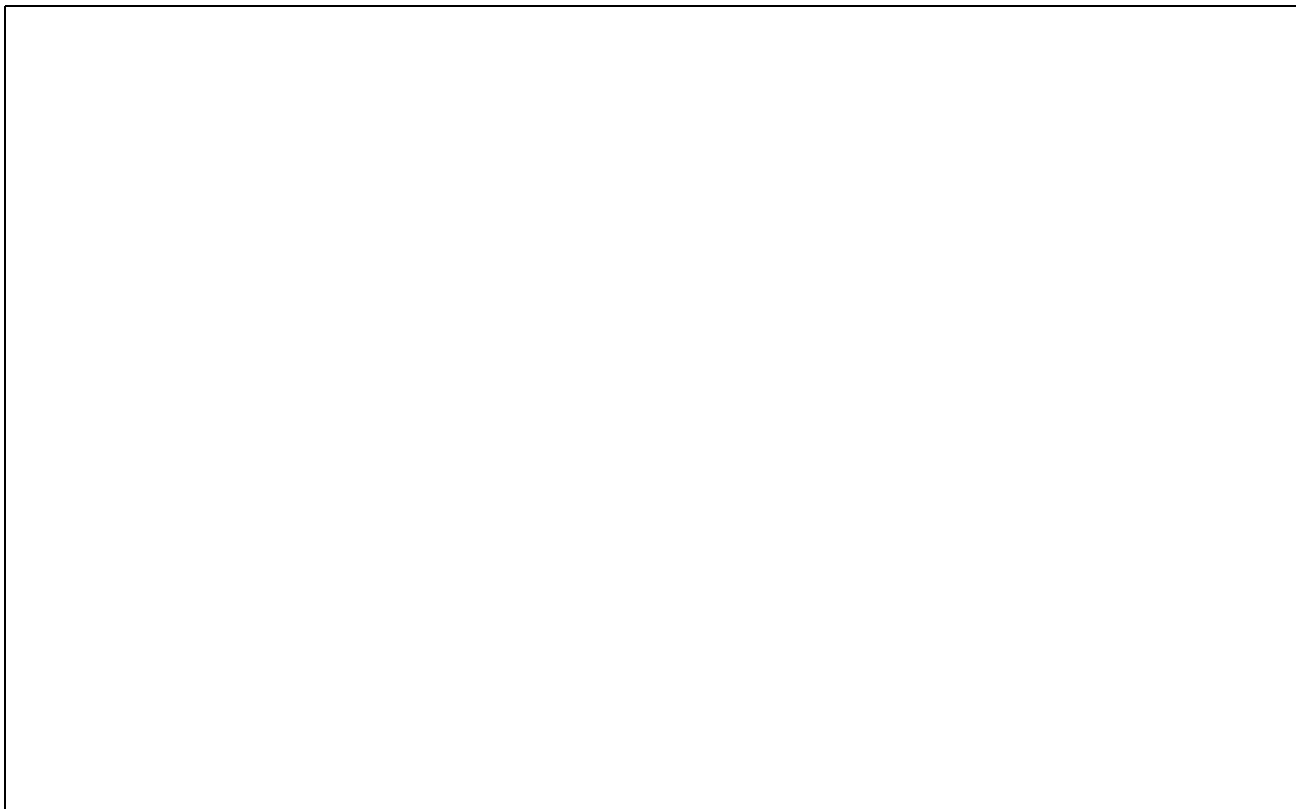

Components

The table below lists the components.

No.	Component
1	Condenser coil
2	Evaporator
3	Evaporator water inlet
4	Evaporator water outlet
5	Victaulic connections for 219.1 O.D. tube
6	Operating and control panel
7	360x150 slot for power and control panel connection
8	8 lifting shackles
9	12 isolator mounting holes 25 mm DIA
10	Coil protection guards (optional)
11	Compressors enclosure (optional)

Version	Condenser type	Weight KG		Isolators load KG											
		Ship-ping	Operat-ing	A	B	C	D	E	F	G	H	L	M	N	P
EWAPC17A JYNN/A	Aluminium	10360	10830	117	117	120	12	126	12	64	640	430	43	705	70
EWAPC17A JYNN/A+OP RN	Acrylic coated			5	5	0	00	5	65	0				0	
EWAPC17A JYNN/A+OP LN	Aluminium	10720	11190	123	123	128	12	130	13	64	640	430	43	705	70
	Acrylic coated			5	5	0	80	5	05	0				0	
EWAPC17A JYNN/A EWAPC17A JYNNN/A+O PRN EWAPC17A JYNNN/A+O PLN	Rubber iso-lators	Type (q/ty)		786010-m (4Pz.)						786010-m (4Pz.)					

1

EWAPC18AJYNN/A

The illustration below shows the outlook, the dimensions and the installation and service space of the unit (mm).

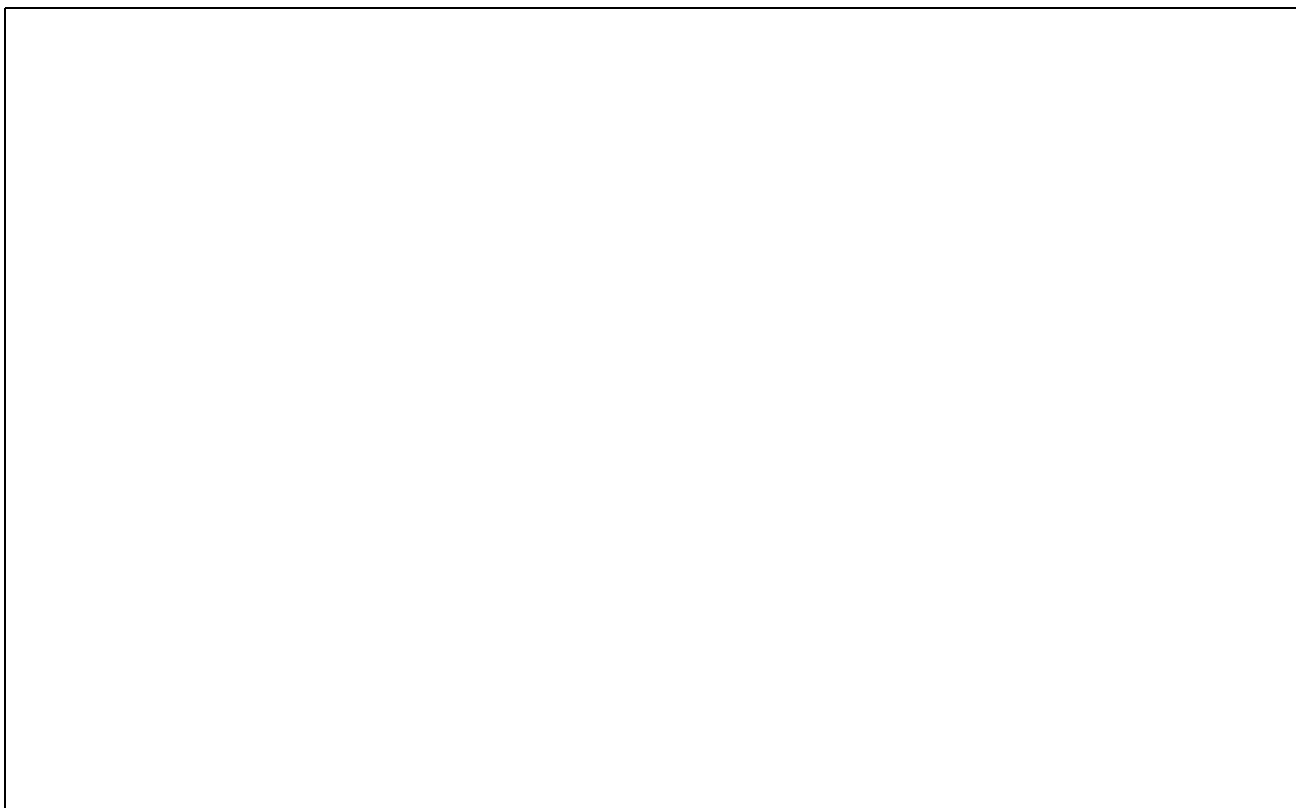

Components

The table below lists the components.

- | No. | Component |
|-----|---|
| 1 | Condenser coil |
| 2 | Evaporator |
| 3 | Evaporator water inlet |
| 4 | Evaporator water outlet |
| 5 | Victaulic connections for 219.1 O.D. tube |
| 6 | Operating and control panel |
| 7 | 360x150 slot for power and control panel connection |
| 8 | 8 lifting shackles |
| 9 | 12 isolator mounting holes 25 mm DIA |
| 10 | Coil protection guards (optional) |
| 11 | Compressors enclosure (optional) |

Version	Con- denser type	Weight KG		Isolators load KG											
		Ship- ping	Operat- ing	A	B	C	D	E	F	G	H	L	M	N	P
EWAPC18AJY NN/A	Aluminium	10360	10830	117	117	120	12	126	12	64	640	430	43	705	70
EWAPC18AJY NN/A+OPRN	Acrylic coated			5	5	0	00	5	65	0			0		
EWAPC18AJY NN/A+OPLN	Aluminium	10720	11190	123	123	128	12	130	13	64	640	430	43	705	70
	Acrylic coated			5	5	0	80	5	05	0			0		
EWAPC18AJY NN/A EWAPC18AJY NN/A+OPRN EWAPC18AJY NN/A+OPLN	Rubber isolators	Type (q/ty)		786010-m (4Pz.)						786010-m (4Pz.)					



1.8 Capacity tables EWAP-AJYNN

EWAP800-C14AJY
NN

Unit size	LWE	AIR AMBIENT TEMPERATURE (°C)									
		25		30		35		40		42	
		CC	PI	CC	PI	CC	PI	CC	PI	CC	PI
800	4	808,7	248,3	768,6	275,7	726,4	307,3	681,4	343,5	662,8	359,5
	5	831,4	251,7	790,6	279,0	747,5	310,4	701,6	346,4	682,6	362,2
	6	854,5	255,2	812,9	282,4	768,8	313,6	722,1	349,3	702,7	365,0
	7	877,8	258,8	835,3	286,0	790,4	317,0	742,8	352,5	723,0	368,0
	8	901,5	262,5	858,0	289,6	812,3	320,5	763,7	355,7	743,6	371,2
	9	925,4	266,2	881,0	293,4	834,3	324,2	784,9	359,2	764,3	374,5
900	4	895,8	274,7	851,1	303,6	804,2	336,5	754,4	373,9	733,8	390,3
	5	920,9	278,6	875,5	307,5	827,5	340,2	776,8	377,5	755,6	393,7
	6	946,6	282,7	900,1	311,5	851,1	344,2	799,3	381,2	777,8	397,3
	7	972,3	286,9	924,9	315,7	875,0	348,2	822,1	385,1	800,2	401,1
	8	998,5	291,2	950,1	320,0	899,1	352,5	845,2	389,1	822,8	405,1
	9	1024,9	295,6	975,5	324,4	923,5	356,8	868,5	393,3	845,6	409,2
950	4	965,7	298,5	918,1	329,1	868,0	363,6	814,9	402,5	792,9	419,4
	5	992,6	302,9	944,1	333,5	892,9	367,9	838,8	406,7	816,3	423,5
	6	1019,9	307,4	970,4	338,0	918,0	372,4	862,9	411,0	840,0	427,7
	7	1047,4	311,9	996,8	342,6	943,6	376,9	887,3	415,5	863,9	432,1
	8	1075,2	316,7	1023,7	347,3	969,3	381,7	911,9	420,1	888,0	436,7
	9	1103,4	321,5	1050,7	352,2	995,3	386,5	936,8	424,9	912,4	441,4
C10	4	1051,1	326,7	998,9	360,0	943,9	397,6	885,7	440,0	861,4	458,4
	5	1080,5	331,5	1027,2	364,9	970,9	402,4	911,6	444,6	886,8	463,0
	6	1110,1	336,5	1055,8	369,8	998,4	407,3	937,7	449,4	912,6	467,7
	7	1140,2	341,5	1084,6	374,9	1026,1	412,4	964,2	454,4	938,5	472,6
	8	1170,6	346,8	1113,8	380,2	1054,1	417,6	991,0	459,5	964,8	477,6
	9	1201,2	352,1	1143,3	385,6	1082,4	423,0	1018,1	464,8	991,3	482,9
C11	4	1118,6	351,9	1063,4	388,2	1005,0	429,1	943,3	475,2	917,5	495,3
	5	1149,6	357,0	1093,1	393,3	1033,7	434,2	970,8	480,1	944,4	500,1
	6	1180,8	362,3	1123,3	398,6	1062,7	439,4	998,4	485,2	971,6	505,1
	7	1212,5	367,7	1153,9	404,0	1091,9	444,8	1026,4	490,5	999,1	510,3
	8	1244,5	373,2	1184,6	409,6	1121,5	450,3	1054,6	495,9	1026,9	515,7
	9	1277,0	378,9	1215,8	415,4	1151,3	456,1	1083,3	501,6	1054,9	521,2
C12	4	1183,6	368,2	1126,1	409,7	1065,2	457,4	1000,6	512,4	973,6	536,7
	5	1216,5	373,0	1157,8	414,3	1095,8	461,8	1030,0	516,4	1002,3	540,4
	6	1249,8	378,0	1190,1	419,2	1126,8	466,4	1059,6	520,5	1031,4	544,4
	7	1283,5	383,0	1222,5	424,1	1158,0	471,2	1089,6	524,9	1060,9	548,6
	8	1317,5	388,3	1255,4	429,3	1189,7	476,1	1119,9	529,6	1090,7	553,0
	9	1352,0	393,6	1288,6	434,6	1221,6	481,3	1150,5	534,4	1120,7	557,6
C13	4	1315,2	401,1	1249,2	443,5	1179,8	492,0	1106,1	547,2	1075,4	571,5
	5	1352,5	406,9	1285,1	449,2	1214,1	497,4	1139,1	552,4	1107,8	576,4
	6	1390,3	412,8	1321,4	455,1	1249,0	503,1	1172,4	557,7	1140,5	581,6
	7	1428,4	419,0	1358,2	461,2	1284,2	509,1	1206,1	563,3	1173,6	587,0
	8	1467,0	425,3	1395,4	467,5	1319,9	515,2	1240,2	569,2	1207,1	592,7
	9	1506,2	431,7	1433,0	473,9	1356,0	521,5	1274,6	575,3	1240,7	598,7
C14	4	1385,9	425,1	1316,9	469,2	1244,0	519,3	1167,3	576,0	1135,2	600,8
	5	1424,9	431,3	1354,3	475,4	1280,2	525,3	1201,7	581,7	1168,9	606,3
	6	1464,4	437,7	1392,5	481,7	1316,6	531,5	1236,6	587,7	1203,2	612,2
	7	1504,3	444,2	1430,8	488,3	1353,5	537,9	1271,7	593,9	1237,8	618,2
	8	1544,7	450,9	1469,7	495,0	1390,7	544,6	1307,4	600,3	1272,8	624,5
	9	1585,6	457,8	1509,1	501,9	1428,5	551,4	1343,5	607,0	1308,1	631,1

SYMBOLS

CC	:	Cooling capacity (kW)
PI	:	Power input for the compressor only (kW)
LWE	:	Leaving Water Evaporator (°C)

NOTES

- 1 The power input is for compressor only; cooling cap. and power input referred to evap. fouling factor= 0,0176m² °C/kW.
- 2 Shaded values are referred to part load operation.

1

**EWAPC15-C18AJY
NN**

Unit size	LWE	AIR AMBIENT TEMPERATURE (°C)											
		25		30		35		40		45		46	
		CC	PI	CC	PI	CC	PI	CC	PI	CC	PI	CC	PI
C15	4	1517,1	413,0	1447,2	454,8	1373,8	502,0	1296,4	555,2	1214,5	615,1	1197,6	628,0
	5	1560,7	418,6	1489,3	460,5	1414,3	507,6	1335,4	560,5	1251,9	620,2	1234,6	633,0
	6	1604,7	424,5	1531,9	466,3	1455,5	513,3	1374,8	566,1	1289,8	625,5	1272,2	638,2
	7	1649,5	430,4	1575,2	472,3	1497,1	519,3	1414,9	571,9	1328,1	631,0	1310,2	643,6
	8	1694,8	436,5	1619,0	478,5	1539,3	525,4	1455,5	577,9	1367,0	636,7	1348,7	649,3
	9	1740,6	442,8	1663,3	484,8	1582,1	531,7	1496,6	584,1	1406,4	642,7	1387,6	655,2
C16	4	1617,8	441,8	1542,1	486,2	1462,8	536,2	1379,2	592,6	1290,7	656,2	1272,6	669,8
	5	1664,5	448,0	1587,2	492,4	1506,2	542,4	1420,8	598,5	1330,7	661,8	1312,0	675,3
	6	1711,8	454,4	1633,0	498,8	1550,3	548,7	1463,1	604,7	1371,0	667,6	1352,1	681,1
	7	1759,8	460,9	1679,2	505,4	1594,7	555,2	1505,9	611,0	1412,0	673,6	1392,7	687,0
	8	1808,3	467,6	1726,2	512,2	1640,0	561,9	1549,2	617,6	1453,6	680,0	1433,8	693,3
	9	1857,4	474,5	1773,6	519,1	1685,7	568,9	1593,2	624,4	1495,6	686,5	1475,4	699,8
C17	4	1672,4	475,3	1593,1	523,5	1509,9	577,8	1421,9	639,1	1329,0	708,1	1309,7	722,9
	5	1720,1	482,0	1639,1	530,3	1554,1	584,5	1464,5	645,5	1369,7	714,1	1350,0	728,8
	6	1768,3	489,0	1685,8	537,2	1599,1	591,3	1507,5	652,1	1410,8	720,4	1390,7	735,1
	7	1817,2	496,0	1733,1	544,3	1644,4	598,4	1551,1	659,0	1452,5	727,0	1432,0	741,6
	8	1866,8	503,3	1780,8	551,7	1690,4	605,7	1595,3	666,2	1494,6	733,9	1473,8	748,4
	9	1916,8	510,8	1829,2	559,2	1737,0	613,2	1640,0	673,6	1537,3	741,0	1516,2	755,4
C18	4	1755,1	490,8	1673,4	540,7	1587,5	597,0	1497,0	660,5	1401,1	732,1	1381,2	747,5
	5	1805,1	497,6	1721,7	547,5	1634,1	603,7	1541,7	667,0	1444,0	738,2	1423,8	753,5
	6	1855,8	504,5	1770,7	554,5	1681,3	610,6	1586,9	673,7	1487,2	744,6	1466,7	759,8
	7	1906,9	511,7	1820,2	561,7	1729,1	617,8	1632,9	680,7	1531,2	751,2	1510,2	766,3
	8	1959,0	519,0	1870,4	569,1	1777,4	625,1	1679,3	687,8	1575,7	758,1	1554,2	773,2
	9	2011,5	526,5	1921,2	576,7	1826,3	632,7	1726,4	695,3	1620,6	765,3	1598,8	780,3

SYMBOLS

CC	:	Cooling capacity (kW)
PI	:	Power input for the compressor only (kW)
LWE	:	Leaving Water Evaporator (°C)

NOTES

- 1 The power input is for compressor only; cooling cap. and power input referred to evap. fouling factor= 0,0176m² °C/kW
-

1

1.9 Capacity tables EWAP-AJYNN + OPRN + OPLN

EWAP800-C14AJY
NN+OPRN+OPLN

Unit size	LWE	AIR AMBIENT TEMPERATURE (°C)							
		25		30		35		38	
		CC	PI	CC	PI	CC	PI	CC	PI
800	4	771,2	273,9	729,4	304,9	685,2	340,5	657,2	364,4
	5	792,3	277,9	749,7	308,7	704,4	344,1	675,9	367,8
	6	813,6	281,9	770,1	312,7	724,0	347,9	694,8	371,4
	7	835,0	286,1	790,7	316,8	743,7	351,8	714,0	375,2
	8	856,8	290,5	811,4	321,0	763,5	355,9	733,3	379,1
	9	878,6	294,9	832,4	325,4	783,5	360,2	752,7	383,3
900	4	853,1	302,3	806,8	334,6	757,7	371,3	726,9	395,8
	5	876,4	306,9	829,0	339,1	779,0	375,7	747,6	400,1
	6	899,9	311,6	851,5	343,8	800,5	380,3	768,3	404,5
	7	923,6	316,5	874,3	348,7	822,1	385,1	789,4	409,1
	8	947,5	321,6	897,2	353,7	844,0	390,0	810,6	413,9
	9	971,6	326,7	920,3	358,9	866,0	395,1	831,9	418,9
950	4	920,1	327,8	870,7	361,7	818,3	399,9	785,5	425,2
	5	944,9	332,9	894,5	366,8	841,0	405,0	807,6	430,1
	6	970,1	338,2	918,5	372,1	864,1	410,2	829,8	435,2
	7	995,3	343,6	942,7	377,5	887,1	415,6	852,2	440,5
	8	1020,7	349,1	967,2	383,1	910,5	421,1	874,8	446,0
	9	1046,6	354,8	991,8	388,8	934,0	426,8	897,5	451,6
C10	4	1000,2	359,2	945,8	396,2	888,5	437,9	852,4	465,4
	5	1027,2	364,8	971,7	401,9	913,2	443,5	876,3	470,9
	6	1054,4	370,7	997,8	407,7	938,0	449,3	900,5	476,6
	7	1081,9	376,6	1024,1	413,7	963,2	455,2	924,7	482,5
	8	1109,6	382,8	1050,7	419,9	988,4	461,3	949,2	488,5
	9	1137,5	389,0	1077,4	426,2	1013,9	467,6	974,1	494,8
C11	4	1064,5	387,3	1007,1	427,6	946,2	473,1	907,7	503,1
	5	1093,1	393,3	1034,3	433,7	972,1	479,0	933,1	508,9
	6	1121,9	399,5	1061,9	439,9	998,5	485,2	958,5	515,0
	7	1150,9	405,9	1089,7	446,3	1025,0	491,5	984,2	521,2
	8	1180,3	412,4	1117,8	452,8	1051,6	498,0	1010,2	527,7
	9	1209,7	419,1	1146,0	459,6	1078,6	504,8	1036,3	534,3
C12	4	1130,8	406,1	1070,8	452,9	1006,9	506,9	966,4	543,2
	5	1161,3	411,8	1100,1	458,4	1034,9	512,0	993,7	548,0
	6	1192,2	417,5	1129,8	464,1	1063,4	517,4	1021,2	553,1
	7	1223,4	423,5	1159,7	469,9	1091,9	523,0	1049,2	558,5
	8	1254,8	429,7	1189,9	476,0	1120,7	528,8	1077,2	564,1
	9	1286,6	436,0	1220,3	482,2	1149,9	534,9	1105,5	569,9
C13	4	1251,9	441,8	1183,4	489,3	1110,8	543,6	1065,1	579,8
	5	1286,3	448,5	1216,3	495,9	1142,2	550,0	1095,6	586,0
	6	1320,9	455,4	1249,5	502,8	1173,9	556,6	1126,4	592,4
	7	1356,0	462,6	1283,1	509,9	1205,8	563,5	1157,3	599,1
	8	1391,3	470,0	1316,9	517,2	1238,1	570,6	1188,6	606,0
	9	1427,1	477,5	1350,8	524,7	1270,5	578,0	1220,1	613,2
C14	4	1319,5	467,5	1247,7	516,6	1171,9	572,4	1124,2	609,3
	5	1355,5	474,7	1282,2	523,8	1204,8	579,4	1156,2	616,2
	6	1391,7	482,2	1317,1	531,2	1238,0	586,7	1188,3	623,3
	7	1428,3	489,8	1352,1	538,9	1271,3	594,2	1220,7	630,6
	8	1465,3	497,7	1387,4	546,8	1305,1	601,9	1253,5	638,2
	9	1502,6	505,8	1423,0	554,9	1339,1	609,9	1286,5	646,1

SYMBOLS

CC	:	Cooling capacity (kW)
PI	:	Power input for the compressor only (kW)
LWE	:	Leaving Water Evaporator (°C)

NOTES

- 1 The power input is for compressor only; cooling cap. and power input referred to evap. fouling factor= 0,0176m² °C/kW

1

EWAPC15-C18AJY
NN+OPRN+OPLN

Unit size	LWE	AIR AMBIENT TEMPERATURE (°C)							
		25		30		35		38	
		CC	PI	CC	PI	CC	PI	CC	PI
C15	4	1394,4	488,4	1320,0	538,6	1241,2	595,2	1191,7	632,5
	5	1432,3	496,0	1356,3	546,2	1275,9	602,7	1225,3	639,9
	6	1470,5	503,8	1392,9	554,1	1310,8	610,5	1259,3	647,6
	7	1509,2	511,9	1429,9	562,1	1346,1	618,5	1293,6	655,5
	8	1548,1	520,1	1467,1	570,5	1381,7	626,7	1328,1	663,6
	9	1587,4	528,6	1504,7	579,0	1417,6	635,2	1363,0	672,1
C16	4	1477,4	526,7	1396,8	580,4	1311,4	640,9	1257,8	680,8
	5	1517,5	535,1	1435,1	588,8	1348,0	649,2	1293,4	689,0
	6	1558,0	543,7	1473,7	597,5	1384,9	657,8	1329,1	697,5
	7	1598,9	552,6	1513,0	606,4	1422,1	666,7	1365,2	706,2
	8	1640,2	561,8	1552,3	615,6	1459,7	675,8	1401,6	715,2
	9	1681,7	571,1	1592,1	625,0	1497,5	685,2	1438,3	724,5
C17	4	1542,7	555,0	1458,6	612,0	1369,8	676,3	1313,9	718,7
	5	1584,3	563,8	1498,5	620,8	1407,7	685,0	1350,6	727,2
	6	1626,5	572,8	1538,7	629,9	1446,1	693,9	1387,9	736,0
	7	1668,9	582,1	1579,4	639,2	1484,7	703,2	1425,4	745,2
	8	1711,7	591,6	1620,2	648,8	1523,8	712,7	1463,2	754,6
	9	1754,8	601,4	1661,5	658,6	1563,1	722,5	1501,3	764,3
C18	4	1607,9	583,3	1520,5	643,6	1428,0	711,6	1369,8	756,5
	5	1651,2	592,5	1561,9	652,8	1467,4	720,7	1408,1	765,4
	6	1694,8	601,9	1603,6	662,3	1507,3	730,0	1446,7	774,6
	7	1738,8	611,6	1645,8	672,0	1547,4	739,7	1485,7	784,1
	8	1783,2	621,5	1688,2	682,0	1587,8	749,6	1524,8	794,0
	9	1827,9	631,7	1731,0	692,3	1628,6	759,8	1564,4	804,1

SYMBOLS

CC	:	Cooling capacity (kW)
PI	:	Power input for the compressor only (kW)
LWE	:	Leaving Water Evaporator (°C)

NOTES

- 1 The power input is for compressor only; cooling cap. and power input referred to evap. fouling factor= 0,0176m² °C/kW.

1.10 Capacity tables EWAP-AJYNN/A

EWAP850-C14AJY
 NN/A: standard

Unit size	LWE	AIR AMBIENT TEMPERATURE (°C)											
		25		30		35		40		45		46	
		CC	PI	CC	PI	CC	PI	CC	PI	CC	PI	CC	PI
850	4	864,4	227,6	824,3	251,8	782,0	279,6	737,6	311,4	690,5	348,0	680,7	356,0
	5	889,8	230,6	848,7	254,7	805,7	282,3	760,3	313,9	712,2	350,2	702,3	358,0
	6	915,6	233,7	873,6	257,8	829,7	285,2	783,3	316,5	734,4	352,5	724,2	360,2
	7	941,6	236,8	898,9	260,9	854,1	288,2	806,7	319,3	756,7	354,9	746,3	362,6
	8	968,1	240,1	924,4	264,1	878,6	291,3	830,4	322,3	779,4	357,5	768,9	365,2
900	4	967,5	255,2	921,4	281,0	873,3	310,3	822,8	343,6	769,3	381,4	758,3	389,6
	5	996,0	258,8	949,0	284,6	899,9	313,8	848,2	346,8	793,7	384,4	782,5	392,5
	6	1025,1	262,5	977,2	288,3	926,9	317,4	874,1	350,3	818,4	387,5	807,0	395,6
	7	1054,5	266,3	1005,5	292,1	954,2	321,1	900,3	353,8	843,5	390,9	831,7	398,8
	8	1084,4	270,3	1034,2	296,0	981,9	325,0	926,9	357,6	868,9	394,3	857,0	402,2
950	4	1114,6	274,3	1063,5	300,1	1010,0	329,0	953,8	361,4	894,6	398,0	882,4	405,8
	5	1042,8	279,5	993,4	307,2	941,7	338,4	887,6	373,5	830,3	413,0	818,4	421,5
	6	1073,3	283,5	1022,9	311,2	970,2	342,3	914,6	377,3	856,2	416,7	844,2	425,1
	7	1104,1	287,7	1052,7	315,4	998,8	346,4	942,1	381,3	882,5	420,4	870,2	428,8
	8	1135,5	291,9	1082,9	319,7	1027,8	350,7	970,2	385,4	909,2	424,4	896,6	432,7
C10	4	1167,3	296,3	1113,6	324,1	1057,4	355,0	998,4	389,7	936,3	428,5	923,4	436,8
	5	1199,4	300,8	1144,6	328,6	1087,3	359,5	1027,0	394,1	963,7	432,7	950,6	441,0
	6	1141,8	308,1	1086,9	338,3	1029,3	372,4	968,8	410,7	905,2	453,8	892,0	463,1
	7	1175,3	312,7	1119,1	342,9	1060,4	376,9	998,6	415,0	933,6	457,9	920,2	467,1
	8	1209,3	317,4	1152,0	347,6	1091,9	381,5	1028,8	419,5	962,4	462,2	948,7	471,4
C11	4	1243,9	322,2	1185,2	352,5	1123,9	386,3	1059,5	424,2	991,6	466,7	977,6	475,8
	5	1278,8	327,1	1218,9	357,5	1156,3	391,3	1090,5	429,1	1021,2	471,4	1007,0	480,4
	6	1314,2	332,2	1253,1	362,6	1189,0	396,4	1121,9	434,1	1051,2	476,2	1036,7	485,2
	7	1215,4	333,4	1157,1	366,3	1095,9	403,4	1031,6	445,2	963,9	492,3	949,8	502,4
	8	1250,8	338,3	1191,2	371,2	1128,8	408,3	1063,1	449,9	993,8	496,7	979,5	506,8
C12	4	1286,8	343,3	1225,8	376,3	1162,0	413,3	1094,9	454,7	1024,2	501,3	1009,7	511,3
	5	1323,1	348,5	1260,8	381,5	1195,7	418,4	1127,3	459,8	1055,1	506,2	1040,2	516,1
	6	1360,0	353,8	1296,5	386,8	1229,9	423,7	1160,0	465,0	1086,3	511,2	1071,1	521,0
	7	1397,2	359,2	1332,4	392,3	1264,4	429,2	1193,2	470,4	1118,0	516,4	1102,4	526,2
	8	1267,2	338,1	1209,3	374,6	1148,5	416,5	1084,2	464,8	1016,1	520,2	1001,9	532,3
C13	4	1303,9	342,3	1244,8	378,7	1182,7	420,4	1117,2	468,3	1047,7	523,2	1033,4	535,1
	5	1341,1	346,7	1280,8	383,0	1217,5	424,5	1150,6	472,0	1079,9	526,4	1065,1	538,2
	6	1378,8	351,2	1317,3	387,5	1252,7	428,8	1184,5	475,9	1112,3	529,9	1097,4	541,5
	7	1417,1	355,8	1354,2	392,0	1288,3	433,2	1218,9	480,1	1145,3	533,5	1130,0	545,1
	8	1455,7	360,5	1391,7	396,8	1324,5	437,8	1253,7	484,4	1178,6	537,4	1163,2	548,9
C14	4	1374,4	365,9	1310,6	404,0	1243,5	447,4	1172,9	496,9	1098,1	553,4	1082,6	565,7
	5	1414,6	370,8	1349,4	408,8	1280,8	452,0	1208,7	501,2	1132,5	557,3	1116,7	569,4
	6	1455,3	375,8	1388,6	413,8	1318,7	456,8	1245,2	505,8	1167,3	561,4	1151,2	573,4
	7	1496,5	381,0	1428,5	418,9	1357,1	461,9	1282,0	510,5	1202,7	565,7	1186,4	577,6
	8	1538,3	386,3	1468,9	424,3	1396,1	467,1	1319,4	515,5	1238,5	570,3	1221,8	582,1
C14	4	1580,6	391,8	1509,9	429,7	1435,5	472,4	1357,2	520,6	1274,7	575,1	1257,6	586,8
	5	1445,7	389,5	1378,8	429,5	1308,5	474,8	1234,5	526,1	1156,2	584,4	1140,0	596,9
	6	1487,4	394,8	1419,2	434,7	1347,4	479,9	1271,8	531,0	1192,0	588,8	1175,5	601,3
	7	1530,0	400,2	1460,2	440,1	1387,0	485,2	1309,9	536,0	1228,4	593,5	1211,5	605,9
	8	1572,9	405,8	1501,6	445,7	1427,1	490,7	1348,3	541,3	1265,3	598,5	1248,1	610,7
C14	4	1616,4	411,5	1543,8	451,5	1467,5	496,3	1387,2	546,8	1302,5	603,6	1285,0	615,8
	5	1660,5	417,4	1586,4	457,4	1508,6	502,2	1426,8	552,5	1340,4	609,0	1322,5	621,1

1**SYMBOLS**

CC	:	Cooling capacity (kW)
PI	:	Power input for the compressor only (kW)
LWE	:	Leaving Water Evaporator (°C)

NOTES

- 1 The power input is for compressor only; cooling cap. and power input referred to evap. fouling factor= 0,0176m² °C/kW

EWAPC15-18AJYN
N/A

Unit size	LWE	AIR AMBIENT TEMPERATURE (°C)											
		25		30		35		40		45		46	
		CC	PI	CC	PI	CC	PI	CC	PI	CC	PI	CC	PI
C15	4	1517,1	413,0	1447,2	454,8	1373,8	502,0	1296,4	555,2	1214,5	615,1	1197,6	628,0
	5	1560,7	418,6	1489,3	460,5	1414,3	507,6	1335,4	560,5	1251,9	620,2	1234,6	633,0
	6	1604,7	424,5	1531,9	466,3	1455,5	513,3	1374,8	566,1	1289,8	625,5	1272,2	638,2
	7	1649,5	430,4	1575,2	472,3	1497,1	519,3	1414,9	571,9	1328,1	631,0	1310,2	643,6
	8	1694,8	436,5	1619,0	478,5	1539,3	525,4	1455,5	577,9	1367,0	636,7	1348,7	649,3
	9	1740,6	442,8	1663,3	484,8	1582,1	531,7	1496,6	584,1	1406,4	642,7	1387,6	655,2
C16	4	1617,8	441,8	1542,1	486,2	1462,8	536,2	1379,2	592,6	1290,7	656,2	1272,6	669,8
	5	1664,5	448,0	1587,2	492,4	1506,2	542,4	1420,8	598,5	1330,7	661,8	1312,0	675,3
	6	1711,8	454,4	1633,0	498,8	1550,3	548,7	1463,1	604,7	1371,0	667,6	1352,1	681,1
	7	1759,8	460,9	1679,2	505,4	1594,7	555,2	1505,9	611,0	1412,0	673,6	1392,7	687,0
	8	1808,3	467,6	1726,2	512,2	1640,0	561,9	1549,2	617,6	1453,6	680,0	1433,8	693,3
	9	1857,4	474,5	1773,6	519,1	1685,7	568,9	1593,2	624,4	1495,6	686,5	1475,4	699,8
C17	4	1672,4	475,3	1593,1	523,5	1509,9	577,8	1421,9	639,1	1329,0	708,1	1309,7	722,9
	5	1720,1	482,0	1639,1	530,3	1554,1	584,5	1464,5	645,5	1369,7	714,1	1350,0	728,8
	6	1768,3	489,0	1685,8	537,2	1599,1	591,3	1507,5	652,1	1410,8	720,4	1390,7	735,1
	7	1817,2	496,0	1733,1	544,3	1644,4	598,4	1551,1	659,0	1452,5	727,0	1432,0	741,6
	8	1866,8	503,3	1780,8	551,7	1690,4	605,7	1595,3	666,2	1494,6	733,9	1473,8	748,4
	9	1916,8	510,8	1829,2	559,2	1737,0	613,2	1640,0	673,6	1537,3	741,0	1516,2	755,4
C18	4	1755,1	490,8	1673,4	540,7	1587,5	597,0	1497,0	660,5	1401,1	732,1	1381,2	747,5
	5	1805,1	497,6	1721,7	547,5	1634,1	603,7	1541,7	667,0	1444,0	738,2	1423,8	753,5
	6	1855,8	504,5	1770,7	554,5	1681,3	610,6	1586,9	673,7	1487,2	744,6	1466,7	759,8
	7	1906,9	511,7	1820,2	561,7	1729,1	617,8	1632,9	680,7	1531,2	751,2	1510,2	766,3
	8	1959,0	519,0	1870,4	569,1	1777,4	625,1	1679,3	687,8	1575,7	758,1	1554,2	773,2
	9	2011,5	526,5	1921,2	576,7	1826,3	632,7	1726,4	695,3	1620,6	765,3	1598,8	780,3

SYMBOLS

- CC : Cooling capacity (kW)
- PI : Power input for the compressor only (kW)
- LWE : Leaving Water Evaporator (°C)

NOTES

- 1 The power input is for compressor only; cooling cap. and power input referred to evap. fouling factor= 0,0176m² °C/kW



1.11 Capacity tables EWAP-AJYNN/A + OPRN + OPLN

EWAP850-C14AJY
NN/A+OPRN+OPLN

Unit size	LWE	AIR AMBIENT TEMPERATURE (°C)									
		25		30		35		40		42	
		CC	PI	CC	PI	CC	PI	CC	PI	CC	PI
850	4	835,3	244,9	794,2	271,3	750,8	301,7	704,8	336,5	685,7	351,9
	5	859,4	248,3	817,3	274,6	773,0	304,8	726,2	339,4	706,6	354,6
	6	883,7	251,8	840,8	278,1	795,5	308,1	747,7	342,4	727,7	357,5
	7	908,3	255,4	864,4	281,6	818,2	311,5	769,4	345,6	749,1	360,6
	8	933,3	259,1	888,4	285,3	841,3	315,0	791,5	348,9	770,9	363,8
	9	958,4	262,9	912,8	289,1	864,6	318,7	813,9	352,4	792,7	367,1
900	4	932,5	274,7	885,4	302,7	836,1	334,6	784,0	370,8	762,3	386,6
	5	959,3	278,8	911,2	306,8	860,9	338,5	807,6	374,5	785,6	390,2
	6	986,6	283,0	937,5	311,0	886,0	342,6	831,6	378,4	809,1	394,0
	7	1014,1	287,4	964,1	315,3	911,3	346,9	855,9	382,5	833,0	398,0
	8	1042,2	291,9	990,9	319,8	937,2	351,3	880,5	386,7	857,1	402,2
	9	1070,5	296,5	1018,1	324,4	963,2	355,8	905,4	391,1	881,4	406,5
950	4	1004,4	300,9	954,0	330,8	900,8	364,6	845,0	402,6	821,8	419,1
	5	1033,1	305,5	981,5	335,4	927,4	369,1	870,4	407,0	846,6	423,4
	6	1062,0	310,2	1009,4	340,2	954,1	373,8	895,8	411,5	871,6	427,9
	7	1091,4	315,1	1037,5	345,1	981,1	378,6	921,5	416,2	896,9	432,5
	8	1121,1	320,1	1066,2	350,1	1008,4	383,6	947,7	421,1	922,6	437,3
	9	1151,1	325,2	1095,0	355,3	1036,1	388,8	974,2	426,2	948,4	442,3
C10	4	1097,4	332,4	1041,1	365,1	982,1	402,0	919,9	443,6	894,1	461,6
	5	1128,8	337,6	1071,2	370,4	1010,9	407,2	947,5	448,6	921,0	466,5
	6	1160,6	343,0	1101,8	375,8	1040,2	412,5	975,3	453,8	948,3	471,6
	7	1192,7	348,5	1132,7	381,3	1069,8	418,0	1003,5	459,1	976,0	476,9
	8	1225,3	354,1	1164,0	387,0	1099,6	423,7	1032,0	464,7	1003,9	482,4
	9	1258,1	360,0	1195,5	392,9	1129,8	429,5	1060,7	470,4	1032,2	488,1
C11	4	1167,6	360,2	1107,8	396,0	1044,8	436,4	978,6	481,8	951,0	501,5
	5	1200,7	365,8	1139,6	401,7	1075,3	441,9	1007,5	487,2	979,5	506,8
	6	1234,1	371,6	1171,7	407,5	1106,1	447,6	1037,0	492,7	1008,3	512,3
	7	1268,1	377,5	1204,3	413,4	1137,3	453,6	1066,7	498,5	1037,4	518,0
	8	1302,4	383,6	1237,2	419,5	1168,7	459,7	1096,7	504,5	1066,9	523,9
	9	1337,0	389,9	1270,5	425,8	1200,6	465,9	1127,0	510,7	1096,5	530,0
C12	4	1226,2	363,6	1166,8	403,6	1104,1	449,4	1037,5	502,3	1009,8	525,6
	5	1260,9	368,5	1200,4	408,3	1136,3	453,9	1068,5	506,3	1040,3	529,4
	6	1296,3	373,5	1234,2	413,2	1169,1	458,6	1099,8	510,6	1071,0	533,5
	7	1331,8	378,6	1268,7	418,2	1202,1	463,4	1131,6	515,1	1102,2	537,8
	8	1367,9	383,9	1303,6	423,5	1235,6	468,5	1163,7	519,8	1133,7	542,3
	9	1404,4	389,4	1338,7	428,9	1269,4	473,7	1196,1	524,8	1165,5	547,1
C13	4	1327,4	393,7	1261,9	435,1	1192,8	482,4	1120,0	536,5	1089,5	560,2
	5	1365,3	399,3	1298,3	440,7	1227,9	487,8	1153,5	541,4	1122,5	564,9
	6	1403,7	405,0	1335,3	446,4	1263,4	493,3	1187,4	546,6	1155,9	569,9
	7	1442,4	410,9	1372,7	452,2	1299,3	499,0	1221,8	552,1	1189,5	575,2
	8	1481,8	417,0	1410,5	458,3	1335,6	505,0	1256,6	557,7	1223,6	580,7
	9	1521,5	423,3	1448,8	464,6	1372,4	511,1	1291,6	563,6	1258,1	586,5
C14	4	1395,7	419,1	1327,1	462,5	1254,6	511,7	1178,2	567,5	1146,5	591,9
	5	1435,1	425,1	1365,0	468,5	1291,2	517,6	1213,2	573,1	1180,7	597,3
	6	1475,1	431,4	1403,6	474,7	1328,2	523,6	1248,6	578,9	1215,5	603,0
	7	1515,5	437,8	1442,4	481,1	1365,6	529,9	1284,3	585,0	1250,5	608,9
	8	1556,4	444,3	1481,9	487,7	1403,4	536,4	1320,6	591,2	1286,2	615,1
	9	1597,7	451,1	1521,6	494,4	1441,6	543,1	1357,1	597,8	1322,0	621,5

SYMBOLS

CC	:	Cooling capacity (kW)
PI	:	Power input for the compressor only (kW)
LWE	:	Leaving Water Evaporator (°C)

NOTES

- 1 The power input is for compressor only; cooling cap. and power input referred to evap. fouling factor= 0,0176m² °C/kW

1

**EWAPC15-18AJYN
N/A+OPRN+OPLN**

Unit size	LWE	AIR AMBIENT TEMPERATURE (°C)									
		25		30		35		40		42	
		CC	PI	CC	PI	CC	PI	CC	PI	CC	PI
C15	4	1467,1	442,6	1395,4	487,7	1320,0	538,5	1240,3	595,9	1207,2	620,8
	5	1508,4	449,0	1435,2	494,1	1358,2	544,9	1276,9	602,0	1243,0	626,8
	6	1550,2	455,6	1475,4	500,8	1396,8	551,5	1313,9	608,4	1279,3	633,1
	7	1592,3	462,4	1516,1	507,6	1435,8	558,2	1351,2	615,0	1315,9	639,6
	8	1635,0	469,4	1557,2	514,6	1475,4	565,2	1389,0	621,8	1353,0	646,3
	9	1678,2	476,5	1598,8	521,8	1515,2	572,4	1427,1	628,9	1390,5	653,3
C16	4	1558,9	476,2	1481,2	524,3	1399,6	578,6	1313,3	639,7	1277,2	666,3
	5	1602,8	483,3	1523,5	531,4	1440,0	585,6	1352,0	646,5	1315,3	672,9
	6	1647,2	490,6	1566,2	538,8	1481,0	592,9	1391,1	653,6	1353,8	679,9
	7	1692,2	498,1	1609,5	546,3	1522,5	600,3	1430,8	660,9	1392,7	687,1
	8	1737,6	505,8	1653,3	554,1	1564,5	608,1	1470,8	668,5	1431,9	694,6
	9	1783,5	513,7	1697,3	562,1	1606,9	616,0	1511,3	676,3	1471,7	702,3
C17	4	1624,6	503,1	1543,7	554,4	1458,6	612,1	1368,6	677,2	1331,1	705,5
	5	1670,0	510,6	1587,4	561,9	1500,5	619,5	1408,6	684,4	1370,4	712,5
	6	1716,1	518,3	1631,7	569,6	1543,0	627,1	1449,3	691,8	1410,3	719,8
	7	1762,5	526,2	1676,5	577,5	1586,0	635,0	1490,3	699,4	1450,4	727,4
	8	1809,6	534,2	1721,7	585,6	1629,4	643,1	1531,7	707,4	1491,1	735,2
	9	1857,0	542,5	1767,4	594,0	1673,2	651,4	1573,6	715,6	1532,3	743,3
C18	4	1690,2	530,1	1606,3	584,4	1517,6	645,7	1423,9	714,8	1384,8	744,8
	5	1737,3	537,9	1651,5	592,3	1561,1	653,4	1465,4	722,2	1425,5	752,1
	6	1784,8	546,0	1697,2	600,3	1604,9	661,4	1507,3	730,0	1466,7	759,7
	7	1832,9	554,2	1743,5	608,6	1649,3	669,6	1549,8	738,0	1508,3	767,6
	8	1881,5	562,7	1790,2	617,1	1694,1	678,1	1592,7	746,3	1550,4	775,8
	9	1930,5	571,3	1837,5	625,9	1739,6	686,8	1635,9	754,9	1592,9	784,3

SYMBOLS

- CC : Cooling capacity (kW)
- PI : Power input for the compressor only (kW)
- LWE : Leaving Water Evaporator (°C)

NOTES

- 1 The power input is for compressor only; cooling cap. and power input referred to evap. fouling factor= 0,0176m² °C/kW

1.12 Correction Factors

Evaporator fouling factors

The table below gives the evaporator fouling factors.

Fouling factors m ² °C / kW	Cooling capacity correction factor	Power input correction factor	COP correction factor
0.0176	1.000	1.000	1.000
0.0440	0.978	0.986	0.992
0.0880	0.957	0.974	0.983
0.1320	0.938	0.962	0.975

Altitude correction factors

The table below gives the altitude correction factors.

Elevation above sea level (m)	0	300	600	900	1200	1500	1800
Barometric pressure (mbar)	1013	977	942	908	875	843	812
Cooling cap.correction factor	1.000	0.993	0.986	0.979	0.973	0.967	0.960
Power input correction factor	1.000	1.005	1.009	1.015	1.021	1.026	1.031

Ethylene glycol and low ambient temperature correction factors

The table below gives the ethylene glycol and low ambient temperature correction factors.

Air ambient temperature °C	-3	-8	-15	-23	-35
% of ethylene glycol by weight	10	20	30	40	50
Cooling capacity correction factor	0.991	0.982	0.972	0.961	0.946
Power input correction factor	0.996	0.992	0.986	0.976	0.966
Flow rate correction factor	1.013	1.040	1.074	1.121	1.178
Water pressure drops correction factor	1.070	1.129	1.181	1.263	1.308

Low temperature operation performance factors

The table below gives the low temperature operation performance factors.

Ethylene glycol/water leaving temperature °C	2	0	-2	-4	-6	-8
Max air ambient temperature °C (EWAP-AJYNN)	40	39	38	37	36	35
Max air ambient temp. °C / A units	44	43	42	41	40	39
Cooling capacity correction factor	0.842	0.785	0.725	0.670	0.613	0.562
Power input compressors correction factor	0.95	0.94	0.92	0.89	0.87	0.84
Min. % of ethylene glycol	10	20	20	30	30	30

1

1.13 Heat recovery ratings

EWAP-AJYNN&
EWAP-AJYNN/A

Standard unit size	/A unit size		LWPR		
			45	50	55
			HC	HC	HC
800	850	Leaving chilled water temperature 7°C ΔT5°C - Air temperature 35°C	165	133	99
900	900		181	146	108
950	950		197	160	118
C10	C10		212	172	127
C11	C11		228	185	137
C12	C12		247	200	148
C13	C13		263	213	158
C14	C14		279	226	168
C15	C15		295	239	177
C16	C16		311	252	187
C17	C17		326	264	196
C18	C18		342	277	205

SYMBOLS

- HC : Heating capacity (kW)
- LWPR : Leaving desuper-heaters water temperature (°C)

**EWAP800-C14AJY
NN**

Unit size	LWE	LWTR											
		40			45			50			55		
		CC	PI	TRC	CC	PI	TRC	CC	PI	TRC	CC	PI	TRC
800	4	783,8	265,6	1049,4	741,3	296,3	1037,6	696,4	331,7	1028,1	648,9	372,2	1021,1
	5	808,1	267,5	1075,6	764,8	297,9	1062,7	719,1	332,9	1052,0	670,6	372,9	1043,5
	6	832,9	269,5	1102,4	788,8	299,7	1088,5	742,1	334,2	1076,3	692,7	373,7	1066,4
	7	858,1	271,6	1129,7	813,1	301,5	1114,6	765,5	335,7	1101,2	715,2	374,8	1090,0
	8	883,6	273,8	1157,4	837,7	303,5	1141,2	789,3	337,4	1126,7	738,0	376,0	1114,0
	9	909,6	276,2	1185,8	862,8	305,6	1168,4	813,4	339,2	1152,6	761,1	377,4	1138,5
900	4	870,4	291,3	1161,7	823,1	323,4	1146,5	773,2	360,0	1133,2	720,4	401,5	1121,9
	5	897,6	293,7	1191,3	849,3	325,6	1174,9	798,4	361,8	1160,2	744,6	402,9	1147,5
	6	925,2	296,2	1221,4	875,9	327,9	1203,8	824,0	363,8	1187,8	769,1	404,5	1173,6
	7	953,2	298,8	1252,0	903,0	330,3	1233,3	850,0	365,9	1215,9	794,1	406,2	1200,3
	8	981,6	301,5	1283,1	930,4	332,8	1263,2	876,5	368,1	1244,6	819,4	408,1	1227,5
	9	1010,5	304,3	1314,8	958,3	335,4	1293,7	903,3	370,5	1273,8	845,1	410,1	1255,2
950	4	939,5	315,7	1255,2	889,0	349,5	1238,5	835,7	387,6	1223,3	779,3	430,5	1209,8
	5	968,4	318,4	1286,8	917,0	352,0	1269,0	862,6	389,9	1252,5	805,2	432,5	1237,7
	6	997,9	321,3	1319,2	945,4	354,7	1300,1	890,0	392,3	1282,3	831,4	434,6	1266,0
	7	1027,8	324,2	1352,0	974,2	357,5	1331,7	917,8	394,9	1312,7	858,1	436,8	1294,9
	8	1058,1	327,2	1385,3	1003,5	360,4	1363,9	946,0	397,6	1343,6	885,2	439,2	1324,4
	9	1088,9	330,4	1419,3	1033,3	363,4	1396,7	974,6	400,4	1375,0	912,7	441,8	1354,5
C10	4	1024,6	343,9	1368,5	969,2	380,6	1349,8	910,8	421,9	1332,7	849,1	468,5	1317,6
	5	1056,3	346,9	1403,2	999,9	383,4	1383,3	940,3	424,5	1364,8	877,3	470,7	1348,0
	6	1088,5	350,0	1438,5	1030,9	386,3	1417,2	970,2	427,2	1397,4	906,0	473,1	1379,1
	7	1121,2	353,3	1474,5	1062,5	389,4	1451,9	1000,6	430,0	1430,6	935,1	475,6	1410,7
	8	1154,4	356,6	1511,0	1094,6	392,6	1487,2	1031,5	433,0	1464,5	964,7	478,3	1443,0
	9	1188,1	360,1	1548,2	1127,1	396,0	1523,1	1062,8	436,1	1498,9	994,8	481,1	1475,9
C11	4	1091,0	370,3	1461,3	1032,5	410,1	1442,6	970,8	455,0	1425,8	905,4	505,6	1411,0
	5	1124,5	373,5	1498,0	1064,9	413,1	1478,0	1001,9	457,7	1459,6	935,3	507,8	1443,1
	6	1158,5	376,8	1535,3	1097,7	416,2	1513,9	1033,5	460,5	1494,0	965,6	510,3	1475,9
	7	1193,0	380,2	1573,2	1131,0	419,4	1550,4	1065,6	463,5	1529,1	996,4	512,9	1509,3
	8	1228,0	383,7	1611,7	1164,9	422,8	1587,7	1098,2	466,6	1564,8	1027,7	515,7	1543,4
	9	1263,5	387,4	1650,9	1199,2	426,3	1625,5	1131,3	469,9	1601,2	1059,5	518,7	1578,2
C12	4	1145,4	396,1	1541,5	1084,5	442,7	1527,2	1020,0	496,3	1516,3	951,4	557,8	1509,2
	5	1180,4	398,8	1579,2	1118,4	444,9	1563,3	1052,7	497,9	1550,6	982,9	558,6	1541,5
	6	1216,0	401,6	1617,6	1152,8	447,3	1600,1	1085,8	499,7	1585,5	1014,8	559,6	1574,4
	7	1252,2	404,5	1556,7	1187,7	449,9	1637,6	1119,5	501,7	1621,2	1047,1	561,0	1608,1
	8	1288,8	407,6	1696,4	1223,2	452,6	1675,8	1153,7	504,0	1657,7	1080,0	562,5	1642,5
	9	1326,0	410,8	1736,8	1259,2	455,5	1714,7	1188,4	506,4	1694,8	1113,4	564,3	1677,7
C13	4	1278,0	425,4	1703,4	1207,9	472,6	1680,5	1134,1	526,6	1660,7	1056,0	588,1	1644,1
	5	1318,1	428,8	1746,9	1246,6	475,7	1722,3	1171,3	529,1	1700,4	1091,7	589,9	1681,6
	6	1358,9	432,5	1791,4	1286,0	478,9	1764,9	1209,2	531,8	1741,0	1127,9	592,0	1719,9
	7	1400,4	436,2	1836,6	1326,0	482,4	1808,4	1247,6	534,8	1782,4	1164,8	594,3	1759,1
	8	1442,5	440,2	1882,7	1366,6	486,0	1852,6	1286,7	538,0	1824,7	1202,2	597,0	1799,2
	9	1485,3	444,3	1929,6	1407,9	489,9	1897,8	1326,3	541,5	1867,8	1240,2	599,8	1840,0
C14	4	1347,7	449,9	1797,6	1274,4	498,8	1773,2	1197,2	554,2	1751,4	1115,5	617,1	1732,6
	5	1389,7	453,7	1843,4	1315,0	502,2	1817,2	1236,2	557,3	1793,5	1152,9	619,5	1772,4
	6	1432,5	457,6	1890,1	1356,2	505,9	1862,1	1275,8	560,5	1836,3	1190,8	622,2	1813,0
	7	1475,8	461,7	1937,5	1398,1	509,7	1907,8	1316,1	563,9	1880,0	1229,4	625,1	1854,5
	8	1519,9	466,0	1985,9	1440,6	513,8	1954,4	1357,0	567,6	1924,6	1268,7	628,3	1897,0
	9	1564,6	470,4	2035,0	1483,7	518,0	2001,7	1398,5	571,5	1970,0	1308,5	631,6	1940,1

1**SYMBOLS**

CC	:	Cooling capacity (kW)
PI	:	Power input for the compressor only (kW)
TRC	:	Total Heat Recovery Capacity (kW)
LWE	:	Leaving Water Evaporator (°C)
LWTR	:	Leaving Water Total Heat Recovery (°C)

NOTES

- 1 Values are based on:
 - $\Delta T=5^{\circ}\text{C}$ entering/leaving condenser water temperature
 - $\Delta T=5^{\circ}\text{C}$ entering/leaving condenser water temperature and with evap. fouling factor= 0,0176m² °C/kW
 - condenser fouling factor= 0,0440 m² C/kW

**EWAPC15-C18AJY
NN**

Unit size	LWE	LWTR											
		40			45			50			55		
		CC	PI	TRC	CC	PI	TRC	CC	PI	TRC	CC	PI	TRC
C15	4	1417,5	474,3	1891,8	1341,0	524,9	1865,9	1260,3	581,9	1842,2	1175,0	646,2	1821,2
	5	1461,4	478,5	1939,9	1383,3	528,8	1912,1	1301,1	585,4	1886,5	1214,1	649,2	1863,3
	6	1506,0	482,8	1988,8	1426,4	532,8	1959,2	1342,5	589,1	1931,6	1253,8	652,4	1906,2
	7	1551,2	487,2	2038,4	1470,1	537,1	2007,2	1384,6	593,0	1977,6	1294,1	655,9	1950,0
	8	1597,2	491,9	2089,1	1514,5	541,5	2056,0	1427,3	597,2	2024,5	1335,1	659,5	1994,6
	9	1643,9	496,6	2140,5	1559,5	546,1	2105,6	1470,6	601,5	2072,1	1376,7	663,5	2040,2
C16	4	1515,0	503,7	2018,7	1432,5	557,0	1989,5	1345,5	617,1	1962,6	1253,6	684,9	1938,5
	5	1562,3	508,2	2070,5	1478,1	561,2	2039,3	1389,3	621,0	2010,3	1295,6	688,2	1983,8
	6	1610,3	512,9	2123,2	1524,4	565,7	2090,1	1433,9	625,0	2058,9	1338,2	691,7	2029,9
	7	1659,1	517,8	2176,9	1571,4	570,3	2141,7	1479,1	629,3	2108,4	1381,6	695,5	2077,1
	8	1708,6	522,8	2231,4	1619,2	575,1	2194,3	1525,1	633,8	2158,9	1425,6	699,6	2125,2
	9	1758,9	528,0	2286,9	1667,7	580,2	2247,9	1571,1	638,5	2210,2	1470,4	703,9	2174,3
C17	4	1582,5	530,2	2112,7	1496,7	586,6	2083,3	1406,3	650,3	2056,6	1310,6	722,0	2032,6
	5	1631,6	534,9	2166,5	1544,1	591,0	2135,1	1451,8	654,2	2106,0	1354,3	725,4	2079,7
	6	1681,4	539,8	2221,2	1592,2	595,6	2187,8	1498,1	658,4	2156,5	1398,7	729,0	2127,7
	7	1732,0	544,8	2276,8	1641,0	600,4	2241,4	1545,1	662,9	2208,0	1443,7	733,0	2176,7
	8	1783,4	550,0	2333,4	1690,6	605,4	2296,0	1592,9	667,5	2260,4	1489,5	737,1	2226,6
	9	1835,6	555,4	2391,0	1741,0	610,6	2351,6	1641,3	672,4	2313,7	1536,0	741,6	2277,6
C18	4	1649,9	556,8	2206,7	1560,9	616,3	2177,2	1467,1	683,4	2150,5	1367,7	759,1	2126,8
	5	1700,8	561,6	2262,4	1610,1	620,8	2230,9	1514,3	687,5	2201,8	1413,1	762,6	2175,7
	6	1752,5	566,6	2319,1	1660,0	625,5	2285,5	1562,4	691,8	2254,2	1459,1	766,3	2225,4
	7	1804,9	571,8	2376,7	1710,6	630,5	2341,1	1611,1	696,4	2307,5	1505,9	770,4	2276,3
	8	1858,2	577,2	2435,4	1762,1	635,7	2397,8	1660,6	701,2	2361,8	1553,4	774,7	2328,1
	9	1912,2	582,8	2495,0	1814,2	641,0	2455,2	1710,9	706,3	2417,2	1601,6	779,3	2380,9

1**SYMBOLS**

CC	:	Cooling capacity (kW)
PI	:	Power input for the compressor only (kW)
TRC	:	Total Heat Recovery Capacity (kW)
LWE	:	Leaving Water Evaporator (°C)
LWTR	:	Leaving Water Total Heat Recovery (°C)

NOTES

- 1 Values are based on:
 - $\Delta T=5^{\circ}\text{C}$ entering/leaving condenser water temperature
 - $\Delta T=5^{\circ}\text{C}$ entering/leaving condenser water temperature and with evap. fouling factor= 0,0176m² °C/kW
 - condenser fouling factor= 0,0440 m² °C/kW

EWAP850-C14AJY
NN/AC15-C18?zie
blad?

Unit size	LWE	LWTR											
		40			45			50			55		
		CC	PI	TRC	CC	PI	TRC	CC	PI	TRC	CC	PI	TRC
850	4	801,4	267,0	1068,4	757,3	297,4	1054,7	710,7	332,4	1043,1	661,5	372,6	1034,1
	5	826,7	269,0	1095,7	781,7	299,2	1080,9	734,2	333,7	1067,9	683,9	373,4	1057,3
	6	852,5	271,2	1123,7	806,5	301,0	1107,5	758,0	335,2	1093,2	706,8	374,4	1081,2
	7	878,6	273,4	1152,0	831,7	303,0	1134,7	782,3	336,9	1119,2	730,0	375,5	1105,5
	8	905,2	275,8	1181,0	857,3	305,2	1162,5	806,9	338,7	1145,6	753,6	376,9	1130,5
	9	932,2	278,2	1210,4	883,3	307,4	1190,7	831,9	340,6	1172,5	777,6	378,4	1156,0
900	4	900,5	294,0	1194,5	850,2	325,7	1175,9	797,4	361,8	1159,2	741,6	402,8	1144,4
	5	929,2	296,6	1225,8	877,9	328,1	1206,0	824,0	363,8	1187,8	767,0	404,4	1171,4
	6	958,5	299,3	1257,8	906,1	330,6	1236,7	851,0	366,0	1217,0	792,9	406,1	1199,0
	7	988,2	302,1	1290,3	934,7	333,2	1267,9	878,4	368,3	1246,7	819,1	408,1	1227,2
	8	1018,4	305,1	1323,5	963,8	336,0	1299,8	906,4	370,8	1277,2	845,9	410,2	1256,1
	9	1049,1	308,2	1357,3	993,3	338,9	1332,2	934,7	373,5	1308,2	873,0	412,5	1285,5
950	4	974,4	319,0	1293,4	920,5	352,4	1272,9	863,9	390,0	1253,9	804,2	432,4	1236,6
	5	1005,2	322,0	1327,2	950,2	355,1	1305,3	892,4	392,5	1284,9	831,5	434,6	1266,1
	6	1036,5	325,1	1361,6	980,4	358,1	1338,5	921,4	395,2	1316,6	859,2	436,9	1296,1
	7	1068,3	328,3	1396,6	1011,0	361,1	1372,1	950,8	398,0	1348,8	887,4	439,4	1326,8
	8	1100,6	331,6	1432,2	1042,2	364,3	1406,5	980,7	401,0	1381,7	916,0	442,1	1358,1
	9	1133,4	335,0	1468,4	1073,8	367,6	1441,4	1011,1	404,1	1415,2	945,1	445,0	1390,1
C10	4	1070,4	348,3	1418,7	1010,6	384,4	1395,0	947,8	425,1	1372,9	881,5	471,0	1352,5
	5	1104,6	351,6	1456,2	1043,5	387,5	1431,0	979,3	428,0	1407,3	911,6	473,5	1385,1
	6	1139,3	355,1	1494,4	1076,9	390,8	1467,7	1011,3	431,0	1442,3	942,3	476,2	1418,5
	7	1174,6	358,7	1533,3	1110,8	394,3	1505,1	1043,9	434,2	1478,1	973,4	479,1	1452,5
	8	1210,4	362,4	1572,8	1145,4	397,9	1543,3	1077,0	437,6	1514,6	1005,1	482,1	1487,2
	9	1246,8	366,3	1613,1	1180,4	401,6	1582,0	1110,7	441,1	1551,8	1037,3	485,3	1522,6
C11	4	1143,0	375,3	1518,3	1079,5	414,4	1493,9	1012,8	458,6	1471,4	942,4	508,4	1450,8
	5	1179,1	378,8	1557,9	1114,4	417,8	1532,2	1046,2	461,6	1507,8	974,4	511,0	1485,4
	6	1215,9	382,5	1598,4	1149,8	421,3	1571,1	1080,2	464,8	1545,0	1006,9	513,8	1520,7
	7	1253,3	386,3	1639,6	1185,8	424,9	1610,7	1114,8	468,2	1583,0	1040,0	516,9	1556,9
	8	1291,2	390,3	1681,5	1222,3	428,7	1651,0	1149,9	471,8	1621,7	1073,5	520,1	1593,6
	9	1329,8	394,3	1724,1	1259,4	432,6	1692,0	1185,5	475,5	1661,0	1107,7	523,5	1631,2
C12	4	1175,2	398,4	1573,6	1111,6	444,5	1556,1	1044,3	497,5	1541,8	973,0	558,3	1531,3
	5	1211,8	401,2	1613,0	1146,9	446,9	1593,8	1078,3	499,3	1577,6	1005,6	559,3	1564,9
	6	1248,9	404,2	1653,1	1182,7	449,5	1632,2	1112,8	501,3	1614,1	1038,7	560,6	1599,3
	7	1286,6	407,4	1694,0	1219,2	452,3	1671,5	1147,9	503,6	1651,5	1072,4	562,1	1634,5
	8	1324,9	410,7	1735,6	1256,1	455,2	1711,3	1183,5	506,0	1689,5	1106,6	564,0	1670,6
	9	1363,8	414,2	1778,0	1293,7	458,4	1752,1	1219,7	508,7	1728,4	1141,3	566,0	1707,3
C13	4	1278,0	425,4	1703,4	1207,9	472,6	1680,5	1134,1	526,6	1660,7	1056,0	588,1	1644,1
	5	1318,1	428,8	1746,9	1246,6	475,7	1722,3	1171,3	529,1	1700,4	1091,7	589,9	1681,6
	6	1358,9	432,5	1791,4	1286,0	478,9	1764,9	1209,2	531,8	1741,0	1127,9	592,0	1719,9
	7	1400,4	436,2	1836,6	1326,0	482,4	1808,4	1247,6	534,8	1782,4	1164,8	594,3	1759,1
	8	1442,5	440,2	1882,7	1366,6	486,0	1852,6	1286,7	538,0	1824,7	1202,2	597,0	1799,2
	9	1485,3	444,3	1929,6	1407,9	489,9	1897,8	1326,3	541,5	1867,8	1240,2	599,8	1840,0
C14	4	1347,7	449,9	1797,6	1274,4	498,8	1773,2	1197,2	554,2	1751,4	1115,5	617,1	1732,6
	5	1389,7	453,7	1843,4	1315,0	502,2	1817,2	1236,2	557,3	1793,5	1152,9	619,5	1772,4
	6	1432,5	457,6	1890,1	1356,2	505,9	1862,1	1275,8	560,5	1836,3	1190,8	622,2	1813,0
	7	1475,8	461,7	1937,5	1398,1	509,7	1907,8	1316,1	563,9	1880,0	1229,4	625,1	1854,5
	8	1519,9	466,0	1985,9	1440,6	513,8	1954,4	1357,0	567,6	1924,6	1268,7	628,3	1897,0
	9	1564,6	470,4	2035,0	1483,7	518,0	2001,7	1398,5	571,5	1970,0	1308,5	631,6	1940,1

1**SYMBOLS**

CC	:	Cooling capacity (kW)
PI	:	Power input for the compressor only (kW)
TRC	:	Total Heat Recovery Capacity (kW)
LWE	:	Leaving Water Evaporator (°C)
LWTR	:	Leaving Water Total Heat Recovery (°C)

NOTES

- 1 Values are based on:
 - $\Delta T=5^{\circ}\text{C}$ entering/leaving condenser water temperature
 - $\Delta T=5^{\circ}\text{C}$ entering/leaving condenser water temperature and with evap. fouling factor= 0,0176m² °C/kW
 - condenser fouling factor= 0,0440 m² °C/kW

1.14 Sound level data

EWAP-AJYNN & EWAP-AJYNN/A

Standard unit size	/A unit size	Sound pressure level at 1m from the unit in free field (rif. 2×10^{-5})								
		63 Hz	125 Hz	250Hz	500Hz	1000H z	2000 Hz	4000 Hz	8000 Hz	dBa
800	850	78,5	79,0	80,5	76,5	76,0	73,0	64,5	56,0	80,5
900	900	78,5	79,0	80,5	76,5	76,0	73,0	64,5	55,5	80,5
950	950	79,0	78,5	81,0	77,0	76,0	74,0	66,0	56,5	81,0
C10	C10	78,0	78,5	80,5	77,5	76,5	73,0	65,0	57,0	81,0
C11	C11	78,5	79,0	80,5	78,0	77,0	73,0	64,5	56,0	81,0
C12	C12	78,5	79,0	80,5	78,0	77,0	73,0	64,5	56,0	81,0
C13	C13	79,0	79,0	81,0	78,5	77,0	73,5	64,5	56,5	81,5
C14	C14	79,5	79,5	81,5	79,0	76,5	73,5	65,0	57,0	81,5
C15	C15	79,5	80,0	81,5	79,5	76,5	73,0	66,0	58,0	81,5
C16	C16	79,0	81,0	81,5	79,5	76,5	73,5	65,5	57,5	81,5
C17		79,0	81,5	82,0	79,5	76,5	73,5	66,0	58,0	81,5
C18		79,0	81,5	81,5	79,0	76,5	73,5	66,0	57,5	81,5

EWAP-AJYNN & EWAP-AJYNN/A + OPRN

Standard unit size	/A unit size	Sound pressure level at 1m from the unit in free field (rif. 2×10^{-5})								
		63 Hz	125 Hz	250Hz	500Hz	1000H z	2000 Hz	4000 Hz	8000 Hz	dBa
800	850	74,5	71,5	74,5	71,5	70,0	67,5	58,5	51,5	75,0
900	900	75,0	72,0	74,5	71,5	70,5	67,5	59,0	51,5	75,0
950	950	75,5	72,5	75,0	72,0	71,0	67,5	59,5	52,0	75,5
C10	C10	75,5	73,0	75,5	72,5	71,0	69,0	59,5	52,5	76,0
C11	C11	76,0	73,0	76,0	72,5	71,0	69,0	60,0	53,0	76,0
C12	C12	77,0	73,5	76,5	73,0	71,5	69,0	60,5	53,5	76,5
C13	C13	77,5	73,0	76,0	73,0	71,5	69,0	60,5	53,0	76,0
C14	C14	77,5	73,5	75,5	73,5	71,0	69,0	60,5	53,0	76,0
C15	C15	78,0	74,0	75,5	73,5	71,5	69,5	60,5	54,0	76,5
C16	C16	78,0	74,5	76,0	73,5	72,0	69,5	60,0	53,5	76,5
C17		78,5	75,0	76,0	73,5	72,5	69,5	60,5	54,0	77,0
C18		78,5	75,5	76,5	74,0	72,5	69,5	60,5	54,5	77,0

EWAP-AJYNN & EWAP-AJYNN/A + OPLN

Standard unit size	/A unit size	Sound pressure level at 1m from the unit in free field (rif. 2×10^{-5})								
		63 Hz	125 Hz	250Hz	500Hz	1000H z	2000 Hz	4000 Hz	8000 Hz	dBa
800	850	76,0	73,5	73,0	70,5	67,5	62,5	55,5	47,5	72,5
900	900	76,0	73,5	73,0	70,5	67,5	62,5	55,5	47,5	72,5
950	950	76,0	74,0	73,0	70,5	67,5	63,0	55,5	47,5	72,5
C10	C10	76,0	74,0	73,5	70,5	67,5	63,0	55,5	47,5	72,5
C11	C11	76,0	74,0	73,5	71,0	67,5	63,0	56,0	48,0	72,5
C12	C12	76,5	74,5	74,0	71,0	68,0	63,5	55,5	47,5	73,0
C13	C13	76,0	74,0	73,0	70,5	67,5	63,0	55,5	47,5	72,5
C14	C14	77,0	75,0	74,0	71,0	68,0	63,5	56,0	48,0	73,0
C15	C15	77,5	75,5	74,0	71,0	68,0	63,5	56,0	48,5	73,0

1

C16	C16	78,0	76,0	73,5	71,0	68,5	63,5	57,0	49,0	73,0
C17		77,5	75,5	74,5	71,5	68,0	63,5	57,5	49,0	73,5
C18		78,0	75,0	74,5	72,0	68,0	64,0	57,0	49,5	73,5

NOTE

- 1 Average sound pressure level rated in accordance to ISO 3744, free field semispheric conditions.
- 2 Sound pressure levels are referred to EWAP-AJYNN Units furnished without water pump and/or high lift fans.

Part 2

Functional Description

Introduction

This part gives more detailed information about the functions and controls of the unit. This information is used as background information for troubleshooting. An extensive overview of the functioning of the controller is also given in this part. Knowledge of the controller is essential to gather information prior to servicing and troubleshooting.

What is in this part?

This part contains the following chapters:

Chapter	See page
1 Operation Range	2-3
2 The Digital Controller	2-13
3 Functional Control	2-77

2

1 Operation Range

1.1 What Is in This Chapter?

Introduction

This chapter contains information about the functions used to control the system. Understanding these functions is vital when diagnosing a malfunction that is related to the functional control.

Overview

This chapter contains the following topics:

Topic	See page
1.2 Operational Range: EWAP-AJYNN	2-4
1.3 Operational Range: EWAP-AJYNN with option OPRN/OPLN	2-6
1.4 Operational Range: EWAP-AJYNN/A	2-8
1.5 Operational Range: EWAP-AJYNN/A with option OPRN/OPLN	2-10

1.2 Operational Range: EWAP-AJYNN

Operational range

The illustration below shows the operational range of EWAP-AJYNN.

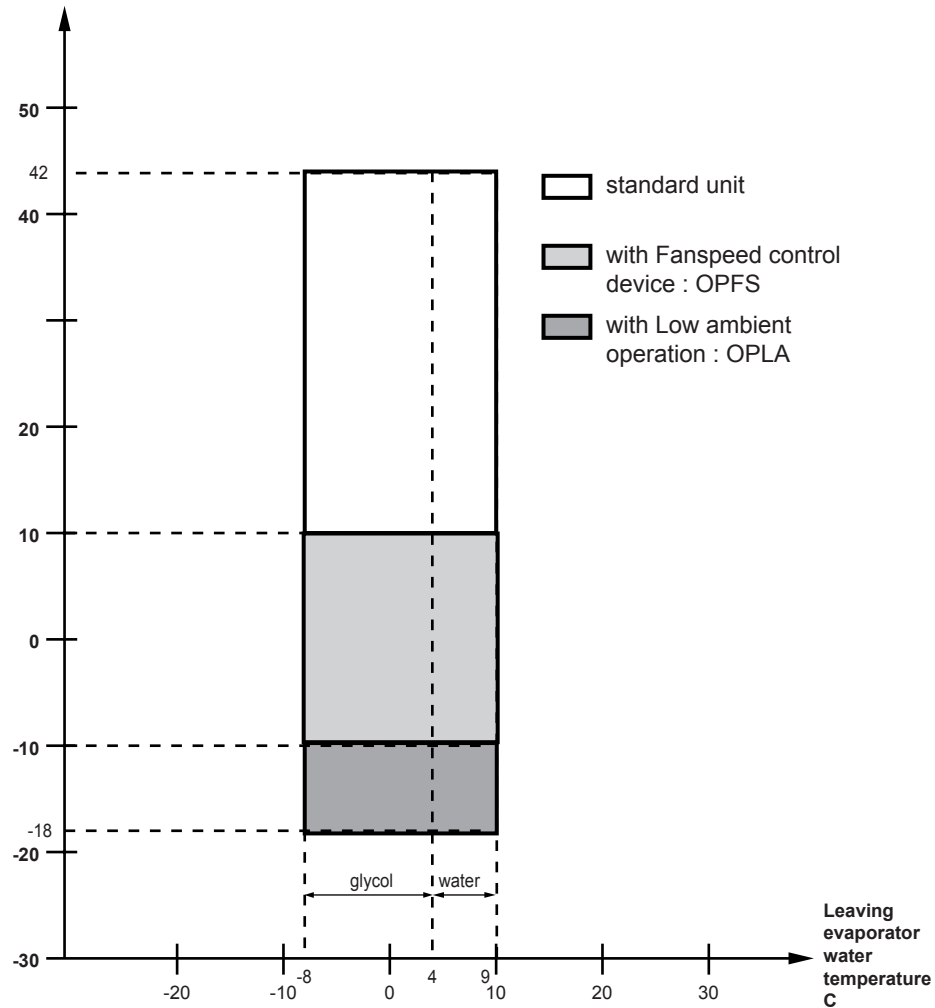

Unit version	EWAP-AJYNN
Max ambient temperature (1)	42°C
Min ambient temperature	+10°C (2)
Max leaving evaporator water temperature	+10°C
Min leaving evaporator water temperature (without glycol)	+4°C
Min leaving evaporator water temperature (with glycol)	-8°C
Max evaporator ΔT	6°C
Min evaporator ΔT	4°C

Notes

(1) The max ambient temperature refers to units working at full load. With higher temperatures the chillers will unload.

(2) When the air temperature is lower than +10°C, the fan speed control device (OPFS) should be used. It allows the unit to work with air temperature down to -10°C. Low ambient operation (OPLA) allows it to reach -18°C.

1.3 Operational Range: EWAP-AJYNN with option OPRN/OPLN

Operational range

The illustration below shows the operational range of EWAP-AJYNN with option OPRN and EWAP-AJYNN with option OPLN.

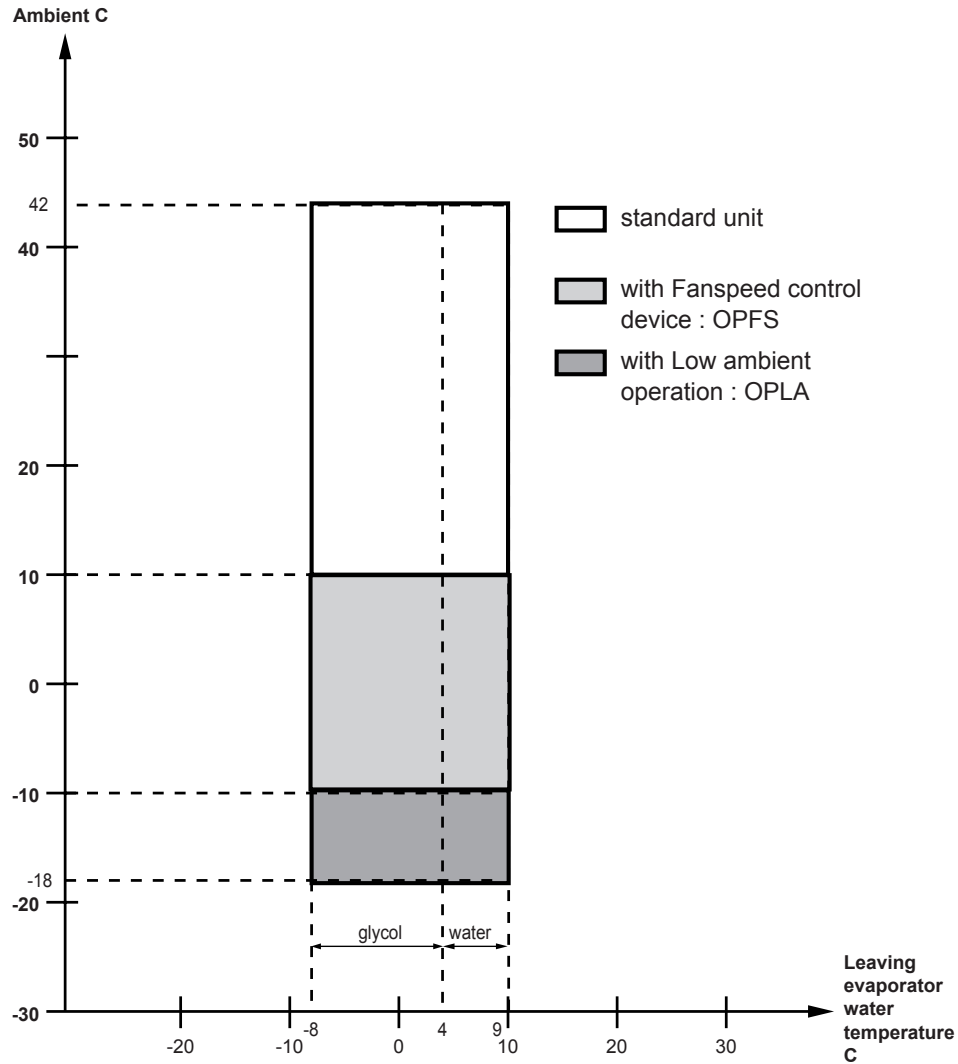

Unit version	EWAP-AJYNN(OPRN-OPLN)
Max ambient temperature (1)	38°C
Min ambient temperature	+10°C (2)
Max leaving evaporator water temperature	+10°C
Min leaving evaporator water temperature (without glycol)	+4°C
Min leaving evaporator water temperature (with glycol)	-8°C
Max evaporator ΔT	6°C
Min evaporator ΔT	4°C

Notes

(1) The max ambient temperature refers to units working at full load. With higher temperatures the chillers will unload.

(2) When the air temperature is lower than +10°C, the fan speed control device (OPFS) should be used. It allows the unit to work with air temperature down to -10°C. Low ambient operation (OPLA) allows it to reach -18°C.

1.4 Operational Range: EWAP-AJYNN/A

Operational range

The illustration below shows the operational range of EWAP-AJYNN/A.

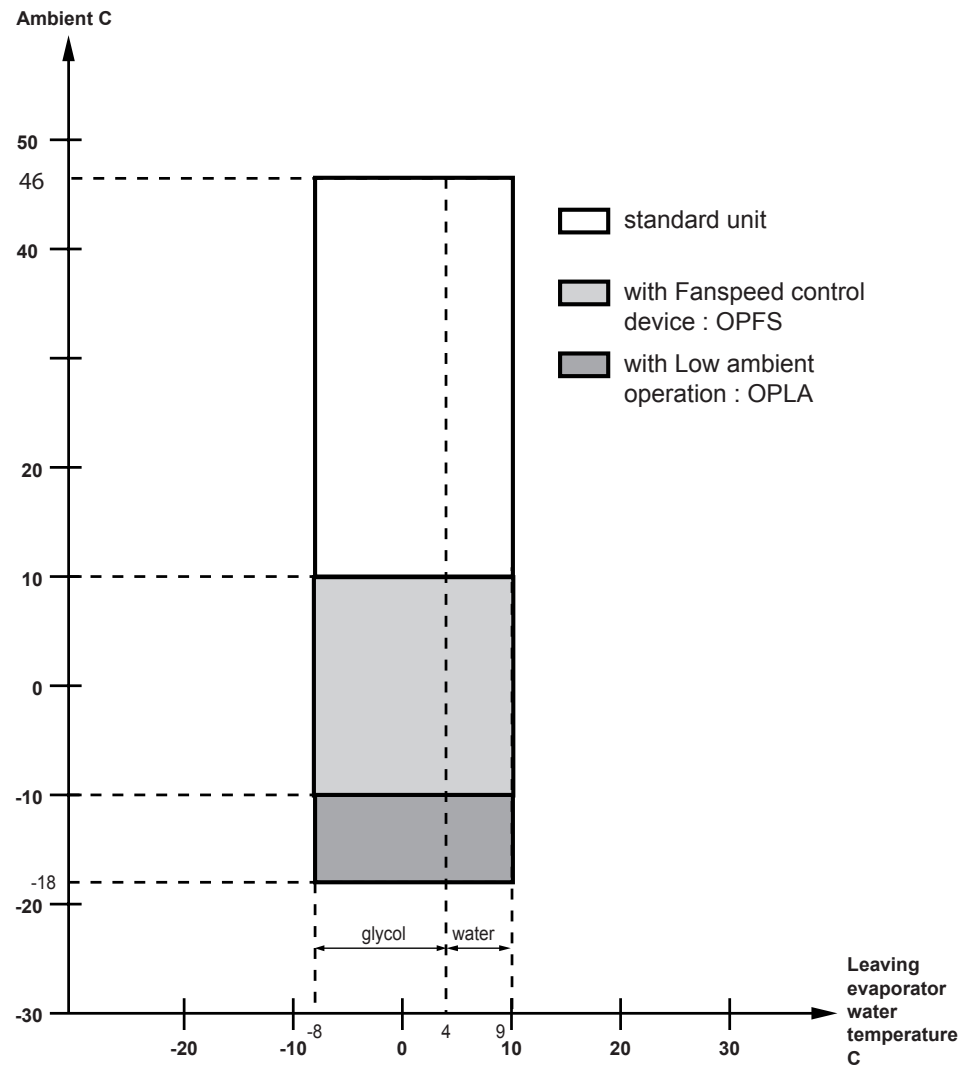

Unit version	EWAP-AJYNN/A
Max ambient temperature (1)	46°C
Min ambient temperature	+10°C (2)
Max leaving evaporator water temperature	+10°C
Min leaving evaporator water temperature (without glycol)	+4°C
Min leaving evaporator water temperature (with glycol)	-8°C
Max evaporator ΔT	6°C
Min evaporator ΔT	4°C

Notes

(1) The max ambient temperature refers to units working at full load. With higher temperatures the chillers will unload.

(2) When the air temperature is higher than +10°C, the fan speed control device (OPFS) should be used. It allows the unit to work with air temperature down to -10°C. Low ambient operation (OPLA) allows it to reach -18°C.

1.5 Operational Range: EWAP-AJYNN/A with option OPRN/OPLN

Operational range

The illustration below shows the operational range of EWAP-AJYNN/A with option OPRN and EWAP-AJYNN/A with option OPLN.

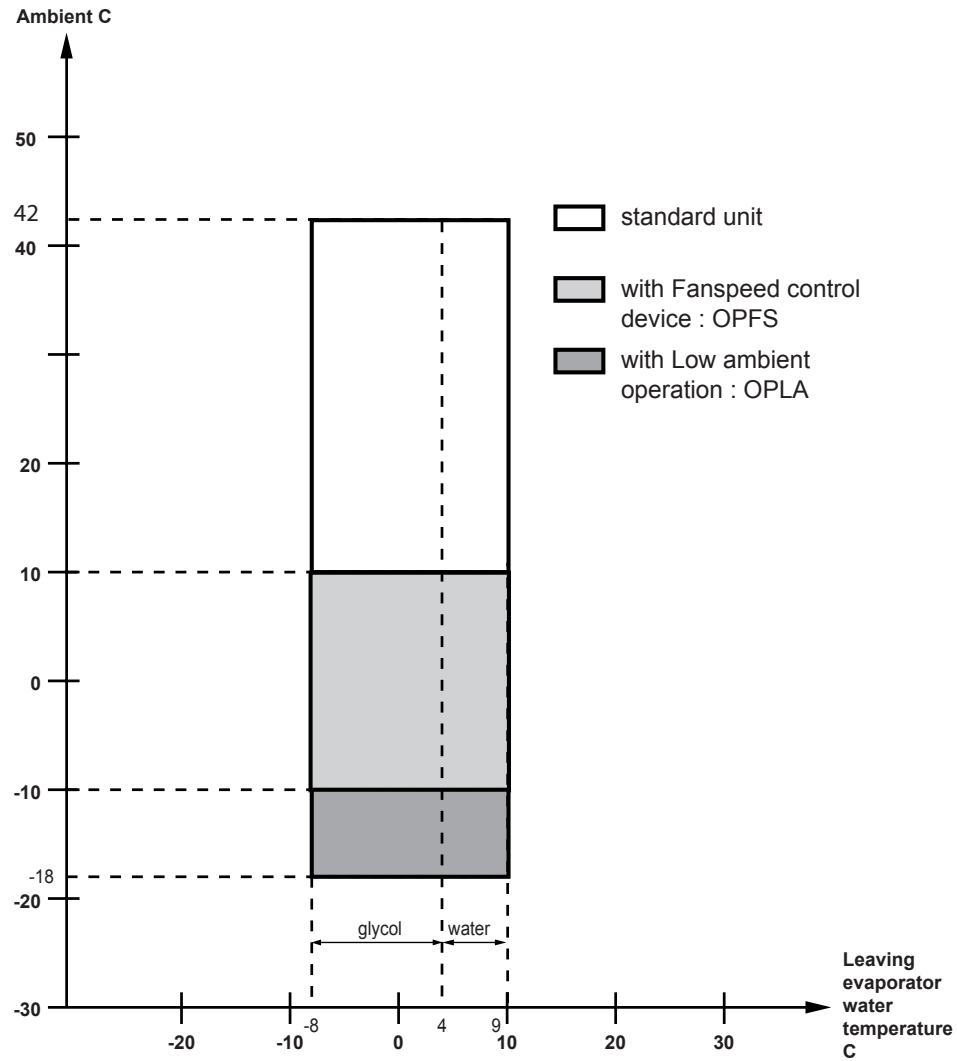

Unit version	EWAP-AJYNN/A (OPRN-OPLN)
Max ambient temperature (1)	42°C
Min ambient temperature	+10°C (2)
Max leaving evaporator water temperature	+10°C
Min leaving evaporator water temperature (without glycol)	+4°C
Min leaving evaporator water temperature (with glycol)	-8°C
Max evaporator ΔT	6°C
Min evaporator ΔT	4°C

Notes

(1) The max ambient temperature refers to units working at full load. With higher temperatures the chillers will unload.

(2) When the air temperature is lower than +10°C, the fan speed control device (OPFS) should be used. It allows the unit to work with air temperature down to -10°C. Low ambient operation (OPLA) allows it to reach -18°C.

2

2 The Digital Controller

2

2.1 What Is in This Chapter?

Introduction

This chapter gives more detailed information about the controller and the software. Understanding these functions is vital when diagnosing a malfunction which is related to system architecture or software.

Overview

This chapter contains the following topics:

Topic	See page
2.2 System Architecture	2–14
2.3 Customer Interfaces	2–15
2.4 Display and Keypad	2–24

2.2 System Architecture

General description

The Microtech II C Plus control panel contains a microprocessor based controller which provides all monitoring and control functions required for a safe, efficient operation of the Chiller. The operator can monitor all operating conditions by using the panels built in a 4 line by 20 character keypad/display or by using an IBM compatible computer running MicroPlant monitor software release 2.0 and later. In addition to providing all normal operating controls, the PlantVisor 1.0 controller monitors all safety devices on the unit and will take corrective action if the chiller is operating off it's normal design conditions. If a fault condition develops, the controller will shut the system down and activate an alarm output. Important operating conditions at the time an alarm condition occurs are retained in the controller's memory to aid in troubleshooting and fault analysis.

The system is protected by a password scheme which only allows access by authorized personnel. A password must be entered into the panel keypad by the operator before any configuration may be altered.

Flow chart

The system architecture is based on the use of one PCO² Carel controller to manage two compressors. An additional PCO^e expansion board is used to manage the economizer when required.

The system is able to control units equipped with an electronic expansion valve. In this case the use of an electronic Carel Driver for each valve is required.

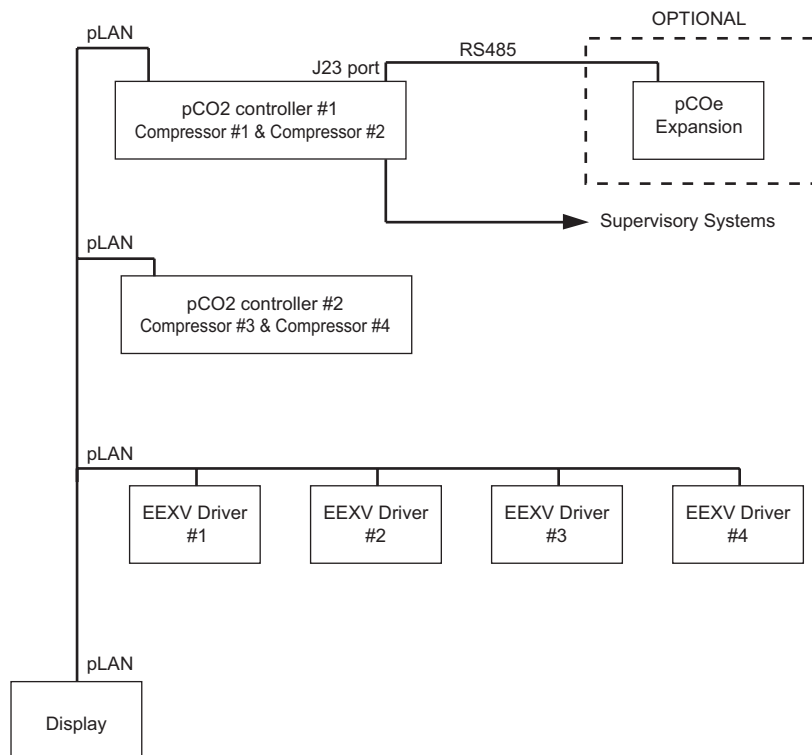

2.3 Customer Interfaces

Overview

This chapter contains the following topics:

Topic	See page
2.3.1 Control Panel	2–15
2.3.2 Main board	2–16
2.3.3 EEXV Valve Driver	2–18
2.3.4 Meaning of the Driver EEXV Status LEDs	2–20
2.3.5 pCO Expansion	2–21
2.3.6 Addressing of plan/RS485	2–23

2.3.1 Control Panel

General description

The Control Panel is constituted by the backlight display 4 line by 20 character and by the 15 key keypad whose functions will be illustrated in “2.4–Display and Keypad”.

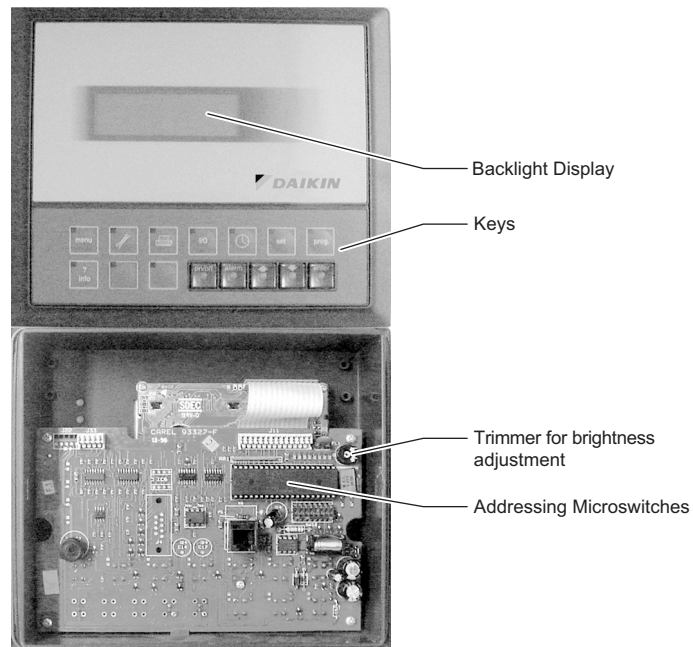

2.3.2 Main board

General description The control board contains the hardware and the software necessary to monitor and to control the unit.

The figure below shows the main board:

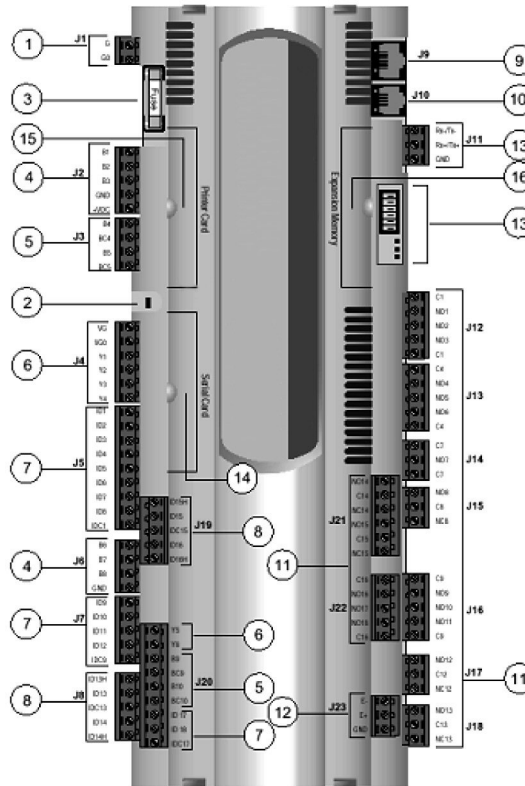

1	Power supply G (+), G0 (-)
2	Status LED
3	Fuse 250Vac
4	Universal analog inputs (NTC, 0/1V, 0/10V, 0/20mA, 4/20mA)
5	Passive analog inputs (NTC, PT1000, On- Off)
6	Analog outputs 0/10V
7	24Vac/Vdc Digital inputs
8	230Vac or 24Vac/Vdc Digital inputs
9	Synoptic terminal connection
10	Standard terminal (and program download) connector
11	Digital outputs (relays)
12	Expansion board connection
13	pLAN connection and microswitches
14	Serial card connection
15	Printer card connection
16	Memory expansion connection

pLAN addressing
microswitches

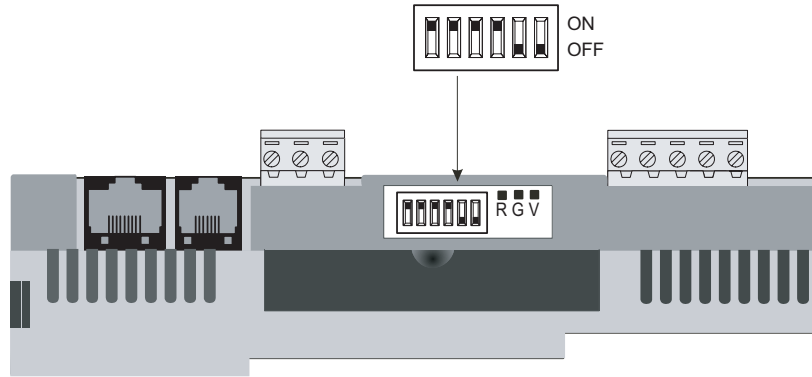

2.3.3 EEXV Valve Driver

General description

The valve drivers contain the software for the control of the electronic expansion valve and are connected to the battery group, which provides the power to close the valve in case of a power failure.

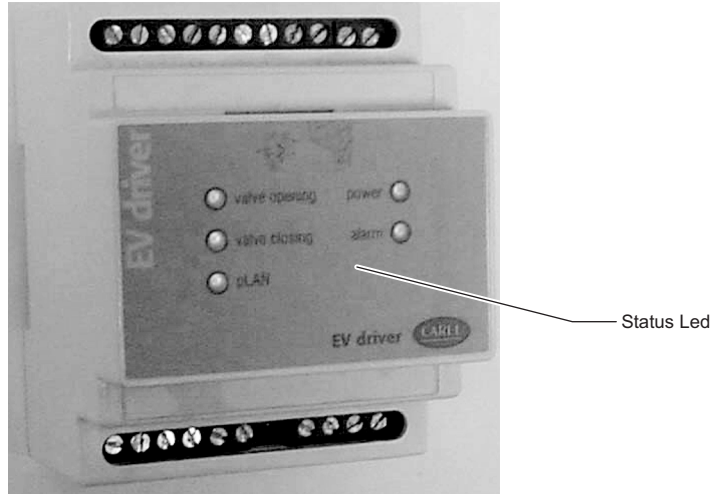

Inside view driver

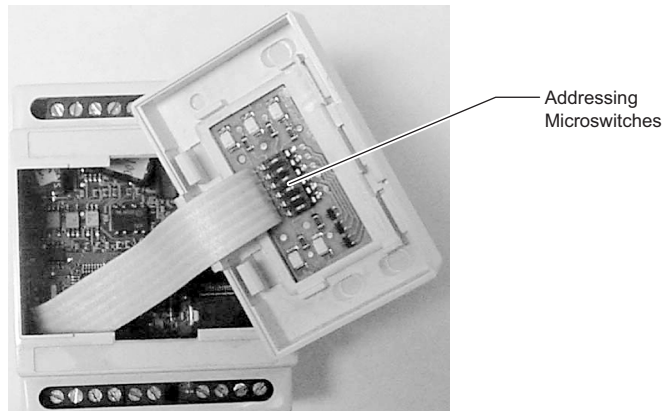

Battery assembly

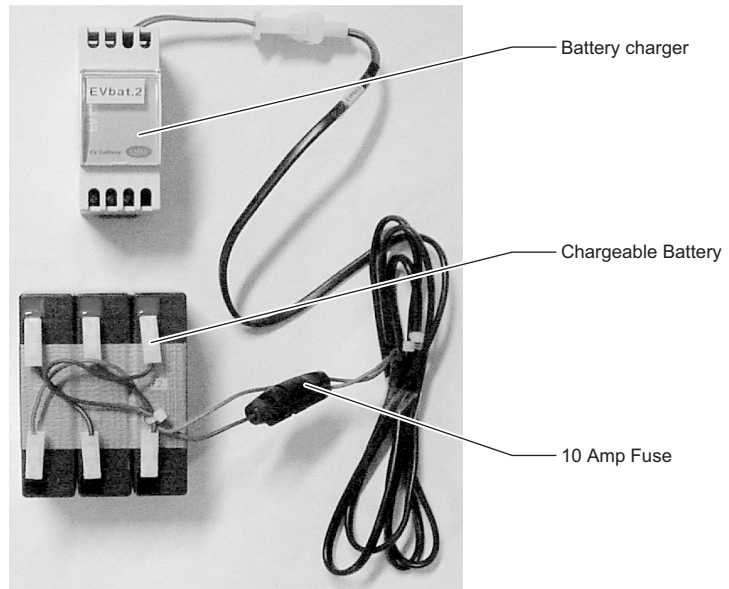

2.3.4 Meaning of the Driver EEXV Status LEDs

Normal conditions

Under normal conditions five(5) LED indicates:

- POWER: (yellow) Remains On in presence of supply. Remains Off in case of battery operation
- OPEN: (green) Flashing during the valve opening. On when valve is fully open.
- CLOSE: (green) Flashing during the valve closing. On when valve is fully close.
- Alarm: (red) On or flashing in case of hardware alarm.
- pLAN: (green) On during the normal working of pLAN.

Alarm situations

In presence of critical alarm situations, the combination of the LED's will identify the alarm as shown below. In case more than one alarm is present, the alarm with the highest priority will be visualized. Highest priority is level 7.

Alarms that stop the system	PRIORITY	LED OPEN	LED CLOSE	LED POWER	LED ALARM
Eprom reading error	7	Off	Off	On	Flashing
Valve open in case of lack of supply	6	Flashing	Flashing	On	Flashing
At start up, wait for battery loading (parameter.....)	5	Off	On	Flashing	Flashing
Other alarms	PRIORITY	LED OPEN	LED CLOSE	LED POWER	LED ERROR
Motor connection error	4	Flashing	Flashing	On	On
Probe error	3	Off	Flashing	On	On
Eeprom writing error	2	-	-	On	On
Battery error	1	-	-	Flashing	On
pLAN		LED pLAN			
Connection OK		On			
Driver connection or address error = 0		Off			

2.3.5 pCO Expansion

Carel expansion board

The introduction of the Economizer functionality in the software requires the use of Carel expansion board shown in the figure below.

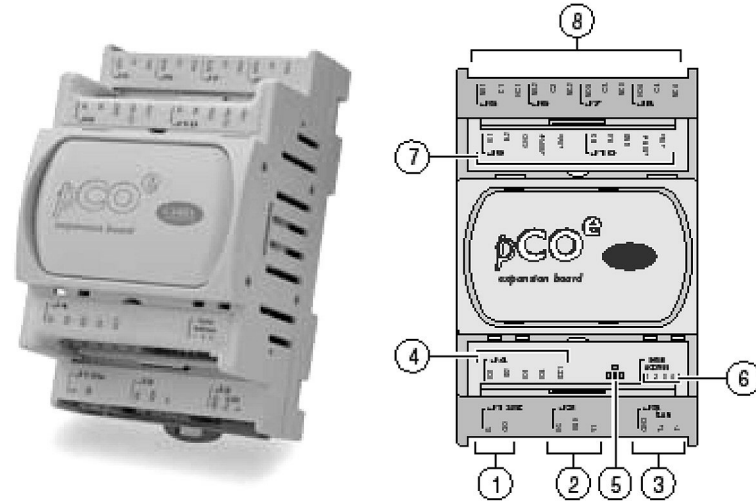

1	Power supply connector (G(+), G0 (-))
2	Analogue output 0 to 10 V
3	Network connector for expansions in RS485 (GND, T+, T-) or tLAN (GND, T+)
4	24 Vac/Vdc digital inputs
5	Yellow LED showing power supply voltage and 3 signalling LEDs
6	Serial address
7	Analogue inputs and probe supply
8	Relay digital outputs

This device needs to be addressed to ensure correct communication with the controller via RS485 protocol. Addressing microswitches are placed nearby status LEDs (refer to key 6 in the figure above). Once the address is correctly set, the expansion could be linked with PCO² board #1. The correct connection is achieved connecting J23 pin on board #1 with J3 pin on the expansion board (note that the expansion board connector is different from the controller one, but the wires must be placed in the same positions of connectors). Expansion boards are only I/O extensions for the controller and don't need any software.

**Expansion board
lan setup details**

2

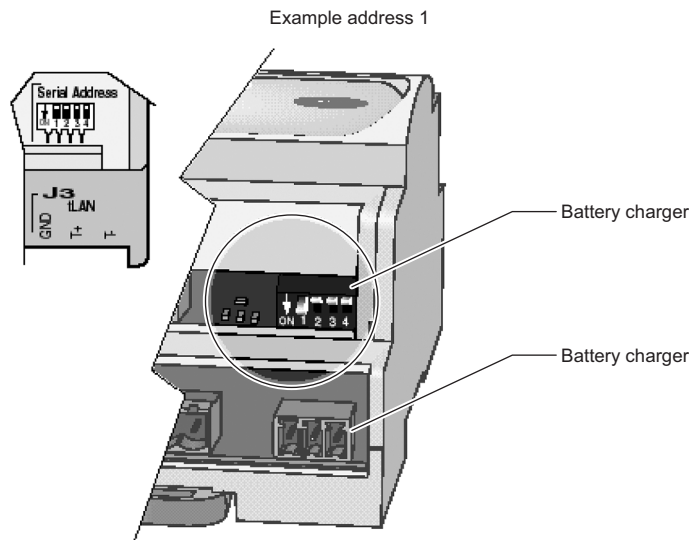

As shown in the figure above, expansion boards have only four microswitches to set the net address. For more details on microswitches configuration refer to "2.3.6–Addressing of plan/RS485".

Status LEDs

Three status LEDs are present, their status represents different statuses of the expansion board.

RED	YELLOW	GREEN	Meaning
-	-	ON	Active CAREL/tLAN supervisor protocol
-	ON	-	Probe error
ON	-	-	"I/O mis-match" error caused by the inhibition matrix
flashing	-	-	Lack of communication
-	-	-	Waiting for the system startup by the master (max. 30 s)

2.3.6 Addressing of plan/RS485

To get the correct functionality of the pLAN net system, it is necessary to address all the installed components correctly. Each component, as previously described, has a series of microswitches that must be set as specified in the following table.

pLAN component	Microswitch					
	1	2	3	4	5	6
Local DISPLAY	ON	ON	ON	OFF	OF	OFF
Remote DISPLAY (if available)	OFF	OFF	OFF	ON	OFF	OFF
COMP. BOARD #1	ON	OFF	OFF	OFF	OFF	OFF
COMP. BOARD #2	OFF	ON	OFF	OFF	OFF	OFF
DRIVER EXV #1	ON	ON	OFF	OFF	OFF	OFF
DRIVER EXV #2	OFF	OFF	ON	OFF	OFF	OFF
DRIVER EXV #3	ON	OFF	ON	OFF	OFF	OFF
DRIVER EXV #4	OFF	ON	ON	OFF	OFF	OFF
RS485 component	Microswitch					
	1	2	3	4		
EXP. BOARD #1	ON	OFF	ON	OFF		

2.4 Display and Keypad

Overview

This chapter contains the following topics:

Topic	See page
2.4.1 General Description	2-25
2.4.2 Keypad Keys and their Functions	2-26
2.4.3 Main Menu	2-29
2.4.4 User Menu	2-34
2.4.5 Setting Menu	2-41
2.4.6 Input / Output Menu	2-42
2.4.7 Manufacturer Menu	2-46
2.4.8 EXV Setting Menu	2-59
2.4.9 Maintenance Output Menu	2-63
2.4.10 Maintenance Input Menu	2-66
2.4.11 Service Menu	2-71
2.4.12 Alarm Menu	2-72
2.4.13 Buffer Alarm Menu	2-75

2.4.1 General Description

Introduction

The display and the keypad are the main elements of the interface between the operator and the unit. All the operational conditions, the alarms and the setpoints can be monitored with this display and all the values of setpoint can be modified through the keypad.

Description

The keypad MicroTech II constitutes 15 keys of access to the operational conditions of the unit and to the functions of the program.

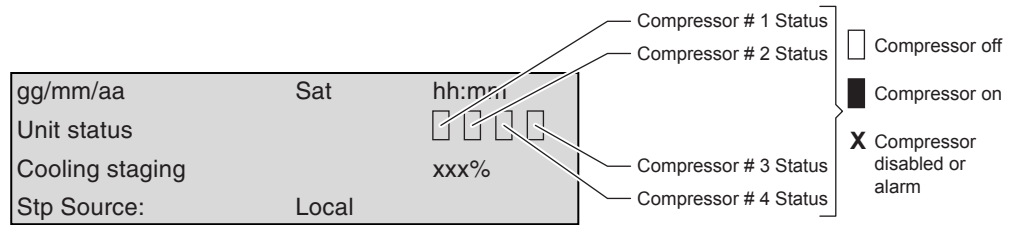





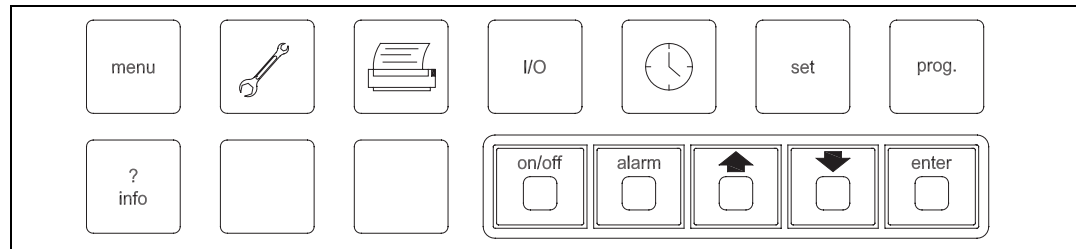



2.4.2 Keypad Keys and their Functions



















2



	<p>User parameters, by password it is possible to set the following parameters:</p> <ul style="list-style-type: none"> ■ Setpoints reset parameters ■ Enable double setpoint ■ Soft load parameters ■ Unit load limiting parameters ■ Compressor sequencing logic ■ Fan Silent Mode values ■ Main pump timing ■ Digital and supervisor inputs enabling ■ Auto restart after power failure and external alarm behaviour ■ Time scheduling ■ Supervisor communication parameters ■ Interface language
	<p>Setpoints adjustment within the limits set under maintenance password</p>
	<p>Date and time setting</p>
	<p>Input/Output and corresponding circuit functions visualization</p>
	<p>Print (not available) (=print)</p>

	<p>(=main)</p>	<p>Maintenance parameters; by Password it is possible to set the following parameters :</p>
<ul style="list-style-type: none"> ■ Hour and start counters reset ■ Water regulation parameters ■ Condensation regulation parameters ■ Setpoint limits ■ Probes enabling ■ Probes offset 		
	<p>It allows you to visualize the main menu</p>	
	<p>It allows the passage from a control board to the other one (visualizing parameters of corresponding compressors, more precisely compressors # 1 and # 2 for board # 1 and compressors # 3 and # 4 for board # 2)</p>	
	<p>Key On/Off unit</p>	
	<p>It indicates the presence of possible anomalies and their causes</p>	
	<p>(=up)</p>	<p>It allows the passage to the previous display screen</p>
	<p>(=down)</p>	<p>It allows the passage to the next display screen</p>
	<p>It enables the set values</p>	

Using the keypad it is possible to access the different sections of the program. In particular there are 9 screen categories, shown in the following table with the keys to use to access them and with the type of operation they allow.

Category	Description	Keys	Password
Main	Operating parameters access (output)		NO
User	Parameters setting by user (input)		0003
Setting	Setpoint setting (input/output)		NO
Input/Output	Compressors working parameters display (output)		NO
Manufacturer	Manufacturer parameters setting (input)	 + 	
EXV Setting	EXV working parameter settings (input)	 + 	0013
Maintenance Output	Maintenance parameter access (output)		NO
Maintenance Input	Maintenance parameter access (input)		
Service	Service (input)	 + 	
Alarm	Alarms (output)		NO
Alarm history	Storage of last 10 alarms (output)	 + 	NO

2.4.3 Main Menu

Operational information

Using this menu you can read the operational information, such as the cooling setpoint, the inlet and outlet water temperatures, the circuit status, etc.

Key : 

Password : NO

Switching between control board # 1 and # 2 : 

Main screen 1

This screen shows information about the compressor status, unit status and setpoint.

DD/MM/YY	Sat	hh/mm
Unit status:		<input type="checkbox"/> <input type="checkbox"/> <input type="checkbox"/> <input type="checkbox"/>
Cooling staging		xx%
Stp Source:	Local	

Line 1 gives current date and time

Line 2 gives the compressor status :

- Compressor OFF
- Compressor ON
- Compressor disabled or alarm

Line 3 gives the unit status in percent with the following possibilities :

- **Cooling staging xx%**
- **Off Alarm** : Unit OFF for alarm
- **Off Rem Comm** : Unit OFF by remote communication (supervisor or BMS)
- **Off Time Schedule** : Unit OFF by time schedule
- **Off Loc/Remote Sw** : Unit OFF through switch
- **Off Keypad** : Unit OFF through keypad (key on/off)
- **Waiting Flow** : Unit ON waiting for evaporator water flow
- **Waiting Load** : Unit ON without compressors working because not required by load
- **No comps available** : Unit ON with no compressors available for automatic management (compressor switch OFF or alarm or in manual mode)
- **FSM Operation** : Unit working in Fan Silent Mode

Line 4 gives the setpoint origin :

- **STP Source** : Local
: Double
: 4-20 mA
- **Soft Load** : xx min (remaining soft load time)

Unit limiting

This screen is only visible when unit limiting (demand limit) is enabled in the user menu.

Unit Limiting	
Demand Limit	xx%

- **Demand Limit** : Read-out of the selected capacity limitation according to the supplied 4-20 mA signal.

Water temperatures

This screen shows the water temperatures.

Water Temperatures	
ENT Evap =	00.0°C
LVG Evap =	00.0°C

- **ENT Evap** : Entering water temperature
- **LVG Evap** : Leaving water temperature (common leaving water if 2 evaps. are present)

Compressor status This screen shows the compressor status.

Comp. # 01	
Status :	Off Ready

Possible status :

- **Off Alarm** : Compressor OFF for alarm
- **Off Switch** : Compressor OFF by local switch
- **Off Ready** : Compressor OFF ready to start
- **Oil Heating** : Compressor waiting for oil heating
- **Manual Off** : Compressor disabled by keypad
- **Recycle Time** : Compressor waiting for timing
- **Starting** : Compressor starting
- **Pre Purge** : Compressor unloading at starting
- **Auto xx%** : Automatic control of compressor with percent load
- **Manual xx%** : Manual control of compressor with percent load
- **Downl.** : Compressor download before stop
- **Pumping down** : Compressor pump down

Refrigerant pressures

This screen shows the high and low pressure of this circuit.

Evap Press =	00.0 bar g
Evap Temp =	00.0 °C
Cond Press =	00.0 bar g
Cond Temp =	00.0 °C

- **Evap Press** : Evaporating Pressure
- **Evap Temp** : Evaporating Temperature
- **Cond Press** : Condensing Pressure
- **Cond Temp** : Condensing Temperature

Refrigerant temperatures

This screen shows the refrigerant temperatures.

Suction Temp =	00.0 °C
Suct Superheat =	00.0 °C
Deliv Superheat =	00.0 °C
Valve Position =	0000

- **Suction Temp** : Suction Temperature
- **Suct Superheat** : Suction Superheat
- **Deliv Superheat** : Discharge Superheat
- **Valve Position** : Position of the electronic expansion valve
 - 0 : Fully closed
 - 2600 : Fully open (Alco EXV8)

Load request

This screen shows the load request of this circuit.

Staging Up	<input type="checkbox"/>
Staging Down	<input type="checkbox"/>
Staging Fixed	<input type="checkbox"/>
Compressor Off	<input checked="" type="checkbox"/>

- **Staging Up** : PID requests a load up of this circuit
- **Staging Down** : PID requests a load down of this circuit
- **Staging Fixed** : No actions are needed
- **Compressor Off** : Compressor is switched off

Comp 2 information

The following screens will appear for compressor 2 (see previous screens)

- Compressor status
- Refrigerant pressures
- Refrigerant temperatures
- Load request

Water temperatures

If 2 evaporators are present, you can scroll between circuits 1, 2 (evap 1) and circuits 3, 4 (evap 2) with the info button.

When you press the info button, the following screen will appear, showing the leaving water temperature of each evaporator:

Water Temperatures	
LVG Evap 1 =	00.0°C
LVG Evap 2 =	00.0°C

- **LVG Evap 1** : Leaving water temperature of evaporator 1
- **LVG Evap 2** : Leaving water temperature of evaporator 2

Comp 3 and 4 information

The following screens will appear for compressor 3 and compressor 4 (if present in the unit)

- Compressor status (see page 2-31)
 - Refrigerant pressures (see page 2-31)
 - Refrigerant temperatures (see page 2-32)
 - Load request (see page 2-32)
-

2.4.4 User Menu

Operational information

Using this menu you can enable or disable additional function in the unit.





Key : 

Password : 0003

Remark : User menu is present in control board # 1 only.

Press the program button to go to the user menu. The following screen will appear:



- Press  and the cursor will move to the first field of the password.
- Pressing  or  will increase the value from 0 to 9999.
- Press  to confirm password.

Setpoint reset

This screen allows you to enable/disable the setpoint reset.



Possible Settings :

- **None**
- **OAT** : Setpoint reset with ambient temperature
- **4-20mA** : Setpoint reset with external signal
- **Return** : Setpoint reset with entering water temperature

**Setpoint reset
4-20mA**

This screen is only visible when setpoint reset : 4-20mA is selected.

This screen allows you to set the parameters used for the 4-20mA setpoint reset (see page 2–34).

chLWT Setpoint Override Limits	
Set. diff	3.0 °C

**Setpoint reset
return**

This screen is only visible when setpoint reset return is selected.

This screen allows you to set the parameters used for the setpoint reset (see page 2–34).

chLWT Return Reset	
Start DT	03.0 °C
Max Reset	03.0 °C

Double setpoint

This screen allows you to enable/disable double setpoint.

Enable Double Setpoint	N/Y
---------------------------	-----

When this function is enabled, additional screen will appear in the setting menu.

Soft load

This screen allows you to enable/disable the soft load function.

When soft load is enabled, Line 2 and 3 will appear.

Enable Soft Load	Y
Max Stage	50 %
Max Time	020 min

This screen allows you to set the parameters used for the soft load function (see page 2–44).

Unit limiting

This screen allows you to enable/disable the unit limiting function.

Unit Limiting
None

Possible settings :

- **None**
- **Demand Limit** : Unit limiting with external signal
- **Current Limit** : Only available on SPN unit
- **Superv. Demand** : Unit limiting with external signal coming from BMS system
- **Superv. Current** : Unit limiting with external signal coming from BMS system

Unit limiting current limit / Superv. current limit

This screen is only visible when current limit or superv. current limit is selected.

Current Limit Set	
4m A	000 A
20 mA	400 A
Max Curr.	300 A

This function is only available on SPN units (special request).

Compressor sequencing

This screen allows you to set the compressors sequencing.

Compressors
Sequencing
Auto

Possible settings :

- **Auto** : Automatic rotation according to the running hours of each compressor
- **Manual** : Manual set sequence for each compressor stage

Manual compressor sequencing

This screen is only visible when manual compressor sequencing is selected.

This screen allows you to set the sequence of the compressors. When selected the sequence is fixed and the controller will no longer look for the running hours of each compressor.

Set Compressor Stage			
C # 1	1st	C # 2	2nd
C # 3	3rd	C # 4	4th

Pump lead time

This screen allows you to set the time between the main pump and the compressor start.

Time Between Main Pump / Fan and Comp. Start	030 s
--	-------

- **Time 30s** : Pump lead time, the pump will operate for 30 seconds (changeable) before the compressor can start

Pump lag time

This screen allows you to set the delay on switching off the pump.

Delay on Switching the Main Pump Off	180 s
---	-------

- **Delay 180 s** : Pump lag time, the pump will operate for another 180 seconds (changeable) when the unit is requested to shut down (local / remote / thermostat)

Supervisory remote

This screen allows you to enable/disable supervisory remote on/off function.

Supervisory Remote On / Off	N
--------------------------------	---

- **N** : The unit will be controlled on/off by local/remote switch/keypad
- **Y** : Allows supervisor or BMS to control the on/off function of the unit

Auto restart

This screen allows you to enable/disable the auto restart after power failure.

Autorestart After Power Failure	Y
------------------------------------	---

- **N** : After a power failure, the unit will not automatically restart
- **Y** : After a power failure, the unit will automatically restart

External alarm

This screen allows you to enable/disable the external alarm function.

Switch Off Unit	
On External Alarm	Y
Reset Type	Auto

■ **External Alarm :**

N : External alarm is disabled

Y : An external alarm signal (open closed contact) can be used to switch off the unit (external alarm)

■ **Reset Type :**

Auto : When the external alarm signal is reset (closed contact), the controller will reset and restart the unit.

Manual : When the external alarm signal is reset (closed contact), the controller will not reset the alarm. A manual reset on the controller is needed to reset the unit.

Time scheduling

This screen allows you to enable/disable the time schedule.

Enable Time	
Scheduling	Y

■ **N** : Time scheduling is not used

■ **Y** : Time scheduling is enabled, additional screens will appear

This screen allows you to enter the start and stop time of the unit.

	Start	Stop
Mon - Fri	00:00	23:59
Sat	00:00	23:59
Sun	00:00	23:59

This screen allows you to enter the holidays (unit will not operate on these days).

	Holidays	(1) or (2)
00/00	00/00	00/00
00/00	00/00	00/00
00/00	00/000	00/00

Remark : To enter the date, please first enter the day and then the month. Example : 31/01

Communication

This screen allows you to select the supervisory communication.

Communication Supervisor

Possible settings :

- **Supervisor** : A supervisor (BMS) system will be used to control the chiller
- **CSC** : The option EKDICN will control the chiller

**Communication
CSC**

These screens are only visible when CSC communication is selected.

This function can only be used when the EKDICN is installed.

Communication	CSC
On Comm Loss	Local/Alarm

- **Local** : When communication is lost, the chiller will operate with local settings
- **Alarm** : When communication is lost, the chiller will go into alarm

This screen allows you to set the identification number of the chiller.

Protocol :	
Supervisor Com. Speed	
Identificat. No. :	001

Communication supervisor

This screen is only visible when supervisor communication is selected.

Protocol : CAREL
Supervisor Com Speed 19200 (RS485 only)
Identificat. No. : 001

■ **Protocol :**

- CAREL : For BACnet communication (with gateway)
- LONWORKS : Direct communication to BMS (Xif pre-loaded)
- MODBUS : Direct communication to BMS
- MODEM :

■ **Com speed :**

- 19200 : RS485 only
- 9600 : RS485 only
- 4800 : RS485 / RS422
- 2400 : RS485 / RS422
- 1200 : RS485 / RS422

■ **Identification No :** Number (address) of the chiller in the BMS system

Language

This screen allows you to select the language of the controller.

Choose Language
ENGLISH

■ Possible settings :

- ENGLISH
- FRENCH
- GERMAN
- ITALIAN
- SPANISH

Change user password

This screen allows you to change the user password.

Change User Password
0003

2.4.5 Setting Menu

Operational information

Using this menu it is possible to set and display the setpoint values.

Key : 

Password : NO

Remark : Setting menu is only present on control board # 1.

Cooling setpoint

This screen allows you to change the cooling setpoint. The setpoint can be selected between the chilled water setpoint limits as specified in the maintenance menu.



Double setpoint

This screen is only visible when the function double setpoint is enabled in the user menu.

This screen allows you to change the cooling double setpoint. The setpoint can be selected between the chilled water setpoint limits as specified in the maintenance menu.

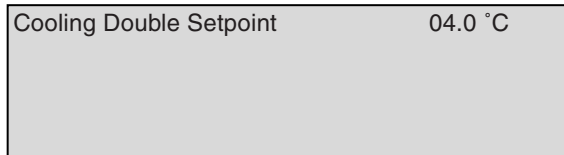

Actual setpoint

This screen shows the actual cooling setpoint.

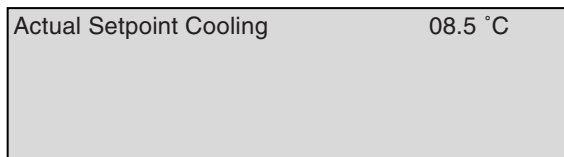

This actual cooling setpoint is the cooling setpoint of the unit at the moment.

This actual cooling setpoint will change if local or dual setpoint is selected or if setpoint is reset.

2.4.6 Input / Output Menu

Operational information

Using this menu you can read the inputs and outputs from the controller, software information and EEV driver information.

Key : I/O

Password : NO

Switching between control board # 1 and # 2 : ? info

I/O expansion board

The screens below are only visible when the unit has economizer (units /A and /Z).

These screens show you the status of the digital output of the I/O expansion board.

I/O Exp E		
DO 1 : Economizer	# 1	N
DO 2 : Economizer	# 2	N

I/O Exp E		
DO 3 : Economizer	# 3	N
DO 4 : Economizer	# 4	N

- **N** : Economizer of this circuit is not active
- **Y** : Economizer of this circuit is active

Software

This screen shows the software version installed in the controller.

Code :	Air
V. 21.307	13/10/06

Digital inputs and outputs

This screen shows the status (O = open, C = closed) of the digital inputs and outputs.

Digital Inputs	
C C	
Digital Outputs	
O O	

Analog inputs

These screens show you the values of the analog inputs.

Analog Inputs :		
B1 :	Oil pr. 1	00.0 bar
B2 :	Oil pr.2	00.0 bar

- **B1** : Oil pressure of compressor circuit 1
- **B2** : Oil pressure of compressor circuit 2

Remark : The oil pressure is measured by a pressure transducer connected to the oil supply chamber of the compressor.

Analog Inputs :		
B3 :		00.0 mA
B4 :	Del. Tem. 1	00.0 °C
B5 :	Del. Tem. 2	00.0 °C

- **B3** : Read-out of the external signal used for setpoint reset (4-20 mA)
- **B4 Del. Tem. 1** : Oil temperature (delivery temperature) of circuit 1
- **B5 Del. Tem. 2** : Oil temperature (delivery temperature) of circuit 2

Remark : The oil temperature (delivery temperature) is measured in the oil separator with a PT1000 sensor.

Analog Inputs :		
B6 :	Cond Pr. 1	00.0 bar
B7 :	Cond Pr. 2	00.0 bar
B8 :		00.0 mA

- **B6** : Condensing pressure of circuit 1
- **B7** : Condensing pressure of circuit 2
- **B8** : Read-out of external signal used for demand limit (4-20 mA) or current limit if unit is SPN unit.

Remark : The condensing pressure is measured by a pressure transducer connected to the oil separator (B8).

Analog Inputs :		
B9 :	In Wtr	00.0 °C
B9 :	Out Wtr	00.0 °C

- **B9** : Inlet water temperature, measured in the inlet of the evaporator 1
- **B10** : Outlet water temperature, measured in the outlet or common outlet (of evap 1 and 2) if unit has 2 evaporators

If consulting this screen or controller # 2 :

- **B9 : O W ev1** : Outlet water temperature of evaporator 1
- **B10 : O W ev2** : Outlet water temperature of evaporator 2

Analog outputs

These screens show you the value of the analog outputs (VFD output signal).

Analog Outputs :	
Y1 :	00.0 V
Y2 :	00.0 V

- **Y1** : Read-out of the VFD output signal of circuit # 1
- **Y2** : Read-out of the second VFD output signal of circuit # 1

Remark : Y1 and Y2 are used only if unit has VFD fans.

Analog Outputs :	
Y4 :	00.0 V
Y5 :	00.0 V

- **Y4** : Read-out of the VFD output signal of circuit # 2
- **Y5** : Read-out of the second VFD output signal of circuit # 12

Remark : Y4 and Y5 are used only if unit has VFD fans.

Soft load

This screen is only visible when soft load function is enabled.

This screen shows you the parameters of the soft load function.

Soft Load	Off
Max Stage	50 %
Rem. Time	000 min
Max Time	020 min

- **Soft Load** :
 - Off** : Soft load is not active
 - On** : Soft load is active
- **Max Stage** : Max unit capacity during the soft load function
- **Rem. Time** : Remaining time that the soft load function is active
- **Max Time** : Time of the soft load function

Boot / Bios info

This screen shows you the Boot and Bios of the software.

Bios Version	003.64
Bios Date	18/05/05
Boot Version	003.01
Boot Date	15/04/02

Driver firmware version

These screens show you the EEV driver hardware and software version.

Driver Firmware Version	C : 1
H.W.	000
S.W.	000

- **C : 1** : Driver firmware version of circuit # 1
- **H.W.** : Hardware version of the EEV driver
- **S.W.** : Software version of the EEV driver

Driver Firmware Version	C : 2
H.W.	000
S.W.	000

- **C : 2** : Driver firmware version of circuit # 2
- **H.W.** : Hardware version of the EEV driver
- **S.W.** : Software version of the EEV driver

I/O parameters for control board # 2 (comp 3 and 4)

If the compressor 3 or 4 are present, you can scroll between control board # 1 (comp 1 and 2) and control board # 2 (comp 3 and 4) with the info button.

When you press the info button, the following screens will appear for control board # 2 :

- Software (see page 2–42)
- Digital inputs and outputs (see page 2–42)
- Analog inputs (see page 2–43)
- Analog outputs (see page 2–44)
- Boot / Bios info (see page 2–45)
- Driver firmware version (see page 2–45)

2.4.7 Manufacturer Menu

Operational information

Using this menu you can set all manufacturer data. Password is required to enter this menu. The parameters can only be modified by trained individuals.

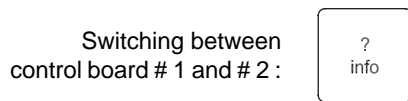
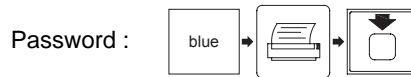
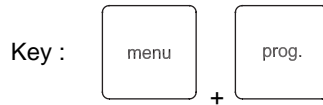

Warning : Improper setpoints or values can cause erratic chiller operation and damage to the chiller. Please use caution whenever changing setpoints or values.

Expansion valve type

This screen allows you to select the expansion valve type.

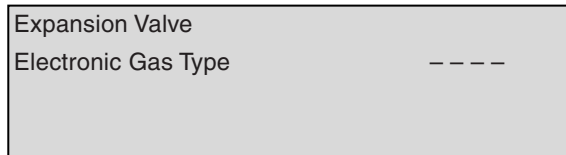

Possible settings :

- **Electronic**
- **Thermostatic** (not used)

Economizer setting

This function is only used on EWAP-AJYNN/A.

This screen allows you to enable/disable the economizer.

En. Economizer	N/Y
Economizer On	090 %
Economizer Off	075 %

- When **N** is selected, the economizer function is disabled. (EWAP-AJYNN)
- When **Y** is selected, the economizer function is enabled. (EWAP-AJYNN/A)
- When **En. Economizer Y** is selected, line 3 and line 4 will appear.
- **Economizer on** : economizer activation point
- **Economizer off** : economizer switch off point

Economizer motor protection

This function is used only in EWAP-AJYNNA/A.

This screen allows you to set the economizer motor protection settings.

- **Motor protection setp.** : Economizer function is disabled when saturated discharge temperature gets above setpoint
- **Motor protection diff.** : Economizer function is allowed again when saturated discharge temperature gets below setp. – diff.

Temp regulation

This screen allows you to set the settings of the PID regulation.

Temp. Regulation	
Integral Time	200 s
Derivative Time	060 s

Integral time and derivative time are used by the PID regulation to calculate the actions needed to reach the setpoint.

Unit configuration

This screen allows you to set the compressor / unit configuration.

Compressors Config.	
N. of Compressors	4
N. of Evaporators	2

- **N. of Compressors** : Number of compressors in the unit
- **N. of Evaporators** : Number of evaporators in the unit. This line is visible only when the number of compressors is >2.

Compressor timers

These screens allow you to set the compressor timers.

Min T between some	
Comp. Start	0600 s
Min T between diff.	
Comp. Start	0120 s

Min Time Compressor	
ON	0120 s
Min Time Compressor	
OFF	0180 s

Interstage timer

This screen allows you to set the interstage time and the double pulse setpoint.

Interstage Time	0210 s
Double Pulse Under	035 %

- **Interstage Time** : Interstage time used for temperature regulation
- **Double Pulse under** : Double load pulses are given below setpoint

Pressure safety prevention

These screens allow you to set the high and low pressure safety preventions.

- **Cond. P. Hold** : Condenser pressure hold capacity
- **Cond. P. Down** : Condenser pressure load down
- **Evap. P. Hold** : Evaporator pressure hold capacity
- **Evap. P. Down** : Evaporator pressure load down

High discharge alarm

This screen allows you to set the discharge temperature alarm setpoint.

Disch Temp Alarm	
Setpoint	110.0 °C

Remark : discharge temperature = delivery temperature (PT1000 sensor in oil separator)

Flow switch alarm

This screen allows you to set the flow switch alarm delay timers.

Evaporat. Flow Alarm Delays	
Start-Up Delay	20 s
Run Delay	05 s

- **Start-Up Delay** : When the flow switch is not closed for 20 seconds (default) during pump lead time, alarm will be displayed
- **Run Delay** : When the flow switch is not closed for 5 seconds (default) during operation of the unit, alarm will be displayed

Freeze prevention

This screen allows you to set the freeze prevention parameters.

Freeze Prevent	
Setpoint	03.0 °C
Diff.	01.0 °C

Freeze Prevent :

- **Setpoint** : Freeze prevention activation setpoint (for evaporator leaving water)
- **Diff.** : Freeze prevention reset difference

Anti-freeze alarm, 1 evap.

This screen allows you to set the anti-freeze alarm parameters.

Anti-Freeze Alarm	
Setpoint	02.0 °C
Diff.	01.0 °C

Anti-freeze Alarm :

- **Setpoint** : Anti-freeze alarm activation setpoint
- **Diff.** : Anti-freeze alarm reset difference

Anti-freeze alarm, 2 evaps.

These screens are visible only when the unit has 2 evaporators.

These screens allow you to set the anti-freeze alarm parameters per evaporator.

Anti Freeze Alarm	EV 1
Setpoint	02.0 °C
Diff.	01.0 °C

Anti Freeze Alarm	EV 2
Setpoint	02.0 °C
Diff.	01.0 °C

Anti-freeze Alarm :

- **EV 1** : Anti-freeze alarm settings of evaporator 1
- **EV 2** : Anti-freeze alarm settings of evaporator 2
- **Setpoint** : Anti-freeze alarm activation setpoint of the particular evaporator
- **Diff.** : Anti-freeze alarm reset difference

**Compressor
load/unload pulses**

This screen allows you to set the compressor load and unload pulses.

Number of Pulses to Load Comp.	015
Number of Pulses to Unload Comp.	015

**Unloading
parameters**

This screen allows you to set the unloading parameters.

Unloading	
Pulse Time	00.3 s
Min Pulse Period	01 s
Max Pulse Period	090 s

- **Pulse Time** : Time of the unload pulses
- **Min Pulse Period** : Minimum time between two unload pulses
- **Max Pulse Period** : Maximum time between two unload pulses

Warning : Verify during commissioning.

**Loading
parameters**

This screen allows you to set the loading parameters.

Loading	
Pulse Time	00.3 s
Min Pulse Period	05 s
Max Pulse Period	090 s

- **Pulse Time** : Time of the load pulses
- **Min Pulse Period** : Minimum time between two load pulses
- **Max Pulse Period** : Maximum time between two load pulses

Warning : Verify during commissioning.

Pump down configuration

This screen allows you to set the pump down parameters (pump down at shut down)

- **Enable :**
 - N** : Pump down is disabled
 - Y** : Pump down is enabled
- **Max Time** : Maximum time of pump down function
- **Min Press** : Minimum pressure during pump down function

Fan configuration

This screen allows you to set the fan setup of the unit.

Condensation	
Enable	PRES.
Type	STEPS
Fan Steps	4

- **Enable PRES.** : Fan regulation on condensing pressure setpoints
- **Type :**
 - Steps** : Fan regulation with on/off fans steps
 - VFD** : Fan regulation with phase cut fans (only in units with OPFS)
 - SPEEPTR** : Fan regulation with 1 VFD fan and all other fans on/off (only in units with OPLA)
- **Fan Steps** : Number of on/off fan steps in the unit
 - Possible settings** : 1 – 4

Fan settings for option OPLA

These screens are not visible when VFD is selected.

These screens allow you to set the setpoints of the different fan steps of a circuit. These settings are applicable for all circuits.

The fan settings for an OPLA unit is a combination of on/off fan steps and one VFD fan.

Condensation	
Fan Step N.	1
Setpoint	00.0 bar
Diff.	00.0 bar

- **Fanstep N.** : Number of this fan step
- **Setpoint** : Setpoint of fanstep, at this setpoint this fan step will switch on
- **Diff.** : Differential of fanstep to switch off this fan step (setpoint – diff.)

This screen can be found in each fan step present in the unit (VFD fan has other setpoints, see next screen). Each fan step has its own setpoint and diff. setting. See Table below for fan step settings.

Available Steps	Setpoint / Diff.			
	Step 1	Step 2	Step 3	Step 4
1	17.0 / 4.0	–	–	–
2	17.0 / 3.0	20.0 / 3.0	–	–
3	17.0 / 3.0	19.0 / 3.0	20.0 / 3.0	–
4	17.0 / 3.0	19.0 / 3.0	20.0 / 3.0	21.0 / 3.0

Fan step settings

These screens are not visible when VFD is selected.

This screen allows you to set the setpoints of the different fan steps of a circuit. These settings are applicable for all circuits.

Condensation	
Fan Step N.	1
Setpoint	00.0 bar
Diff.	00.0 bar

- **Fanstep N.** : Number of this fan step
- **Setpoint** : Setpoint of fanstep, at this setpoint this fan step will switch on
- **Diff.** : Differential of fanstep to switch off this fan step (setpoint – diff.)

This screen can be found in each fan step present in the unit. Each fan step has its own setpoint and diff. setting. See table below for fan step settings.

Available Steps	Setpoint / Diff.			
	Step 1	Step 2	Step 3	Step 4
1	Not available	–	–	–
2	15.0 / 4.0	18.0 / 4.0	–	–
3	15.0 / 4.0	17.0 / 3.0	18.0 / 3.0	–
4	15.0 / 4.0	16.0 / 2.0	17.0 / 2.0	18.0 / 2.0

Available only for electronic expansion valve

Fan settings for units with option OPLA and OPFS

This screen is visible only when VFD or SPEEDTR is selected.

If the unit is with option OPLA, these settings will be used to control the VFD fan.

If the unit is with option OPFS, these settings will be used to control all the fans of the circuit.

Inverter Config.	
Max. Speed	10.0 V
Min. Speed	0.0 V
Speed Up Time	1 s

- **Max. Speed** : When 10.0 V output signal is given, fans will work at maximum speed
- **Min. Speed** : When 0.0 V output signal is given, fans will work at minimum speed (switched off)
- **Speed Up Time** : Time that full speed signal is given to the fan to speed up at fan start-up

Condensation setpoints for units with option OPLA and OPFS

These screens are visible only when VFD or SPEEDTR is selected.

These screens allow you to set the condensation regulations setpoints.

Cond Regulation	
Regul. Band	05.0 bar
Neutral Band	00.0 bar

- **Regul. Band** : Condensation regulation band around the condensation setpoint
- **Neutral Band** : Condensation neutral band around the condensation setpoint

Cond. Regulation	
Integral Time	600 s
Derivative Time	001 s

Integral time and derivative time are used by the PID regulation to calculate the actions needed to reach the condensation setpoint.

Oil heating

This screen allows you to enable/disable the oil heating control.

Enable Oil Heating Control	Y
----------------------------	---

- **Y** : Oil heating function is enabled
- **N** : Oil heating function is disabled

HP alarm settings This screen allows you to set the high pressure alarm settings.

- **Setpoint** : High pressure alarm setpoint to activate high pressure alarm
- **Diff.** : High pressure alarm differential to be able to reset high pressure alarm (setpoint – diff.)

LP alarm settings This screen allows you to set the low pressure alarm settings.

- **Setpoint** : Low pressure alarm setpoint to activate low pressure alarm
- **Diff.** : Low pressure alarm differential to be able to reset low pressure alarm (setpoint + diff.)

LP alarm delay This screen allows you to set the low pressure alarm delay timers.

Low Press. Alarm Delays	
Start-Up Delay :	060 s
Run Delay :	040 s

- **Start-Up Delay** : Low pressure bypass timer during start-up of compressor
- **Run Delay** : Low pressure delay time before unit goes into LP alarm when unit is in operation

Pressure ratio alarm This screen allows you to set the pressure ratio alarm setpoints.

Pressure Ratio Alarm	
Min Load Setp	1.4
Max Load Setp	1.8

- **Min Load Setp** : Pressure ratio alarm setpoint when compressor is operating at minimum load
- **Max Load Setp** : Pressure ratio alarm setpoint when compressor is operating at full load

Remark : The actual pressure ratio alarm setpoint will be calculated according to the actual compressor capacity.

Pressure ratio alarm delay

This screen allows you to set the pressure ratio alarm delay timers.

Pressure Ratio Alarm	
Start-Up Delay	180 s
Run Delay	90 s

- **Start-Up Delay** : Pressure ratio alarm bypass timer during start-up of compressor
- **Run Delay** : Pressure ratio alarm delay time before unit goes into pressure ratio alarm when unit is in operation

Oil high pressure diff. alarm

This screen allows you to set the oil high pressure diff. alarm settings.

Oil High Pressure Diff. Alarm	
Setp	2.5 bar
Delay	020 s

- **Setp** : When the pressure drop over the oil filter is bigger than 2.5 bar (default), the unit will go into alarm (after delay timer)
- **Delay** : Oil high pressure diff. alarm delay time before unit goes into alarm

Remark : Oil high pressure diff = pressure drop over oil filter (measured by: high pressure transducer and oil pressure transducer).

Liquid injection

This screen allows you to set the liquid injection settings.

Liquid Injection	
Setpoint	085 °C
Diff.	10.0 °C

- **Setpoint** : Liquid injection setpoint to activate the liquid injection.
Temperature is measured by the oil temperature sensor PT1000.
- **Diff** : Liquid injection differential to switch off liquid injection function (setpoint – diff.)

EXV pre-opening

This screen allows you to set the EXV pre-opening setting.



- **EXV pre-opening** : Pre-opening of the electronic expansion valve during pre-purge (compressor startup)

RS485 net refresh

This screen allows you to reset the RS485 net (communication to expansion board).



- **Time check** : Time that the controller will refresh the RS485 net
- **Refresh** : Start the refreshing of the RS485 net

During the RS485 net refreshing, the following screens will appear.



Refresh procedure is busy.

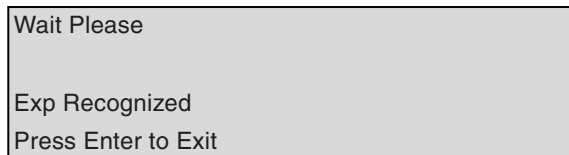

Refresh procedure is finished and expansion board is found.

When there is a problem with the RS485 communication, the following screen will appear after the refresh procedure.

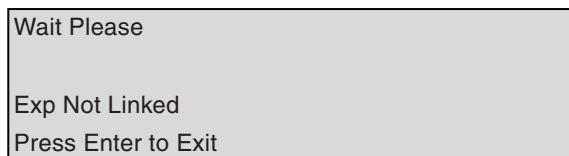

Reset all parameters to default values

This screen allows you to reset all parameters to the default values.

Reset all Parameters to Default Values		U : 1
		N

- **U : 1** : Reset all parameters on control board # 1
- **Y** : Reset all parameters of this control board to the default values

EXV settings

This screen allows you to enter the EXV setting password.

EXV Setting	
Insert Password	0000

Manufacturer settings on control board # 2 (comp 3 and 4)

If compressor 3 or 4 is present, you can scroll between control board # 1 (comp 1 and 2) and control board # 2 (comp 3 and 4) with the info button.

When you press the info button, the following screens will appear for control board # 2 in the manufacturer menu.

Freeze Prevent	
Setpoint	00.0 °C
Diff.	00.0 °C

- **Setpoint** : Freeze prevention activation setpoint (for evaporator 2 leaving water)
- **Diff** : Freeze prevention reset difference

RS485 Net	
Time Check	045
Refresh	N

- **Time Check** : Time that the controller will refresh the RS485 net
- **Refresh Y** : Start the refreshing of the RS485 net

	U : 2
Reset all Parameters to Default Values	N

- **U : 2** : Reset all parameters on control board # 2
- **Y** : Reset all parameters of this control board to the default values

2

2.4.8 EXV Setting Menu

Operational information

Using this menu you can set all EXV parameters. The parameters can only be modified by trained individuals.



Password : 0013

Switching between control board # 1 and # 2 :



Warning screen

These screens show you the warnings of the EXV driver.

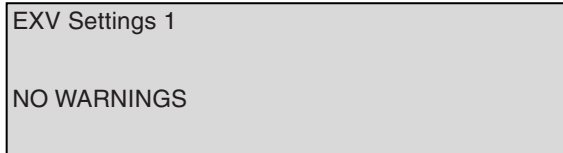

Actual / Manual positions

These screens show you the actual EXV position, and allows you to manually control the EXV.



- **EXV Setting** : Indicates the EXV settings from circuit 1 or 2 (3 or 4)
- **Actual Position** : Actual position of the expansion valve
- **Manual Position** : Setpoint in EXV manual mode for the expansion value
- **En. EXV Manual**

Auto : Automatic expansion regulation

Manual : Manual control of the expansion valve (only during troubleshooting)

EXV type

This screen allows you to set the valve type and gas type.

- **Valve Type** : Type of valve used in unit
- **Gas Type** : Refrigerant used in unit

Opening / Closing extra steps

This screen allows you to enable / disable the extra steps at closing or opening of the expansion valve.

EXV Settings		
Opening	EXTRAs	Y
Closing	EXTRAs	Y
Time	EXTRAs	0000 s

- **Opening EXTRAs Y** : Extra opening pulses are given when fully open position is reached
- **Closing EXTRAs Y** : Extra closing pulses are given when fully closed position is reached
- **Time EXTRAs** : Function to be confirmed

Superheat setpoint

This screen allows you to set the superheat setpoint and superheat dead band.

EXV Settings	
SHeat Setp.	06.0 °C
Dead Zone	00.0 °C

- **SHeat Setp** : Superheat setpoint
- **Dead Zone** : Dead band around the superheat setpoint

EXV PID factors

This screen allows you to set the EXV regulation PID factors.

EXV Settings	
Prop. Factor	80.0
Int. Factor	030 s
Diff. Factor	00.5 s

Low SH protections This screen allows you to set the low superheat protection settings.

EXV Settings	
Low SHeat Protection	
Low Limit	-1.0 °C
Int. Time	01.0 °C

- **Low Limit** : Setpoint of the low limit function
- **Int. Time** : Integral time used for the low limit function

LOP protection This screen allows you to set the LOP protection parameters.

EXV Settings	
LOP Protection	
LOP Limit	- 30.0 °C
Int. Time	04.0 °C

- **LOP Limit** : Setpoint of the LOP protection function
- **Int. time** : Integral time used for the LOP function

MOP protection These screens allow you to set the MOP protection parameters

EXV Settings	
MOP Protection	
MOP Limit	12.0 °C
Int. Time	04.0 °C

- **MOP Limit** : Setpoint of the MOP protection function
- **Int. Time** : Integral time used for the MOP function

EXV Settings	
MOP Protection	
Start-Up Delay	090 s

- **Start-Up Delay** : Start-up delay of the MOP functions at start-up

**High temperature
condensing
protection**

This screen allows you to set the high temperature condensing protection setpoints.

EXV Settings			
HiTcond	PROTECTION		
HiTcond	Limit	90.0	°C
Int. Time		04.0	°C

- **HiTcond Limit** : Setpoint of the high temperature condensing protection
- **Int. Time** : Integral time used for the high temperature condensing protection

**Suction
temperature high
limit**

This screen allows you to set the suction temperature high limit setpoint.

EXV Settings	
Suction Temperature	
High Limit	060.0 °C

**EXV pressure probe
values**

This screen allows you to set the pressure probe minimum and maximum values.

- **Min Value** : Minimum value of the low pressure probe operation range
- **Max Value** : Maximum value of the low pressure probe operation range

**Battery / Plan
setting**

These screens allow you to enable / disable the EXV battery and plan.

EXV Setting 1	
BATTERY PRESENT	Y
PLAN PRESENT	Y

EXV Setting 2	
BATTERY PRESENT	Y
PLAN PRESENT	Y

**Change driver
password**

This screen allows you to change the driver password.

Change Driver Password	0013
------------------------------	------

2.4.9 Maintenance Output Menu

Operational information

Using this menu you can read-out all the maintenance parameters.

Key :



Password : NO

Switching between control board # 1 and # 2 :



Evaporator pump hours

This screen shows you the total evaporator pump running hours

Hour Counter	
Pump Evap.	000000

Compressor running data

This screen shows you the total running hours of a compressor and the number of compressor starts.

Compressor	C : 1
Hour Counter	000000
Number of Starts	00002

- **C : 1** : Compressor running data of compressor # 1
- **Hour Counter** : Total running hours of this compressor
- **Number of Starts** : Total number of compressor starts

This screen shows you the last compressor start and compressor stop.

Last Comp. Start	C : 1
DD/MM/YY	hh:mm
Last Comp. Stop	
DD/MM/YY	hh:mm

This screen shows you the EXV driver battery state.

EXV Driver State	C : 1
Batt. Resist.	000.0
Batt. Voltage	00.0

- **C : 1** : EXV driver state of circuit 1
- **Batt. Resist.** : Battery resistance
- **Batt. Voltage** : Battery voltage

Remark : Same compressor running data screens (3 previous screens) will be displayed for compressor 2 (C : 2)

Cooling PID errors

This screen shows the cooling PID errors used for the temperature regulations.

Cooling PID Errors	
Prop.	00.0 °C
Int.	0000.0 °C x sec
Der.	000.0 °C / min

- **Prop.** : Proportional error read-out
- **Int.** : Integral error read-out
- **Der.** : Derivation error read-out

Cooling PID actions

This screen shows the cooling PID actions.

Cooling PID Act	0000
Proportional	0000
Integral	0000
Derivative	0000

Read-out of the calculated PID actions:

Cooling Reg.	
Disable Stop	N / Y
Increase Stop	N / Y

Global PID request This screen shows you the global PID request.

Global PID Request	
Load	Y
Unload	N
Stand-by	N

- **Load :**
 - N : No load requested
 - Y : Load requested
- **Unload :**
 - N : No unload requested
 - Y : Unload requested
- **Stand-by :**
 - N : No stand-by requested
 - Y : Stand-by requested

Remark : Only one action can be requested at a time.

Maintenance password This screen allows you to enter the maintenance password.

Digit
maintenance password

Maintenance read-out menu on control board # 2 (comp 3 and 4)

If compressor 3 or 4 is present, you can scroll between control board # 1 (comp 1 and 2) and control board # 2 (comp 3 and 4).

When you press the info button, the following screens will appear for control board # 2 :

- Compressor running data screens for comp 3 (see page 2–63)
- Compressor running data screens for comp 4 (see page 2–63)
- Maintenance password screen (see page 2–65)

2.4.10 Maintenance Input Menu

Operational information

Using this menu you can set all maintenance parameters. The parameters can only be modified by trained individuals.

Screen : Digit maintenance password

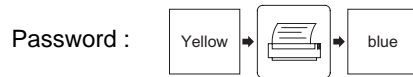

Switching between control board # 1 and # 2 :



Evaporator pump timers

This screen allows you to settle the evaporator threshold (maintenance) and running hours.

Evap. Pump h. Count.	
Threshold	010 x 1000
Reset	N
Adjust	000000

- **Threshold** : Running hour when unit will show “Evaporator Pump Maintenance” Alarm
- **Reset Y** : Reset evaporator pump hours
- **Adjust** : Enter the running hours of the pump. This has to be done whenever software or controller is changed.

Compressor running data setting

This screen allows you to set the compressor threshold (maintenance) and running hours.

Comp. h. Count	C : 1
Threshold	010 x 1000
Reset	N
Adjust	000000

- **C : 1** : Compressor information of compressor circuit 1
- **Threshold** : Running hour of this compressor when unit shows “Compressor # 1 Maintenance” alarm
- **Reset Y** : Reset compressor running hours
- **Adjust** : Enter the running hours of this compressor. This has to be done whenever software or controller is changed.

This screen allows you to set the number of compressor starts.

	C : 1
Comp. Starts	
Reset	N
Adjust	000000

- **C : 1** : Compressor information of compressor circuit 1
- **Reset Y** : Reset compressor starts
- **Adjust** : Enter the compressor starts of this compressor. This has to be done whenever software or controller is changed.

Remark : Same compressor timers screens (two previous screens) will be displayed for compressor 2 (C : 2)

Temperature regulation settings

These screens allow you to set the parameters for the temperature regulation function.

- **Regul. Band** : Regulation band
- **Neutral Band** : Neutral band around setpoint
- **Max Pull Down Rate** : Maximum pull down rate

Start-Up DT	02.6 °C
Shut Down DT	01.7 °C

Remark : These parameters are vital for a proper temperature regulation.

High chilled water start

This screen allows you to set the high chilled leaving water start parameters.

High ChLWT start	
LWT	25.0 °C
Max Comp. Stage	070 %

- **LWT** : Leaving water temperature setpoint to activate the high chilled leaving water
- **Max Comp. Stage** : Maximum compressor stage of the compressor if leaving water temperature is higher than LWT setpoint

Condensation setpoint

This screen is only visible if fan type VFD or SPEEDTR is selected (units option OPFS or OPLA).

This screen allows you to set the condensation setpoint.

- **Condensation Setpoint** : Condensation setpoint for phase cut fans (VFD or SPEEDTR)

Temperature setpoint limits

This screen allows you to set the minimum and maximum setpoint limits.

ChLWT Temperature	
Setpoint Limits	
Low	04.0 °C
High	10.0 °C

- **Low** : Minimum chilled outlet water temperature setpoint you can enter in the setting menu (MOW)
- **High** : Maximum chilled outlet water temperature setpoint you can enter in the setting menu

Probes enable screen

This screen allows you to enable or disable the analog inputs.

Probes enable			U : 1
B1 : Y	B2 : Y	B3 : Y	B4 : Y
B5 : Y	B6 : Y	B7 : Y	B8 : Y
B9 : Y	B10 : Y		

- **U : 1** : Analog inputs of control board # 1
- **Bx : Y** : Analog input x is enabled
- **Bx : N** : Analog input x is disabled

Remark : When using setpoint override (4-20 mA), probe B3 has to be enabled. When using demand limit, probe B8 has to be enabled.

Expansion board probe screen

This screen allows you to enable or disable the analog input (from the expansion board).

This screen is only visible when the unit has an expansion board (units /A and /Z). The ambient sensor which can be connected to the expansion board analog input B1 is used for setpoint reset OAT. This sensor is not standard (SPN unit).

EXP Probes enable	
B1 : Y	
EXP Probes Offs	
B1 Offs :	00.0 °C

- **B1 : Y** : Analog input is enabled
- **B1 : N** : Analog input is disabled
- **B1 Offs** : Offset of sensor B1, adjust if needed

Controller probes offset

These screens allow you to set the offset of the analog inputs.

Inputs Probes Offset			
B1 : 0.0	B2 : 0.0		
B4 : 0.0	B5 : 0.0		

Input Probes Offset			
B6 : 0.0	B7 : 0.0		
B9 : 0.0	B10 : 0.0		

Time to down load compressor

This screen allows you to set the time to down load compressor before the pump down procedure starts.

Time to Download Compressor	
30 s	

Reload and re-unload comp

This screen allows you to set the reload and re-unload ΔT .

DT to Reload and Re-unload Comp	
0.7 °C	

- **DT** : ΔT above and below setpoint to reload or re-unload compressor

Maintenance input menu on control board # 2 (comp 3 and 4)

If compressor 3 or 4 is present, you can scroll between control board # 1 (comp 1 and 2) and control board # 2 (comp 3 and 4).

When you press the info button, the following screens will appear for control board # 2 :

- Compressor running data settings for comp 3 (see page 2-66)
 - Compressor running data settings for comp 4 (see page 2-66)
 - Probes enable screen (see page 2-68)
 - Controller probes offset (see page 2-69)
-

2.4.11 Service Menu

Operational information

Using this menu you can operate the different circuits in manual mode. When the chiller is working in manual mode and a safety prevention is met (LP prevention / HP prevention / Freeze prevention / ...), the chiller will automatically switch over to normal (auto) mode. This is to prevent the unit from tripping. This function can only be used during commissioning or troubleshooting.

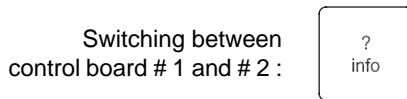
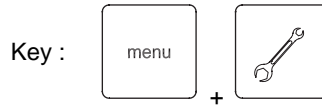

Compressor manual mode

These screens allow you to operate a compressor in manual mode.

Compressor # 1	
Manual Load	050 %
State	Auto

Compressor # 2	
Manual Load	050 %
State	Auto

- **Compressor # 1** : Compressor circuit 1
- **Manual Load** : The requested load during manual mode (25% till 100%)
- **State** :
 - Auto** : Manual mode is disabled
 - Manual** : Manual mode is enabled, unit will work with manual load setpoint
 - Off** : Compressor is disabled (switched off)

Remark : Switching between auto and manual mode can be done without compressor stop.

Service menu on control board # 2 (comp 3 and 4)

If compressor 3 or 4 is present, you can scroll between control board # 1 (comp 1 and 2) and control board # 2 (comp 3 and 4).

When you press the info button, the following screens will appear for control board # 2 :

- Compressor manual mode screens (see page 2-71)

2.4.12 Alarm Menu

Operational information

Using this menu you can read out the actual alarm.

When an alarm condition occurs, the display buzzer starts. Pressing the alarm key displays the current fault. Pressing the alarm key twice stops the buzzer while pressing it thrice removes the alarm.

Remark : Sometimes, when an alarm occurs, another spurious alarm of star/delta transition failure also occurs. In this case, solve the spurious alarm first. If the spurious alarm occurs again, check the electrical connections.

If the alarm is not removed even after pressing the alarm key again, it means that faulty conditions still exist.

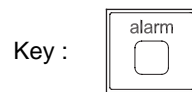

Password : NO

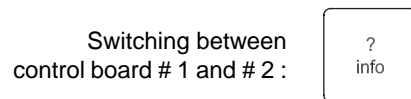

Alarm screen

This screen shows you the actual alarm.

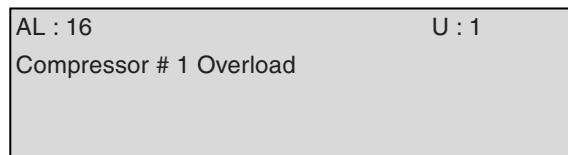

- **AL : 16** : Alarm code
- **U : 1** : Alarm on controller board # 1
- **Compressor # 1 Overload** : Alarm description with indication of circuit

Alarm menu on control board # 2 (comp 3 and 4)

If compressor 3 or 4 is present, you can scroll between control board # 1 (comp 1 and 2) and control board # 2 (comp 3 and 4)

When you press the info button, the following screen will appear for control board # 2 :

- Alarm screen (see page 2–72)

The following table displays a list of possible alarms with the identifier number, the cause and the reset type (A = auto, M = manual).

Alarm		Alarm cause	Reset
001	Phase monitor	Intervention of the device control of phases. The phases are not correctly sequenced or the supply voltage is out of acceptable limits.	M
002	Freeze alarm	Antifreeze protection. The outlet water temperature is equal to the antifreeze value.	M
005	Evaporator Flow alarm	Intervention of Evaporator Flow switch. The water pump could be off.	M
006	Low pressure alarm (transducer)	Low pressure intervention by microchip.	M
007	High discharge temperature alarm (temperature switch)	Intervention of the discharge temperature switch.	M
008	Fault transition	Starting procedure is not complete. Verify the contactors.	M
009	Low oil pressure	The oil pressure is not enough for the correct lubrication of the compressor. Verify that the condensing pressure is at least 3 times the suction pressure 0	M
011	High oil pressure difference	High oil differential pressure. The oil filter could be dirty or the solenoid valve doesn't work correctly.	M
012	High pressure alarm (pressure switch)	Intervention of the high pressure mechanical switch.	M
016	Compressor overload	Intervention of the compressor thermal motor or intervention of the high temperature switch	M
023	High pressure alarm (transducer)	Intervention high pressure by microchip	M
030	B1 probe fault or not connected	Sensor B1 error	M
031	B2 probe fault or not connected	Sensor B2 error	M
032	B3 probe fault or not connected	Sensor B3 error	M
033	B4 probe fault or not connected	Sensor B4 error	M
034	B5 probe fault or not connected	Sensor B5 error	M
035	B6 probe fault or not connected	Sensor B6 error	M
036	B7 probe fault or not connected	Sensor B7 error	M
037	B8 probe fault or not connected	Sensor B8 error	M
039	Evaporator pump maintenance	Request of evaporator pump maintenance	M
040	Condenser pump maintenance	Request of condenser pump maintenance	M
041	Compressor maintenance	Request of compressor maintenance	M
050	Unit 1 offline	Compressor #1 network error	A

051	Unit 2 offline	Compressor #2 network error	A
052	Unit 3 offline	Compressor #3 network error	A
053	Unit 4 offline	Compressor #4 network error	A
D01	EXV Driver Probe fault	Driver EXV probe error	A
D02	EXV step motor error	EXV valve motor error	A
D03	EXV Driver Eeprom error	Driver EXV eeprom error	M
D04	EXV Driver battery error	Driver EXV battery error	A
D08	EXV not closed during power off	Valve doesn't close without power	M
	Alarms expansion E	Expansion board Offline or not recognized	M

2.4.13 Buffer Alarm Menu

Operational information

Using this menu you can consult the last ten alarms of every chiller circuit.

Each mask displays the date, time and description of the alarm. Pressing the enter key when an alarm description is displayed shows the operating conditions at the time the alarm occurred (temperatures, pressures, expansion valve status and compressor load).

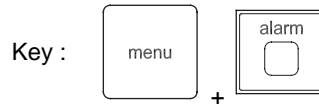



Password : NO

Buffer alarm screens

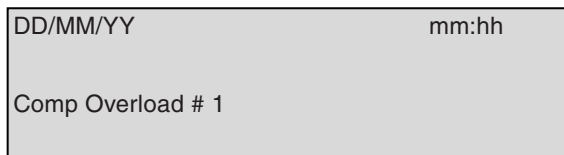
These screens allow you to consult all the running parameters of the circuit/unit at the moment of the alarm.



■ Press  to consult the running conditions.

■ Press  or  to scroll through all the running data screens.

Buffer alarm menu on control board # 2 (comp 3 and 4)

If compressor 3 or 4 is present, you can scroll between control board # 1 (comp 1 and 2) and control board # 2 (comp 3 and 4).

When you press the info button, the following screen will appear for control board # 2

■ Buffer alarm screens (see page 2-75)

2

3 Functional Control

3.1 What Is In This Chapter?

Introduction

This chapter will give more detailed information about the functions used to control the system. Understanding these functions is vital when diagnosing a malfunction which is related to functional control.

Overview

This chapter contains the following topics:

Topic	See page
3.2 ON / OFF Management	2–79
3.3 Thermostat Control	2–80
3.4 Setpoint Reset of the Chilled Water	2–85
3.5 Return Water Reset	2–88
3.6 Freeze-up Control	2–89
3.7 Enable Soft Load	2–91
3.8 Unit Load Limiting	2–92
3.9 Start Up With High Evaporator Water Temperature	2–93
3.10 Ambient Lockout	2–94
3.11 Pump Control	2–95
3.12 Auto Restart after Power Failure Function	2–96
3.13 Liquid Injection	2–97
3.14 Economizer Function	2–98
3.15 EXV Pre Opening	2–99
3.16 Compressor Configuration	2–100
3.17 Compressor Management	2–101
3.18 High Pressure Setback	2–103
3.19 LP Prevention	2–104
3.20 Capacity Control	2–105
3.21 Pump Down Configuration at Compressor Stop	2–108
3.22 Pressure Safeties	2–109
3.23 LP alarm delay	2–111
3.24 Oil Management Safeties	2–112
3.25 Head Pressure Control	2–114
3.26 Heat Recovery Microprocessor Control	2–118
3.27 Heat Recovery Operation	2–119

Topic	See page
3.28 Heat Recovery Microprocessor Set-up	2-120

3.2 ON / OFF Management

Introduction

There are four ways of switching the unit on and off:

- Through the local key of the controller
- Through a remote switch
- Through a supervision system (BMS)
- Through a time schedule

Power on

- The initialization takes 10 seconds.
- The controller automatically goes to the first screen.

Remark: An auto restart function is integrated. This means that the on/off status is remembered after a power failure of the unit. This auto restart function can be disabled in the user menu.

On/Off local

Unit shutdown through the controller (on/off key).

If the switch is enabled, "off keypad" will appear on the display of the unit status.

Remote on/off

Unit shutdown through a digital contact.

If the panel switch is in the "0" position, the unit is off by local switch and "Off Loc/Rem Sw" will appear on the display.

- If the switch is in "Loc" position, the unit is on (unless there are other shutdown conditions).
- If the switch is in the "Rem" position, the digital contact control allows the start up and the shutdown of the unit from a remote switch. When the unit is stopped from remote, "Off Loc/Rem Sw" will appear on the display of the unit status.

Remark: The remote on/off switch is field supply.

On/Off network

This function allows the startup and the shutdown of the unit through Supervision System Plant Visor 1.0.

In case this function is enabled, the display of the unit status shows "Off Rem. Comm".

On/Off time schedule

This function, if enabled, allows the startup and the shutdown of the unit based on a user defined time schedule. In case the function is enabled, "Off Time Schedule" will appear on the display of the unit status.

Emergency stop

In the event of an emergency, switch off the unit by pushing the emergency button.

When the problem is solved, do not forget to reset the emergency button.

3.3 Thermostat Control

Introduction

The thermostat control is used to generate a load-up or load-down according to the active PID regulation.

Continuous loading and unloading uses 2 solenoid valves to control the screw compressor slide and thus its capacity. Control is performed by outlet temperature.

Unit and compressor start up and shutdown procedure

In the following flow chart the unit startup, management and shutdown procedures are shown, as well as the compressors loading and unloading strategy.

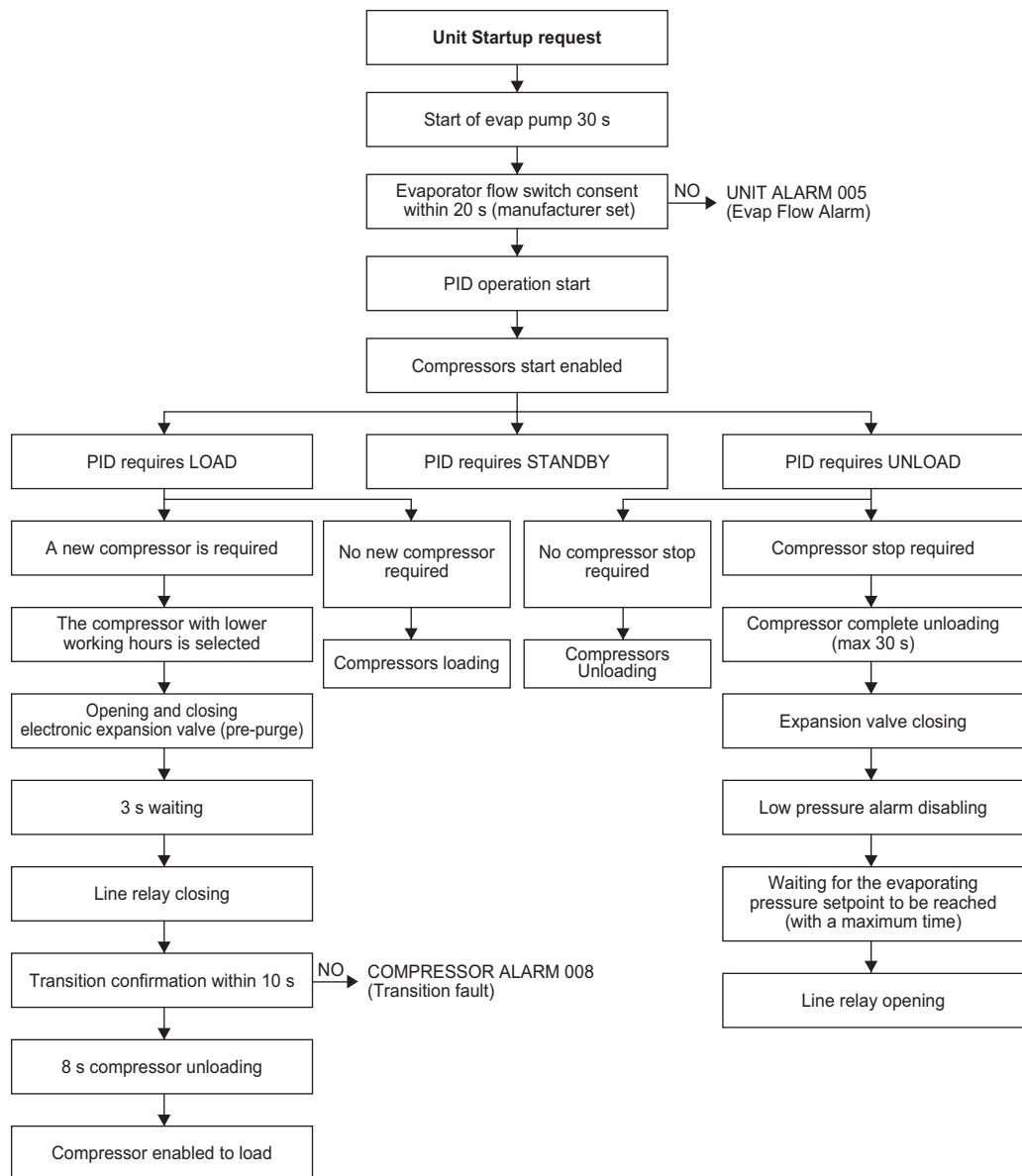

Unit shutdown

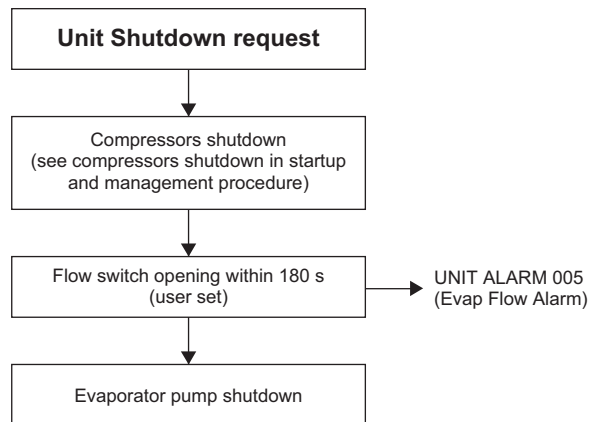

Compressors start up and loading management (4 compressors)

Step n.	Leader Comp.	Lag 1 Comp.	Lag 2 Comp.	Lag 3 Comp.
0	Off	Off	Off	Off
1	If $(T - \text{SetP}) < \text{Start up DT \& Cooling}$ or $(\text{SetP} - T) < \text{Start up DT \& Heating}$ Waiting			
2	Start	Off	Off	Off
3	Load up to 75%	Off	Off	Off
4	If T in Regulation Band Wait interstage time			
5	If T is approaching SetP – Waiting			
6a (T in unload band)	Unload up to 50%	Start	Off	Off
6b (T not in unload band)	Fixed at 75%	Start	Off	Off
6	Fixed at 75% or 50%	Load up to 50%	Off	Off
7 (If leader at 50%)	Load up to 75%	Fixed at 50%	Off	Off
8	Fixed at 75%	Load up to 75%	Off	Off
9	If T in Regulation Band Wait interstage time			
10	If T is approaching SetP – Waiting			
10a (T in unload band)	Fixed at 75%	Unload up to 50%	Start	Off
10b (T not in unload band)	Fixed at 75%	Fixed at 75%	Start	Off
11	Fixed at 75%	Fixed at 75% or 50%	Load up to 50%	Off
12 (If lag 1 at 50%)	Fixed at 75%	Load up to 75%	Fixed at 50%	Off
13	Fixed at 75%	Fixed at 75%	Load up to 75%	Off
14	If T in Regulation Band Wait interstage time			
15	If T is approaching SetP – Waiting			

2

Step n.	Leader Comp.	Lag 1 Comp.	Lag 2 Comp.	Lag 3 Comp.
16a (T in unload band)	Fixed at 75%	Fixed at 75%	Unload up to 50%	Start
16b (T out unload band)	Fixed at 75%	Fixed at 75%	Fixed at 75%	Start
17	Fixed at 75%	Fixed at 75%	Fixed at 75% or 50%	Load up to 50%
18 (if lag 2 at 50%)	Fixed at 75%	Fixed at 75%	Load up to 75%	Fixed at 50%
19	Fixed at 75%	Fixed at 75%	Fixed at 75%	Load up to 75%
20	Load up to 100%	Fix a/Fixed at 75%	Fix a/Fixed at 75%	Fix a/Fixed at 75%
21	Fixed at 100%	Fixed at 100%	Fixed at 100%	Fixed at 75%
22	Fixed at 100%	Fixed at 100%	Load up to 100%	Fixed at 75%
23	Fixed at 100%	Fixed at 100%	Fixed at 100%	Load up to 100%
24	Fixed at 100%	Fixed at 100%	Fixed at 100%	Fixed at 100%

Compressors unload and shutdown management (4 compressors)

Step n.	Leader Comp.	Lag 1 Comp.	Lag 2 Comp.	Lag 3 Comp.
0	100%	100%	100%	100%
1	Fixed at 100%	Fixed at 100%	Fixed at 100%	Unload up to 75%
2	Fixed at 100%	Fixed at 100%	Unload up to 75%	Fixed at 75%
3	Fixed at 100%	Unload up to 75%	Fixed at 75%	Fixed at 75%
4	Unload up to 75%	Fixed at 75%	Fixed at 75%	Fixed at 75%
5	Fixed at 75%	Fixed at 75%	Fixed at 75%	Unload up to 50%
6	Fixed at 75%	Fixed at 75%	Unload up to 50%	Fixed at 50%
7	Fixed at 75%	Fixed at 75%	Fixed at 50%	Unload up to 25%
8	If T is approaching SetP – Waiting			
8a (T in load band)	Fixed at 75%	Fixed at 75%	Load up to 75%	Stop
8b (T not in load band)	Fixed at 75%	Fixed at 75%	Fixed at ??	Stop
9 (if lag 2 at 75%)	Fixed at 75%	Fixed at 75%	Fixed at ??	Off
10	Fixed at 75%	Unload up to 50%	Fixed at 50%	Off
11	Fixed at 75%	Fixed at 50%	Fixed at 25%	Off
12	If T is approaching SetP – Waiting			
13a (T in load band)	Fixed at 75%	Load up to 75%	Stop	Off
13b (T not in load band)	Fixed at 75%	Fixed at 50%	Stop	Off
14 (lag 1 at 75%)	Fixed at 75%	Unload up to 50%	Off	Off
15	Unload up to 50%	Fixed at 50%	Off	Off
16	Fixed at 50%	Unload up to 25%	Off	Off
17	If T is approaching SetP – Waiting			

Step n.	Leader Comp.	Lag 1 Comp.	Lag 2 Comp.	Lag 3 Comp.
18a (T in load band)	Load up to 75%	Stop	Off	Off
18b (T not in load band)	Fixed at 50%	Stop	Off	Off
19	Unload up to 25%	Off	Off	Off
20	If T is approaching SetP – Waiting			
21	If (SetP – T) < Shutdown DT & Cooling or (T – SetP) < Shutdown DT & Heating Waiting			
22	Stop	Off	Off	Off
23	Off	Off	Off	Off

Loading and unloading zones

The graph below shows the different loading and unloading zones.

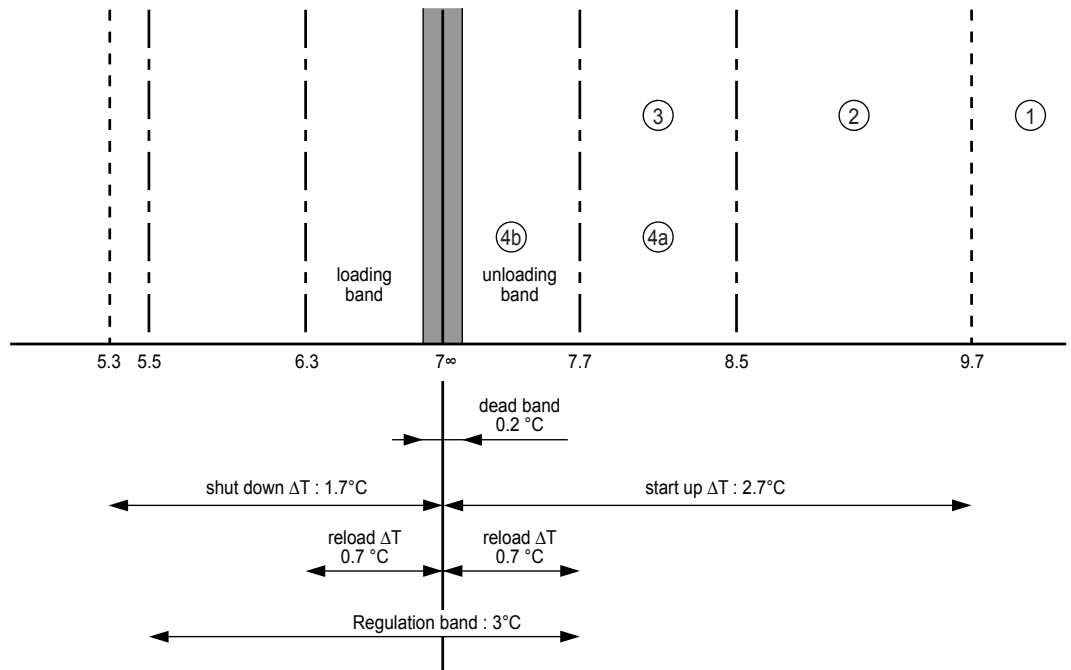

Settings

Do not change:

- Max pull down : 1.2 ° / min
- Dead band : 0.2°C
- Reload ΔT : 0.7°C
- Interstage : 210 s

Other settings

- Start up ΔT : 2.6°C
- Shutdown ΔT : 1.7°C
- Regulation band : 3°C

EXAMPLE: Upload

1)

- If the water temperature is above 9.6°C, the chiller can start (below 9.6°C the chiller will wait)
- Unit will start leader compressor

2)

- Unit will load leader compressor till 75%

3)

- If the temperature is in Regulation Band

→ wait interstage time (default 210 sec)

- If the temperature is approaching setpoint (after interstage time)

→ wait (no need to start new compressors because chilled water temperature is decreasing, prevent undershoot)

- After interstage time check if temperature is in unloading band

4a)

No: Unit will add next compressor (25% capacity) and keep the leader compressor at 75%

Leader comp : 75%

Next comp : 28%

4b)

Yes: Unit will first unload leader compressor to 50%. When this is done the next compressor will start (25%).

Leader comp : 50%

Next comp : 25%

This will give you another 75% capacity, but now the unit is able to upload in small steps.

- Unit will upload the running compressors to 75%
 - If another compressor is present and there is still demand for food, the regulation cycle will continue from point 3.
 - If no other compressors are present and there is still demand for load, the compressors will upload to 100% capacity according to the PID regulation (if needed).
- When the temperature is in the dead band, the unit will operate with the same capacity (no upload or download)

3.4 Setpoint Reset of the Chilled Water

Introduction

Among the MicroTech NC controllers options, there are also several possibilities to regulate the unit with particular logics or outside signals. The setpoint reset function gives the possibility to modify the local setpoint of the chilled water according to the following logics:

- double setpoint
- external signal
- OAT (outdoor ambient temperature) reset
- return water reset

Double setpoint

Through an external contact (optionally a switch is installed on the electric panel control), it is possible to vary the local setpoint of control between two well defined values. Such option results are advantageously applicable in case of installation with ice bank. When the temperatures of the evaporator outgoing water are inferior to 4°C, the introduction of the correct quantity of Anti-freeze in the hydraulic system is required.

Enable Double Setpoint	Y
------------------------	---

Cooling Double Setpoint	12.0 °C
Heating Double Setpoint	---- °C

External signal

The setpoint override allows, by use of an external signal, to override the chilled water setpoint.

This function is activated by enabling the analog input B3 of the controller. A 4-20mA signal can be used to change the setpoint.

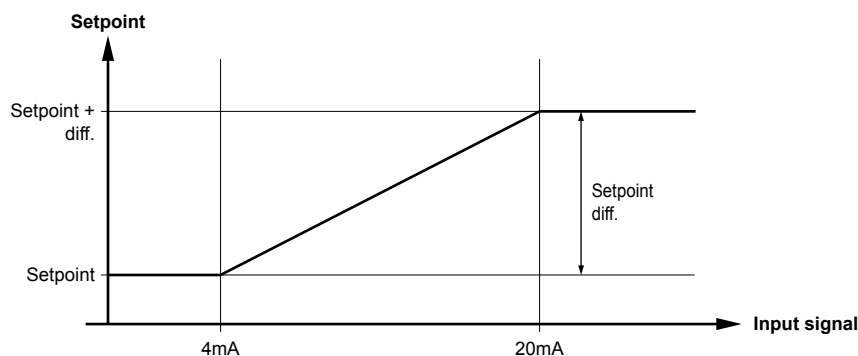

- For inputs lower than 4mA, the water setpoint is set to the local setpoint
- For inputs between 4 and 20mA, the setpoint is obtained by linear interpolation between the setpoint and the setpoint + setpoint diff (entered in the user menu)
- For inputs higher than 20mA, the water setpoint is set to setpoint + diff.

Remark: The value entered for the setpoint diff can also be negative.

2

Lvg Water Temp	
Setpoint Reset	
	4-20mA

chLWT Setpoint	
Override Limits	
Setp. Diff.	03.0 °C

Outdoor ambient temperature reset

The OAT mode can be used to modify the setpoint in function of the ambient temperature. The user is able to choose to use the OAT mode or not. The result of using the ambient mode is that the unit will be used more efficiently and that the modified setpoint will be displayed under the normal setpoint.

The OAT setpoint parameters and function can be set in the user menu.

This function is only available when the optional pCOe (expansion board) is present. This is because the ambient sensor is connected to this pCOe.

Function description

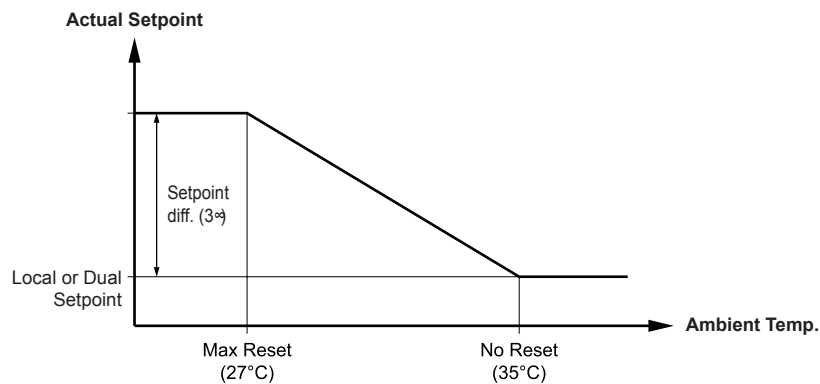

OAT chWT Reset	
Setpoint Diff.	3 °C
Max Reset	27 °C
No Reset	35 °C

- Above 35°C Ambient Temperature, there is no reset. The unit will operate with the local or dual setpoint.
- Between 27°C and 35°C Ambient Temperature, the unit will change the actual setpoint according to the offset.
- Below 27°C Ambient Temperature, the unit will operate with actual setpoint equal to the local or dual setpoint + setpoint diff.

Explanation

When the load of the unit drops (by drop in outdoor temperature), then the setpoint will be changed upwards by the setpoint diff value. Because of this, the unit will evaporate at a higher temperature and the performance of the unit will be better.

Remark: When you use the OAT setpoint reset, the actual setpoint will show in the setting menu.

3.5 Return Water Reset

Introduction

When return water is selected as the reset mode, the MicroTech controller will adjust the leaving chilled water setpoint to maintain a constant return water temperature equal to the return water setpoint. The return water temperature is sampled every 5 minutes and a proportional correction is made to the leaving chilled water setpoint. The corrected leaving water setpoint is never set to a value greater than the return water setpoint and is never set to a value less than the actual leaving chilled water setpoint.

Function description

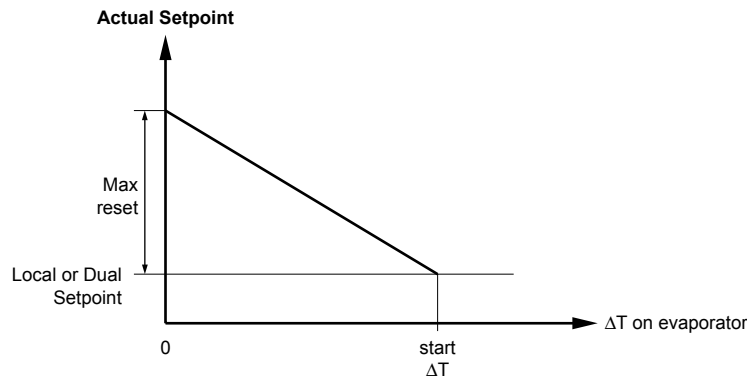

chLWT Return Reset	
Start dT	3 °C
Max Reset	3 °C

Remark: When the unit is designed for a ΔT of 5°C (at 100% capacity), then the start ΔT and Max Reset should also be set to 5°C.

Explanation

The return water reset will adjust the leaving chilled water setpoint according to the evaporator ΔT . In this way the chiller can maintain a constant return water temperature.



3.6 Freeze-up Control

Introduction

Freeze up control is used to protect the evaporator against accidental freezing.

Two protections are present: freeze-up prevention and Anti-freeze alarm.

Freeze-up prevention

Freeze-up prevention will request a load-down when the temperature of the evaporator outlet gets below 3°C (freeze prevention setpoint).

The unit will go back to normal operation (possibility to load up) when the outlet temperature gets above freeze prevention setpoint + diff.

Characteristics	Freeze-up prevention
Control device	Sensor (1 sensor at each evaporator outlet)
Diagram name	
Activation	Outlet water temp < Freeze prevention setpoint (3°C)
Result	Load down compressor
Reset	Outlet water temp > Freeze prevention setpoint + diff (4°C)
Result	Normal mode

Anti-freeze alarm

When the evaporator outlet water temperature drops below Anti-freeze alarm setpoint (2°C), the Anti-freeze protection is activated and the unit will shut down. When the temperature rises above the Anti-freeze setpoint + diff (3°C) it is possible to reset the Anti-freeze alarm.

Characteristics	Anti-freeze alarm
Control device	Sensor (1 sensor at each evaporator outlet)
Diagram name	
Activation	Outlet water temp < Anti-freeze setpoint (2°C for standard unit)
Result	Unit disabled
Result	Manual reset Manual reset possible when outlet temp is above Anti-freeze setpoint + diff.

Remark: In case of 2 evaporators, each evaporator has its own Anti-freeze alarm setpoints.



Function description

2

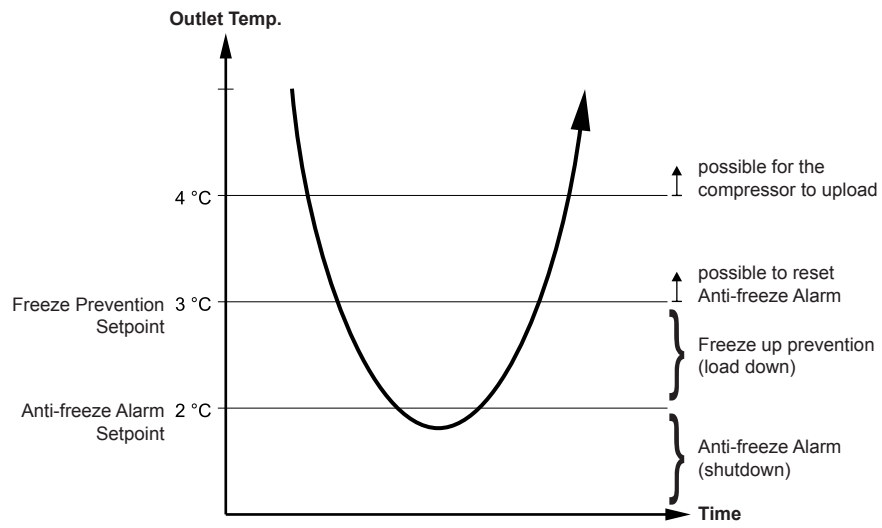

Anti-Freeze Alarm	
Setpoint	02.0 °C
Diff.	01.0 °C

In case the unit has 2 evaporators:

Evap 1 Anti-Freeze Alarm	
Setpoint	2.0 °C
Diff.	1.0 °C

Evap 2 Anti-Freeze Alarm	
Setpoint	2.0 °C
Diff.	1.0 °C

3.7 Enable Soft Load

Function description

The Soft load function can be enabled by keyboard in the user menu. The Soft load function limits the unit load to a predetermined value (Max stage) for a set period (Max time). This function finds wide application where the water temperature is high at the start up but without having a consistent thermal load. This function allows energy saving during the unit start up, avoiding useless loading of the compressors .

Enable Soft Load	Y
------------------	---

Enable Soft Load	Y
Max stage	50 %
Max Time	20 min



3.8 Unit Load Limiting

Introduction

The Unit load limiting function finds application in all those situations when it is necessary to reduce the electric absorption of the unit, in determined periods of the day.

Load limiting

It is possible to limit the unit absorption, using one of the two options available under user menu.

- The first way, called "Demand Limit" requires a 40mA - 20mA external signal (connections 37 and 38 on M3). The unit max load decreases from 100% to 0% as the input increases from 4mA to 20mA.

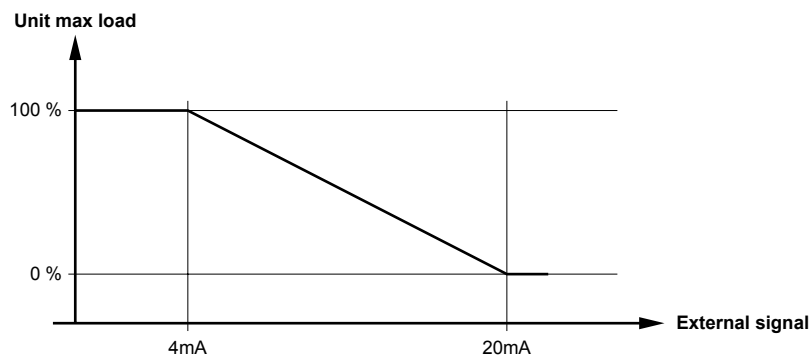

- The second way, called "Current Limit" needs a direct measure of the current absorbed by the unit and the set of the maximum current to be absorbed. (Option: SPN unit)

Remark: The current limit screen appears only if the b8 probe is enabled under maintenance menu.



Current Limit Set	
4m A	000 A
20 mA	400 A
Max Curr.	300 A

3.9 Start Up With High Evaporator Water Temperature

Function description

This function limits the load of each compressor to a set value (default 70%) until the outlet water temperature is over the set value (default 25°C). This function helps the start up of the unit when the water temperature is very high (35°C - 40°C), avoiding dangerous overheating of the motor and disagreeable interventions for high pressure protection.

The value of the maximum load of the compressors and the limit water temperature are modifiable under the user menu.

High chLWT Start	
LWT	25.0 °C
Max Comp. Stage	70 %



3.10 Ambient Lockout

Introduction

The Ambient lockout function will allow you to disable the unit below a specified Ambient temperature.

Function description

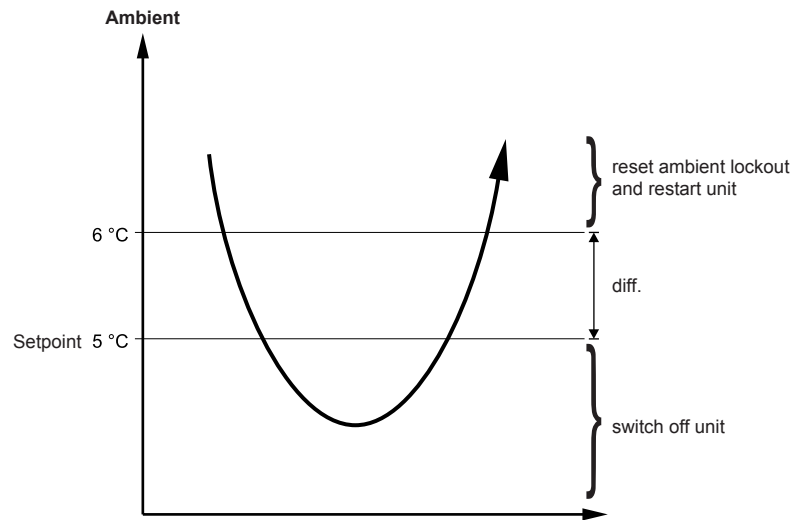

En. Ambient Lockout	
Setpoint	05.0 °C
Diff.	01.0 °C

- When the ambient temperature gets below the ambient lockout set point, the unit will be switched off.
- When the unit is off by ambient lockout, and the temperature rises above 6°C, the unit will restart and continue operation.

3.11 Pump Control

Introduction

To prevent the chiller to start up without flow, safety checks are performed.

First there is a check to make sure that water flows through the system.

The pump control of the user menu allows the user to define the pump lead and the pump lag time.

Pump lead time

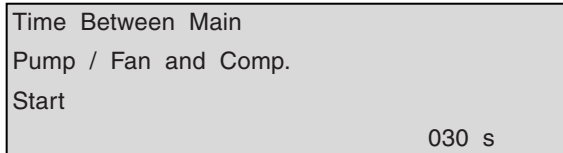

When the unit is switched on, the pump will run for 30 seconds before the chiller (compressors) can start. During these 30 seconds of pump lead time, you will also need a closed flow switch for 20 seconds.

Pump lag time

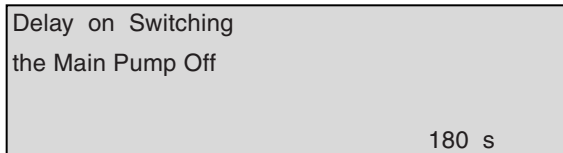

When an off signal is given to the controller (thermostat, local/remote switch,...), the pump will run for another 180 seconds before switching off (pump lag time). During these 180 seconds, the unit will execute the pump down procedure.

3.12 Auto Restart after Power Failure Function

Function description

The Auto restart after power failure allows the unit to restart after a power failure.

- When the Auto restart is enabled, the unit will automatically restart after the power failure.
- When the Auto restart is disabled, the unit will not automatically restart after the power failure. The unit needs to be restarted manually.

This function can be enabled/disabled in the user menu.

Autorestart After Power Failure	Y / N
------------------------------------	-------

3.13 Liquid Injection

Function description

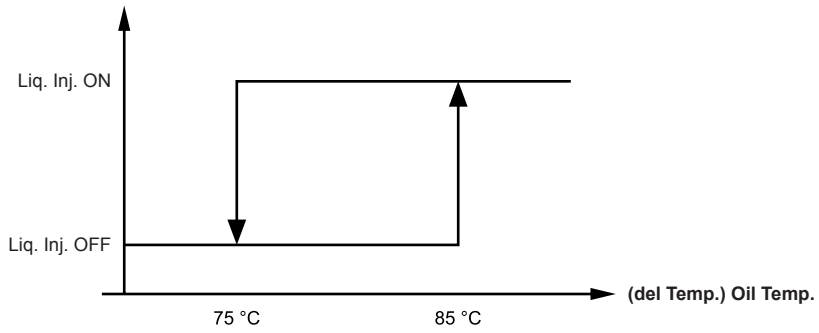

- When the oil temperature (PT1000; del. temp.) is higher than 85°C (default) the liquid injection will be activated.
- When the oil temperature decreases to 75°C the liquid injection will be disabled.

Liquid Injection	
Setpoint	085 °C
Diff.	10.0 °C

3.14 Economizer Function

This economizer function is only present on the EWAD650-C21BJYNN/A and EWAD600-C10BJYNN/Z units.

2

Function description

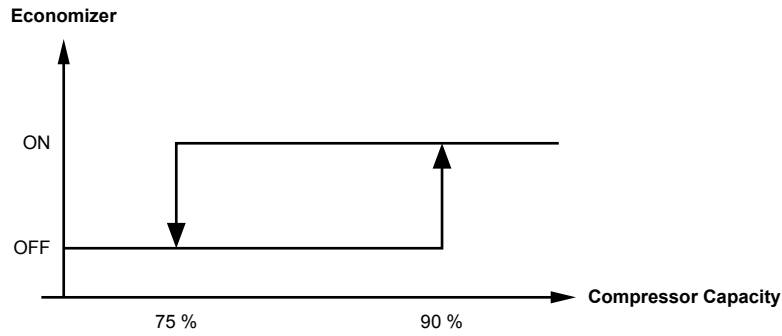

- When the compressor capacity reaches 90%, the economizer will be activated.
- When the economizer is active and the compressor capacity drops to 75%, the economizer will be deactivated.

Enable Economizer	Y / N
Economizer ON	90 %
Economizer OFF	75 %

3.15 EXV Pre Opening

Function description

Because the unit stops with a pump down, it will restart with a pre-purge (opening - closing of the expansion valve).

At start up, the valve will open (up to 50%) and close to the evaporator with a certain amount of liquid.

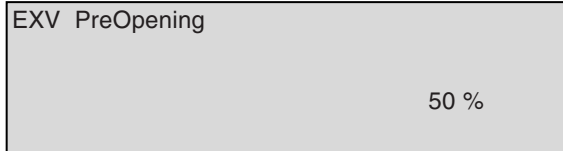

3.16 Compressor Configuration

**Function
description**

This controller screen will allow you to modify the number of compressors and evaporators on the unit. The selection of the compressors and evaporators has to be done according to the unit.

Compressor Configuration	
Numbers of Compressors	2 - 4
Numbers of Evaporators	1 - 2

2

3.17 Compressor Management

Introduction

The compressor sequencing mode determines which circuit starts up first in case of a capacity demand. It prevents the unit from always starting the same circuit. Also, compressor timers are implemented to avoid too many compressor starts in 1 hour.

Compressor sequence

The compressor sequence of starting up can be selected in the user menu.

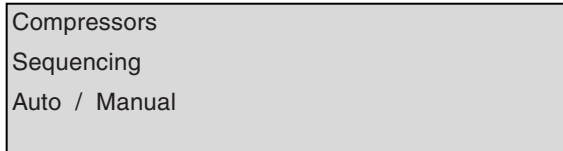

- Auto: The selection of the compressor sequence will be done by the controller depending on the running hours.
- Manual: The selection of the compressor sequence is fixed according to the entered sequence. When the manual is selected, the following screen will appear.

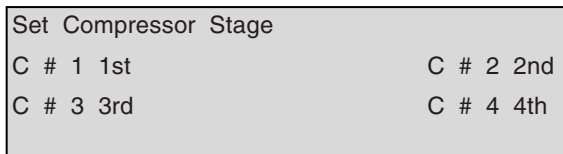

Compressor timers

The compressor timers are implemented to prevent too many compressor starts.

The time set for the compressor to start is 600 seconds. This is to prevent breakdown of the compressor.

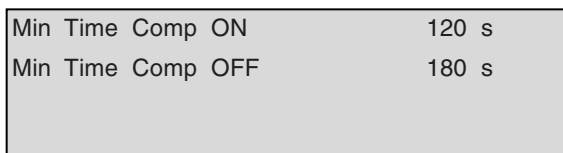
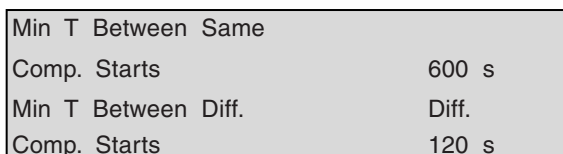

Function description

2

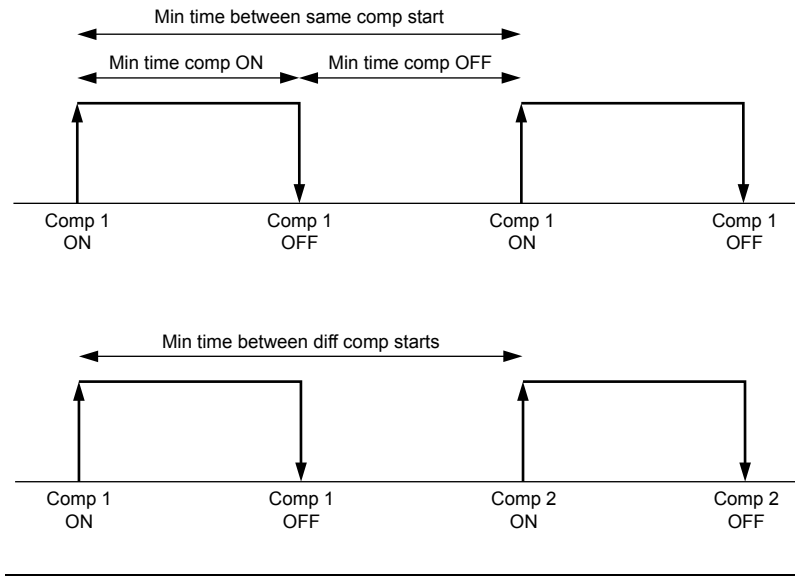

3.18 High Pressure Setback

Introduction

This is a safety prevention function, when the high pressure is near the high pressure switch setpoint. The unit will hold the same capacity or will load down to prevent the unit from tripping on the high pressure switch or transducer high pressure alarm.

Function description

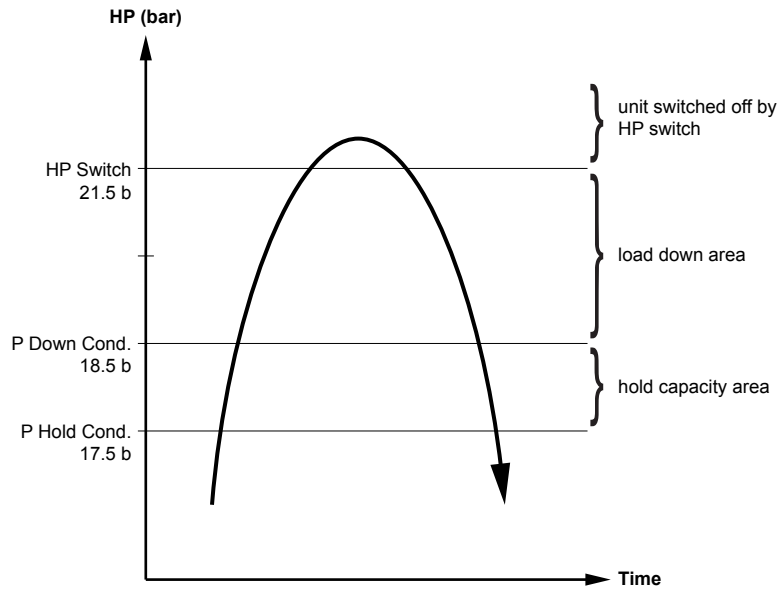

- Hold capacity area: if the HP is above the “P hold cond” setpoint (default 17.5 bar), the compressor will hold the same capacity (no load-up possible).
- Load down area: if the HP is above the “P down cond” setpoint (default 18.5 bar), the compressor will load down in order to decrease the high pressure.
- Above HP switch: the unit will shutdown safely.

2

3.19 LP Prevention

Introduction

This is a safety prevention function, when the low pressure is near the low pressure switch. The unit will hold the same capacity or will load down to prevent the unit from tripping on the low pressure switch.

Function description

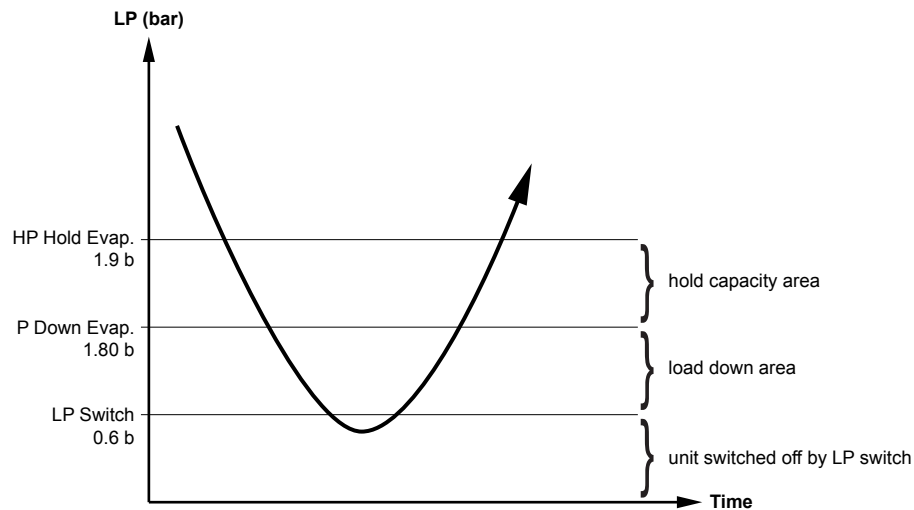

- hold capacity area: if the LP is below the “P hold evap” setpoint (default 1.9 bar), the compressor will hold the same capacity (no load up possible).
- load down area: if the LP is below the “P down evap” setpoint (default 4.8 bar), the compressor will load down in order to increase the low pressure.
- below LP switch: the unit will shutdown safely.

3.20 Capacity Control

Introduction

Cooling capacity control is infinitely variable by means of a capacity slide controlled by a microprocessor system. Each unit has infinitely variable capacity control from 100% down to 6.25% (four compressor units), to 8.3% (three compressor units) to 12.5% (two compressor units). This modulation allows the compressor capacity to exactly match the building-cooling load. The result is a decrease in chiller energy costs, particularly at the part-load conditions at which the chiller operates most of the time. Additionally, in some cases there should be a possibility to avoid inertial tank in the water circuit.

Function description

The compressor capacity, moving of the sliding vane, is done by oil pressure. The controller will decide to feed or to drain oil from the capacity control piston compartment in order to load or unload.

- When the unload valve (B) is energized, the valve will feed oil to the piston and the slide will move to the right (loading down).
- When the load valve (A) is energized, the valve (A) will open. The discharge pressure will push the sliding vane to the left and the oil will drain via the loading valve.

Number of pulses

The compressor load regulation is controlled by a fixed number of pulses to the two solenoid valves, draining and feeding oil in the slide valve chamber.

With the default settings, the compressor will load from 25% capacity to 100% capacity in 15 pulses.

Number of Pulses	
To Load Comp.	15
Number of Pulses	
To Unload Comp.	15

Pulse time

The time of the pulse time is fixed (default 0.3 s). The interval time between two pulses is proportional to the PID (proportional + integral + derivative) unit request.

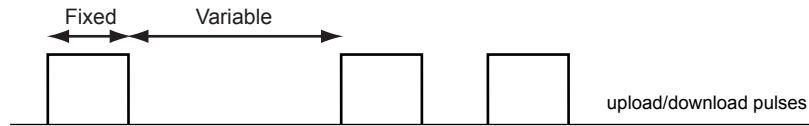

Compressor Unloading	
Pulse Time	00.3 s
Min Pulse Period	01 s
Max Pulse Period	90 s

Compressor Loading	
Pulse Time	00.3 s
Min Pulse Period	05 s
Max Pulse Period	90 s

Graph 1

A pure proportional logic will load or unload with a frequency related to the set-point distance.

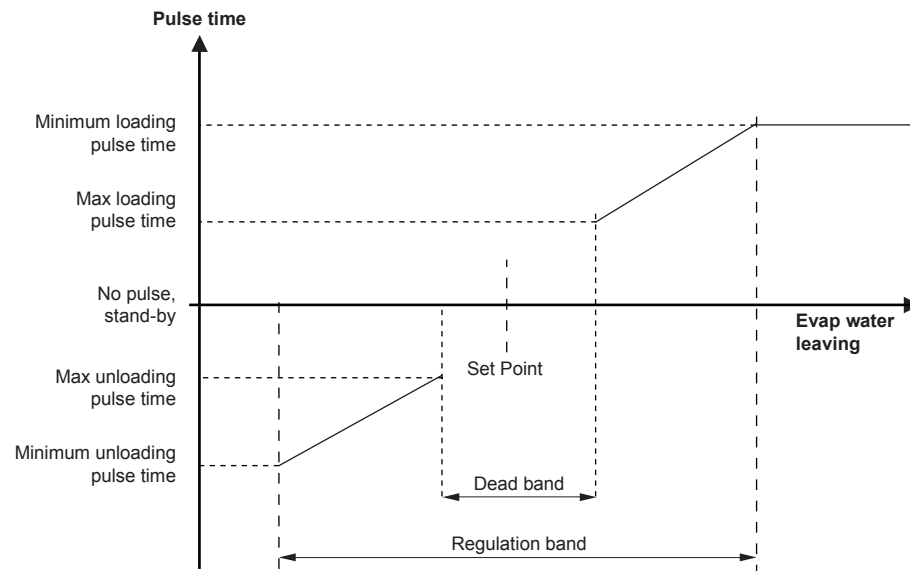

Graph 2

The derivative part of the logic controls how the temperature reaches the setpoint. If it is getting closer (increases the time between the intervals) or if it is far from the setpoint (decreases the time between the intervals). The result is having the controller act differently whenever the water temperature changes.

If the derivative time is increased, the control will be more sensitive to temperature changes. For example: the derivative time can be increased when a chiller is working with a very variable load. The integral time stores the memory on how the P+1 controls the temperature.

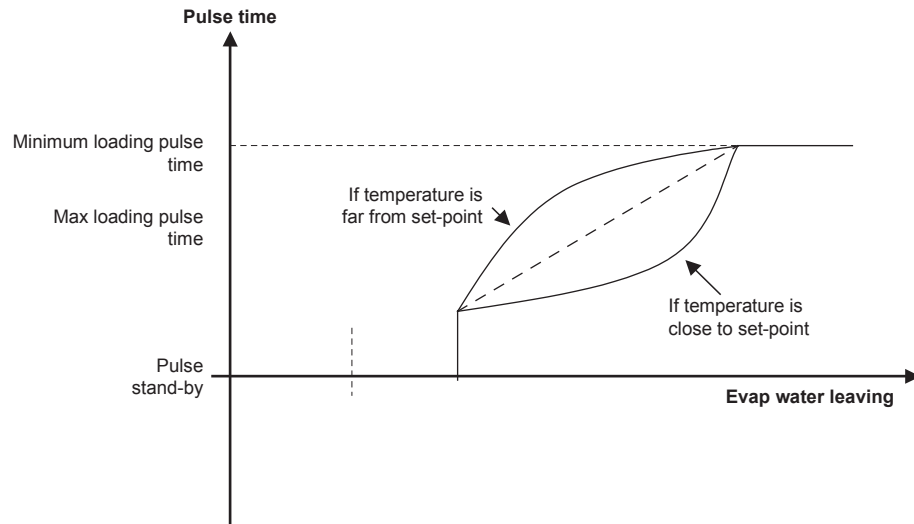

3.21 Pump Down Configuration at Compressor Stop

Introduction

When the unit is switched off (local, remote, thermostat) the pump down procedure will be executed.

Function description

Pump down procedure:

- request to shut down compressor
 - close electronic expansion valve
 - stop compressor or when one of the two conditions is met:
 - max time of pump down = 30 seconds
 - LP is below 2.5 bar
-

3.22 Pressure Safeties

3.22.1 Transducer high pressure alarm

Introduction

This is a software safety function. When the high pressure is near to the high pressure switch setpoint, the unit will shut down and trip on the transducer high pressure alarm.

Function description

- When the pressure is above the HP setpoint, the unit will go into HP alarm.
 - When the high pressure alarm is activated and the HP sinks below the HP setpoint-diff, it is possible to reset the transducer high pressure alarm.
 - When the high pressure rises above the high pressure switch setpoint (29.5 bar), the unit will go into alarm and a manual reset on the high pressure switch is needed.
-

3.22.2 Transducer low pressure alarm

Function description

2

- When the low pressure is below the LP setpoint (for the LP alarm delay time), the unit will go into LP alarm.
 - When the low pressure alarm is activated and the LP rises above the LP setpoint + diff, it will be possible to reset the transducer low pressure alarm.
 - When the low pressure sinks below the low pressure switch setpoint (3.0 bar), the unit will go into alarm and a manual reset of the low pressure switch is needed.
-

3.23 LP alarm delay

Function description

Delay timer before the unit goes into LP alarm.

- start delay: At start up the unit has a delay of 120 seconds before the unit can trip on the LP alarm (low pressure bypass timer)
- run delay: When the unit is in operation, the low pressure can be below the LP alarm setpoint for a specified time before the unit will trip on the LP alarm.

Low Press. Alarm Delays	
Start-Up Delay :	060 s
Run Delay :	040 s



3.24 Oil Management Safeties

3.24.1 Pressure ratio alarm

Introduction

Because the capacity control is done by oil pressure, it is very important to have a minimum pressure difference between LP and HP to be able to move the sliding vane.

Function description

When the pressure ratio is too small for a specified time, the controller will give an alarm.

$$\text{pressure ratio} = \frac{\text{discharge pressure (Abs)}}{\text{suction pressure (Abs)}}$$

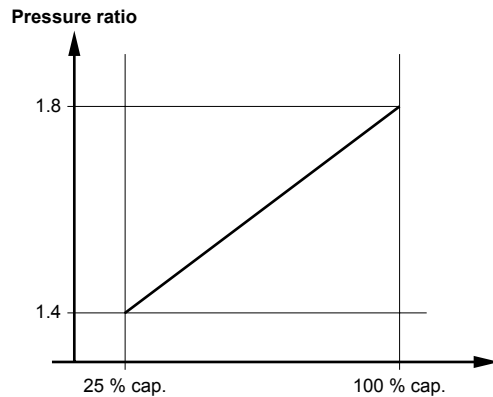

- When the unit is at 25% capacity, the unit will go into alarm when the pressure ratio is below 1.4 for a specified time.
- When the unit is at 100% capacity, the unit will go into alarm when the pressure ratio is below 1.8 for a specified time.
- When the unit is between 25% and 100% capacity, the unit will go into alarm when the pressure ratio is below the calculated value for a specified time.

Pressure Ratio Alarm	
Min Load Setp	1.4
Max Load Setp	1.8

3.24.2 Pressure ratio alarm delay

Function description

Delay time before the unit goes into pressure ratio alarm.

- start up delay: At start up the unit will start to check the pressure ratio after the 180 seconds start up delay timer.
- run delay: When the unit is in operation, the pressure ratio can be below the setpoint for a specified time before the unit will trip on the pressure ratio alarm.

Pressure Ratio Alarm	
Start-Up Delay	180 s
Run Delay	90 s

3.24.3 High Oil DP Alarm

Function description

When the pressure drop across the oil filter becomes too big (higher than 2.5 bar) the unit will shut down and generate the high oil DP alarm.

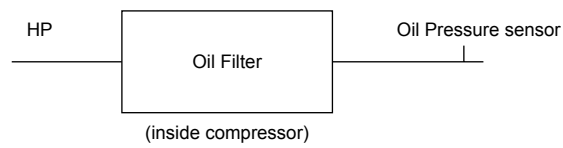

The alarm activates when the DP is higher than 2.5 bar (default) for 20 seconds (default).

$$DP = (HP - \text{oil pressure})$$

High Oil DP Alarm	
Setpoint	2.5 bar
Delay	20 s

3.25 Head Pressure Control

3.25.1 Fan Management

Purpose

To regulate the high pressure

There are 3 possible settings depending on the unit and options:

- Fan steps on/off management
- Phase cut fan management on all fans
- On/off fans + phase cut fan management

Function description

In the controller, the fan management has to be specified. First of all the fan type and fan steps have to be selected.

Condensation	
Enable	Press.
Type	Steps
Fan Steps	1 - 4

Explanation: enable

- None: not used
- Press: fan management is based on the high pressure of the unit
- Temp: not used

Type:

- VFD (variable fan drive) - when the unit is equipped with phase cut fans, this type of fan should be selected.
- Steps - when the unit is equipped with on/off fans, this type of fan should be selected.
- Speedtr - when the unit is equipped with the option OPLA (Option Low Ambient), this type of fan should be selected.

Fan steps:

According to the unit the number of fan steps has to be entered. This setting is only present when the unit is equipped with on/off fans.

3.25.2 Phase cut fan management

Function description

The fan will work according to regulation.

- Through a signal 0-10 VdC (coming from the controller), it is possible to control an external regulator of speed (phase cut device). The MicroTech II controller, besides regulating the fan speed in accordance with the corresponding pressures, enables the on/off function.

The screen is only visible when VFD is selected.

Inverter Config.	
Max. Speed	10.0 V
Min. Speed	0.0 V
Speed Up Time	1 s

- The fans will operate at maximum speed when the controller gives a signal of 10V and at minimum speed when the controller gives a signal of 0V.
- When the fan has to start, the controller will give a maximum speed signal (10V) for 1 second. This is to speed up the fan at fan start. After this speed up time, the fan will go to the required fan speed.

3.25.3 Fan steps on/off management

Function description

The fan will work according to regulation.

Below an example is shown for 5 fan steps:

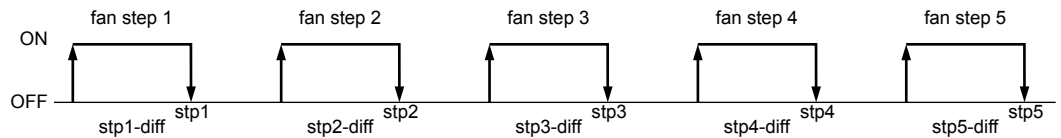

Each step has a different setpoint and differential to cut in and out. These settings can be entered in the manufacturer menu.

Condensation					
Fan step n°	1	2	3	4	5
Setpoint	9.0 bar	12.0 bar	14.0 bar	16.0 bar	18.0 bar
Diff	1.5 bar	3.0 bar	3.5 bar	4.0 bar	5.0 bar

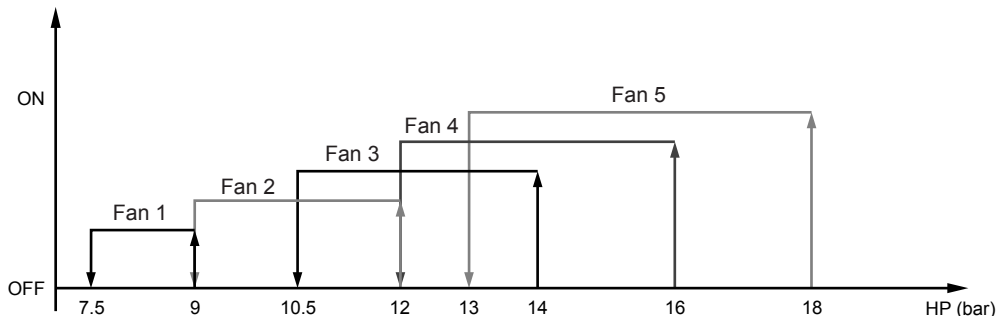

Manufacturer menu

Cond Regulation	
Regul. Band	05.0 bar
Neutral Band	00.0 bar

Cond. Regulation	
Integral Time	600 s
Derivative Time	001 s

These parameters are used for the PID function

Maintenance menu

The controller will calculate the fan speed according to the HP to match the entered HP setpoint.

3.25.4 On/off fans + phase cut (OPLA) management

Function description

The logic of regulation of this system is only present in the units with OPLA and is similar to the two previously described functions. The speed regulator is applied only to some fans while the others are controlled with the steps system. Such system allows the operation of the units in very low air temperatures without the necessity to install complex and more expensive solutions.

3.25.5 Fan silent mode

Function description

This function is only available when the unit is equipped with VFD fans.

The fan silent mode function allows to reduce the unit noise, limiting the maximum fan speed according to a time schedule. The function may operate only if a continuous speed regulation is adopted. Its parameters may be set under "User" password. The function is bypassed whenever the condensation pressure exceeds the condenser pressure stage hold threshold.

This function will allow limitaion of the maximum fan speed in certain periods of a day or some days of the year. It is accessible under the user menu and bypass in case of high pressure problems (stage hold or stage down).

Fan Silent Mode	S
Max Inv. Out	06.0 V

_FSM Monday–Friday		
	Start	Stop
1st	00:00	06:00
2nd	18:00	23:59

_ FSM Saturday		
	Start	Stop
1st	00:00	23:59
2nd	14:00	00:00

FSM Force On Days (1)		
00/00	00/00	00/00
00/00	00/00	00/00
00/00	00/00	00/00

FSM Force On Days (2)		
00/00	00/00	00/00
00/00	00/00	00/00
00/00	00/00	00/00

3.26 Heat Recovery Microprocessor Control

Function description

All the units equipped with the heat recovery water condensers have an additional “microprocessor control” to manage the heat recovery function of the unit.

The microprocessor is installed inside the main control box below the MicroTech key pad as shown below.

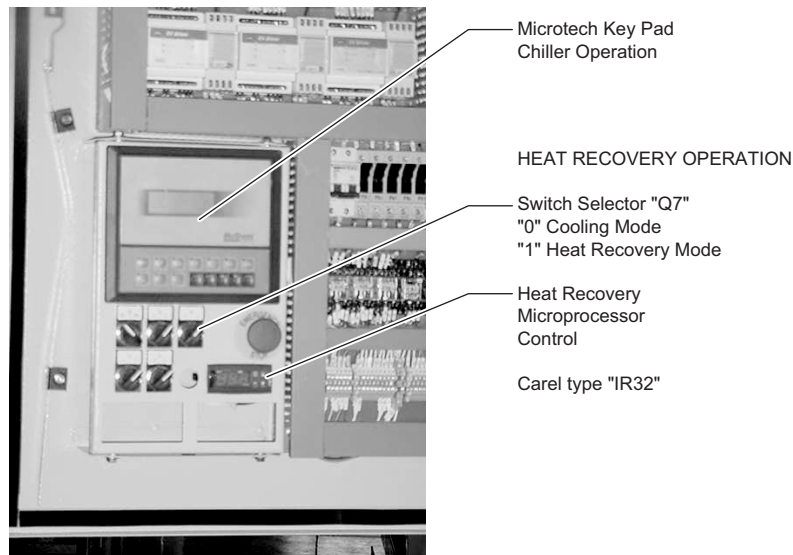

Two different models of microprocessor control are used:

- **IR32W** units with two heat recovery condensers
- **IR32Z** units with three or four heat recovery condensers

Both models are equipped with the temperature sensors NTC and PR100 to control the entering water temperature to the heat recovery condenser, and to measure the temperature of leaving hot water. Temperature sensors are supplied electrically and are connected to the microprocessor but they are not installed in the pipe well pocket. The activation of this device must be done locally by the installer.

The specifications of the sensors are the following:

- **W10** to be installed at the entrance of the condenser
- **W11** to be installed at the exit of the condenser

When the selector switch Q7 enables the heat recovery mode, the sensor “W10” measures the hot water temperature value. If the value is below the setpoint temperature value, it allows the first step to switch the four-way valve from chiller to heat recovery cycle. If the setpoint temperature is not achieved, the microprocessor control inserts all the other steps available according to the number of refrigerant circuits. On the contrary, if the water temperature exceeds the setpoint value, the microprocessor control switches off the steps until the correct temperature is achieved inside the band.

It is of course mandatory that the heat recovery condenser flow switch is on, otherwise the unit will never switch the heat recovery cycle on.

The microprocessor control is normally set at the factory. To verify or change the setpoints, refer to the user manual supplied with the unit.

3.27 Heat Recovery Operation

Function description

The unit supplied with the heat recovery condensers is equipped with an additional microprocessor TC10 (see electrical wiring diagram) with two, three or four steps to control the hot water temperature according to the number of heat exchangers installed in the unit (one step for each compressor). For reference on how to set this microprocessor, see the specific manual supplied with the unit. The heat recovery mode is available only if there is a request for cooling load and the capacity depends on the number of compressors running and their unloading positions.

To run the unit in heat recovery mode, follow the items listed below:

- 1 Verify the installation of the water flow switch done by the installer and check the electrical connections at M3.426 and M3.427 terminal blocks inside the electrical panel.
 - 2 Verify the installation of the microprocessor sensor in the pocket well of the water return common header (done by the installer).
 - 3 Check the setpoint of the return water temperature on the display of the microprocessor TC10 (Carel IR32). Do not exceed the maximum water temperature allowed (see the operating limits) to avoid shutdown of the unit due to high pressure.
 - 4 Switch the water pump on.
 - 5 Switch "ON" the selector "Q7", which allows the unit to run in heat recovery mode. If the microprocessor TC10 asks for hot water, the four-way valve changes the refrigerant circuits from the condenser coil to the heat recovery condenser (first step) and inserts the other circuits until the return hot water is matching the setpoint. In this condition, the fan motors of the respective condenser coils are switched "OFF". Inversely, when the microprocessor reduces the steps, the four-way valve changes the refrigerant circuits from the heat recovery condenser to the condenser coil and switches on the respective fan motors.
 - 6 In case of lack of water in the heat recovery condenser, the unit automatically switches to cooling mode only.
-

3.28 Heat Recovery Microprocessor Set-up

Function description

The unit supplied with the heat recovery condensers is equipped with an additional microprocessor TC10 (see electric wiring diagram) with two, three or four steps to control the hot water temperature according to the number of heat exchangers installed in the unit (one step for each compressor). For reference on how to set this microprocessor, refer to the specific manual supplied with the unit.

Below are important setup values (for references, refer to the microprocessor manual):

Item	Description	Setpoint
St1	Inlet water temperature setpoint	Max 50
St2		N/A
CO	Operating Mode	1
P1	Differential Setpoint	2
P2		N/A
C4	Authority	0.5
C5		1
C6		0
C7		3
C8		5
C9		0
C10		0
C11		0
C12		20
C13		1
C14		0
C15		0
C16		100
C17		5
C18		0
C19		0
C21		30
C22		43
C23		N/A
C24		N/A
P25		8
P26		55
P27		2
P28		20
C29		4
C30		N/A
C31		0
C32		1
C33		0
C50		4
C51		0

Part 3

Troubleshooting

3

Introduction

When a problem occurs, all possible faults have to be checked. This chapter gives a general idea of where to look for faults. Furthermore, the general procedures for refrigeration circuit repair and for electrical circuit repair are explained.

Remark

Not all repair procedures are described. Some procedures are considered common practice.

What is in this part?

This part contains the following chapters:

Chapter	See page
1 Overview of Fault Indications and Safeties	3–3
2 Checking the Inputs and Outputs	3–7
3 Procedure for Software Upload/Download	3–13
4 Procedure to Protect Compressor in Case of Frozen Evaporator	3–33
5 Procedure to Clear the Refrigerant Circuit in Case of Frozen Evaporators	3–35
6 Procedure for the Changing and Configuration of the Display	3–37
7 Procedure for the Changing and Configuration of the PCO ² (“I/O Board”)	3–41
8 Procedure for the Changing of the Electronic Expansion Valve Driver	3–43
9 Procedure for the Changing and Configuration of the Expansion I/O Board (Optional)	3–45
10 Manual Upload or Download Control Test Procedure	3–47
11 Troubleshooting Chart	3–49
12 Prestart System Checklist	3–55

3

1 Overview of Fault Indications and Safeties

1.1 What Is in This Chapter?

Introduction

In the first stage of troubleshooting sequence it is important to interpret the fault indication on the controller display. This will help you to find the cause of the problem.

Overview

This chapter contains the following topics:

Topic	See page
1.2 What to do in the Event of an Alarm?	3-4
1.3 Overview of Safeties	3-5

1.2 What to do in the Event of an Alarm?

In the event of an alarm or a warning, the following must be done.

Step	Action	Result
1	Press the Alarm button to acknowledge the alarm.	<ul style="list-style-type: none"> ■ The Alarm button LED lights up. ■ A unit, circuit or network safety is displayed.
2	Find the cause of the alarm and correct it.	The system is repaired.
3	Press the Alarm button to reset the alarm.	<ul style="list-style-type: none"> ■ The Alarm button LED goes out and the alarm screen is deactivated. ■ "No alarm detected" is displayed on the screen. ■ Press Menu button to go back to normal screen. <p>Remark: After resetting the alarm it is possible to consult the safety information by using the buffer alarm menu.</p>
4	After the error has been corrected and the alarm has been reset, the unit will automatically restart.	The unit starts again.

1.3 Overview of Safeties

The following table shows a list of possible alarms with the identifier number, the cause and the reset type (A = auto, M = manual).

	Alarm	Alarm cause	Reset
001	Phase monitor	Intervention of the device control of phases. The phases are not correctly sequenced or the supply voltage is out of the acceptable limits.	M
002	Freeze alarm	Anti-freeze protection. The outlet water temperature is equal to the anti-freeze value.	M
005	Evaporator Flow Alarm	Intervention of Evaporator Flow switch. The water pump could be off.	M
006	Low pressure alarm (transducer)	Low pressure intervention by microchip	M
007	High discharge temperature alarm (temperature switch)	Intervention of the discharge temperature switch	M
008	Fault transition	Starting procedure is not complete. Verify the contactors.	M
009	Low oil pressure	The oil pressure is not enough for the correct lubrication of the compressor. Verify if the condensing pressure is at least 3 times the suction pressure.	M
011	High oil pressure difference	High oil differential pressure. The oil filter could be dirty or the solenoid valve doesn't work correctly.	M
012	High pressure alarm (pressure switch)	Intervention of the high pressure mechanical switch	M
016	Compressor overload	Intervention of the compressor thermal motor or intervention of the high temperature switch	M
023	High pressure alarm (transducer)	Intervention of the high pressure by microchip	M
030	B1 probe fault or not connected	Sensor B1 error	M
031	B2 probe fault or not connected	Sensor B2 error	M
032	B3 probe fault or not connected	Sensor B3 error	M
033	B4 probe fault or not connected	Sensor B4 error	M
034	B5 probe fault or not connected	Sensor B5 error	M
035	B6 probe fault or not connected	Sensor B6 error	M
036	B7 probe fault or not connected	Sensor B7 error	M
037	B8 probe fault or not connected	Sensor B8 error	M
039	Evaporator pump maintenance	Request of evaporator pump maintenance	M
040	Condenser pump maintenance	Request of condenser pump maintenance	M
041	Compressor maintenance	Request of compressor maintenance	M
050	Unit 1 offline	Compressor # 1 network error	A
051	Unit 2 offline	Compressor # 2 network error	A
052	Unit 3 offline	Compressor # 3 network error	A
053	Unit 4 offline	Compressor # 4 network error	A
D01	EXV Driver Probe fault	Driver EXV probe error	A
D02	EXV Step motor error	EXV valve motor error	A

Alarm		Alarm cause	Reset
D03	EXV Driver Eeprom error	Driver EXV Eeprom error	M
D04	EXV Driver battery error	Drive EXV battery error	A
D08	EXV not closed during power off	Valve doesn't close without power	M
	Alarms Expansion E	Expansion Board Offline or not recognized	M

2 Checking the Inputs and Outputs

2.1 What is in This Chapter?

Introduction This chapter gives information about the configuration of the input and output channels of the MicroTech II controller.

Overview This chapter contains the following topics:

Topic	See page
2.2 List of Digital Inputs	3–8
2.3 List of Analog Inputs	3–9
2.4 List of Digital Outputs	3–10
2.5 List of Analog Outputs	3–11
2.6 List of Input and Output Channels of the Expansion Board # 1 (Option Econo- mizer)	3–12

2.2 List of Digital Inputs

The table below gives an overview of all the digital inputs.

N	BOARD # 1	BOARD # 2
1	Compressor # 1 On/Off	Compressor # 3 On/Off
2	Compressor # 2 On/Off	Compressor # 4 On/Off
3	Evaporator Flow Switch	---
4	Phase monitor	---
5	Double Setpoint (Ice Mode)	---
6	High pressure Switch # 1	High Pressure Switch # 3
7	High pressure Switch # 2	High Pressure Switch # 4
8		---
9	Current Limit enable	---
10	Low Pressure Switch # 1	Low Pressure Switch # 3
11	Low Pressure Switch # 2	Low Pressure Switch # 4
12	Transition Fault # 1	Transition Fault # 3
13	Transition Fault # 2	Transition Fault # 4
14	Overload # 1	Overload # 3
15	Overload # 2	Overload # 4
16	On/Off Unit	---
17	Remote Start/Stop	---
18	External alarm	---

2.3 List of Analog Inputs

The table below gives an overview of all the analog inputs.

N	BOARD # 1	BOARD # 2
B1	Oil pressure # 1	Oil pressure # 3
B2	Oil pressure # 2	Oil pressure # 4
B3	Setpoint Override	---
B4	Gas temperature on compressor discharge # 1	Gas temperature on compressor discharge # 3
B5	Gas temperature on compressor discharge # 2	Gas temperature on compressor discharge # 4
B6	Gas pressure on compressor discharge # 1	Gas pressure on compressor discharge # 3
B7	Gas pressure on compressor discharge # 2	Gas pressure on compressor discharge # 4
B8	Demand limit/Current limit	---
B9	In water Temperature (common on 2 Evap unit)	In water Temperature (common on 2 Evap unit)
B10	Evaporator Out water Temperature (Common on 2 Evap unit)	Evaporator Out water Temperature (Common on 2 Evap unit)

2.4 List of Digital Outputs

The table below gives an overview of all the digital outputs.

N	BOARD # 1	BOARD # 2
1	Start Compressor # 1	Start Compressor # 3
2	Load Compressor # 1	Load Compressor # 3
3	Unload Compressor # 1	Unload Compressor # 3
4	Liquid Injection # 1	Liquid Injection # 3
5	Liquid Line # 1 (*)	Liquid Line # 3 (***)
6	First step fan # 1	First step fan # 3
7	Second step fan # 1	Second step fan # 3
8	Third step fan # 1	Third step fan # 3
9	Start Compressor # 2	Start Compressor # 4
10	Load Compressor # 2	Load Compressor # 4
11	Unload Compressor # 2	Unload Compressor # 4
12	Evaporator water pump	---
13	Unit Alarm	---
14	Liquid Injection # 2	Liquid Injection # 4
15	Liquid Line # 2 (**)	Liquid Line # 4 (****)
16	First step fan # 2	First step fan # 4
17	Second step fan # 2	Second step fan # 4
18	Third step fan # 2	Third step fan # 4

Notes

(*) If Thermostatic expansion valve is used. Fourth step fan # 1 if electronic expansion valve is used.

(**) If Thermostatic expansion valve is used. Fourth step fan # 2 if electronic expansion valve is used.

(***) If Thermostatic expansion valve is used. Fourth step fan # 3 if electronic expansion valve is used.

(****) If Thermostatic expansion valve is used. Fourth step fan # 4 if electronic expansion valve is used.

2.5 List of Analog Outputs

The table below gives an overview of all the analog outputs.

N	BOARD # 1	BOARD # 2
1	VFD output signal # 1	VFD output signal # 3
2	Second VFD output signal # 1	Second VFD output signal # 3
3	SPARE	SPARE
4	VFD output signal # 2	VFD output signal # 4
5	Second VFD output signal # 2	Second VFD output signal # 4
6	SPARE	SPARE

2.6 List of Input and Output Channels of the Expansion Board # 1 (Option Economizer)

The table below gives an overview of all the inputs and outputs of the expansion board.

Analog Input

N	Expansion BOARD # 1	TYPE
1	SPARE	---
2	SPARE	---
3	SPARE	---
4	SPARE	---

Digital Input

N	Expansion BOARD # 1
1	SPARE
2	SPARE
3	SPARE
4	SPARE

Analog Output

N	Expansion BOARD # 1
1	SPARE

Digital Output

N	Expansion BOARD # 1
1	Economizer # 1
2	Economizer # 2
3	Economizer # 3
4	Economizer # 4

3 Procedure for Software Upload/Download

3.1 What is in This Chapter?



Overview

This chapter contains the following topics:



Topic	See page
3.2 Copy from the Software Key to pCO ²	3-14
3.3 Copy from pCO ² to the Software Key	3-15
3.4-Installation of Winload32 on the PC and Programming a Controller	3-16
3.5 Copy Software from WinLoad32 to the Software key	3-31



3.2 Copy from the Software Key to pCO²

-
- Switch off the pCO² and remove the "expansion memory" cover with a screwdriver (see "Copy from pCO² to the Software Key" on page 3–15/Fig. 1).
 - Set the key selector on 
 - Insert the key in the corresponding pin connector as shown. (see "Copy from pCO² to the Software Key" on page 3–15/Fig. 2).
 - Press the buttons UP and DOWN simultaneously and then supply power to the pCO².
 - Check if the LED on the key is on (red color )
 - Wait until the request for copying appears on the LCD display, then release the buttons and confirm by pressing ENTER.
 - The data transfer operation takes about 50s using the 1MB key and 100s using the 2MB one. The display will show a progressive series of numbers.
 - Once copied, the application program will start. Switch off the pCO², remove the key, put the cover in its place and switch on the pCO² again.
 - Now the pCO² works with the program transferred by the key.
-

3.3 Copy from pCO² to the Software Key

- Switch off the pCO² and remove the "expansion memory" cover with a screwdriver (see Fig. 1).
- Set the key selector on 
- Insert the key in the corresponding pin connector as shown (see Fig. 2).
- Press the buttons UP and DOWN simultaneously and then supply the pCO².
- Check if the LED on the key is on (green color )
- Wait until the request for copying appears on the LCD display, then release the buttons and confirm by pressing ENTER.
- If the application includes a password to protect the software, use the UP and DOWN buttons on the terminal to enter the correct password. Then press enter.
- The data transfer operation takes about 50s using the 1MB key and 100s using the 2MB one. The display will show a progressive series of numbers.
- Once copied, the application program starts. Switch off the pCO², remove the key, put the cover in its place and switch on the pCO² again.
- Now the key contains the program transferred by the pCO².

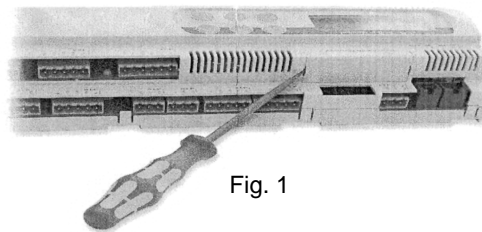

Fig. 1

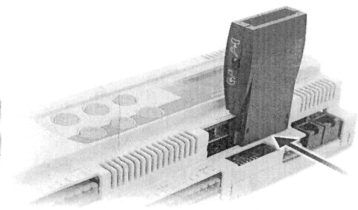
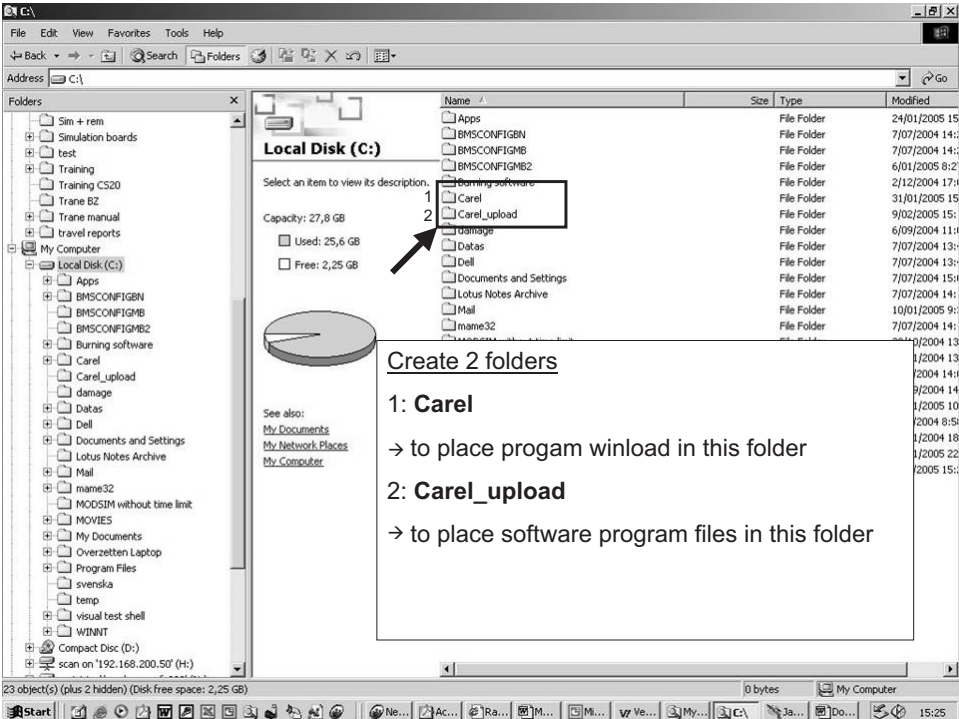
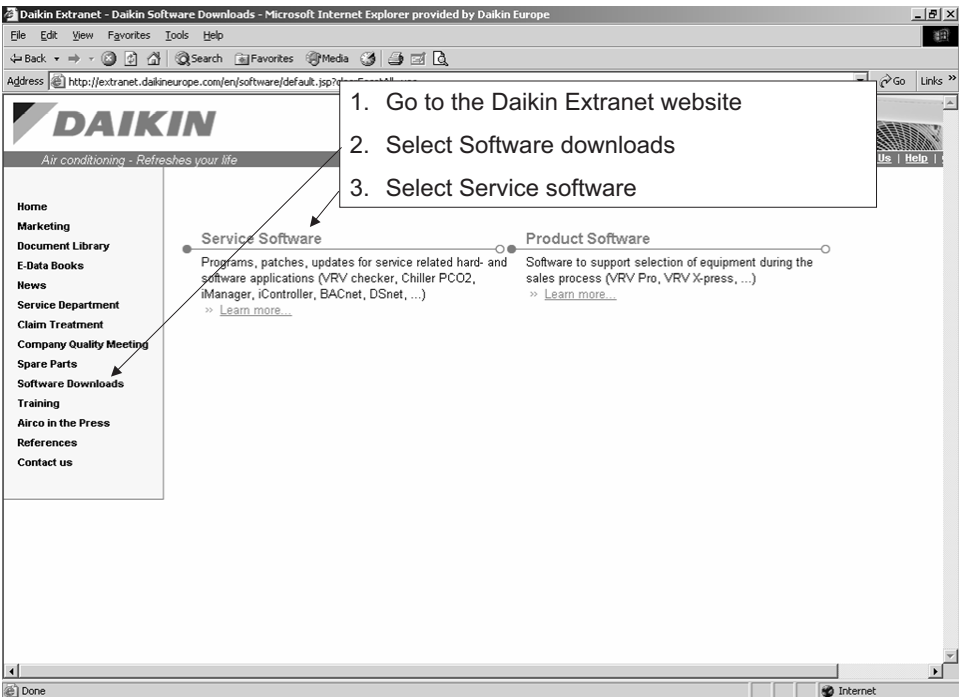
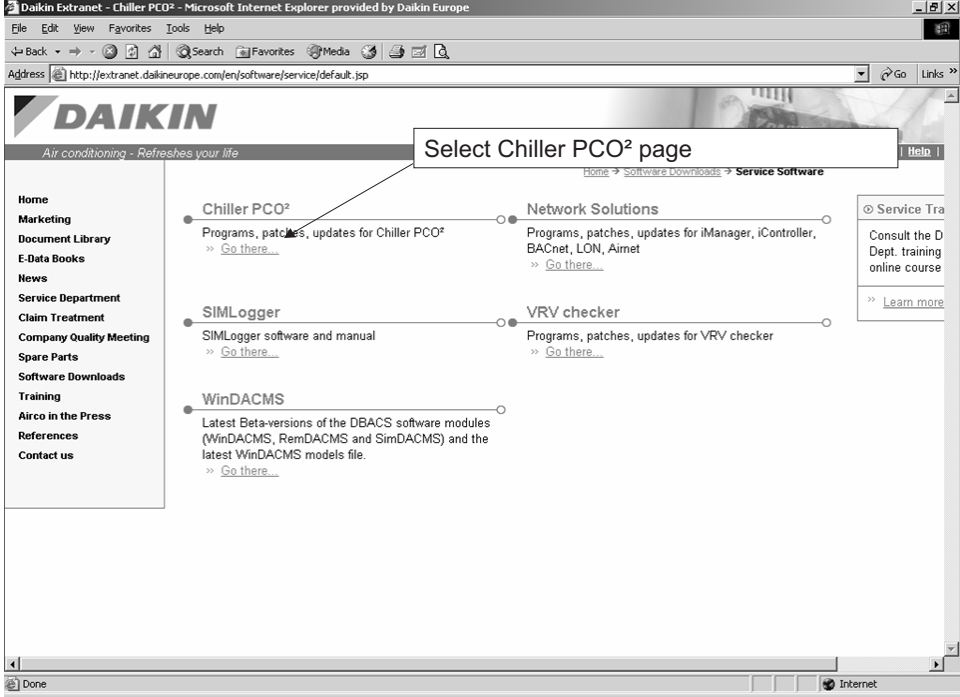
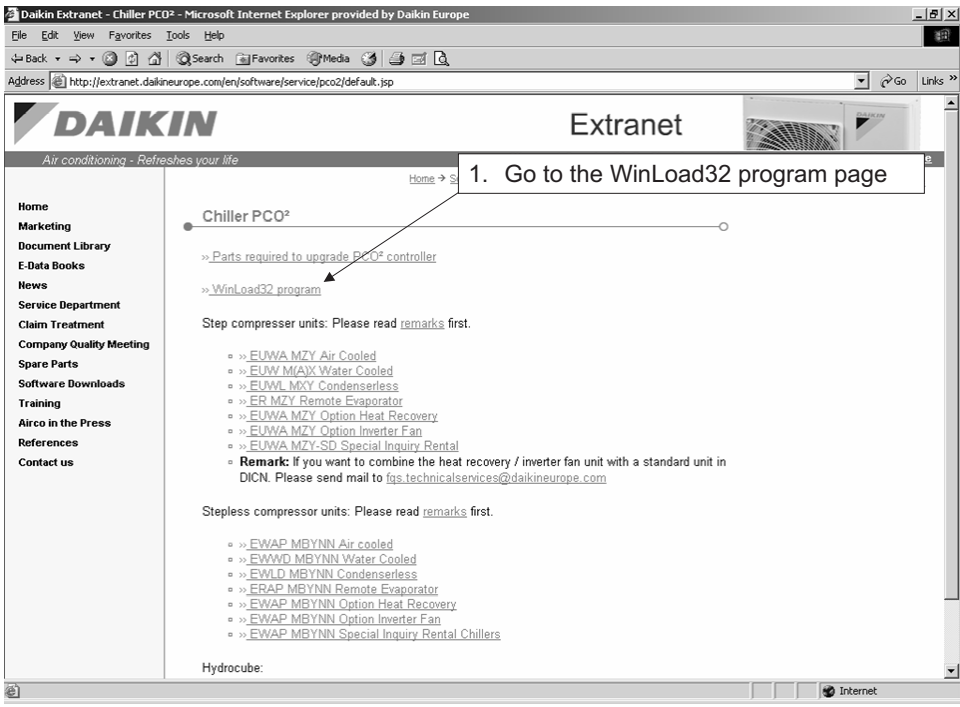

Fig. 2

3.4 Installation of Winload32 on the PC and Programming a Controller

3

Step	Action
1	 <p>Create 2 folders</p> <ol style="list-style-type: none"> Carel → to place program winload in this folder Carel_upload → to place software program files in this folder
2	 <ol style="list-style-type: none"> Go to the Daikin Extranet website Select Software downloads Select Service software

Step	Action
3	 <p>The screenshot shows the 'Chiller PCO²' page on the Daikin Extranet. A callout box with the text 'Select Chiller PCO² page' points to the 'Chiller PCO²' link in the main content area. The page includes a navigation menu on the left and several product categories with links to go there.</p>
4	 <p>The screenshot shows the 'WinLoad32 program page' on the Daikin Extranet. A callout box with the text '1. Go to the WinLoad32 program page' points to the 'WinLoad32 program' link under the 'Chiller PCO²' section. The page lists various compressor units and provides a remark about combining heat recovery/inverter fan units.</p>

3

Step	Action
5	<p>1. Click on winload32 to download the file</p> <p>2. "file download" screen will appear</p> <p>3. Click on save</p>

6	<p>Download the file to your hard disk</p> <p>1. Browse to the place were you want to save the file</p> <p>Example: save on C-drive</p> <p>2. Press save</p>
---	--

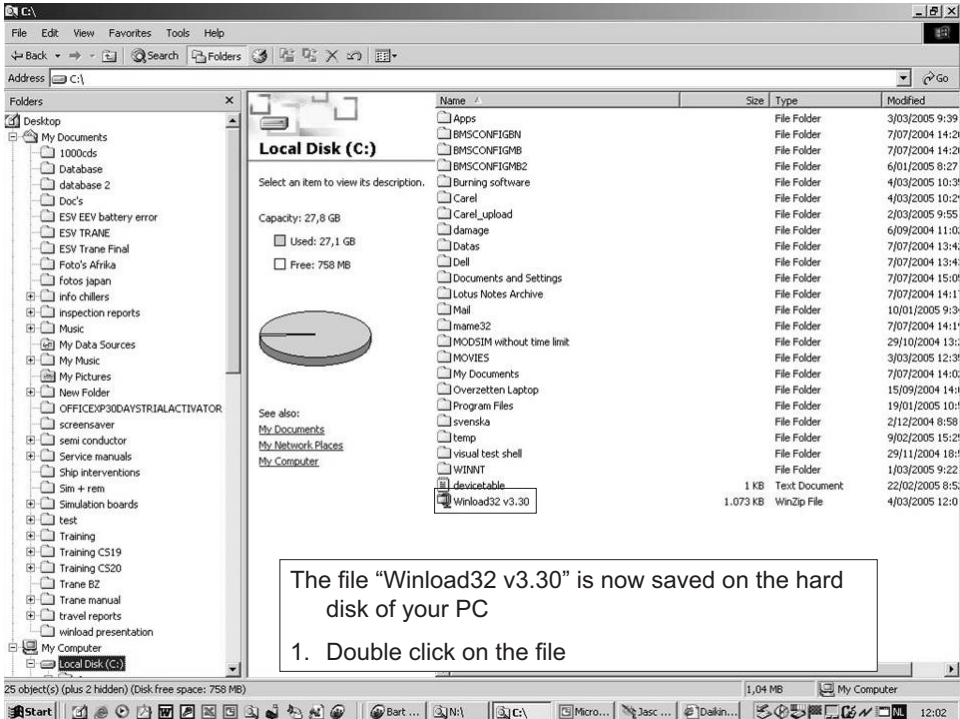
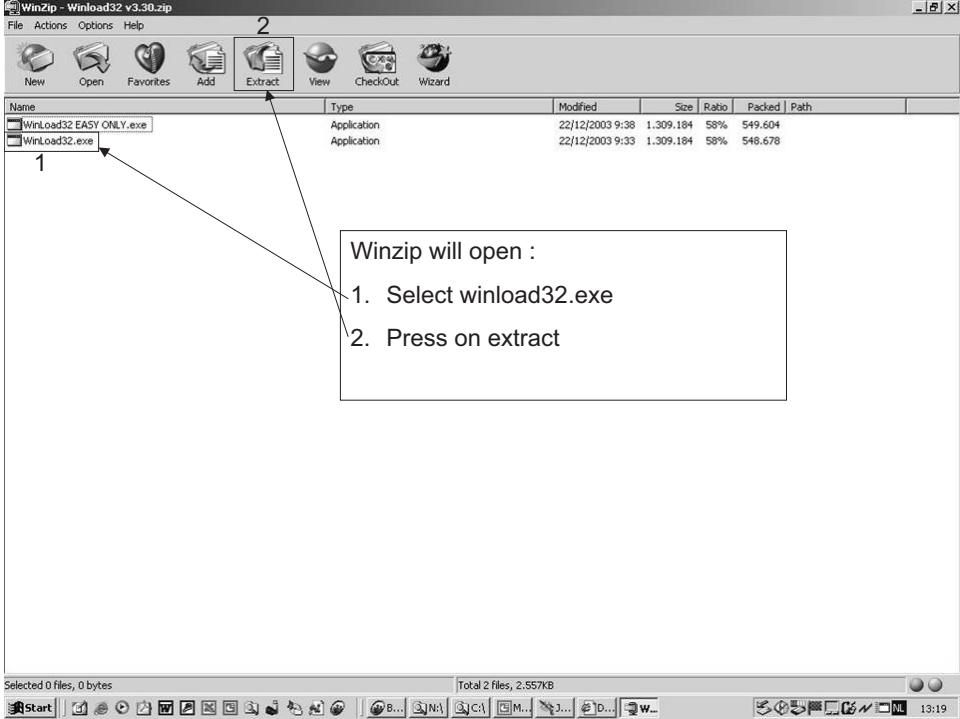
Step	Action
7	 <p>The file "Winload32 v3.30" is now saved on the hard disk of your PC</p> <ol style="list-style-type: none">1. Double click on the file
8	 <p>Winzip will open :</p> <ol style="list-style-type: none">1. Select winload32.exe2. Press on extract

3

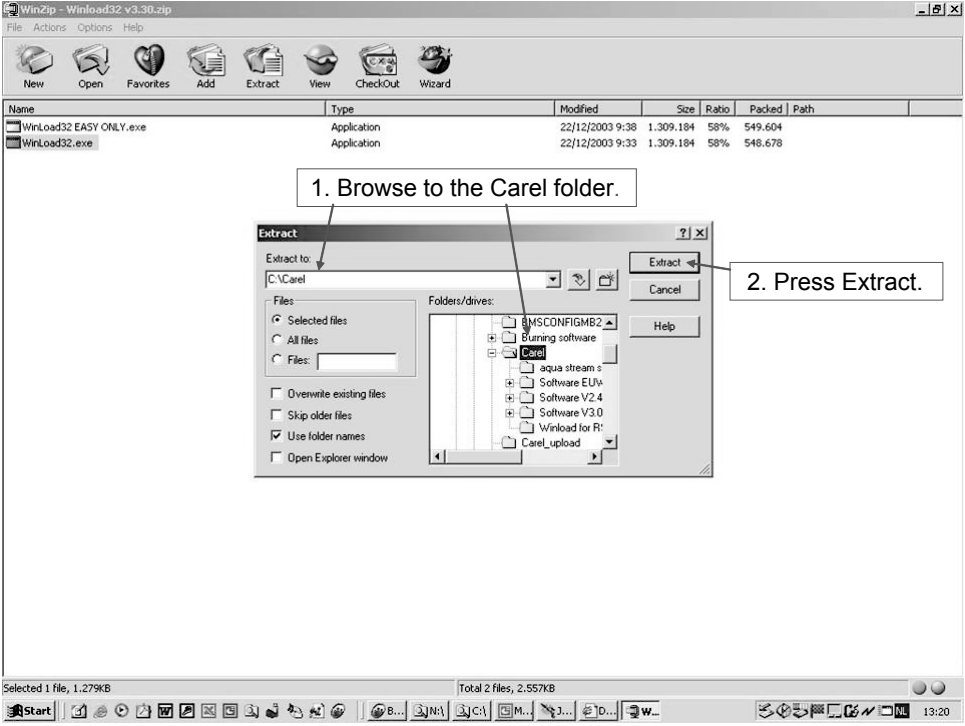
Step	Action
9	

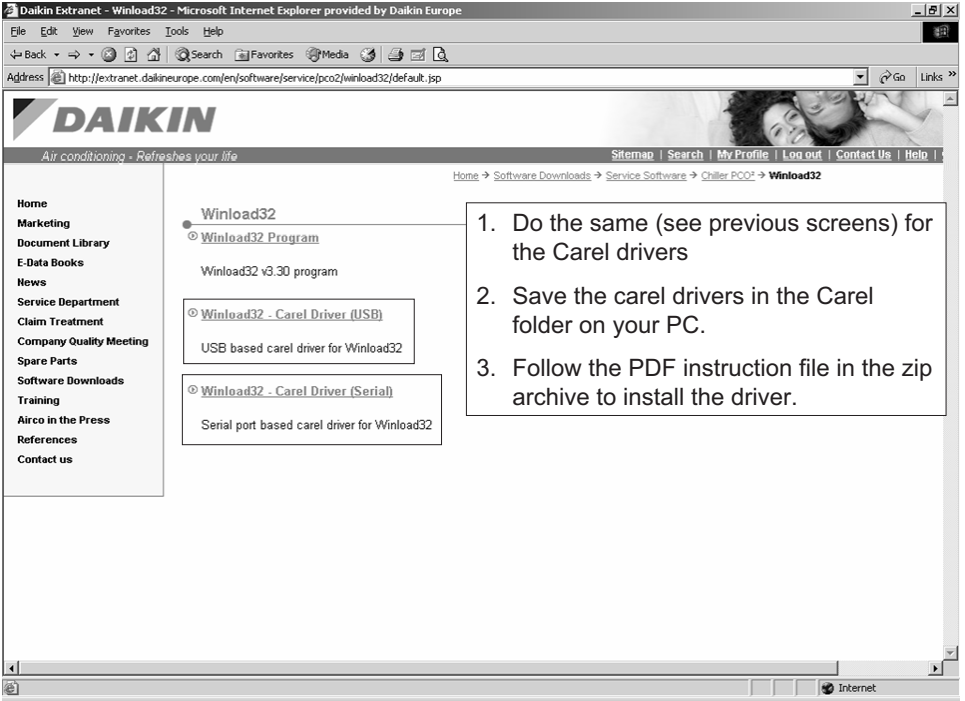
10	
----	--

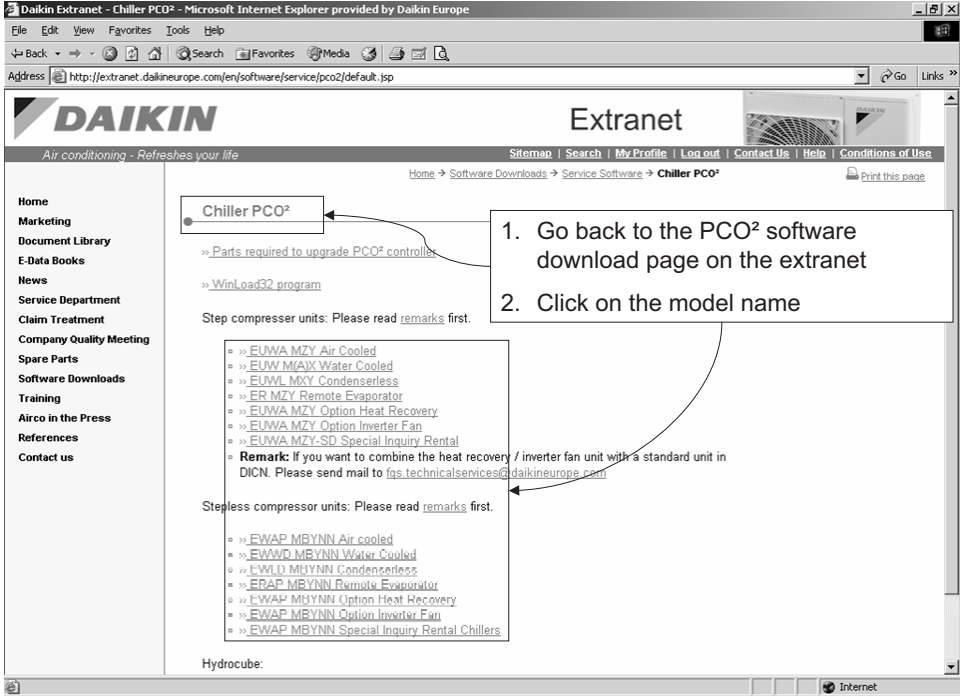
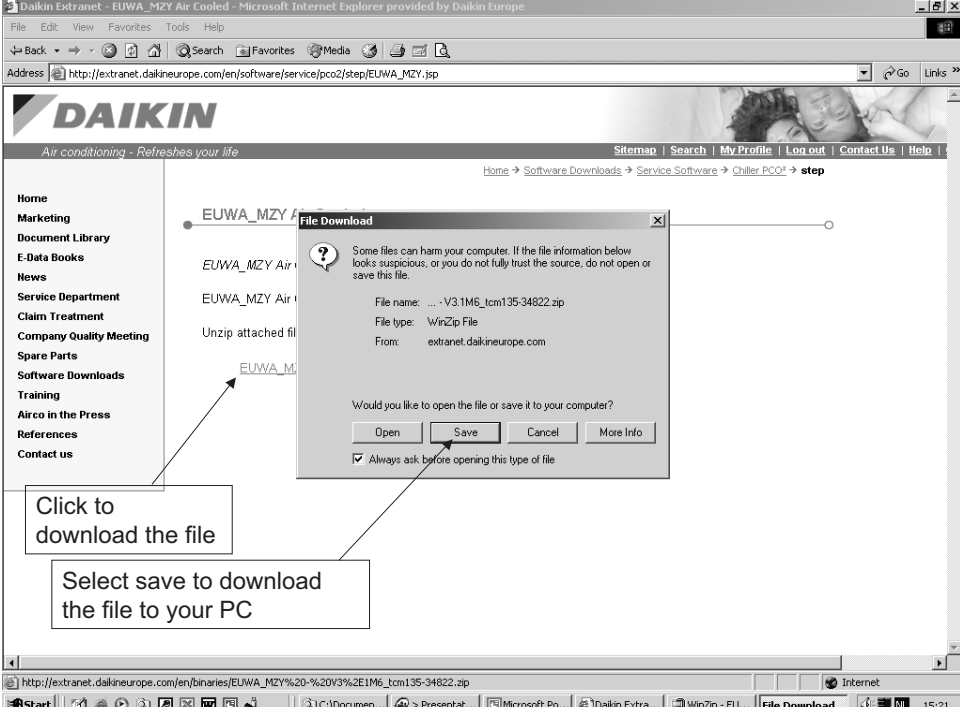
Step	Action
11	 <p>1. Go back to the PCO² software download page on the extranet</p> <p>2. Click on the model name</p>
12	 <p>Click to download the file</p> <p>Select save to download the file to your PC</p>

Step

Action

13

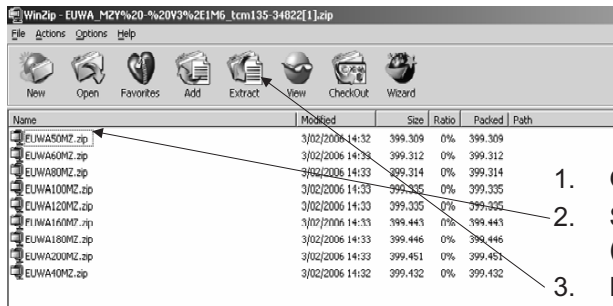

1. Open the saved zip file
2. Select the file for the unit (capacity)
3. Press extract
4. Choose a location where you want to save the file (example: C-drive)
5. Click extract

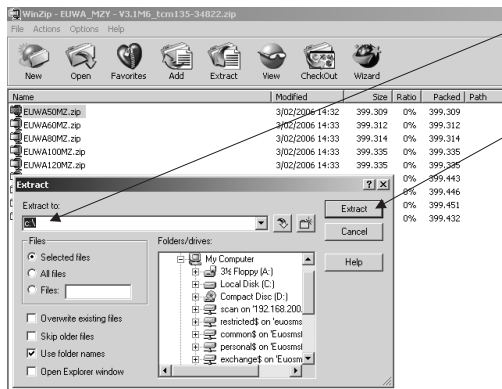

14

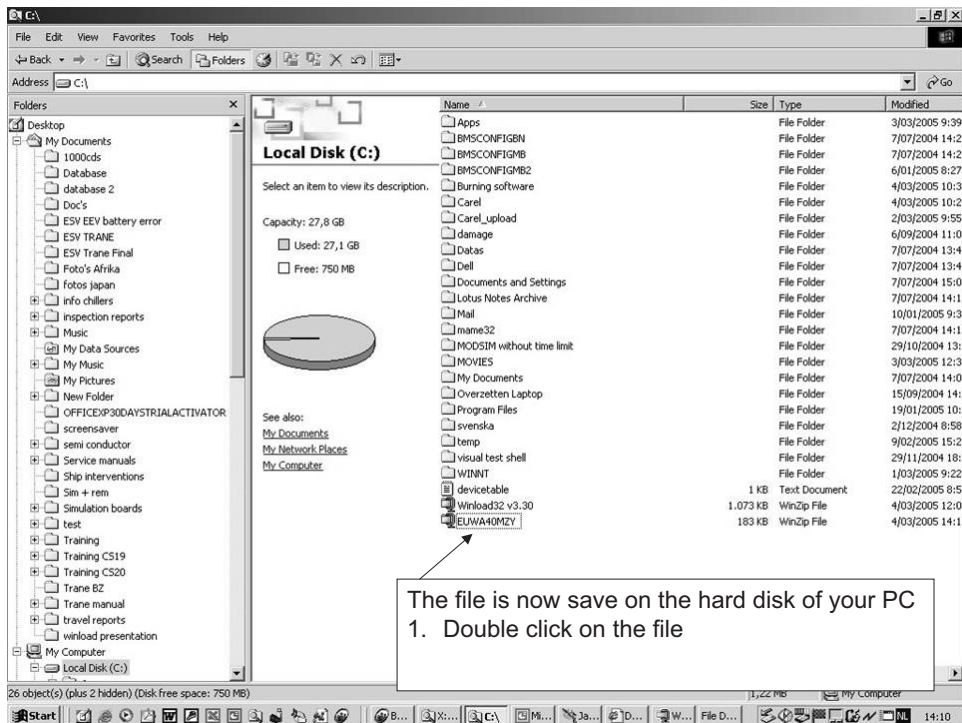

The file is now save on the hard disk of your PC
1. Double click on the file

3

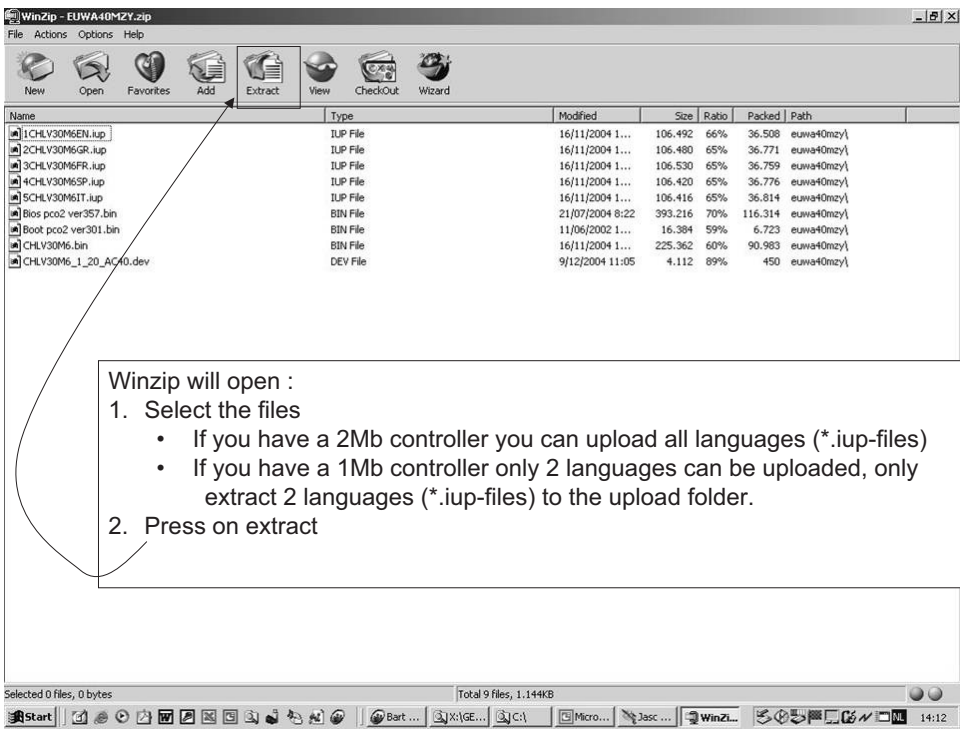
Step	Action
15	 <p>Winzip will open :</p> <ol style="list-style-type: none"> Select the files <ul style="list-style-type: none"> If you have a 2Mb controller you can upload all languages (*.iup-files) If you have a 1Mb controller only 2 languages can be uploaded, only extract 2 languages (*.iup-files) to the upload folder. Press on extract

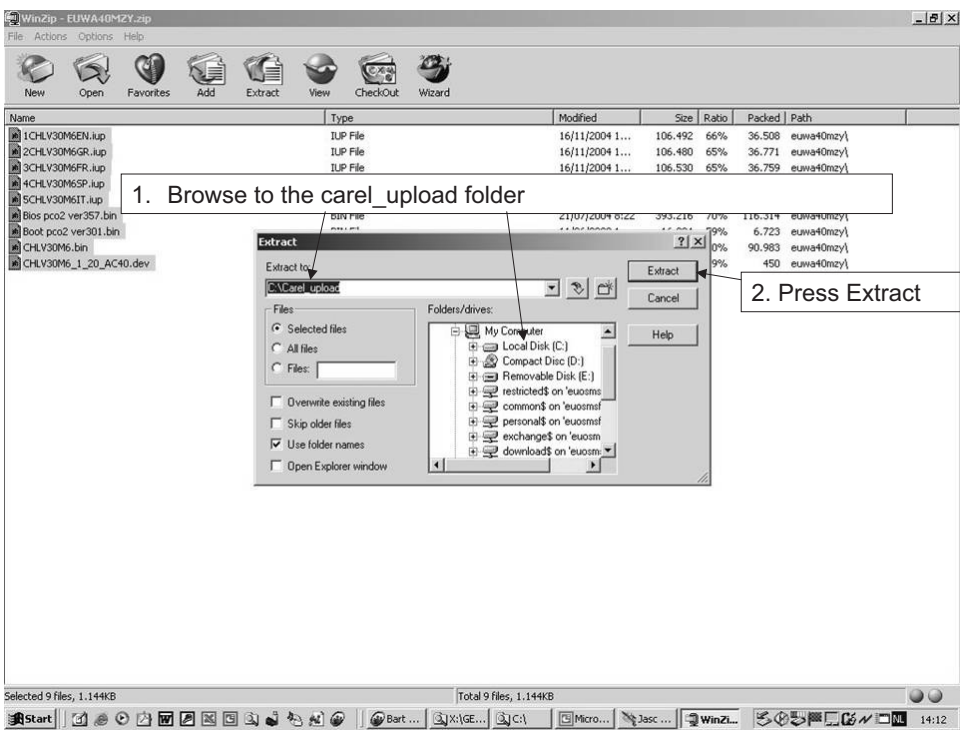
16	 <p>1. Browse to the carel_upload folder</p> <p>2. Press Extract</p>
----	--

Step

Action

17

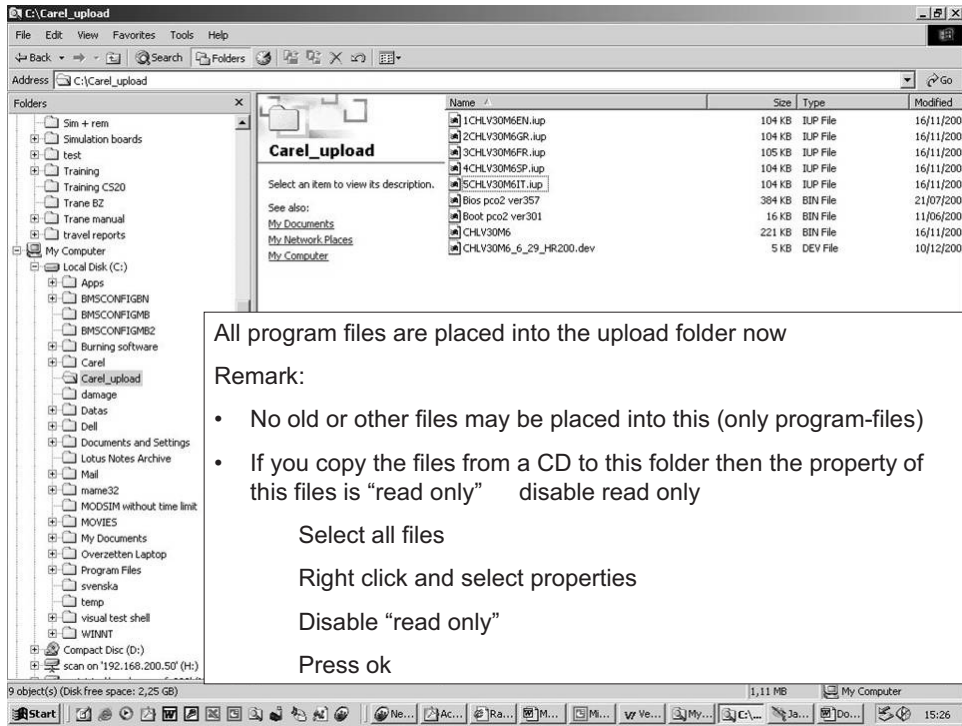

All program files are placed into the upload folder now

Remark:

- No old or other files may be placed into this (only program-files)
- If you copy the files from a CD to this folder then the property of this files is "read only" disable read only

Select all files

Right click and select properties

Disable "read only"

Press ok

18

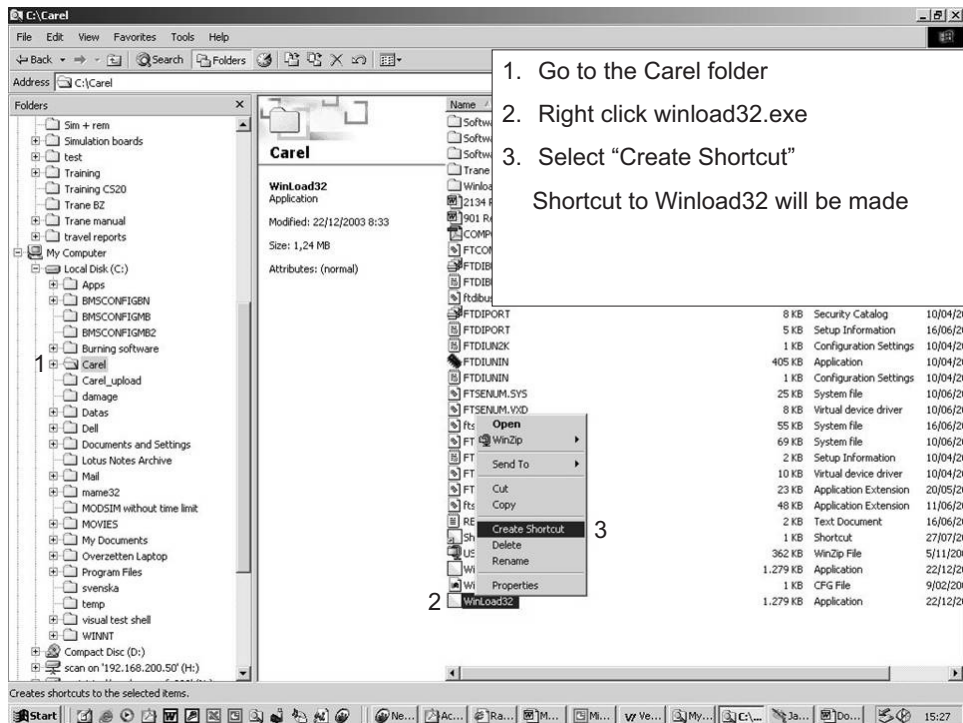

1. Go to the Carel folder

2. Right click winload32.exe

3. Select "Create Shortcut"

Shortcut to Winload32 will be made

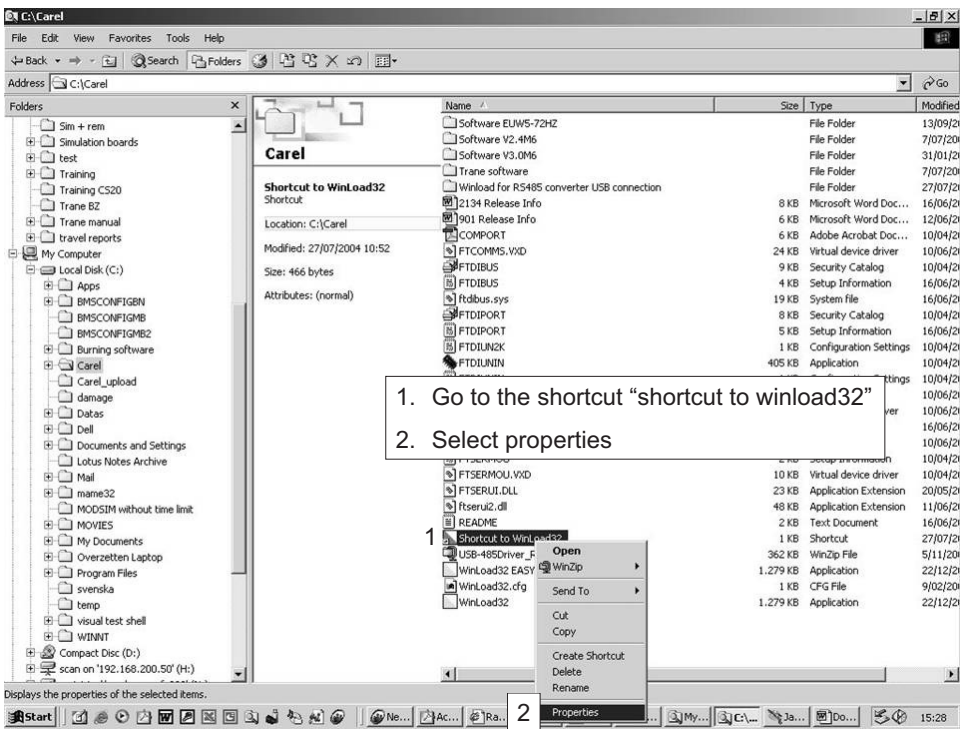
Step	Action
19	 <p>1. Go to the shortcut "shortcut to winload32"</p> <p>2. Select properties</p>

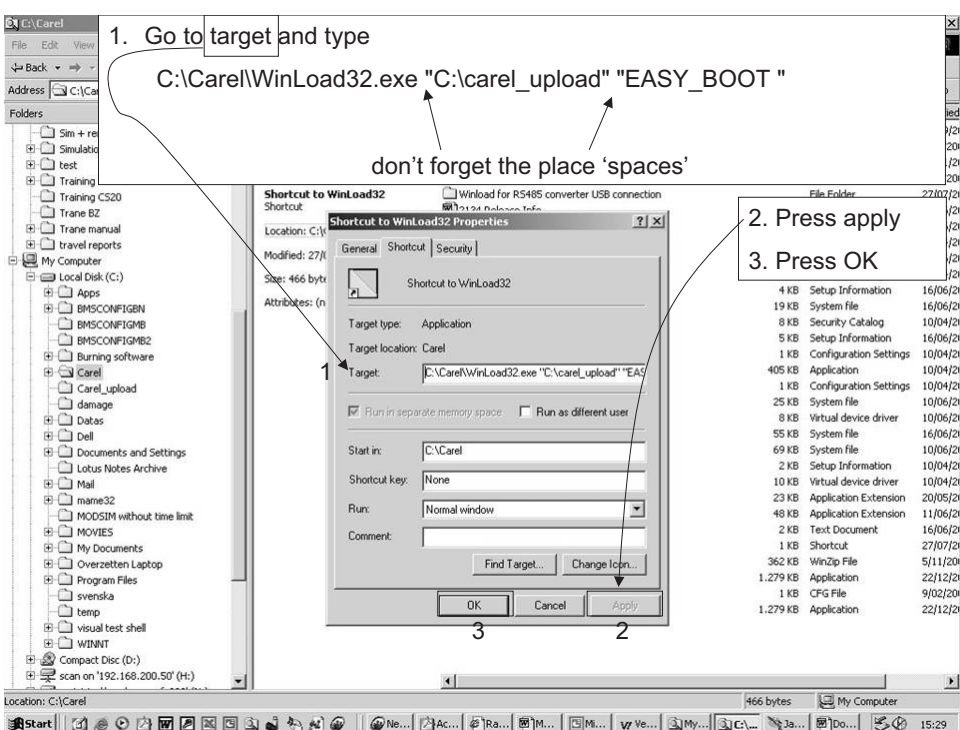
20	 <p>1. Go to target and type C:\Carel\WinLoad32.exe "C:\carel_upload" "EASY_BOOT "</p> <p>don't forget the place 'spaces'</p> <p>2. Press apply</p> <p>3. Press OK</p>
----	--

Step

Action

21

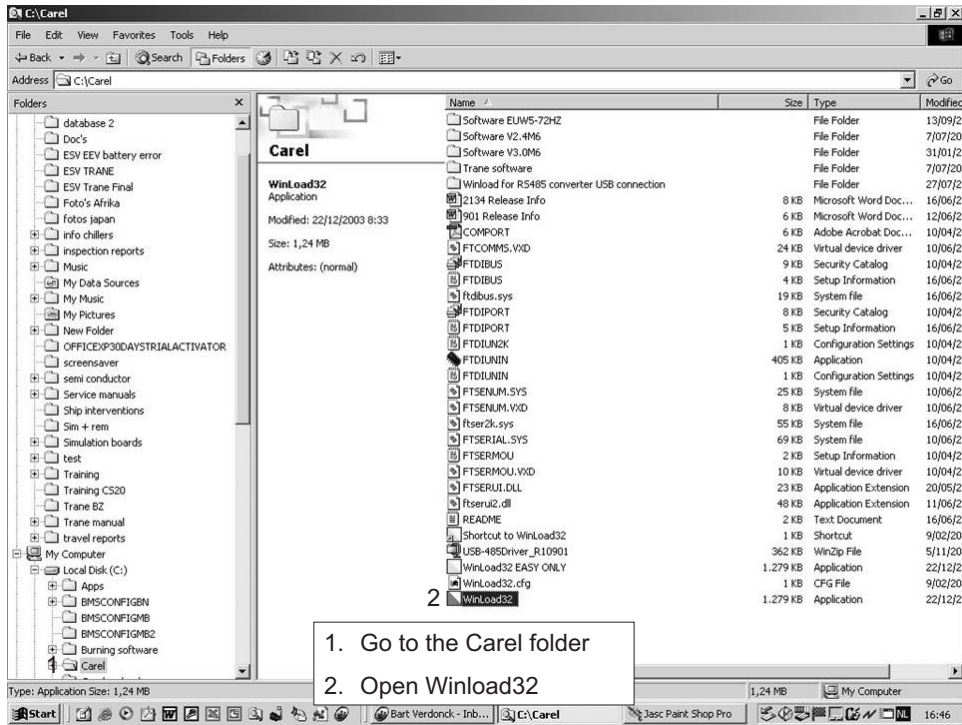

22

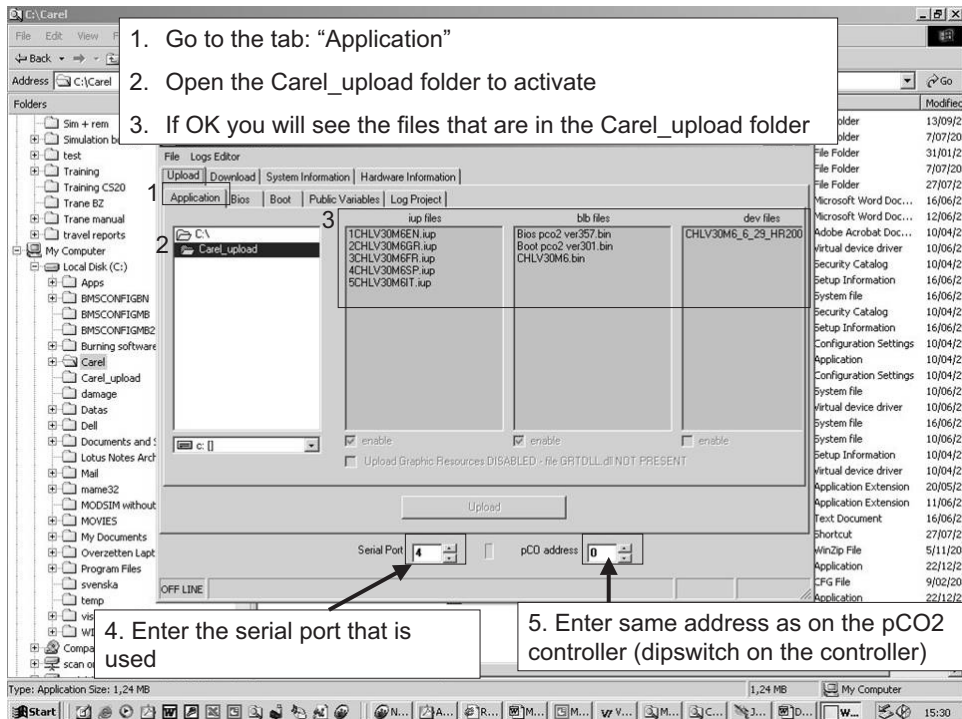

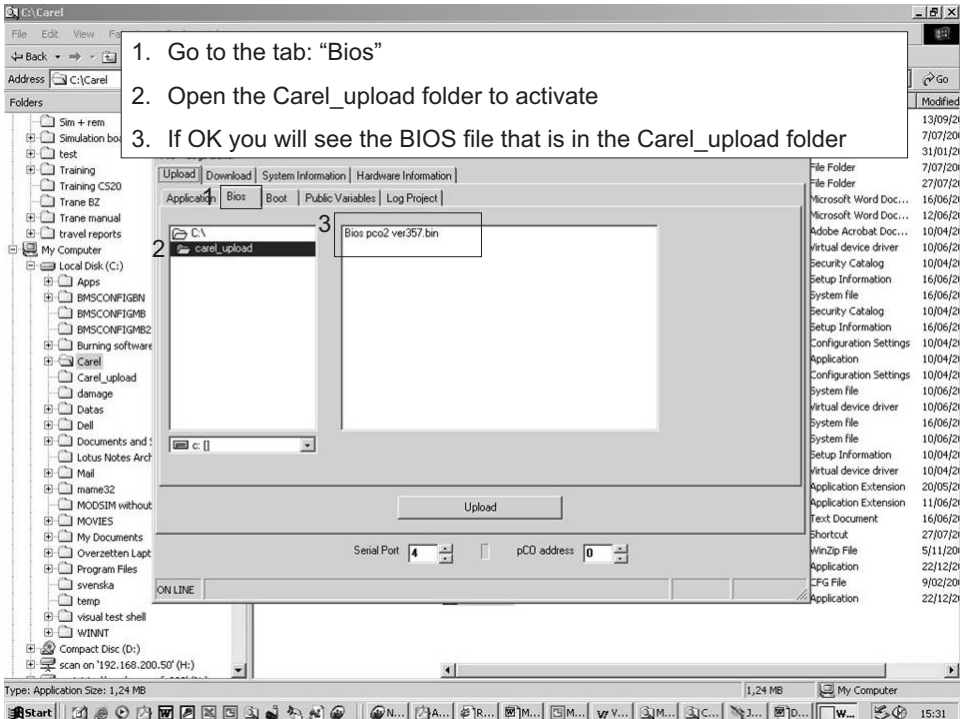
Step	Action
23	<div style="border: 1px solid black; padding: 10px;"> <ol style="list-style-type: none"> 1. Go to the tab: "Bios" 2. Open the Carel_upload folder to activate 3. If OK you will see the BIOS file that is in the Carel_upload folder  </div>

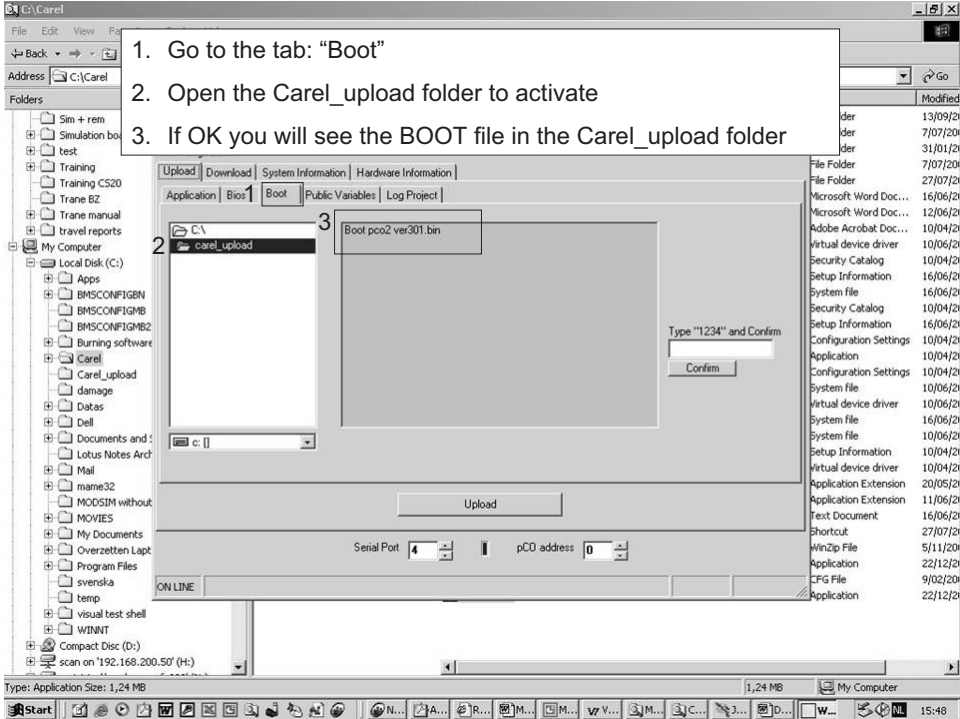
24	<div style="border: 1px solid black; padding: 10px;"> <ol style="list-style-type: none"> 1. Go to the tab: "Boot" 2. Open the Carel_upload folder to activate 3. If OK you will see the BOOT file in the Carel_upload folder  </div>
----	---

Step

Action

25

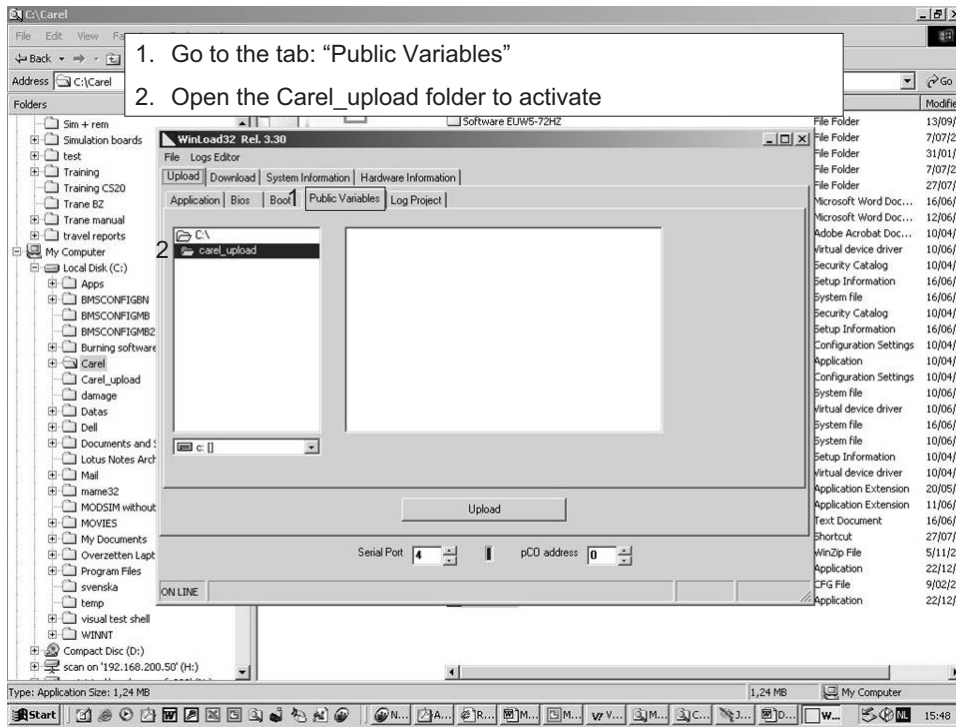

26

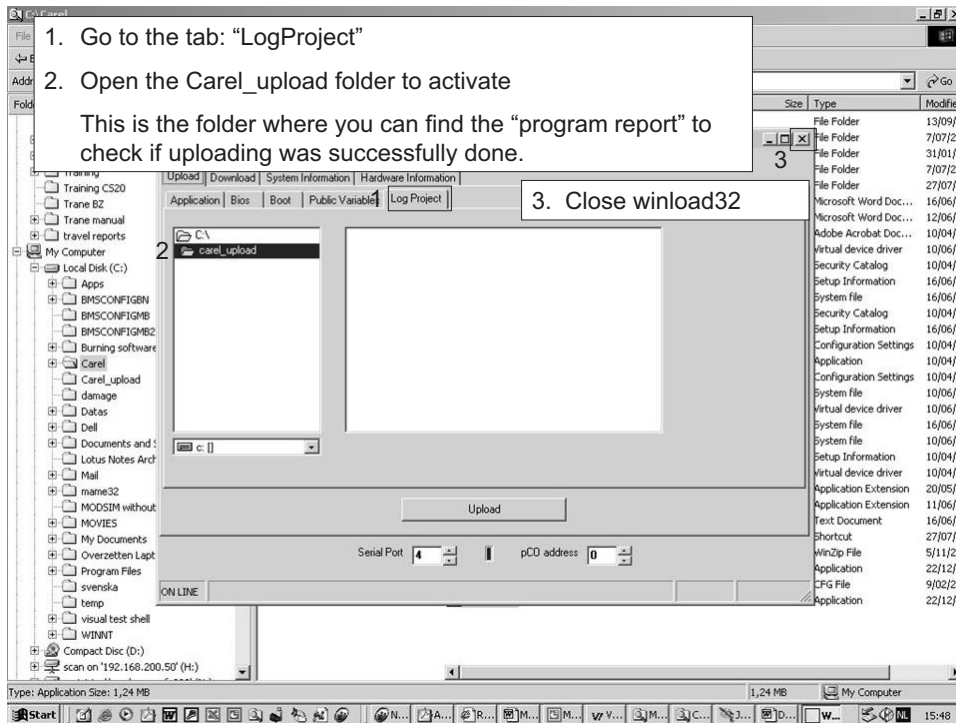

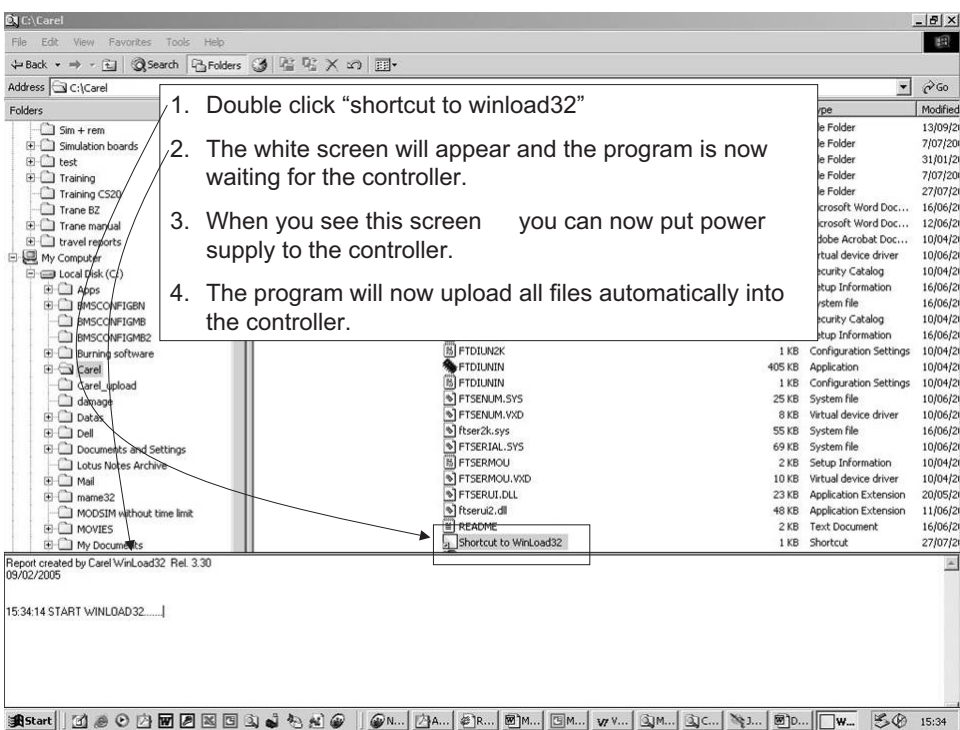
Step	Action
27	 <ol style="list-style-type: none"> 1. Double click "shortcut to winload32" 2. The white screen will appear and the program is now waiting for the controller. 3. When you see this screen you can now put power supply to the controller. 4. The program will now upload all files automatically into the controller. <p>Report created by Carel WinLoad32 Rel. 3.30 09/02/2005</p> <pre>15:34:14 START WINLOAD32.....</pre>

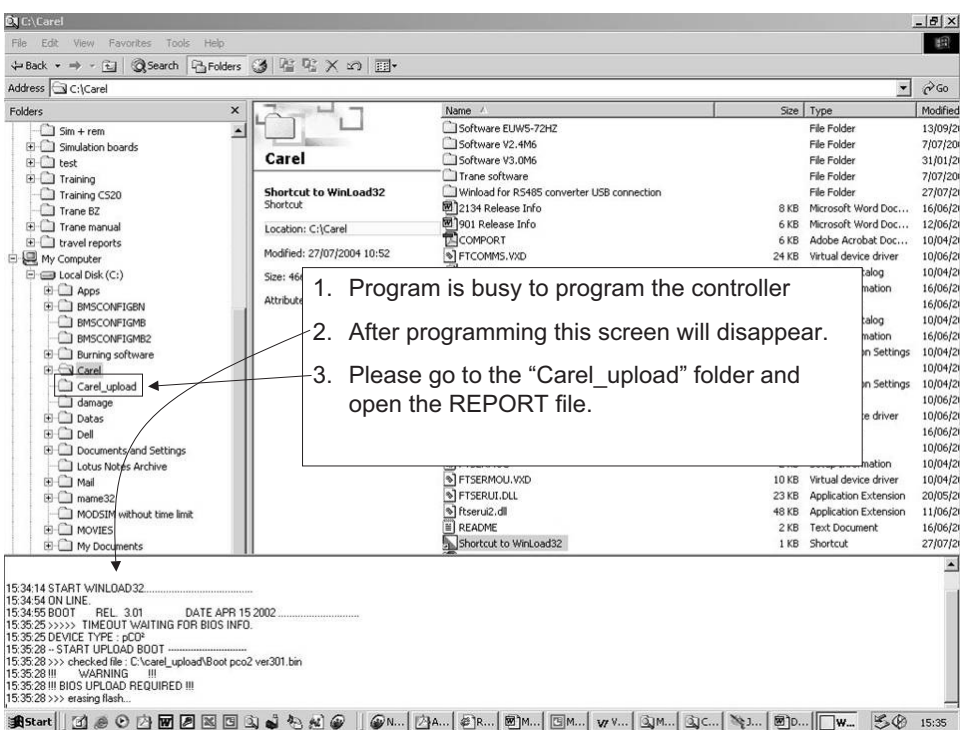

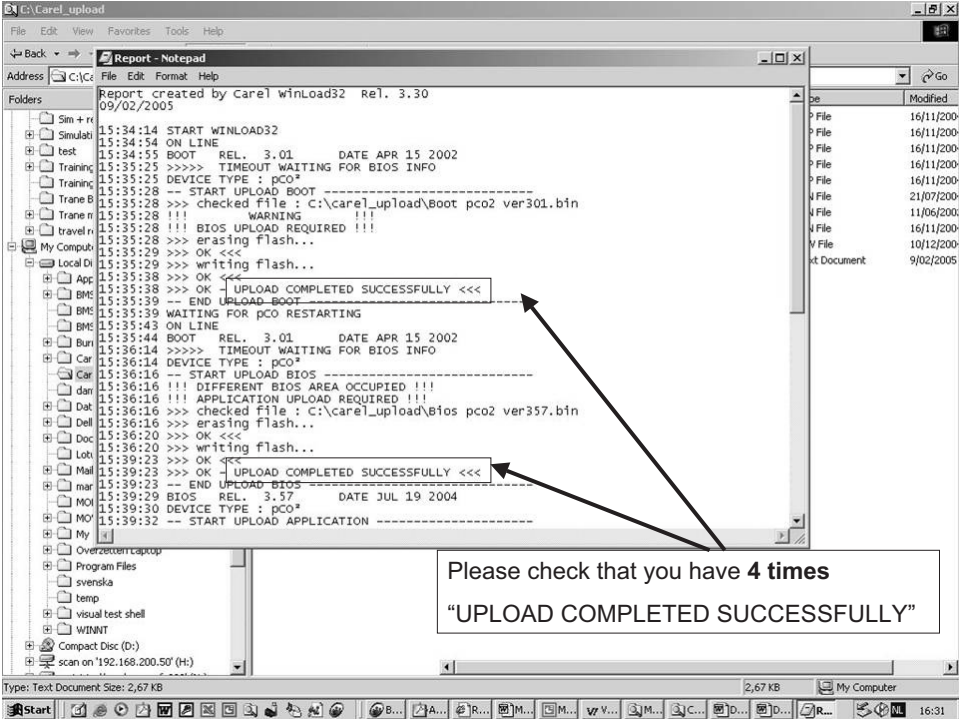
28	 <ol style="list-style-type: none"> 1. Program is busy to program the controller 2. After programming this screen will disappear. 3. Please go to the "Carel_upload" folder and open the REPORT file. <pre>15:34:14 START WINLOAD32..... 15:34:54 ON LINE 15:35:25 BOOT REL 3.01 DATE APR 15 2002..... 15:35:25 >>>> TIMEOUT WAITING FOR BIOS INFO. 15:35:28 DEVICE TYPE = pC0 15:35:28 - START UPLOAD BOOT 15:35:28 >>> checked file - C:\carel_upload\boot pco2 ver301.bin 15:35:28 !!! WARNING !!! 15:35:28 !!! BIOS UPLOAD REQUIRED !!! 15:35:28 >>> erasing flash...</pre>
----	--

Step	Action
29	 <p>Report created by Carel winLoad32 Rel. 3.30 09/02/2005</p> <pre> 15:34:14 START WINLOAD32 15:34:54 ON LINE 15:34:55 BOOT REL. 3.01 DATE APR 15 2002 15:35:25 >>>> TIMEOUT WAITING FOR BIOS INFO 15:35:25 DEVICE TYPE : PC0? 15:35:28 -- START UPLOAD BOOT ----- 15:35:28 >>> checked file : C:\carel_upload\boot pco2 ver301.bin 15:35:28 !!! WARNING !!! 15:35:28 !!! BIOS UPLOAD REQUIRED !!! 15:35:28 >>> erasing flash... 15:35:29 >>> OK <<< 15:35:29 >>> writing flash... 15:35:38 >>> OK <<< 15:35:38 >>> UPLOAD COMPLETED SUCCESSFULLY <<< 15:35:39 -- END UPLOAD BOOT ----- 15:35:39 WAITING FOR PC0 RESTARTING 15:35:43 ON LINE 15:35:44 BOOT REL. 3.01 DATE APR 15 2002 15:36:14 >>>> TIMEOUT WAITING FOR BIOS INFO 15:36:14 DEVICE TYPE : PC0? 15:36:16 -- START UPLOAD BIOS ----- 15:36:16 !!! DIFFERENT BIOS AREA OCCUPIED !!! 15:36:16 !!! APPLICATION UPLOAD REQUIRED !!! 15:36:16 >>> checked file : C:\carel_upload\bios pco2 ver357.bin 15:36:16 >>> erasing flash... 15:36:20 >>> OK <<< 15:36:20 >>> writing flash... 15:39:23 >>> OK <<< 15:39:23 >>> UPLOAD COMPLETED SUCCESSFULLY <<< 15:39:23 -- END UPLOAD BIOS ----- 15:39:29 BIOS REL. 3.57 DATE JUL 19 2004 15:39:30 DEVICE TYPE : PC0? 15:39:32 -- START UPLOAD APPLICATION ----- </pre> <p>Please check that you have 4 times "UPLOAD COMPLETED SUCCESSFULLY"</p>

3

3.5 Copy Software from WinLoad32 to the Software key

Optional: Carel RS Converter (software Winload + drivers: are available on intranet)

- Switch off the pCO² and remove the "expansion memory" cover with a screwdriver (see "Copy from pCO² to the Software Key" on page 3–15/Fig. 1).
 - Set the key selector on  (from key to pCO²).
 - Insert the key in the corresponding pin connector as shown. (see "Copy from pCO² to the Software Key" on page 3–15/Fig. 2).
 - Prepare the connection for downloading the program for WinLoad32. (see also previous chapter)
 - Supply power to the pCO² (check if the red LED on the key  is on).
 - Make the upload.
 - Once finished, switch off the pCO², remove the key and put the cover in its place.
 - Now the key contains the program transferred from WinLoad32.
-

3

4 Procedure to Protect Compressor in Case of Frozen Evaporator

4.1 What is in This Chapter?

Overview

This chapter contains the following topics:

Topic	See page
4.2 Procedure to Protect Compressor in Case of Frozen Evaporator	3–34

4.2 Procedure to Protect Compressor in Case of Frozen Evaporator

If water is detected in the compressor after an evaporator damage, the following procedure should be executed within the first day.

Step	Action
1	Supply the compressor crank case heater.
2	Insulate the compressor from the rest of the refrigerant circuit. If there is no suction valve available on the compressor, use a plate to close the suction of the compressor.
3	Open the oilplugs to drain the oil and the water out of the compressor.
4	Blow-dry nitrogen through the compressor using the service ports on the HP and LP side of the compressor.
5	Close the drain plugs and vacuum the compressor for a few hours while the crank case heater is on.
6	If the vacuum oil becomes coloured (milky colour) replace the vacuum oil.
7	Repeat step 6 each time the vacuum oil becomes milky.
8	After 4 hours, break the vacuum using step 3.
9	Repeat step 5 till step 7 until the oil of the vacuum pump becomes clear.
10	If the vacuum oil remains clear, fill the compressor with the necessary compressor oil.
11	Charge the compressor with nitrogen.

5 Procedure to Clear the Refrigerant Circuit in Case of Frozen Evaporators

5.1 What Is in This Chapter?

Overview

This chapter contains the following topics:

Topic	See page
5.2 Procedure to Clean the Refrigerant Circuit in Case of Frozen Evaporators	3–36

5.2 Procedure to Clean the Refrigerant Circuit in Case of Frozen Evaporators

If water is detected in the refrigerant circuit after an evaporator damage, the following procedure should be executed to clear the system.

Step	Action
1	Inspection and cleaning of compressor. Vacuum and heat-up the compressor to remove moisture. Fill with oil and N ₂ .
2	Cleaning & drying refrigerant circuit. Cleaning components: <ul style="list-style-type: none"> ■ Expansion valve body. ■ Liquid line solenoid valve. ■ Suction and liquid line. Replace components: <ul style="list-style-type: none"> ■ Sight glass ■ Drier filter element by high density filter ■ Compressor oil Actions: <ul style="list-style-type: none"> ■ Drill a hole on the bottom of the condenser headers to remove the water. ■ Braze the drilled holes. ■ Draw the rags through the suction and liquid line. ■ Blow-dry N₂ through all the pipes. ■ Drain the compressor oil ■ Vacuum the whole installation: <p>Check the condition of the oil of the vacuum pump on a regular basis. If the vacuum oil becomes milky, it should be replaced by new vacuum oil. The crankcase heater must be activated. It is advisable to connect a second heater tape at the suction of the compressor.</p> <ul style="list-style-type: none"> ■ Stop the vacuum and purge with dry nitrogen. ■ Restart the vacuum of the installation; check the condition of the vacuum oil after a couple of hours. If OK, the unit can be recharged. ■ Charge the unit with R407c. ■ Start the unit & re-commissioning. ■ After 24 hours replace the HD filter by a new HD filter & replace the compressor oil. ■ Check oil contamination with measuring kit. ■ After 48 hours replace the HD filter by a normal filter drier + check sight glass and pressures.
3	Find the cause of this evaporator breakdown and take the necessary actions to prevent recurrence in the future.

6 Procedure for the Changing and Configuration of the Display

6.1 What Is in This Chapter?

Overview

This chapter contains the following topics:

Topic	See page
6.2 Changing the Display	3–38
6.3 Configuration Procedure for the pLan Settings	3–39

6.2 Changing the Display



To change the display, proceed as follows:

Step	Action
1	Switch off the power supply to the chiller.
2	Remove the old display
3	Put the dipswitches of the new display on the right address.
4	Place the new display in the same way as the old display.

6.3 Configuration Procedure for the pLan Settings

This procedure must be done in case a terminal is replaced or added (remote controller) in the pLan or if settings are changed.

To start configuration, proceed as follows:

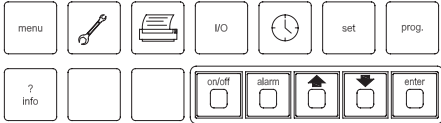
Step	Action	Result																				
1	Turn on the power supply	Nothing will appear on the screen because no configuration has been made.																				
2	<p>Hold down  ,  and enter simultaneously for five seconds.</p> 	<p>A screen will appear with the terminal address and with the address of the board in examination:</p> <div style="border: 1px solid black; padding: 5px; background-color: #f0f0f0;"> Terminal Addr: 7 I/O Board Addr: n </div> <p>Using the “up” and “down” keys it is possible to choose the different boards (1 and 2 for pCO² controller and 3, 4, 5 and 6 for the electronic valve drivers).</p>																				
3	Select in correspondence with “I/O Board Addr” the number 1 (Board with address 1) and push “enter”.	<p>In about two seconds the following screen will appear:</p> <div style="border: 1px solid black; padding: 5px; background-color: #f0f0f0;"> Terminal Config Press ENTER To continue </div>																				
4	Push “enter” again.	<p>The following screen will appear:</p> <div style="border: 1px solid black; padding: 5px; background-color: #f0f0f0;"> <table border="1"> <thead> <tr> <th>P: 01</th> <th>Addr</th> <th>Priv/Shared</th> <th></th> <th></th> </tr> </thead> <tbody> <tr> <td>Trm1</td> <td>7</td> <td>Sh</td> <td></td> <td></td> </tr> <tr> <td>Trm2</td> <td>None</td> <td>---</td> <td></td> <td></td> </tr> <tr> <td>Trm3</td> <td>None</td> <td>---Ok?</td> <td>No</td> <td></td> </tr> </tbody> </table> </div>	P: 01	Addr	Priv/Shared			Trm1	7	Sh			Trm2	None	---			Trm3	None	---Ok?	No	
P: 01	Addr	Priv/Shared																				
Trm1	7	Sh																				
Trm2	None	---																				
Trm3	None	---Ok?	No																			
5	If you want to add a second terminal (remote terminal), change the line “Trm2 None-” with the line “Trm2 8 Sh’	<p>The following screen will be displayed on the screen:</p> <div style="border: 1px solid black; padding: 5px; background-color: #f0f0f0;"> <table border="1"> <thead> <tr> <th>P: 01</th> <th>Addr</th> <th>Priv/Shared</th> <th></th> <th></th> </tr> </thead> <tbody> <tr> <td>Trm1</td> <td>7</td> <td>Sh</td> <td></td> <td></td> </tr> <tr> <td>Trm2</td> <td>8</td> <td>Sch</td> <td></td> <td></td> </tr> <tr> <td>Trm3</td> <td>None</td> <td>---Ok?</td> <td>No</td> <td></td> </tr> </tbody> </table> </div>	P: 01	Addr	Priv/Shared			Trm1	7	Sh			Trm2	8	Sch			Trm3	None	---Ok?	No	
P: 01	Addr	Priv/Shared																				
Trm1	7	Sh																				
Trm2	8	Sch																				
Trm3	None	---Ok?	No																			
6	To enable the new configuration, put the pointer on “No” (using the key “enter”) and change it to “Yes” with “up” and “down” and push enter.	The new configuration is enabled.																				
	<p>Remarks:</p> <ul style="list-style-type: none"> ■ The operations from 1 to 4 must be repeated for all compressor boards (“I/O Board” 1 and 2). ■ The operations from 1 to 5 must be repeated for all compressor boards (“I/O Board” 1 and 2) if the remote terminal is connected. 																					

Step	Action	Result
7	At the end of the operations turn off and restart the system.	

Remark:

It is possible after a restart that the terminal is stuck in a unit. This is due to the fact that the memory of the drivers remains fed by the buffer battery and keeps on processing the data contained in the preceding configuration. In this case, with the system not fed, it is sufficient to disconnect the batteries from all the drivers and then connect them again.

7 Procedure for the Changing and Configuration of the PCO² (“I/O Board”)

7.1 What Is in This Chapter?

Overview

This chapter contains the following topics:

Topic	See page
7.2 Changing the PCO ² controller	3–42

7.2 Changing the PCO² controller

To change the PCO² Controller, proceed as follows:

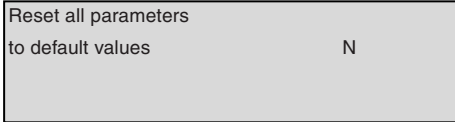
Step	Action
1	Switch off the power supply to the chiller.
2	Remove the old PCO ² controller.
3	Place the new PCO ² controller in the same way as the old PCO ² controller.
4	Change the PCO ² controller dipswitches to the right address.
5	Execute the configuration procedure for the pLan settings (see previous chapter).
6	Enter the I/O board address of the controller you have changed (see step 2 of the configuration procedure for the pLan settings).
7	Finish the configuration procedure. Now you are able to change the default setting of the I/O board you selected in the previous step.
8	Go to the manufacturer menu (menu + prog).
9	Go to the screen:  and select "Yes".
10	Change all the needed parameters according to the unit and application.

3

8 Procedure for the Changing of the Electronic Expansion Valve Driver

8.1 What is in This Chapter?

Overview

This chapter contains the following topics:

Topic	See page
8.2 Changing the Expansion Valve Driver	3–44

8.2 Changing the Expansion Valve Driver

To change the expansion valve driver, proceed as follows:

Step	Action
1	Switch off the power supply to the driller.
2	Remove the old EV driver.
3	Place the new EV driver in the same way as the old EV driver.
4	Change the EV driver dipswitches to the right address.
5	Execute the configuration procedure for the pLan settings (see "Configuration Procedure for the pLan Settings" on page 3–39).

9 Procedure for the Changing and Configuration of the Expansion I/O Board (Optional)

9.1 What is in This Chapter?

Overview

This chapter contains the following topics:

Topic	See page
9.2 Changing the PCO ² Expansion Board	3–46

9.2 Changing the PCO² Expansion Board

To change the PCO² expansion board, proceed as follows:

Step	Action
1	Switch off the power supply to the chiller.
2	Remove the old expansion board driver.
3	Place the new expansion board in the same way as the old expansion board.
4	Check if the dipswitch address is on 5 (on/off/on/off).
5	Switch on the power to the chiller.
6	Go to the manufacturer menu (menu + prog).
7	Go to the screen: <div style="border: 1px solid black; padding: 5px; margin: 5px 0;"> RS484 net Time check 000 Refresh N </div>
8	Select refresh – “Yes” The following screen will appear: <div style="border: 1px solid black; padding: 5px; margin: 5px 0;"> Wait please Exp Recognized </div> When “press enter to exit” appears, the configuration is finished.
9	Press enter to exit.

Remark:

If the following screen appears:

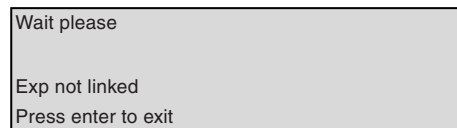

please check:

- dipswitch address of the expansion board
- wiring of the tLAN.

10 Manual Upload or Download Control Test Procedure

10.1 What is in This Chapter?

Overview

This chapter contains the following topics:

Topic	See page
10.2 Manual Upload or Download Control Test Procedure	3–48

10.2 Manual Upload or Download Control Test Procedure

Introduction This function must only be used for testing of the unit, e.g. during commissioning or troubleshooting.

Description This function allows setting the compressor to a fixed capacity step, without thermostat control. The unit is still protected by the normal safeties.

When the unit is near to a safety prevention (LP down, HP down, Freeze-prevention,...), it will skip manual mode and continue in normal operation. This is to prevent the unit from tripping on a safety.

This function can be enabled in the service menu (menu + maintenance).

Please enter digit password to get access to this menu digit.

Compressor # 1	Compressor # 3
Manual Load 25%	Manual Load 25%
State Manual	State Manual
Compressor # 2	Compressor # 4
Manual Load 25%	Manual Load 25%
State Manual	State Manual

- Manual load 25 - 100%: this parameter can be changed to the required compressor capacity.
- State OFF: this compressor will be disabled
 - Auto: the PID function will calculate the needed capacity
 - Manual: the selected manual load capacity will be used, compressor is fixed to this capacity

3

11 Troubleshooting Chart

11.1 What is in This Chapter?

Overview

This chapter contains the following topics:

Topic	See page
11.2 Troubleshooting Chart	3–50

11.2 Troubleshooting Chart

3

Problem	Possible causes	Possible corrective steps
<p>Compressor will not run</p>	<ol style="list-style-type: none"> 1 Main power switch is open. 2 Unit system switch is open. 3 Circuit switch is in pump-down position. 4 Evaporator flow switch is not closed. 5 Circuit breakers are open. 6 Fuse is blown or circuit breakers are tripped. 7 Unit phase voltage monitor is not satisfied. 8 Compressor overload is tripped. 9 Compressor contactor or contactor coil is defective. 10 System was shut down by safety devices. 11 There is no cooling required. 12 There is motor electrical trouble. 13 There is loose wiring. 	<ol style="list-style-type: none"> 1 Close switch. 2 Check the unit status on the control panel. Close switch. 3 Check the circuit status on the control panel. Close switch. 4 Check the unit status on the control panel. Close switch. 5 Close circuit breakers. 6 Check the electrical circuits and motor windings for shorts or grounds. Investigate for possible overloading. Check for loose or corroded connections. Reset breakers or replace fuses after fault is corrected. 7 Check unit power wiring to unit for correct phasing. Check voltage. 8 Overloads are manual reset. Reset overload at button on overload. 9 Check wiring. Repair or replace contactor. 10 Determine the type and cause of the shutdown and correct the problem before attempting to restart. 11 Check control settings. Wait until unit calls for cooling. 12 See 6, 7, 8 above. 13 Check circuits for voltage at required points. Tighten all power wiring terminals.

<p>Compressor overload relay tripped or circuit breaker trip or fuses blown</p>	<ol style="list-style-type: none"> 1 There is low voltage during high load condition. 2 There is loose power wiring. 3 There is a power line fault causing unbalanced voltage. 4 There is defective or grounded wiring in the motor. 5 There is high discharge pressure. 	<ol style="list-style-type: none"> 1 Check the supply voltage for excessive voltage drop. 2 Check and tighten all connections. 3 Check the supply voltage. 4 Check the motor and replace if defective. 5 See corrective steps for high discharge pressure.
<p>Compressor noisy or vibrating</p>	<ol style="list-style-type: none"> 1 There is a compressor internal problem. 2 The oil injection is not adequate. 	<ol style="list-style-type: none"> 1 Contact Daikin. 2 Contact Daikin.
<p>Compressor will not load or unload</p>	<ol style="list-style-type: none"> 1 The capacity control is defective. 2 The unloader mechanism is defective. 3 The control solenoids are defective. 	<ol style="list-style-type: none"> 1 See capacity control section. 2 Replace. 3 Replace.
<p>High discharge pressure</p>	<ol style="list-style-type: none"> 1 Discharge shut-off valve is partially closed. 2 Non condensable is in the system. 3 Fans are not running. 4 Fan control is out of adjustment. 5 Heat recovery condensers are dirty. 6 System is overcharged with refrigerant. 7 The condenser coil is dusty. 8 The air recirculates from the outlet into the unit coils. 9 Air entering the unit is restricted. 	<ol style="list-style-type: none"> 1 Open the shut-off valve. 2 Purge the non-condensable from the condenser coil after shutdown. 3 Check the fan fuses and electrical circuits. 4 Check if the unit set-up in the microprocessor matches the unit model number. Check the microprocessor condenser pressure sensor for proper operation. 5 Clean the condenser tubes by mechanical or chemical tools. 6 Check for excessive sub-cooling. Remove the excess charge. 7 Clean the condenser coil. 8 Remove the cause of recirculation. 9 Remove any obstructions near the unit.

<p>Low discharge pressure</p>	<ol style="list-style-type: none"> 1 There is wind effect at low ambient. 2 The condenser fan control is not correct. 3 There is low suction pressure. 4 The compressor is operating unloaded. 	<ol style="list-style-type: none"> 1 Protect the unit against excessive wind into the vertical coils. 2 Check if the unit set-up in the microprocessor matches the unit model number. 3 See the corrective steps for low suction pressure. 4 See the corrective steps for failure to load.
<p>Low suction pressure</p>	<ol style="list-style-type: none"> 1 The refrigerant charge quantity is inadequate. 2 The evaporator is dirty. 3 The liquid line filter-drier is clogged. 4 The expansion valve is malfunctioning. 5 The water flow to the evaporator is insufficient. 6 The water temperature leaving the evaporator is too low. 7 There is an evaporator head ring gasket slippage. 	<ol style="list-style-type: none"> 1 Check the liquid line sight-glass. Check the unit for leaks. 2 Clean chemically. 3 Replace. 4 Check the expansion valve superheat and valve opening positions. Replace only the valve that is not working. 5 Check the water pressure drop across the evaporator and adjust the flow. 6 Adjust the water temperature to a higher value. 7 If the suction pressure and the superheat are both low, it may indicate an internal problem. <i>(What's the corrective step here?)</i>
<p>High suction pressure</p>	<ol style="list-style-type: none"> 1 There is excessive load - high water temperature. 2 The compressor unloaders are open. 3 The superheat is too low. 	<ol style="list-style-type: none"> 1 Reduce the load or add additional equipment 2 See corrective steps below for failure of compressor to load. 3 Check the superheat on the microprocessor display. Check the suction line sensor installation and sensor.

<p>Unit does not switch to heat recovery operation mode</p>	<p>1 The "Q7" selector switch doesn't work.</p>	<p>1 Replace the selector switch.</p>
	<p>2 There is no heating load required.</p>	<p>2 Add additional equipment.</p>
	<p>3 The flow switch is not operating.</p>	<p>3 Check the water pump.</p>
	<p>4 The 4-way solenoid valve is not working.</p>	<p>4 Check the solenoid valve and check if the 4-way valve is blocked. Replace the wrong components.</p>
	<p>5 The "W10" sensor element is not fixed in the well pocket.</p>	<p>5 Fix the element in the well pocket properly.</p>
	<p>6 The "W10" sensor element gives a wrong signal.</p>	<p>6 Replace the element.</p>
	<p>7 The "TC10" microprocessor control doesn't work.</p>	<p>7 Check the supply connections or replace it.</p>

3

12 Prestart System Checklist

12.1 What is in This Chapter?

Overview

This chapter contains the following topics:

Topic	See page
12.2 Prestart System Checklist	3–56

12.2 Prestart System Checklist

3

	Yes	No	N/A
Chilled water			
Piping complete			
Water system filled, vented			
Pump installed, (rotation checked), strainers cleaned			
Controls (3 way valves, face and bypass dampers, bypass valves, etc) operable			
Water system operated and flow balanced to meet unit design requirements			
Heat recovery condensers			
Piping and headers complete			
Water system filled, vented			
Temperature sensors installed in the water pockets			
Pump installed, (rotation checked), strainers cleaned			
Controls (3 way valves, face and bypass dampers, bypass valves, etc) operable			
Water system operated and flow balanced to meet unit design requirements			
Electrical			
Power leads connected to starter			
All interlock wiring complete between control panel and complies with specification			
Pump starter and interlock wired			
Wiring complies with local codes			
Miscellaneous			
Thermometer wells, thermometers, gauges, control wells, controls, etc., installed			
Minimum system load of 60% or machine capacity available for testing			
Adjusting controls			

Part 4

Commissioning and Test Run

Introduction

Commissioning and test runs are well known practices in service engineering. This part contains a systematic approach on test run checks and test values, which guarantees a high quality installation and operation of the units.

What is in this part?

This part contains the following chapters:

Chapter	See page
1 Pre-Test Run Checks	4-3

4

1 Pre-Test Run Checks

1.1 What Is in This Chapter?

Introduction

This chapter contains checks you have to carry out before every test run.

Overview

This chapter contains the following topics:

Topic	See page
1.2 General Checks	4-4
1.3 Water Piping Checks	4-5
1.4 Water Pump Diagram	4-7
1.5 Evaporator Pressure Drop: EWAP-AJYNN and EWAP-AJYNN/A	4-8
1.6 Pressure Drop for Partial Heat Recovery	4-10
1.7 Pressure Drop for Full Heat Recovery	4-11
1.8 Water Flow and Pressure Drop Precautions	4-12
1.9 Electrical Checks	4-13

1.2 General Checks

Checklist

The table below contains the general checklist.

Step	Check whether...
1	There is external damage.
2	The unit is properly supported and/or has a proper foundation.
3	The unit is installed horizontally with a deviation of maximum 1°.
4	Anti-vibration pads are required.
5	Check for remaining metal dust or burrs. Metal dust or burrs from grinding or drilling in the metal parts during construction facilitates the rust process and shortens the lifetime of the unit.
6	The operator has received the operation manual.
7	The installer has received the installation manual.
8	The air volume over the coil is adequate; there is no blockage (from paper, plastic...) or air short circuit due to wrong positioning.

1.3 Water Piping Checks

Checklist

The table below contains the water piping checklist.

Step	Check whether...
1	A filter is installed in front (less than 1 meter) of the water inlet of the heat exchanger. The heat exchangers are sensitive to dirt and small particles (maximum filter mesh of 1mm).
2	The water volume is within the limits.
3	There is adequate water flow.
4	The water quality meets the standards.
5	The water piping is properly insulated.
6	Measurement points for temperature and pressure are available on the water circuit.
7	The flow switch and pump are properly working.
8	Air purge points are installed on the high parts of the water piping.
9	Drain taps are installed at the low points of the water piping.
10	Other parts of the water circuit are properly mounted and installed (e.g. buffer tank, expansion tank...).
11	Vibration compensators are mounted at the water connections if the unit is positioned on anti-vibration pads.



Water volume, flow and pressure

The table below shows the operation range of water volume and water flow for proper operation of the unit.

Chiller type	Evaporator			Condenser	
	Minimum water volume	Minimum water flow	Maximum water flow	Minimum water flow	Maximum water flow

	Evaporator			Condenser	

4

The water pressure should not exceed the maximum working pressure of 10 bar.

1.4 Water Pump Diagram

Water pump diagram

The illustration below shows the water pump diagrams for the different pumps (option OPSP or OPTP).

EWAP-AJYNN

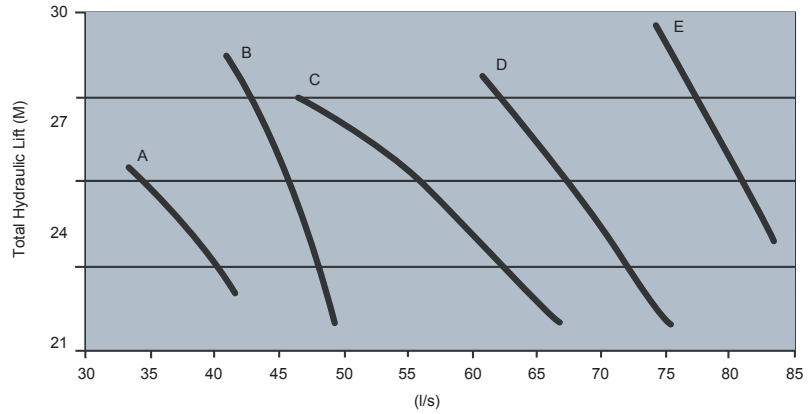

Note:

To have the useful hydraulic lift it is necessary to subtract the evaporator pressure drop to the total hydraulic lift.



Standard unit size	EWAP-AJYNN ST + OPRN/OPLN type pump	/A unit size	EWAP-AJYNN/A ST + OPRN/ OPLN type pump
800	A	850	A
900	A	900	B
950	B	950	B
C10	B	C10	C
C11	C	C11	C
C12	C	C12	C
C13	C	C13	C
C14	C	C14	D
C15	D	C15	D
C16	D	C16	E
C17	E	C17	E
C18	E	C18	E

1.5 Evaporator Pressure Drop: EWAP-AJYNN and EWAP-AJYNN/A

Evaporator pressure drop

The illustration below shows the water pressure drop through evaporator for EWAP-AJYNN and EWAP-AJYNN/A.

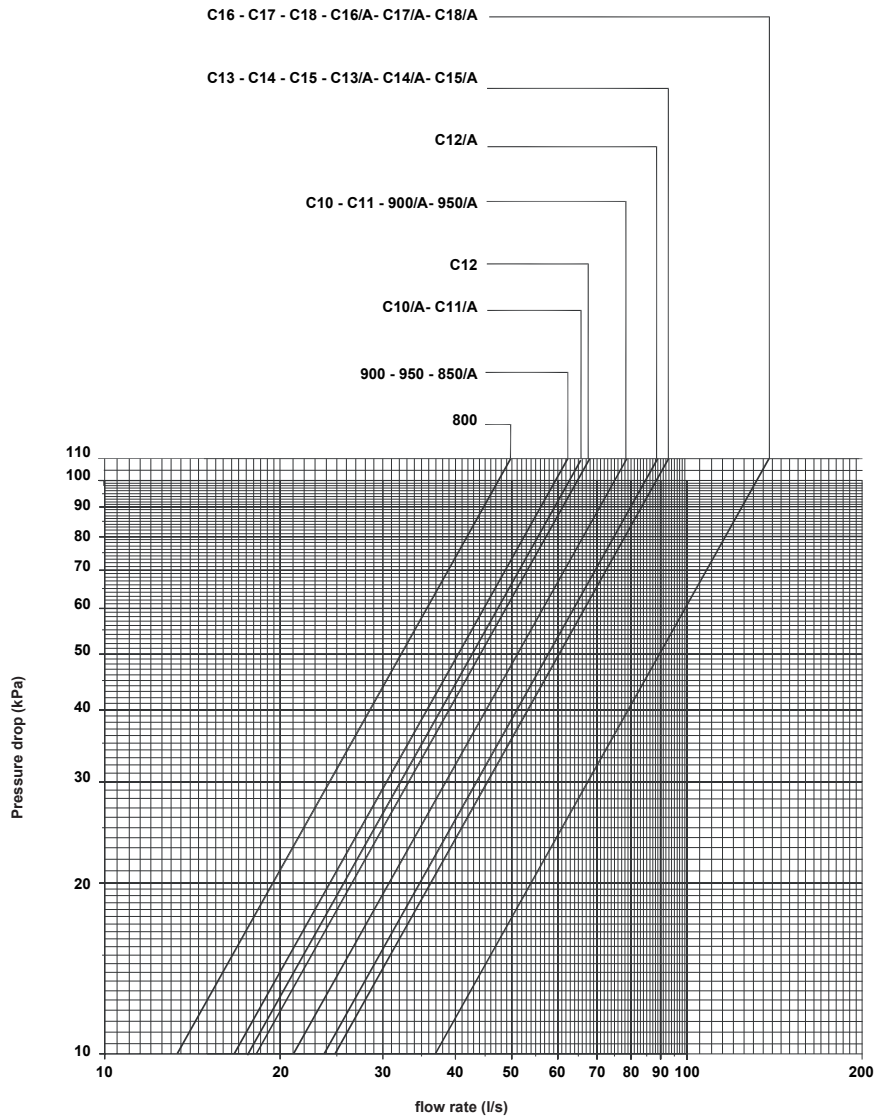

Note: For matching unit size, see table on page 4–7.

1.6 Pressure Drop for Partial Heat Recovery

Pressure drop for partial heat recovery

The illustration below shows the water pressure drop through evaporator for EWAP-AJYNN and EWAP-AJYNN/A.

EW AP-AJYNN
EW AP-AJYNN/A

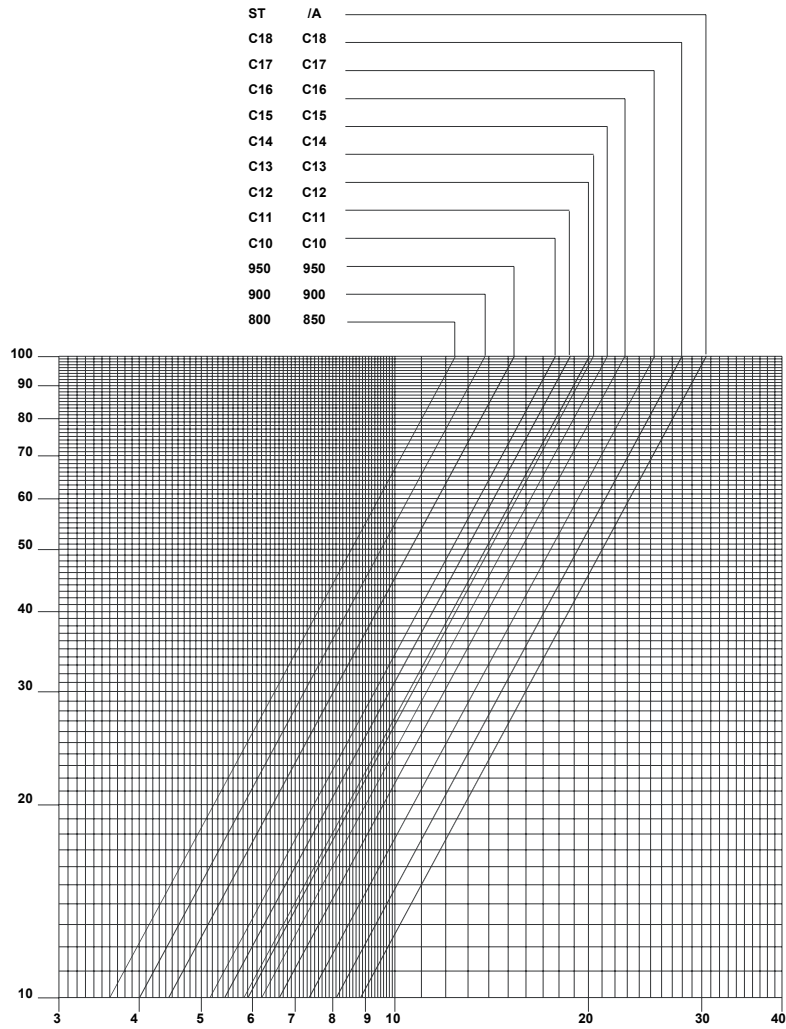

4

Note: For matching unit size, see table on page 4-7.

1.7 Pressure Drop for Full Heat Recovery

Pressure drop for full heat recovery

The illustration below shows the water pressure drop through evaporator for EWAP-AJYNN.

EW AP-AJYNN

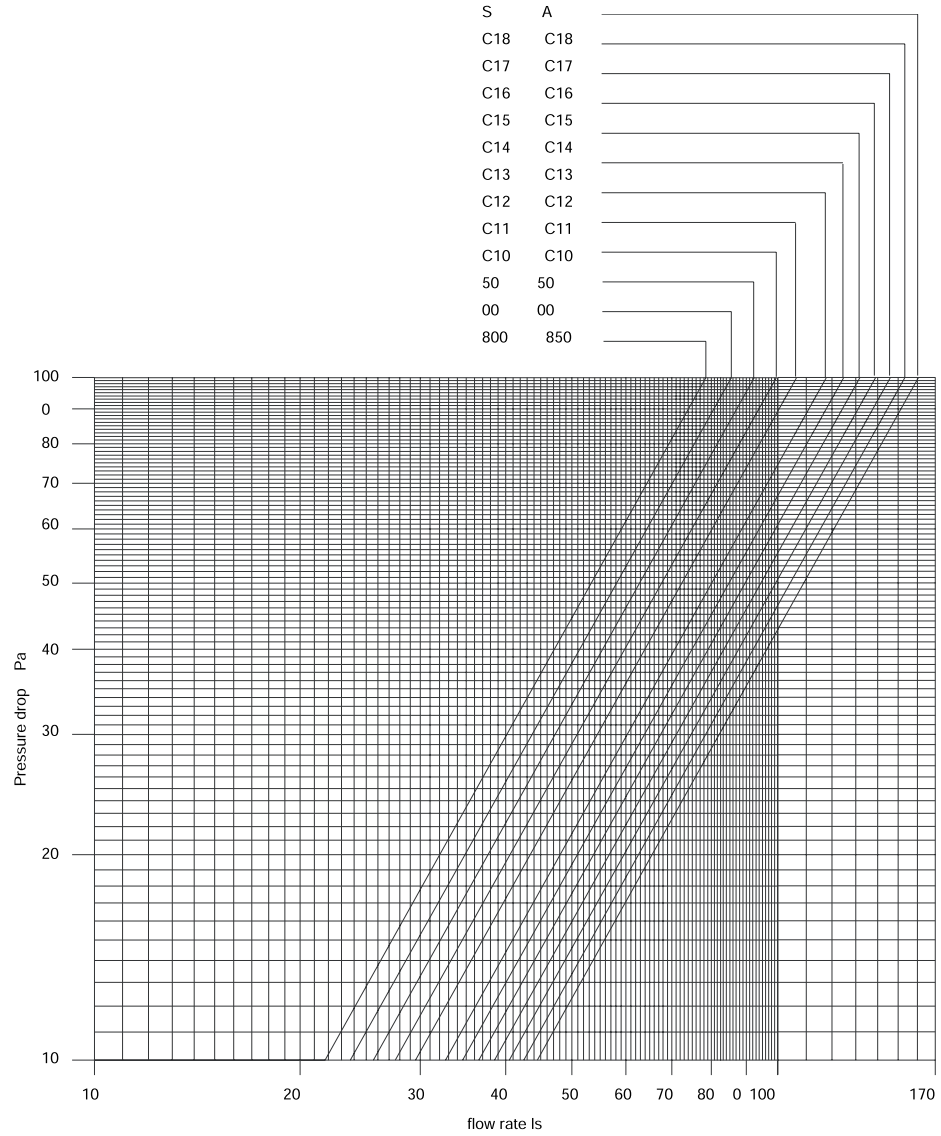

Note: For matching unit size, see table on page 4-7.

1.8 Water Flow and Pressure Drop Precautions

Evaporator water flow and pressure drop

Balance the chilled water flow through the evaporator. The flow rates must fall between the minimum and maximum values. Flow rates below the minimum values shown will result in laminar flow which will reduce efficiency, cause erratic operation of the electronic expansion valve and could cause low temperature cut-out. On the other hand, flow rates exceeding the maximum values shown can cause erosion, vibration and may cause the break on the evaporator water connections and tubes. Measure the chilled water pressure drop through the evaporator at field installed pressure taps. It is important not to include valve or strainer pressure drop in these readings.

Variable chilled water flow through the evaporator while the compressors are operating is not recommended. Set points are based upon a constant flow and variable temperature.

Heat recovery condenser water flow and pressure drop

Heat recovery condensers are supplied without the headers connection on both water sides, entering and leaving.

These Headers must be provided by the installer locally, including the wells pockets for microprocessor control sensors.

Balance the hot water flow through the heat recovery condenser. The flow rates must fall between the minimum and maximum values. Flow rates below the minimum values shown will result in laminar flow that will reduce efficiency, cause erratic operation of the unit and could cause high pressure cut-out. On the other hand, flow rates exceeding the maximum values shown can cause erosion on the condenser water connections and tubes.

Measure the hot water pressure drop through the condenser at field installed pressure taps. It is important not to include header, valve or strainer pressure drop in these readings. Variable hot water flow through the condenser while the compressors are operating is not recommended. Set points are based upon a constant flow and variable temperature.

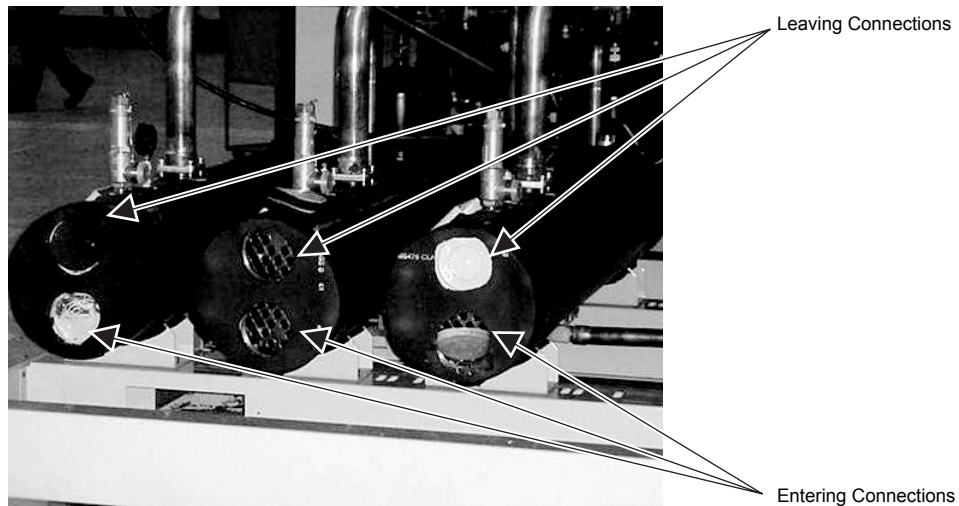

1.9 Electrical Checks

Checklist

The table below contains the electrical checklist.

Step	Check whether...
1	The main fuses, earth leak detector and main isolator are installed.
2	The main power supply voltage deviates less than 10% from the nominal value.
3	The flow switch and pump contact are properly wired.
4	The optional wiring for pump control is installed.
5	The optional wiring for remote start/stop is installed. Make sure that the controller is programmed correctly.

4

Part 5

Maintenance

Introduction

Preventive maintenance should be set up for operation at maximum capacity or to avoid damage. The following chapters explain how to or when to maintain the units.

It is also applicable on other types of Daikin chillers.

What is in this part?

This part contains the following chapters:

Chapter	See page
1 Maintenance	5-3

5

1 Maintenance

1.1 What Is in This Chapter

Introduction

As shown in the table below, we have grouped the maintenance in maintenance of the main parts (condenser, compressor and evaporator) and periodical checks.

Precautions

Correct choices and decisions have to be made before any maintenance is done. Opening the refrigerant circuit may cause a loss of refrigerant or lead to system contamination.

- Avoid high gas concentrations.
While the heavy concentration of the refrigerant gas will remain on the floor level, good ventilation is a must.
- Avoid all contact with open fires or hot surfaces.
With high temperatures, the refrigerant gas R 134a may decompose into irritating and poisonous gas. Avoid skin and hand contact with the liquid refrigerant and protect your eyes against liquid splashes.

Overview

This chapter covers the following topics:

Topic	See page
1.2 System Maintenance	5–4
1.3 Preventive Maintenance Schedule	5–8
1.4 Start-up and Shut-down	5–9
1.5 Seasonal Shut-down	5–10
1.6 Maintenance Shut-down	5–11
1.7 Periodical Checks	5–12

1.2 System Maintenance

General

To ensure proper operation at peak capacity and to avoid damage to package components, a program of periodic inspections should be set up and followed. The following items are intended as a guide and are to be used during inspection and must be combined with sound coming from the compressor and electrical practices to ensure troublefree performance. The liquid line sightglass indicator on all circuits must be checked to be sure the glass is full and clear. If the indicator shows that a wet condition exists and/or there are bubbles in the glass, even with a full refrigerant charge, the filter-drier element must be changed.

Compressor maintenance

The screw Frame 4 compressor does not require frequent maintenance. However, vibration test is an excellent check for proper mechanical operation. Compressor vibration is an indicator of the requirement for maintenance and contributes to a decrease in unit performance and efficiency. It is recommended to check the compressor with a vibration analyser at or shortly after start-up and again on an annual basis. When performing the test, the load should be maintained as closely as possible to the load of the original test. The vibration analyser test provides a fingerprint of the compressor and when performed routinely it can give a warning of impending problems.

The compressor is supplied with a cartridge oil filter. It is a good policy to replace this filter anytime the compressor is opened for servicing.

Electrical control

Warning: Electric shock hazard. Turn off all electrical power supplies before continuing with following service.

Caution: It is necessary to de-energise the complete electrical panel, including crankcase heater, before doing any servicing inside.

Prior to attempting any service on the control centre it is advisable to study the wiring diagram so that you understand the operation system of the water chiller. Electrical components do not require particular maintenance other than a monthly tightening of cables.

Warning: The warranty becomes void if the wiring connection to the unit is not in accordance with the specification. A blown fuse or tripped protector indicates a short ground or overload. Before replacing the fuse or restarting the compressor, the problem must be found and corrected. It is important to have a qualified electrician to service this panel. Unqualified tampering with the controls can cause serious damage to equipment and void the warranty.

Refrigerant sight-glass

The refrigerant sight-glasses should be observed periodically (a weekly observation should be adequate). A clear liquid sight-glass indicates the right refrigerant charge in the system to insure proper feed through the expansion valve. Bubbling refrigerant in the sight-glass during stable run conditions indicates that the system may be short of refrigerant charge. Refrigerant gas flashing in the sight-glass could also indicate an excessive pressure drop in the liquid line, possibly due to a clogged filter-drier or a restriction elsewhere in the liquid line. If sub-cooling is low, add charge to clear the sight-glass. If sub-cooling is normal and flashing is visible in the sight-glass, replace the filter-drier. An element inside the sight-glass indicates the moisture condition corresponding to a given element colour. If the sight-glass does not indicate a dry condition after about 3 hours of operation, the unit should be pumped down and the filter-driers changed.

The following table is a guide to determinate the dry or wet condition of the system:

COLOUR	MEANS
Green (Sky Blue)	Dry
Yellow (Pink)	Wet

Evaporator

The units are supplied with a new optimised counter-flow evaporator, single refrigerant pass. It is direct expansion (2 evaporators for units with 4 compressors) with refrigerant inside the tubes and water outside (shell side) with carbon steel tube sheets, with straight copper tubes that are spirally wound internally for higher efficiencies, expanded on the tube plates. The external shell, is linked with an electrical heater to prevent freezing to -28 C ambient temperature, energised by a thermostat and is covered with a closed cell insulation material. Each evaporator has 2 or 3 refrigerant circuits, one for each compressor. Each evaporator is manufactured in accordance with PED approval. Normally no service work is required on the evaporator.

Filter-dryers

A replacement of the filter-drier is recommended during scheduled service maintenance of the unit when bubbles occur in the sight-glass with normal sub-cooling temperature. The filter-drier should also be changed if the moisture indicator in the sight-glass indicates excess moisture by the wet system colour indicators. During the first few months of operation the filter-drier replacement may be necessary if you have bubbles in liquid line as explained before. Any residual particles from the unit working process, compressor and miscellaneous components are swept by the refrigerant into the liquid line and are caught by the filter-drier.

To change the filter drier, close the manual liquid line shutoff valve, pump the unit down by opening the switches Q1, Q2 (ON/OFF switches compressors) in "off" position.

Move the ON/OFF switch unit Q0 to the "off" position.

Close the suction line valve. Remove and replace the filter-drier. Evacuate the liquid line through the manual shutoff valve removing non-condensable that may have entered during filter replacement.

Open the suction line valve; open the manual liquid line of shutoff valve. A leak check is recommended before returning the unit to operation.

Electronic expansion valve

EWAP-BJ air-cooled chiller is equipped with the most advanced electronic expansion valve to achieve precise control of refrigerant mass flow. As today's system requires improved energy efficiency, tighter temperature control, wider range of operating conditions and incorporate new features like remote monitoring and diagnostics, the application of electronic expansion valves becomes mandatory. EWAD-BJ electronic expansion valve proposes features that makes it unique: short opening and closing time, high resolution, positive shut-off function to eliminate use of additional solenoid valve, highly linear flow capacity, continuous modulation of mass flow without stress in the refrigerant circuit and corrosion resistance stainless steel body.

Heat recovery condensers

Condensers are shell and clearable, through-tube types. Standard configuration is 2 passes. The unit has independent exchangers, one per circuit completely assembled. Each heat recovery condenser has a carbon steel and seamless, integrally finned high efficiency copper tubes, roll expanded into heavy carbon steel tube sheets.

Water heads are removable and include vent and drain plugs. Condensers are equipped spring loaded relief valves.

Condenser is designed to comply with PED. Waterside working pressure is designed for 10.5 bar. Standard configuration on water connection side is 2 passes.

The installer has to supply the water header connection for all heat recovery condensers installed on the unit, both at the entering and leaving water connections and provide the flow switch. All the heat recovery condenser must be connected together in parallel. At the entering water pipe, the temperature sensor must be installed, supplied spare with the unit, to control the heat recovery cycle.

Condenser coil fans	<p>The condenser fans are helical types with wing-profile blades to achieve a better performance. The direct coupling with the electrical motor reducing vibrations caused by the functioning. The three-phase type motors are supplied as standard with IP54 protection (Insulation class F); they are protected against overloading and short circuits by circuit breakers located inside the electrical control panel.</p>
Air-cooled condenser (Condensing coil)	<p>The condensing coils are constructed with internally enhanced seamless copper tubes arranged in a staggered row pattern and mechanically expanded into lanced and rippled aluminum condenser fins with full fin collars. An integral sub-cooler circuit provides sub-cooling to effectively eliminate liquid flashing and increases in cooling capacity without increasing the power input.</p> <p>No maintenance is ordinary required except the occasional removal of dirt and debris from the outside surface of the fins. Daikin recommends the use of foaming coil cleaners available at air conditioning supply outlets. Use caution when selecting such cleaners as some may contain potentially harmful chemical. Care should be taken not to damage the fins during cleaning.</p>
Lubricating oils	<p>Besides lubricating the bearing and other moving parts, the oil has the equally important task of sealing the clearances between the rotors and other potential leakage paths thereby improving pumping efficiency; the oil also assists in dissipating the heat of compression. The amount of oil injected is therefore well in excess of that required for lubrication alone. To reduce the oil circulation in the refrigerant circuit, the oil separator is installed on the compressor discharge line.</p> <p>Lubricating oil approved for use with the compressor used in this type of unit is POE Emkarate RL68H.</p> <p>The oil pressure transducer monitors the oil injection pressure on the compressor. If the oil pressure value is below the setting point inside the microprocessor control, the compressor stops.</p> <p>The oil pressure is generated by discharge pressure, a minimum discharge pressure must be maintained. This minimum pressure increases, as the suction pressure increases in order to maintain the pressure difference required.</p>
Crankcase and oil separator heaters	<p>The function of the Oil separator heaters is to prevent oil dilution with refrigerant during compressor shutdown, which would cause foaming and consequent reduction in lubricating oil flow to the moving parts. Electric heaters are energised every time the compressor shuts down.</p> <p>Warning: Verify if the heaters have been energised at least 12 hours prior to the start-up.</p>
Refrigerant	<p>Refrigerant charging</p> <p>EWAP-AJ air cooled screw chillers are shipped factory charged with a full operating charge of refrigerant, but there may be times when a unit must be recharged at the jobsite. Follow these recommendations when field charging.</p> <p>Refer to the unit operating charge, found in the data tables on pages 1–4 to 1–12 according to the version of the unit, chiller or heat recovery. The optimum charge is the charge which allows the unit to run with no flashing in the liquid line at all operating conditions. When the liquid line temperature does not drop with the addition of 2.0- 4.0 Kg of charge and the discharge pressure goes up 20-35 kPa, then the sub-cooler is nearly full and proper charge has been reached. Unit can be charged at any steady load condition, at any outdoor ambient temperature.</p> <p>Unit must be allowed to run 5 minutes or longer so that the condenser fan staging is stabilized at normal operating discharge pressure. For best results, charge the unit with 2 or more condenser fans operating per refrigerant.</p> <p>In case moisture is noticed in the system, through the moisture indicator, the system must be evacuated to eliminate the cause of trouble. After the trouble has been solved, the system must be dried by making an almost perfect vacuum. For this purpose, a displacement vacuum pump should be used.</p>

When the system has been opened for extensive repairs, like an overhaul, it is advisable to use the method of the evacuation as follows:

- 1 Evacuate the refrigerant system by the vacuum pump reaching the value of 200 Pa (1.5 mm Hg).
- 2 Break the vacuum with nitrogen until the atmospheric pressure is reached.
- 3 Repeat operation 1 and 2 two times.
- 4 Evacuate the refrigerant system reaching the value of 66.5 Pa.

The dry nitrogen, used to break the vacuum will absorb all moisture and air left in the system, which will be almost completely removed by the three evacuations. If burnt oil or sludge are found in the refrigerant circuit (caused by the compressor motor burn-out) before the vacuum operation, it will be necessary to carefully clean the system using the filter dryer clean-out method. This basically involves the use of special filter dryers, including a suitable desiccant in both the liquid and suction lines.

Excessive refrigerant losses can also cause leak of oil from the system. Check the oil level during operation and ensure that oil is visible in the top sight-glass of the oil separator.

- 1 If the unit is slightly undercharged, it will show bubbles in the sight-glass. Recharge the unit.
- 2 If the unit is moderately undercharged, it will most likely trip on freeze protection. Recharge the unit as described in the charging procedure below.

Procedure to charge a moderately undercharged EWAP-AJ unit

- 1 If a unit is low on refrigerant, you must first determine the cause before attempting to recharge the unit. Locate and repair any refrigerant leaks. Evidence of oil is a good indicator of leakage however, oil may not be visible at all leaks. Liquid leak detector fluids work well to show bubbles at medium size leaks, but an electronic leak detector may be needed to locate small leaks.
- 2 Add the charge to the system through the valve on the evaporator entering pipe between the expansion valve and the evaporator head. Follow the procedure reported on "Refrigerant charging".
- 3 The charge can be added at any load condition.

Charging the refrigerant

- 1 Connect the refrigerant bottle with a filling pipe to the filling valve on the evaporator head. Before firmly tightening the refrigerant bottle valve, open it and force the air out of the filling pipe. Tighten the charging valve connection and fill the refrigerant.
- 2 When the refrigerant stops to enter the system, start the compressor and complete the refrigerant charge.
- 3 If you do not know how much refrigerant has to be added, shut off the bottle valve every 5 minutes and continue to charge the refrigerant until the sight glass is clear and free from bubbles.

Note: Do not discharge the refrigerant into the atmosphere. To recover it, use empty, clean and dry bottles. The liquid refrigerant recovery can be made through the valve provided on the condenser coil sub-cooler outlet. To facilitate the recovery of refrigerant, put the bottle inside a container full of ice. Avoid excessive filling of the bottle (70÷80% max).

1.3 Preventive Maintenance Schedule

Overview

Operation Ref. No.	TYPE OF OPERATION	SCHEDULE			
		Weekly	Monthly	Six-Monthly	Yearly
1	Reading and recording of suction pressure	x			
2	Reading and recording of discharge pressure	x			
3	Reading and recording of supply voltage	x			
4	Reading and recording of current intensity	x			
5	Check refrigerant charge and possible moisture in the circuit refrigerant through the liquid sight glass	x			
6	Check the suction temperature and the superheating		x		
7	Check setting and operation of safety devices		x		
8	Check setting and proper operation of control devices			x	
9	Inspect the condenser for possible scaling or damages				x

1.4 Start-up and Shut-down

Start-up

-
- Verify that all shut-off valves are open.
 - Prior to starting the unit, open the water circulation pump(s) and regulate the flow through the evaporator and through the heat recovery condensers (if supplied) in accordance with the setting conditions of the unit.

If the flow meter is not available in the water system, practice suggests to fix the water flow as a first step by reaching the differential pressure drops values at the entering/leaving connections of the heat exchangers as reported on the diagram pressure drops. The final set up will be done, when the unit is running, adjusting the water flow to reach the water "DT" at full load.
 - Verify if the evaporator the inlet and outlet water temperature sensors indicate the same temperature and if the difference between them and the thermometer does not exceed 0.1°C.
 - Verify if the inlet water temperature sensors of the heat recovery condenser (if supplied) have been installed in a well pocket on the common pipe and indicate the same temperature. Also verify if the difference between it and the thermometer does not exceed 0.1°C.
 - Verify if the flow switch(es) is (are) connected to the electrical panel at the terminal blocks M3.8 – M3.23 for the evaporator and M3.426 – M3.427 for heat recovery condensers (if supplied).
 - Verify the electrical power connection to the electrical panel and put all the switches in "OFF" position. Switch "ON" the main switch isolator "Q10" and the selector "Q12". This way the electric heaters of the compressors and the oil separators are energised.
 - Check if the software installed on the microprocessor is corresponding to the unit type and the set points are correct.
 - Turn the selector switch Q0 in position " Local ". For normal unit operation condition, if the unit is handled by remote place, switch Q0 in position "remote".
 - Push the "on/off" button on the keypad and wait for the green light to go on.
 - Before turning the Q1 selector to ON position, check if the Q10 and Q12 has been switched ON at least 12 hours before. The controller, if there is a cooling load demand, will start the corresponding compressor. Repeat the sequence for Q2, Q3, Q4 selectors according to the number of compressors installed.

Operational shut-down

-
- Push the "On/Off" button on the keypad, or by remote switch, to de-energise the unit, green light become off, all the compressors will carry out its pump-down cycle and then stop.
 - Switch off the water pumps.
-

1.5 Seasonal Shut-down

Procedure

- Turn the Q1 selector to Off position. The compressor will carry out its pump-down cycle and then stop.
 - Repeat the sequence for all the selectors Q2, (Q3 and Q4) to stop all the other compressors.
 - Switch the “Q0” selector from “Local” to off position.
 - Push the “On/Off” button on the keypad to de-energise the unit, green light become off.
 - Open the circuit breaker Q12 to stop the auxiliary circuit.
 - Open the main switch Q10 to remove the power supplier to the unit. In this condition the oil electric heater is off. When you restart the unit before switching on the compressors wait at least 12 hours to heat the oil.
 - Close the shut-off valves of the refrigerant circuits.
 - Switch off the water pumps.
 - Empty the water heat exchangers or fill them with glycol for freeze protection.
-

1.6 Maintenance Shut-down

Procedure

- Turn the Q1 selector to Off position. The compressor will carry out its pump-down cycle and then stop.
 - Repeat the sequence for all the selectors Q2, (Q3 and Q4) to stop all the other compressors.
 - Switch the "Q0" selector from "Local" to off position.
 - Push the "On/Off" button on the keypad to de-energise the unit, green light become off.
 - Open the circuit breaker Q12 to stop the auxiliary circuit.
 - Open the main switch Q10 to remove the power supplier to the unit. In this condition the oil electric heater is off. When you restart the unit before switching on the compressors wait at least 12 hours to heat the oil.
 - Close the shut-off valves of the refrigerant circuits.
 - Switch off the water pumps.
 - Service the unit according to the program.
-

1.7 Periodical Checks

Electrical checks

The table below contains the electrical checks.

Inspection checks and actions	Remarks
Check if all electrical wiring is properly connected and securely tightened.	—
Check the electrical components for damage or loss.	—
Check if the power supply corresponds with the identification label of the unit.	—
Check the operation of the circuit breaker and the earth leak detector of the local supply panel.	—
Check the operation of the safety devices.	No operation can cause damage to the unit.

Refrigerant checks

The table below contains the refrigerant checks.

Inspection checks and actions	Remarks
Check the refrigerant circuit. <ul style="list-style-type: none"> ■ If the unit leaks, contact your dealer. 	—

Water checks

The table below contains the water checks.

Inspection checks and actions	Remarks
Check the water condition. <ul style="list-style-type: none"> ■ Drain the water from the air release plug. ■ If the water is dirty, replace all the water in the system. 	Dirty water causes a cooling capacity drop as well as corrosion of the water heat exchanger and pipe.
Check the water connection.	—
Check the water velocity.	—
Check the function of the flow switch.	The evaporator can freeze up if the flow switch is not able to operate.
Make sure that there is no air mixed in the water pipes.	Even if the air is removed at the beginning, air can sometimes enter later. Therefore bleed the system regularly.
Check the water filter.	—

Noise checks

The table below contains the noise checks.

Inspection checks and actions	Remarks
Check for any abnormal noise. <ul style="list-style-type: none"> ■ Locate the noise producing section and search the cause. ■ If the cause of the noise cannot be located, contact your dealer. 	—

5

C

capacity tables EWAP-AJYNN	1-60
changing the display	3-38
changing the expansion valve driver	3-44
changing the PCO ² controller	3-42
changing the PCO ² expansion board	3-46
checking the inputs and outputs	
list of analog inputs	3-9
list of analog outputs	3-11
list of digital outputs	3-10
list of input and output channels of the expansion board # 1 (option economizer)	3-12
checks	
electrical checks	4-13
general checks	4-4
periodical checks	5-12
water piping checks	4-5
control functions	
ambient lockout	2-94
auto restart after power failure function	2-96
capacity control	2-105
compressor configuration	2-100
compressor management	2-101
economizer function	2-98
enable soft load	2-91
EXV pre opening	2-99
freeze-up control	2-89
head pressure control	2-114
heat recovery microprocessor control	2-118
heat recovery microprocessor set-up	2-120
heat recovery operation	2-119
high pressure setback	2-103
liquid injection	2-97
LP alarm delay	2-111
LP prevention	2-104
oil management safeties	2-112
ON/OFF management	2-79
pressure safeties	2-109
pump control	2-95
pump down configuration at compressor stop	2-108
return water reset	2-88
setpoint reset of the chilled water	2-85
start up with high evaporator water temperature	2-93
thermostat control	2-80
unit load limiting	2-92
controller menu	
alarm menu	2-72
buffer alarm menu	2-75
EXV setting menu	2-59
input/output menu	2-42
maintenance input menu	2-66
maintenance output menu	2-63
manufacturer menu	2-46
service menu	2-71
setting menu	2-41
user menu	2-34

correction factors	
altitude	1–73
ethylene glycol and low ambient temperature	1–73
evaporator	1–73
low temperature operation performance	1–73
customer interfaces	
addressing of plan/RS485	2–23
control panel	2–15
EEXV valve driver	2–18
main board	2–16
meaning of the driver EEXV status LEDs	2–20
pCO expansion	2–21

D

digital controller	
customer interfaces	2–15
display and keypad	2–24
system architecture	2–14
display and keypad	
general description	2–25
keypad keys and their functions	2–26

E

electrical checks	4–13
electrical specifications	
EWAP-AJYNN	1–12, 1–16
EWAP-AJYNN/A	1–14
evaporator pressure drop	
EWAP-AJYNN and EWAP-AJYNN/A	4–8

G

general checks	4–4
----------------	-----

H

head pressure control	
fan management	2–114
fan silent mode	2–117
fan steps on/off management	2–115
on/off fans + phase cut (OPLA) management	2–117
phase cut fan management	2–115
Heat recovery ratings	1–74

M

maintenance	
maintenance shut-down	5–11
periodical checks	5–12, 5–13
preventive maintenance schedule	5–8
seasonal shut-down	5–10
start-up and shut-down	5–9
system maintenance	5–4
manual upload or download control test procedure	3–48

O

oil management safeties	
high oil DP alarm	2-113
pressure ratio alarm delay	2-112
pressure ratio alarm	2-112
operational range	
EWAP-AJYNN with option OPRN/OPLN	2-6
EWAP-AJYNN	2-4
EWAP-AJYNN/A with option OPRN/OPLN	2-10
EWAP-AJYNN/A	2-8
outlook drawing	
EWAP-AJYNN	1-16
overview of safeties	3-5

P

periodical checks	
electrical checks	5-12
noise checks	5-13
refrigerant checks	5-12
water checks	5-12
pressure drop for partial heat recovery	4-10
pressure drop for total heat recovery	4-11
pressure safeties	
transducer high pressure alarm	2-109
transducer low pressure alarm	2-110
prestart system checklist	3-56
procedure for the changing and configuration of the display	3-37
procedure to clean the refrigerant circuit in case of frozen evaporators	3-36
procedure to protect compressor in case of frozen evaporator	3-34

S

software upload/download	
copy from pCO ² to the software key	3-15
copy from the software key to pCO ²	3-14
copy software from WinLoad32 to the software key	3-31
installation of Winload32 on the PC and programming a controller	3-16
sound level data	1-81
system maintenance	
ar-cooled condenser (condensing coil)	5-6
compressor maintenance	5-4
condenser coil fans	5-6
crankcase and oil separator heaters	5-6
electrical control	5-4
electronic expansion valve	5-5
evaporator	5-5
filter-dryers	5-5
heat recovery condensers	5-5
lubricating oils	5-6
refrigerant sight-glass	5-4
refrigerant	5-6

T

technical specifications	
EWAP-AJYNN	1-4
EWAP-AJYNN/A	1-8
troubleshooting chart	3-50

W

water flow and pressure drop precautions	4-12
water piping checks	4-5
water pump diagram	4-7
what to do in the event of an alarm	3-4