



SiBE12- 819

# Service Manual

# SUPER MULTI *NX*

## F-Series / G-Series

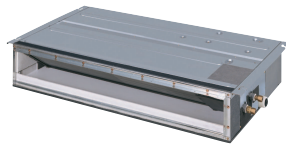
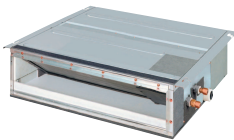

### [Applied Models]

- Inverter Multi : Cooling Only
- Inverter Multi : Heat Pump

# SUPER MULTI NX

## F-Series

## G-Series

### ●Cooling Only

#### Indoor Unit

FTXS20G2V1B  
 FTXS25G2V1B  
 FTXS35G2V1B  
 FTXS42G2V1B  
 FTXS50G2V1B

FTKS60FV1B  
 FTKS71FV1B

FDKS50CVMB  
 FDKS60CVMB  
 FDKS25EAVMB  
 FDKS35EAVMB

FLKS25BAVMB  
 FLKS35BAVMB  
 FLKS50BAVMB  
 FLKS60BAVMB  
 FVXS25FV1B  
 FVXS35FV1B  
 FVXS50FV1B  
 FHQ35BVV1B  
 FHQ50BVV1B  
 FHQ60BVV1B

#### Outdoor Unit

4MKS75F2V1B

### ●Heat Pump

#### Indoor Unit

FTXG25EV1BW  
 FTXG25EV1BS  
 FTXG35EV1BW  
 FTXG35EV1BS  
 CTXG50EV1BW  
 CTXG50EV1BS  
 FTXS20G2V1B  
 FTXS25G2V1B  
 FTXS35G2V1B  
 FTXS42G2V1B  
 FTXS50G2V1B

FTXS60FV1B  
 FTKS71FV1B

FDXS50CVMB  
 FDXS60CVMB  
 FDXS25EAVMB  
 FDXS35EAVMB

FLXS25BAVMB  
 FLXS35BAVMB  
 FLXS50BAVMB  
 FLXS60BAVMB  
 FVXS25FV1B  
 FVXS35FV1B  
 FVXS50FV1B  
 FHQ35BVV1B  
 FHQ50BVV1B  
 FHQ60BVV1B

#### Outdoor Unit

3MXS68G2V1B  
 4MXS68F2V1B

1. Introduction .....	V
1.1 Safety Cautions .....	v
1.2 Used Icons .....	ix

## **Part 1 List of Functions ..... 1**

1. List of Functions .....	2
1.1 Cooling Only Models .....	2
1.2 Heat Pump Models .....	7

## **Part 2 Specifications ..... 13**

1. Specifications .....	14
1.1 Indoor Units - Cooling Only .....	14
1.2 Outdoor Units - Cooling Only .....	20
1.3 Indoor Units - Heat Pump .....	21
1.4 Outdoor Units - Heat Pump .....	29

## **Part 3 Printed Circuit Board Connector Wiring Diagram ..... 31**

1. Printed Circuit Board Connector Wiring Diagram .....	32
1.1 Wall Mounted Type .....	32
1.2 Duct Connected Type .....	38
1.3 Floor / Ceiling Suspended Dual Type .....	40
1.4 Floor Standing Type .....	43
1.5 Ceiling Suspended Type .....	45
1.6 Outdoor Units .....	47

## **Part 4 Function and Control..... 51**

1. Main Functions .....	52
1.1 Frequency Principle .....	52
1.2 Power-Airflow Dual Flaps, Wide Angle Louvers and Auto-Swing .....	54
1.3 Operation Starting Control .....	56
1.4 Fan Speed Control for Indoor Units .....	57
1.5 Programme Dry Function .....	58
1.6 Automatic Operation .....	59
1.7 Thermostat Control .....	60
1.8 Night Set Mode .....	61
1.9 ECONO Mode .....	62
1.10 INTELLIGENT EYE (FTXG-E, CTXG-E, FTK(X)S-F) .....	63
1.11 2 AREA INTELLIGENT EYE (FTXS-G) .....	65
1.12 HOME LEAVE Operation .....	67
1.13 Inverter POWERFUL Operation .....	68
1.14 Other Functions .....	69
2. Function of Main Structural Parts .....	71
2.1 Main Structural Parts .....	71
2.2 Function of Thermistor .....	72
3. Control Specification .....	76
3.1 Mode Hierarchy .....	76
3.2 Frequency Control .....	77
3.3 Controls at Mode Changing / Start-up .....	80
3.4 Discharge Pipe Control .....	82

3.5	Input Current Control.....	82
3.6	Freeze-up Protection Control .....	83
3.7	Heating Peak-cut Control .....	83
3.8	Fan Control.....	84
3.9	Liquid Compression Protection Function 2.....	84
3.10	Defrost Control .....	85
3.11	Electronic Expansion Valve Control .....	86
3.12	Malfunctions .....	90
3.13	Forced Operation Mode .....	91
3.14	Wiring-Error Check.....	92
3.15	Additional Function.....	94

## **Part 5 Operation Manual ..... 97**

1.	System Configuration.....	98
1.1	Operation Instructions .....	98
2.	Instruction.....	99
2.1	FTXG-E, CTXG-E, FTK(X)S-F, FDK(X)S-C(E), FLK(X)S-B Series.....	99
2.2	FTXS-G, FVXS-F Series .....	149
2.3	FHQ-B Series.....	191

## **Part 6 Service Diagnosis..... 205**





1.	Caution for Diagnosis.....	206
1.1	Troubleshooting with Operation Lamp .....	206
2.	Problem Symptoms and Measures .....	208
3.	Service Check Function .....	209
3.1	Check Method 1 .....	209
3.2	Check Method 2 .....	211
4.	Code Indication on the Remote Controller .....	213
4.1	Error Codes and Description of Fault .....	213
5.	Troubleshooting .....	214
5.1	Indoor Units .....	214
5.2	Outdoor Units .....	215
5.3	Indoor Unit PCB Abnormality .....	216
5.4	Freeze-up Protection Control or High Pressure Control.....	217
5.5	Fan Motor or Related Abnormality .....	219
5.6	Thermistor or Related Abnormality (Indoor Unit).....	222
5.7	Front Panel Open / Close Fault.....	223
5.8	Signal Transmission Error (between Indoor and Outdoor Unit) .....	224
5.9	Unspecified Voltage (between Indoor and Outdoor Units) .....	226
5.10	Freeze-up Protection Control .....	227
5.11	Outdoor Unit PCB Abnormality.....	229
5.12	OL Activation (Compressor Overload) .....	230
5.13	Compressor Lock .....	231
5.14	DC Fan Lock .....	232
5.15	Input Over Current Detection .....	233
5.16	Discharge Pipe Temperature Control.....	235
5.17	High Pressure Control in Cooling .....	236
5.18	Compressor Sensor System Abnormality .....	238
5.19	Position Sensor Abnormality .....	240
5.20	CT or Related Abnormality .....	241

5.21 Thermistor or Related Abnormality (Outdoor Unit) .....	243
5.22 Electrical Box Temperature Rise .....	245
5.23 Radiation Fin Temperature Rise .....	247
5.24 Output Over Current Detection.....	249
5.25 Insufficient Gas.....	251
5.26 Low-voltage Detection or Over-voltage Detection .....	253
5.27 Signal Transmission Error (on Outdoor Unit PCB).....	254
5.28 Anti-icing Function in Other Rooms / Unspecified Voltage (between Indoor and Outdoor Units) .....	255
6. Check .....	256
6.1 How to Check.....	256
<b>Part 7 Removal Procedure .....</b>	<b>267</b>
1. Outdoor Unit.....	268
1.1 Removal of the Panels and Plates .....	268
1.2 Removal of the Electrical Box .....	272
1.3 Removal of the PCB.....	280
1.4 Removal of the Propeller Fan / Fan Motor .....	286
1.5 Removal of the Sound Blanket.....	288
1.6 Removal of Electronic Expansion Valve Coil, Four Way Valve Coil and Thermistor .....	292
1.7 Removal of the Distributor .....	295
1.8 Removal of the Four Way Valve.....	296
1.9 Removal of the Compressor.....	297
<b>Part 8 Others .....</b>	<b>299</b>
1. Others .....	300
1.1 Test Run from the Remote Controller .....	300
1.2 Jumper Settings .....	301
1.3 Application of Silicon Grease to a Power Transistor and a Diode Bridge.....	302
<b>Part 9 Appendix.....</b>	<b>303</b>
1. Piping Diagrams.....	304
1.1 Indoor Units .....	304
1.2 Outdoor Units .....	309
2. Wiring Diagrams.....	311
2.1 Indoor Units .....	311
2.2 Outdoor Units .....	315
<b>Index .....</b>	<b>i</b>
<b>Drawings &amp; Flow Charts .....</b>	<b>v</b>







# 1. Introduction



## 1.1 Safety Cautions









### Cautions and Warnings

- Be sure to read the following safety cautions before conducting repair work.
- The caution items are classified into “ **Warning**” and “ **Caution**”. The “ **Warning**” items are especially important since they can lead to death or serious injury if they are not followed closely. The “ **Caution**” items can also lead to serious accidents under some conditions if they are not followed. Therefore, be sure to observe all the safety caution items described below.
- About the pictograms
  - △ This symbol indicates the item for which caution must be exercised.  
The pictogram shows the item to which attention must be paid.
  - This symbol indicates the prohibited action.  
The prohibited item or action is shown in the illustration or near the symbol.
  - This symbol indicates the action that must be taken, or the instruction.  
The instruction is shown in the illustration or near the symbol.
- After the repair work is complete, be sure to conduct a test operation to ensure that the equipment operates normally, and explain the cautions for operating the product to the customer.











### 1.1.1 Cautions Regarding Safety of Workers

 <b>Warning</b>	
<p>Be sure to disconnect the power cable plug from the plug socket before disassembling the equipment for repair. Working on the equipment that is connected to the power supply may cause an electrical shock. If it is necessary to supply power to the equipment to conduct the repair or inspecting the circuits, do not touch any electrically charged sections of the equipment.</p>	
<p>If the refrigerant gas is discharged during the repair work, do not touch the discharged refrigerant gas. The refrigerant gas may cause frostbite.</p>	
<p>When disconnecting the suction or discharge pipe of the compressor at the welded section, evacuate the refrigerant gas completely at a well-ventilated place first. If there is a gas remaining inside the compressor, the refrigerant gas or refrigerating machine oil discharges when the pipe is disconnected, and it may cause injury.</p>	
<p>If the refrigerant gas leaks during the repair work, ventilate the area. The refrigerant gas may generate toxic gases when it contacts flames.</p>	
<p>The step-up capacitor supplies high-voltage electricity to the electrical components of the outdoor unit. Be sure to discharge the capacitor completely before conducting repair work. A charged capacitor may cause an electrical shock.</p>	
<p>Do not start or stop the air conditioner operation by plugging or unplugging the power cable plug. Plugging or unplugging the power cable plug to operate the equipment may cause an electrical shock or fire.</p>	





 <b>Warning</b>	
Be sure to wear a safety helmet, gloves, and a safety belt when working at a high place (more than 2m). Insufficient safety measures may cause a fall accident.	
In case of R410A refrigerant models, be sure to use pipes, flare nuts and tools for the exclusive use of the R410A refrigerant. The use of materials for R22 refrigerant models may cause a serious accident such as a damage of refrigerant cycle as well as an equipment failure.	







 <b>Caution</b>	
Do not repair the electrical components with wet hands. Working on the equipment with wet hands may cause an electrical shock.	
Do not clean the air conditioner by splashing water. Washing the unit with water may cause an electrical shock.	
Be sure to provide the grounding when repairing the equipment in a humid or wet place, to avoid electrical shocks.	
Be sure to turn off the power switch and unplug the power cable when cleaning the equipment. The internal fan rotates at a high speed, and cause injury.	
Be sure to conduct repair work with appropriate tools. The use of inappropriate tools may cause injury.	
Be sure to check that the refrigerating cycle section has cooled down enough before conducting repair work. Working on the unit when the refrigerating cycle section is hot may cause burns.	
Use the welder in a well-ventilated place. Using the welder in an enclosed room may cause oxygen deficiency.	





## 1.1.2 Cautions Regarding Safety of Users

 <b>Warning</b>	
Be sure to use parts listed in the service parts list of the applicable model and appropriate tools to conduct repair work. Never attempt to modify the equipment. The use of inappropriate parts or tools may cause an electrical shock, excessive heat generation or fire.	
If the power cable and lead wires have scratches or deteriorated, be sure to replace them. Damaged cable and wires may cause an electrical shock, excessive heat generation or fire.	
Do not use a joined power cable or extension cable, or share the same power outlet with other electrical appliances, since it may cause an electrical shock, excessive heat generation or fire.	
Be sure to use an exclusive power circuit for the equipment, and follow the local technical standards related to the electrical equipment, the internal wiring regulations, and the instruction manual for installation when conducting electrical work. Insufficient power circuit capacity and improper electrical work may cause an electrical shock or fire.	
Be sure to use the specified cable for wiring between the indoor and outdoor units. Make the connections securely and route the cable properly so that there is no force pulling the cable at the connection terminals. Improper connections may cause excessive heat generation or fire.	
When wiring between the indoor and outdoor units, make sure that the terminal cover does not lift off or dismount because of the cable. If the cover is not mounted properly, the terminal connection section may cause an electrical shock, excessive heat generation or fire.	
Do not damage or modify the power cable. Damaged or modified power cable may cause an electrical shock or fire. Placing heavy items on the power cable, and heating or pulling the power cable may damage the cable.	
Do not mix air or gas other than the specified refrigerant (R410A / R22) in the refrigerant system. If air enters the refrigerating system, an excessively high pressure results, causing equipment damage and injury.	
If the refrigerant gas leaks, be sure to locate the leaking point and repair it before charging the refrigerant. After charging refrigerant, make sure that there is no refrigerant leak. If the leaking point cannot be located and the repair work must be stopped, be sure to perform pump-down and close the service valve, to prevent the refrigerant gas from leaking into the room. The refrigerant gas itself is harmless, but it may generate toxic gases when it contacts flames, such as fan and other heaters, stoves and ranges.	
When relocating the equipment, make sure that the new installation site has sufficient strength to withstand the weight of the equipment. If the installation site does not have sufficient strength and if the installation work is not conducted securely, the equipment may fall and cause injury.	







 <b>Warning</b>	
Check to make sure that the power cable plug is not dirty or loose, then insert the plug into a power outlet securely. If the plug has dust or loose connection, it may cause an electrical shock or fire.	
Be sure to install the product correctly by using the provided standard installation frame. Incorrect use of the installation frame and improper installation may cause the equipment to fall, resulting in injury.	For unitary type only 
Be sure to install the product securely in the installation frame mounted on the window frame. If the unit is not securely mounted, it may fall and cause injury.	For unitary type only 
When replacing the coin battery in the remote controller, be sure to disposed of the old battery to prevent children from swallowing it. If a child swallows the coin battery, see a doctor immediately.	

 <b>Caution</b>	
Installation of a leakage breaker is necessary in some cases depending on the conditions of the installation site, to prevent electrical shocks.	
Do not install the equipment in a place where there is a possibility of combustible gas leaks. If the combustible gas leaks and remains around the unit, it may cause a fire.	
Check to see if the parts and wires are mounted and connected properly, and if the connections at the soldered or crimped terminals are secure. Improper installation and connections may cause excessive heat generation, fire or an electrical shock.	
If the installation platform or frame has corroded, replace it. Corroded installation platform or frame may cause the unit to fall, resulting in injury.	
Check the grounding, and repair it if the equipment is not properly grounded. Improper grounding may cause an electrical shock.	

 <b>Caution</b>	
Be sure to measure the insulation resistance after the repair, and make sure that the resistance is 1 MΩ or higher. Faulty insulation may cause an electrical shock.	
Be sure to check the drainage of the indoor unit after the repair. Faulty drainage may cause the water to enter the room and wet the furniture and floor.	
Do not tilt the unit when removing it. The water inside the unit may spill and wet the furniture and floor.	
Be sure to install the packing and seal on the installation frame properly. If the packing and seal are not installed properly, water may enter the room and wet the furniture and floor.	For unitary type only  

## 1.2 Used Icons

Icons are used to attract the attention of the reader to specific information. The meaning of each icon is described in the table below:

Icon	Type of Information	Description
 Note:	Note	A “note” provides information that is not indispensable, but may nevertheless be valuable to the reader, such as tips and tricks.
 Caution	Caution	A “caution” is used when there is danger that the reader, through incorrect manipulation, may damage equipment, lose data, get an unexpected result or has to restart (part of) a procedure.
 Warning	Warning	A “warning” is used when there is danger of personal injury.
	Reference	A “reference” guides the reader to other places in this binder or in this manual, where he/she will find additional information on a specific topic.



# Part 1

# List of Functions

1. List of Functions .....	2
1.1 Cooling Only Models .....	2
1.2 Heat Pump Models.....	7

# 1. List of Functions

## 1.1 Cooling Only Models

Category	Functions	FTXS20-50G2V1B	Category	Functions	FTXS20-50G2V1B
Basic Function	Inverter (with Inverter Power Control)	○	Health & Clean	Air Purifying Filter	—
	Operation Limit for Cooling (°CDB)	—		Photocatalytic Deodorizing Filter	—
	Operation Limit for Heating (°CWB)	—		Air Purifying Filter with Photocatalytic Deodorizing Function	—
PAM Control	—	Titanium Apatite Photocatalytic Air-Purifying Filter		○	
Compressor	Oval Scroll Compressor	—		Mold Proof Air Filter	○
	Swing Compressor	—		Wipe-clean Flat Panel	○
	Rotary Compressor	—		Washable Grille	—
	Reluctance DC Motor	—		Mold Proof Operation	—
Comfortable Airflow	Power-Airflow Flap	—		Heating Dry Operation	—
	Power-Airflow Dual Flaps	○		Good-Sleep Cooling Operation	—
	Power-Airflow Diffuser	—	Timer	Weekly Timer	○
	Wide-Angle Louvers	○		24-Hour On/Off Timer	○
	Vertical Auto-Swing (Up and Down)	○		72-Hour On/Off Timer	—
	Horizontal Auto-Swing (Right and Left)	○		Night Set Mode	○
	3-D Airflow	○	Worry Free "Reliability & Durability"	Auto-Restart (after Power Failure)	○
	Comfort Airflow Mode	○		Self-Diagnosis (Digital, LED) Display	○
3-Step Airflow (H/P Only)	—	Wiring Error Check		—	
Comfort Control	Auto Fan Speed	○		Anticorrosion Treatment of Outdoor Heat Exchanger	—
	Indoor Unit Quiet Operation	○	Flexibility	Multi-Split / Split Type Compatible Indoor Unit	○
	Night Quiet Mode (Automatic)	—		H/P, C/O Compatible Indoor Unit	○
	Outdoor Unit Quiet Operation (Manual)	—		Flexible Voltage Correspondence	—
	INTELLIGENT EYE	—		High Ceiling Application	—
	2 Area INTELLIGENT EYE	○	Chargeless	—	
	Quick Warming Function	—	Either Side Drain (Right or Left)	○	
	Hot-Start Function	—	Power Selection	—	
Automatic Defrosting	—	Operation	5-Rooms Centralized Controller (Option)	○	
Operation	Automatic Operation		—	Remote Control Adaptor (Normal Open-Pulse Contact) (Option)	○
	Programme Dry Function		○	Remote Control Adaptor (Normal Open Contact) (Option)	○
	Fan Only	○	DIII-NET Compatible (Adaptor) (Option)	○	
Lifestyle Convenience	New POWERFUL Operation (Non-Inverter)	—	Remote Control	Wireless	○
	Inverter POWERFUL Operation	○		Wired	—
	Priority-Room Setting	—	Remote Controller		
	Cooling / Heating Mode Lock	—			
	HOME LEAVE Operation	—			
	ECONO Mode	○			
	Indoor Unit On/Off Switch	○			
	Signal Reception Indicator	—			
Temperature Display	—				

**Note:** ○ : Holding Functions

— : No Functions

Category	Functions	FTKS60/71 FV1B	Category	Functions	FTKS60/71 FV1B	
Basic Function	Inverter (with Inverter Power Control)	○	Health & Clean	Air Purifying Filter	—	
	Operation Limit for Cooling (°CDB)	—		Photocatalytic Deodorizing Filter	—	
	Operation Limit for Heating (°CWB)	—		Air Purifying Filter with Photocatalytic Deodorizing Function	—	
PAM Control	—	Titanium Apatite Photocatalytic Air-Purifying Filter		○		
Compressor	Oval Scroll Compressor	—		Longlife Filter (Option)	—	
	Swing Compressor	—		Mold Proof Air Filter	○	
	Rotary Compressor	—		Wipe-clean Flat Panel	○	
	Reluctance DC Motor	—		Washable Grille	—	
Comfortable Airflow	Power-Airflow Flap	—		Filter Cleaning Indicator	—	
	Power-Airflow Dual Flaps	○		Mold Proof Operation	—	
	Power-Airflow Diffuser	—	Heating Dry Operation	—		
	Wide-Angle Louvers	○	Good-Sleep Cooling Operation	—		
	Vertical Auto-Swing (Up and Down)	○	Timer	Weekly Timer	—	
	Horizontal Auto-Swing (Right and Left)	○		24-Hour On/Off Timer	○	
	3-D Airflow	○		72-Hour On/Off Timer	—	
	Comfort Airflow Mode	—		Night Set Mode	○	
Comfort Control	3-Step Airflow (H/P Only)	—	Worry Free "Reliability & Durability"	Auto-Restart (after Power Failure)	○	
	Auto Fan Speed	○		Self-Diagnosis (Digital, LED) Display	○	
	Indoor Unit Quiet Operation	○		Wiring Error Check	—	
	Night Quiet Mode (Automatic)	—		Anticorrosion Treatment of Outdoor Heat Exchanger	—	
	Outdoor Unit Quiet Operation (Manual)	—		Flexibility	Multi-Split / Split Type Compatible Indoor Unit	○
	INTELLIGENT EYE	○	H/P, C/O Compatible Indoor Unit		—	
	2 Area INTELLIGENT EYE	—	Flexible Voltage Correspondence		—	
	Operation	Quick Warming Function	—	High Ceiling Application	—	
Hot-Start Function		—	Chargeless	—		
Automatic Defrosting		—	Either side Drain (Right or Left)	○		
Lifestyle Convenience	Automatic Operation	—	Power Selection	—		
	Programme Dry Function	○	Remote Control	5-Rooms Centralized Controller (Option)	○	
	Fan Only	○		Remote Control Adaptor (Normal Open-Pulse Contact) (Option)	○	
	New POWERFUL Operation (Non-Inverter)	—		Remote Control Adaptor (Normal Open Contact) (Option)	○	
		—		DIIII-NET Compatible (Adaptor) (Option)	○	
	Inverter POWERFUL Operation	○		Remote Controller	Wireless	○
	Priority-Room Setting	—			Wired	—
	Cooling / Heating Mode Lock	—				
HOME LEAVE Operation	○					
ECONO Mode	—					
Indoor Unit On/Off Switch	○					
Signal Reception Indicator	○					
Temperature Display	—					

**Note:** ○ : Holding Functions  
 — : No Functions

Category	Functions	FDKS50/60CVMB	FDKS25/35EAVMB	Category	Functions	FDKS50/60CVMB	FDKS25/35EAVMB	
Basic Function	Inverter (with Inverter Power Control)	○	○	Health & Clean	Air Purifying Filter	—	—	
	Operation Limit for Cooling (°CDB)	—	—		Photocatalytic Deodorizing Filter	—	—	
	Operation Limit for Heating (°CWB)	—	—		Air Purifying Filter with Photocatalytic Deodorizing Function	—	—	
	PAM Control	—	—		Titanium Apatite Photocatalytic Air-Purifying Filter	—	—	
Compressor	Oval Scroll Compressor	—	—		Longlife Filter (Option)	—	—	
	Swing Compressor	—	—		Mold Proof Air Filter	○	○	
	Rotary Compressor	—	—		Wipe-clean Flat Panel	—	—	
	Reluctance DC Motor	—	—		Washable Grille	—	—	
Comfortable Airflow	Power-Airflow Flap	—	—		Filter Cleaning Indicator	—	—	
	Power-Airflow Dual Flaps	—	—		Mold Proof Operation	—	—	
	Power-Airflow Diffuser	—	—	Heating Dry Operation	—	—		
	Wide-Angle Louvers	—	—	Good-Sleep Cooling Operation	—	—		
	Vertical Auto-Swing (Up and Down)	—	—	Timer	Weekly Timer	—	—	
	Horizontal Auto-Swing (Right and Left)	—	—		24-Hour On/Off Timer	○	○	
	3-D Airflow	—	—		72-Hour On/Off Timer	—	—	
	Comfort Airflow Mode	—	—		Night Set Mode	○	○	
Comfort Control	3-Step Airflow (H/P Only)	—	—	Worry Free "Reliability & Durability"	Auto-Restart (after Power Failure)	○	○	
	Auto Fan Speed	○	○		Self-Diagnosis (Digital, LED) Display	○	○	
	Indoor Unit Quiet Operation	○	○		Wiring-Error Check	—	—	
	Night Quiet Mode (Automatic)	—	—		Anticorrosion Treatment of Outdoor Heat Exchanger	—	—	
	Operation	Outdoor Unit Quiet Operation (Manual)	—	—	Flexibility	Multi-Split / Split Type Compatible Indoor Unit	○	○
		INTELLIGENT EYE	—	—		H/P, C/O Compatible Indoor Unit	—	—
		2 Area INTELLIGENT EYE	—	—		Flexible Voltage Correspondence	○	○
		Quick Warming Function	—	—		High Ceiling Application	—	—
Hot-Start Function		—	—	Chargeless		—	—	
Automatic Defrosting		—	—	Either Side Drain (Right or Left)		—	—	
Power-Selection		—	—	Remote Control		5-Rooms Centralized Controller (Option)	○	○
Automatic Operation	—	—	Remote Control Adaptor (Normal Open-Pulse Contact) (Option)		○	○		
Programme Dry Function	○	○	Remote Control Adaptor (Normal Open Contact) (Option)		○	○		
Fan Only	○	○	DIII-NET Compatible (Adaptor) (Option)		○	○		
Lifestyle Convenience	New POWERFUL Operation (Non-Inverter)	—	—	Remote Controller	Wireless	○	○	
	Inverter POWERFUL Operation	○	○		Wired	—	—	
	Priority-Room Setting	—	—					
	Cooling / Heating Mode Lock	—	—					
	HOME LEAVE Operation	○	○					
	ECONO Mode	—	—					
	Indoor Unit On/Off Switch	○	○					
	Signal Reception Indicator	○	○					
Temperature Display	—	—						

**Note:** ○ : Holding Functions  
 — : No Functions

Category	Functions	FLKS25-60BAVMB	FYXS25-50FV1B	FHQ35-60BVV1B	Category	Functions	FLKS25-60BAVMB	FYXS25-50FV1B	FHQ35-60BVV1B	
Basic Function	Inverter (with Inverter Power Control)	○	○	○	Health & Clean	Air Purifying Filter	○	—	—	
	Operation Limit for Cooling (°CDB)	—	—	—		Photocatalytic Deodorizing Filter	○	—	—	
	Operation Limit for Heating (°CWB)	—	—	—		Air Purifying Filter with Photocatalytic Deodorizing Function	—	—	—	
	PAM Control	—	—	—		Titanium Apatite Photocatalytic Air-Purifying Filter	—	○	—	
Compressor	Oval Scroll Compressor	—	—	—	Longlife Filter (Option)	—	—	○		
	Swing Compressor	—	—	—	Mold Proof Air Filter	○	○	○		
	Rotary Compressor	—	—	—	Wipe-clean Flat Panel	—	○	—		
	Reluctance DC Motor	—	—	—	Washable Grille	—	—	○		
Comfortable Airflow	Power-Airflow Flap	—	—	—	Filter Cleaning Indicator	—	—	○		
	Power-Airflow Dual Flaps	—	—	—	Mold Proof Operation	—	—	—		
	Power-Airflow Diffuser	—	—	—	Heating Dry Operation	—	—	—		
	Wide-Angle Louvers	—	○	—	Good-Sleep Cooling Operation	—	—	—		
	Vertical Auto-Swing (Up and Down)	○	○	○	Timer	Weekly Timer	—	○	—	
	Horizontal Auto-Swing (Right and Left)	—	—	—		24-Hour On/Off Timer	○	○	—	
	3-D Airflow	—	—	—		72-Hour On/Off Timer	—	—	○	
	Comfort Airflow Mode	—	—	—		Night Set Mode	○	○	—	
Comfort Control	3-Step Airflow (H/P Only)	—	—	—	Worry Free "Reliability & Durability"	Auto-Restart (after Power Failure)	○	○	○	
	Auto Fan Speed	○	○	—		Self-Diagnosis (Digital, LED) Display	○	○	○	
	Indoor Unit Quiet Operation	○	○	—		Wiring-Error Check	—	—	—	
	Night Quiet Mode (Automatic)	—	—	—		Anticorrosion Treatment of Outdoor Heat Exchanger	—	—	—	
	Outdoor Unit Quiet Operation (Manual)	—	—	—	Flexibility	Multi-Split / Split Type Compatible Indoor Unit	○	○	○	
	INTELLIGENT EYE	—	—	—		H/P, C/O Compatible Indoor Unit	—	—	—	
	2 Area INTELLIGENT EYE	—	—	—		Flexible Voltage Correspondence	○	—	—	
	Quick Warming Function	—	—	—		High Ceiling Application	—	—	○	
Operation	Hot-Start Function	—	—	—	Chargeless	—	—	—		
	Automatic Defrosting	—	—	—	Either Side Drain (Right or Left)	—	—	—		
	Automatic Operation	—	—	—	Power-Selection	—	—	—		
	Programme Dry Function	○	○	○	Remote Control	5-Rooms Centralized Controller (Option)	○	○	—	
	Fan Only	○	○	○		Remote Control Adaptor (Normal Open-Pulse Contact) (Option)	○	○	—	
	New POWERFUL Operation (Non-Inverter)	—	—	—		Remote Control Adaptor (Normal Open Contact) (Option)	○	○	—	
	Lifestyle Convenience	Inverter POWERFUL Operation	○	○	—	Remote Controller	DIII-NET Compatible (Adaptor) (Option)	○	○	○
		Priority-Room Setting	—	—	—		Wireless	○	○	○
Cooling / Heating Mode Lock		—	—	—	Wired	—	—	○		
HOME LEAVE Operation		○	—	—						
ECONO Mode		—	○	—						
Indoor Unit On/Off Switch		○	○	—						
Signal Reception Indicator		○	○	—						
Temperature Display		—	—	—						

**Note:** ○ : Holding Functions  
— : No Functions



Category	Functions	4MKS75F2V1B	Category	Functions	4MKS75F2V1B	
Basic Function	Inverter (with Inverter Power Control)	○	Health & Clean	Air Purifying Filter	—	
	Operation Limit for Cooling (°CDB)	-10 46		Photocatalytic Deodorizing Filter	—	
	Operation Limit for Heating (°CWB)	—		Air Purifying Filter with Photocatalytic Deodorizing Function	—	
	PAM Control	○		Titanium Apatite Photocatalytic Air-Purifying Filter	—	
Compressor	Oval Scroll Compressor	—		Longlife Filter (Option)	—	
	Swing Compressor	○		Mold Proof Air Filter	—	
	Rotary Compressor	—		Wipe-clean Flat Panel	—	
	Reluctance DC Motor	○		Washable Grille	—	
Comfortable Airflow	Power-Airflow Flap	—		Filter Cleaning Indicator	—	
	Power-Airflow Dual Flaps	—		Mold Proof Operation	—	
	Power-Airflow Diffuser	—		Heating Dry Operation	—	
	Wide-Angle Louvers	—		Good-Sleep Cooling Operation	—	
	Vertical Auto-Swing (Up and Down)	—	Timer	Weekly Timer	—	
	Horizontal Auto-Swing (Right and Left)	—		24-Hour On/Off Timer	—	
	3-D Airflow	—		72-Hour On/Off Timer	—	
	Comfort Airflow Mode	—		Night Set Mode	—	
Comfort Control	3-Step Airflow (H/P Only)	—	Worry Free "Reliability & Durability"	Auto-Restart (after Power Failure)	—	
	Auto Fan Speed	—		Self-Diagnosis (Digital, LED) Display	○	
	Indoor Unit Quiet Operation	—		Wiring-Error Check	○	
	Night Quiet Mode (Automatic)	○		Anticorrosion Treatment of Outdoor Heat Exchanger	○	
	Operation	Outdoor Unit Quiet Operation (Manual)	○	Flexibility	Multi-Split / Split Type Compatible Indoor Unit	—
		INTELLIGENT EYE	—		H/P, C/O Compatible Indoor Unit	—
		2 Area INTELLIGENT EYE	—		Flexible Voltage Correspondence	—
		Quick Warming Function	—		High Ceiling Application	—
Hot-Start Function		—	Chargeless		○	
Automatic Defrosting		—	Either Side Drain (Right or Left)		—	
Operation		Automatic Operation	—		Power-Selection	—
		Programme Dry Function	—		Remote Control	5-Rooms Centralized Controller (Option)
	Fan Only	—	Remote Control Adaptor (Normal Open-Pulse Contact) (Option)	—		
Lifestyle Convenience	New POWERFUL Operation (Non-Inverter)	—	Remote Control Adaptor (Normal Open Contact) (Option)	—		
	Inverter POWERFUL Operation	—	DIII-NET Compatible (Adaptor) (Option)	—		
	Priority-Room Setting	○	Remote Controller	Wireless	—	
	Cooling / Heating Mode Lock	—		Wired	—	
	HOME LEAVE Operation	—				
	ECONO Mode	—				
	Indoor Unit On/Off Switch	—				
	Signal Reception Indicator	—				
Temperature Display	—					

**Note:** ○ : Holding Functions  
— : No Functions

## 1.2 Heat Pump Models

Category	Functions				Category	Functions				
		FTXG25/35EV1BW(S)	CTXG50EV1BW(S)	FTXS20-50G2V1B			FTXG25/35EV1BW(S)	CTXG50EV1BW(S)	FTXS20-50G2V1B	
Basic Function	Inverter (with Inverter Power Control)	○	○	○	Health & Clean	Air Purifying Filter	—	—	—	
	Operation Limit for Cooling (°CDB)	—	—	—		Photocatalytic Deodorizing Filter	—	—	—	
	Operation Limit for Heating (°CWB)	—	—	—		Air Purifying Filter with Photocatalytic Deodorizing Function	—	—	—	
PAM Control	—	—	—	Titanium Apatite Photocatalytic Air-Purifying Filter		○	○	○		
Compressor	Oval Scroll Compressor	—	—	—		Longlife Filter (Option)	—	—	—	
	Swing Compressor	—	—	—		Mold Proof Air Filter	○	○	○	
	Rotary Compressor	—	—	—		Wipe-clean Flat Panel	○	○	○	
	Reluctance DC Motor	—	—	—		Washable Grille	—	—	—	
Comfortable Airflow	Power-Airflow Flap	—	—	—		Filter Cleaning Indicator	—	—	—	
	Power-Airflow Dual Flaps	○	○	○		Mold Proof Operation	—	—	—	
	Power-Airflow Diffuser	—	—	—	Heating Dry Operation	—	—	—		
	Wide-Angle Louvers	○	○	○	Good-Sleep Cooling Operation	—	—	—		
	Vertical Auto-Swing (Up and Down)	○	○	○	Timer	Weekly Timer	—	—	○	
	Horizontal Auto-Swing (Right and Left)	○	○	○		24-Hour On/Off Timer	○	○	○	
	3-D Airflow	○	○	○		72-Hour On/Off Timer	—	—	—	
	Comfort Airflow Mode	○	○	○		Night Set Mode	○	○	○	
3-Step Airflow (H/P Only)	—	—	—	Worry Free "Reliability & Durability"	Auto-Restart (after Power Failure)	○	○	○		
Comfort Control	Auto Fan Speed	○	○		○	Self-Diagnosis (Digital, LED) Display	○	○	○	
	Indoor Unit Quiet Operation	○	○		○	Wiring Error Check	—	—	—	
	Night Quiet Mode (Automatic)	—	—		—	Anticorrosion Treatment of Outdoor Heat Exchanger	—	—	—	
	Outdoor Unit Quiet Operation (Manual)	—	—		—	Flexibility	Multi-Split / Split Type Compatible Indoor Unit	○	—	○
	INTELLIGENT EYE	○	○		—		H/P, C/O Compatible Indoor Unit	—	—	○
	2 Area INTELLIGENT EYE	—	—		○		Flexible Voltage Correspondence	—	—	—
	Quick Warming Function	—	—		—		High Ceiling Application	—	—	—
	Hot-Start Function	○	○	○	Chargeless	—	—	—		
Automatic Defrosting	—	—	—	Remote Control	Either Side Drain (Right or Left)	○	○	○		
Operation	Automatic Operation	○	○		○	Power Selection	—	—	—	
	Programme Dry Function	○	○		○	5-Rooms Centralized Controller (Option)	○	○	○	
	Fan Only	○	○		○	Remote Control Adaptor (Normal Open-Pulse Contact) (Option)	○	○	○	
Lifestyle Convenience	New POWERFUL Operation (Non-Inverter)	—	—		—	Remote Control Adaptor (Normal Open Contact) (Option)	○	○	○	
	Inverter POWERFUL Operation	○	○		○	DIII-NET Compatible (Adaptor) (Option)	○	○	○	
	Priority-Room Setting	—	—		—	Remote Controller	Wireless	○	○	○
	Cooling / Heating Mode Lock	—	—		—		Wired	—	—	—
	HOME LEAVE Operation	—	—	—						
	ECONO Mode	—	—	○						
	Indoor Unit On/Off Switch	○	○	○						
	Signal Reception Indicator	○	○	—						
Temperature Display	—	—	—							

**Note:** ○ : Holding Functions  
— : No Functions

Category	Functions	FTXS60/71FV1B	Category	Functions	FTXS60/71FV1B	
Basic Function	Inverter (with Inverter Power Control)	○	Health & Clean	Air Purifying Filter	—	
	Operation Limit for Cooling (°CDB)	—		Photocatalytic Deodorizing Filter	—	
	Operation Limit for Heating (°CWB)	—		Air Purifying Filter with Photocatalytic Deodorizing Function	—	
	PAM Control	—		Titanium Apatite Photocatalytic Air-Purifying Filter	○	
Compressor	Oval Scroll Compressor	—		Longlife Filter (Option)	—	
	Swing Compressor	—		Mold Proof Air Filter	○	
	Rotary Compressor	—		Wipe-clean Flat Panel	○	
	Reluctance DC Motor	—		Washable Grille	—	
Comfortable Airflow	Power-Airflow Flap	—		Filter Cleaning Indicator	—	
	Power-Airflow Dual Flaps	○		Mold Proof Operation	—	
	Power-Airflow Diffuser	—		Heating Dry Operation	—	
	Wide-Angle Louvers	○		Good-Sleep Cooling Operation	—	
	Vertical Auto-Swing (Up and Down)	○		Timer	Weekly Timer	—
	Horizontal Auto-Swing (Right and Left)	○			24-Hour On/Off Timer	○
	3-D Airflow	○			72-Hour On/Off Timer	—
	Comfort Airflow Mode	—			Night Set Mode	○
Comfort Control	3-Step Airflow (H/P Only)	—	Worry Free "Reliability & Durability"	Auto-Restart (after Power Failure)	○	
	Auto Fan Speed	○		Self-Diagnosis (Digital, LED) Display	○	
	Indoor Unit Quiet Operation	○		Wiring-Error Check	—	
	Night Quiet Mode (Automatic)	—	Flexibility	Anticorrosion Treatment of Outdoor Heat Exchanger	—	
	Outdoor Unit Quiet Operation (Manual)	—		Multi-Split / Split Type Compatible Indoor Unit	○	
	INTELLIGENT EYE	○		H/P, C/O Compatible Indoor Unit	—	
	2 Area INTELLIGENT EYE	—		Flexible Voltage Correspondence	—	
	Quick Warming Function	—		High Ceiling Application	—	
Hot-Start Function	○	Chargeless	—			
Automatic Defrosting	—	Either Side Drain (Right or Left)	○			
Operation	Automatic Operation	○	Power-Selection	—		
	Programme Dry Function	○	Remote Control	5-Rooms Centralized Controller (Option)	○	
	Fan Only	○		Remote Control Adaptor (Normal Open-Pulse Contact) (Option)	○	
Lifestyle Convenience	New POWERFUL Operation (Non-Inverter)	—		Remote Control Adaptor (Normal Open Contact) (Option)	○	
	Inverter POWERFUL Operation	○	DIII-NET Compatible (Adaptor) (Option)	○		
	Priority-Room Setting	—	Remote Controller	Wireless	○	
	Cooling / Heating Mode Lock	—		Wired	—	
	HOME LEAVE Operation	○				
	ECONO Mode	—				
	Indoor Unit On/Off Switch	○				
	Signal Reception Indicator	○				
Temperature Display	—					

**Note:** ○ : Holding Functions  
 — : No Functions

Category	Functions	FDXS50/60CVMB	FDXS25/35EAVMB	Category	Functions	FDXS50/60CVMB	FDXS25/35EAVMB	
Basic Function	Inverter (with Inverter Power Control)	○	○	Health & Clean	Air Purifying Filter	—	—	
	Operation Limit for Cooling (°CDB)	—	—		Photocatalytic Deodorizing Filter	—	—	
	Operation Limit for Heating (°CWB)	—	—		Air Purifying Filter with Photocatalytic Deodorizing Function	—	—	
	PAM Control	—	—		Titanium Apatite Photocatalytic Air-Purifying Filter	—	—	
Compressor	Oval Scroll Compressor	—	—		Longlife Filter (Option)	—	—	
	Swing Compressor	—	—		Mold Proof Air Filter	○	○	
	Rotary Compressor	—	—		Wipe-clean Flat Panel	—	—	
	Reluctance DC Motor	—	—		Washable Grille	—	—	
Comfortable Airflow	Power-Airflow Flap	—	—		Filter Cleaning Indicator	—	—	
	Power-Airflow Dual Flaps	—	—		Mold Proof Operation	—	—	
	Power-Airflow Diffuser	—	—		Heating Dry Operation	—	—	
	Wide-Angle Louvers	—	—		Good-Sleep Cooling Operation	—	—	
	Vertical Auto-Swing (Up and Down)	—	—		Timer	Weekly Timer	—	—
	Horizontal Auto-Swing (Right and Left)	—	—			24-Hour On/Off Timer	○	○
	3-D Airflow	—	—			72-Hour On/Off Timer	—	—
	3-Step Airflow (H/P Only)	—	—			Night Set Mode	○	○
Comfort Control	Auto Fan Speed	○	○	Worry Free "Reliability & Durability"	Auto-Restart (after Power Failure)	○	○	
	Indoor Unit Quiet Operation	○	○		Self-Diagnosis (Digital, LED) Display	○	○	
	Night Quiet Mode (Automatic)	—	—		Wiring-Error Check	—	—	
	Outdoor Unit Quiet Operation (Manual)	—	—		Anticorrosion Treatment of Outdoor Heat Exchanger	—	—	
	INTELLIGENT EYE	—	—	Flexibility	Multi-Split / Split Type Compatible Indoor Unit	○	○	
	2 Area INTELLIGENT EYE	—	—		H/P, C/O Compatible Indoor Unit	—	—	
	Quick Warming Function	—	—		Flexible Voltage Correspondence	○	○	
	Hot-Start Function	○	○		High Ceiling Application	—	—	
	Automatic Defrosting	—	—		Chargeless	—	—	
		—	—		Either Side Drain (Right or Left)	—	—	
Operation	Automatic Operation	○	○	Remote Control	Power-Selection	—	—	
	Programme Dry Function	○	○		5-Rooms Centralized Controller (Option)	○	○	
	Fan Only	○	○		Remote Control Adaptor (Normal Open-Pulse Contact) (Option)	○	○	
Lifestyle Convenience	New POWERFUL Operation (Non-Inverter)	—	—	Remote Control	Remote Control Adaptor (Normal Open Contact) (Option)	○	○	
	Inverter POWERFUL Operation	○	○		DIII-NET Compatible (Adaptor) (Option)	○	○	
	Priority-Room Setting	—	—	Remote Controller	Wireless	○	○	
	Cooling / Heating Mode Lock	—	—		Wired	—	—	
	HOME LEAVE Operation	○	○					
	ECONO Mode	—	—					
	Indoor Unit On/Off Switch	○	○					
	Signal Reception Indicator	○	○					
Temperature Display	—	—						

**Note:** ○ : Holding Functions  
— : No Functions

Category	Functions				Category	Functions			
		FLXS25-60BAVMB	FYXS25-50FV1B	FHQ35-60BVV1B			FLXS25-60BAVMB	FYXS25-50FV1B	FHQ35-60BVV1B
Basic Function	Inverter (with Inverter Power Control)	○	○	○	Health & Clean	Air Purifying Filter	○	—	—
	Operation Limit for Cooling (°CDB)	—	—	—		Photocatalytic Deodorizing Filter	○	—	—
	Operation Limit for Heating (°CWB)	—	—	—		Air Purifying Filter with Photocatalytic Deodorizing Function	—	—	—
	PAM Control	—	—	—		Titanium Apatite Photocatalytic Air-Purifying Filter	—	○	—
Compressor	Oval Scroll Compressor	—	—	—	Longlife Filter (Option)	—	—	○	
	Swing Compressor	—	—	—	Mold Proof Air Filter	○	○	○	
	Rotary Compressor	—	—	—	Wipe-clean Flat Panel	—	○	—	
	Reluctance DC Motor	—	—	—	Washable Grille	—	—	○	
Comfortable Airflow	Power-Airflow Flap	—	—	—	Filter Cleaning Indicator	—	—	○	
	Power-Airflow Dual Flaps	—	—	—	Mold Proof Operation	—	—	—	
	Power-Airflow Diffuser	—	—	—	Heating Dry Operation	—	—	—	
	Wide-Angle Louvers	—	○	—	Good-Sleep Cooling Operation	—	—	—	
	Vertical Auto-Swing (Up and Down)	○	○	○	Timer	Weekly Timer	—	○	—
	Horizontal Auto-Swing (Right and Left)	—	—	—		24-Hour On/Off Timer	○	○	—
	3-D Airflow	—	—	—		72-Hour On/Off Timer	—	—	○
	Comfort Airflow Mode	—	—	—		Night Set Mode	○	○	—
Comfort Control	3-Step Airflow (H/P Only)	—	—	—	Worry Free "Reliability & Durability"	Auto-Restart (after Power Failure)	○	○	○
	Auto Fan Speed	○	○	—		Self-Diagnosis (Digital, LED) Display	○	○	○
	Indoor Unit Quiet Operation	○	○	—		Wiring-Error Check	—	—	—
	Night Quiet Mode (Automatic)	—	—	—		Anticorrosion Treatment of Outdoor Heat Exchanger	—	—	—
	Outdoor Unit Quiet Operation (Manual)	—	—	—	Flexibility	Multi-Split / Split Type Compatible Indoor Unit	○	○	○
	INTELLIGENT EYE	—	—	—		H/P, C/O Compatible Indoor Unit	—	—	—
	2 Area INTELLIGENT EYE	—	—	—		Flexible Voltage Correspondence	○	—	—
	Quick Warming Function	—	—	—		High Ceiling Application	—	—	○
Operation	Hot-Start Function	○	○	○	Chargeless	—	—	—	
	Automatic Defrosting	—	—	—	Either Side Drain (Right or Left)	—	—	—	
	Automatic Operation	○	○	○	Power-Selection	—	—	—	
Lifestyle Convenience	Programme Dry Function	○	○	○	Remote Control	5-Rooms Centralized Controller (Option)	○	○	—
	Fan Only	○	○	○		Remote Control Adaptor (Normal Open-Pulse Contact) (Option)	○	○	—
	New POWERFUL Operation (Non-Inverter)	—	—	—		Remote Control Adaptor (Normal Open Contact) (Option)	○	○	—
	Inverter POWERFUL Operation	○	○	—	Remote Controller	DIII-NET Compatible (Adaptor) (Option)	○	○	○
	Priority-Room Setting	—	—	—		Wireless	○	○	○
	Cooling / Heating Mode Lock	—	—	—		Wired	—	—	○
	HOME LEAVE Operation	○	—	—					
	ECONO Mode	—	○	—					
Indoor Unit On/Off Switch	○	○	—						
Signal Reception Indicator	○	○	—						
Temperature Display	—	—	—						

**Note:** ○ : Holding Functions  
— : No Functions

Category	Functions	3MXS68G2V1B 4MXS68F2V1B	Category	Functions	3MXS68G2V1B 4MXS68F2V1B	
Basic Function	Inverter (with Inverter Power Control)	○	Health & Clean	Air Purifying Filter	—	
	Operation Limit for Cooling (°CDB)	-10 ~ 46		Photocatalytic Deodorizing Filter	—	
	Operation Limit for Heating (°CWB)	-15 ~ 15.5		Air Purifying Filter with Photocatalytic Deodorizing Function	—	
	PAM Control	○		Titanium Apatite Photocatalytic Air-Purifying Filter	—	
Compressor	Oval Scroll Compressor	—		Longlife Filter (Option)	—	
	Swing Compressor	○		Mold Proof Air Filter	—	
	Rotary Compressor	—		Wipe-clean Flat Panel	—	
	Reluctance DC Motor	○		Washable Grille	—	
Comfortable Airflow	Power-Airflow Flap	—		Filter Cleaning Indicator	—	
	Power-Airflow Dual Flaps	—		Mold Proof Operation	—	
	Power-Airflow Diffuser	—	Heating Dry Operation	—		
	Wide-Angle Louvers	—	Good-Sleep Cooling Operation	—		
	Vertical Auto-Swing (Up and Down)	—	Timer	Weekly Timer	—	
	Horizontal Auto-Swing (Right and Left)	—		24-Hour On/Off Timer	—	
	3-D Airflow	—		72-Hour On/Off Timer	—	
	Comfort Airflow Mode	—		Night Set Mode	—	
Comfort Control	3-Step Airflow (H/P Only)	—	Worry Free "Reliability & Durability"	Auto-Restart (after Power Failure)	—	
	Auto Fan Speed	—		Self-Diagnosis (Digital, LED) Display	○	
	Indoor Unit Quiet Operation	—		Wiring-Error Check	○	
	Night Quiet Mode (Automatic)	○		Anticorrosion Treatment of Outdoor Heat Exchanger	○	
	Operation	Outdoor Unit Quiet Operation (Manual)	○	Flexibility	Multi-Split / Split Type Compatible Indoor Unit	—
		INTELLIGENT EYE	—		H/P, C/O Compatible Indoor Unit	—
		2 Area INTELLIGENT EYE	—		Flexible Voltage Correspondence	—
		Quick Warming Function	○		High Ceiling Application	—
Hot-Start Function		—	Chargeless		30m	
Automatic Defrosting		○	Either Side Drain (Right or Left)		—	
Operation		Automatic Operation	—		Power-Selection	—
		Programme Dry Function	—		Remote Control	5-Rooms Centralized Controller (Option)
	Fan Only	—	Remote Control Adaptor (Normal Open-Pulse Contact) (Option)	—		
Lifestyle Convenience	New POWERFUL Operation (Non-Inverter)	—	Remote Control Adaptor (Normal Open Contact) (Option)	—		
	Inverter POWERFUL Operation	—	DIII-NET Compatible (Adaptor) (Option)	—		
	Priority-Room Setting	○	Remote Controller	Wireless	—	
	Cooling / Heating Mode Lock	○		Wired	—	
	HOME LEAVE Operation	—				
	ECONO Mode	—				
	Indoor Unit On/Off Switch	—				
	Signal Reception Indicator	—				
Temperature Display	—					

**Note:** ○ : Holding Functions  
— : No Functions



# Part 2

# Specifications

1. Specifications .....	14
1.1 Indoor Units - Cooling Only .....	14
1.2 Outdoor Units - Cooling Only .....	20
1.3 Indoor Units - Heat Pump .....	21
1.4 Outdoor Units - Heat Pump .....	29



# 1. Specifications

## 1.1 Indoor Units - Cooling Only

### Wall Mounted Type

50Hz 230V

Model			FTXS20G2V1B	FTXS25G2V1B
Rated Capacity			2.0kW Class	2.5kW Class
Front Panel Color			White	White
Airflow Rates	m <sup>3</sup> /min (cfm)	H	9.4 (332)	9.1 (321)
		M	7.4 (262)	7.1 (252)
		L	5.5 (193)	5.2 (182)
		SL	4.0 (141)	3.7 (130)
Fan	Type		Cross Flow Fan	Cross Flow Fan
	Motor Output	W	23	23
	Speed	Steps	5 Steps, Quiet, Auto	5 Steps, Quiet, Auto
Air Direction Control			Right, Left, Horizontal, Downward	Right, Left, Horizontal, Downward
Air Filter			Removable / Washable / Mildew Proof	Removable / Washable / Mildew Proof
Running Current (Rated)		A	0.08	0.08
Power Consumption (Rated)		W	18	18
Power Factor		%	97.8	97.8
Temperature Control			Microcomputer Control	Microcomputer Control
Dimensions (HxWxD)		mm	295x800x215	295x800x215
Packaged Dimensions (HxWxD)		mm	274x870x366	274x870x366
Weight		kg	9	9
Gross Weight		kg	13	13
Operation Sound	H/M/L/SL	dBA	38/32/25/22	38/32/25/22
Sound Power	H	dBA	54	54
Heat Insulation			Both Liquid and Gas Pipes	Both Liquid and Gas Pipes
Piping Connection	Liquid	mm	φ 6.4	φ 6.4
	Gas	mm	φ 9.5	φ 9.5
	Drain	mm	φ18.0	φ18.0
Drawing No.			3D059727	3D059728

Model			FTXS35G2V1B	FTXS42G2V1B
Rated Capacity			3.5kW Class	4.2kW Class
Front Panel Color			White	White
Airflow Rates	m <sup>3</sup> /min (cfm)	H	10.4 (367)	9.1 (321)
		M	7.7 (270)	7.7 (273)
		L	4.8 (170)	6.3 (221)
		SL	3.5 (125)	5.4 (190)
Fan	Type		Cross Flow Fan	Cross Flow Fan
	Motor Output	W	23	23
	Speed	Steps	5 Steps, Quiet, Auto	5 Steps, Quiet, Auto
Air Direction Control			Right, Left, Horizontal, Downward	Right, Left, Horizontal, Downward
Air Filter			Removable / Washable / Mildew Proof	Removable / Washable / Mildew Proof
Running Current (Rated)		A	0.12	0.11
Power Consumption (Rated)		W	26	24
Power Factor		%	94.2	94.9
Temperature Control			Microcomputer Control	Microcomputer Control
Dimensions (HxWxD)		mm	295x800x215	295x800x215
Packaged Dimensions (HxWxD)		mm	274x870x366	274x870x366
Weight		kg	10	10
Gross Weight		kg	13	13
Operation Sound	H/M/L/SL	dBA	42/34/26/23	42/38/33/30
Sound Power	H	dBA	58	58
Heat Insulation			Both Liquid and Gas Pipes	Both Liquid and Gas Pipes
Piping Connection	Liquid	mm	φ 6.4	φ 6.4
	Gas	mm	φ 9.5	φ 9.5
	Drain	mm	φ18.0	φ18.0
Drawing No.			3D059729	3D059730

Conversion Formulae
kcal/h=kWx860
Btu/h=kWx3414
cfm=m <sup>3</sup> /minx35.3

50Hz 230V

Model			FTXS50G2V1B		
Rated Capacity			5.0kW Class		
Front Panel Color			White		
Airflow Rates	m <sup>3</sup> /min (cfm)	H	10.2 (360)		
		M	8.6 (305)		
		L	7.0 (246)		
		SL	6.0 (212)		
Fan	Type	Cross Flow Fan			
	Motor Output	W	23		
	Speed	Steps	5 Steps, Quiet, Auto		
Air Direction Control			Right, Left, Horizontal, Downward		
Air Filter			Removable / Washable / Mildew Proof		
Running Current (Rated)		A	0.12		
Power Consumption (Rated)		W	26		
Power Factor		%	94.2		
Temperature Control			Microcomputer Control		
Dimensions (HxWxD)		mm	295x800x215		
Packaged Dimensions (HxWxD)		mm	274x870x366		
Weight		kg	10		
Gross Weight		kg	13		
Operation Sound	H/M/L/SL	dBA	43/39/34/31		
Sound Power	H	dBA	59		
Heat Insulation			Both Liquid and Gas Pipes		
Piping Connection	Liquid	mm	φ 6.4		
	Gas	mm	φ 9.5		
	Drain	mm	φ18.0		
Drawing No.			3D059731		

Model			FTKS60FV1B			FTKS71FV1B		
Rated Capacity			6.0kW Class			7.1kW Class		
Front Panel Color			White			White		
Airflow Rates	m <sup>3</sup> /min (cfm)	H	16.2 (572)			17.4 (614)		
		M	13.6 (480)			14.6 (516)		
		L	11.4 (403)			11.6 (410)		
		SL	10.2 (360)			10.6 (374)		
Fan	Type	Cross Flow Fan						
	Motor Output	W	43			43		
	Speed	Steps	5 Steps, Quiet, Auto			5 Steps, Quiet, Auto		
Air Direction Control			Right, Left, Horizontal, Downward			Right, Left, Horizontal, Downward		
Air Filter			Removable-Washable-Mildew Proof			Removable-Washable-Mildew Proof		
Running Current (Rated)		A	0.18			0.20		
Power Consumption (Rated)		W	40			45		
Power Factor		%	96.6			97.8		
Temperature Control			Microcomputer Control			Microcomputer Control		
Dimensions (HxWxD)		mm	290x1,050x238			290x1,050x238		
Packaged Dimensions (HxWxD)		mm	337x1,147x366			337x1,147x366		
Weight		kg	12			12		
Gross Weight		kg	17			17		
Operation Sound	H/M/L/SL	dBA	45/41/36/33			46/42/37/34		
Sound Power	H	dBA	61			62		
Heat Insulation			Both Liquid and Gas Pipes			Both Liquid and Gas Pipes		
Piping Connection	Liquid	mm	φ 6.4			φ 6.4		
	Gas	mm	φ 12.7			φ 15.9		
	Drain	mm	φ18.0			φ18.0		
Drawing No.			3D056017			3D056018A		

Conversion Formulae
kcal/h=kWx860
Btu/h=kWx3414
cfm=m <sup>3</sup> /minx35.3

Duct Connected Type

50Hz 230V

Model			FDKS50CVMB	FDKS60CVMB
Rated Capacity			5.0kW Class	6.0kW Class
Front Panel Color			—	—
Airflow Rates	m <sup>3</sup> /min (cfm)	H	12.0 (424)	16.0 (565)
		M	11.0 (388)	14.8 (523)
		L	10.0 (353)	13.5 (477)
		SL	8.4 (297)	11.2 (395)
Fan	Type	Sirocco Fan		Sirocco Fan
	Motor Output	W	130	130
	Speed	Steps	5 Steps, Quiet, Auto	5 Steps, Quiet, Auto
Air Filter			Removable-Washable-Mildew Proof	Removable-Washable-Mildew Proof
Running Current (Rated)		A	0.64	0.74
Power Consumption (Rated)		W	140	160
Power Factor		%	95.1	94.0
Temperature Control			Microcomputer Control	Microcomputer Control
Dimensions (HxWxD)		mm	200x900x620	200x1,100x620
Packaged Dimensions (HxWxD)		mm	266x1,106x751	266x1,306x751
Weight		kg	27	30
Gross Weight		kg	34	37
Operation Sound	H/M/L/SL	dBA	37/35/33/31	38/36/34/32
External Static Pressure		Pa	40	40
Moisture Removal		L/h	2.9	3.9
Heat Insulation			Both Liquid and Gas Pipes	Both Liquid and Gas Pipes
Piping Connection	Liquid	mm	φ 6.4	φ 6.4
	Gas	mm	φ12.7	φ12.7
	Drain	mm	VP20 (O.D. φ26 / I.D. φ20)	VP20 (O.D. φ26 / I.D. φ20)
Drawing No.			3D052134A	3D052135

Model			FDKS25EAVMB	FDKS35EAVMB
Rated Capacity			2.5kW Class	3.5kW Class
Front Panel Color			—	—
Airflow Rates	m <sup>3</sup> /min (cfm)	H	8.7 (307)	8.7 (307)
		M	8.0 (282)	8.0 (282)
		L	7.3 (258)	7.3 (258)
		SL	6.2 (219)	6.2 (219)
Fan	Type	Sirocco Fan		Sirocco Fan
	Motor Output	W	62	62
	Speed	Steps	5 Steps, Quiet, Auto	5 Steps, Quiet, Auto
Air Filter			Removable-Washable-Mildew Proof	Removable-Washable-Mildew Proof
Running Current (Rated)		A	0.48	0.48
Power Consumption (Rated)		W	71	71
Power Factor		%	64.3	64.3
Temperature Control			Microcomputer Control	Microcomputer Control
Dimensions (HxWxD)		mm	200x700x620	200x700x620
Packaged Dimensions (HxWxD)		mm	274x906x751	274x906x751
Weight		kg	21	21
Gross Weight		kg	29	29
Operation Sound	H/M/L/SL	dBA	35/33/31/29	35/33/31/29
External Static Pressure		Pa	30	30
Moisture Removal		L/h	1.2	1.9
Heat Insulation			Both Liquid and Gas Pipes	Both Liquid and Gas Pipes
Piping Connection	Liquid	mm	φ 6.4	φ 6.4
	Gas	mm	φ 9.5	φ 9.5
	Drain	mm	VP20 (O.D. φ 26 / I.D. φ 20)	VP20 (O.D. φ 26 / I.D. φ 20)
Drawing No.			3D051882A	3D051884A

**Note:** 1. The operating sound is based on the rear side suction inlet and the external static pressure 30 Pa. Operating sound for under side suction inlet: [operating sound for rear side suction inlet]+6 dB. However, when installation to which the external static pressure becomes low is carried out, 6 dB or more may go up.

Conversion Formulae
kcal/h=kW×860
Btu/h=kW×3414
cfm=m <sup>3</sup> /min×35.3

## Floor / Ceiling Suspended Dual Type

50Hz 230V

Model				FLKS25BAVMB		FLKS35BAVMB		
Rated Capacity				2.5kW Class		3.5kW Class		
Front Panel Color				Almond White		Almond White		
Airflow Rates		m <sup>3</sup> /min (cfm)	H	7.6 (268)		8.6 (304)		
			M	6.8 (240)		7.6 (268)		
			L	6.0 (212)		6.6 (233)		
			SL	5.2 (184)		5.6 (198)		
Fan	Type		Sirocco Fan		Sirocco Fan			
	Motor Output		W		34			
	Speed		Steps		5 Steps, Quiet, Auto			
Air Direction Control				Right, Left, Horizontal, Downward		Right, Left, Horizontal, Downward		
Air Filter				Removable-Washable-Mildew Proof		Removable-Washable-Mildew Proof		
Running Current (Rated)		A		0.34		0.36		
Power Consumption (Rated)		W		74		78		
Power Factor		%		94.6		94.2		
Temperature Control				Microcomputer Control		Microcomputer Control		
Dimensions (HxWxD)		mm		490x1,050x200		490x1,050x200		
Packaged Dimensions (HxWxD)		mm		566x1,100x280		566x1,100x280		
Weight		kg		16		16		
Gross Weight		kg		22		22		
Operation Sound	H/M/L/SL		dBA		37/34/31/28		38/35/32/29	
Sound Power	H		dBA		53		54	
Heat Insulation				Both Liquid and Gas Pipes		Both Liquid and Gas Pipes		
Piping Connection		Liquid	mm	φ 6.4		φ 6.4		
		Gas	mm	φ 9.5		φ 9.5		
		Drain	mm	φ18.0		φ18.0		
Drawing No.				3D050862		3D050864		

Model				FLKS50BAVMB		FLKS60BAVMB		
Rated Capacity				5.0W Class		6.0kW Class		
Front Panel Color				Almond White		Almond White		
Airflow Rates		m <sup>3</sup> /min (cfm)	H	11.4 (402)		12.0 (424)		
			M	10.0 (353)		10.7 (378)		
			L	8.5 (300)		9.3 (328)		
			SL	7.5 (265)		8.3 (293)		
Fan	Type		Sirocco Fan		Sirocco Fan			
	Motor Output		W		34			
	Speed		Steps		5 Steps, Quiet, Auto			
Air Direction Control				Right, Left, Horizontal, Downward		Right, Left, Horizontal, Downward		
Air Filter				Removable-Washable-Mildew Proof		Removable-Washable-Mildew Proof		
Running Current (Rated)		A		0.45		0.45		
Power Consumption (Rated)		W		96		98		
Power Factor		%		92.8		94.7		
Temperature Control				Microcomputer Control		Microcomputer Control		
Dimensions (HxWxD)		mm		490x1,050x200		490x1,050x200		
Packaged Dimensions (HxWxD)		mm		280x1,100x566		280x1,100x566		
Weight		kg		17		17		
Gross Weight		kg		24		24		
Operation Sound	H/M/L/SL		dBA		47/43/39/36		48/45/41/39	
Sound Power	H		dBA		63		64	
Heat Insulation				Both Liquid and Gas Pipes		Both Liquid and Gas Pipes		
Piping Connection		Liquid	mm	φ 6.4		φ 6.4		
		Gas	mm	φ12.7		φ12.7		
		Drain	mm	φ18.0		φ18.0		
Drawing No.				3D050896		3D050881		

## Conversion Formulae

kcal/h=kW×860  
 Btu/h=kW×3414  
 cfm=m<sup>3</sup>/min×35.3

Floor Standing Type

50Hz 230V

Model				FVXS25FV1B	FVXS35FV1B	
Rated Capacity				2.5kW Class	3.5kW Class	
Front Panel Color				White	White	
Airflow Rates	m <sup>3</sup> /min (cfm)	H		8.2 (290)	8.5 (300)	
		M		6.5 (229)	6.7 (237)	
		L		4.8 (169)	4.9 (174)	
		SL		4.1 (146)	4.5 (158)	
Fan	Type			Turbo Fan	Turbo Fan	
	Motor Output	W			48	48
	Speed	Steps			5 Steps, Quiet, Auto	5 Steps, Quiet, Auto
Air Direction Control				Right, Left, Horizontal, Downward	Right, Left, Horizontal, Downward	
Air Filter				Removable-Washable-Mildew Proof	Removable-Washable-Mildew Proof	
Running Current (Rated)		A			0.13	0.13
Power Consumption (Rated)		W			15	15
Power Factor		%			50.2	50.2
Temperature Control				Microcomputer Control	Microcomputer Control	
Dimensions (HxWxD)		mm			600x700x210	600x700x210
Packaged Dimensions (HxWxD)		mm			696x786x286	696x786x286
Weight		kg			14	14
Gross Weight		kg			18	18
Operation Sound	H/M/L/SL	dBA			38/32/26/23	39/33/27/24
Sound Power	H	dBA			54	55
Heat Insulation				Both Liquid and Gas Pipes	Both Liquid and Gas Pipes	
Piping Connection	Liquid	mm			φ 6.4	φ 6.4
	Gas	mm			φ 9.5	φ 9.5
	Drain	mm			φ 20	φ 20
Drawing No.				3D056295A	3D056296A	

Model				FVXS50FV1B	
Rated Capacity				5.0kW Class	
Front Panel Color				White	
Airflow Rates	m <sup>3</sup> /min (cfm)	H		10.7 (378)	
		M		9.2 (326)	
		L		7.8 (274)	
		SL		6.6 (233)	
Fan	Type			Turbo Fan	
	Motor Output	W			48
	Speed	Steps			5 Steps, Quiet, Auto
Air Direction Control				Right, Left, Horizontal, Downward	
Air Filter				Removable-Washable-Mildew Proof	
Running Current (Rated)		A			0.17
Power Consumption (Rated)		W			27
Power Factor		%			69.1
Temperature Control				Microcomputer Control	
Dimensions (HxWxD)		mm			600x700x210
Packaged Dimensions (HxWxD)		mm			696x786x286
Weight		kg			14
Gross Weight		kg			18
Operation Sound	H/M/L/SL	dBA			44/40/36/32
Sound Power	H	dBA			56
Heat Insulation				Both Liquid and Gas Pipes	
Piping Connection	Liquid	mm			φ 6.4
	Gas	mm			φ 12.7
	Drain	mm			φ 20.0
Drawing No.				3D056297	

Conversion Formulae
kcal/h=kWx860
Btu/h=kWx3414
cfm=m <sup>3</sup> /minx35.3

## Ceiling-suspended Type

50Hz 230V

Model			FHQ35BVV1B	FHQ50BVV1B	FHQ60BVV1B
Rated Capacity			3.5kW Class	5.0kW Class	6.0kW Class
Decoration Panel	Color		White	White	White
	Dimensions (HxWxD)		—	—	—
Airflow Rates	m <sup>3</sup> /min (cfm)	H	13.0 (458)	13.0 (458)	17.0 (600)
		M	—	—	—
		L	10.0 (353)	10.0 (353)	13.0 (459)
		SL	—	—	—
Fan	Type		Sirocco Fan	Sirocco Fan	Sirocco Fan
	Motor Output	W	62	62	62
	Speed	Steps	2 Steps	2 Steps	2 Steps
Air Direction Control			Right, Left, Horizontal, Downward	Right, Left, Horizontal, Downward	Right, Left, Horizontal, Downward
Air Filter			Removable-Washable-Mildew Proof	Removable-Washable-Mildew Proof	Removable-Washable-Mildew Proof
Temperature Control			Microcomputer Control	Microcomputer Control	Microcomputer Control
Dimensions (HxWxD)		mm	195x960x680	195x960x680	195x1,160x680
Packaged Dimensions (HxWxD)		mm	279x1,046x818	279x1,046x818	279x1,246x818
Weight		kg	24	25	27
Gross Weight		kg	31	32	35
Operation Sound	H/L	dBA	37/32	38/33	39/33
Sound Power	H/L	dBA	53/48	54/49	55/49
Heat Insulation			Both Liquid and Gas Pipes	Both Liquid and Gas Pipes	Both Liquid and Gas Pipes
Piping Connection	Liquid	mm	φ 6.4 (Flare)	φ 6.4 (Flare)	φ 6.4 (Flare)
	Gas	mm	φ 9.5 (Flare)	φ 12.7 (Flare)	φ 12.7 (Flare)
	Drain	mm	VP20 (O.D.φ 26 / I.D.φ 20)	VP20 (O.D.φ 26 / I.D.φ 20)	VP20 (O.D.φ 26 / I.D.φ 20)
Drawing No.			3D037992E	3D037992E	3D037992E

Conversion Formulae
kcal/h=kWx860
Btu/h=kWx3414
cfm=m <sup>3</sup> /minx35.3

# 1.2 Outdoor Units - Cooling Only

50Hz 230V

Model		4MKS75F2V1B	
Cooling Capacity	kW	—	
Power Consumption	W	—	
Running Current	A	—	
Casing Color	Ivory White		
Compressor	Type	Hermetically Sealed Swing Type	
	Model	2YC45DXD	
	Motor Output	W	1,380
Refrigerant Oil	Model	FVC50K	
	Charge	L	0.65
Refrigerant	Type	R-410A	
	Charge	kg	2.3
Airflow Rates	m <sup>3</sup> /min	H	52.7
		M	49.4
		L	43.5
	cfm	H	1,861
		M	1,744
		L	1,536
Fan	Type	Propeller	
	Motor Output	W	53
	Running Current	A	H: 0.20 / M: 0.16 / L: 0.10
	Power Consumption	W	H: 70 / M: 58 / L: 36
Starting Current	A	6.2	
Dimensions (HxWxD)	mm	735x936x300	
Packaged Dimensions (HxWxD)	mm	797x992x390	
Weight	kg	57	
Gross Weight	kg	61	
Operation Sound	dBA	48	
Sound Power	dBA	61	
Piping Connection	Liquid	mm	φ 6.4x4
	Gas	mm	φ 9.5x2, φ 12.7x1, φ 15.9x1
	Drain	mm	φ 18.0
Heat Insulation	Both Liquid and Gas Pipes		
No. of Wiring Connection	3 for Power Supply, 4 for Interunit Wiring		
Max. Interunit Piping Length	m	60 (for Total of Each Room)	
	m	25 (for One Room)	
Amount of Additional Charge	g/m	Chargeless	
Max. Installation Height Difference	m	15 (between Indoor Unit and Outdoor Unit)	
	m	15 (between Indoor Units)	
Drawing No.	3D056453		

**Note:** 1. The data are based on the conditions shown in the table below.

Cooling	Piping Length
Indoor ; 27°CDB/19°CWB Outdoor ; 35°CDB	5m

Conversion Formulae
kcal/h=kWx860 Btu/h=kWx3414 cfm=m <sup>3</sup> /minx35.3

# 1.3 Indoor Units - Heat Pump

## Wall Mounted Type

50Hz 230V

Model			FTXG25EV1BW		FTXG25EV1BS	
			Cooling	Heating	Cooling	Heating
Rated Capacity			2.5kW Class		2.5kW Class	
Front Panel Color			Mat Crystal White		Mat Crystal Silver	
Airflow Rates	m <sup>3</sup> /min (cfm)	H	7.7 (271)	9.0 (317)	7.7 (271)	9.0 (317)
		M	6.1 (215)	7.9 (278)	6.1 (215)	7.9 (278)
		L	4.7 (165)	6.7 (236)	4.7 (165)	6.7 (236)
		SL	3.8 (134)	5.4 (190)	3.8 (134)	5.4 (190)
Fan	Type	Cross Flow Fan		Cross Flow Fan		
	Motor Output	W	40	40	40	
	Speed	Steps	5 Steps, Quiet, Auto	5 Steps, Quiet, Auto	5 Steps, Quiet, Auto	
Air Direction Control			Right, Left, Horizontal, Downward		Right, Left, Horizontal, Downward	
Air Filter			Removable-Washable-Mildew Proof		Removable-Washable-Mildew Proof	
Running Current (Rated)			A	0.15-0.14-0.13	0.15-0.14-0.13	0.15-0.14-0.13
Power Consumption (Rated)			W	30-30-30	30-30-30	30-30-30
Power Factor			%	90.9-93.2-96.2	90.9-93.2-96.2	90.9-93.2-96.2
Temperature Control			Microcomputer Control		Microcomputer Control	
Dimensions (HxWxD)			mm	275x840x150	275x840x150	275x840x150
Packaged Dimensions (HxWxD)			mm	222x894x345	222x894x345	222x894x345
Weight			kg	9	9	9
Gross Weight			kg	13	13	13
Operation Sound	H/M/L/SL	dBA	38/32/25/22	38/33/28/25	38/32/25/22	38/33/28/25
Sound Power	H	dBA	56	56	56	56
Heat Insulation			Both Liquid and Gas Pipes		Both Liquid and Gas Pipes	
Piping Connection	Liquid	mm	φ 6.4		φ 6.4	
	Gas	mm	φ 9.5		φ 9.5	
	Drain	mm	φ18.0		φ18.0	
Drawing No.			3D051101		3D051102	

Model			FTXG35EV1BW		FTXG35EV1BS	
			Cooling	Heating	Cooling	Heating
Rated Capacity			3.5kW Class		5.0kW Class	
Front Panel Color			Mat Crystal White		Mat Crystal Silver	
Airflow Rates	m <sup>3</sup> /min (cfm)	H	8.1 (285)	9.6 (338)	8.1 (285)	9.6 (338)
		M	6.5 (229)	8.2 (289)	6.5 (229)	8.2 (289)
		L	4.9 (173)	6.7 (236)	4.9 (173)	6.7 (236)
		SL	4.1 (144)	5.9 (208)	4.1 (144)	5.9 (208)
Fan	Type	Cross Flow Fan		Cross Flow Fan		
	Motor Output	W	40	40	40	
	Speed	Steps	5 Steps, Quiet, Auto	5 Steps, Quiet, Auto	5 Steps, Quiet, Auto	
Air Direction Control			Right, Left, Horizontal, Downward		Right, Left, Horizontal, Downward	
Air Filter			Removable-Washable-Mildew Proof		Removable-Washable-Mildew Proof	
Running Current (Rated)			A	0.15-0.14-0.13	0.15-0.14-0.13	0.15-0.14-0.13
Power Consumption (Rated)			W	30-30-30	30-30-30	30-30-30
Power Factor			%	90.9-93.2-96.2	90.9-93.2-96.2	90.9-93.2-96.2
Temperature Control			Microcomputer Control		Microcomputer Control	
Dimensions (HxWxD)			mm	275x840x150	275x840x150	275x840x150
Packaged Dimensions (HxWxD)			mm	222x894x345	222x894x345	222x894x345
Weight			kg	9	9	9
Gross Weight			kg	13	13	13
Operation Sound	H/M/L/SL	dBA	39/33/26/23	39/34/29/26	39/33/26/23	39/34/29/26
Sound Power	H	dBA	57	57	57	57
Heat Insulation			Both Liquid and Gas Pipes		Both Liquid and Gas Pipes	
Piping Connection	Liquid	mm	φ 6.4		φ 6.4	
	Gas	mm	φ 9.5		φ12.7	
	Drain	mm	φ18.0		φ18.0	
Drawing No.			3D051103		3D051104	

## Conversion Formulae

kcal/h=kW×860  
 Btu/h=kW×3414  
 cfm=m<sup>3</sup>/min×35.3



50Hz 230V

Model			CTXG50EV1BW		CTXG50EV1BS	
			Cooling	Heating	Cooling	Heating
Rated Capacity			5.0kW Class		5.0kW Class	
Front Panel Color			Mat Crystal White		Mat Crystal Silver	
Airflow Rates	m <sup>3</sup> /min (cfm)	H	11.3 (398)	12.6 (444)	11.3 (398)	12.6 (444)
		M	9.1 (320)	10.6 (373)	9.1 (320)	10.6 (373)
		L	7.1 (250)	8.7 (306)	7.1 (250)	8.7 (306)
		SL	6.7 (236)	7.7 (271)	6.7 (236)	7.7 (271)
Fan	Type	Cross Flow Fan		Cross Flow Fan		
	Motor Output	W	40		40	
	Speed	Steps	5 Steps, Quiet, Auto		5 Steps, Quiet, Auto	
Air Direction Control			Right, Left, Horizontal, Downward		Right, Left, Horizontal, Downward	
Air Filter			Removable-Washable-Mildew Proof		Removable-Washable-Mildew Proof	
Running Current (Rated)		A	0.15-0.14-0.13	0.15-0.14-0.13	0.15-0.14-0.13	0.15-0.14-0.13
Power Consumption (Rated)		W	30	30	30	30
Power Factor		%	90.9-93.2-96.2	90.9-93.2-96.2	90.9-93.2-96.2	90.9-93.2-96.2
Temperature Control			Microcomputer Control		Microcomputer Control	
Dimensions (HxWxD)		mm	275x840x150		275x840x150	
Packaged Dimensions (HxWxD)		mm	222x894x345		222x894x345	
Weight		kg	9		9	
Gross Weight		kg	13		13	
Operation Sound	H/M/L/SL	dBA	47/41/35/32	47/41/35/32	47/41/35/32	47/41/35/32
Sound Power	H	dBA	64	64	64	64
Heat Insulation			Both Liquid and Gas Pipes		Both Liquid and Gas Pipes	
Piping Connection	Liquid	mm	φ 6.4		φ 6.4	
	Gas	mm	φ 12.7		φ 12.7	
	Drain	mm	φ18.0		φ18.0	
Drawing No.			3D051105		3D051106	

Model			FTXS20G2V1B		FTXS25G2V1B	
			Cooling	Heating	Cooling	Heating
Rated Capacity			2.0kW Class		2.5kW Class	
Front Panel Color			White		White	
Airflow Rates	m <sup>3</sup> /min (cfm)	H	9.4 (332)	9.9 (350)	9.1 (321)	9.8 (346)
		M	7.4 (262)	8.2 (290)	7.1 (252)	7.9 (280)
		L	5.5 (193)	6.5 (228)	5.2 (182)	6.2 (217)
		SL	4.0 (141)	5.5 (193)	3.7 (130)	5.2 (183)
Fan	Type	Cross Flow Fan		Cross Flow Fan		
	Motor Output	W	23		23	
	Speed	Steps	5 Steps, Quiet, Auto		5 Steps, Quiet, Auto	
Air Direction Control			Right, Left, Horizontal, Downward		Right, Left, Horizontal, Downward	
Air Filter			Removable / Washable / Mildew Proof		Removable / Washable / Mildew Proof	
Running Current (Rated)		A	0.08	0.10	0.08	0.10
Power Consumption (Rated)		W	18	21	18	21
Power Factor		%	97.8	91.3	97.8	91.3
Temperature Control			Microcomputer Control		Microcomputer Control	
Dimensions (HxWxD)		mm	295x800x215		295x800x215	
Packaged Dimensions (HxWxD)		mm	274x870x366		274x870x366	
Weight		kg	9		9	
Gross Weight		kg	13		13	
Operation Sound	H/M/L/SL	dBA	38/32/25/22	38/33/28/25	38/32/25/22	39/34/28/25
Sound Power	H	dBA	54	54	54	55
Heat Insulation			Both Liquid and Gas Pipes		Both Liquid and Gas Pipes	
Piping Connection	Liquid	mm	φ 6.4		φ 6.4	
	Gas	mm	φ 9.5		φ 9.5	
	Drain	mm	φ18.0		φ18.0	
Drawing No.			3D059722		3D059723	

Conversion Formulae
kcal/h=kWx860
Btu/h=kWx3414
cfm=m <sup>3</sup> /minx35.3

50Hz 230V

Model			FTXS35G2V1B		FTXS42G2V1B	
			Cooling	Heating	Cooling	Heating
Rated Capacity			3.5kW Class		4.2kW Class	
Front Panel Color			White			
Airflow Rates	m <sup>3</sup> /min (cfm)	H	10.7 (367)	10.6 (374)	9.1 (321)	11.2 (395)
		M	7.7 (270)	8.5 (302)	7.7 (273)	9.4 (333)
		L	4.8 (170)	6.4 (226)	6.3 (221)	7.7 (271)
		SL	3.5 (125)	5.4 (191)	5.4 (190)	6.8 (240)
Fan	Type	Cross Flow Fan				
	Motor Output	W	23		23	
	Speed	Steps	5 Steps, Quiet, Auto		5 Steps, Quiet, Auto	
Air Direction Control			Right, Left, Horizontal, Downward		Right, Left, Horizontal, Downward	
Air Filter			Removable / Washable / Mildew Proof		Removable / Washable / Mildew Proof	
Running Current (Rated)		A	0.12	0.13	0.11	0.14
Power Consumption (Rated)		W	26	28	24	30
Power Factor		%	94.2	93.6	94.9	93.2
Temperature Control			Microcomputer Control		Microcomputer Control	
Dimensions (HxWxD)		mm	295x800x215		295x800x215	
Packaged Dimensions (HxWxD)		mm	274x870x366		274x870x366	
Weight		kg	10		10	
Gross Weight		kg	13		13	
Operation Sound	H/M/L/SL	dBA	45/34/26/23	42/36/29/26	45/38/33/30	42/38/33/30
Sound Power	H	dBA	58	58	58	58
Heat Insulation			Both Liquid and Gas Pipes		Both Liquid and Gas Pipes	
Piping Connection	Liquid	mm	φ 6.4		φ 6.4	
	Gas	mm	φ 9.5		φ 9.5	
	Drain	mm	φ18.0		φ18.0	
Drawing No.			3D059724		3D059725	

Model			FTXS50G2V1B	
			Cooling	Heating
Rated Capacity			5.0kW Class	
Front Panel Color			White	
Airflow Rates	m <sup>3</sup> /min (cfm)	H	10.2 (360)	11.0 (388)
		M	8.6 (305)	9.3 (330)
		L	7.0 (246)	7.6 (267)
		SL	6.0 (212)	6.7 (236)
Fan	Type	Cross Flow Fan		
	Motor Output	W	23	
	Speed	Steps	5 Steps, Quiet, Auto	
Air Direction Control			Right, Left, Horizontal, Downward	
Air Filter			Removable / Washable / Mildew Proof	
Running Current (Rated)		A	0.12	0.14
Power Consumption (Rated)		W	26	32
Power Factor		%	94.2	99.4
Temperature Control			Microcomputer Control	
Dimensions (HxWxD)		mm	295x800x215	
Packaged Dimensions (HxWxD)		mm	274x870x366	
Weight		kg	9	
Gross Weight		kg	12	
Operation Sound	H/M/L/SL	dBA	43/39/34/31	44/39/34/31
Sound Power	H	dBA	59	60
Heat Insulation			Both Liquid and Gas Pipes	
Piping Connection	Liquid	mm	φ 6.4	
	Gas	mm	φ 9.5	
	Drain	mm	φ18.0	
Drawing No.			3D059726	

Conversion Formulae
kcal/h=kWx860
Btu/h=kWx3414
cfm=m <sup>3</sup> /minx35.3

50Hz 230V

Model			FTXS60FV1B		FTXS71FV1B	
			Cooling	Heating	Cooling	Heating
Rated Capacity			6.0kW Class		7.1kW Class	
Front Panel Color			White		White	
Airflow Rates	m <sup>3</sup> /min (cfm)	H	16.2 (572)	17.4 (614)	17.4 (614)	19.7 (696)
		M	13.6 (480)	15.1 (533)	14.6 (516)	16.9 (597)
		L	11.4 (403)	12.7 (448)	11.6 (410)	14.3 (505)
		SL	10.2 (360)	11.4 (403)	10.6 (374)	12.7 (448)
Fan	Type	Cross Flow Fan		Cross Flow Fan		
	Motor Output	W	43		43	
	Speed	Steps	5 Steps, Quiet, Auto		5 Steps, Quiet, Auto	
Air Direction Control			Right, Left, Horizontal, Downward		Right, Left, Horizontal, Downward	
Air Filter			Removable-Washable-Mildew Proof		Removable-Washable-Mildew Proof	
Running Current (Rated)		A	0.18	0.20	0.20	0.27
Power Consumption (Rated)		W	40	45	45	60
Power Factor		%	96.6	97.8	97.8	96.6
Temperature Control			Microcomputer Control		Microcomputer Control	
Dimensions (HxWxD)		mm	290x1,050x238		290x1,050x238	
Packaged Dimensions (HxWxD)		mm	337x1,147x366		337x1,147x366	
Weight		kg	12		12	
Gross Weight		kg	17		17	
Operation Sound	H/M/L/SL	dBA	45/41/36/33	44/40/35/32	46/42/37/34	46/42/37/34
Sound Power	H	dBA	61	60	62	62
Heat Insulation			Both Liquid and Gas Pipes		Both Liquid and Gas Pipes	
Piping Connection	Liquid	mm	φ 6.4		φ 6.4	
	Gas	mm	φ12.7		φ15.9	
	Drain	mm	φ18.0		φ18.0	
Drawing No.			3D056020		3D056021A	

Conversion Formulae
kcal/h=kWx860
Btu/h=kWx3414
cfm=m <sup>3</sup> /minx35.3

## Duct Connected Type

50Hz 230V

Model			FDXS50CVMB				FDXS60CVMB			
			Cooling		Heating		Cooling		Heating	
Rated Capacity			5.0kW Class				6.0kW Class			
Front Panel Color			—				—			
Airflow Rates	m <sup>3</sup> /min (cfm)	H	12.0 (424)	12.0 (424)	16.0 (565)	16.0 (565)				
		M	11.0 (388)	11.0 (388)	14.8 (523)	14.8 (523)				
		L	10.0 (353)	10.0 (353)	13.5 (477)	13.5 (477)				
		SL	8.4 (297)	8.4 (297)	11.2 (395)	11.2 (395)				
Fan	Type	Sirocco Fan				Sirocco Fan				
	Motor Output	W 130				130				
	Speed	Steps 5 Steps, Quiet, Auto				5 Steps, Quiet, Auto				
Air Filter			Removable-Washable-Mildew Proof				Removable-Washable-Mildew Proof			
Running Current (Rated)		A	0.64	0.64	0.74	0.74				
Power Consumption (Rated)		W	140	140	160	160				
Power Factor		%	95.1	95.1	94.0	94.0				
Temperature Control			Microcomputer Control				Microcomputer Control			
Dimensions (HxWxD)		mm	200x900x620				200x1,100x620			
Packaged Dimensions (HxWxD)		mm	266x1,106x751				266x1,306x751			
Weight		kg	27				30			
Gross Weight		kg	34				37			
Operation Sound	H/M/L/SL	dBA	37/35/33/31	37/35/33/31	38/36/34/32	38/36/34/32				
External Static Pressure		Pa	40				40			
Heat Insulation			Both Liquid and Gas Pipes				Both Liquid and Gas Pipes			
Piping Connection	Liquid	mm	φ 6.4				φ 6.4			
	Gas	mm	φ 12.7				φ 12.7			
	Drain	mm	VP20 (O.D. φ 26 / I.D. φ 20)				VP20 (O.D. φ 26 / I.D. φ 20)			
Drawing No.			3D052132				3D052133			

Model			FDXS25EAVMB				FDXS35EAVMB			
			Cooling		Heating		Cooling		Heating	
Rated Capacity			2.5kW Class				3.5kW Class			
Front Panel Color			—				—			
Airflow Rates	m <sup>3</sup> /min (cfm)	H	8.7 (307)	8.7 (307)	8.7 (307)	8.7 (307)				
		M	8.0 (282)	8.0 (282)	8.0 (282)	8.0 (282)				
		L	7.3 (258)	7.3 (258)	7.3 (258)	7.3 (258)				
		SL	6.2 (219)	6.2 (219)	6.2 (219)	6.2 (219)				
Fan	Type	Sirocco Fan				Sirocco Fan				
	Motor Output	W 62				62				
	Speed	Steps 5 Steps, Quiet, Auto				5 Steps, Quiet, Auto				
Air Filter			Removable-Washable-Mildew Proof				Removable-Washable-Mildew Proof			
Running Current (Rated)		A	0.48	0.48	0.48	0.48				
Power Consumption (Rated)		W	71	71	71	71				
Power Factor		%	64.3	64.3	64.3	64.3				
Temperature Control			Microcomputer Control				Microcomputer Control			
Dimensions (HxWxD)		mm	200x700x620				200x700x620			
Packaged Dimensions (HxWxD)		mm	274x906x751				274x906x751			
Weight		kg	21				21			
Gross Weight		kg	29				29			
Operation Sound	H/M/L/SL	dBA	35/33/31/29	35/33/31/29	35/33/31/29	35/33/31/29				
External Static Pressure		Pa	30				30			
Heat Insulation			Both Liquid and Gas Pipes				Both Liquid and Gas Pipes			
Piping Connection	Liquid	mm	φ 6.4				φ 6.4			
	Gas	mm	φ 9.5				φ 9.5			
	Drain	mm	VP20 (O.D. φ 26 / I.D. φ 20)				VP20 (O.D. φ 26 / I.D. φ 20)			
Drawing No.			3D051881A				3D051883A			

- Note:**
- The operating sound is based on the rear side suction inlet and the external static pressure 30 Pa. Operating sound for under side suction inlet : [operating sound for rear side suction inlet] +6 dB. However, when installation to which the external static pressure becomes low is carried out, 6 dB or more may go up.

Conversion Formulae
kcal/h=kWx860
Btu/h=kWx3414
cfm=m <sup>3</sup> /minx35.3

Floor / Ceiling Suspended Dual Type

50Hz 230V

Model			FLXS25BAVMB		FLXS35BAVMB	
			Cooling	Heating	Cooling	Heating
Rated Capacity			2.5kW Class		3.5kW Class	
Front Panel Color			Almond White		Almond White	
Airflow Rates	m <sup>3</sup> /min (cfm)	H	7.6 (268)	9.2 (325)	8.6 (304)	9.8 (346)
		M	6.8 (240)	8.3 (293)	7.6 (268)	8.9 (314)
		L	6.0 (212)	7.4 (261)	6.6 (233)	8.0 (282)
		SL	5.2 (184)	6.6 (233)	5.6 (198)	7.2 (254)
Fan	Type	Sirocco Fan		Sirocco Fan		
	Motor Output	W	34		34	
	Speed	Steps	5 Steps, Quiet, Auto		5 Steps, Quiet, Auto	
Air Direction Control			Right, Left, Horizontal, Downward		Right, Left, Horizontal, Downward	
Air Filter			Removable-Washable-Mildew Proof		Removable-Washable-Mildew Proof	
Running Current (Rated)	A	0.32	0.34	0.36	0.36	
Power Consumption (Rated)	W	70	74	78	78	
Power Factor	%	95.1	94.6	94.2	94.2	
Temperature Control			Microcomputer Control		Microcomputer Control	
Dimensions (HxWxD)	mm	490x1,050x200		490x1,050x200		
Packaged Dimensions (HxWxD)	mm	566x1,100x280		566x1,100x280		
Weight	kg	16		16		
Gross Weight	kg	22		22		
Operation Sound	H/M/L/SL	dBA	37/34/31/28	37/34/31/29	38/35/32/29	39/36/33/30
Sound Power	H	dBA	53	—	54	—
Heat Insulation			Both Liquid and Gas Pipes		Both Liquid and Gas Pipes	
Piping Connection	Liquid	mm	φ 6.4		φ 6.4	
	Gas	mm	φ 9.5		φ 9.5	
	Drain	mm	φ18.0		φ18.0	
Drawing No.			3D050866		3D050868	

Model			FLXS50BAVMB		FLXS60BAVMB	
			Cooling	Heating	Cooling	Heating
Rated Capacity			5.0kW Class		6.0kW Class	
Front Panel Color			Almond White		Almond White	
Airflow Rates	m <sup>3</sup> /min (cfm)	H	11.4 (402)	12.1 (427)	12.0 (424)	12.8 (452)
		M	10.0 (353)	9.8 (346)	10.7 (378)	10.6 (374)
		L	8.5 (300)	7.5 (265)	9.3 (328)	8.4 (297)
		SL	7.5 (265)	6.8 (240)	8.3 (293)	7.5 (265)
Fan	Type	Sirocco Fan		Sirocco Fan		
	Motor Output	W	34		34	
	Speed	Steps	5 Steps, Quiet, Auto		5 Steps, Quiet, Auto	
Air Direction Control			Right, Left, Horizontal, Downward		Right, Left, Horizontal, Downward	
Air Filter			Removable-Washable-Mildew Proof		Removable-Washable-Mildew Proof	
Running Current (Rated)	A	0.45	0.45	0.47	0.45	
Power Consumption (Rated)	W	96	96	98	96	
Power Factor	%	92.8	92.8	90.7	92.8	
Temperature Control			Microcomputer Control		Microcomputer Control	
Dimensions (HxWxD)	mm	490x1,050x200		490x1,050x200		
Packaged Dimensions (HxWxD)	mm	280x1,100x566		280x1,100x566		
Weight	kg	17		17		
Gross Weight	kg	24		24		
Operation Sound	H/M/L/SL	dBA	47/43/39/36	46/41/35/33	48/45/41/39	47/42/37/34
Sound Power	H	dBA	63	32	64	63
Heat Insulation			Both Liquid and Gas Pipes		Both Liquid and Gas Pipes	
Piping Connection	Liquid	mm	φ 6.4		φ 6.4	
	Gas	mm	φ12.7		φ12.7	
	Drain	mm	φ18.0		φ18.0	
Drawing No.			3D050897		3D050882	

Conversion Formulae
kcal/h=kWx860
Btu/h=kWx3414
cfm=m <sup>3</sup> /minx35.3

## Floor Standing Type

50Hz 230V

Model			FVXS25FV1B		FVXS35FV1B	
			Cooling	Heating	Cooling	Heating
Rated Capacity			2.5kW Class		3.5kW Class	
Front Panel Color			White			
Airflow Rates	m <sup>3</sup> /min (cfm)	H	8.2 (290)	8.8 (311)	8.5 (300)	9.4 (332)
		M	6.5 (229)	6.9 (244)	6.7 (237)	7.3 (258)
		L	4.8 (169)	5.0 (178)	4.9 (174)	5.2 (184)
		SL	4.1 (146)	4.4 (155)	4.5 (158)	4.7 (168)
Fan	Type	Turbo Fan				
	Motor Output	W	48			
	Speed	Steps	5 Steps, Quiet, Auto			
Air Direction Control			Right, Left, Horizontal, Downward		Right, Left, Horizontal, Downward	
Air Filter			Removable-Washable-Mildew Proof			
Running Current (Rated)		A	0.13	0.14	0.13	0.14
Power Consumption (Rated)		W	15	17	15	17
Power Factor		%	50.2	52.8	50.2	52.8
Temperature Control			Microcomputer Control			
Dimensions (HxWxD)		mm	600x700x210		600x700x210	
Packaged Dimensions (HxWxD)		mm	696x786x286		696x786x286	
Weight		kg	14			
Gross Weight		kg	18			
Operation Sound	H/M/L/SL	dBA	38/32/26/23	38/32/26/23	39/33/27/24	39/33/27/24
Sound Power	H	dBA	54	54	55	55
Heat Insulation			Both Liquid and Gas Pipes			
Piping Connection	Liquid	mm	φ 6.4		φ 6.4	
	Gas	mm	φ 9.5		φ 9.5	
	Drain	mm	φ 20.0		φ 20.0	
Drawing No.			3D056274A		3D056275A	

Model			FVXS50FV1B		
			Cooling	Heating	
Rated Capacity			5.0kW Class		
Front Panel Color			White		
Airflow Rates	m <sup>3</sup> /min (cfm)	H	10.7 (378)	11.8 (417)	
		M	9.2 (326)	10.1 (358)	
		L	7.8 (274)	8.5 (300)	
		SL	6.6 (233)	7.1 (250)	
Fan	Type	Turbo Fan			
	Motor Output	W	48		
	Speed	Steps	5 Steps, Quiet, Auto		
Air Direction Control			Right, Left, Horizontal, Downward		
Air Filter			Removable-Washable-Mildew Proof		
Running Current (Rated)		A	0.17	0.19	
Power Consumption (Rated)		W	27	34	
Power Factor		%	69.1	77.8	
Temperature Control			Microcomputer Control		
Dimensions (HxWxD)		mm	600x700x210		
Packaged Dimensions (HxWxD)		mm	696x786x286		
Weight		kg	14		
Gross Weight		kg	18		
Operation Sound	H/M/L/SL	dBA	44/40/36/32	45/40/36/32	
Sound Power	H	dBA	56	57	
Heat Insulation			Both Liquid and Gas Pipes		
Piping Connection	Liquid	mm	φ 6.4		
	Gas	mm	φ 12.7		
	Drain	mm	φ 20.0		
Drawing No.			3D056276		

## Conversion Formulae

kcal/h=kW×860  
 Btu/h=kW×3414  
 cfm=m<sup>3</sup>/min×35.3

Ceiling-suspended Type

50Hz 230V

Model			FHQ35BVV1B		FHQ50BVV1B		FHQ60BVV1B	
			Cooling	Heating	Cooling	Heating	Cooling	Heating
Rated Capacity			3.5kW Class		5.0kW Class		6.0kW Class	
Decoration Panel	Color	White						
	Dimensions (HxWxD)	—						
Airflow Rates	m <sup>3</sup> /min (cfm)	H	13.0 (458)	13.0 (458)	13.0 (458)	13.0 (458)	17.0 (600)	16.0 (565)
		M	—		—		—	
		L	10.0 (353)	10.0 (353)	10.0 (353)	10.0 (353)	13.0 (459)	13.0 (459)
		SL	—		—		—	
Fan	Type	Sirocco Fan						
	Motor Output	W	62		62		62	
	Speed	Steps	2 Steps		2 Steps		2 Steps	
Air Direction Control			Right, Left, Horizontal, Downward		Right, Left, Horizontal, Downward		Right, Left, Horizontal, Downward	
Air Filter			Removable-Washable-Mildew Proof		Removable-Washable-Mildew Proof		Removable-Washable-Mildew Proof	
Temperature Control			Microcomputer Control		Microcomputer Control		Microcomputer Control	
Dimensions (HxWxD)		mm	195x960x680		195x960x680		195x1,160x680	
Packaged Dimensions (HxWxD)		mm	279x1,046x818		279x1,046x818		279x1,246x818	
Weight		kg	24		25		27	
Gross Weight		kg	31		32		35	
Operation Sound	H/L	dBA	37/32		38/33		39/33	
Sound Power	H/L	dBA	53/48		54/49		55/49	
Heat Insulation			Both Liquid and Gas Pipes		Both Liquid and Gas Pipes		Both Liquid and Gas Pipes	
Piping Connection	Liquid	mm	φ 6.4 (Flare)		φ 6.4 (Flare)		φ 6.4 (Flare)	
	Gas	mm	φ 9.5 (Flare)		φ 12.7 (Flare)		φ 12.7 (Flare)	
	Drain	mm	VP20 (O.D.φ 26 / I.D.φ 20)		VP20 (O.D.φ 26 / I.D.φ 20)		VP20 (O.D.φ 26 / I.D.φ 20)	
Drawing No.			3D037992E		3D037992E		3D037992E	

Conversion Formulae
kcal/h=kWx860
Btu/h=kWx3414
cfm=m <sup>3</sup> /minx35.3

# 1.4 Outdoor Units - Heat Pump

50Hz 230V

Model		3MXS68G2V1B		4MXS68F2V1B		
		Cooling	Heating	Cooling	Heating	
Cooling Capacity	kW	—		—		
Power Consumption	W	—		—		
Running Current	A	—		—		
Casing Color		Ivory White		Ivory White		
Compressor	Type	Hermetically Sealed Swing Type		Hermetically Sealed Swing Type		
	Model	2YC45DXD		2YC45DXD		
Refrigerant Oil	Motor Output	W	1,380	1,380		
	Model		FVC50K	FVC50K		
Refrigerant	Charge	L	0.65	0.65		
	Type		R-410A	R-410A		
Airflow Rates	m <sup>3</sup> /min	H	52.7	46.4	52.7	46.4
		M	49.4	44.5	49.4	44.5
		L	43.5	16.3	43.5	16.3
	cfm	H	1,861	1,638	1,861	1,638
		M	1,744	1,571	1,744	1,571
		L	1,536	576	1,536	576
Fan	Type	Propeller		Propeller		
	Motor Output	W	53	53		
	Running Current	A	H: 0.20 / M: 0.16 / L: 0.10	H: 0.16 / M: 0.14 / L: 0.03	H: 0.20 / M: 0.16 / L: 0.10	H: 0.16 / M: 0.14 / L: 0.03
	Power Consumption	W	H: 70 / M: 58 / L: 36	H: 55 / M: 48 / L: 10	H: 70 / M: 58 / L: 36	H: 55 / M: 48 / L: 10
Starting Current	A	6.2		6.2		
Dimensions (HxWxD)	mm	735x936x300		735x936x300		
Packaged Dimensions (HxWxD)	mm	797x992x390		797x992x390		
Weight	kg	58		58		
Gross Weight	kg	63		63		
Operation Sound	dBA	48	49	48	49	
Sound Power	dBA	61	—	61	—	
Piping Connection	Liquid	mm	φ 6.4x3		φ 6.4x4	
	Gas	mm	φ9.5x1, φ12.7x2		φ9.5x2, φ12.7x2	
	Drain	mm	φ 18.0		φ18.0	
Heat Insulation		Both Liquid and Gas Pipes		Both Liquid and Gas Pipes		
No. of Wiring Connection		3 for Power Supply, 4 for Interunit Wiring		3 for Power Supply, 4 for Interunit Wiring		
Max. Interunit Piping Length	m	60 (for Total of Each Room)		60 (for Total of Each Room)		
	m	25 (for One Room)		25 (for One Room)		
Amount of Additional Charge	g/m	20 (30m or more)		20 (30m or more)		
Max. Installation Height Difference	m	15 (between Indoor Unit and Outdoor Unit)		15 (between Indoor Unit and Outdoor Unit)		
	m	7.5 (between Indoor Units)		7.5 (between Indoor Units)		
Drawing No.		3D058720		3D056404		

**Note:** 1. The data are based on the conditions shown in the table below.

Cooling	Heating	Piping Length
Indoor : 27°CDB/19°CWB Outdoor : 35°CDB	Indoor : 20°CDB Outdoor : 7°CDB/6°CWB	5m

Conversion Formulae
kcal/h=kWx860 Btu/h=kWx3414 cfm=m <sup>3</sup> /minx35.3





# Part 3

# Printed Circuit Board

# Connector Wiring Diagram

1. Printed Circuit Board Connector Wiring Diagram.....	32
1.1 Wall Mounted Type .....	32
1.2 Duct Connected Type.....	38
1.3 Floor / Ceiling Suspended Dual Type.....	40
1.4 Floor Standing Type .....	43
1.5 Ceiling Suspended Type .....	45
1.6 Outdoor Units .....	47

# 1. Printed Circuit Board Connector Wiring Diagram

## 1.1 Wall Mounted Type

### 1.1.1 FTXS20~50G

#### Connectors

##### PCB(1) (Control PCB)

- 1) **S1** Connector for DC fan motor
- 2) **S21** Connector for [centralized control \(HA\)](#)
- 3) **S25** Connector for INTELLIGENT EYE sensor PCB
- 4) **S32** Connector for heat exchanger thermistor
- 5) **S41** Connector for swing motor
- 6) **S46** Connector for display PCB
- 7) **S47** Connector for signal receiver PCB

##### PCB(2) (Signal Receiver PCB)

- 1) **S48** Connector for control PCB

##### PCB(3) (Display PCB)

- 1) **S49** Connector for control PCB

##### PCB(4) (INTELLIGENT EYE sensor PCB)

- 1) **S26** Connector for control PCB



#### Note:

Other designations

##### PCB(1) (Control PCB)

- 1) **V1** [Varistor](#)
  - 2) **JA** [Address setting jumper](#)
  - JB** [Fan speed setting](#) when compressor is OFF on thermostat
  - JC** [Power failure recovery function \(auto-restart\)](#)
- \* Refer to page 301 for detail.
- 3) **LED A** LED for service monitor (green)
  - 4) **FU1** [Fuse \(3.15A\)](#)

##### PCB(3) (Display PCB)

- 1) **SW1 (S1W)** [Forced operation ON / OFF switch](#)
- 2) **LED1** LED for operation (green)
- 3) **LED2** LED for timer (yellow)
- 4) **LED3** LED for INTELLIGENT EYE (green)
- 5) **RTH1 (R1T)** Room temperature thermistor

PCB Detail

PCB(1): Control PCB

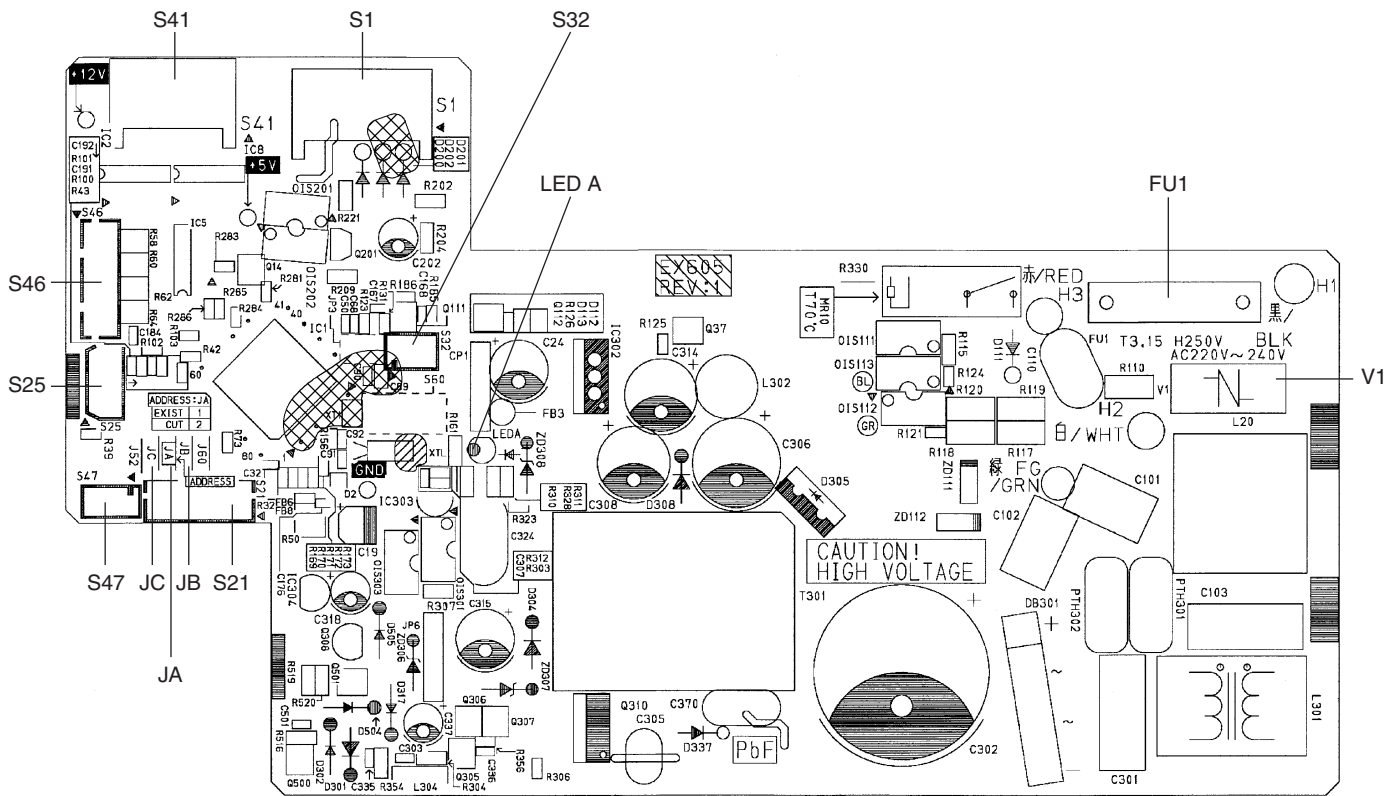

2P206687

PCB(2): Signal Receiver PCB

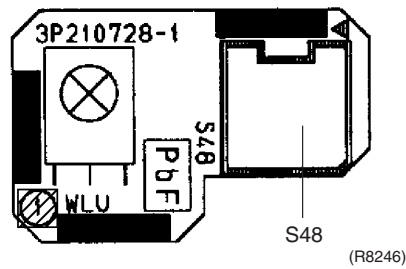

(R8246)

PCB(3): Display PCB

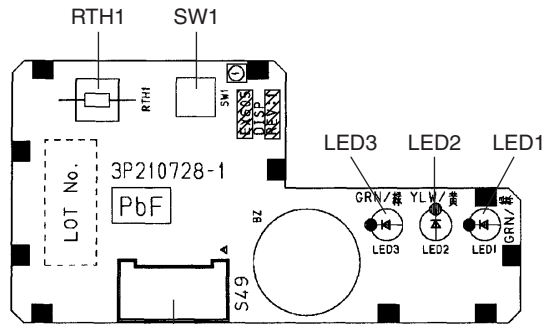

(R8247)

PCB(4): INTELLIGENT EYE sensor PCB

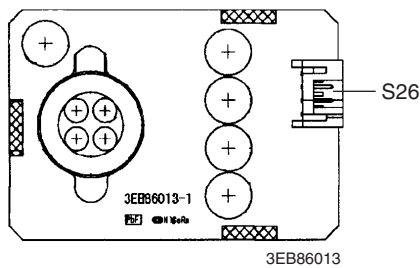

3EB86013

## 1.1.2 FTK(X)S60/71F

### Connectors

#### PCB(1) (Control PCB)

- 1) **S1** Connector for DC fan motor
- 2) **S6** Connector for swing motor (horizontal blades)
- 3) **S8** Connector for swing motor (vertical blades)
- 4) **S21** Connector for [centralized control \(HA\)](#)
- 5) **S26** Connector for buzzer PCB
- 6) **S28** Connector for signal receiver PCB
- 7) **S32** Connector for heat exchanger thermistor
- 8) **S35** Connector for Intelligent Eye sensor PCB

#### PCB(2) (Signal Receiver PCB)

- 1) **S29** Connector for control PCB

#### PCB(3) (Buzzer PCB)

- 1) **S27** Connector for control PCB
- 2) **S38** Connector for display PCB

#### PCB(4) (Display PCB)

- 1) **S37** Connector for buzzer PCB

#### PCB(5) (INTELLIGENT EYE sensor PCB)

- 1) **S36** Connector for control PCB



#### Note:

Other designations

#### PCB(1) (Control PCB)

- 1) **V1** [Varistor](#)
- 2) **JA** [Address setting jumper](#)
- JB** [Fan speed setting](#) when compressor is OFF on thermostat
- JC** [Power failure recovery function](#)
- \* Refer to page 301 for detail.
- 3) **LED A** LED A for service monitor (green)
- 4) **FU1** [Fuse \(3.15A\)](#)

#### PCB(2) (Signal Receiver PCB)

- 1) **SW1 (S1W)** [Forced operation ON/OFF switch](#)

#### PCB(3) (Buzzer PCB)

- 1) **RTH1 (R1T)** Room temperature thermistor

#### PCB(4) (Display PCB)

- 4) **LED1** LED for operation (green)
- 5) **LED2** LED for timer (yellow)
- 6) **LED3** LED for HOME LEAVE operation (red)

PCB Detail

PCB(1): Control PCB (indoor unit)

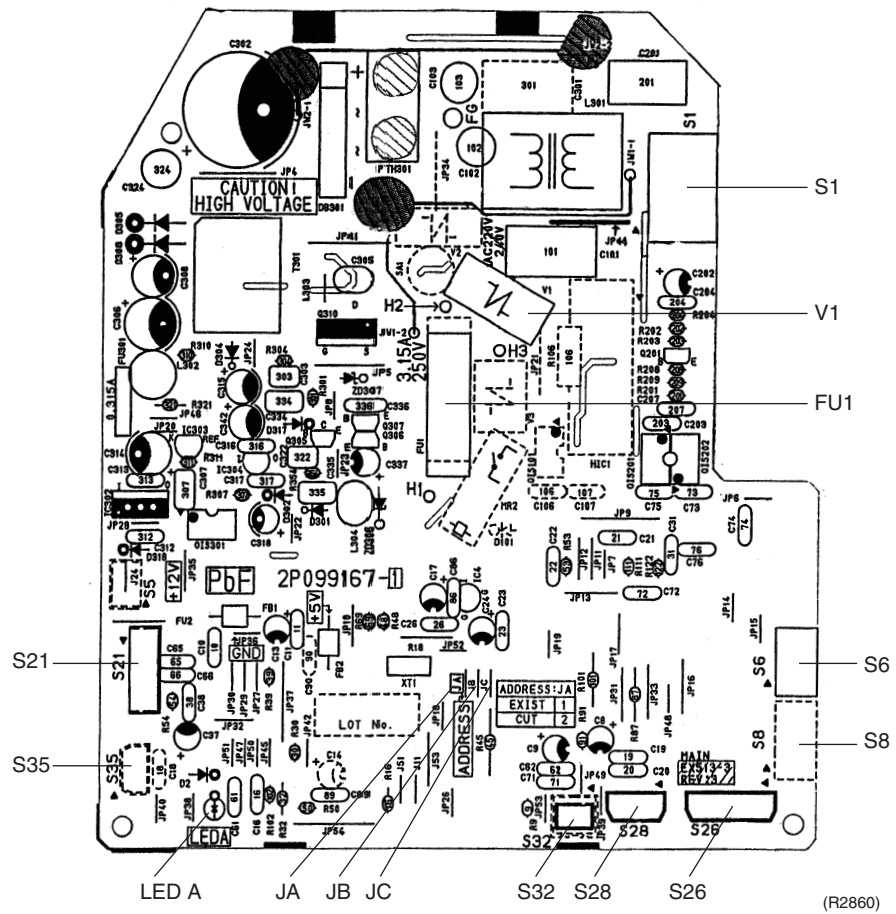

PCB(2): Signal Receiver PCB

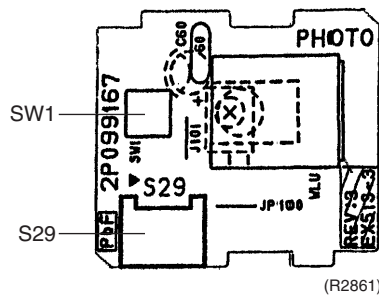

PCB(3): Buzzer PCB

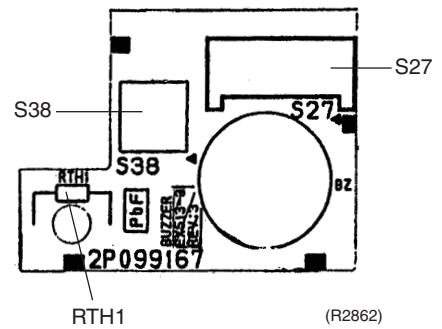

PCB(4): Display PCB

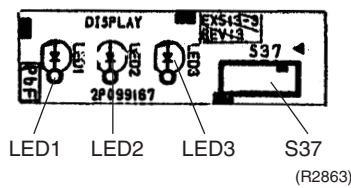

PCB(5): INTELLIGENT EYE sensor PCB

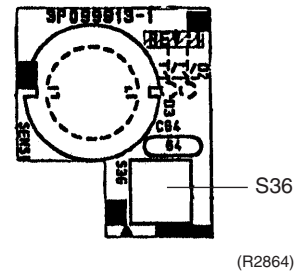

### 1.1.3 FTXG25~35E, CTXG50E

#### Connectors

##### PCB(1) (Control PCB)

- 1) **S1** Connector for fan motor
- 2) **S21** Connector for [centralized control \(HA\)](#)
- 3) **S32** Connector for heat exchanger thermistor
- 4) **S36** Connector for INTELLIGENT EYE sensor PCB and control PCB
- 5) **S41** Connector for swing motor
- 6) **S46** Connector for signal receiver PCB
- 7) **S49** Connector for reduction motor (front panel mechanism)
- 8) **S51** Connector for front panel limit switch

##### PCB(2) (Signal Receiver PCB)

- 1) **S47** Connector for control PCB

##### PCB(3) (INTELLIGENT EYE sensor PCB)

- 1) **S36** Connector for control PCB



**Note:** Other designations

##### PCB(1) (Control PCB)

- 1) **V1** [Varistor](#)
  - 2) **JA** [Address setting jumper](#)
  - JB** [Fan speed setting](#) when compressor is OFF on thermostat
  - JC** [Power failure recovery function \(auto-restart\)](#)
- \* Refer to page 301 for detail.
- 3) **FU1** [Fuse](#) (3.15A)
  - 4) **LED A** LED for service monitor (green)

##### PCB(2) (Signal Receiver PCB)

- 1) **SW1** [Forced operation ON / OFF switch](#)
- 2) **LED2** LED for INTELLIGENT EYE (green)
- 3) **LED3** LED for timer (yellow)
- 4) **LED4** LED for operation (green)
- 5) **RTH1** Room temperature thermistor

PCB Detail

PCB(1): Control PCB (indoor unit)

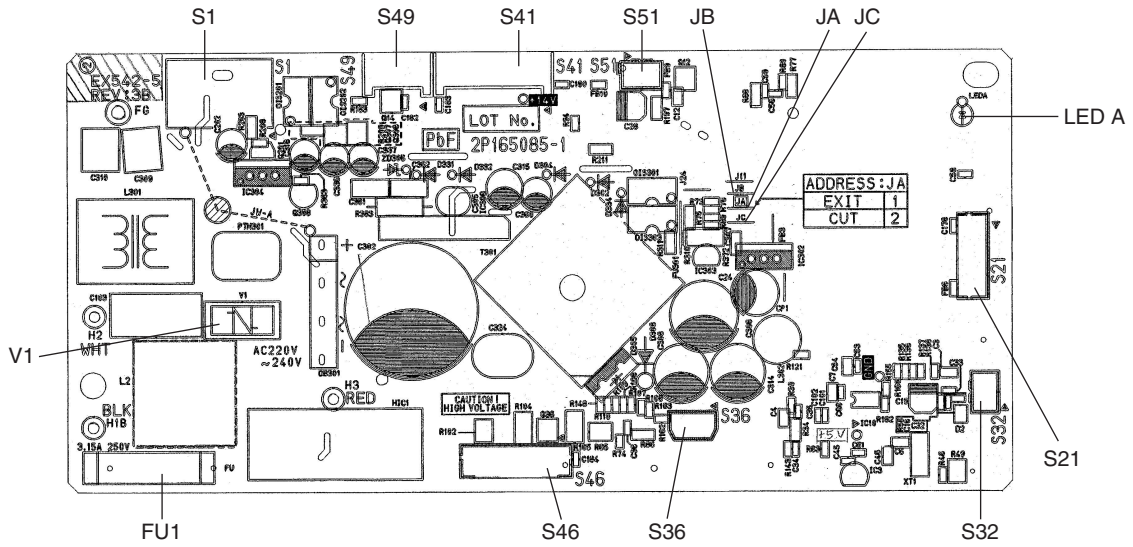

(R4991)

PCB(2): Signal Receiver PCB

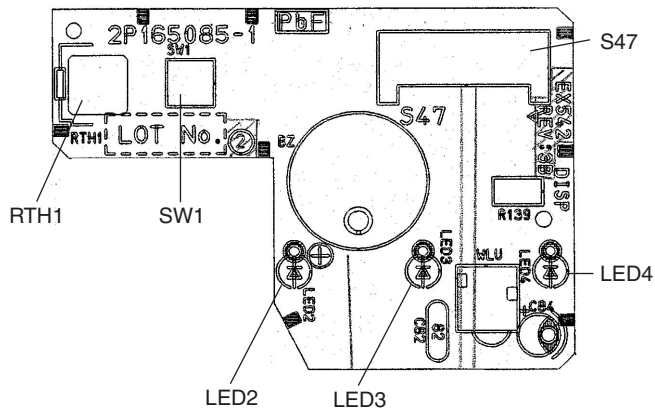

(R4992)

PCB(3): INTELLIGENT EYE sensor PCB

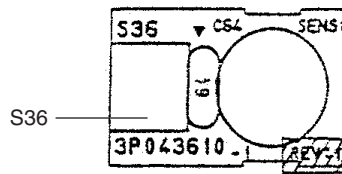

(R4988)



# 1.2 Duct Connected Type

## Connectors

### PCB(1) (Control PCB)

- 1) **S1** Connector for AC fan motor
- 2) **S7** Connector for AC fan motor
- 3) **S21** Connector for centralized control to 5 rooms
- 4) **S26** Connector for display PCB
- 5) **S32** Connector for heat exchanger thermistor

### PCB(2) (Display PCB)

- 1) **S1** Connector for control PCB



**Note:**

Other designations

### PCB(1) (Control PCB)

- 1) **V1** Varistor
- 2) **JA** Address setting jumper
- JB** Fan speed setting when compressor is OFF on thermostat
- JC** Power failure recovery function
- \* Refer to page 301 for more detail.
- 3) **LED A** LED for service monitor (green)
- 4) **FU1** Fuse (3.15A)

### PCB(2) (Display PCB)

- 1) **SW1 (S1W)** Forced operation ON/OFF switch
- 2) **LED1** LED for operation (green)
- 3) **LED2** LED for timer (yellow)
- 4) **LED3** LED for HOME LEAVE operation (red)
- 5) **RTH1 (R1T)** Room temperature thermistor

## PCB Detail

### PCB (1): Control PCB

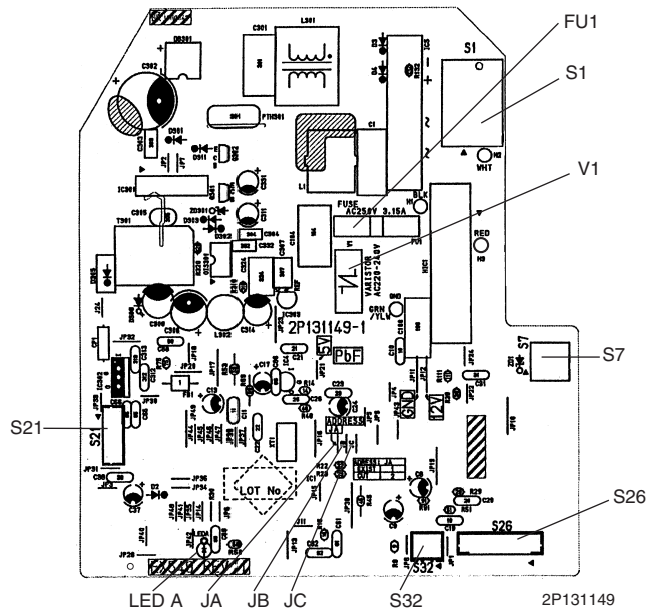

PCB Detail

PCB (2): Display PCB

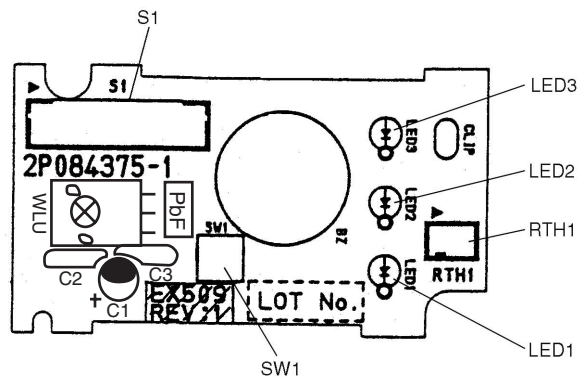

2P084375

## 1.3 Floor / Ceiling Suspended Dual Type

### Connectors

#### PCB(1) (Control PCB)

- 1) [S6](#) Connector for swing motor (horizontal swing)
- 2) [S7](#) Connector for AC fan motor
- 3) [S21](#) Connector for [centralized control](#)
- 4) [S24](#) Connector for display PCB
- 5) [S26](#) Connector for signal receiver PCB
- 6) [S32](#) Connector for heat exchanger thermistor
- 7) [S37](#) Connector for power supply PCB

#### PCB(2) (Power Supply PCB)

- 1) [S36](#) Connector for control PCB

#### PCB(3) (Display PCB)

- 1) [S25](#) Connector for control PCB

#### PCB(4) (Signal Receiver PCB)

- 1) [S27](#) Connector for control PCB
- 2) [S31](#) Connector for room temperature thermistor



#### Note:

Other designations

#### PCB(1) (Control PCB)

- 1) [JA](#) [Address setting jumper](#)
- [JB](#) [Fan speed setting](#) when compressor is OFF on thermostat
- [JC](#) [Power failure recovery function](#)  
\* Refer to page 301 for detail.
- 2) [SW2](#) Select switch ceiling or floor
- 3) [LED A](#) LED for service monitor (green)

#### PCB(2) (Power Supply PCB)

- 1) [V1](#) [Varistor](#)
- 1) [FU1](#) [Fuse \(3.15A\)](#)

#### PCB(3) (Display PCB)

- 1) [LED1](#) LED for operation (green)
- 2) [LED2](#) LED for timer (yellow)
- 3) [LED3](#) LED for HOME LEAVE operation (red)

#### PCB(4) (Signal Receiver PCB)

- 1) [SW1 \(S1W\)](#) [Forced operation ON/OFF switch](#)

PCB Detail

PCB (1): Control PCB

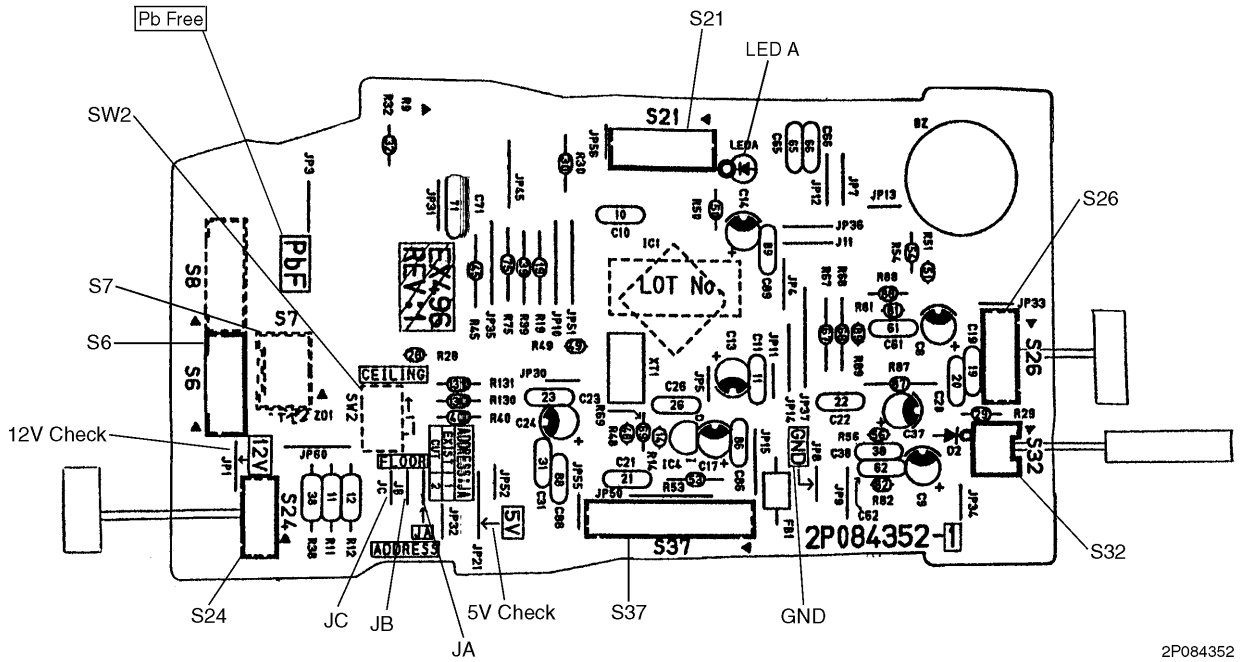

2P084352

PCB Detail

PCB (2): Power Supply PCB

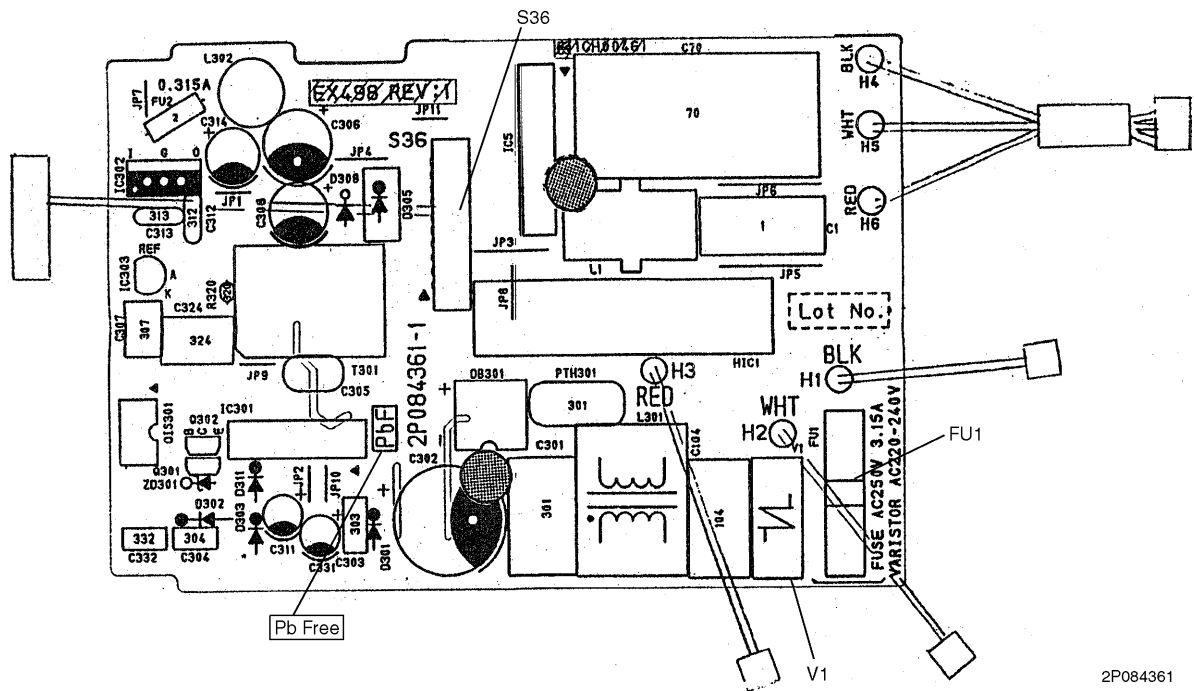

2P084361

PCB (3): Display PCB

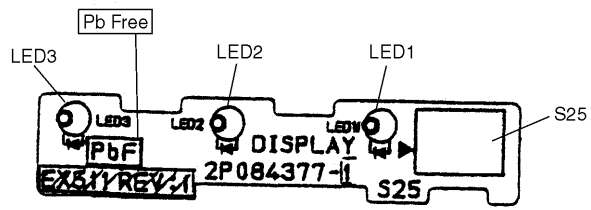

2P084377

PCB (4): Signal Receiver PCB

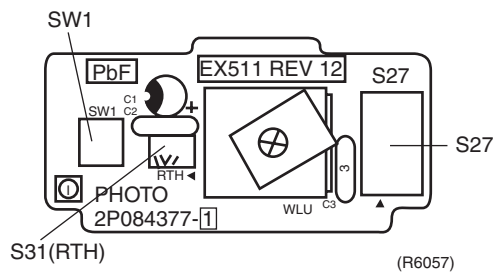

(R6057)

## 1.4 Floor Standing Type

### Connectors

#### PCB(1) (Sensor PCB)

- 1) **S49** Connector for control PCB

#### PCB(2) (Control PCB)

- 1) **S1** Connector for fan motor  
 2) **S21** Connector for centralized control  
 3) **S26** Connector for service PCB  
 4) **S41** Connector for lower air outlet motor  
 5) **S42** Connector for swing motor  
 6) **S46** Connector for display PCB  
 7) **S48** Connector for sensor PCB

#### PCB(3) (Service PCB)

- 1) **S27** Connector for control PCB

#### PCB(4) (Display PCB)

- 1) **S47** Connector for control PCB



#### Note:

Other Designations

#### PCB(2) (Control PCB)

- 1) **V1** Varistor  
 2) **JA** Address setting jumper  
**JB** Fan speed setting when compressor is OFF on thermostat  
**JC** Power failure recovery function  
 \* Refer to page 301 for detail.  
 3) **FU1** Fuse (3.15A)  
 4) **LED A** LED for service monitor (green)

#### PCB(3) (Service PCB)

- 1) **SW2** Changing upward airflow limit switch  
 2) **SW4** Discharge changeover switch

#### PCB(4) (Display PCB)

- 1) **SW1** (S1W) Forced operation ON/OFF switch  
 2) **LED1** LED for operation (green)  
 3) **LED2** LED for timer (yellow)

PCB Detail

PCB(1): Sensor PCB

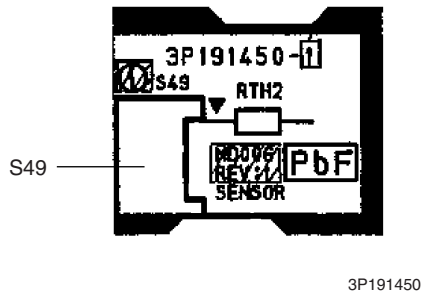

PCB(2): Control PCB

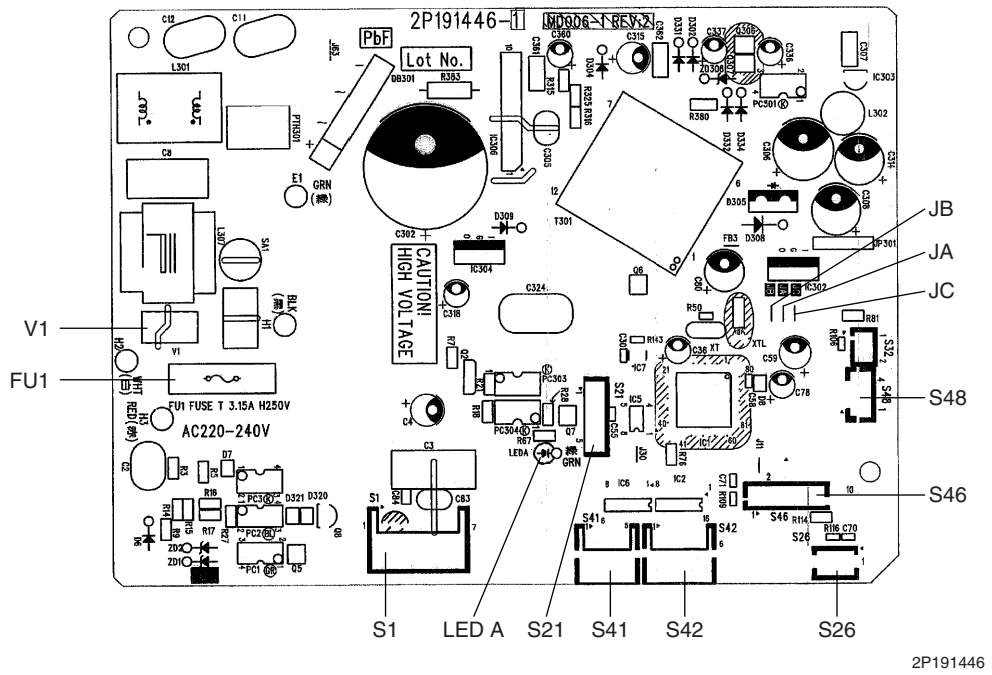

PCB(3): Service PCB

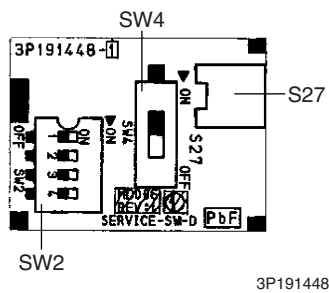

PCB(3): Display PCB

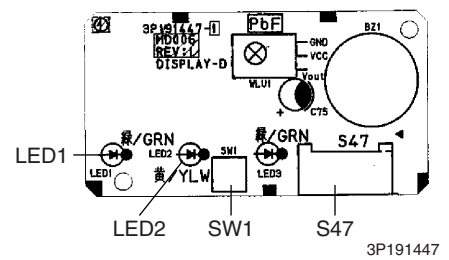

## 1.5 Ceiling Suspended Type

---

### Connectors

- |                |  |
|----------------|--|
| 1) X5A         | Connector for Terminal Strip (for Wired Remote Controller)       |
| 2) X14A        | Connector for Limit Switch (for Swing Flap)                      |
| 3) X15A        | Connector for Drain Pump (Optional Accessory)                    |
| 4) X17A        | Connector for Heat Exchanger Thermistor (2)                      |
| 5) X18A        | Connector for Heat Exchanger Thermistor (1)                      |
| 6) X19A        | Connector for Room Temperature Thermistor                        |
| 7) X20A, X26A  | Connector for Fan Motor  |
| 8) X24A        | Connector for Wireless Remote Controller Receiver Unit           |
| 9) X25A        | Connector for Drain Pump Motor (Optional Accessory)              |
| 10) X27A       | Connector for Terminal Strip (for Inter Unit Wiring)             |
| 11) X29A       | Connector for Swing Motor  |
| 12) X33A       | Connector for Wiring Adaptor PCB (Optional Accessory)            |
| 13) X35A       | Connector for Group Control Adaptor (Optional Accessory)         |
| 14) X40A       | Connector for ON/OFF Input from Outside (for Optional Accessory) |
| 15) X60A, X61A | Connector for Interface Adaptor (Optional Accessory)             |



**Note:** Other Designation

- |        |                     |
|--------|---------------------|
| 1) HAP | Service Monitor LED |
|--------|---------------------|



PCB Detail

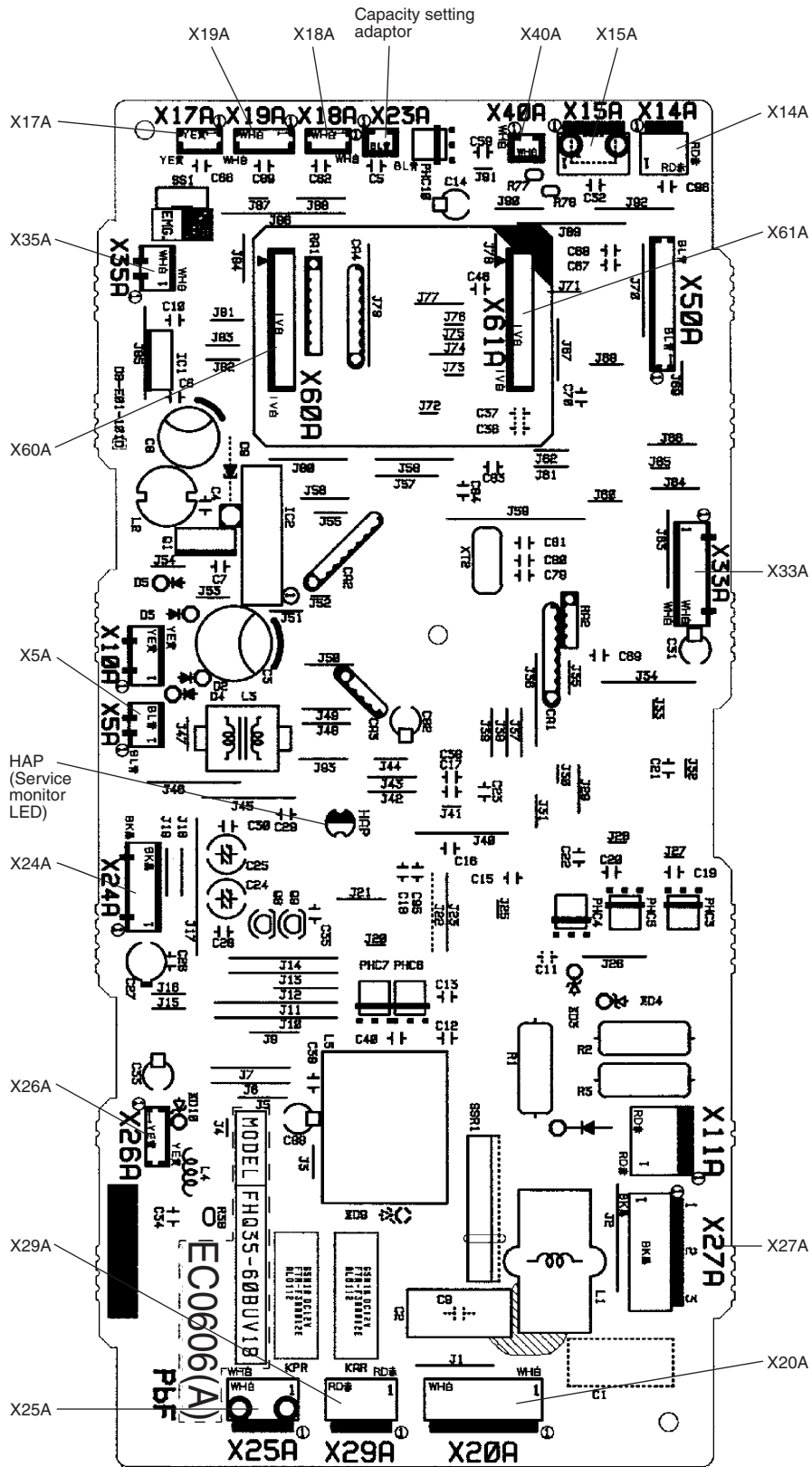

2P095007

## 1.6 Outdoor Units

### Connectors

#### PCB(1)(Main PCB)

- |              |  |
|--------------|--|
| 1) S10       | Connector for terminal strip (indoor-outdoor transmission)                     |
| 2) S15       | Connector for COOL / HEAT mode lock  |
| 3) S20       | Connector for electronic expansion valve coil A port (white)                   |
| 4) S21       | Connector for electronic expansion valve coil B port (red)                     |
| 5) S22       | Connector for electronic expansion valve coil C port (blue)                    |
| 6) S23       | Connector for electronic expansion valve coil D port (yellow)                  |
| 7) S40       | Connector for overload protector   |
| 8) S51, S101 | Connector for service monitor PCB  |
| 9) S70       | Connector for fan motor  |
| 10) S80      | Connector for four way valve coil  |
| 11) S90      | Connector for thermistors<br>(outdoor air, heat exchanger, and discharge pipe) |
| 12) S92      | Connector for gas pipe thermistor  |
| 13) S93      | Connector for liquid pipe thermistor   |
| 14) AC1, AC2 | Connector for terminal strip (power supply)                                    |
| 15) HR1, HR2 | Connector for reactor  |

#### PCB(2)(Service Monitor PCB)

- |              |                           |
|--------------|---------------------------|
| 1) S52, S102 | Connector for control PCB |
|--------------|---------------------------|



#### Note:

Other Designations

#### PCB(1)(Main PCB)

- |                           |              |
|---------------------------|--------------|
| 1) FU1                    | Fuse (30A)   |
| 2) FU2, FU3               | Fuse (3.15A) |
| 3) V2, V3, V5<br>V9, V100 | Varistor     |

#### PCB(2)(Service Monitor PCB)

- |                |                                 |
|----------------|---------------------------------|
| 1) LED A       | Service monitor LED (green)     |
| 2) LED1 - LED4 | Service monitor LED (red)       |
| 3) SW1         | Forced operation ON/OFF switch  |
| 4) SW2         | Operation mode switch           |
| 5) SW3         | Wiring error check switch       |
| 6) SW4         | Priority room setting switch    |
| 7) SW5         | Night quiet mode setting switch |

PCB Detail

PCB(1): Main PCB

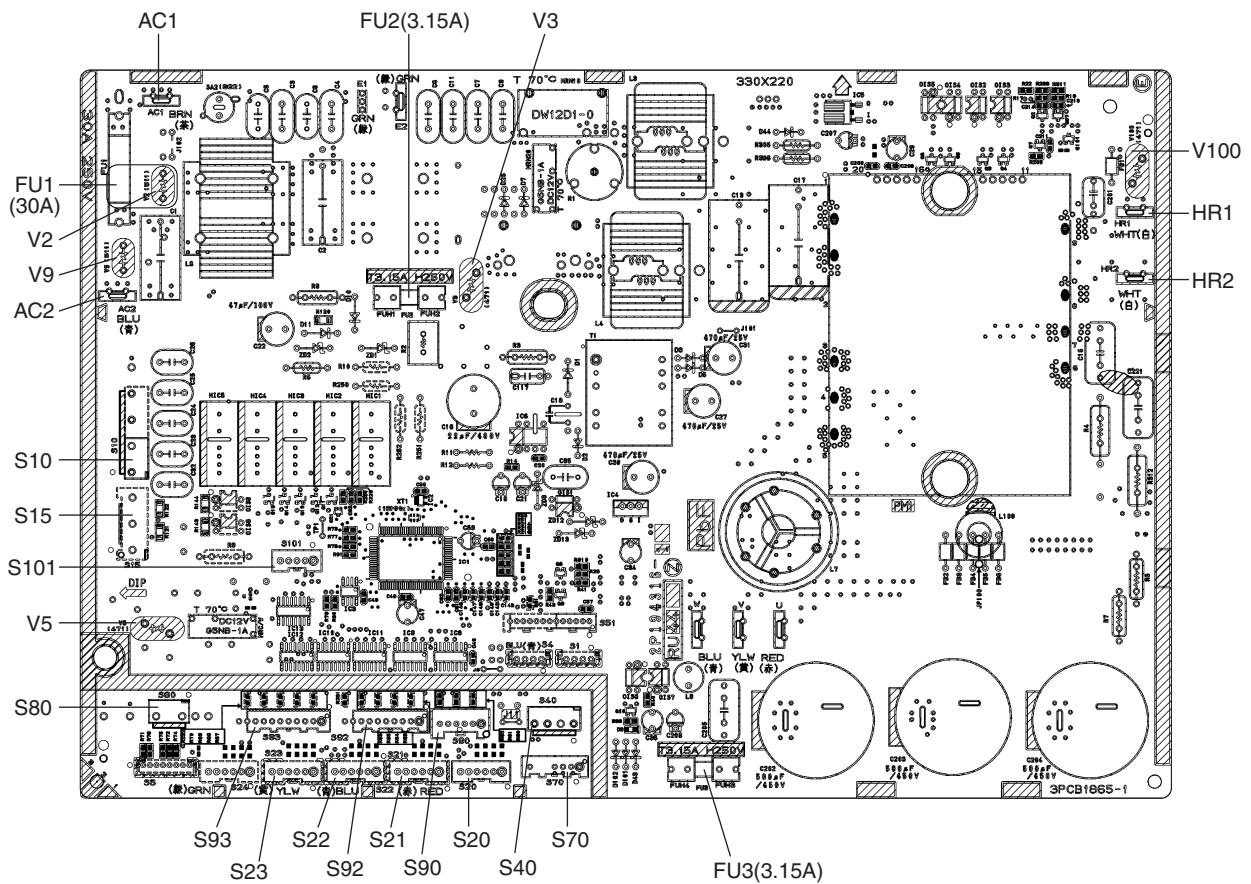

2P194316

PCB(2): Service Monitor PCB

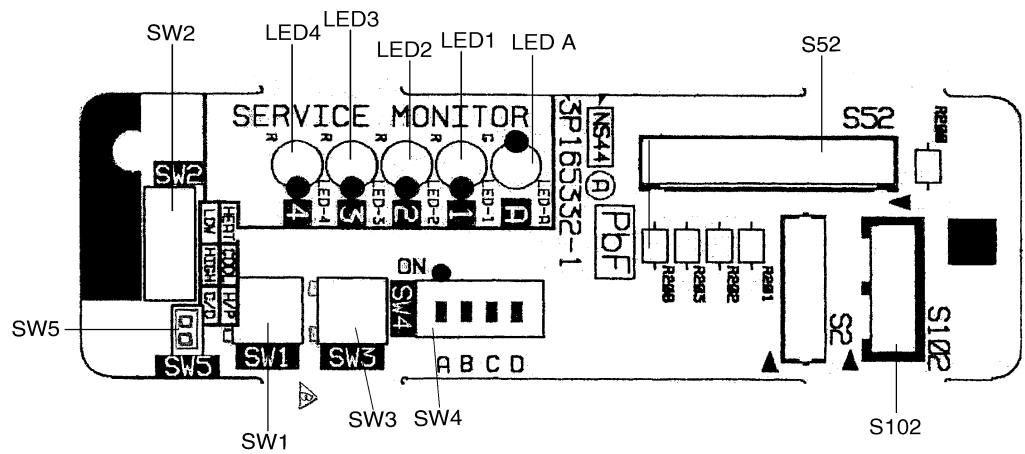

3P165332



# Part 4

## Function and Control

1. Main Functions.....	52
1.1 Frequency Principle.....	52
1.2 Power-Airflow Dual Flaps, Wide Angle Louvers and Auto-Swing .....	54
1.3 Operation Starting Control.....	56
1.4 Fan Speed Control for Indoor Units.....	57
1.5 Programme Dry Function .....	58
1.6 Automatic Operation.....	59
1.7 Thermostat Control.....	60
1.8 Night Set Mode.....	61
1.9 ECONO Mode .....	62
1.10 INTELLIGENT EYE (FTXG-E, CTXG-E, FTK(X)S-F) .....	63
1.11 2 AREA INTELLIGENT EYE (FTXS-G).....	65
1.12 HOME LEAVE Operation .....	67
1.13 Inverter POWERFUL Operation .....	68
1.14 Other Functions.....	69
2. Function of Main Structural Parts.....	71
2.1 Main Structural Parts.....	71
2.2 Function of Thermistor .....	72
3. Control Specification .....	76
3.1 Mode Hierarchy.....	76
3.2 Frequency Control.....	77
3.3 Controls at Mode Changing / Start-up.....	80
3.4 Discharge Pipe Control .....	82
3.5 Input Current Control.....	82
3.6 Freeze-up Protection Control .....	83
3.7 Heating Peak-cut Control .....	83
3.8 Fan Control.....	84
3.9 Liquid Compression Protection Function 2.....	84
3.10 Defrost Control .....	85
3.11 Electronic Expansion Valve Control .....	86
3.12 Malfunctions .....	90
3.13 Forced Operation Mode .....	91
3.14 Wiring-Error Check.....	92
3.15 Additional Function.....	94

# 1. Main Functions



**Note:** See the list of functions for the functions applicable to different models.

## 1.1 Frequency Principle

### Main Control Parameters

The compressor is frequency-controlled during normal operation. The target frequency is set by the following 2 parameters coming from the operating indoor unit:

- The load condition of the operating indoor unit
- The difference between the room temperature and the set temperature

### Additional Control Parameters

The target frequency is adapted by additional parameters in the following cases:

- Frequency restrictions
- Initial settings
- Forced cooling / heating operation

### Inverter Principle

To regulate the capacity, a frequency control is needed. The inverter makes it possible to vary the rotation speed of the compressor. The following table explains the conversion principle:

Phase	Description
1	The supplied AC power source is converted into the DC power source for the present.
2	The DC power source is reconverted into the three phase AC power source with variable frequency. <ul style="list-style-type: none"> <li>■ When the frequency increases, the rotation speed of the compressor increases resulting in an increased refrigerant circulation. This leads to a higher amount of the heat exchange per unit.</li> <li>■ When the frequency decreases, the rotation speed of the compressor decreases resulting in a decreased refrigerant circulation. This leads to a lower amount of the heat exchange per unit.</li> </ul>

### Drawing of Inverter

The following drawing shows a schematic view of the inverter principle:

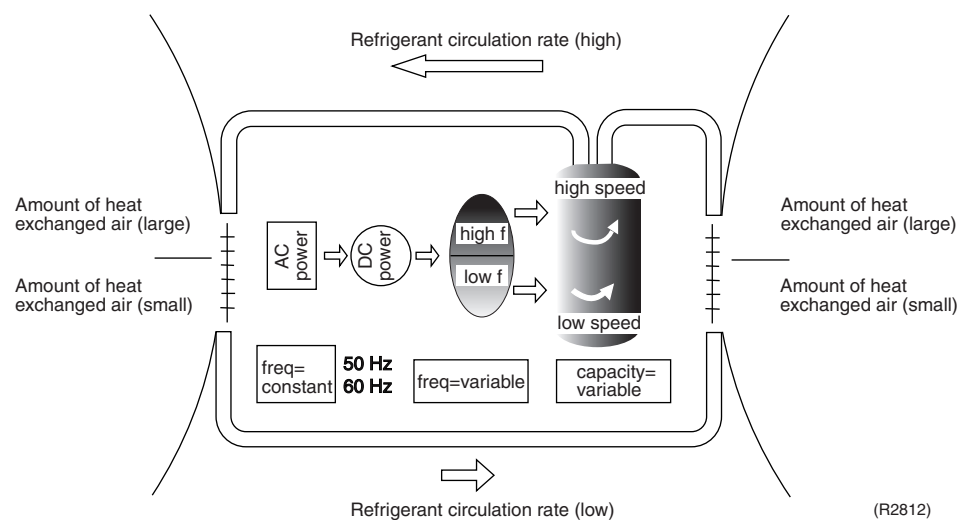

### Inverter Features

The inverter provides the following features:

- The regulating capacity can be changed according to the changes in the outdoor air temperature and cooling / heating load.
- Quick heating and quick cooling  
The compressor rotational speed is increased when starting the heating (or cooling). This enables a quick set temperature.

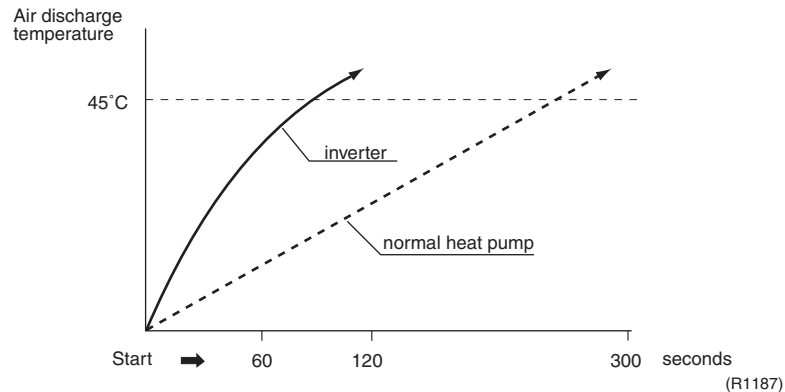

- Even during extreme cold weather, the high capacity is achieved. It is maintained even when the outdoor air temperature is 2°C.
- Comfortable air conditioning  
A detailed adjustment is integrated to ensure a fixed room temperature. It is possible to air condition with a small room temperature variation.
- Energy saving heating and cooling  
Once the set temperature is reached, the energy saving operation enables to maintain the room temperature at low power.

### Frequency Limits

The following table shows the functions that define the minimum and maximum frequency:

Frequency limits	Limited during the activation of following functions
Low	<ul style="list-style-type: none"> <li>■ Four way valve operation compensation. Refer to page 80.</li> </ul>
High	<ul style="list-style-type: none"> <li>■ Input current control. Refer to page 82.</li> <li>■ Compressor protection function. Refer to page 81.</li> <li>■ Heating Peak-cut control. Refer to page 83.</li> <li>■ Freeze-up protection. Refer to page 83.</li> <li>■ Defrost control. Refer to page 85.</li> </ul>

### Forced Cooling / Heating Operation

For more information, refer to "Forced operation mode" on page 91.



# 1.2 Power-Airflow Dual Flaps, Wide Angle Louvers and Auto-Swing

## Power-airflow Dual Flaps

The large flaps send a large volume of air downwards to the floor. The flap provides an optimum control area in cooling, heating and dry mode.

### Heating Mode

During heating mode, the large flap enables direct warm air straight downwards. The flap presses the warm air above the floor to reach the entire room.

### Cooling Mode

During cooling mode, the flap retracts into the indoor unit. Then, cool air can be blown far and pervaded all over the room.



## Wide-Angle Louvers

The louvers, made of elastic synthetic resin, provide a wide range of airflow that guarantees a comfortable air distribution.

## Auto-Swing

### In case of FTXS20-50G

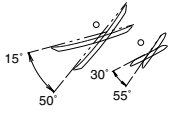
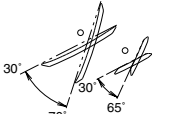
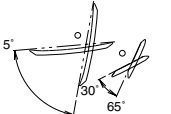
The following table explains the auto swing process for heating, cooling, dry and fan :

Vertical Swing (up and down)			Horizontal Swing (right and left: manual)
Cooling / Dry	Heating	Fan	
 <p>(R8278)</p>	 <p>(R8279)</p>	 <p>(R8280)</p>	 <p>(R8281)</p>

## 3-D Airflow

### FTXG25-35E, CTXG50E, FTXS20-50G, FTK(X)S60/71F

- Alternative repetition of vertical and horizontal swing motions enables uniform air-conditioning of the entire room. This function is effective for starting the air conditioner.
- When the horizontal swing and vertical swing are both set to auto mode, the airflow become 3-D airflow and the horizontal swing and vertical swing motions are alternated. The order of swing motion is such that it turns counterclockwise, starting from the right upper point as viewed to the front side of the indoor unit.

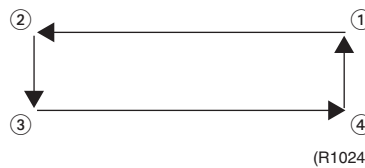



## COMFORT AIRFLOW Mode

### FTXG25-35E, CTXG50E

The vertical swing flap is controlled not to blow the air directly on the person in the room.

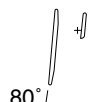
- The airflow rate is set to AUTOMATIC.
- The airflow rate has the upper limit (M tap) in heating mode.
- The latest command has the priority between POWERFUL and COMFORT AIRFLOW.

Heating	Cooling, Dry
 <p>80°</p> <p>(R3297)</p>	 <p>5°</p> <p>(R3298)</p>

**FTXS20-50G**

The vertical swing flap is controlled not to blow the air directly on the person in the room.

- The airflow rate is controlled automatically within the following steps.

Cooling: L tap – MH tap (same as AUTOMATIC)

Heating: Equivalent to ML tap – MH tap

- The latest command has the priority between POWERFUL and COMFORT AIRFLOW.

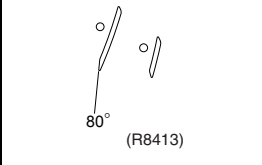
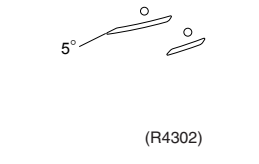
Heating	Cooling
 <p>80° (R8413)</p>	 <p>5° (R4302)</p>

# 1.3 Operation Starting Control

## FTXG25-35E, CTXG50E

The system carries out the following control at the beginning to conduct every functional parts properly.

1. Opening the front panel fully
2. Output of the  $\Delta D$  signal after the front panel starts moving
3. Opening the flap fully after the front panel opens fully
4. Making the fan rotate when the flap passes over the fan-banned area

### Control Flow

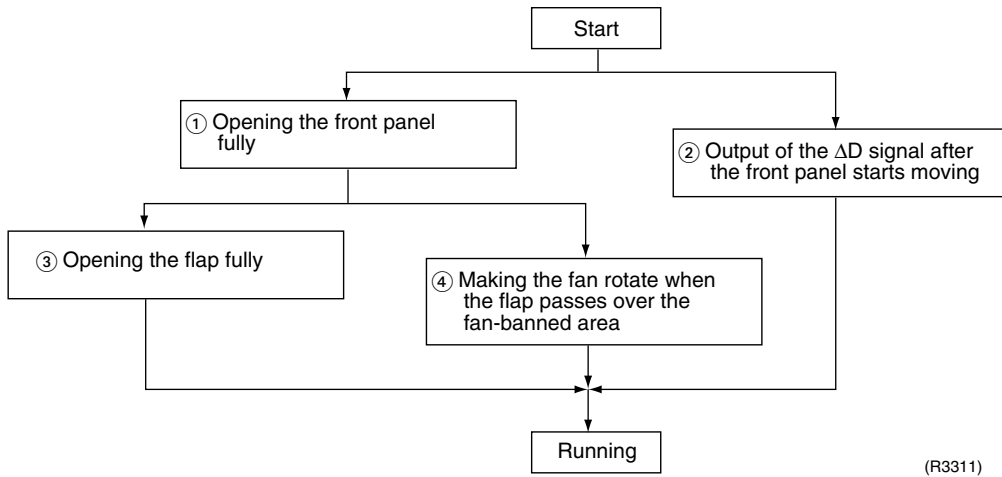

### Timing Chart

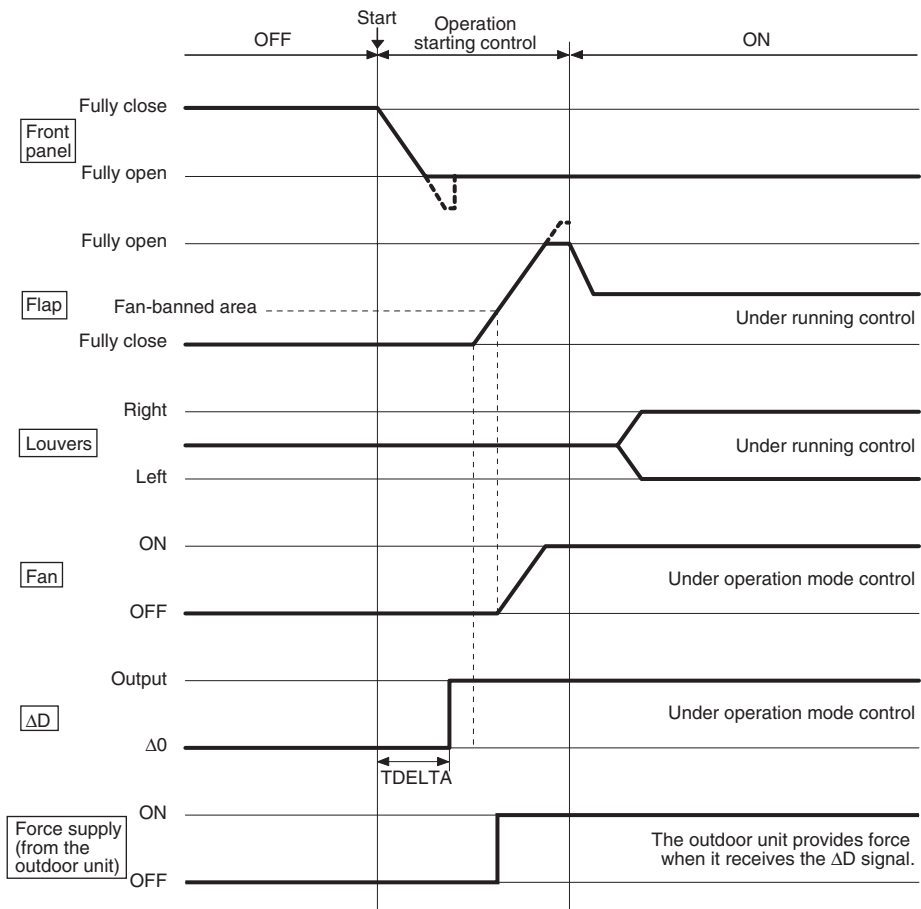

# 1.4 Fan Speed Control for Indoor Units

## Control Mode

The airflow rate can be automatically controlled depending on the difference between the set temperature and the room temperature. This is done through phase control and Hall IC control.



For more information about Hall IC, refer to the troubleshooting for fan motor on page 219.

## Phase Steps

Phase control and fan speed control contains 9 steps: LLL, LL, SL, L, ML, M, MH, H and HH. In automatic operation, the step "SL" is not available.

	FTXS20-50G FTXG25/35E CTXG50E FVXS25-50F		FTK(X)S60/71F		FDK(X)S25-35EA FDK(X)S50-60C FLK(X)S25-60BA	
Step	Cooling	Heating	Cooling	Heating	Cooling	Heating
LLL						
LL						
L						
ML						
M						
MH						
H						
HH (Powerful)	H+70 (FTXG25/35E) H+50 (FTXS20-50G, CTXG50E) H+40 (FVXS25-50F)	H+50 (FTXS20-50G, FTXG25/35E, CTXG50E) H+40 (FVXS25-50F)	H+90	H+90	H+50	H+50

= Within this range the airflow rate is automatically controlled when the FAN setting button is set to automatic.



### Note:

1. Fan stops during defrost operation.
2. In time of thermostat OFF, the fan rotates at the following speed.  
Cooling : The fan keeps rotating at the set tap.  
Heating : The fan keeps rotating at LLL tap (FTXS, FVXS series) or stops (the other models).

## Automatic Airflow Control for Heating

On heating mode, the indoor fan speed will be regulated according to the indoor heat exchanger temperature and the difference between the room temperature and the required set point.

## Automatic Airflow Control for Cooling

The following drawing explains the principle of fan speed control for cooling:

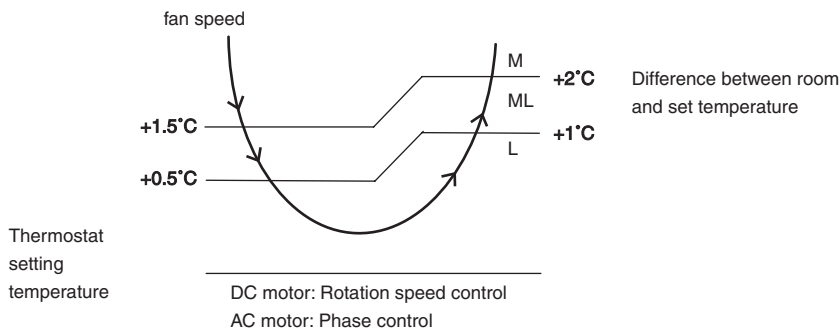

## 1.5 Programme Dry Function

Programme dry function removes humidity while preventing the room temperature from lowering.

Since the microcomputer controls both the temperature and airflow volume, the temperature adjustment and fan adjustment buttons are inoperable in this mode.

### In Case of Inverter Units

The microcomputer automatically sets the temperature and fan settings. The difference between the room temperature at startup and the temperature set by the microcomputer is divided into two zones. Then, the unit operates in the dry mode with an appropriate capacity for each zone to maintain the temperature and humidity at a comfortable level.

Room temperature at startup	Set temperature X	Thermostat OFF point Y	Thermostat ON point Z
24°C or more	Room temperature at startup	X - 2.5°C	X - 0.5°C or Y + 0.5°C (zone B) continues for 10 min.
23.5°C ∴ 18°C		X - 2.0°C	X - 0.5°C or Y + 0.5°C (zone B) continues for 10 min.
17.5°C ∴	18°C	X - 2.0°C	X - 0.5°C = 17.5°C or Y + 0.5°C (zone B) continues for 10 min.

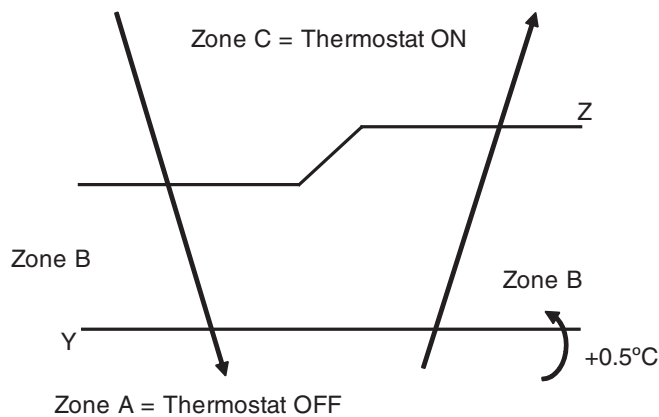

(R6841)

## 1.6 Automatic Operation

### Automatic Cooling / Heating Function (Heat Pump Only)

When the AUTO mode is selected with the remote controller, the microcomputer automatically determines the operation mode from cooling and heating according to the room temperature and setting temperature at the time of the operation startup, and automatically operates in that mode.

The unit automatically switches the operation mode to cooling or heating to maintain the room temperature at the main unit setting temperature.

#### Detailed Explanation of the Function

1. Remote controller setting temperature is set as automatic cooling / heating setting temperature (18 to 30°C).
2. Main unit setting temperature equals remote controller setting temperature.
3. Operation ON / OFF point and mode switching point are as follows.
  - ① Heating → Cooling switching point:  
Room temperature  $\geq$  Main unit setting temperature +2.5 deg.
  - ② Cooling → Heating switching point:  
Room temperature  $<$  Main unit setting temperature -2.5 deg.
  - ③ Thermostat ON / OFF point is the same as the ON / OFF point of cooling or heating operation.
4. During initial operation
  - Room temperature  $\geq$  Remote controller setting temperature: Cooling operation
  - Room temperature  $<$  Remote controller setting temperature: Heating operation

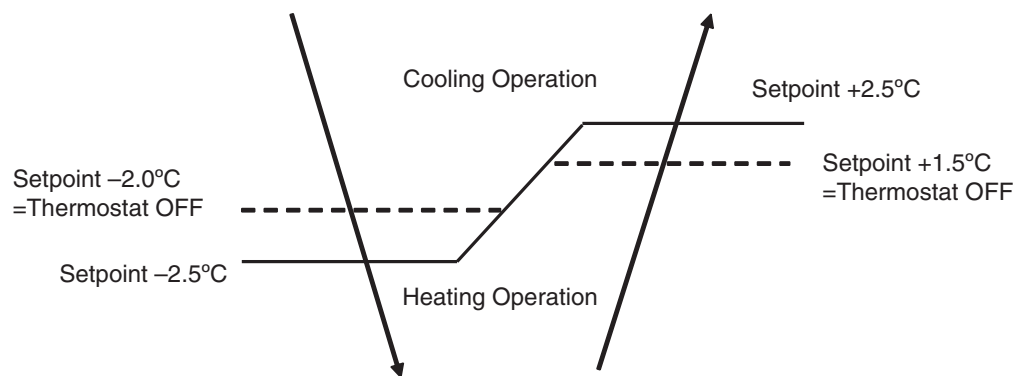

(R6842)

Ex: When the set point is 25°C

Cooling Operation → 23°C: Thermostat OFF → 22°C: Switch to Heating Operation

5. Heating Operation → 26.5°C: Thermostat OFF → 27.5°C: Switch to Cooling Operation

# 1.7 Thermostat Control

Thermostat control is based on the difference between the room temperature and the setpoint.

### Thermostat OFF Condition

- ◆ The temperature difference is in the zone A.

### Thermostat ON Condition

- ◆ The temperature difference is above the zone C after being in the zone A.
- ◆ The system resumes from defrost control in any zones except A.
- ◆ The operation turns on in any zones except A.
- ◆ The monitoring time has passed while the temperature difference is in the zone B.  
(Cooling / Dry : 10 minutes, Heating : 10 seconds)

### Cooling / Dry

- ◆ Wall Mounted Type
- ◆ Floor standing Type

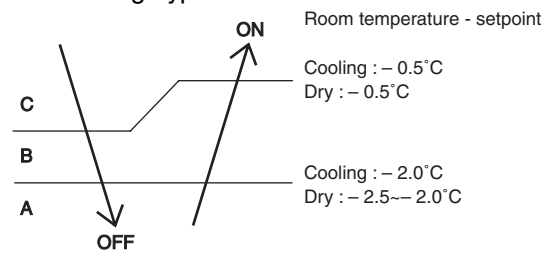

(R4668)

- ◆ Floor/Ceiling suspended Type
- ◆ Duct Connected Type

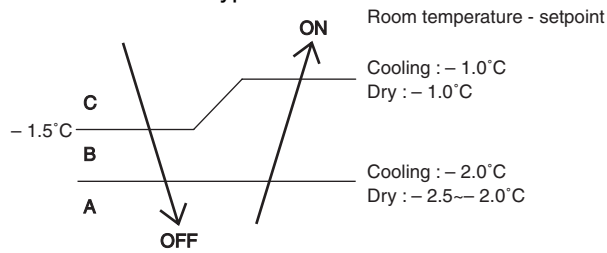

(R6032)

### Heating

- ◆ Wall Mounted Type
- ◆ Floor standing Type

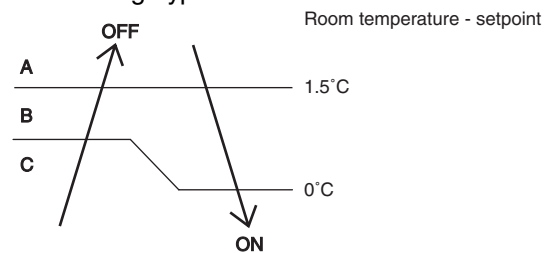

(R4669)

- ◆ Floor/Ceiling suspended Type
- ◆ Duct Connected Type

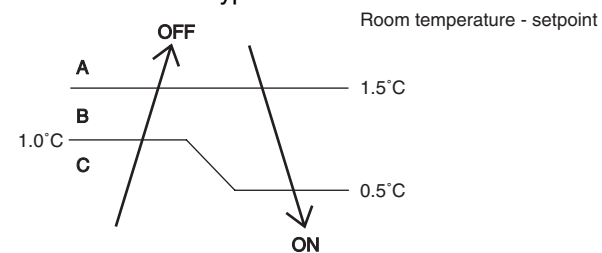

(R6033)

# 1.8 Night Set Mode

When the OFF timer is set, the Night Set circuit automatically activates. The Night Set circuit maintains the airflow setting made by users.

## The Night Set Circuit

The Night Set circuit continues heating or cooling the room at the set temperature for the first one hour, then automatically raises the temperature setting slightly in the case of cooling, or lowers it slightly in the case of heating, for economical operations. This prevents excessive heating in winter and excessive cooling in summer to ensure comfortable sleeping conditions, and also conserves electricity.

## Cooling Operation

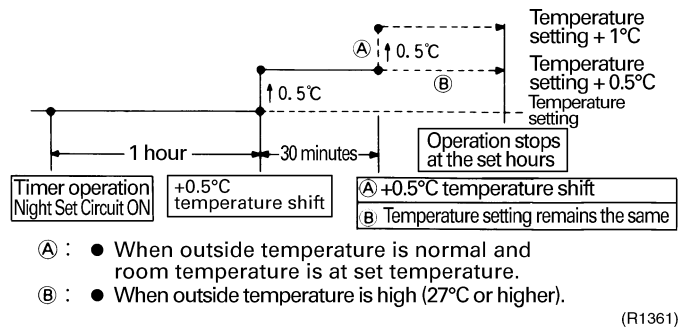

In case of FTXG25-35E, CTXG50E, FTXS20-50G, FVXS25-50F the temperature rises once.

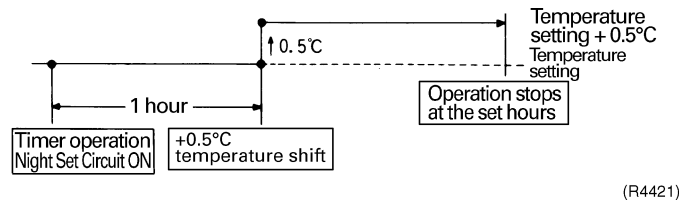

## Heating Operation

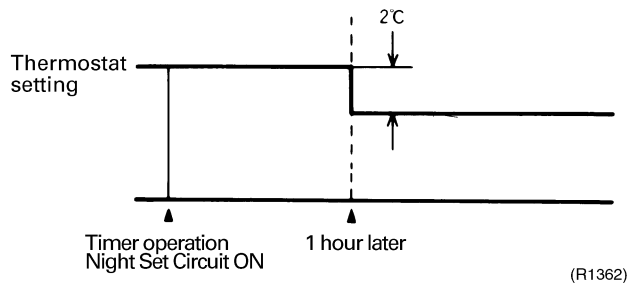



## 1.9 ECONO Mode

### Outline

#### FTXS20-50G, FVXS25-50F

The "ECONO mode" reduces the maximum operating current and power consumption by approx. 30% during start up etc..

This mode is particularly convenient for energy-saving-oriented users. It is also a major bonus for those whose breaker capacities do not allow the use of multiple electrical devices and air conditioners.

It is easily activated from the wireless remote controller by pushing the ECONO button.

- When this function is ON, the maximum capacity is also down. (Approx. 20%)
- This function can only be set when the unit is running. Pressing the operation stop button causes the settings to be canceled.
- This function and POWERFUL operation cannot be used at the same time. The latest command has the priority.

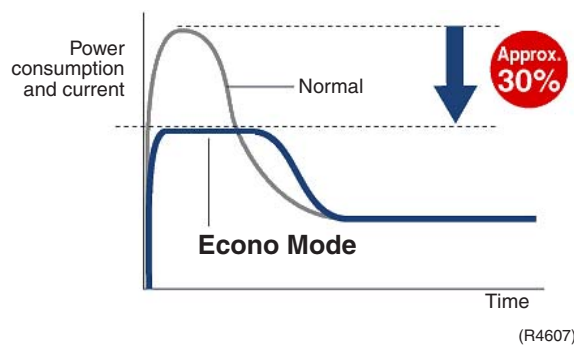

### Details

- ECONO mode can be activated while the unit is running. The remote controller can send the ECONO command when the unit is in COOL, HEAT, DRY, or AUTO operation.
- When the ECONO command is valid, the upper limit of frequency is restricted.

## 1.10 INTELLIGENT EYE (FTXG-E, CTXG-E, FTK(X)S-F)

This is the function that detects existence of humans in the room by a human motion sensor (INTELLIGENT EYE) and reduces the capacity when there is no human in the room in order to save electricity.

### Processing

#### 1. Detection method by Intelligent Eye

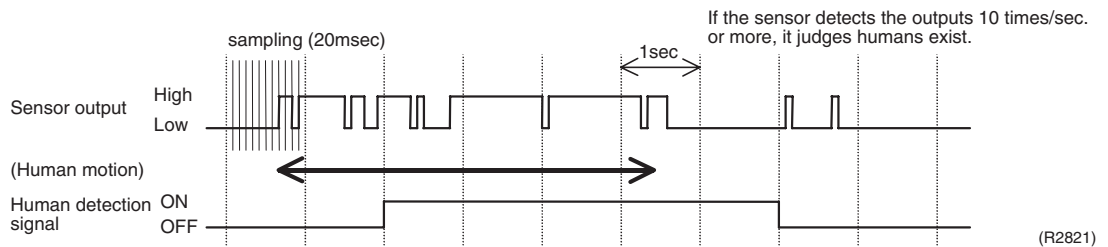

- This sensor detects human motion by receiving infrared rays and displays the pulse wave output.
- A microcomputer in an indoor unit carries out a sampling every 20 msec. and if it detects 10 cycles of the wave in one second in total (corresponding to  $20\text{msec.} \times 10 = 200\text{msec.}$ ), it judges human is in the room as the motion signal is ON.

#### 2. The motions (for example: in cooling)

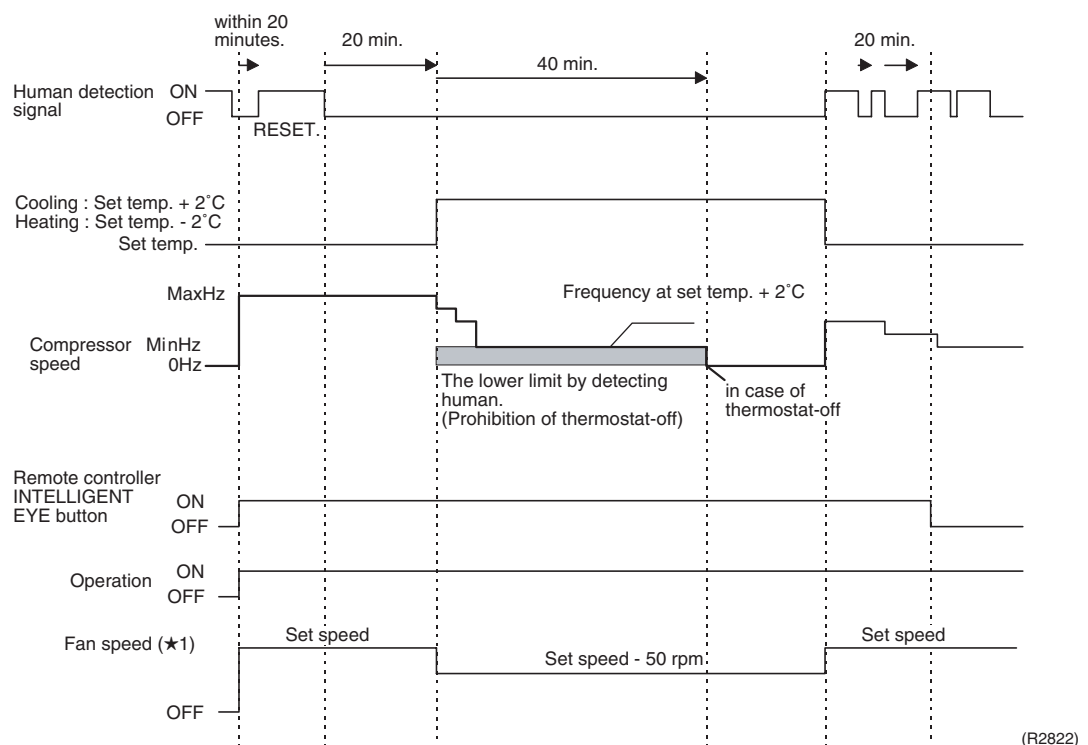

- When a microcomputer doesn't have a signal from the sensor in 20 minutes, it judges that nobody is in the room and operates the unit in temperature shifted 2°C from the set temperature. (Cooling : 2°C higher, Dry: 1°C higher and Auto : according to the operation mode at that time.)
- ★1 In case of Fan mode, the fan speed reduces by 50 rpm.

- Since the set temperature is shifted by 2°C higher for 40 minutes, compressor speed becomes low and can realize energy saving operation. But as thermostat is prone to be off by the fact that the set temperature has been shifted, the thermostat-off action is prohibited in 40 minutes so as to prevent this phenomena.  
After this 40 minutes, the prohibition of the thermostat-off is cancelled and it can realize the conditions to conduct thermostat-off depending on the room temperature. In or after this 40 minutes, if the sensor detects human motion detection signal, it let the set temperature and the fan speed return to the original set point, keeping a normal operation.

---

**Others**

- The dry operation can't command the setting temperature with a remote controller, but internally the set temperature is shifted by 1°C.

## 1.11 2 AREA INTELLIGENT EYE (FTXS-G)

The following functions can be performed by a human motion sensor (INTELLIGENT EYE).

1. Reduces the capacity when there is no human in the room in order to save electricity. (energy saving operation)
2. Divides the room into plural areas and detects existence of humans in each area. Shifts the airflow direction to the area having no human automatically to avoid direct airflow on humans.

### Processing

#### 1. Detection method by INTELLIGENT EYE

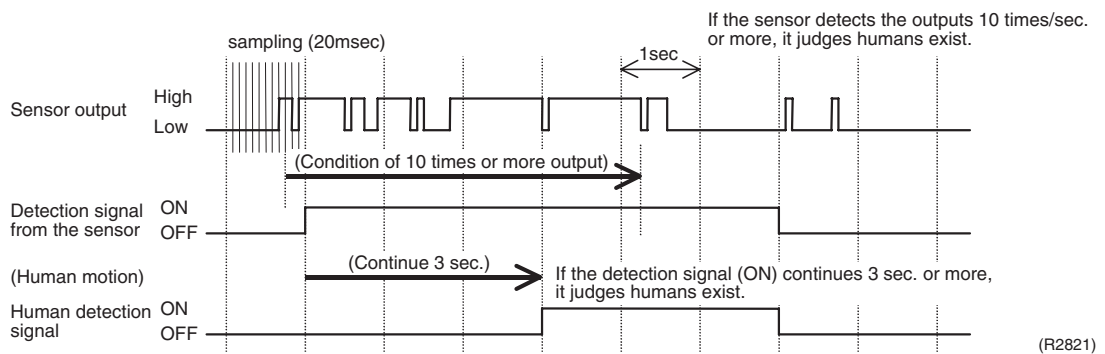

- This sensor detects human motion by receiving infrared rays and displays the pulse wave output.
- A microcomputer in an indoor unit carries out a sampling every 20 msec. and if it detects 10 cycles of the wave in one second in total (corresponding to  $20\text{msec.} \times 10 = 200\text{msec.}$ ), and when the ON signal continues 3 sec., it judges human is in the room as the motion signal is ON.
- INTELLIGENT EYE sensor is divided into 2 areas and detects humans in each area.

#### ■ Image of 2 AREA INTELLIGENT EYE

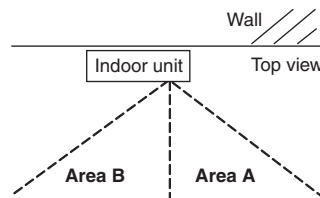

· A microcomputer judges human existence in area A and B by the sensor signal from each

(R3854)

## 2. The motions in energy saving operation (for example: in cooling)

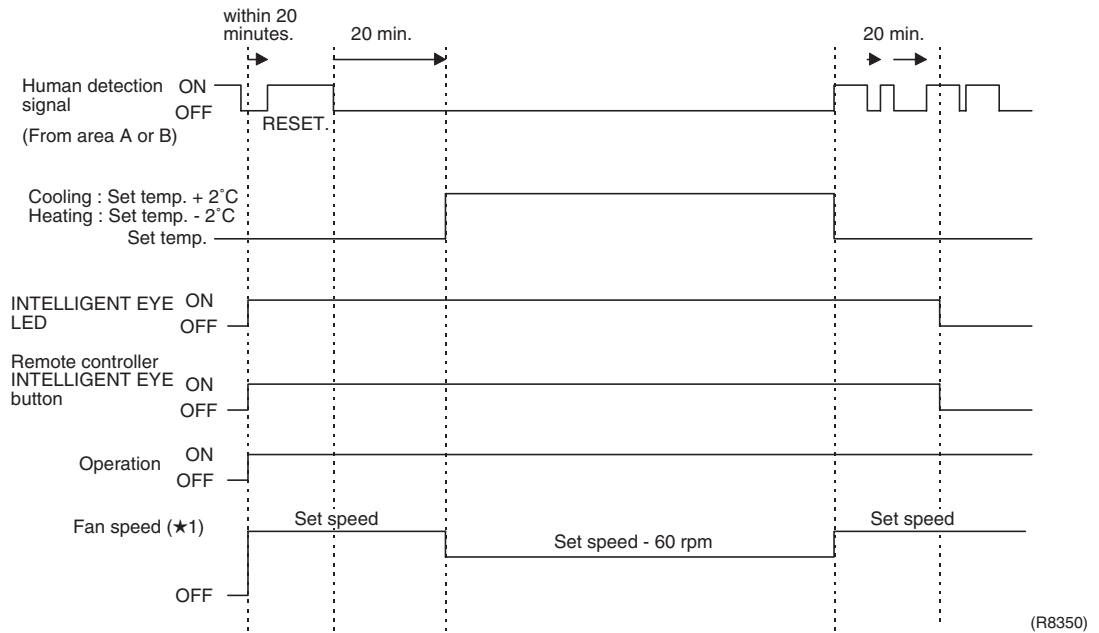

- When a microcomputer doesn't have a signal from the sensor in 20 minutes, it judges that nobody is in the room and operates the unit in temperature shifted 2°C from the set temperature. (Cooling/Dry : 2°C higher, Heating : 2°C lower and AUTO : according to the operation mode at that time.)

★1 In case of FAN mode, the fan speed reduces by 60 rpm.

## 3. Airflow direction in 2 AREA INTELLIGENT EYE operation

- Detection method: The opposite area of detected area is set as the target direction.

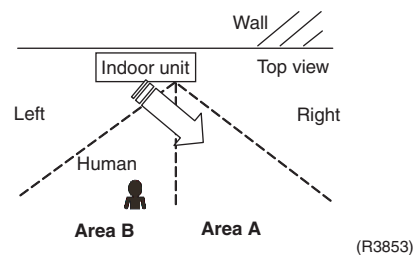

1. Detection signal ON in both area A and B: Shift the airflow direction to area B (left side)
2. Detection signal ON in area A: Shift the airflow direction to area B (left side)
3. Detection signal ON in area B: Shift the airflow direction to area A (right side)
4. Detection signal OFF in both area A and B: No change

\* When the detection signal OFF in both area A and B, the unit starts energy saving operation.

## Others

- The dry operation can't command the setting temperature with a remote controller, but internally the set temperature is shifted by 1°C.

## 1.12 HOME LEAVE Operation

### Outline

In order to respond to the customer's need for immediate heating and cooling of the room after returning home or for house care, a measure to switch the temperature and air volume from that for normal time over to outing time by one touch is provided. (This function responds also to the need for keeping up with weak cooling or heating.)

This time, we seek for simplicity of operation by providing the special temperature and air volume control for outing to be set by the exclusive button. The SkyAir indoor models also have the function.

### Detail of the Control

#### 1. Start of Function

The function starts when the [HOME LEAVE] button is pressed in cooling mode or heating mode (including stopping and powerful operation). If this button is pressed while the operation is stopped, the function becomes effective when the operation is started. If this button is pressed in powerful operation, the powerful operation is reset and this function becomes effective.

- The [HOME LEAVE] button is ineffective in dry mode and fan mode.

#### 2. Details of Function

A mark representing [HOME LEAVE] is indicated on the liquid crystal display of the remote controller. The indoor unit is operated according to the set temperature and air volume for HOME LEAVE which were pre-set in the memory of the remote controller.

The LED (Red) of indoor unit representing [HOME LEAVE] lights up. (It goes out when the operation is stopped.)

#### 3. End of Function

The function ends when the [HOME LEAVE] button is pressed again during [HOME LEAVE] operation or when the powerful operation button is pressed.

#### Scene <cooling>



#### Scene <Heating>

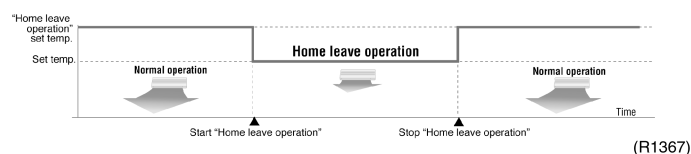
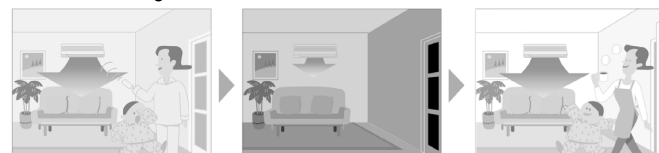

### Others

The set temperature and set air volume are memorized in the remote controller. When the remote controller is reset due to replacement of battery, it is necessary to set the temperature and air volume again for [HOME LEAVE].

## 1.13 Inverter POWERFUL Operation

### Outline

In order to exploit the cooling and heating capacity to full extent, operate the air conditioner by increasing the indoor fan rotating speed and the compressor frequency.

### Details of the Control

When POWERFUL button is pushed in each operation mode, the fan speed / setting temperature will be converted to the following states in a period of 20 minutes.

#### In case of FTXS20-50G

Operation mode	Fan speed	Target set temperature
COOL	H tap + 50 rpm	18°C
DRY	Dry rotating speed + 50 rpm	Normally targeted temperature in dry operation; Approx. -2°C
HEAT	H tap + 50 rpm	30°C
FAN	H tap + 50 rpm	—
AUTO	Same as cooling / heating in POWERFUL operation	The target is kept unchanged

Ex.) : POWERFUL operation in cooling mode.

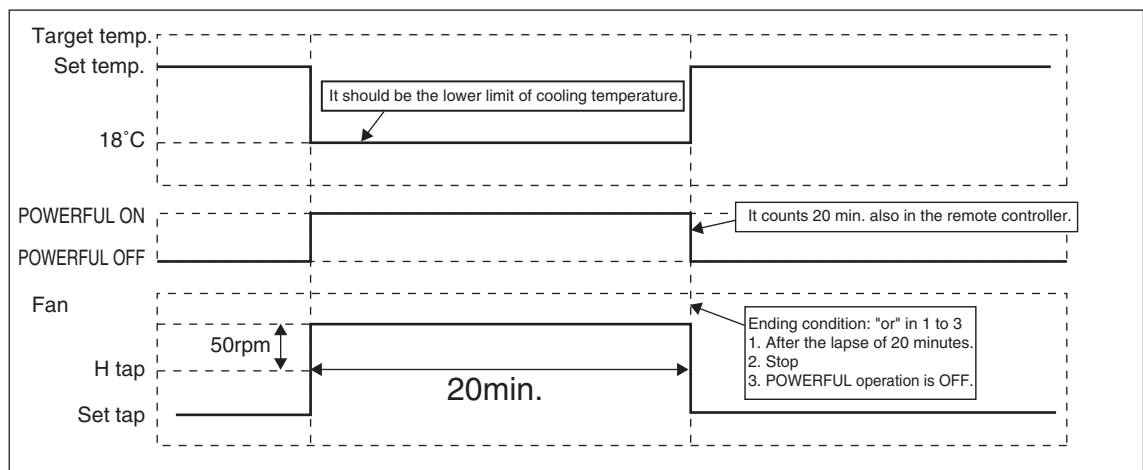

(R4560)



Refer to "Fan Speed control" on page 57 for detail.

## 1.14 Other Functions

### 1.14.1 Hot-Start Function

#### Heat Pump Only

In order to prevent the cold air blast that normally comes when heating is started, the temperature of the heat exchanger of the indoor unit is detected, and either the airflow is stopped or is made very weak thereby carrying out comfortable heating of the room.

\*The cold air blast is also prevented using a similar control when the defrosting operation is started or when the thermostat gets turned ON.

### 1.14.2 Signal Receiving Sign

When the indoor unit receives a signal from the remote controller, the unit emits a signal receiving sound.

### 1.14.3 ON/OFF Button on Indoor Unit

An ON/OFF button is provided on the front panel of the unit. Use this button when the remote controller is missing or if its battery has run out.

Every press of the button switches from ON to OFF or from OFF to ON.

#### In case of FTXS20-50G

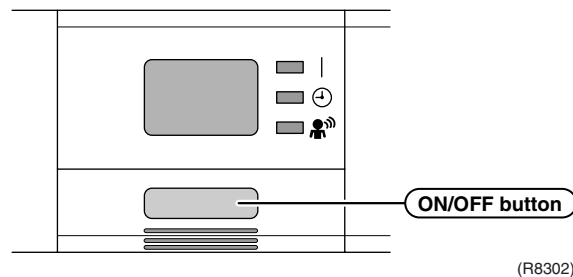

- Push this button once to start operation. Push once again to stop it.
- This button is useful when the remote controller is missing.
- The operation mode refers to the following table.

	Mode	Temperature setting	Airflow rate
Cooling Only	COOL	22°C	AUTO
Heat Pump	AUTO	25°C	AUTO

- In the case of multi system operation, there are times when the unit does not activate with this button.

#### <Forced operation mode>

Forced operation mode will be set by pressing the ON/OFF button for between 5 to 9 sec. while the unit is not operating.



**Note:** When the ON/OFF button is pressed for 10 sec. or more, the operation will be stopped. See page 91 for the detail of "Forced Operation Mode".



### 1.14.4 Titanium Apatite Photocatalytic Air-Purifying Filter

**For FTXS20-50G, FTK(X)S60/71F, FVXS25-50F, FTXG25/35E, CTXG50E**

This filter combines the Air Purifying Filter and Titanium Apatite Photocatalytic Deodorizing Filter in a single highly effective unit. The filter traps microscopic particles, decompose odours and even deactivates bacteria and viruses. It lasts for three years without replacement if washed about once every six months.

### 1.14.5 Photocatalytic Deodorizing Filter

**For FLK(X)S25-60B**

Photocatalytic Deodorizing Filter demonstrates powerful oxidation characteristics when subjected to harmless ultraviolet light. Photocatalytic deodorizing power is recovered simply by exposing the filter to the sun for 6 hours once every 6 months.

### 1.14.6 Air-Purifying Filter

**For FLK(X)S25-60B**

A double structure made up of a bacteriostatic filter and an Air-Purifying Filter traps dust, mildew, mites, tobacco smoke, and allergy-causing pollen. Replace the Air-Purifying Filter once every 3 months.

### 1.14.7 Mold Proof Air Filter (Prefilter)

**For all indoor units**

The filter net is treated with mold resisting agent TBZ (harmless, colorless, and odorless). Due to this treatment, the amount of mold growth is much smaller than that of normal filters.

### 1.14.8 Self-Diagnosis Digital Display

The microcomputer continuously monitors main operating conditions of the indoor unit, outdoor unit and the entire system. When an abnormality occur, the LCD remote controller displays error code. These indications allow prompt maintenance operations.

### 1.14.9 Auto-restart Function

Even if a power failure (including one for just a moment) occurs during the operation, the operation restarts in the condition before power failure automatically when power is restored. (Note) It takes 3 minutes to restart the operation because the 3-minute standby function is activated.

### 1.14.10 WEEKLY TIMER Operation

Up to 4 timer settings can be saved for each day of the week (up to 28 settings in total). Those 3 items of "ON / OFF", "temperature" and "time" can be set.



Refer to "WEEKLY TIMER Operation" on page 175 for detail.

## 2. Function of Main Structural Parts

### 2.1 Main Structural Parts

#### Heat Pump Model

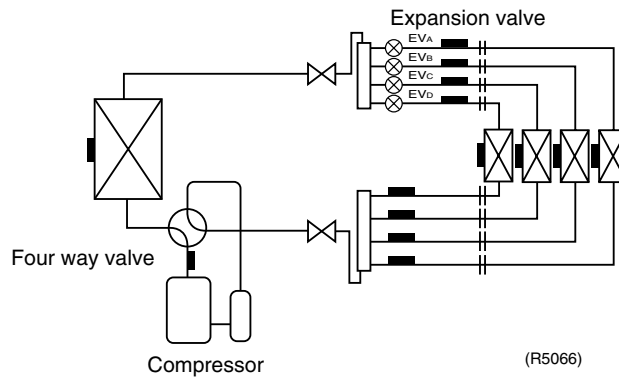

#### Cooling Only Model

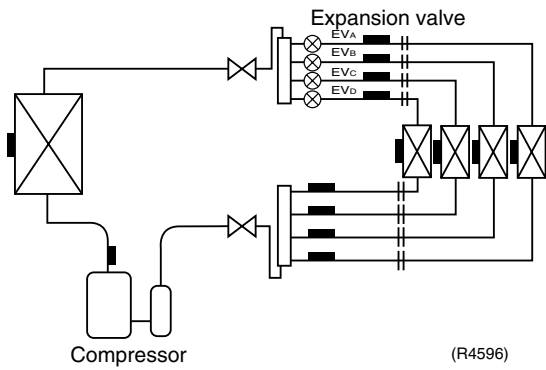

**i Note:** Expansion Valve : In Case of 3 port model.....EVA-C, 4 port model.....EVA-D

## 2.2 Function of Thermistor

### 2.2.1 Heat Pump Model

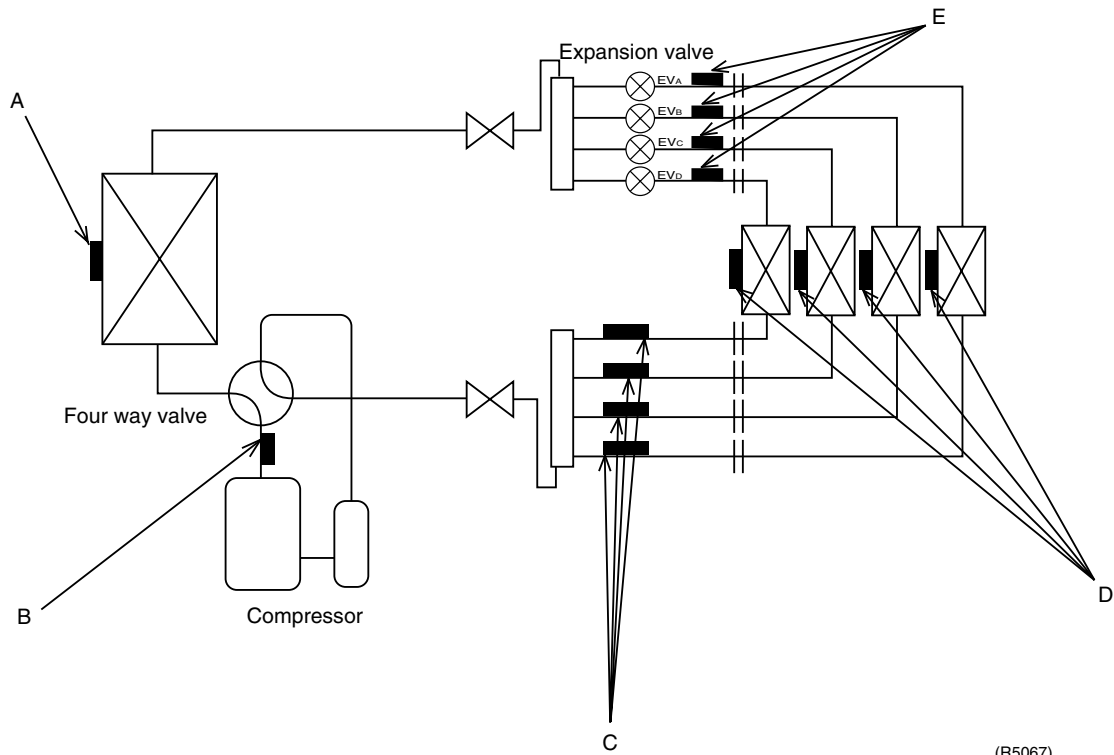

(R5067)

#### A Outdoor Heat Exchanger Thermistor

1. The outdoor heat exchanger thermistor is used for controlling target discharge temperature. The system sets a target discharge temperature according to the outdoor and indoor heat exchanger temperature, and controls the electronic expansion valve opening so that the target discharge temperature can be obtained.
2. The outdoor heat exchanger thermistor is used for detecting disconnection of the discharge thermistor when cooling.  
When the discharge pipe temperature becomes lower than the outdoor heat exchanger temperature, the discharge pipe thermistor is judged as disconnected.

#### B Discharge Pipe Thermistor

1. The discharge pipe thermistor is used for controlling temperature of the discharge pipe. If the temperature of discharge pipe (used in place of the inner temperature of the compressor) rises abnormally, the operating frequency drops or the operation halts.
2. The discharge pipe thermistor is used for detecting disconnection of the discharge thermistor.

#### C Gas Pipe Thermistor

1. In cooling, the gas pipe thermistors are used for gas pipe isothermal control. The system controls electronic expansion valve opening so that gas pipe temperature in each room becomes equal.

---

#### D Indoor Heat Exchanger Thermistor

1. The indoor heat exchanger thermistors are used for controlling target discharge temperature.  
The system sets a target discharge pipe temperature according to the outdoor and indoor heat exchanger temperature, and controls the electronic expansion valve opening so that the target discharge temperature can be obtained.
2. The indoor heat exchanger thermistors are used for preventing freezing.  
During the cooling operation, if the temperature drops abnormally, the operating frequency becomes lower, then the operation halts.
3. The indoor heat exchanger thermistors are used for anti-icing control.  
During the cooling operation, if the heat exchanger temperature in the room where operation is halted becomes  $-1^{\circ}\text{C}$ , or if the room temperature - heat exchanger temperature in the room where operation is halted becomes  $\geq 10^{\circ}\text{C}$ , it is assumed as icing.
4. During heating: the indoor heat exchanger thermistors are used for detecting disconnection of the discharge pipe thermistor.  
When the discharge pipe temperature becomes lower than the indoor heat exchanger temperature, the discharge pipe thermistor is judged as disconnected.  
The indoor heat exchanger thermistors are also used for preventing abnormal high pressure.
5. The indoor heat exchanger thermistors are used for detecting incorrect wiring.  
During checking incorrect wiring, refrigerant is passed in order from the port A to detect a heat exchanger temperature, and then wiring and piping will be checked.
6. The indoor heat exchanger thermistors are used for sub-cooling control.  
The actual sub-cooling is calculated from the liquid pipe temperature and the heat exchanger temperature. The system controls the electronic expansion valve opening to reach the target sub-cooling.
7. The indoor heat exchanger thermistors are used for heating isothermal control of heat exchanger.  
When heating: if the difference in temperature of each room is greater than  $8^{\circ}\text{C}$ , the electronic expansion valve of the room in which the temperature is higher is opened.

---

#### E Liquid Pipe Thermistor

1. In heating, the liquid pipe thermistors are used for sub-cooling control.  
The system calculates the actual sub-cooling with the liquid pipe temperature and the maximum heat exchanger temperature among all rooms, and controls the opening of the electronic expansion valve to reach the target sub-cooling.

## 2.2.2 Cooling Only Model

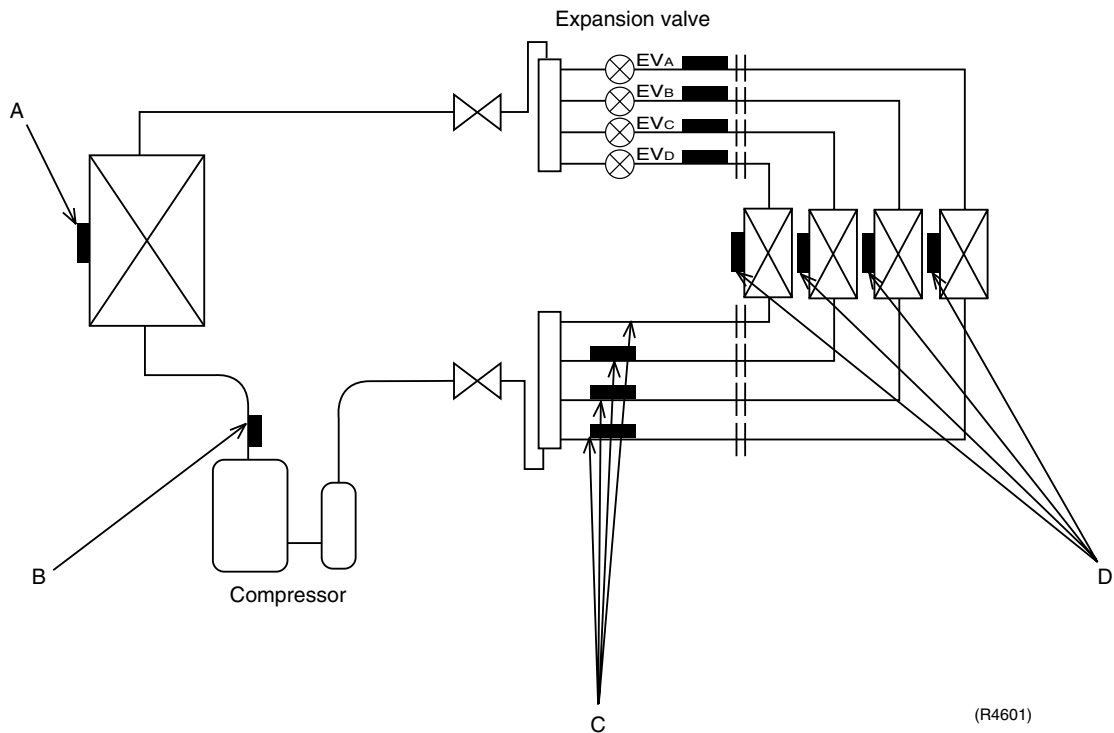

### A Outdoor Heat Exchanger Thermistor

1. The outdoor heat exchanger thermistor is used for controlling target discharge temperature. The system sets a target discharge temperature according to the outdoor and indoor heat exchanger temperature, and controls the electronic expansion valve opening so that the target discharge temperature can be obtained.
2. The outdoor heat exchanger thermistor is used for detecting disconnection of the discharge thermistor when cooling. When the discharge pipe temperature becomes lower than the outdoor heat exchanger temperature, the discharge pipe thermistor is judged as disconnected.

### B Discharge Pipe Thermistor

1. The discharge pipe thermistor is used for controlling temperature of the discharge pipe. If the temperature of discharge pipe (used in place of the inner temperature of the compressor) rises abnormally, the operating frequency drops or the operation halts.
2. The discharge pipe thermistor is used for detecting disconnection of the discharge thermistor.

### C Gas Pipe Thermistor

1. In cooling, the gas pipe thermistors are used for gas pipe isothermal control. The system controls electronic expansion valve opening so that gas pipe temperature in each room becomes equal.

#### D Indoor Heat Exchanger Thermistor

1. The indoor heat exchanger thermistors are used for controlling target discharge temperature.  
The system sets a target discharge pipe temperature according to the outdoor and indoor heat exchanger temperature, and controls the electronic expansion valve opening so that the target discharge temperature can be obtained.
2. The indoor heat exchanger thermistors are used for preventing freezing.  
During the cooling operation, if the temperature drops abnormally, the operating frequency becomes lower, then the operation halts.
3. The indoor heat exchanger thermistors are used for anti-icing control.  
During the cooling operation, if the heat exchanger temperature in the room where operation is halted becomes  $-1^{\circ}\text{C}$ , or if the room temperature - heat exchanger temperature in the room where operation is halted becomes  $\geq 10^{\circ}\text{C}$ , it is assumed as icing.
4. The indoor heat exchanger thermistors are used for detecting incorrect wiring.  
During checking incorrect wiring, refrigerant is passed in order from the port A to detect a heat exchanger temperature, and then wiring and piping will be checked.

# 3. Control Specification

## 3.1 Mode Hierarchy

**Outline** There are two modes; the mode selected in user's place (normal air conditioning mode) and forced operation mode for installation and providing service.

**Detail** **1. For heat pump model**  
There are following modes; stop, cooling (includes drying), heating (include defrosting)

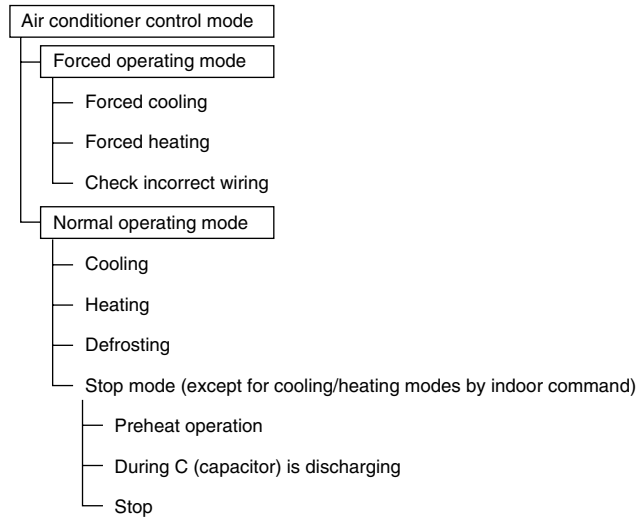

(R1373)

**2. For cooling only model**  
There are following models; stop and cooling (including drying).

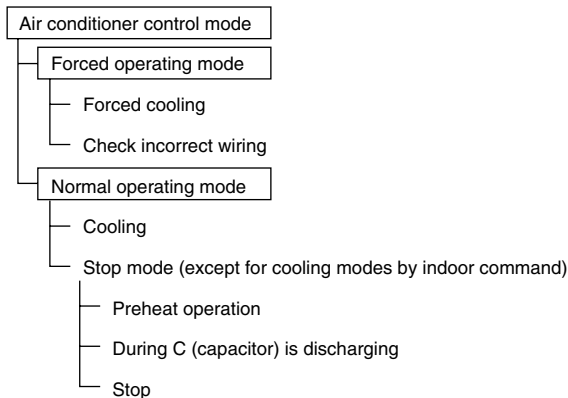

(R1374)



**Note:** Unless specified otherwise, an indoor dry operation command must be regarded as cooling operation. An indoor fan operation command cannot be made in a multiple indoor unit. (A forced fan command to the indoor unit from the outdoor unit must be made during forced operation.)

### Determine Operating Mode

Judge the operating mode command set by each room in accordance with the instructing procedure, and determine the operating mode of the system.

The following procedure will be taken as the modes conflict with each other.

\*1. The system will follow the mode determined first. (First-push, first-set)

\*2. For the rooms set with different mode, select stand-by mode. (Operation lamp flashes)

## 3.2 Frequency Control

### Outline

Frequency that corresponds to each room's capacity will be determined according to the difference in the temperature of each room and the temperature that is set by the remote controller.

The function is explained as follows.

1. How to determine frequency.
2. Frequency command from an indoor unit. (The difference between a room temperature and the temperature set by the remote controller.)
3. Frequency command from an indoor unit. (The ranked capacity of the operating room).
4. Frequency initial setting.
5. PI control.

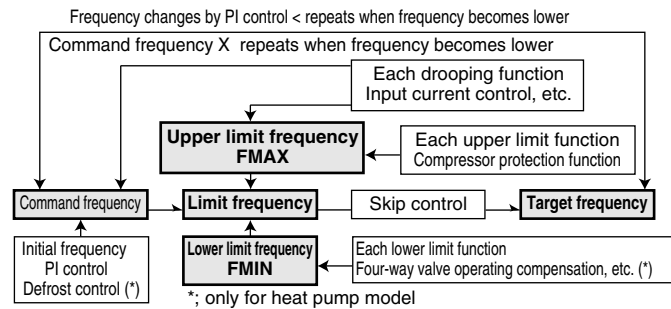

(R1375)

### Detail

#### How to Determine Frequency

The compressor's frequency will finally be determined by taking the following steps.

#### For Heat Pump Model

##### 1. Determine command frequency

- ◆ Command frequency will be determined in the following order of priority.
  - 1.1 Limiting frequency by drooping function
    - ◆ Input current, discharge pipes, low Hz high pressure limit, peak cutting, freeze-up protection, dew prevention, fin thermistor temperature.
  - 1.2 Limiting defrost control time
  - 1.3 Forced cooling / heating
  - 1.4 Indoor frequency command

##### 2. Determine upper limit frequency

- ◆ Set a minimum value as an upper limit frequency among the frequency upper limits of the following functions:  
Compressor protection, input current, discharge pipes, Low Hz high pressure, peak cutting, freeze-up protection, defrost.

##### 3. Determine lower limit frequency

- ◆ Set a maximum value as an lower limit frequency among the frequency lower limits of the following functions:  
Four way valve operating compensation, draft prevention, pressure difference upkeep.

##### 4. Determine prohibited frequency

- ◆ There is a certain prohibited frequency such as a power supply frequency.

#### For Cooling Only Model

##### 1. Determine command frequency

- ◆ Command frequency will be determined in the following order of priority.
  - 1.1 Limiting frequency by drooping function  
Input current, discharge pipes, freeze-up protection, dew prevention, fin thermistor temperature.
  - 1.2 Indoor frequency command



**2. Determine upper limit frequency**

- ◆ Set a minimum value as an upper limit frequency among the frequency upper limits of the following functions:  
Compressor protection, input current, discharge pipes, freeze-up protection, dew prevention, fin thermistor temperature.

**3. Determine lower limit frequency**

- ◆ Set a maximum value as an lower limit frequency among the frequency lower limits of the following functions:  
Pressure difference upkeep.

**4. Determine prohibited frequency**

- ◆ There is a certain prohibited frequency such as a power supply frequency.

**Indoor Frequency Command ( $\Delta D$  signal)**

The difference between a room temperature and the temperature set by the remote controller will be taken as the " $\Delta D$  signal" and is used for frequency command.

Temperature difference	$\Delta D$ signal	Temperature difference	$\Delta D$ signal	Temperature difference	$\Delta D$ signal	Temperature difference	$\Delta D$ signal
0	*Th OFF	2.0	4	4.0	8	6.0	C
0.5	1	2.5	5	4.5	9	6.5	D
1.0	2	3.0	6	5.0	A	7.0	E
1.5	3	3.5	7	5.5	B	7.5	F

\*Th OFF = Thermostat OFF

**Indoor Unit Capacity (S value)**

The capacity of the indoor unit is a "S" value and is used for frequency command.

Capacity	S value	Capacity	S value
2.5 kW	25	6.0 kW	60
3.5 kW	35	7.1 kW	71
5.0 kW	50		

**Frequency Initial Setting****<Outline>**

When starting the compressor, or when conditions are varied due to the change of the operating room, the frequency must be initialized according to the total of a maximum  $\Delta D$  value of each room and a total value of Q ( $\Sigma Q$ ) of the operating room (the room in which the thermostat is set to ON).  
Q value: Indoor unit output determined from indoor unit volume, airflow rate and other factors.

**PI Control (Determine Frequency Up / Down by  $\Delta D$  Signal)****1. P control**

Calculate a total of the  $\Delta D$  value in each sampling time (20 seconds), and adjust the frequency according to its difference from the frequency previously calculated.

**2. I control**

If the operating frequency is not change more than a certain fixed time, adjust the frequency up and down according to the  $\Sigma \Delta D$  value, obtaining the fixed  $\Sigma \Delta D$  value.

When the  $\Sigma \Delta D$  value is small...lower the frequency.

When the  $\Sigma \Delta D$  value is large...increase the frequency.

**3. Limit of frequency variation width**

When the difference between input current and input current drooping value is less than 1.5 A, the frequency increase width must be limited.

**4. Frequency management when other controls are functioning**

- ◆ When each frequency is drooping;  
Frequency management is carried out only when the frequency droops.
- ◆ For limiting lower limit  
Frequency management is carried out only when the frequency rises.

**5. Upper and lower limit of frequency by PI control**

The frequency upper and lower limits are set depending on the total of S values of a room. When low noise commands come from the indoor unit more than one room or when outdoor unit low noise or quiet commands come from all the rooms, the upper limit frequency must be lowered than the usual setting.

## 3.3 Controls at Mode Changing / Start-up

### 3.3.1 Preheating Operation

**Outline** Operate the inverter in the open phase operation with the conditions including the preheating command from the indoor, the outdoor air temperature and discharge pipe temperature. The power consumption of preheating operation is 35W. (The total power consumption depends on the number of the indoor units.)

**Detail**

**Preheating ON Condition**

- ◆ When outdoor air temperature is below 10.5°C or discharge pipe temperature is below 10.5°C, inverter in open phase operation starts. (The power consumption of compressor during preheat operation is 35W.)

**OFF Condition**

- ◆ When outdoor air temperature is higher than 12°C or discharge pipe temperature is higher than 12°C, inverter in open phase operation stops.

### 3.3.2 Four Way Valve Switching

**Outline of heating operation**

**Heat Pump Only**

During the heating operation current must be conducted and during cooling and defrosting current must not be conducted. In order to eliminate the switching sound (as the four way valve coil switches from ON to OFF) when the heating is stopped, the delay switch of the four way valve must be carried out after the operation stopped.

**Detail**

The OFF delay of four way valve  
Energize the coil for 150 sec after unit operation is stopped.

### 3.3.3 Four Way Valve Operation Compensation

**Outline**

**Heat Pump Only**

At the beginning of the operation as the four way valve is switched, acquire the differential pressure required for activating the four way valve by having output the operating frequency, which is more than a certain fixed frequency, for a certain fixed time.

The lower limit frequency is restricted to 40Hz for 70 seconds on both cooling and heating, except under the condition of heating overload (outdoor temperature  $\geq 15$  degree).

**Detail**

**Starting Conditions**

1. When starting compressor for heating.
2. When the operating mode changes from the previous time.
3. When starting compressor for rushing defrosting or resetting.
4. When starting compressor for the first time after the reset with the power is ON.

Set the lower limit frequency to 40 (model by model) Hz for 70 seconds with any conditions 1 through 4 above.

### 3.3.4 3-Minute Standby

Prohibit to turn ON the compressor for 3 minutes after turning it off.  
(Except when defrosting. (Only for Heat Pump Model).)

### 3.3.5 Compressor Protection Function

When turning the compressor from OFF to ON, the upper limit of frequency must be set as follows. (The function must not be used when defrosting (only for heat pump model).)

	2YC45
FCG 3	80
FCG 2	65
FCG 1	55

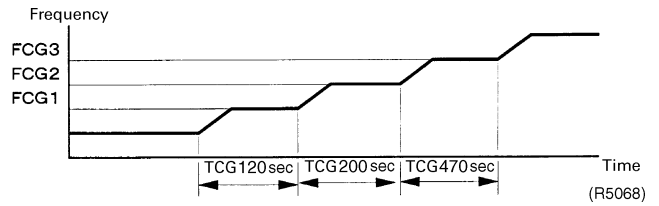

**Note:** When the compressor doesn't run for long time in the condition that the discharge pipe temperature is 10°C or less, the time between FCG2 and FCG3 will be longer than 470 sec.

## 3.4 Discharge Pipe Control

### Outline

The discharge pipe temperature is used as the compressor's internal temperature. If the discharge pipe temperature rises above a certain level, the operating frequency upper limit is set to keep this temperature from going up further.

### Detail

#### Zones (typical value)

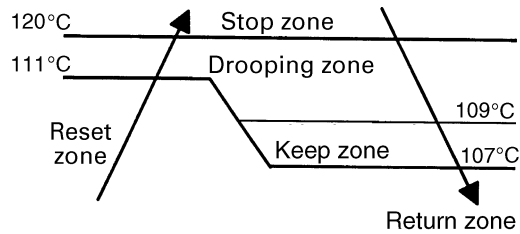

(R5069)

#### Management within the Zone

Zone	Control contents
Stop zone	When the temperature reaches the stop zone, stop the compressor and correct abnormality.
Drooping zone	Start the timer, and the frequency will be drooping.
Keep zone	Keep the frequency upper limit.
Return / Reset zone	Cancel the frequency upper limit.

## 3.5 Input Current Control

### Outline

Detect an input current by the CT during the compressor is running, and set the frequency upper limit from such input current. In case of heat pump model, this control is the upper limit control function of the frequency which takes priority of the lower limit of four way valve activating compensation.

### Detail

The frequency control will be made within the following zones.

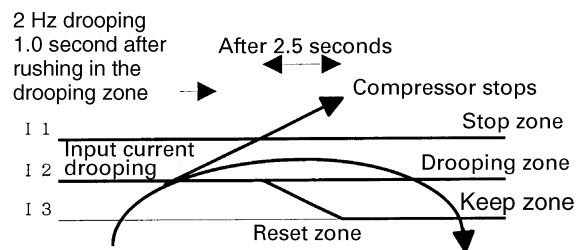

(R4598)

When a "stop current" continues for 2.5 seconds after rushing on the stop zone, the compressor operation stops.

If a "drooping current" is continues for 1.0 second after rushing on the drooping zone, the frequency will be 2 Hz drooping.

Repeating the above drooping continues until the current rushes on the drooping zone without change. In the keep zone, the frequency limit will remain.

In the return / reset zone, the frequency limit will be cancelled.

#### Limitation of current drooping and stop value according to the outdoor air temperature

- In case the operation mode is cooling
  - The current droops when outdoor air temperature becomes higher than a certain level (model by model).
- In case the operation mode is heating (only for heat pump model)
  - The current droops when outdoor air temperature becomes higher than a certain level (model by model).

### 3.6 Freeze-up Protection Control

**Outline** During cooling operation, the signals being sent from the indoor unit allow the operating frequency limitation and then prevent freezing of the indoor heat exchanger.

**Detail** **Conditions for Start Controlling**  
 Judge the controlling start with the indoor heat exchanger temperature after 2 sec from operation start and after 30 sec from changing number of operation room.  
**Control in Each Zone**  
 The zone is determined by the commands from indoor units.  
 In drooping zone, the frequency decreases 2Hz/20 seconds.

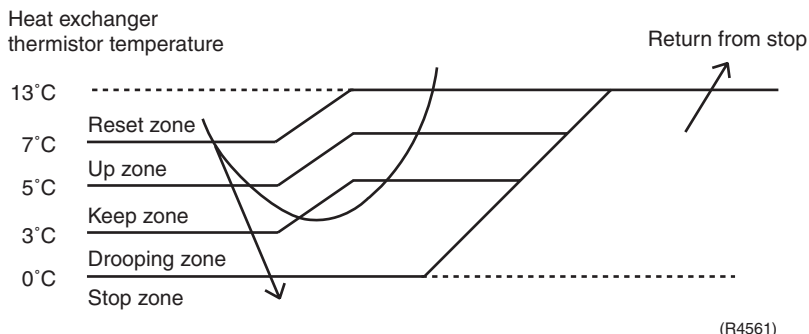

### 3.7 Heating Peak-cut Control

**Outline** **Heat Pump Only**  
 During heating operation, the signals being sent from the indoor unit allow the operating frequency limitation and prevent abnormal high pressure. (The signal from the indoor unit must be divided as follows.)

**Detail** **Conditions for Start Controlling**  
 Judge the controlling start with the indoor heat exchanger temperature after 2 min from operation start and after A sec from changing number of operation room.

	A
When increase	30
When decrease	2

**Control in Each Zone**  
 The maximum value of heat exchange intermediate temperature of each indoor unit controls the following (excluding stopped rooms).  
 In drooping zone, the frequency decreases 6Hz/40 seconds.  
 In up zone, the frequency increases 2Hz/60 seconds.

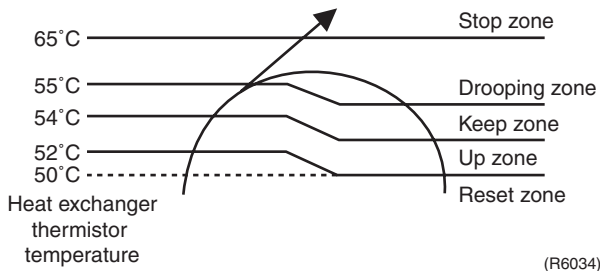

## 3.8 Fan Control

### Outline

Fan control is carried out with following conditions.

1. Fan ON control for electric component cooling fan
2. Fan control when defrosting
3. Fan OFF delay when stopped
4. ON/OFF control when cooling operation
5. Fan control when the number of heating rooms decreases
6. Fan control when forced operation
7. Fan control in indoor / outdoor Quiet operation
8. Fan control for pressure difference upkeep

### Detail

#### Fan OFF Control when Stopped

- ◆ Fan OFF delay for 60 seconds must be made when the compressor is stopped.

#### Fan control when the number of heating room decreases (Only for Heat Pump Model)

When the outdoor air temperature is more than 10°C, the fan must be turned OFF for 30 seconds.

#### Tap Control

On cooling, the fan tap changes L ↔ M when the outdoor air temperature is 8°C, and M ↔ H at 37°C.

On heating, the fan tap changes L ↔ M when the outdoor air temperature is 15°C with min. Hz, and

M ↔ H at 4°C.

For SkyAir models, the fan starts when the outdoor air temperature is more than 37°C on cooling, or less than -4°C on heating, or when 60 seconds have elapsed.

#### Tap Control in Indoor Unit Quiet Operation

1. When Cooling Operation  
When the outdoor air temperature is less than 37°C, the fan tap must be lower.
2. When Heating Operation  
When the outdoor air temperature is more than 4°C, the fan tap must be lower. (only for heat pump model).

## 3.9 Liquid Compression Protection Function 2

### Outline

In order to obtain the dependability of the compressor, the compressor must be stopped according to the conditions of the temperature of the outdoor air and outdoor heat exchanger.

### Detail

#### Heat Pump Model

- ◆ Operation stops depending on the outdoor air temperature.

Compressor operation turns OFF under the conditions that the system is in cooling operation and outdoor air temperature is below -10°C. (Except in forced cooling mode)

#### Cooling Only Model

- ◆ Operation stops depending on the outdoor air temperature.

Compressor operation turns OFF under the condition that outdoor air temperature is below -10°C. (Except in forced cooling mode)

### 3.10 Defrost Control

**Outline**

**Heat Pump Only**

Defrosting is carried out by the cooling cycle (reverse cycle). The defrosting time or outdoor heat exchanger temperature must be more than its fixed value when finishing.

**Detail**

**Conditions for Starting Defrost**

Under the conditions that the system is in heating operation, 6 minutes after the compressor is started and more than 38 minutes of accumulated time pass since the start of the operation or ending the defrosting.

When the outdoor air temperature and the outdoor heat exchanger temperature meet the following condition for 60 seconds, the defrost control starts.

$$A < -(19/256) \times B + (45/64) \times C$$

A: outdoor heat exchanger temperature

B: output frequency

C: outdoor air temperature

**Conditions for Canceling Defrost**

The target heat exchanger temperature as the canceling condition is selected in the range of  $4^{\circ}\text{C} \leq T_e \leq 12^{\circ}\text{C}$  according to the air temperature as the following formula.

$$\text{The target heat exchanger temperature} = -(45/64) \times (\text{ambient temperature}) + 14$$

The defrost operation surely operates in 120 seconds after the start. (A→B)

After then the defrost operation stops at the following conditions.

1. When the heat exchanger temperature reaches the target heat exchanger temperature. (B→C)
2. When 650 seconds have passed after the start even if the heat exchanger temperature does not reaches the target heat exchanger temperature. (C)

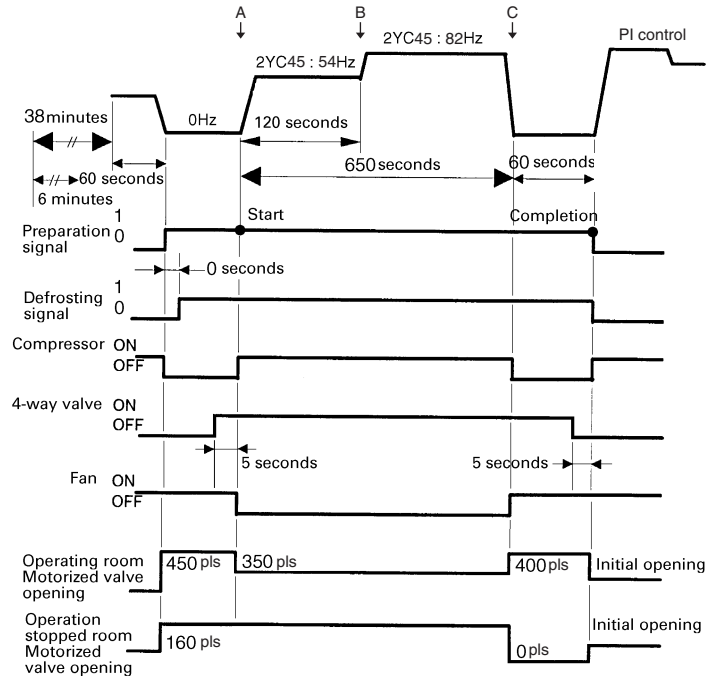

(R6959)



## 3.11 Electronic Expansion Valve Control

---

### Outline

The following items are included in the electronic expansion valve control.

#### **Electronic expansion valve is fully closed**

1. Electronic expansion valve is fully closed when turning on the power.
2. Pressure equalizing control

#### **Room Distribution Control**

1. Gas pipe isothermal control (distribution control in cooling)
2. SC control (only for heat pump model, distribution control in heating)
3. Liquid pipe temperature control (with all ports connected and all rooms being air-conditioned)
4. Liquid pipe temperature control for stopped rooms
5. Dew prevention function for indoor rotor

#### **Open Control**

1. Electronic expansion valve control when starting operation
2. Control when frequency changed
3. Control for defrosting (only for heat pump model)
4. Oil recover control
5. Control when a discharge pipe temperature is abnormally high
6. Control when the discharge pipe thermistor is disconnected
7. Control for indoor unit freeze-up protection

#### **Feedback Control**

1. Discharge pipe temperature control

Detail

The followings are the examples of control which function in each mode by the electronic expansion valve control.

Operation pattern		Gas pipe isothermal control	SC control (only for heat pump model)	Control when frequency changed	Control for abnormally high discharge pipe temperature	Oil recovery control	Indoor freeze-up protection control	Liquid pipe temperature control	Liquid pipe temperature control for stopped rooms	Dew prevention control for indoor rotor
When power is turned ON	Fully closed when power is turned ON	×	×	×	×	×	×	×	×	×
Cooling, 1 room operation	Open control when starting	×	×	×	○	○	○	×	×	×
	(Control of target discharge pipe temperature)	×	×	○	○	○	○	×	×	○
Cooling, 2 rooms operation to Cooling, 4 rooms operation	Control when the operating room is changed	×	×	×	○	○	○	×	×	○
	(Control of target discharge pipe temperature)	○	×	○	○	○	○	×	×	○
Stop	Pressure equalizing control	×	×	×	×	×	×	×	×	×
Heating, 1 room operation (only for heat pump model)	Open control when starting	×	×	×	○	×	×	×	×	×
	(Control of target discharge pipe temperature)	×	○ All rooms ×	○	○	×	×	○ All rooms ○	○ All rooms ×	×
Heating, 2 rooms operation to Heating, 4 rooms operation (only for heat pump model)	Control when the operating room is changed	×	×	×	○	×	×	×	×	×
	(Control of target discharge pipe temperature)	×	○ All rooms ×	○	○	×	×	○ All rooms ○	○ All rooms ×	×
	(Defrost control FD=1) (only for heat pump model)	×	×	×	×	×	×	×	×	×
Stop	Pressure equalizing control	×	×	×	×	×	×	×	×	
Heating operation (only for heat pump model)	Open control when starting	×	×	×	○	×	×	×	×	×
	Control of discharge pipe thermistor disconnection	×	○ All rooms ×	×	×	×	×	○ All rooms ○	○ All rooms ×	×
Stop	Pressure equalizing control	×	×	×	×	×	×	×	×	

(R3056)

### 3.11.1 Fully Closing with Power ON

Initialize the electronic expansion valve when turning on the power, set the opening position and develop pressure equalizing.

The electronic expansion valves are closed further with 720 pulse, and then opened with 150 pulse.

### 3.11.2 Pressure Equalization Control

When the compressor is stopped, open and close the electronic expansion valve and develop pressure equalization.

### 3.11.3 Opening Limit

---

**Outline** Limit a maximum and minimum opening of the electronic expansion valve in the operating room.

---

**Detail**

- ◆ A maximum electronic expansion valve opening in the operating room: 450 pulses
  - ◆ A minimum electronic expansion valve opening in the operating room: 75 pulses
- The electronic expansion valve is fully closed in the room where cooling is stopped and is opened with fixed opening during defrosting.

### 3.11.4 Gas Pipe Isothermal Control During Cooling

When the units are operating in multiple rooms, detect the gas piping temperature and correct the electronic expansion valve opening so that the temperature of the gas pipe in each room becomes identical.

- ◆ When the gas pipe temperature > the average gas pipe temperature,
  - open the electronic expansion valve in that room
- ◆ When the gas pipe temperature < the average gas pipe temperature,
  - close the electronic expansion valve in that room

The temperatures are monitored every 40 seconds.

### 3.11.5 SC Control

**Outline**

**Heat Pump Only**

Detect the temperature of liquid pipe and heat exchanger of the rooms and compensate the electronic expansion valve opening so that the SC of each room becomes the target SC.

- ◆ When the actual SC is > target SC, open the electronic expansion valve of the room.
  - ◆ When the actual SC is < target SC, close the electronic expansion valve of the room.
- 

**Detail**

**Start Functioning Conditions**

After finishing the open control (810 seconds after the beginning of the operation), control all the electronic expansion valve in the operating room.

**Determine Electronic Expansion Valve Opening**

Adjust the electronic expansion valve so that the temperature difference between the maximum heat exchanger temperature of connected room and the temperature of liquid pipe thermistor becomes constant.

### 3.11.6 Starting Operation Control / Changing Operation Room

Control the electronic expansion valve opening when the system is starting or the operating room is changed, and prevent the system to be super heated or moistened.

### 3.11.7 Disconnection of the Discharge Pipe Thermistor

#### Outline

Detect a disconnected discharge pipe thermistor by comparing the discharge pipe temperature with the condensation temperature. If any is disconnected, open the electronic expansion valve according to the outdoor air temperature and the operating frequency and operate for a specified time, and then stop.

After 3 minutes of waiting, restart the unit and check if any is disconnected. If any is disconnected stop the system after operating for a specified time. If the disconnection is detected 4 times in succession, then the system will be down.

#### Detail

##### Detect Disconnection

If a 780-second timer for open control becomes over, and a 9-minute timer for the compressor operation continuation is not counting time, the following adjustment must be made.

1. When the operation mode is cooling  
When the discharge pipe temperature is lower than the outdoor heat exchanger temperature, the discharge pipe thermistor disconnection must be ascertained.
2. When the operation mode is heating (only for heat pump model)  
When the discharge pipe temperature is lower than the max temperature of operating room heat exchanger, the discharge pipe thermistor disconnection must be ascertained.

##### Adjustment when the thermistor is disconnected

When compressor stop repeats specified time, the system should be down.

### 3.11.8 Control when frequency is changed

When the target pipe temperature control is active, if the target frequency is changed for a specified value in a certain time period, cancel the target discharge pipe temperature control and change the opening of the target electronic expansion valve according to the shift.

### 3.11.9 High Temperature of the Discharge Pipe

When the compressor is operating, if the discharge pipe temperature exceeds a certain value, open the electronic expansion valve and remove the refrigerant to the low pressure side and lower discharge temperature.

### 3.11.10 Oil Recovery Function

#### Outline

The electronic expansion valve opening in the cooling stopped room must be set as to open for a certain time at a specified interval so that the oil in the cooling stopped room may not be accumulated.

#### Detail

During cooling operation, every 1 hour continuous operation, the electronic expansion valves in the operation stopped room must be opened by 80 pulses for specified time.

### 3.11.11 Target Discharge Pipe Temperature Control

Obtain the target discharge pipe temperature from the indoor and outdoor heat exchange temperature, and adjust the electronic expansion valve opening so that the actual discharge pipe temperature become close to that temperature. (Indirect SH control using the discharge pipe temperature)

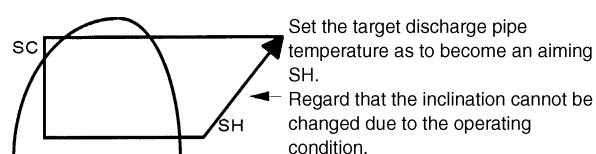

(R1389)

Determine a correction value of the electronic expansion valve compensation and drive it according to the deflection of the target discharge temperature and actual discharge temperature, and the discharge temperature variation by the 20 sec.

## 3.12 Malfunctions

### 3.12.1 Sensor Malfunction Detection

Sensor malfunction may occur either in the thermistor or current transformer (CT) system.

#### Relating to Thermistor Malfunction

1. Outdoor heat exchanger thermistor
2. Discharge pipe thermistor
3. Fin thermistor
4. Gas pipe thermistor
5. Outdoor air temperature thermistor
6. Liquid pipe thermistor

#### Relating to CT Malfunction

When the output frequency is more than 55 Hz and the input current is less than 0.5A, carry out abnormal adjustment.

### 3.12.2 Detection of Overload and Over Current

#### Outline

In order to protect the inverter, detect an excessive output current, and for protecting compressor, monitor the OL operation.

#### Detail

- ◆ If the OL (compressor head) temperature exceeds 130°C (2YC45), the compressor gets interrupted.

### 3.12.3 Insufficient Gas Control

#### Outline

If a power consumption is below the specified value in which the frequency is higher than the specified frequency, it must be regarded as gas insufficient. In addition to such conventional function, if the discharge temperature is higher than the target discharge pipe temperature, and more than the specified temperature, and the electronic expansion valve is fully open (450 pulses) more than the specified time, it is considered as an insufficient gas.

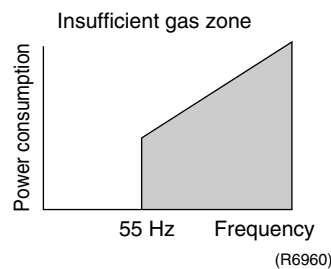

With the conventional function, a power consumption is weak comparing with that in the normal operation when gas is insufficient, and gas insufficiency is detected by checking a power consumption.

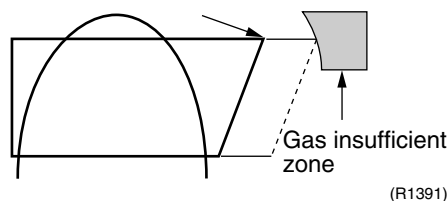

When operating with insufficient gas, although the rise of discharge pipe temperature is great and the electronic expansion valve is open, it is presumed as an insufficient gas if the discharge pipe temperature is higher than the target discharge pipe temperature.



Refer to “Insufficient Gas” on page 251 for detail.

**Detail****Judgment by Input Current**

When an output frequency is exceeds 55 Hz and the input current is less than specified value, the adjustment is made for insufficient gas.

**Judgment by Discharge Pipe Temperature**

When discharge pipe temperature is 20°C higher than target value and the electronic expansion valve opening is 450 plus (max.), the adjustment is made for insufficient gas.

**3.12.4 Preventing Indoor Freezing**

During cooling, if the heat exchanger temperature in the operation stopped room becomes below the specified temperature for the specified time, open the electronic expansion valve in the operation stopped room as specified, and carry out the fully closed operation. After this, if freezing abnormality occurs more than specified time, the system shall be down as the system abnormality.

**3.13 Forced Operation Mode****Outline**

Forced operating mode includes functions such as; forced cooling, forced heating, incorrect wiring, incorrect piping check.

Operating mode must be selected by operating the forced operation switch (SW1 on service PCB).

**Detail****Forced Cooling, Forced Heating (Only for Heat Pump Model)**

Item	Forced Cooling	Forced Heating
Forced operation allowing conditions	1) The indoor unit is not abnormal, but the indoor unit which is not in the freezing prohibiting zone is present in more than 1 room.	1) The indoor unit is not abnormal. The indoor unit which is not in the peak-cut prohibited zone is present in more than 1 room.
	2) The outdoor unit is not abnormal and not in the 3-minute standby mode.	←
	3) The operating mode of the outdoor unit is the stop mode.	←
	4) The slide selection switch of the forced operation is the cooling mode. The forced operation is allowed when the above "and" conditions are met.	4) The slide selection switch of the forced operation is the heating mode. The forced operation is allowed when the above "and" conditions are met.
Starting / adjustment	If the forced operation switch is pressed as the above conditions are met.	←
1) Determine operating room	All rooms	One of the available units runs. Priority is given to the youngest number's room in alphabetical order. (A > B > C > D)
2) Command frequency	◆ 2YC45: 42 Hz	◆ 2YC45: 37 Hz (Outdoor air temp:0°C)
3) Electronic expansion valve opening	It depends on the capacity of the operating indoor unit.	←
4) Outdoor unit adjustment	Compressor is in operation.	←
5) Indoor unit adjustment	The command of forced operation is transmitted to the indoor unit.	←
End	1) When the forced operation switch is pressed again.	←
	2) The operation is to end automatically after 15 min.	←
Others	The protect functions are prior to all others in the forced operation.	←

## 3.14 Wiring-Error Check

### Outline

The convenient Wiring Error Check function is designed for the microcomputer to correct wiring errors itself.

If local wiring is unclear in the case of buried piping, for example, just press the wiring error check switch that is behind the right-hand panel of the outdoor unit. Even if the connections for Room A and Room B are confused, the system may run without a hassle. Note that this check function does not work in the following cases.

- ◆ For about 1 minute after the power is turned on (during initial setup).
- ◆ For 3-minute standby period after the compressor has stopped.
- ◆ When the outdoor air temperature is below 5°C.
- ◆ If the indoor unit is in trouble (also in case of all-room transmission failure).

When the piping and wiring are perfect, there is no need to use this function.

### Operation

1. Remove the 2 screws from the service panel (right side panel) and detach the panel.
2. Press the wiring error check switch on the service monitor PCB, and the wiring error check function is activated.
3. In about 10-15 minutes, the checking will end automatically.
4. When the checking is over, the service monitor LED indicators start flashing.

LED	1	2	3	4	Judgment
Status	All flashing at once				Self-correction impossible
	Flashing one after another				Self-correction complete

Self-correction complete...The LED indicators 1 ~ 4 flash one after another.

Self-correction impossible...The LED indicators flash all at the same time.

- ◆ Transmission failure occurs at any of the indoor units.
- ◆ The indoor unit heat exchanger thermistor is disconnected.
- ◆ An indoor unit is in trouble (if a trouble occurs during the wiring error checking).

Emergency stop...Any of the LED indicators 1 ~ 4 stays on.



#### Note:

1. After self-correction completed, LED 3 and LED 4 are not displayed for 2 rooms, LED 4 is not displayed for 3 rooms.
2. It takes about 10-15 minutes (after pressing the wiring error check switch) to complete the checking. (Wrong wiring between the upper and lower units cannot be self-corrected.)
3. Wrongly connected liquid and gas pipes cannot be self-corrected either. Be sure to make the liquid pipe and the gas pipe in pairs.
4. To forced-terminate the wiring error check procedure halfway, press the wiring error check switch again.  
In this case, the microcomputer's memory gets back to its initial status (Room A wiring → Port A piping, Room B wiring → Port B piping).
5. In replacing the outdoor unit PCB, be sure to use this function.
6. Make the power slide setting after doing the wiring error checking. (Otherwise, if the wiring is reversed, the air-conditioners being connected are set up in the reverse way.)

### Basic Knowledge

- ◆ This function works in this way. Refrigerant is let flow from Port A and on. The temperatures of the indoor unit heat exchanger thermistors are detected one by one to check up the matching between the pipes and wiring.
- ◆ With this function on, freezing (crackling) noise may be heard from the indoor unit. This is not a problem. (This is because the heat exchange temperature is made to drop below 0°C in order to increase the detection accuracy.)
- ◆ The indoor fan is made to turn on and off at the same time.

**Checking the current setting data on the microcomputer memory**

Those data can be checked by looking at the service monitor LED indicators, when the wiring error checking is over, during forced operation, at the stop of the system. The LED indicators stop flashing when the forced operation is over.  
 LED1...Room A wiring, LED2...Room B wiring  
 1st flashing LED...Port A piping, 2nd flashing LED...Port B piping  
 The first stay-on LED means the room that is connected with Port A. The next stay-on LED means the one connected with Port B.

**Example**

Let's suppose the LED indicators are flashing as follows.

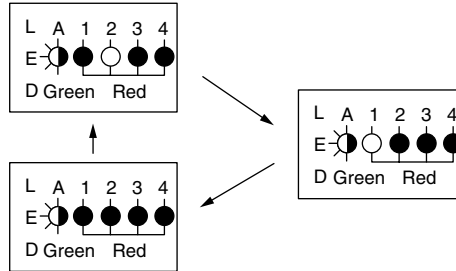

The above means that Port A is connected with Room B and Port B with Room A (or self-corrected this way.)

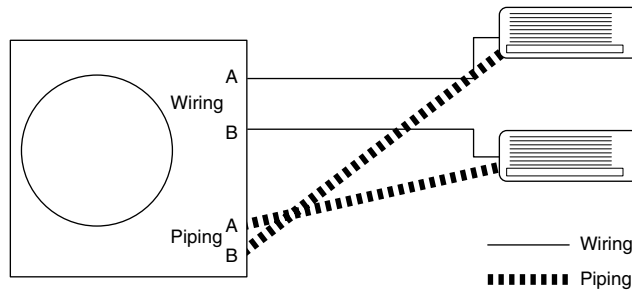



## 3.15 Additional Function

### 3.15.1 Priority Room Setting

Electronic expansion valves are controlled to provide the unit designated as the priority room with the capacity of other room units.

(Distribution of capacity: Priority room unit ---  $\Delta D$  Max., other room units ---  $\Delta D - \alpha$ )

- ◆ Setting method  
Turn off the circuit breaker before changing the setting.  
Only one room can be set as the priority room.
- ◆ Control start conditions  
Priority room setting is made.  
AND  
“Powerful” signal from the priority room unit is received.



**Note:** The operation mode of the priority room unit has precedence.

- ◆ Cancellation of control  
The control function is canceled when the “Powerful” operation mode is switched off or 20 minutes elapse after “Powerful Operation” started.

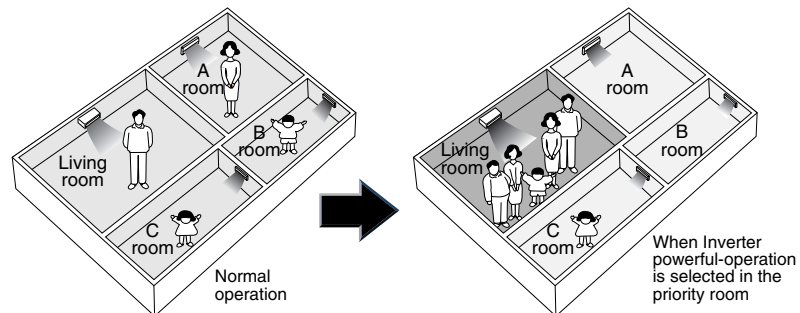

**The prioritised room will be heated/cooled much more quickly**

(R1396)

### 3.15.2 POWERFUL Operation Mode

Compressor operating frequency is increased to PI Max. (Max. Hz of operating room unit  $\Sigma S$ ) and outdoor unit airflow rate is increased.

### 3.15.3 Cooling / Heating Mode Lock

Use the S15 connector to set the unit to only cool or heat.

Setting to only heat (H): Short-circuit pins 1 and 3 of the connector <S15>.

Setting to only cool (C): short-circuit pins 3 and 5 of the connector <S15>.

The following specifications apply to the connector housing and pins.

JST products Housing: VHR-5N

Pin: SVH-21T-1, 1

Note that forced operation is also possible in COOL / HEAT mode.

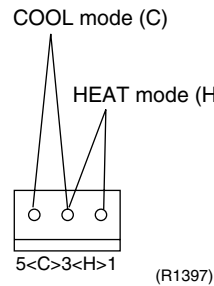

### 3.15.4 ECONO-mode-proof Setting

#### Outline

When installing in hotels, you can make ECONO mode ineffective on the outdoor unit.

#### Operation

The ECONO mode can be switched over between "effective" and "ineffective" by pressing the forced operation switch (SW1) and wiring error check switch (SW3) at the same time and holding them for 5 seconds while the compressor is stopped. The LEDs are lit in turn for 15 seconds to show the ECONO mode status.

The factory setting is "effective".

	effective → ineffective	ineffective → effective
LED flashing order	4 → 3 → 2 → 1	1 → 2 → 3 → 4



# Part 5

# Operation Manual

1. System Configuration.....	98
1.1 Operation Instructions .....	98
2. Instruction.....	99
2.1 FTXG-E, CTXG-E, FTK(X)S-F, FDK(X)S-C(E), FLK(X)S-B Series.....	99
2.2 FTXS-G, FVXS-F Series .....	149
2.3 FHQ-B Series .....	191

# 1. System Configuration

## 1.1 Operation Instructions

After the installation and test operation of the room air conditioner have been completed, it should be operated and handled as described below. Every user would like to know the correct method of operation of the room air conditioner, to check if it is capable of cooling (or heating) well, and to know a clever method of using it.

In order to meet this expectation of the users, giving sufficient explanations taking enough time can be said to reduce about 80% of the requests for servicing. However good the installation work is and however good the functions are, the customer may blame either the room air conditioner or its installation work because of improper handling. The installation work and handing over of the unit can only be considered to have been completed when its handling has been explained to the user without using technical terms but giving full knowledge of the equipment.

## 2. Instruction

### 2.1 FTXG-E, CTXG-E, FTK(X)S-F, FDK(X)S-C(E), FLK(X)S-B Series

#### 2.1.1 Manual Contents and Reference Page

Model Series	Wall Mounted Type	
	FTXG25/35E CTXG50E	FTK(X)S60/71F
<b>Read Before Operation</b>		
Safety Precautions	100	100
Names of Parts	102	105
Preparation Before Operation ★1	114	114
<b>Operation</b>		
AUTO, DRY, COOL, HEAT, FAN Operation ★1	117	117
Adjusting the Airflow Direction	119	121
POWERFUL Operation ★1	125	125
OUTDOOR UNIT QUIET Operation ★1	126	126
ECONO Operation	—	—
HOME LEAVE Operation ★2	—	127
INTELLIGENT EYE Operation ★1	129	129
TIMER Operation ★1	131	131
Note for Multi System	133	133
<b>Care</b>		
Care and Cleaning	135	138
<b>Trouble Shooting</b>		
Trouble Shooting	146	146
Drawing No.	3P194513-2B	3P190111-1B

Model Series	Duct Connected Type	Floor/Ceiling Suspended Dual Type
	FDK(X)S50/60C FDK(X)S25/35E	FLK(X)S25/35/50/60B
<b>Read Before Operation</b>		
Safety Precautions	100	100
Names of Parts	108	111
Preparation Before Operation ★1	114	114
<b>Operation</b>		
AUTO, DRY, COOL, HEAT, FAN Operation ★1	117	117
Adjusting the Airflow Direction	—	123
POWERFUL Operation ★	125	125
OUTDOOR UNIT QUIET Operation ★1	126	126
ECONO Operation	—	—
HOME LEAVE Operation ★2	127	127
INTELLIGENT EYE Operation	—	—
TIMER Operation ★	131	131
Note for Multi System	133	133
<b>Care</b>		
Care and Cleaning	141	143
<b>Trouble Shooting</b>		
Trouble Shooting	146	146
Drawing No.	3P196326-9B	3P194444-5B



★1 : Illustrations are for wall mounted type FTXG25/35E as representative.





★2 : Illustrations are for duct connected type FDK(X)S50/60C as representative.

## 2.1.2 Safety Precautions



# Safety precautions

- Keep this manual where the operator can easily find them.
- Read this manual attentively before starting up the unit.
- For safety reason the operator must read the following cautions carefully.
- This manual classifies precautions into WARNING and CAUTION. Be sure to follow all precautions below: they are all important for ensuring safety.

 <b>WARNING</b> If you do not follow these instructions exactly, the unit may cause property damage, personal injury or loss of life.	 <b>CAUTION</b> If you do not follow these instructions exactly, the unit may cause minor or moderate property damage or personal injury.
---	--



- |  |  |
|--|--|
| <ul style="list-style-type: none"> <li> Never do.</li> <li> Be sure to earth the air conditioner.</li> <li> Never touch the air conditioner (including the remote controller) with a wet hand.</li> </ul> | <ul style="list-style-type: none"> <li> Be sure to follow the instructions.</li> <li> Never cause the air conditioner (including the remote controller) to get wet.</li> </ul> |
|--|--|

### **WARNING**

- In order to avoid fire, explosion or injury, do not operate the unit when harmful, among which flammable or corrosive gases, are detected near the unit. 
  - It is not good for health to expose your body to the air flow for a long time.
  - Do not put a finger, a rod or other objects into the air outlet or inlet. As the fan is rotating at a high speed, it will cause injury.
  - Do not attempt to repair, relocate, modify or reinstall the air conditioner by yourself. Incorrect work will cause electric shocks, fire etc.  
For repairs and reinstallation, consult your Daikin dealer for advice and information.
  - Do not insert fingers, poles, or other objects into the moving parts of the front panel or the outlet vent panel.
- 
- The refrigerant used in the air conditioner is safe. Although leaks should not occur, if for some reason any refrigerant happens to leak into the room, make sure it does not come in contact with any flame as of gas heaters, kerosene heaters or gas range. 
  - If the air conditioner is not cooling (heating) properly, the refrigerant may be leaking, so call your dealer. When carrying out repairs accompanying adding refrigerant, check the content of the repairs with our service staff.
  - Do not attempt to install the air conditioner by your self. Incorrect work will result in water leakage, electric shocks or fire. For installation, consult the dealer or a qualified technician.
  - In order to avoid electric shock, fire or injury, if you detect any abnormally such as smell of fire, stop the operation and turn off the breaker. And call your dealer for instructions.
  - Depending on the environment, an earth leakage breaker must be installed. Lack of an earth leakage breaker may result in electric shocks or fire.
- 
- The air conditioner must be earthed. Incomplete earthing may result in electric shocks. Do not connect the earth line to a gas pipe, water pipe, lightning rod, or a telephone earth line. 

### **CAUTION**

- In order to avoid any quality deterioration, do not use the unit for cooling precision instruments, food, plants, animals or works of art. 
- Never expose little children, plants or animals directly to the air flow

- Do not place appliances which produce open fire in places exposed to the air flow from the unit or under the indoor unit. It may cause incomplete combustion or deformation of the unit due to the heat.
  - Do not block air inlets nor outlets. Impaired air flow may result in insufficient performance or trouble.
  - Do not stand or sit on the outdoor unit. Do not place any object on the unit to avoid injury, do not remove the fan guard.
  - Do not place anything under the indoor or outdoor unit that must be kept away from moisture. In certain conditions, moisture in the air may condense and drip.
  - After a long use, check the unit stand and fittings for damage.
  - Do not touch the air inlet and aluminum fins of outdoor unit. It may cause injury.
  - The appliance is not intended for use by young children or infirm persons without supervision.
  - Young children should be supervised to ensure that they do not play with the appliance.
- 
- To avoid oxygen deficiency, ventilate the room sufficiently if equipment with burner is used together with the air conditioner. 
  - Before cleaning, be sure to stop the operation, turn the breaker off or pull out the supply cord.
  - Do not connect the air conditioner to a power supply different from the one as specified. It may cause trouble or fire.
  - Arrange the drain hose to ensure smooth drainage. Incomplete draining may cause wetting of the building, furniture etc.
  - Do not place objects in direct proximity of the outdoor unit and do not let leaves and other debris accumulate around the unit.  
Leaves are a hotbed for small animals which can enter the unit. Once in the unit, such animals can cause malfunctions, smoke or fire when making contact with electrical parts.
- 
- Do not operate the air conditioner with wet hands. 
- 
- Do not wash the indoor unit with excessive water, only use a slightly wet cloth.
  - Do not place things such as vessels containing water or anything else on top of the unit. Water may penetrate into the unit and degrade electrical insulations, resulting in an electric shock. 

### Installation site.

- To install the air conditioner in the following types of environments, consult the dealer.
  - Places with an oily ambient or where steam or soot occurs.
  - Salty environment such as coastal areas.
  - Places where sulfide gas occurs such as hot springs.
  - Places where snow may block the outdoor unit.

The drain from the outdoor unit must be discharged to a place of good drainage.

### Consider nuisance to your neighbours from noises.

- For installation, choose a place as described below.
  - A place solid enough to bear the weight of the unit which does not amplify the operation noise or vibration.
  - A place from where the air discharged from the outdoor unit or the operation noise will not annoy your neighbours.

### Electrical work.

- For power supply, be sure to use a separate power circuit dedicated to the air conditioner.

### System relocation.

- Relocating the air conditioner requires specialized knowledge and skills. Please consult the dealer if relocation is necessary for moving or remodeling.



### 2.1.3 Name of Parts

FTXG 25/35 E, CTXG 50 E

## Names of parts

### ■ Indoor Unit

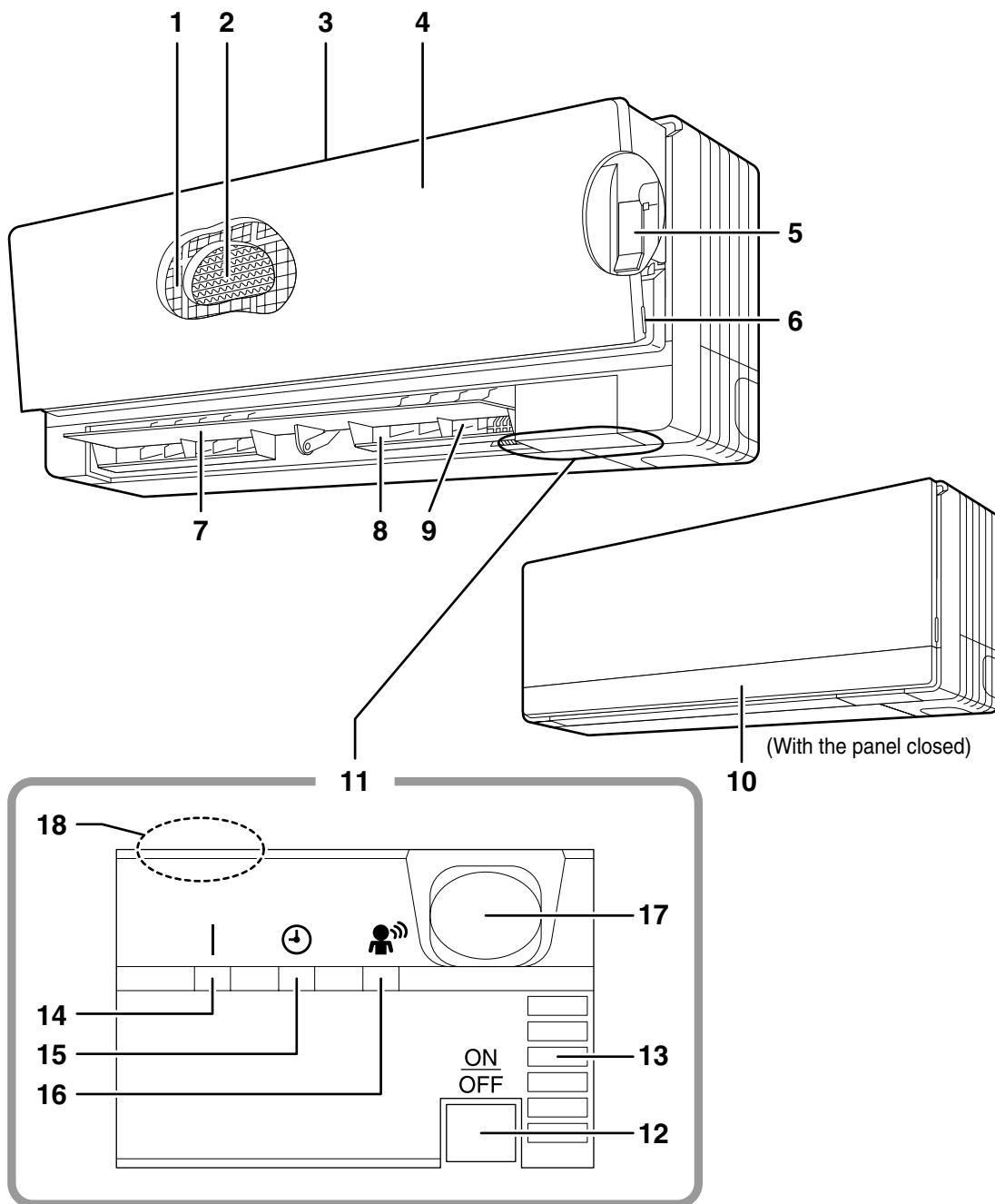

## ■ Outdoor Unit

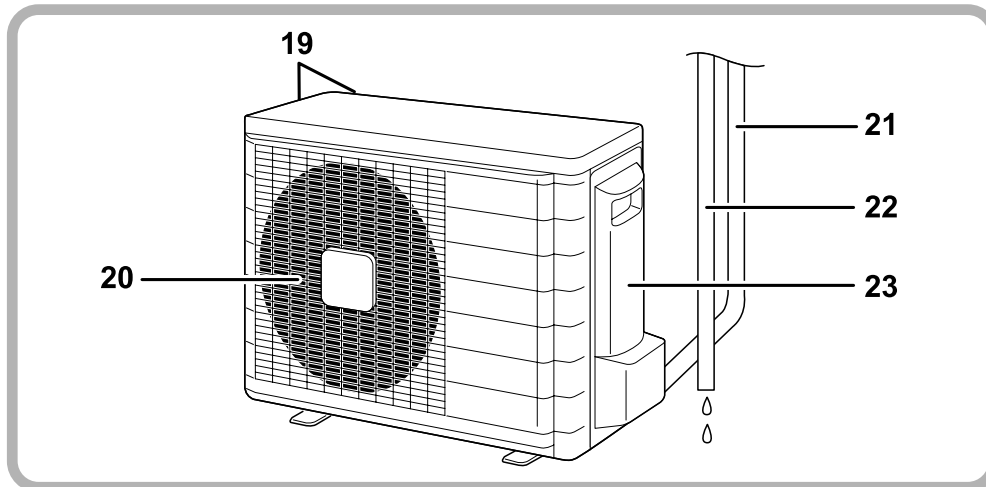

## ■ Indoor Unit

1. Air filter
2. Titanium Apatite Photocatalytic Air-Purifying Filter:
  - These filters are attached to the inside of the air filters.
3. Air inlet
4. Front panel
5. Supporting plate:
  - The supporting plate is used to support the front panel during maintenance.
6. Panel tab
7. Flap (horizontal blade)
8. Air outlet
9. Louvers (vertical blades):
  - The louvers are inside of the air outlet.
10. Outlet vent panel
11. Display
12. Indoor Unit ON/OFF switch:
  - Push this switch once to start operation.
  - Push once again to stop it.

- The operation mode refers to the following table.

	Mode	Temperature setting	Air flow rate
F(C)TXG	AUTO	25°C	AUTO

- This switch is useful when the remote controller is missing.
13. Room temperature sensor:
    - It senses the air temperature around the unit.
  14. Operation lamp (green)
  15. TIMER lamp (yellow)
  16. INTELLIGENT EYE lamp (green)
  17. INTELLIGENT EYE sensor:
    - It detects the movements of people and automatically switches between normal operation and energy saving operation.
  18. Signal receiver:
    - It receives signals from the remote controller.
    - When the unit receives a signal, you will hear a short beep.
      - Operation start .....beep-beep
      - Settings changed.....beep
      - Operation stop .....beeeeeeep

## ■ Outdoor Unit

19. Air inlet: (Back and side)
20. Air outlet
21. Refrigerant piping and inter-unit cable
22. Drain hose
23. Earth terminal:
  - It is inside of this cover.

Appearance of the outdoor unit may differ from some models.

## ■ Remote Controller

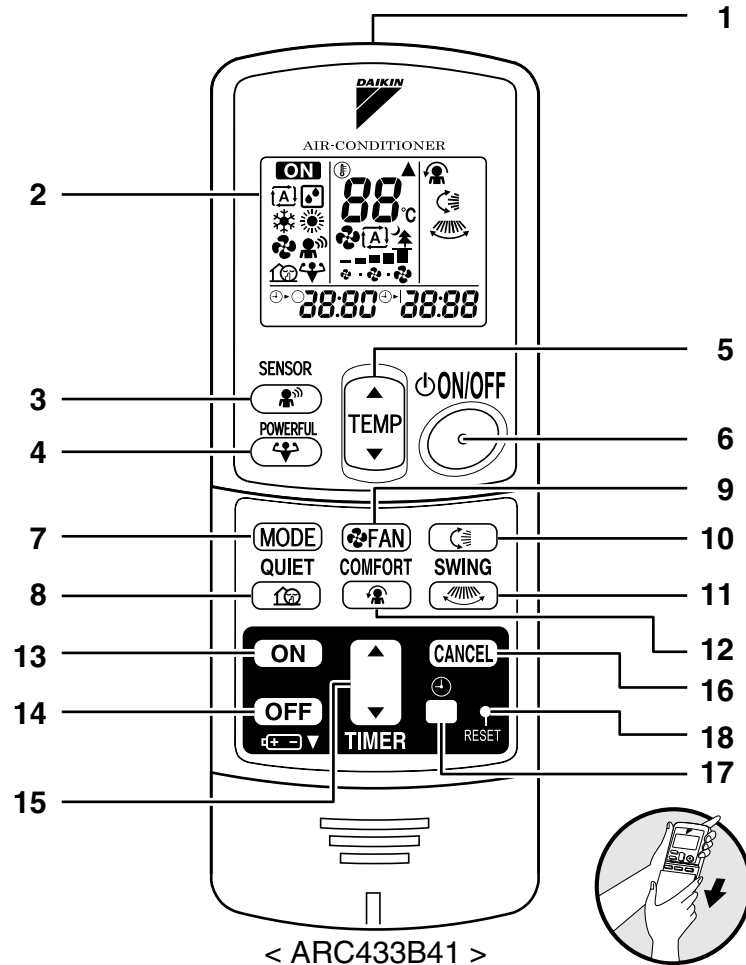

- |   |  |
|---|--|
| <p><b>1. Signal transmitter:</b></p> <ul style="list-style-type: none"> <li>• It sends signals to the indoor unit.</li> </ul> <p><b>2. Display:</b></p> <ul style="list-style-type: none"> <li>• It displays the current settings.<br/>(In this illustration, each section is shown with all its displays ON for the purpose of explanation.)</li> </ul> <p><b>3. SENSOR button:</b> INTELLIGENT EYE operation</p> <p><b>4. POWERFUL button:</b> POWERFUL operation</p> <p><b>5. TEMPERATURE adjustment buttons:</b></p> <ul style="list-style-type: none"> <li>• It changes the temperature setting.</li> </ul> <p><b>6. ON/OFF button:</b></p> <ul style="list-style-type: none"> <li>• Press this button once to start operation.<br/>Press once again to stop it.</li> </ul> <p><b>7. MODE selector button:</b></p> <ul style="list-style-type: none"> <li>• It selects the operation mode.<br/>(AUTO/DRY/COOL/HEAT/FAN)</li> </ul> | <p><b>8. QUIET button:</b> OUTDOOR UNIT QUIET operation</p> <p><b>9. FAN setting button:</b></p> <ul style="list-style-type: none"> <li>• It selects the air flow rate setting.</li> </ul> <p><b>10. SWING button:</b></p> <ul style="list-style-type: none"> <li>• Flap (Horizontal blade)</li> </ul> <p><b>11. SWING button:</b></p> <ul style="list-style-type: none"> <li>• Louvers (Vertical blades)</li> </ul> <p><b>12. COMFORT AIRFLOW mode button</b></p> <p><b>13. ON TIMER button</b></p> <p><b>14. OFF TIMER button</b></p> <p><b>15. TIMER Setting button:</b></p> <ul style="list-style-type: none"> <li>• It changes the time setting.</li> </ul> <p><b>16. TIMER CANCEL button:</b></p> <ul style="list-style-type: none"> <li>• It cancels the timer setting.</li> </ul> <p><b>17. CLOCK button</b></p> <p><b>18. RESET button:</b></p> <ul style="list-style-type: none"> <li>• Restart the unit if it freezes.</li> </ul> |
|---|--|

FTK(X)S 60/71 F

# Names of parts

## ■ Indoor Unit

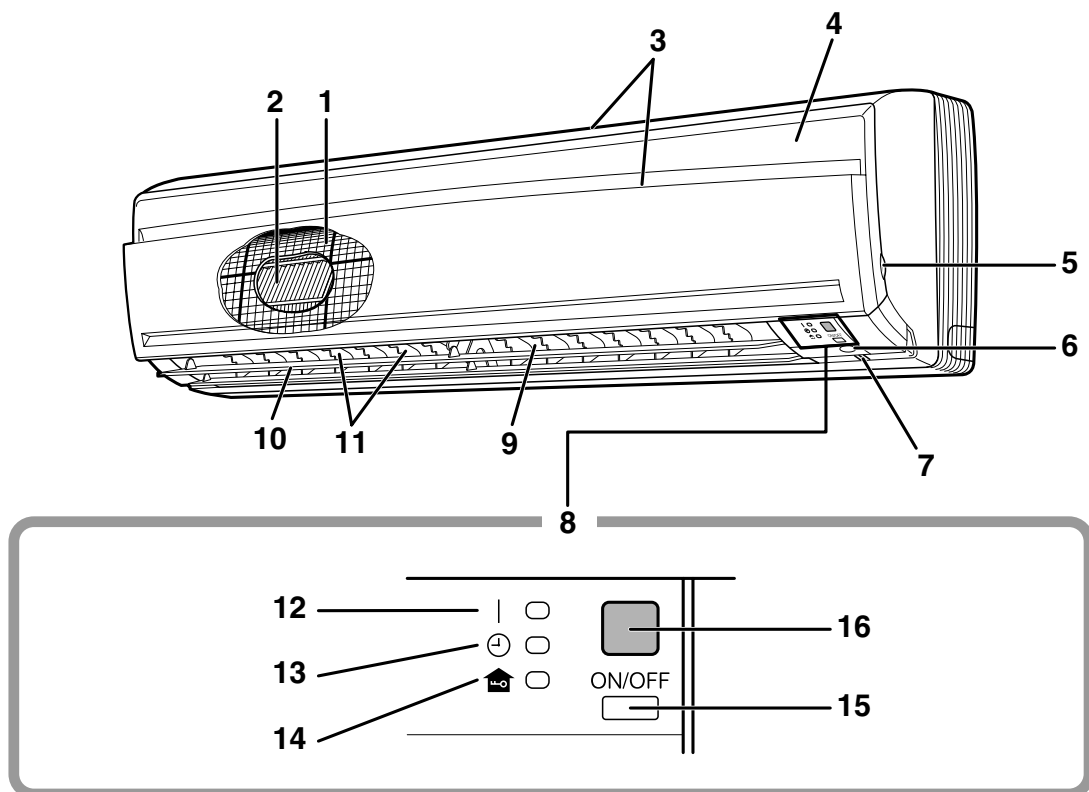

## Outdoor Unit

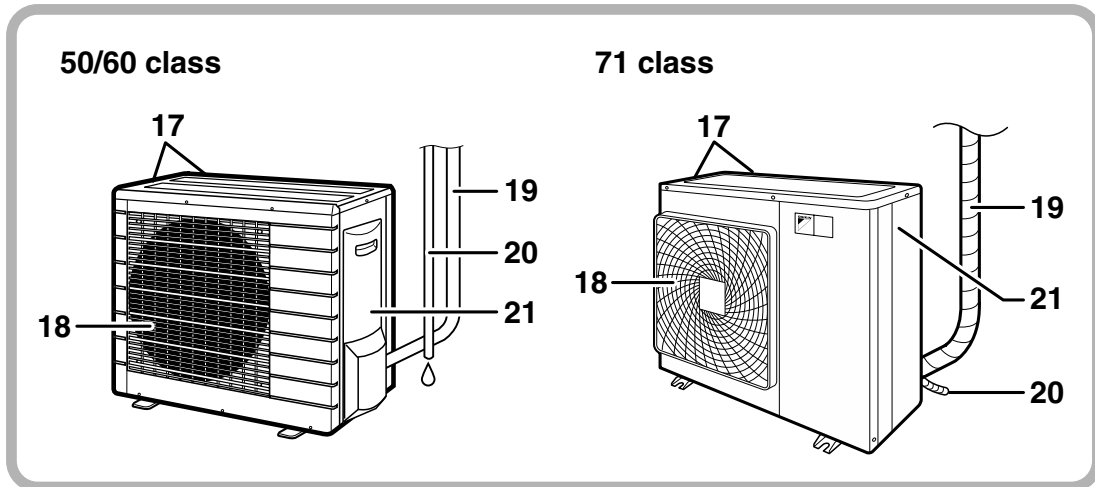

### Indoor Unit

1. Air filter
2. Titanium Apatite Photocatalytic Air-Purifying Filter
3. Air inlet
4. Front panel
5. Panel tab
6. INTELLIGENT EYE sensor:
  - It detects the movements of people and automatically switches between normal operation and energy saving operation.
7. Room temperature sensor:
  - It senses the air temperature around the unit.
8. Display
9. Air outlet
10. Flap (horizontal blade)
11. Louvers (vertical blades):
  - The Louvers are inside of the air outlet.
12. Operation lamp (green)
13. TIMER lamp (yellow)

14. HOME LEAVE lamp (red):
  - Lights up when you use HOME LEAVE Operation.
15. Indoor Unit ON/OFF switch:
  - Push this switch once to start operation. Push once again to stop it.
  - The operation mode refer to the following table.

	Mode	Temperature setting	Air flow rate
FTKS	COOL	22°C	AUTO
FTXS	AUTO	25°C	AUTO

- This switch is useful when the remote controller is missing.
- 16. Signal receiver:
  - It receives signals from the remote controller.
  - When the unit receives a signal, you will hear a short beep.
    - Operation start .....beep-beep
    - Settings changed.....beep
    - Operation stop .....beeeeeeep

### Outdoor Unit

17. Air inlet: (Back and side)
18. Air outlet
19. Refrigerant piping and inter-unit cable
20. Drain hose
21. Earth terminal:
  - It is inside of this cover.

Appearance of the outdoor unit may differ from some models.

## ■ Remote Controller

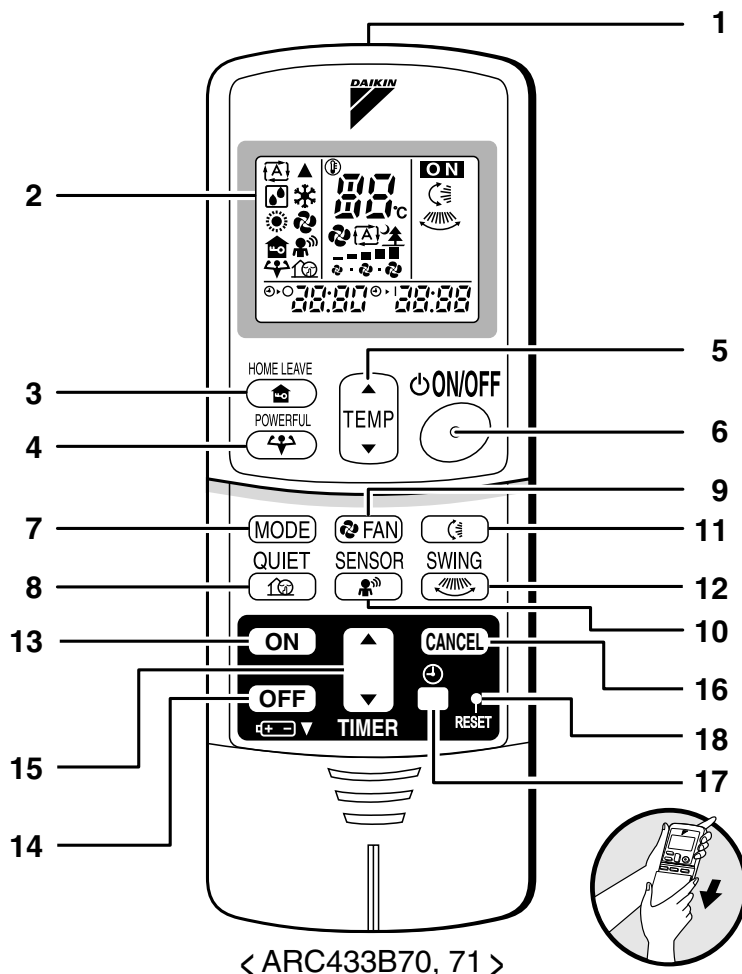

- 1. Signal transmitter:**
  - It sends signals to the indoor unit.
- 2. Display:**
  - It displays the current settings.  
(In this illustration, each section is shown with all its displays ON for the purpose of explanation.)
- 3. HOME LEAVE button:**  
HOME LEAVE operation
- 4. POWERFUL button:**  
POWERFUL operation
- 5. TEMPERATURE adjustment buttons:**
  - It changes the temperature setting.
- 6. ON/OFF button:**
  - Press this button once to start operation.  
Press once again to stop it.
- 7. MODE selector button:**
  - It selects the operation mode.  
(AUTO/DRY/COOL/HEAT/FAN)
- 8. QUIET button:** OUTDOOR UNIT QUIET operation
- 9. FAN setting button:**
  - It selects the air flow rate setting.
- 10. SENSOR button:** INTELLIGENT EYE operation
- 11. SWING button:**
  - Flap (Horizontal blade)
- 12. SWING button:**
  - Louver (Vertical blades)
- 13. ON TIMER button**
- 14. OFF TIMER button**
- 15. TIMER Setting button:**
  - It changes the time setting.
- 16. TIMER CANCEL button:**
  - It cancels the timer setting.
- 17. CLOCK button**
- 18. RESET button:**
  - Restart the unit if it freezes.
  - Use a thin object to push.

FDK(X)S 50/60 C, FDK(X)S 25/35 E

# Names of parts

## ■ Indoor Unit

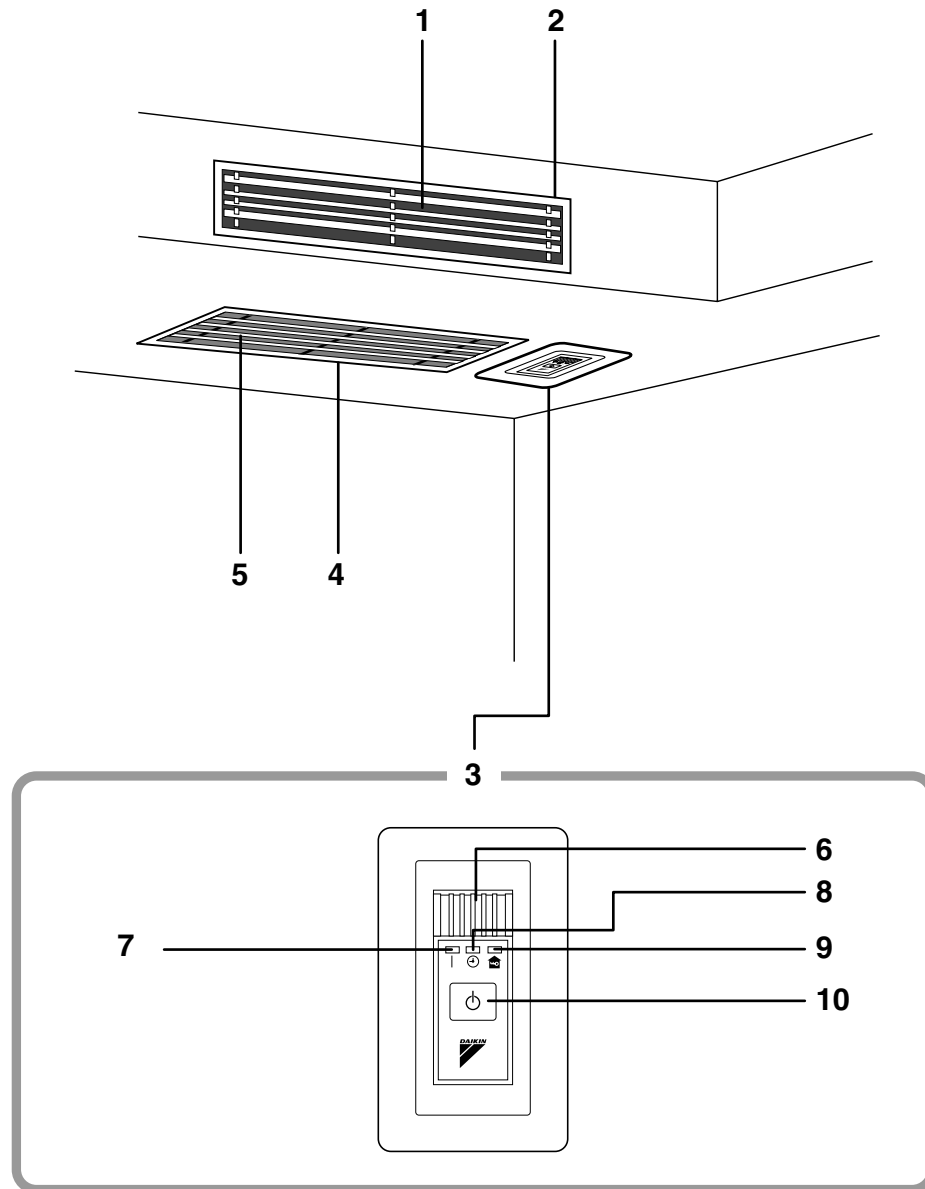

## ■ Outdoor Unit

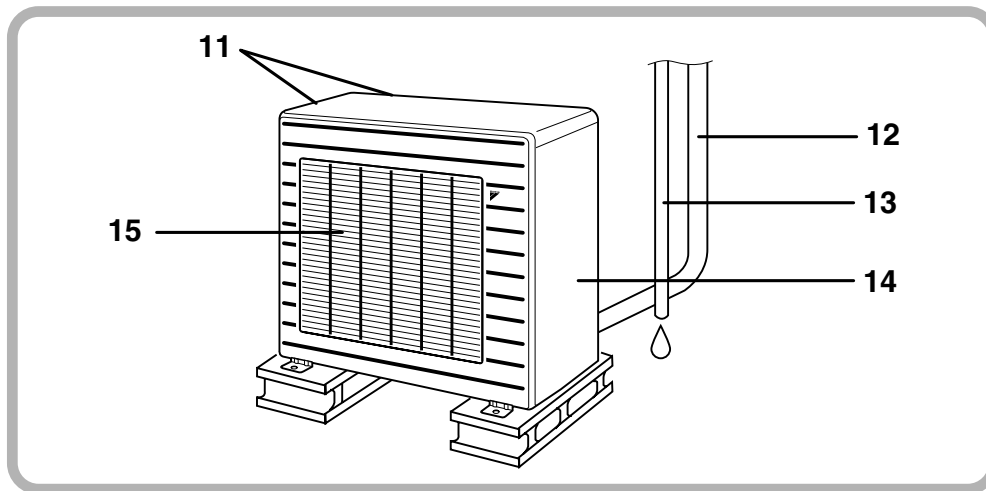

## ■ Indoor Unit

### 1. Air outlet

### 2. Air outlet grille: (Field supply)

- Appearance of the Air outlet grille and Air inlet grille may differ with some models.

### 3. Display, Control panel

### 4. Suction grille: (Option)

- Appearance of the suction grille and Air inlet grille may differ with some models.

### 5. Air inlet

### 6. Room temperature sensor:

- It senses the air temperature around the unit.

### 7. Operation lamp (green)

### 8. TIMER lamp (yellow)

### 9. HOME LEAVE lamp (red):

- Lights up when you use HOME LEAVE operation.

### 10. Indoor Unit ON/OFF switch:

- Push this switch once to start operation. Push once again to stop it.
- This switch is useful when the remote controller is missing.

- The operation mode refers to the following table.

	Mode	Temperature setting	Air flow rate
F(C)DKS	COOL	22°C	AUTO
F(C)DXS	AUTO	25°C	AUTO

## ■ Outdoor Unit

### 11. Air inlet: (Back and side)

### 12. Refrigerant piping and inter-unit cable

### 13. Drain hose

### 14. Earth terminal:

- It is inside of this cover.

### 15. Air outlet

Appearance of the outdoor unit may differ from some models.



## ■ Remote Controller

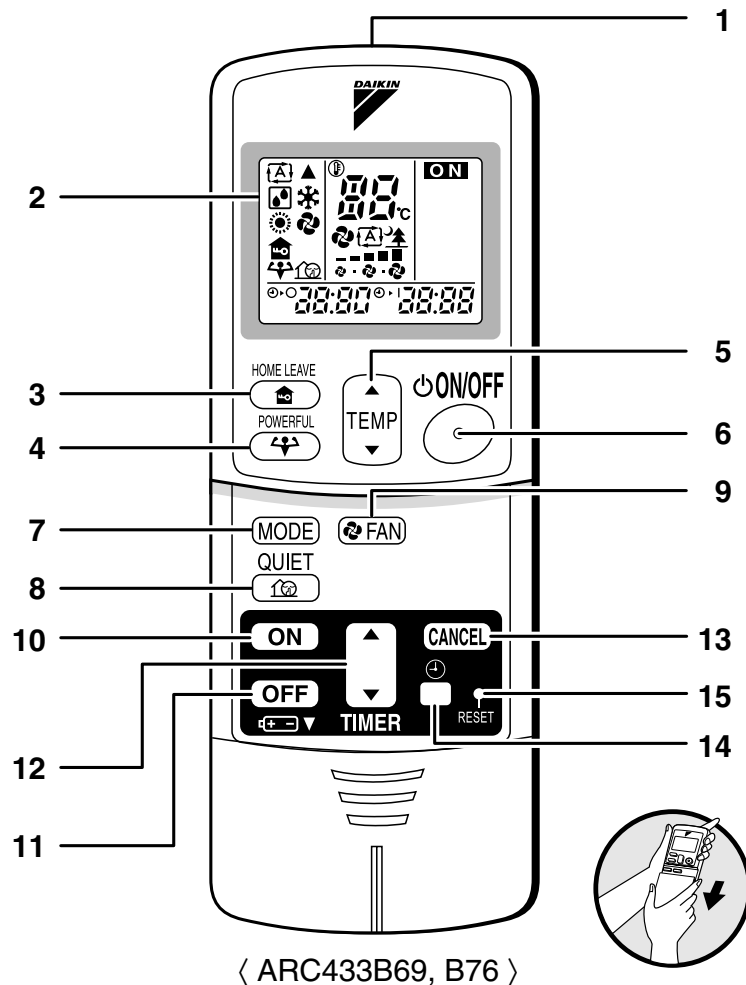

〈 ARC433B69, B76 〉

- |   |   |
|---|---|
| <p><b>1. Signal transmitter:</b></p> <ul style="list-style-type: none"> <li>• It sends signals to the indoor unit.</li> </ul> <p><b>2. Display:</b></p> <ul style="list-style-type: none"> <li>• It displays the current settings.<br/>(In this illustration, each section is shown with all its displays ON for the purpose of explanation.)</li> </ul> <p><b>3. HOME LEAVE button:</b><br/>HOME LEAVE operation</p> <p><b>4. POWERFUL button:</b><br/>POWERFUL operation</p> <p><b>5. TEMPERATURE adjustment buttons:</b></p> <ul style="list-style-type: none"> <li>• It changes the temperature setting.</li> </ul> <p><b>6. ON/OFF button:</b></p> <ul style="list-style-type: none"> <li>• Press this button once to start operation.<br/>Press once again to stop it.</li> </ul> | <p><b>7. MODE selector button:</b></p> <ul style="list-style-type: none"> <li>• It selects the operation mode.<br/>(AUTO/DRY/COOL/HEAT/FAN)</li> </ul> <p><b>8. QUIET button:</b> OUTDOOR UNIT QUIET operation</p> <p><b>9. FAN setting button:</b></p> <ul style="list-style-type: none"> <li>• It selects the air flow rate setting.</li> </ul> <p><b>10. ON TIMER button</b></p> <p><b>11. OFF TIMER button</b></p> <p><b>12. TIMER Setting button:</b></p> <ul style="list-style-type: none"> <li>• It changes the time setting.</li> </ul> <p><b>13. TIMER CANCEL button:</b></p> <ul style="list-style-type: none"> <li>• It cancels the timer setting.</li> </ul> <p><b>14. CLOCK button</b></p> <p><b>15. RESET button:</b></p> <ul style="list-style-type: none"> <li>• Restart the unit if it freezes.</li> <li>• Use a thin object to push.</li> </ul> |
|---|---|

FLK(X)S 25/35/50/60 B

# Names of parts

## ■ Indoor Unit

The indoor unit can be installed either to the ceiling or to a wall. The descriptions contained in this manual show the case when installation is being carried out to the ceiling. (The methods of operation used are the same when installing to a wall.)

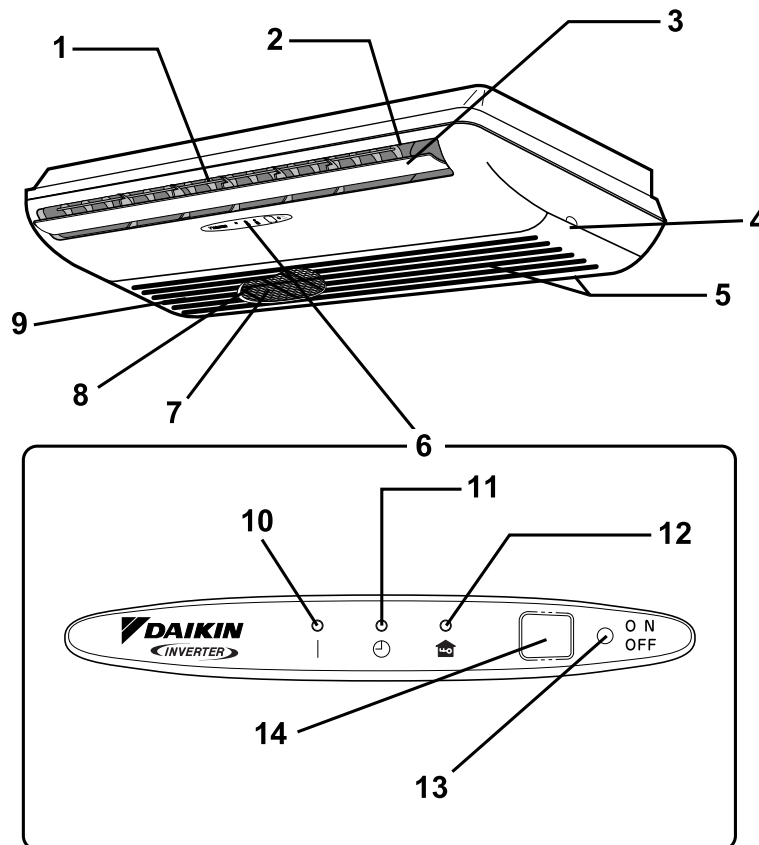

## ■ Opening the front panel

How to open the front panel

### ⚠ CAUTION

- Before opening the front panel, be sure to stop the operation and turn the breaker OFF.

## ■ Outdoor Unit

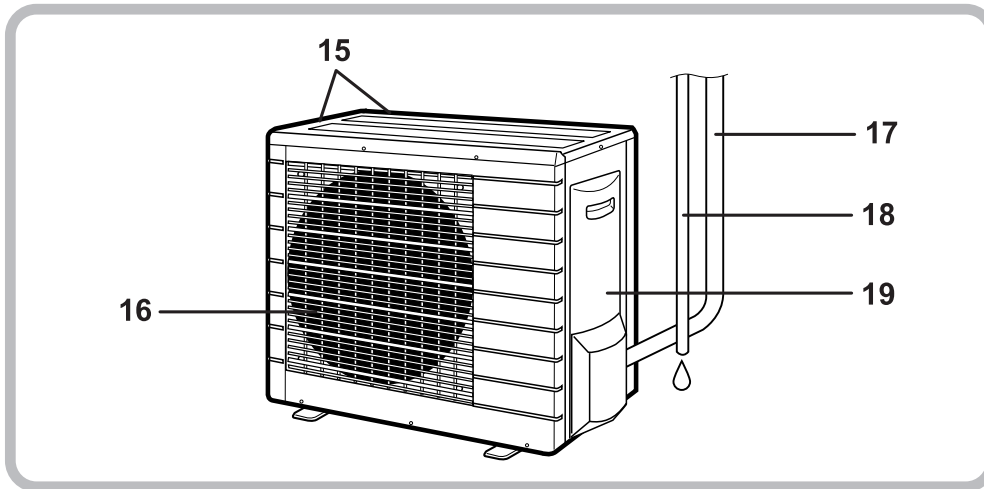

## ■ Indoor Unit

1. **Louvers (vertical blades):**  
The louvers are inside of the air outlet.
2. **Air outlet**
3. **Flap (horizontal blade)**
4. **Panel tab**
5. **Air inlet**
6. **Display**
7. **Air filter**
8. **Photocatalytic deodorizing filter or Air purifying filter:**
  - These filters are attached to the inside of the air filters.
9. **Front panel**
10. **Operation lamp (green)**
11. **TIMER lamp (yellow)**
12. **HOME LEAVE lamp (red):**  
Lights up when you use HOME LEAVE Operation.

13. **Indoor unit ON/OFF switch:**
  - Push this switch once to start operation. Push once again to stop it.
  - The operation mode refers to the following table.

	Mode	Temperature setting	Air flow rate
FLKS	COOL	22°C	AUTO
FLXS	AUTO	25°C	AUTO

- Push the switch using an object with a sharp tip, such as a pen.
  - This switch is useful when the remote controller is missing.
14. **Signal receiver:**
    - It receives signals from the remote controller.
    - When the unit receives a signal, you will hear a short beep.
      - Operation start .....beep-beep
      - Settings changed.....beep
      - Operation stop .....beeeep

## ■ Outdoor Unit

15. **Air inlet:** (Back and side)
16. **Air outlet**
17. **Refrigerant piping and inter-unit cable**
18. **Drain hose**
19. **Earth terminal:**
  - It is inside of this cover.

Appearance of the outdoor unit may differ from some models.

## ■ Remote Controller

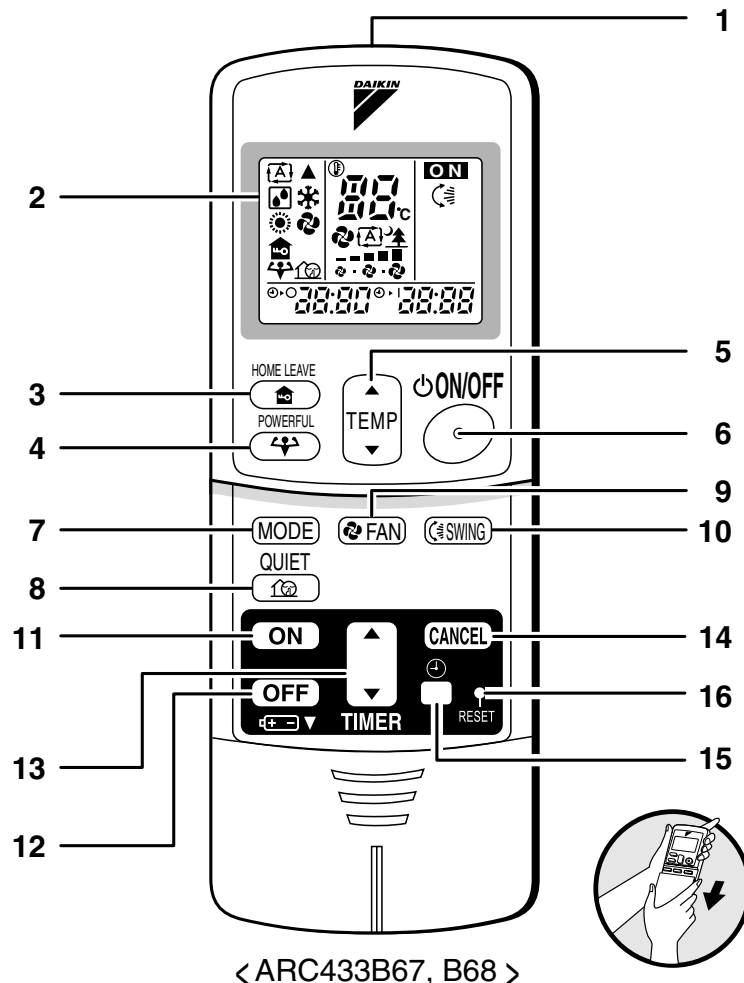

- |   |   |
|---|---|
| <p><b>1. Signal transmitter:</b></p> <ul style="list-style-type: none"> <li>• It sends signals to the indoor unit.</li> </ul> <p><b>2. Display:</b></p> <ul style="list-style-type: none"> <li>• It displays the current settings.<br/>(In this illustration, each section is shown with all its displays ON for the purpose of explanation.)</li> </ul> <p><b>3. HOME LEAVE button:</b><br/>HOME LEAVE operation</p> <p><b>4. POWERFUL button:</b><br/>POWERFUL operation</p> <p><b>5. TEMPERATURE adjustment buttons:</b></p> <ul style="list-style-type: none"> <li>• It changes the temperature setting.</li> </ul> <p><b>6. ON/OFF button:</b></p> <ul style="list-style-type: none"> <li>• Press this button once to start operation.<br/>Press once again to stop it.</li> </ul> | <p><b>7. MODE selector button:</b></p> <ul style="list-style-type: none"> <li>• It selects the operation mode.<br/>(AUTO/DRY/COOL/HEAT/FAN)</li> </ul> <p><b>8. QUIET button:</b> OUTDOOR UNIT QUIET operation</p> <p><b>9. FAN setting button:</b></p> <ul style="list-style-type: none"> <li>• It selects the air flow rate setting.</li> </ul> <p><b>10. SWING button</b></p> <p><b>11. ON TIMER button</b></p> <p><b>12. OFF TIMER button</b></p> <p><b>13. TIMER Setting button:</b></p> <ul style="list-style-type: none"> <li>• It changes the time setting.</li> </ul> <p><b>14. TIMER CANCEL button:</b></p> <ul style="list-style-type: none"> <li>• It cancels the timer setting.</li> </ul> <p><b>15. CLOCK button</b></p> <p><b>16. RESET button:</b></p> <ul style="list-style-type: none"> <li>• Restart the unit if it freezes.<br/>• Use a thin object to push.</li> </ul> |
|---|---|

## 2.1.4 Preparation Before Operation

# Preparation Before Operation

### ■ To set the batteries

1. Slide the front cover to take it off.
2. Set two dry batteries (AAA).
3. Set the front cover as before.

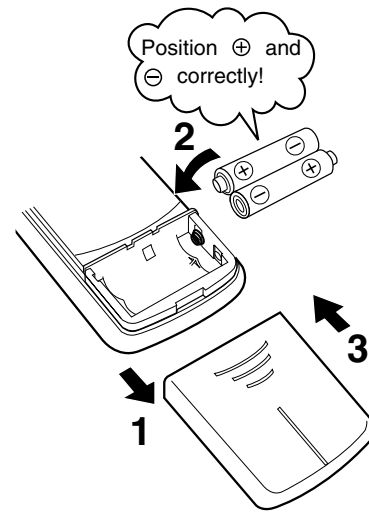

## ATTENTION

### ■ About batteries

- When replacing the batteries, use batteries of the same type, and replace the two old batteries together.
- When the system is not used for a long time, take the batteries out.
- We recommend replacing once a year, although if the remote controller display begins to fade or if reception deteriorates, please replace with new alkali batteries. Using manganese batteries reduces the lifespan.
- The attached batteries are provided for the initial use of the system.  
The usable period of the batteries may be short depending on the manufactured date of the air conditioner.

# Preparation Before Operation

## ■ To operate the remote controller

- To use the remote controller, aim the transmitter at the indoor unit. If there is anything to block signals between the unit and the remote controller, such as a curtain, the unit will not operate.
- Do not drop the remote controller. Do not get it wet.
- The maximum distance for communication is about 7m.

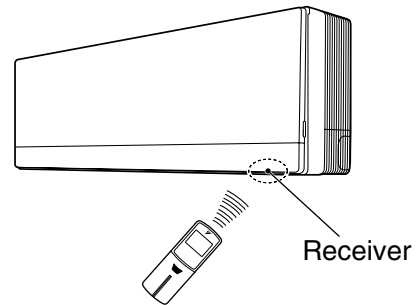

## ■ To fix the remote controller holder on the wall

1. Choose a place from where the signals reach the unit.
2. Fix the holder to a wall, a pillar, or similar location with the screws procured locally.
3. Place the remote controller in the remote controller holder.

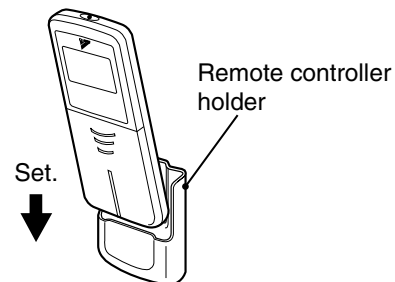

## ■ Turn on the power breaker

- Turning on the power breaker will cause the panel and flap to open once and then close again. (This is a normal procedure.)

- To remove, pull it upwards.

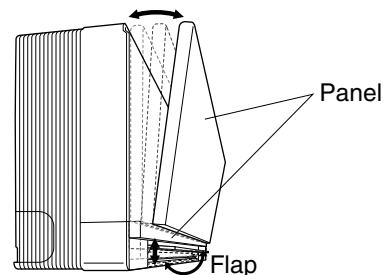

### ⚠ CAUTION

- During operation (i.e. when the panel is open or being opened or closed), do not touch the panel with your hands.

### ATTENTION

#### ■ About remote controller

- Never expose the remote controller to direct sunlight.
- Dust on the signal transmitter or receiver will reduce the sensitivity. Wipe off dust with soft cloth.
- Signal communication may be disabled if an electronic-starter-type fluorescent lamp (such as inverter-type lamps) is in the room. Consult the shop if that is the case.
- If the remote controller signals happen to operate another appliance, move that appliance to somewhere else, or consult the shop.

## ■ To set the clock

### 1. Press “CLOCK button”.

0:00 is displayed.

⌚ blinks.

### 2. Press “TIMER setting button” to set the clock to the present time.

Holding down “▲” or “▼” button rapidly increases or decreases the time display.

### 3. Press “CLOCK button”.

⌚ blinks.

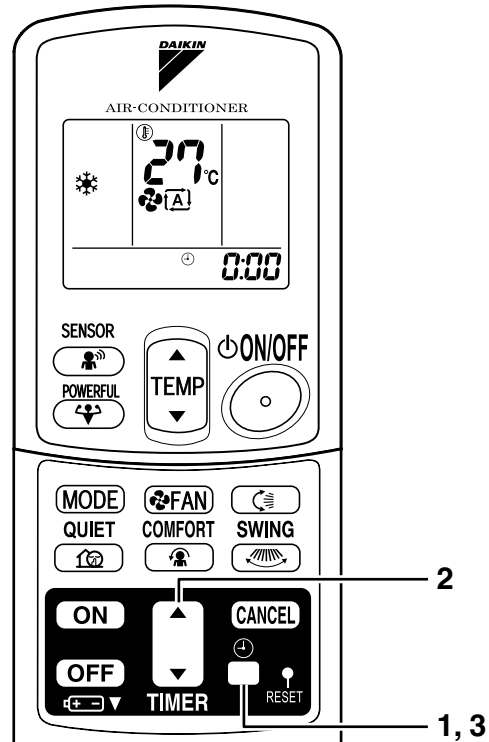

## NOTE

### ■ Tips for saving energy

- Be careful not to cool (heat) the room too much. Keeping the temperature setting at a moderate level helps save energy.
- Cover windows with a blind or a curtain. Blocking sunlight and air from outdoors increases the cooling (heating) effect.
- Clogged air filters cause inefficient operation and waste energy. Clean them once in about every two weeks.

Recommended temperature setting
For cooling: 26°C – 28°C
For heating: 20°C – 24°C

### ■ Please note

- The air conditioner always consumes 15-35 watts of electricity even while it is not operating.
- If you are not going to use the air conditioner for a long period, for example in spring or autumn, turn the breaker OFF.
- Use the air conditioner in the following conditions.

Mode	Operating conditions	If operation is continued out of this range
COOL	Outdoor temperature: <2MXS40> 10 to 46°C <2MXS52> -10 to 46°C <3/4/5MXS> -10 to 46°C <RXG> 10 to 46°C Indoor temperature: 18 to 32°C Indoor humidity: 80% max.	<ul style="list-style-type: none"> <li>• A safety device may work to stop the operation. (In multi system, it may work to stop the operation of the outdoor unit only.)</li> <li>• Condensation may occur on the indoor unit and drip.</li> </ul>
HEAT	Outdoor temperature: <2MXS40> -10 to 15.5°C <2MXS52> -15 to 15.5°C <3/4/5MXS> -15 to 15.5°C <RXG> -15 to 20°C Indoor temperature: 10 to 30°C	<ul style="list-style-type: none"> <li>• A safety device may work to stop the operation.</li> </ul>
DRY	Outdoor temperature: <2MXS40> 10 to 46°C <2MXS52> -10 to 46°C <3/4/5MXS> -10 to 46°C <RXG> 10 to 46°C Indoor temperature: 18 to 32°C Indoor humidity: 80% max.	<ul style="list-style-type: none"> <li>• A safety device may work to stop the operation.</li> <li>• Condensation may occur on the indoor unit and drip.</li> </ul>

- Operation outside this humidity or temperature range may cause a safety device to disable the system.

## 2.1.5 AUTO • DRY • COOL • HEAT • FAN Operation

# AUTO • DRY • COOL • HEAT • FAN Operation

The air conditioner operates with the operation mode of your choice.

From the next time on, the air conditioner will operate with the same operation mode.

### ■ To start operation

#### 1. Press “MODE selector button” and select a operation mode.

- Each pressing of the button advances the mode setting in sequence.

: AUTO

: DRY

: COOL

: HEAT

: FAN

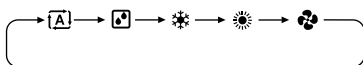

#### 2. Press “ON/OFF button”.

- The operation lamp will light up and the panel will open.

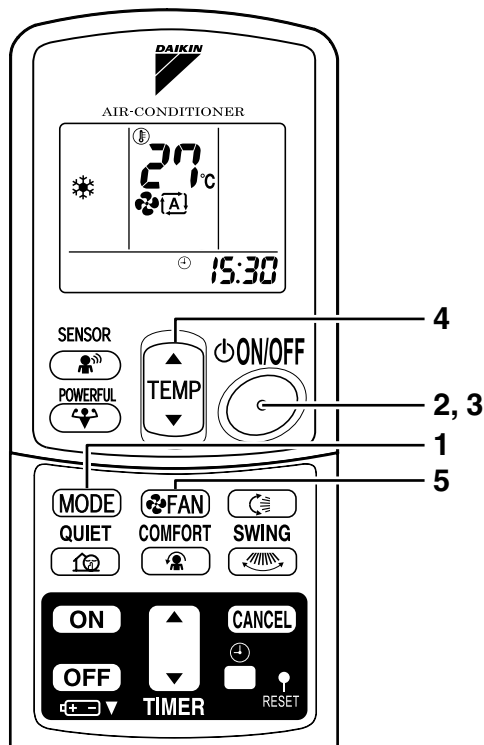
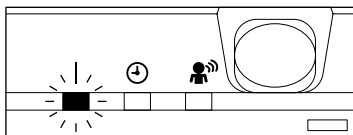

### ■ To stop operation

#### 3. Press “ON/OFF button” again.

- The operation lamp will go off and the panel will close.

### ■ To change the temperature setting





#### 4. Press “TEMPERATURE adjustment button”.

DRY or FAN mode	AUTO or COOL or HEAT mode
The temperature setting is not variable.	Press “▲” to raise the temperature and press “▼” to lower the temperature.
	Set to the temperature you like. 



## ■ To change the air flow rate setting

### 5. Press “FAN setting button”.

DRY mode	AUTO or COOL or HEAT or FAN mode
The air flow rate setting is not variable.	Five levels of air flow rate setting from “  ” to “  ” plus “  ” “  ” are available. 

- Indoor unit quiet operation

When the air flow is set to “”, the noise from the indoor unit will become quieter. Use this when making the noise quieter.

The unit might lose capacity when the air flow rate is set to a weak level.

## NOTE

### ■ Note on HEAT operation

- Since this air conditioner heats the room by taking heat from outdoor air to indoors, the heating capacity becomes smaller in lower outdoor temperatures. If the heating effect is insufficient, it is recommended to use another heating appliance in combination with the air conditioner.
- The heat pump system heats the room by circulating hot air around all parts of the room. After the start of heating operation, it takes some time before the room gets warmer.
- In heating operation, frost may occur on the outdoor unit and lower the heating capacity. In that case, the system switches into defrosting operation to take away the frost.
- During defrosting operation, hot air does not flow out of indoor unit.

### ■ Note on COOL operation

- This air conditioner cools the room by blowing the hot air in the room outside, so if the outside temperature is high, performance drops.

### ■ Note on DRY operation

- The computer chip works to rid the room of humidity while maintaining the temperature as much as possible. It automatically controls temperature and air flow rate, so manual adjustment of these functions is unavailable.

### ■ Note on AUTO operation

- In AUTO operation, the system selects an appropriate operation mode (COOL or HEAT) based on the room temperature at the start of the operation.
- The system automatically reselects setting at a regular interval to bring the room temperature to user-setting level.
- If you do not like AUTO operation, you can manually select the operation mode and setting you like.

### ■ Note on air flow rate setting

- At smaller air flow rates, the cooling (heating) effect is also smaller.





## 2.1.6 Adjusting the Airflow Direction

FTXG 25/35 E, CTXG 50 E

# Adjusting the Air Flow Direction



You can adjust the air flow direction to increase your comfort.

### ■ To adjust the horizontal blade (flap)

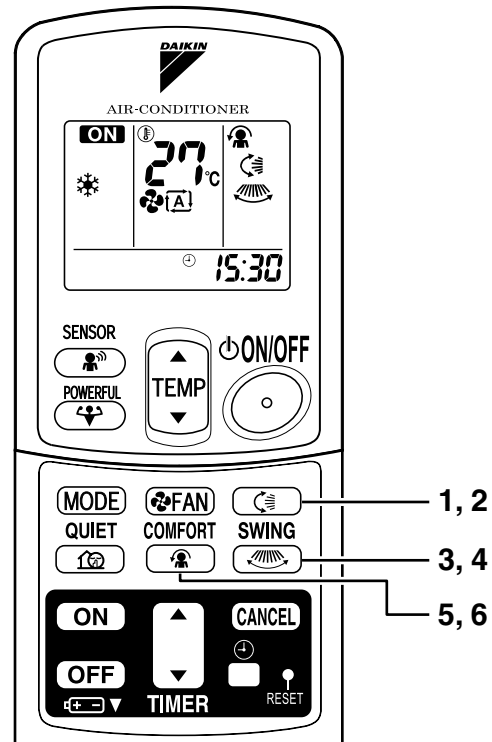



1. Press “SWING button ”.
  - “” is displayed on the LCD.
2. When the flap has reached the desired position, press “SWING button ” once more.
  - The flap will stop moving.
  - “” disappears from the LCD.



### ■ To adjust the vertical blades (louvers)

3. Press “SWING button ”.
  - “” is displayed on the LCD.
4. When the louvers have reached the desired position, press the “SWING button ” once more.
  - The louvers will stop moving.

### ■ To 3-D Airflow

1. 3. Press the “SWING button ” and the “SWING button ”:  
the “” and “” display will light up and the flap and louvers will move in turn.

### ■ To cancel 3-D Airflow

2. 4. Press either the “SWING button ” or the “SWING button ”.

## ■ To start COMFORT AIRFLOW operation

### 5. Press “COMFORT AIRFLOW button”.

- The flap orientation will change, preventing air from blowing directly on the occupants of the room.
- “” is displayed on the LCD.

<COOL/DRY> The flap will go up.

<HEAT> The flap will go down.

## ■ To cancel COMFORT AIRFLOW operation

### 6. Press “COMFORT AIRFLOW button” again.

- The flaps will return to the memory position from before COMFORT AIRFLOW mode.
- “” disappears from the LCD.

## NOTE

- When “**SWING button** ” is selected, the flap swinging range depends on the operation mode. (See the figure.)

### Three-Dimensional (3-D) Airflow

- Using three-dimensional airflow circulates cold air, which tends to be collected at the bottom of the room, and hot air, which tends to collect near the ceiling, throughout the room, preventing areas of cold and hot developing.

### Comfort Airflow

- The air flow is set automatically.
- The air direction is as shown in the figure at right.

### ■ ATTENTION

- Always use a remote controller to adjust the flap angle. If you attempt to move it forcibly with hand when it is swinging, the mechanism may be broken.
- Always use a remote controller to adjust the louvers angles.

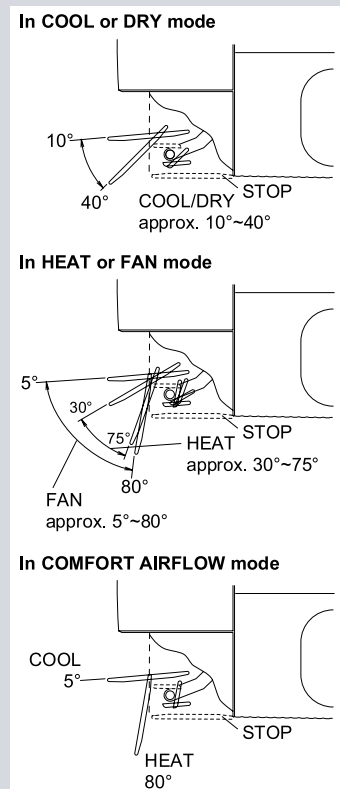





FTK(X)S 60/70 F

## Adjusting the Air Flow Direction



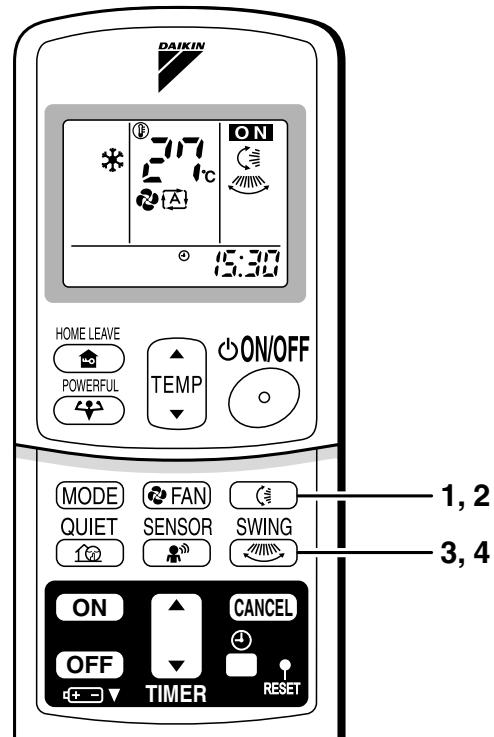

You can adjust the air flow direction to increase your comfort.

### ■ To adjust the horizontal blade (flap)





1. Press “SWING button ”.
  - “” is displayed on the LCD and the flaps will begin to swing.
2. When the flap has reached the desired position, press “SWING button ” once more.
  - The flap will stop moving.
  - “” disappears from the LCD.



### ■ To adjust the vertical blades (louvers)

3. Press “SWING button ”.
  - “” is displayed on the LCD.
4. When the louvers have reached the desired position, press the “SWING button ” once more.
  - The louvers will stop moving.
  - “” disappears from the LCD.

## ■ To 3-D Airflow

3. Press the “SWING button ” and the “SWING button ”:  
the “” and “” display will light up and the flap and louvers will move in turn.

## ■ To cancel 3-D Airflow

4. Press either the “SWING button ” or the “SWING button ”.

## Notes on louvers angles

### ■ ATTENTION

- Always use a remote controller to adjust the louvers angles. Inside the air outlet, a fan is rotating at a high speed.

## Notes on flap angle

- When “SWING button” is selected, the flaps swinging range depends on the operation mode. (See the figure.)

### Three-Dimensional (3-D) Airflow

- Using three-dimensional airflow circulates cold air, which tends to collect at the bottom of the room, and hot air, which tends to collect near the ceiling, throughout the room, preventing areas of cold and hot developing.

### ■ ATTENTION

- Always use a remote controller to adjust the flaps angle. If you attempt to move it forcibly with hand when it is swinging, the mechanism may be broken.
- Be careful when adjusting the louvers. Inside the air outlet, fan is rotating at a high speed.

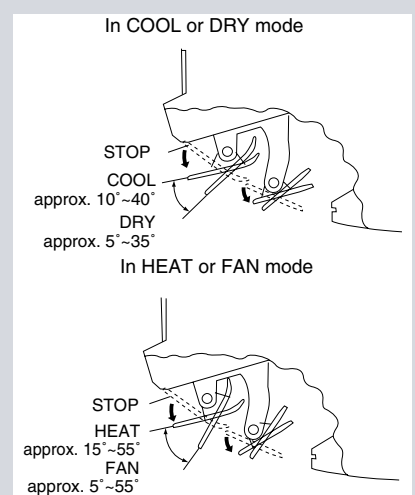

FLK(X)S 25/35/50/60 B

## Adjusting the Air Flow Direction

You can adjust the air flow direction to increase your comfort.

### ■ To adjust the horizontal blade (flap)

#### 1. Press “SWING button”.

- “” is displayed on the LCD and the flaps will begin to swing.

#### 2. When the flaps have reached the desired position, press “SWING button” once more.

- The flap will stop moving.
- “” disappears from the LCD.

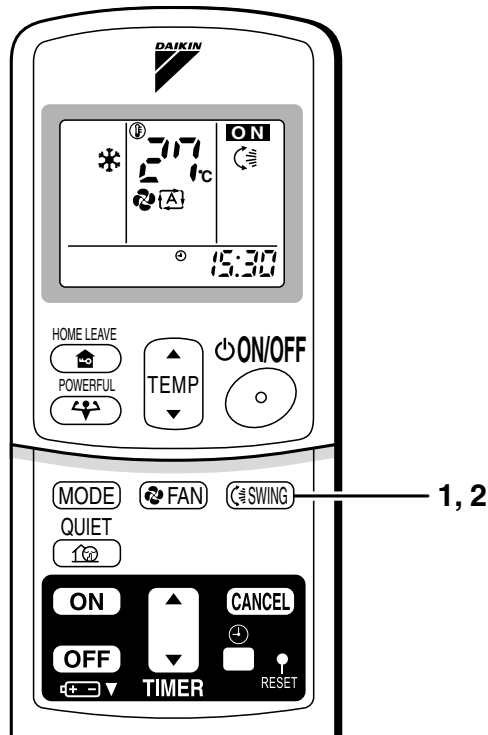

## ■ To adjust the vertical blades (louvers)

- When adjusting the louver, use a robust and stable stool and watch your steps carefully.  
Hold the knob and move the louvers.  
(You will find a knob on the left side and the right side blades.)

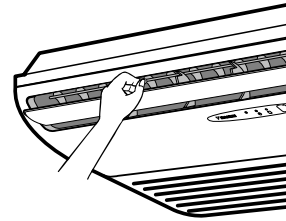

## Notes on flap and louvers angles.

- Unless [SWING] is selected, you should set the flap at a near- horizontal angle in COOL or DRY mode to obtain the best performance.
- In COOL or DRY mode, if the flap is fixed at a downward position, the flap automatically moves in about 60 minutes to prevent condensation on it.

### ■ ATTENTION

- Always use a remote controller to adjust the flap angle.  
If you attempt to move it forcibly with hand when it is swinging, the mechanism may be broken.
- Be careful when adjusting the louvers. Inside the air outlet, a fan is rotating at a high speed.

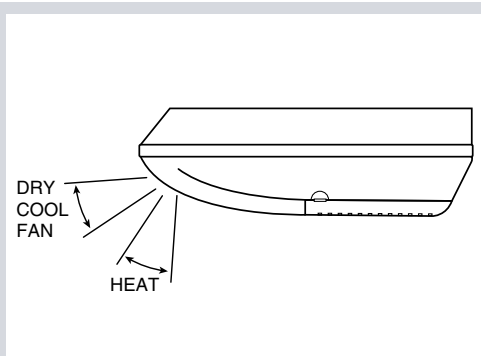

## 2.1.7 POWERFUL Operation

# POWERFUL Operation

POWERFUL operation quickly maximizes the cooling (heating) effect in any operation mode. You can get the maximum capacity.

### ■ To start POWERFUL operation

#### 1. Press “POWERFUL button”.

- POWERFUL operation ends in 20 minutes. Then the system automatically operates again with the settings which were used before POWERFUL operation.
- When using POWERFUL operation, there are some functions which are not available.
- “” is displayed on the LCD.

### ■ To cancel POWERFUL operation

#### 2. Press “POWERFUL button” again.

- “” disappears from the LCD.

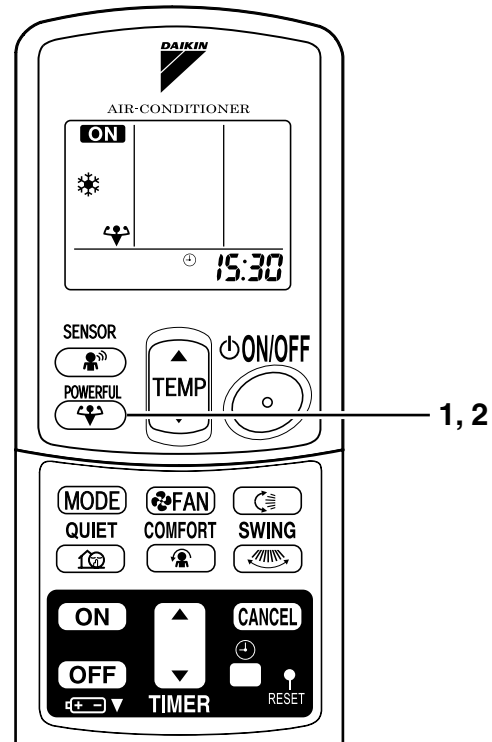

## NOTE

### ■ Notes on POWERFUL operation

- POWERFUL Operation cannot be used together with QUIET, or COMFORT Operation. Priority is given to the function of whichever button is pressed last. (This does not include QUIET operation.)
- POWERFUL Operation can only be set when the unit is running. Pressing the operation stop button causes the settings to be canceled, and the “” disappears from the LCD.
- **In COOL and HEAT mode**  
To maximize the cooling (heating) effect, the capacity of outdoor unit must be increased and the air flow rate be fixed to the maximum setting.  
The temperature and air flow settings are not variable.
- **In DRY mode**  
The temperature setting is lowered by 2.5°C and the air flow rate is slightly increased.
- **In FAN mode**  
The air flow rate is fixed to the maximum setting.
- **When using priority-room setting**  
See “Note for multi system”



## 2.1.8 OUTDOOR UNIT QUIET Operation

# OUTDOOR UNIT QUIET Operation

OUTDOOR UNIT QUIET operation lowers the noise level of the outdoor unit by changing the frequency and fan speed on the outdoor unit. This function is convenient during night.

### ■ To start OUTDOOR UNIT QUIET operation

1. Press “QUIET button”.
  - “” is displayed on the LCD.

### ■ To cancel OUTDOOR UNIT QUIET operation

2. Press “QUIET button” again.
  - “” disappears from the LCD.

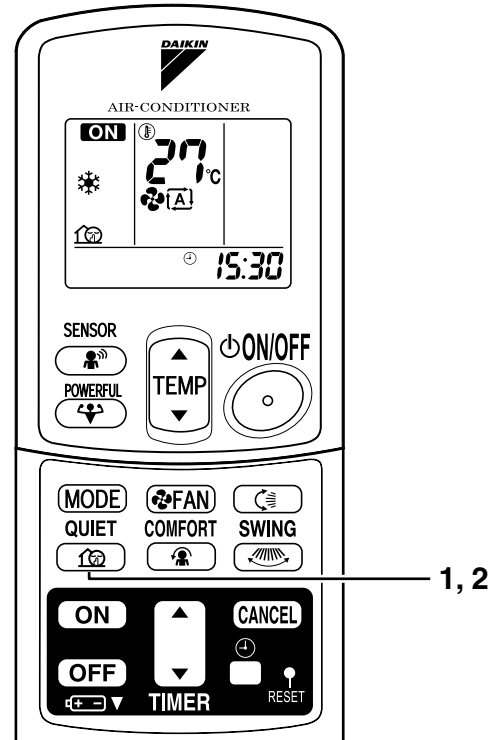

## NOTE

### ■ Note on OUTDOOR UNIT QUIET operation

- If using a multi system, this function will work only when the OUTDOOR UNIT QUIET operation is set on all operated indoor units.  
However, if using priority-room setting, see “Note for multi system”
- This function is available in COOL, HEAT, and AUTO modes.  
(This is not available in FAN and DRY mode.)
- POWERFUL operation and OUTDOOR UNIT QUIET operation cannot be used at the same time.  
Priority is given to the function of whichever button is pressed last.
- If operation is stopped using the remote controller or the main unit ON/OFF switch when using OUTDOOR UNIT QUIET operation, “” will remain on the remote controller display.

## 2.1.9 HOME LEAVE Operation

# HOME LEAVE Operation

HOME LEAVE operation is a function which allows you to record your preferred temperature and air flow rate settings.

### ■ To start HOME LEAVE operation

#### 1. Press “HOME LEAVE button”.

- “” is displayed on the LCD.
- The HOME LEAVE lamp lights up.

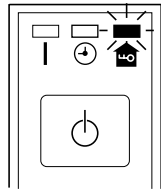

### ■ To cancel HOME LEAVE operation

#### 2. Press “HOME LEAVE button” again.



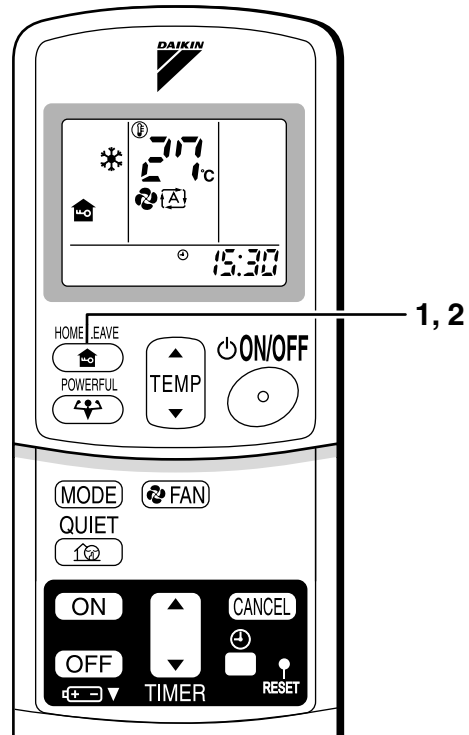



- The HOME LEAVE lamp goes off.
- “” disappears from the LCD.





### Before using HOME LEAVE operation.

#### ■ To set the temperature and air flow rate for HOME LEAVE operation

When using HOME LEAVE operation for the first time, please set the temperature and air flow rate for HOME LEAVE operation. Record your preferred temperature and air flow rate.

	Initial setting		Selectable range	
	temperature	Air flow rate	temperature	Air flow rate
Cooling	25°C	“  ”	18-32°C	5 step, “  ” and “  ”
Heating	25°C	“  ”	10-30°C	5 step, “  ” and “  ”

1. Press “HOME LEAVE button”. Make sure “” is displayed in the remote control display.

2. Adjust the set temperature with “” or “” as you like.

3. Adjust the air flow rate with “FAN” setting button as you like.

Home leave operation will run with these settings the next time you use the unit. To change the recorded information, repeat steps 1 – 3.

## ■ What's the HOME LEAVE operation?

Is there a set temperature and air flow rate which is most comfortable, a set temperature and air flow rate which you use the most? HOME LEAVE operation is a function that allows you to record your favorite set temperature and air flow rate. You can start your favorite operation mode simply by pressing the HOME LEAVE button on the remote control. This function is convenient in the following situations.

## ■ Useful in these cases

### 1. Use as an energy-saving mode.

Set the temperature 2-3°C higher (cooling) or lower (heating) than normal. Setting the fan strength to the lowest setting allows the unit to be used in energy-saving mode. Also convenient for use while you are out or sleeping.

#### • Every day before you leave the house...

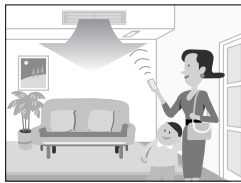

When you go out, push the "HOME LEAVE Operation" button, and the air conditioner will adjust capacity to reach the preset temperature for HOME LEAVE Operation.



When you return, you will be welcomed by a comfortably air conditioned room.



Push the "HOME LEAVE Operation" button again, and the air conditioner will adjust capacity to the set temperature for normal operation.

#### • Before bed...

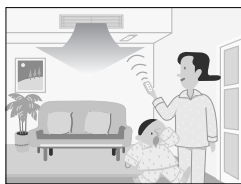

Set the unit to HOME LEAVE Operation before leaving the living room when going to bed.



The unit will maintain the temperature in the room at a comfortable level while you sleep.

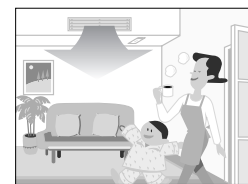

When you enter the living room in the morning, the temperature will be just right. Disengaging HOME LEAVE Operation will return the temperature to that set for normal operation. Even the coldest winters will pose no problem!

### 2. Use as a favorite mode.

Once you record the temperature and air flow rate settings you most often use, you can retrieve them by pressing HOME LEAVE button. You do not have to go through troublesome remote control operations.

## NOTE

- Once the temperature and air flow rate for HOME LEAVE operation are set, those settings will be used whenever HOME LEAVE operation is used in the future. To change these settings, please refer to the "Before using HOME LEAVE operation" section above.
- HOME LEAVE operation is only available in COOL and HEAT mode. Cannot be used in AUTO, DRY, and FAN mode.
- HOME LEAVE operation runs in accordance with the previous operation mode (COOL or HEAT) before using HOME LEAVE operation.
- HOME LEAVE operation and POWERFUL operation cannot be used at the same time. Last button that was pressed has priority.
- The operation mode cannot be changed while HOME LEAVE operation is being used.
- When operation is shut off during HOME LEAVE operation, using the remote controller or the indoor unit ON/OFF switch, "🏠" will remain on the remote controller display.

## 2.1.10 INTELLIGENT EYE Operation

# INTELLIGENT EYE Operation

“INTELLIGENT EYE” is the infrared sensor which detects the human movement.

### ■ To start INTELLIGENT EYE operation

1. Press “SENSOR button”.
  - “” is displayed on the LCD.

### ■ To cancel the INTELLIGENT EYE operation

2. Press “SENSOR button” again.
  - “” disappears from the LCD.

[EX.]

**When somebody in the room**

- Normal operation.
- The INTELLIGENT EYE lamp lights up.



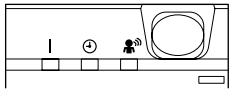

**When somebody in the room**

- 20 min. after, start **energy saving operation**.
- The INTELLIGENT EYE lamp goes off.

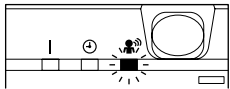
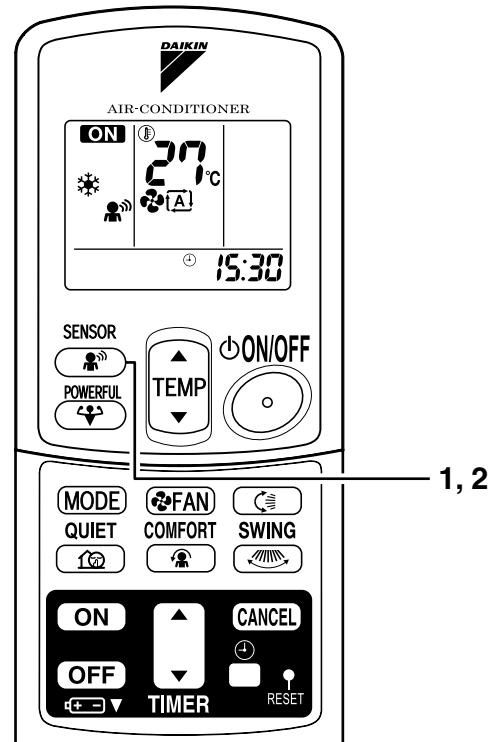

**Somebody back in the room**

- Back to normal operation.
- The INTELLIGENT EYE lamp lights up.

## “INTELLIGENT EYE” is useful for Energy Saving

### ■ Energy saving operation

- Change the temperature  $-2^{\circ}\text{C}$  in heating /  $+2^{\circ}\text{C}$  in cooling /  $+2^{\circ}\text{C}$  in dry mode from set temperature.
- Decrease the air flow rate slightly in fan operation. (In FAN mode only)

### Notes on “INTELLIGENT EYE”

- Application range is as follows.

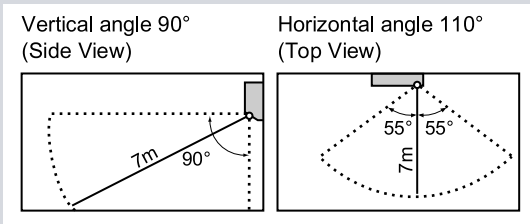

- Sensor may not detect moving objects further than 7m away. (Check the application range)
- Sensor detection sensitivity changes according to indoor unit location, the speed of passersby, temperature range, etc.
- The sensor also mistakenly detects pets, sunlight, fluttering curtains and light reflected off of mirrors as passersby.
- INTELLIGENT EYE operation will not go on during powerful operation.
- Night set mode will not go on during you use INTELLIGENT EYE operation.

### **!** CAUTION

- Do not place large objects near the sensor.  
Also keep heating units or humidifiers outside the sensor's detection area. This sensor can detect objects it shouldn't as well as not detect objects it should.
- Do not hit or violently push the INTELLIGENT EYE sensor. This can lead to damage and malfunction.

## 2.1.11 TIMER Operation

# TIMER Operation

Timer functions are useful for automatically switching the air conditioner on or off at night or in the morning. You can also use OFF TIMER and ON TIMER in combination.

### ■ To use OFF TIMER operation

- Check that the clock is correct.  
If not, set the clock to the present time.

#### 1. Press “OFF TIMER button”.

0:00 is displayed.

⊕-○ blinks.

#### 2. Press “TIMER Setting button” until the time setting reaches the point you like.

- Every pressing of either button increases or decreases the time setting by 10 minutes.  
Holding down either button changes the setting rapidly.

#### 3. Press “OFF TIMER button” again.

- The TIMER lamp lights up.

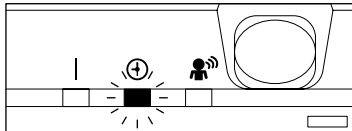

### ■ To cancel the OFF TIMER operation

#### 4. Press “CANCEL button”.

- The TIMER lamp goes off.

## NOTE

- When TIMER is set, the present time is not displayed.
- Once you set ON, OFF TIMER, the time setting is kept in the memory. (The memory is canceled when remote controller batteries are replaced.)
- When operating the unit via the ON/OFF Timer, the actual length of operation may vary from the time entered by the user.

### ■ NIGHT SET MODE

When the OFF TIMER is set, the air conditioner automatically adjusts the temperature setting (0.5°C up in COOL, 2.0°C down in HEAT) to prevent excessive cooling (heating) for your pleasant sleep.

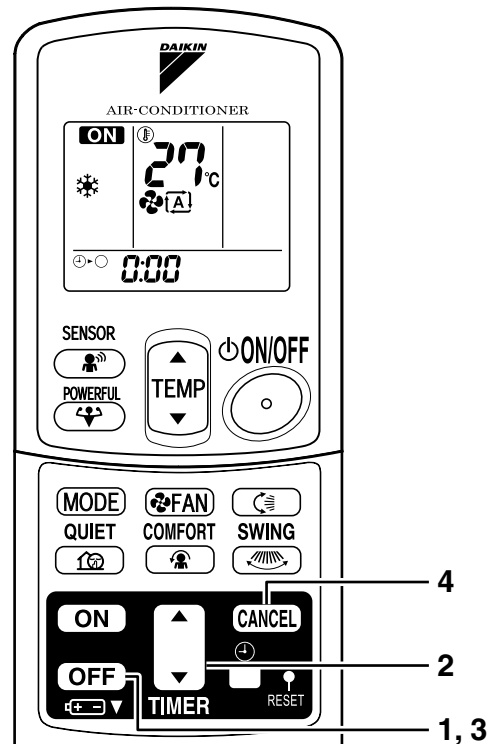

## ■ To use ON TIMER operation

- Check that the clock is correct. If not, set the clock to the present time.

### 1. Press “ON TIMER button”.

8:00 is displayed.

⊕| blinks.

### 2. Press “TIMER Setting button” until the time setting reaches the point you like.

- Every pressing of either button increases or decreases the time setting by 10 minutes. Holding down either button changes the setting rapidly.

### 3. Press “ON TIMER button” again.

- The TIMER lamp lights up.

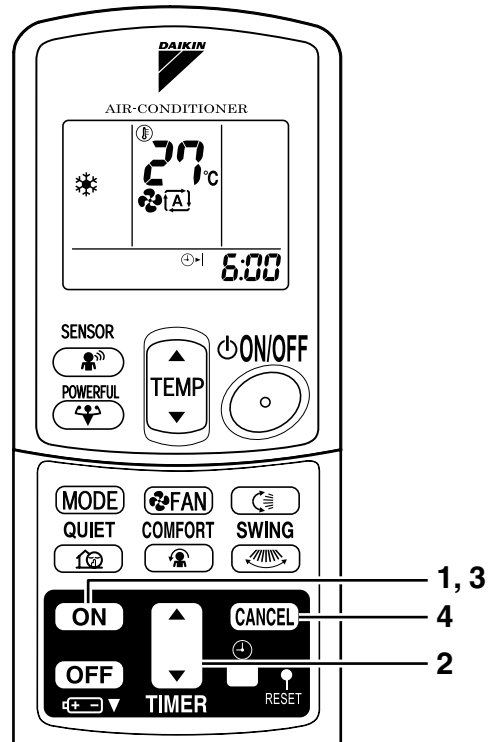
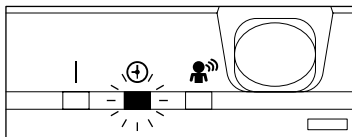

## ■ To cancel ON TIMER operation

### 4. Press “CANCEL button”.

- The TIMER lamp goes off.

## ■ To combine ON TIMER and OFF TIMER

- A sample setting for combining the two timers is shown below.

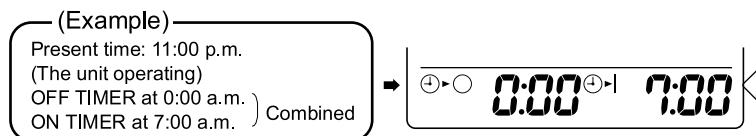

## ATTENTION

### ■ In the following cases, set the timer again.

- After a breaker has turned OFF.
- After a power failure.
- After replacing batteries in the remote controller.

## 2.1.12 Note for Multi System

# Note for Multi System

<< What is a “Multi System”? >>

This system has one outdoor unit connected to multiple indoor units.

## ■ Selecting the Operation Mode

### 1. With the Priority Room Setting present but inactive or not present.

When more than one indoor unit is operating, priority is given to the first unit that was turned on.

In this case, set the units that are turned on later to the same operation mode (\*1) as the first unit.

Otherwise, they will enter the Standby Mode, and the operation lamp will flash; this does not indicate malfunction.

(\*1)

- COOL, DRY and FAN mode may be used at the same time.
- AUTO mode automatically selects COOL mode or HEAT mode based on the room temperature. Therefore, AUTO mode is available when selecting the same operation mode as that of the room with the first unit to be turned on.

<CAUTION>

Normally, the operation mode in the room where the unit is first run is given priority, but the following situations are exceptions, so please keep this in mind.

If the operation mode of the first room is **FAN Mode**, then using **Heating Mode** in any room after this will give priority to **heating**. In this situation, the air conditioner running in FAN Mode will go on standby, and the operation lamp will flash.

### 2. With the Priority Room Setting active.

See “Priority Room Setting” on the next page.

## ■ NIGHT QUIET Mode (Available only for cooling operation)

NIGHT QUIET Mode requires initial programming during installation. Please consult your retailer or dealer for assistance. NIGHT QUIET Mode reduces the operation noise of the outdoor unit during the night time hours to prevent annoyance to neighbors.

- The NIGHT QUIET Mode is activated when the temperature drops 5°C or more below the highest temperature recorded that day. Therefore, when the temperature difference is less than 5°C, this function will not be activated.
- NIGHT QUIET Mode reduces slightly the cooling efficiency of the unit.

## ■ OUTDOOR UNIT QUIET Operation

### 1. With the Priority Room Setting present but inactive or not present.

When using the OUTDOOR UNIT QUIET operation feature with the Multi system, set all indoor units to OUTDOOR UNIT QUIET operation using their remote controllers.

When clearing OUTDOOR UNIT QUIET operation, clear one of the operating indoor units using their remote controller.

However OUTDOOR UNIT QUIET operation display remains on the remote controller for other rooms.

We recommend you release all rooms using their remote controllers.

### 2. With the Priority Room Setting active.

See “Priority Room Setting” on the next page.

## ■ Cooling / Heating Mode Lock (Available only for heat pump models)

The Cooling / Heating Mode Lock requires initial programming during installation. Please consult your retailer or dealer for assistance. The Cooling / Heating Mode Lock sets the unit forcibly to either Cooling or Heating Mode. This function is convenient when you wish to set all indoor units connected to the Multi system to the same operation mode.

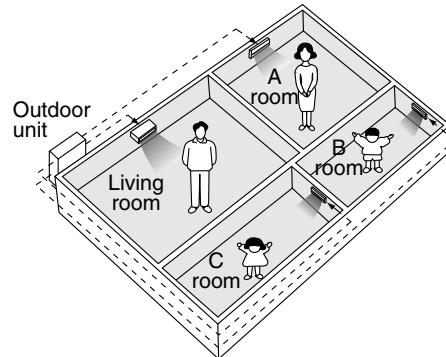



# Note for Multi System

## ■ Priority Room Setting

The Priority Room Setting requires initial programming during installation. Please consult your retailer or dealer for assistance.

The room designated as the Priority Room takes priority in the following situations;

### 1. Operation Mode Priority.

As the operation mode of the Priority Room takes precedence, the user can select a different operation mode from other rooms.

〈Example〉

\* Room A is the Priority Room in the examples.

When COOL mode is selected in Room A while operating the following modes in Room B,C and D :

Operation mode in Room B, C and D	Status of Room B, C and D when the unit in Room A is in COOL mode
COOL or DRY or FAN	Current operation mode maintained
HEAT	The unit enters Standby Mode. Operation resumes when the Room A unit stops operating.
AUTO	If the unit is set to COOL mode, operation continues. If set to HEAT mode, it enters Standby Mode. Operation resumes when the Room A unit stops operating.

### 2. Priority when POWERFUL operation is used.

〈Example〉

\* Room A is the Priority Room in the examples.

The indoor units in Rooms A,B,C and D are all operating. If the unit in Room A enters POWERFUL operation, operation capacity will be concentrated in Room A. In such a case, the cooling (heating) efficiency of the units in Rooms B,C and D may be slightly reduced.

### 3. Priority when using OUTDOOR UNIT QUIET operation.

〈Example〉

\* Room A is the Priority Room in the examples.

Just by setting the unit in Room A to QUIET operation, the air conditioner starts OUTDOOR UNIT QUIET operation.

You don't have to set all the operated indoor units to QUIET operation.

## 2.1.13 Care and Cleaning

FTXG 25/35 E, CTXG 50 E

# Care and Cleaning



### CAUTION

- Before cleaning, be sure to stop the operation and turn the breaker OFF.
- Always shut down the unit (and close the panel) before doing any work. Opening the panel during operation may cause the panel to fall off.

## Units

### ■ Indoor unit, Outdoor unit and Remote controller

1. Wipe them with dry soft cloth.

### ■ Front panel

#### 1. Open the front panel.

- Open the front panel by placing a finger on the panel tab on either side of the front panel.

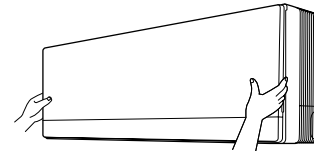

#### 2. Remove the front panel.

- With the front panel open so that it is almost horizontal, slide it to the right. The revolving axis on the left will come off. The revolving axis on the right can be removed by sliding the front panel to the left.

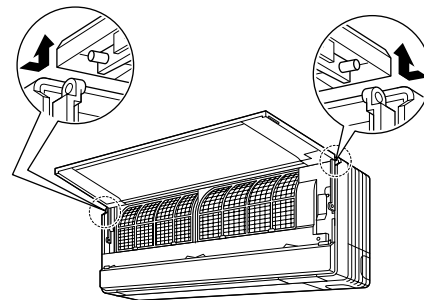

#### 3. Clean the front panel.

- Wipe it with a soft cloth soaked in water.
- Only neutral detergent may be used.
- In case of washing the front panel with water, dry it with cloth, dry it up in the shade after washing.

#### 4. Attach the front panel.

- Place the revolving axes on either side of the front panel into the holes and slowly close. (Press either side of the front panel.)

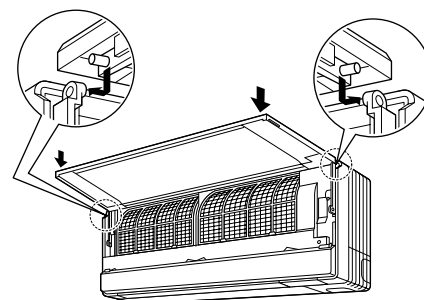

### CAUTION

- Don't touch the metal parts of the indoor unit. If you touch those parts, this may cause an injury.
- When removing or attaching the front panel, use a robust and stable stool and watch your steps carefully.
- When removing or attaching the front panel, support the front panel securely with hand to prevent it from falling.
- For cleaning, do not use hot water above 40°C, benzene, gasoline, thinner, nor other volatile oils, polishing compound, scrubbing brushes, nor other hand stuff.
- After cleaning, make sure that the front panel is securely fixed.

## Filters

### 1. Open the front panel.

- Open the front panel by placing a finger on the panel tab on either side of the front panel and then secure it using the supporting plate on the right.

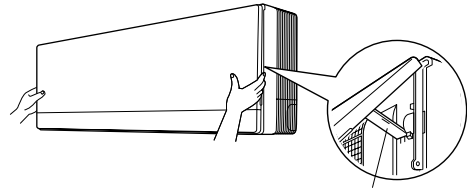

Supporting plate

### 2. Pull out the air filters.

- Push a little upwards the tab at the center of each air filter, then pull it down.

### 3. Take off the Titanium Apatite Photocatalytic Air-Purifying Filter.

- Hold the recessed parts of the frame and unhook the four claws.

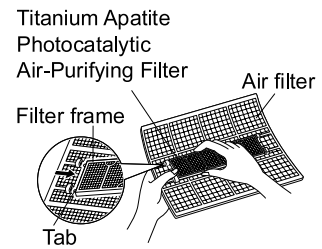
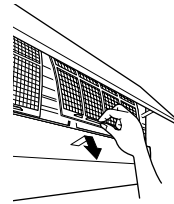

### 4. Clean or replace each filter.

See figure.

### 5. Set the air filter and the Titanium Apatite Photocatalytic Air-Purifying Filter as they were and close the front panel.

- Be sure to insert the two tabs below.
- Return the supporting plate to its previous position.
- Press either side of the front panel.

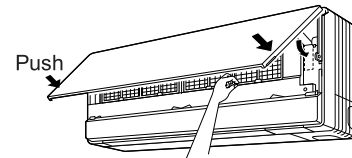

## ■ Air Filter

### 1. Wash the air filters with water or clean them with vacuum cleaner.

- If the dust does not come off easily, wash them with neutral detergent thinned with lukewarm water, then dry them up in the shade.
- It is recommended to clean the air filters every two weeks.

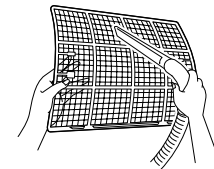

## ■ Titanium Apatite Photocatalytic Air-Purifying Filter (gray)

The Titanium Apatite Photocatalytic Air-Purifying Filter can be renewed by washing it with water once every 6 months. We recommend replacing it once every 3 years.

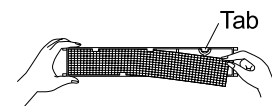

### [ Maintenance ]

1. Remove dust with a vacuum cleaner and wash lightly with water.
2. If it is very dirty, soak it for 10 to 15 minutes in water mixed with a neutral cleaning agent.
3. Do not remove filter from frame when washing with water.
4. After washing, shake off remaining water and dry in the shade.
5. Since the material is made out of paper, do not wring out the filter when removing water from it.

### [ Replacement ]

1. Remove the tabs on the filter frame and replace with a new filter.
  - Dispose of the old filter as flammable waste.

## NOTE

- Operation with dirty filters:
  - (1) cannot deodorize the air.                      (2) cannot clean the air.
  - (3) results in poor heating or cooling.            (4) may cause odour.
- To order Titanium Apatite Photocatalytic Air-Purifying Filter contact to the service shop there you bought the air conditioner.
- Dispose of old filters as burnable waste.

Item	Part No.
Titanium Apatite Photocatalytic Air-Purifying Filter. (with frame) 1 set	KAF952B41
Titanium Apatite Photocatalytic Air-Purifying Filter. (without frame) 1 set	KAF952B42

## Check

Check that the base, stand and other fittings of the outdoor unit are not decayed or corroded.
Check that nothing blocks the air inlets and the outlets of the indoor unit and the outdoor unit.
Check that the drain comes smoothly out of the drain hose during COOL or DRY operation. <ul style="list-style-type: none"> <li>• If no drain water is seen, water may be leaking from the indoor unit. Stop operation and consult the service shop if this is the case.</li> </ul>

## ■ Before a long idle period

- 1. Operate the “FAN only” for several hours on a fine day to dry out the inside.**
  - Press “MODE” button and select “FAN” operation.
  - Press “ON/OFF” button and start operation.
- 2. After operation stops, turn off the breaker for the room air conditioner.**
  - When a multi outdoor unit is connected, make sure the heating operation is not used at the other room before you use the fan operation.
- 3. Clean the air filters and set them again.**
- 4. Take out batteries from the remote controller.**

FTK(X)S 60/70 F

# Care and Cleaning

**⚠ CAUTION** Before cleaning, be sure to stop the operation and turn the breaker OFF.

## Units

### ■ Indoor unit, Outdoor unit and Remote controller

1. Wipe them with dry soft cloth.

### ■ Front panel

#### 1. Open the front panel.

- Hold the panel by the tabs on the two sides and lift it until it stops with a click.

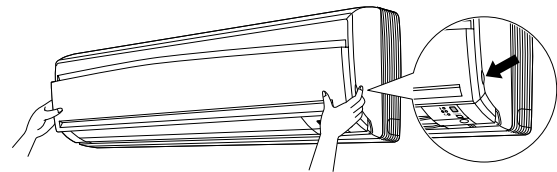

#### 2. Remove the front panel.

- Open the front panel further while sliding it to either the left or right and pulling it toward you. This will disconnect the rotation dowel on one side. Then disconnect the rotation dowel on the other side in the same manner.

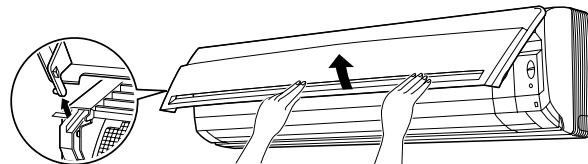

#### 3. Clean the front panel.

- Wipe it with a soft cloth soaked in water.
- Only neutral detergent may be used.
- In case of washing the panel with water, dry it with cloth, dry it up in the shade after washing.

#### 4. Attach the front panel.

- Align the rotation dowels on the left and right of the front panel with the slots, then push them all the way in.
- Close the front panel slowly. (Press the panel at both sides and the center.)

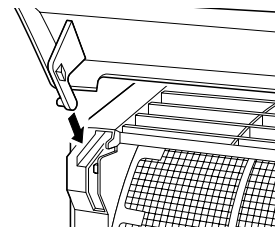

### ⚠ CAUTION

- Don't touch the metal parts of the indoor unit. If you touch those parts, this may cause an injury.
- When removing or attaching the front panel, use a robust and stable stool and watch your steps carefully.
- When removing or attaching the front panel, support the panel securely with hand to prevent it from falling.
- For cleaning, do not use hot water above 40°C, benzene, gasoline, thinner, nor other volatile oils, polishing compound, scrubbing brushes, nor other hand stuff.
- After cleaning, make sure that the front panel is securely fixed.

## Filters

### 1. Open the front panel.

### 2. Pull out the air filters.

- Push a little upwards the tab at the center of each air filter, then pull it down.

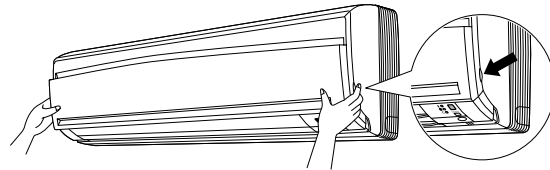

### 3. Take off the Titanium Apatite Photocatalytic Air-Purifying Filter.

- Press the top of the air-cleaning filter onto the tabs (3 tabs at top). Then press the bottom of the filter up slightly, and press it onto the tabs (3 at bottom).

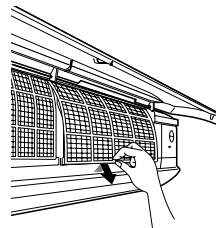

tabs (3 tabs at top)

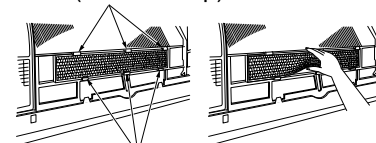

tabs (3 at bottom)

### 4. Clean or replace each filter.

See figure.

### 5. Set the air filter and the Titanium Apatite Photocatalytic Air-Purifying Filter as they were and close the front panel.

- Press the front panel at both sides and the center.

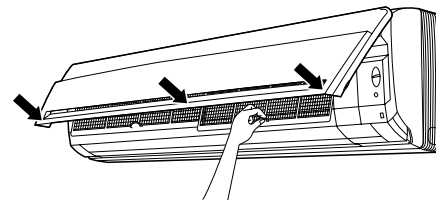

## ■ Air Filter

### 1. Wash the air filters with water or clean them with vacuum cleaner.

- If the dust does not come off easily, wash them with neutral detergent thinned with lukewarm water, then dry them up in the shade.
- It is recommended to clean the air filters every two weeks.

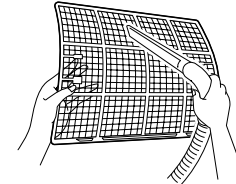

## ■ Titanium Apatite Photocatalytic Air-purifying Filter

The Titanium Apatite Photocatalytic Air-Purifying Filter can be renewed by washing it with water once every 6 months. We recommend replacing it once every 3 years.

### [ Maintenance ]

1. Remove dust with a vacuum cleaner and wash lightly with water.
2. If it is very dirty, soak it for 10 to 15 minutes in water mixed with a neutral cleaning agent.
3. After washing, shake off remaining water and dry in the shade.
4. Since the material is made out of polyester, do not wring out the filter when removing water from it.

### [ Replacement ]

1. Remove the tabs on the filter frame and replace with a new filter.
  - Dispose of the old filter as non-flammable waste.

## NOTE

- Operation with dirty filters:
  - (1) cannot deodorize the air.                      (2) cannot clean the air.
  - (3) results in poor heating or cooling.            (4) may cause odour.
- To order Titanium Apatite Photocatalytic Air-Purifying Filter contact to the service shop there you bought the air conditioner.
- Dispose of old filters as non-flammable waste.

Item	Part No.
Titanium Apatite Photocatalytic Air-Purifying Filter (without frame) 1 set	KAF952B42

## Check

Check that the base, stand and other fittings of the outdoor unit are not decayed or corroded.
Check that nothing blocks the air inlets and the outlets of the indoor unit and the outdoor unit.
Check that the drain comes smoothly out of the drain hose during COOL or DRY operation. <ul style="list-style-type: none"> <li>• If no drain water is seen, water may be leaking from the indoor unit. Stop operation and consult the service shop if this is the case.</li> </ul>

## ■ Before a long idle period

- 1. Operate the “FAN only” for several hours on a fine day to dry out the inside.**
  - Press “MODE” button and select “FAN” operation.
  - Press “ON/OFF” button and start operation.
- 2. After operation stops, turn off the breaker for the room air conditioner.**
- 3. Clean the air filters and set them again.**
- 4. Take out batteries from the remote controller.**
  - NOTE) When a multi outdoor unit is connected, make sure the heating operation is not used at the other room before you use the fan operation.

FDK(X)S 50/60 C, FDK(X)S 25/35 E

# Care and Cleaning



**CAUTION** • Only a qualified service person is allowed to perform maintenance.

- Before cleaning, be sure to stop the operation and turn the breaker OFF.

## ■ Cleaning the air filter

### 1. Removing the air filter.

- Rear suction  
Pull the bottom side of the air filter backwards, over the bends. (2 bends for 25/35 type, 3 bends for 50/60 type)
- Bottom suction  
Pull the filter over the bends (2 bends for 25/35 type, 3 bends for 50/60 type) situated at the backside of the unit.

### 2. Cleaning the air filter.

Remove dust from the air filter using a vacuum cleaner and gently rinse them in cool water. Do not use detergent or hot water to avoid filter shrinking or deformation. After cleaning dry them in the shade.

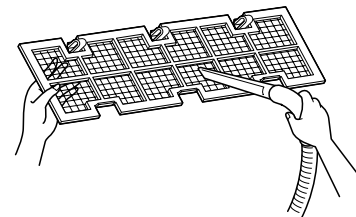

### 3. Replacing the air filter.

- Rear suction  
Hook the filter behind the flap situated at the top of the unit and push the other side gently over the bends. (2 bends for 25/35 type, 3 bends for 50/60 type)
- Bottom suction  
Hook the filter behind the flap situated at the middle of the unit and push the other side gently over the bends. (2 bends for 25/35 type, 3 bends for 50/60 type)

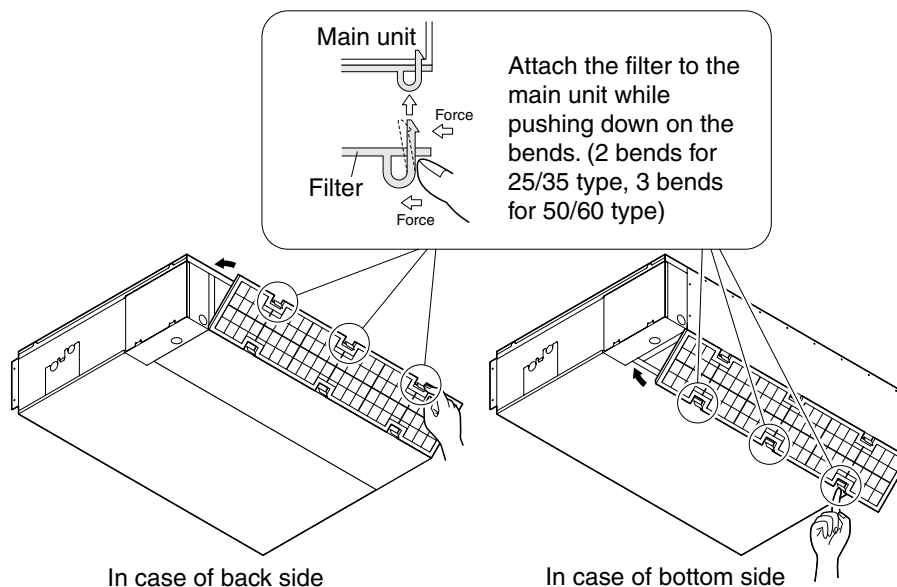



## ■ Cleaning the drain pan

- Clean the drain pan periodically, or drain piping may be clogged with dust and may result in water leakage. Ask your DAIKIN dealer to clean them.
- Prepare a cover locally to prevent any dust in the air around the indoor unit from getting in the drain pan, if there is a great deal of dust present.

## CAUTION

- Do not operate the air conditioner without filters, this to avoid dust accumulation inside the unit.
- Do not remove the air filter except when cleaning. Unnecessary handling may damage the filter.
- Do not use gasoline, benzene, thinner, polishing powder, liquid insecticide, It may cause discoloring or warping.
- Do not let the indoor unit get wet. It may cause an electric shock or a fire.
- Operation with dusty air filters lowers the cooling and heating capacity and wastes energy.
- The suction grille is option.
- Do not use water or air of 50°C or higher for cleaning air filters and outside panels.
- Ask your DAIKIN dealer how to clean it.

## Check

Check that the base, stand and other fittings of the outdoor unit are not decayed or corroded.
Check that nothing blocks the air inlets and the outlets of the indoor unit and the outdoor unit
Check that the drain comes smoothly out of the drain hose during COOL or DRY operation. <ul style="list-style-type: none"> <li>• If no drain water is seen, water may be leaking from the indoor unit. Stop operation and consult the service shop if this is the case.</li> </ul>

## ■ Before a long idle period

- 1. Operate the “FAN only” for several hours on a fine day to dry out the inside.**
  - Press “MODE selector button” and select “FAN” operation.
  - Press “ON/OFF button” and start operation.
- 2. Clean the air filters and set them again.**
- 3. Take out batteries from the remote controller.**
- 4. Turn OFF the breaker for the room air conditioner.**
  - When a multi outdoor unit is connected, make sure the heating operation is not used at the other room before you use the fan operation.

FLK(X)S 25/35/50/60 B

# Care and Cleaning



**CAUTION** Before cleaning, be sure to stop the operation and turn the breaker OFF.

## Units

### ■ Indoor unit, Outdoor unit and Remote controller

1. Wipe them with dry soft cloth.

### ■ Front panel

#### 1. Open the front panel.

- Hold the panel by the tabs on the two sides and lift it until it stops.

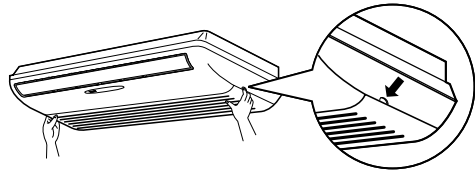

#### 2. Clean the front panel.

- Wipe it with a soft cloth soaked in water.
- Only neutral detergent may be used.
- In case of washing the panel with water, dry it with cloth, dry it up in the shade after washing.

#### 3. Close the front panel.

- Push the panel at the 5 points indicated by ↑.
- Operation without air filters may result in troubles as dust will accumulate inside the indoor unit.

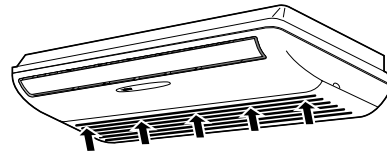

### CAUTION

- Don't touch the metal parts of the indoor unit. If you touch those parts, this may cause an injury.
- When removing or attaching the front panel, use a robust and stable stool and watch your steps carefully.
- When removing or attaching the front panel, support the panel securely with hand to prevent it from falling.
- For cleaning, do not use hot water above 40°C, benzene, gasoline, thinner, nor other volatile oils, polishing compound, scrubbing brushes, nor other hand stuff.
- After cleaning, make sure that the front panel is securely fixed.

## Filters

1. Open the front panel.
2. Pull out the air filters.
  - Push upwards the tab at the center of each air filter, then pull it down.

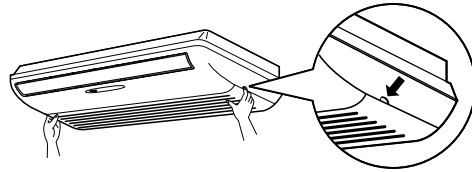

3. Take off the air purifying filter, photocatalytic deodorizing filter.
  - Hold the recessed parts of the frame and unhook the four claws.

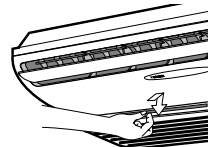

4. Clean or replace each filter.

See figure.

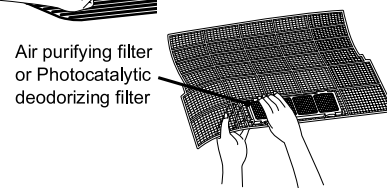

5. Set the air filter, air purifying filter and photocatalytic deodorizing filter as they were and close the front panel.

- Insert claws of the filters into slots of the front panel.
- Push the panel at the 5 points.

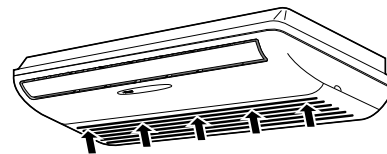

### ■ Air Filter

1. Wash the air filters with water or clean them with vacuum cleaner.

- If the dust does not come off easily, wash them with neutral detergent thinned with lukewarm water, then dry them up in the shade.
- It is recommended to clean the air filters every two weeks.

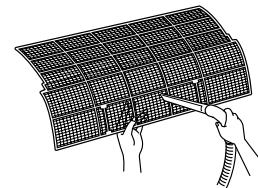

### ■ Air Purifying Filter (green)

(Replace approximately once every 3 months.)

1. Detach the filter element and attach a new one.

- Insert with the green side up.
- It is recommended to replace the air purifying filter every three months.

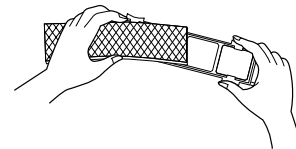

### ■ Photocatalytic Deodorizing Filter (gray)

#### [ Maintenance ]

1. Dry the photocatalytic deodorizing filter in the sun.

- After removing the dust with a vacuum cleaner, place the filter in the sun for approximately 6 hours. By drying the photocatalytic deodorizing filter in the sun, its deodorizing and antibacterial capabilities are regenerated.
- Because the filter material is paper, it can not be cleaned with water.
- It is recommended dry the filter once every 6 months.

#### [ Replacement ]

1. Detach the filter element and attach a new one.

## Check

Check that the base, stand and other fittings of the outdoor unit are not decayed or corroded.
Check that nothing blocks the air inlets and the outlets of the indoor unit and the outdoor unit.
Check that the drain comes smoothly out of the drain hose during COOL or DRY operation. <ul style="list-style-type: none"> <li>If no drain water is seen, water may be leaking from the indoor unit. Stop operation and consult the service shop if this is the case.</li> </ul>

## ■ Before a long idle period

- Operate the “FAN only” for several hours on a fine day to dry out the inside.**
  - Press “MODE” button and select “FAN” operation.
  - Press “ON/OFF” button and start operation.
- After operation stops, turn off the breaker for the room air conditioner.**
- Clean the air filters and set them again.**
- Take out batteries from the remote controller.**
  - When a multi outdoor unit is connected, make sure the heating operation is not used at the other room before you use the fan operation.

## NOTE

- Operation with dirty filters :
  - cannot deodorize the air.
  - cannot clean the air.
  - results in poor heating or cooling.
  - may cause odour.
- The air purifying filter and Photocatalytic deodorizing filter cannot be reused, even if washed.
- In principle, there is no need to replace the photocatalytic deodorizing filter. Remove the dust periodically with a vacuum cleaner. However, it is recommended to replace the filter in the following cases.
  - The paper material is torn or broken during cleaning.
  - The filter has become extremely dirty after long use.
- To order air purifying filter or Photocatalytic deodorizing filter, contact to the service shop where you bought the air conditioner.
- Dispose of old air filters as non-burnable waste and Photocatalytic deodorizing filters as burnable waste.

Item	Part No.
Photocatalytic deodorizing filter (with frame)	KAZ917B41
Photocatalytic deodorizing filter (without frame)	KAZ917B42
Air purifying filter (with frame)	KAF925B41
Air purifying filter (without frame)	KAF925B42

## 2.1.14 Troubleshooting

# Trouble Shooting

### These cases are not troubles.

The following cases are not air conditioner troubles but have some reasons. You may just continue using it.

Case	Explanation
<b>Operation does not start soon.</b> <ul style="list-style-type: none"> <li>When ON/OFF button was pressed soon after operation was stopped.</li> <li>When the mode was reselected.</li> </ul>	<ul style="list-style-type: none"> <li>This is to protect the air conditioner. You should wait for about 3 minutes.</li> </ul>
<b>Hot air does not flow out soon after the start of heating operation.</b>	<ul style="list-style-type: none"> <li>The air conditioner is warming up. You should wait for 1 to 4 minutes. (The system is designed to start discharging air only after it has reached a certain temperature.)</li> </ul>
<b>The heating operation stops suddenly and a flowing sound is heard.</b>	<ul style="list-style-type: none"> <li>The system is taking away the frost on the outdoor unit. You should wait for about 4 to 12 minutes.</li> </ul>
<b>The outdoor unit emits water or steam.</b>	<ul style="list-style-type: none"> <li>In HEAT mode <ul style="list-style-type: none"> <li>The frost on the outdoor unit melts into water or steam when the air conditioner is in defrost operation.</li> </ul> </li> <li>In COOL or DRY mode <ul style="list-style-type: none"> <li>Moisture in the air condenses into water on the cool surface of outdoor unit piping and drips.</li> </ul> </li> </ul>
<b>Mist comes out of the indoor unit.</b>	<ul style="list-style-type: none"> <li>This happens when the air in the room is cooled into mist by the cold air flow during cooling operation.</li> <li>This is because the air in the room is cooled by the heat exchanger and becomes mist during defrost operation.</li> </ul>
<b>The indoor unit gives out odour.</b>	<ul style="list-style-type: none"> <li>This happens when smells of the room, furniture, or cigarettes are absorbed into the unit and discharged with the air flow. (If this happens, we recommend you to have the indoor unit washed by a technician. Consult the service shop where you bought the air conditioner.)</li> </ul>
<b>The outdoor fan rotates while the air conditioner is not in operation.</b>	<ul style="list-style-type: none"> <li>After operation is stopped: <ul style="list-style-type: none"> <li>The outdoor fan continues rotating for another 60 seconds for system protection.</li> </ul> </li> <li>While the air conditioner is not in operation: <ul style="list-style-type: none"> <li>When the outdoor temperature is very high, the outdoor fan starts rotating for system protection.</li> </ul> </li> </ul>
<b>The operation stopped suddenly. (OPERATION lamp is on.)</b>	<ul style="list-style-type: none"> <li>For system protection, the air conditioner may stop operating on a sudden large voltage fluctuation. It automatically resumes operation in about 3 minutes.</li> </ul>

**Check again.**

Please check again before calling a repair person.

<b>Case</b>	<b>Check</b>
<b>The air conditioner does not operate.</b> <b>(OPERATION lamp is off.)</b>	<ul style="list-style-type: none"> <li>• Hasn't a breaker turned OFF or a fuse blown?</li> <li>• Isn't it a power failure?</li> <li>• Are batteries set in the remote controller?</li> <li>• Is the timer setting correct?</li> </ul>
<b>Cooling (Heating) effect is poor.</b>	<ul style="list-style-type: none"> <li>• Are the air filters clean?</li> <li>• Is there anything to block the air inlet or the outlet of the indoor and the outdoor units?</li> <li>• Is the temperature setting appropriate?</li> <li>• Are the windows and doors closed?</li> <li>• Are the air flow rate and the air direction set appropriately?</li> </ul>
<b>Operation stops suddenly.</b> <b>(OPERATION lamp flashes.)</b>	<ul style="list-style-type: none"> <li>• Are the air filters clean?</li> <li>• Is there anything to block the air inlet or the outlet of the indoor and the outdoor units?</li> </ul> <p>Clean the air filters or take all obstacles away and turn the breaker OFF. Then turn it ON again and try operating the air conditioner with the remote controller. If the lamp still blinks, call the service shop where you bought the air conditioner.</p> <ul style="list-style-type: none"> <li>• Are operation modes all the same for indoor units connected to outdoor units in the <b>multi system</b>?</li> </ul> <p>If not, set all indoor units to the same operation mode and confirm that the lamps flash.</p> <p>Moreover, when the operation mode is in "AUTO", set all indoor unit operation modes to "COOL" or "HEAT" for a moment and check again that the lamps are normal.</p> <p>If the lamps stop flashing after the above steps, there is no malfunction.</p>
<b>An abnormal functioning happens during operation.</b>	<ul style="list-style-type: none"> <li>• The air conditioner may malfunction with lightning or radio waves. Turn the breaker OFF, turn it ON again and try operating the air conditioner with the remote controller.</li> </ul>

**Call the service shop immediately.**

 **WARNING**

- When an abnormality (such as a burning smell) occurs, stop operation and turn the breaker OFF.  
Continued operation in an abnormal condition may result in troubles, electric shocks or fire.  
Consult the service shop where you bought the air conditioner.
- Do not attempt to repair or modify the air conditioner by yourself.  
Incorrect work may result in electric shocks or fire.  
Consult the service shop where you bought the air conditioner.

If one of the following symptoms takes place, call the service shop immediately.

<ul style="list-style-type: none"> <li>■ <b>The power cord is abnormally hot or damaged.</b></li> <li>■ <b>An abnormal sound is heard during operation.</b></li> <li>■ <b>The safety breaker, a fuse, or the earth leakage breaker cuts off the operation frequently.</b></li> <li>■ <b>A switch or a button often fails to work properly.</b></li> <li>■ <b>There is a burning smell.</b></li> <li>■ <b>Water leaks from the indoor unit.</b></li> </ul>		<p>Turn the breaker OFF and call the service shop.</p>
---	---	--

<ul style="list-style-type: none"> <li>■ <b>After a power failure</b> The air conditioner automatically resumes operation in about 3 minutes. You should just wait for a while.</li> </ul>	<ul style="list-style-type: none"> <li>■ <b>Lightning</b> If lightning may strike the neighboring area, stop operation and turn the breaker OFF for system protection.</li> </ul>
--	---

**Disposal requirements**



Your air conditioning product is marked with this symbol. This means that electrical and electronic products shall not be mixed with unsorted household waste.

Do not try to dismantle the system yourself: the dismantling of the air conditioning system, treatment of the refrigerant, of oil and of other parts must be done by a qualified installer in accordance with relevant local and national legislation.

Air conditioners must be treated at a specialized treatment facility for re-use, recycling and recovery. By ensuring this product is disposed of correctly, you will help to prevent potential negative consequences for the environment and human health. Please contact the installer or local authority for more information.

Batteries must be removed from the remote controller and disposed of separately in accordance with relevant local and national legislation.

**We recommend periodical maintenance.**

In certain operating conditions, the inside of the air conditioner may get foul after several seasons of use, resulting in poor performance. It is recommended to have periodical maintenance by a specialist aside from regular cleaning by the user. For specialist maintenance, contact the service shop where you bought the air conditioner.

The maintenance cost must be born by the user.

## 2.2 FTXS-G, FVXS-F Series

### 2.2.1 Manual Contents and Reference Page

Model Series	Wall Mounted Type	Floor Standing Type
	FTXS20-50G	FVXS25-50F
<b>Read Before Operation</b>		
Safety Precautions	150	150
Names of Parts	152	155
Preparation Before Operation ★1	158	158
<b>Operation</b>		
AUTO, DRY, COOL, HEAT, FAN Operation ★1	161	161
Adjusting the Airflow Direction	163	165
Comfort Airflow and INTELLIGENT EYE Operation	167	—
POWERFUL Operation ★1	170	170
OUTDOOR UNIT QUIET Operation ★1	171	171
ECONO Operation ★1	172	172
HOME LEAVE Operation	—	—
INTELLIGENT EYE Operation	—	—
TIMER Operation ★1	173	173
WEEKLY TIMER Operation ★1	175	175
Note for Multi System ★1	180	180
<b>Care</b>		
Care and Cleaning	182	185
<b>Trouble Shooting</b>		
Trouble Shooting	188	188
Drawing No.	3P207037-1B	3P191290-1F

★1 : Illustrations are for wall mounted type FTXS20/25/35/42/50G as representative.



## 2.2.2 Safety Precautions

# Safety precautions





- Keep this manual where the operator can easily find them.
- Read this manual attentively before starting up the unit.
- For safety reason the operator must read the following cautions carefully.
- This manual classifies precautions into WARNINGS and CAUTIONS. Be sure to follow all precautions below: they are all important for ensuring safety.

### WARNING

If you do not follow these instructions exactly, the unit may cause property damage, personal injury or loss of life.

### CAUTION

If you do not follow these instructions exactly, the unit may cause minor or moderate property damage or personal injury.

-  Never do.
-  Be sure to earth the air conditioner.
-  Never touch the air conditioner (including the remote controller) with a wet hand.
-  Be sure to follow the instructions.
-  Never cause the air conditioner (including the remote controller) to get wet.

### WARNING

- In order to avoid fire, explosion or injury, do not operate the unit when harmful, among which flammable or corrosive gases, are detected near the unit. 
- It is not good for health to expose your body to the airflow for a long time.
- Do not put a finger, a rod or other objects into the air outlet or inlet. As the fan is rotating at a high speed, it will cause injury.
- Do not attempt to repair, relocate, modify or reinstall the air conditioner by yourself. Incorrect work will cause electric shocks, fire etc.  
For repairs and reinstallation, consult your Daikin dealer for advice and information.

- The refrigerant used in the air conditioner is safe. Although leaks should not occur, if for some reason any refrigerant happens to leak into the room, make sure it does not come in contact with any flame as of gas heaters, kerosene heaters or gas range. 
- If the air conditioner is not cooling (heating) properly, the refrigerant may be leaking, so call your dealer. When carrying out repairs accompanying adding refrigerant, check the content of the repairs with our service staff.
- Do not attempt to install the air conditioner by your self. Incorrect work will result in water leakage, electric shocks or fire. For installation, consult the dealer or a qualified technician.
- In order to avoid electric shock, fire or injury, if you detect any abnormally such as smell of fire, stop the operation and turn off the breaker. And call your dealer for instructions.
- Depending on the environment, an earth leakage breaker must be installed. Lack of an earth leakage breaker may result in electric shocks or fire.

- The air conditioner must be earthed. Incomplete earthing may result in electric shocks. Do not connect the earth line to a gas pipe, water pipe, lightning rod, or a telephone earth line. 

### CAUTION

- In order to avoid any quality deterioration, do not use the unit for cooling precision instruments, food, plants, animals or works of art. 
- Never expose little children, plants or animals directly to the airflow.
- Do not place appliances which produce open fire in places exposed to the airflow from the unit or under the indoor unit. It may cause incomplete combustion or deformation of the unit due to the heat.

- Do not block air inlets nor outlets. Impaired airflow may result in insufficient performance or trouble.
- Do not stand or sit on the outdoor unit. Do not place any object on the unit to avoid injury, do not remove the fan guard.
- Do not place anything under the indoor or outdoor unit that must be kept away from moisture. In certain conditions, moisture in the air may condense and drip.
- After a long use, check the unit stand and fittings for damage.
- Do not touch the air inlet and aluminum fins of outdoor unit. It may cause injury.
- The appliance is not intended for use by young children or infirm persons without supervision.
- Young children should be supervised to ensure that they do not play with the appliance.

- To avoid oxygen deficiency, ventilate the room sufficiently if equipment with burner is used together with the air conditioner. 
- Before cleaning, be sure to stop the operation, turn the breaker off or pull out the supply cord.
- Do not connect the air conditioner to a power supply different from the one as specified. It may cause trouble or fire.
- Arrange the drain hose to ensure smooth drainage. Incomplete draining may cause wetting of the building, furniture etc.
- Do not place objects in direct proximity of the outdoor unit and do not let leaves and other debris accumulate around the unit.  
Leaves are a hotbed for small animals which can enter the unit. Once in the unit, such animals can cause malfunctions, smoke or fire when making contact with electrical parts.

- Do not operate the air conditioner with wet hands. 

- Do not wash the indoor unit with excessive water, only use a slightly wet cloth. 
- Do not place things such as vessels containing water or anything else on top of the unit. Water may penetrate into the unit and degrade electrical insulations, resulting in an electric shock.

### Installation site.

- To install the air conditioner in the following types of environments, consult the dealer.
  - Places with an oily ambient or where steam or soot occurs.
  - Salty environment such as coastal areas.
  - Places where sulfide gas occurs such as hot springs.
  - Places where snow may block the outdoor unit.

The drain from the outdoor unit must be discharged to a place of good drainage.

### Consider nuisance to your neighbours from noises.

- For installation, choose a place as described below.
  - A place solid enough to bear the weight of the unit which does not amplify the operation noise or vibration.
  - A place from where the air discharged from the outdoor unit or the operation noise will not annoy your neighbours.

### Electrical work.

- For power supply, be sure to use a separate power circuit dedicated to the air conditioner.

### System relocation.

- Relocating the air conditioner requires specialized knowledge and skills. Please consult the dealer if relocation is necessary for moving or remodeling.

### 2.2.3 Names of Parts

FTXS 20/25/35/42/50 G

## Names of parts

### ■ Indoor Unit

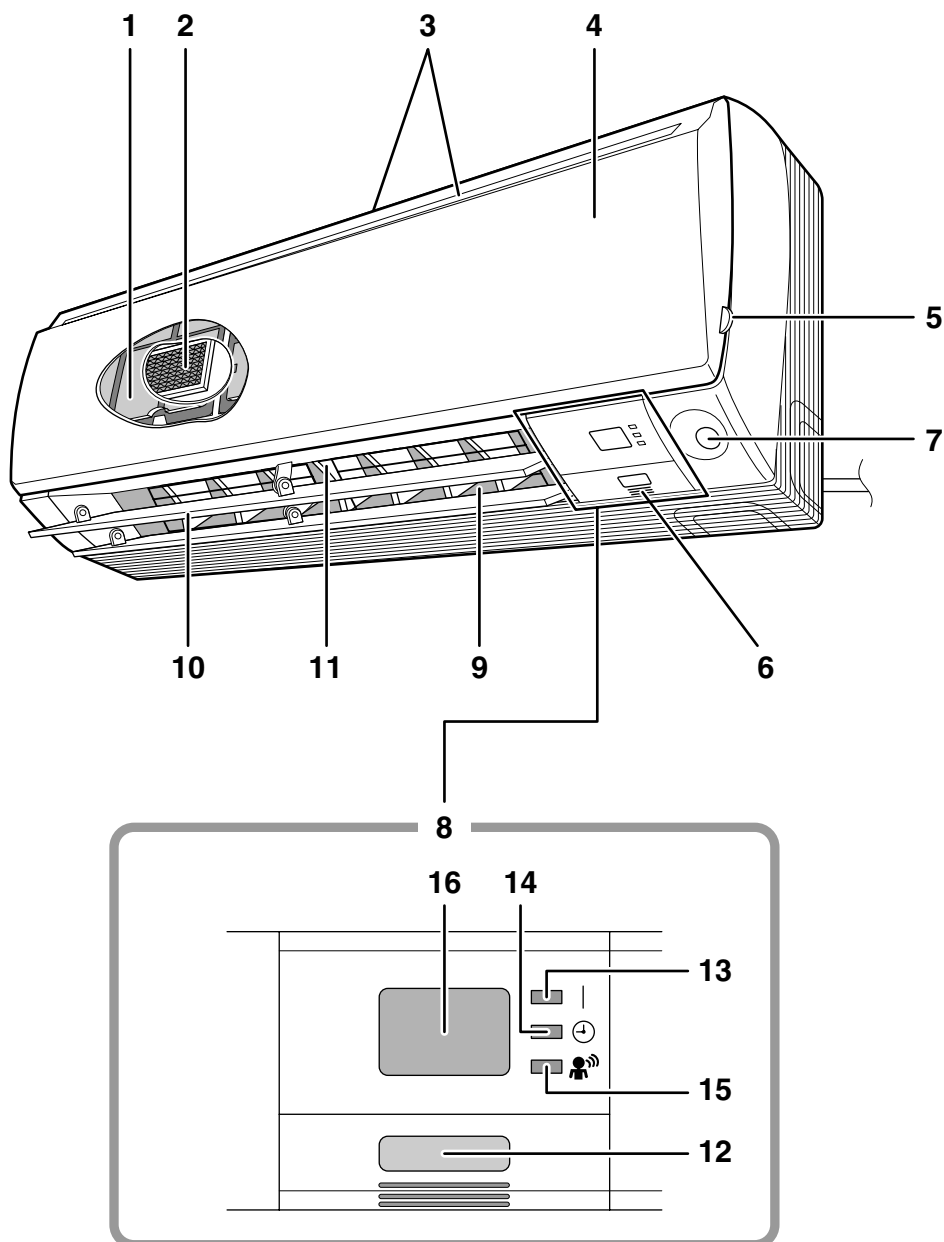

## ■ Outdoor Unit

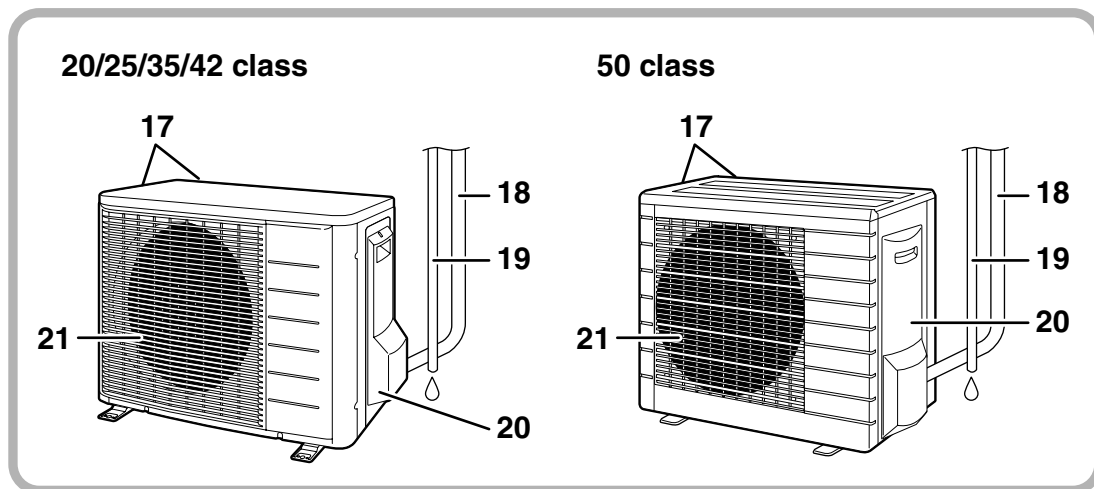

## ■ Indoor Unit

1. Air filter
2. Titanium Apatite Photocatalytic Air-Purifying Filter:
  - These filters are attached to the inside of the air filters.
3. Air inlet
4. Front panel
5. Panel tab
6. Room temperature sensor:
  - It senses the air temperature around the unit.
7. INTELLIGENT EYE sensor
8. Display
9. Air outlet
10. Horizontal blades (flaps)
11. Vertical blades (louvers):
  - The louvers are inside of the air outlet.

### 12. Indoor Unit ON/OFF switch:

- Push this switch once to start operation. Push once again to stop it.
- The operation mode refers to the following table.

Model	Mode	Temperature setting	Airflow rate
COOLING ONLY	COOL	22°C	AUTO
HEAT PUMP	AUTO	25°C	AUTO

- This switch is useful when the remote controller is missing.

### 13. Operation lamp (green)

### 14. TIMER lamp (yellow)

### 15. INTELLIGENT EYE lamp (green)

### 16. Signal receiver:

- It receives signals from the remote controller.
- When the unit receives a signal, you will hear a short beep.
  - Operation start ..... beep-beep
  - Settings changed ..... beep
  - Operation stop..... beeeeeeep

## ■ Outdoor Unit

17. Air inlet: (Back and side)
18. Refrigerant piping and inter-unit cable
19. Drain hose

### 20. Earth terminal:

- It is inside of this cover.

### 21. Air outlet

## ■ Remote Controller

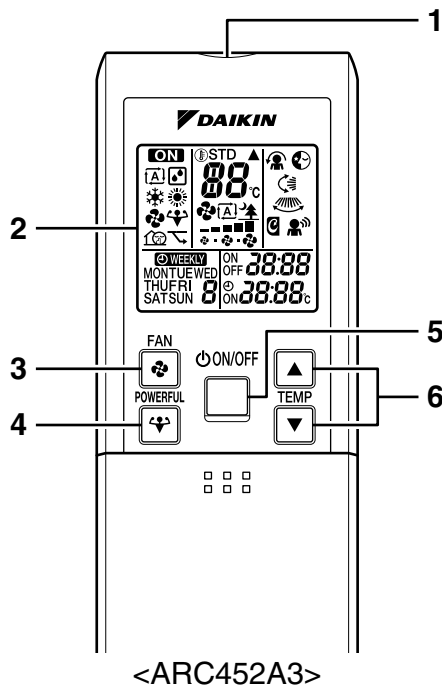

<ARC452A3>

- 1. Signal transmitter:**
  - It sends signals to the indoor unit.
- 2. Display:**
  - It displays the current settings.  
(In this illustration, each section is shown with all its displays ON for the purpose of explanation.)
- 3. FAN setting button:**
  - It selects the airflow rate setting.
- 4. POWERFUL button:**
  - POWERFUL operation
- 5. ON/OFF button:**
  - Press this button once to start operation.  
Press once again to stop it.
- 6. TEMPERATURE adjustment buttons:**
  - It changes the temperature setting.
- 7. MODE selector button:**
  - It selects the operation mode.  
(AUTO/DRY/COOL/HEAT/FAN)
- 8. QUIET button:**
  - OUTDOOR UNIT QUIET operation
- 9. ECONO button:**
  - ECONO operation
- 10. SWING button:**
  - Horizontal blades (flaps)

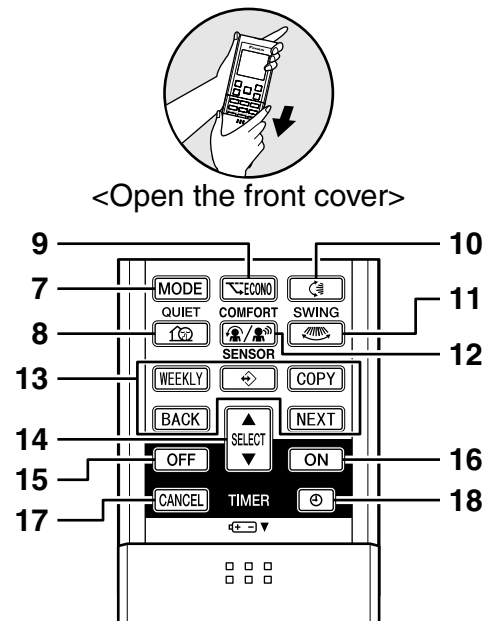

- 11. SWING button:**
  - Vertical blades (louvers)
- 12. COMFORT/SENSOR button:**
  - COMFORT AIRFLOW and INTELLIGENT EYE operation
- 13. WEEKLY/PROGRAM/COPY/BACK/NEXT button:**
  - WEEKLY TIMER operation
- 14. SELECT button:**
  - It changes the ON/OFF TIMER and WEEKLY TIMER settings.
- 15. OFF TIMER button**
- 16. ON TIMER button**
- 17. TIMER CANCEL button:**
  - It cancels the timer setting.
  - It cannot be used for the WEEKLY TIMER operation.
- 18. CLOCK button**

FVXS 25/35/50 F

# Names of parts

## ■ Indoor Unit

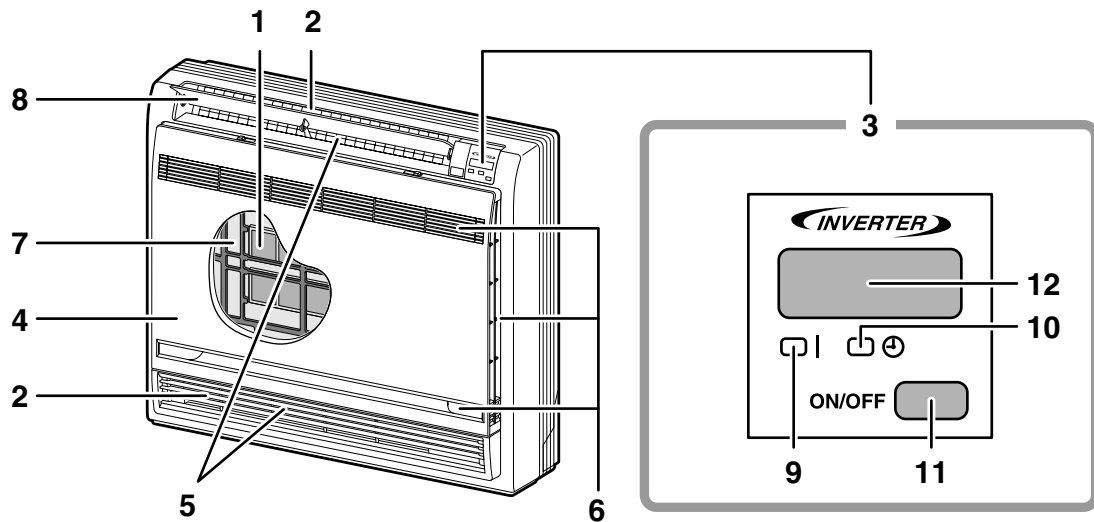

## ■ Opening the Front Panel

How to open the front panel:

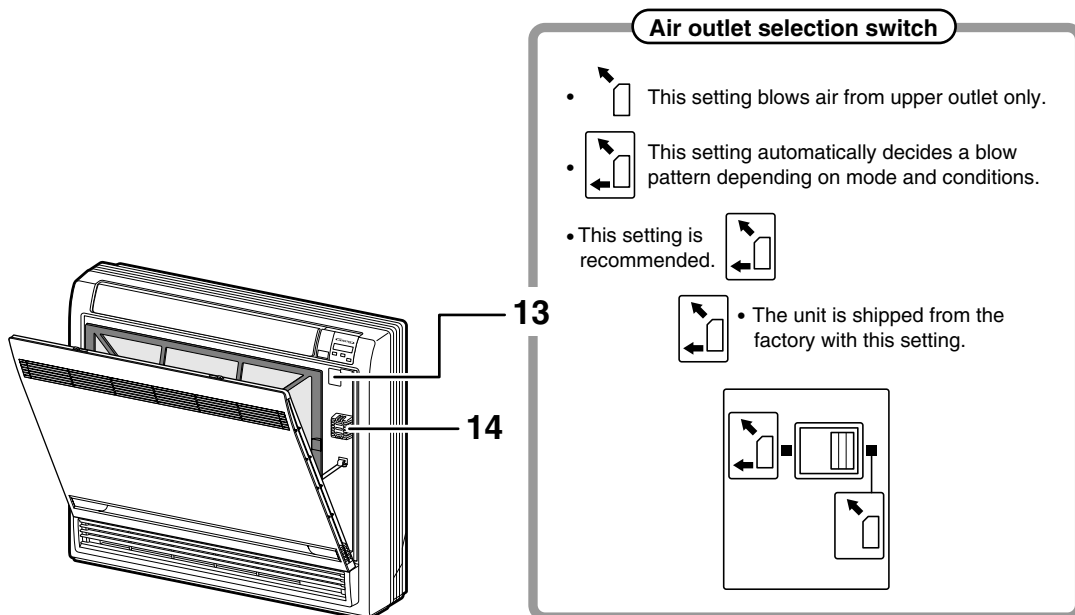

### ⚠ CAUTION

Before opening the front panel, be sure to stop the operation and turn the breaker OFF. Do not touch the metal parts on the inside of the indoor unit, as it may result in injury.

## ■ Outdoor Unit

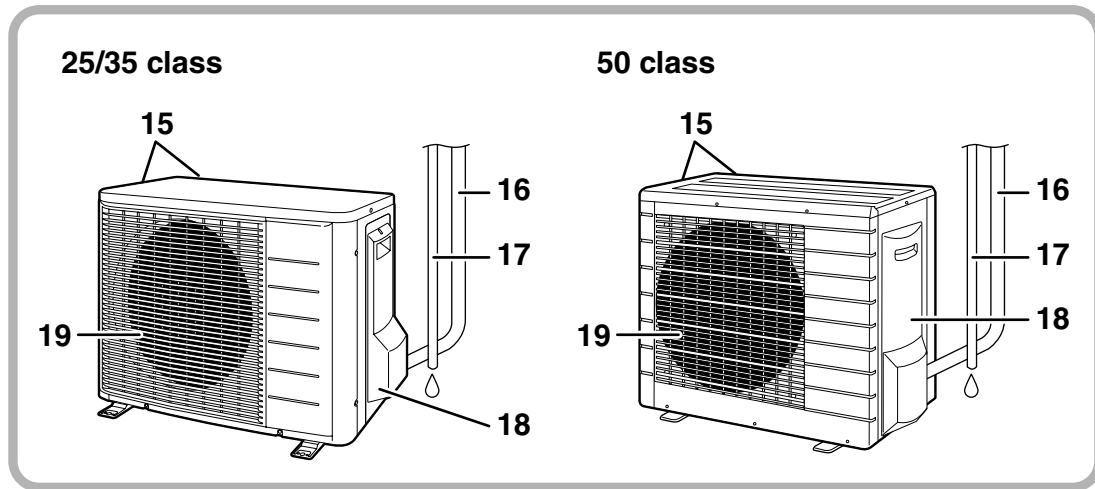

## ■ Indoor Unit

### 1. Titanium Apatite Photocatalytic Air-Purifying Filter:

- These filters are attached to the inside of the air filters.

### 2. Air outlet

### 3. Display

### 4. Front panel

### 5. Vertical blades (louvers):

- The louvers are inside of the air outlet.

### 6. Air inlet

### 7. Air filter

### 8. Horizontal blade (flap)

### 9. Operation lamp (green)

### 10. TIMER lamp (yellow)

### 11. Indoor Unit ON/OFF switch:

- Push this switch once to start operation. Push once again to stop it.

- The operation mode refers to the following table.

Model	Mode	Temperature setting	Airflow rate
COOLING ONLY	COOL	22°C	AUTO
HEAT PUMP	AUTO	25°C	AUTO

- This switch is useful when the remote controller is missing.

### 12. Signal receiver:

- It receives signals from the remote controller.
- When the unit receives a signal, you will hear a short beep.
  - Operation start ..... beep-beep
  - Settings changed ..... beep
  - Operation stop..... beeeep

### 13. Air outlet selection switch

### 14. Room temperature sensor:

- It senses the air temperature around the unit.

## ■ Outdoor Unit

15. Air inlet: (Back and side)

16. Refrigerant piping and inter-unit cable

17. Drain hose

18. Earth terminal:

- It is inside of this cover.

19. Air outlet

Appearance of the outdoor unit may differ from some models.

## ■ Remote Controller

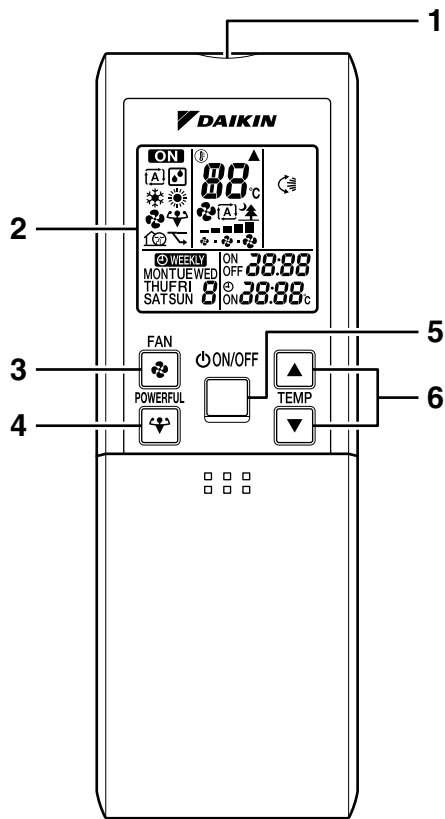

<ARC452A1>

- 1. Signal transmitter:**
  - It sends signals to the indoor unit.
- 2. Display:**
  - It displays the current settings.  
(In this illustration, each section is shown with all its displays ON for the purpose of explanation.)
- 3. FAN setting button:**
  - It selects the airflow rate setting.
- 4. POWERFUL button:**  
POWERFUL operation
- 5. ON/OFF button:**
  - Press this button once to start operation.  
Press once again to stop it.
- 6. TEMPERATURE adjustment buttons:**
  - It changes the temperature setting.
- 7. MODE selector button:**
  - It selects the operation mode.  
(AUTO/DRY/COOL/HEAT/FAN)
- 8. QUIET button:**  
OUTDOOR UNIT QUIET operation

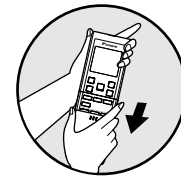

<Open the lid>

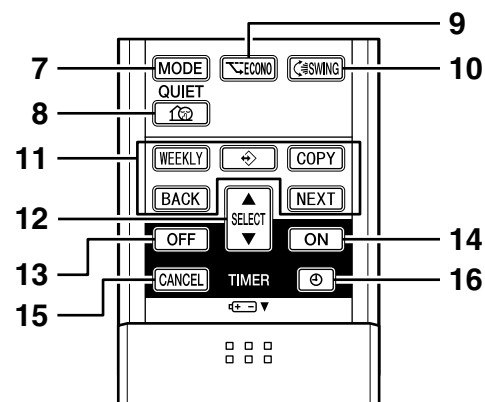

- 9. ECONO button:**  
ECONO operation
- 10. SWING button:**
  - Adjusting the Airflow Direction
- 11. WEEKLY/PROGRAM/COPY/BACK/NEXT button:**  
WEEKLY TIMER operation
- 12. SELECT button:**
  - It changes the ON/OFF TIMER and WEEKLY TIMER settings.
- 13. OFF TIMER button**
- 14. ON TIMER button**
- 15. TIMER CANCEL button:**
  - It cancels the timer setting.
  - It cannot be used for the WEEKLY TIMER operation.
- 16. CLOCK button**



## 2.2.4 Preparation Before Operation

# Preparation Before Operation

### ■ To set the batteries

1. Slide the front cover to take it off.
2. Set two dry batteries (LR03-AAA).
3. Set the front cover as before.

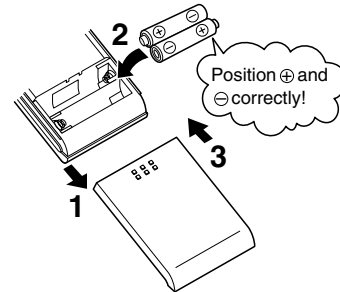

### ■ To operate the remote controller

- To use the remote controller, aim the transmitter at the indoor unit. If there is anything to block signals between the unit and the remote controller, such as a curtain, the unit will not operate.
- Do not drop the remote controller. Do not get it wet.
- The maximum distance for communication is about 7m.

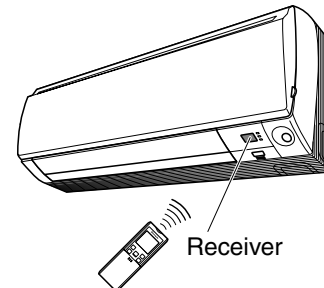

### ■ To fix the remote controller holder on the wall

1. Choose a place from where the signals reach the unit.
2. Fix the holder to a wall, a pillar, or similar location with the screws procured locally.
3. Place the remote controller in the remote controller holder.

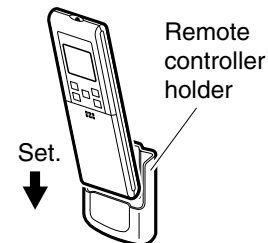

- To remove, pull it upwards.

## ATTENTION

### ■ About batteries

- When replacing the batteries, use batteries of the same type, and replace the two old batteries together.
- When the system is not used for a long time, take the batteries out.
- The batteries will last for approximately one year. If the remote controller display begins to fade and the degradation of reception performance occurs within a year, however, replace both two batteries with new size AAA alkaline batteries.
- The attached batteries are provided for the initial use of the system.  
The usable period of the batteries may be short depending on the manufactured date of the air conditioner.

### ■ About remote controller

- Never expose the remote controller to direct sunlight.
- Dust on the signal transmitter or receiver will reduce the sensitivity. Wipe off dust with soft cloth.
- Signal communication may be disabled if an electronic-starter-type fluorescent lamp (such as inverter-type lamps) is in the room. Consult the shop if that is the case.
- If the remote controller signals happen to operate another appliance, move that appliance to somewhere else, or consult the shop.

# Preparation Before Operation

## ■ To set the clock

1. Press “**CLOCK button**”.

0:00 is displayed.

MON and  blinks.

2. Press “**SELECT button**” to set the current day of the week.

3. Press “**CLOCK button**”.

 blinks.

4. Press “**SELECT button**” to set the clock to the present time.

Holding down “▲” or “▼” button rapidly increases or decreases the time display.

5. Press “**CLOCK button**”.

Always point the remote controller at the indoor unit when pushing the buttons when setting the indoor unit’s internal clock.

 blinks.

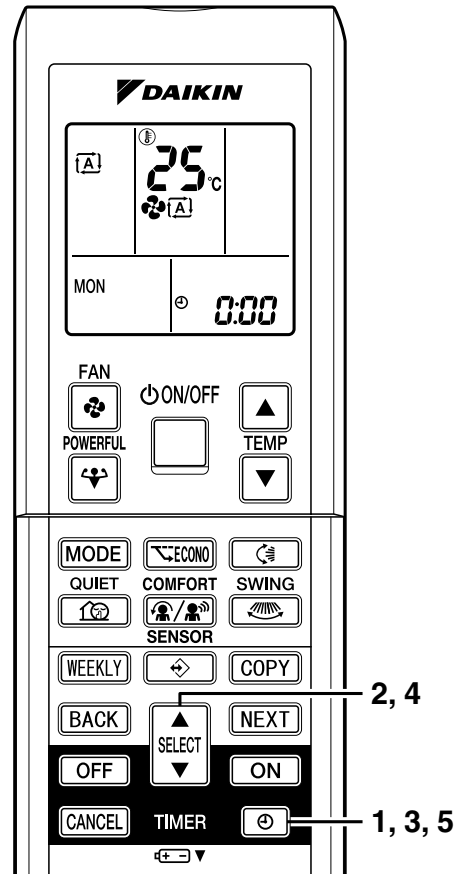

## NOTE

- If the indoor unit’s internal clock is not set to the correct time, the WEEKLY TIMER will not operate punctually.

## ■ Turn the breaker ON

- Turning ON the breaker opens once and closes the flaps. (This is a normal procedure.)

## ■ Checks on Remote Controller Settings

- This remote controller is common to the heat pump model and cooling only model. Use the dipswitches on the remote controller to set the heat pump model or cooling only model.
- Refer to the following explanation and make the setting as shown in the illustration.
  - For customers of Heat pump model: Set to H/P
  - For customers of Cooling-only model: Set to C/O

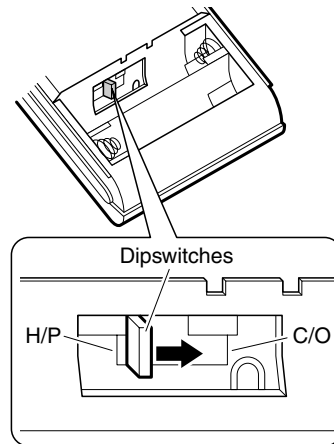

## NOTE

### ■ Tips for saving energy

- Be careful not to cool (heat) the room too much. Keeping the temperature setting at a moderate level helps save energy.
- Cover windows with a blind or a curtain. Blocking sunlight and air from outdoors increases the cooling (heating) effect.
- Clogged air filters cause inefficient operation and waste energy. Clean them once in about every two weeks.

Recommended temperature setting
For cooling: 26°C – 28°C
For heating: 20°C – 24°C

### ■ Please note

- The air conditioner always consumes 15-35 watts of electricity even while it is not operating.
- If you are not going to use the air conditioner for a long period, for example in spring or autumn, turn the breaker OFF.
- Use the air conditioner in the following conditions.

Mode	Operating conditions	If operation is continued out of this range
COOL	Outdoor temperature: <2MK(X)S> 10 to 46°C <3/4/5MK(X)S> -10 to 46°C <RK(X)S> -10 to 46°C Indoor temperature: 18 to 32°C Indoor humidity: 80% max.	<ul style="list-style-type: none"> <li>• A safety device may work to stop the operation. (In multi system, it may work to stop the operation of the outdoor unit only.)</li> <li>• Condensation may occur on the indoor unit and drip.</li> </ul>
HEAT	Outdoor temperature: <2/3/4/5MXS> -15 to 20°C <RXS> -15 to 20°C Indoor temperature: 10 to 30°C	<ul style="list-style-type: none"> <li>• A safety device may work to stop the operation.</li> </ul>
DRY	Outdoor temperature: <2MK(X)S> 10 to 46°C <3/4/5MK(X)S> -10 to 46°C <RK(X)S> -10 to 46°C Indoor temperature: 18 to 32°C Indoor humidity: 80% max.	<ul style="list-style-type: none"> <li>• A safety device may work to stop the operation.</li> <li>• Condensation may occur on the indoor unit and drip.</li> </ul>

- The operation of the system outside the above humidity or temperature range may cause a safety device to disable the system.

## 2.2.5 AUTO • DRY • COOL • HEAT • FAN Operation

# AUTO • DRY • COOL • HEAT • FAN Operation

The air conditioner operates with the operation mode of your choice.

From the next time on, the air conditioner will operate with the same operation mode.

### ■ To start operation

#### 1. Press “MODE selector button” and select a operation mode.

- Each pressing of the button advances the mode setting in sequence.

- : AUTO
- : DRY
- : COOL
- : HEAT
- : FAN

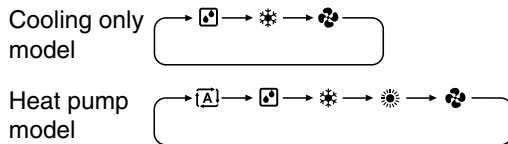

#### 2. Press “ON/OFF button”.

- The OPERATION lamp lights up.

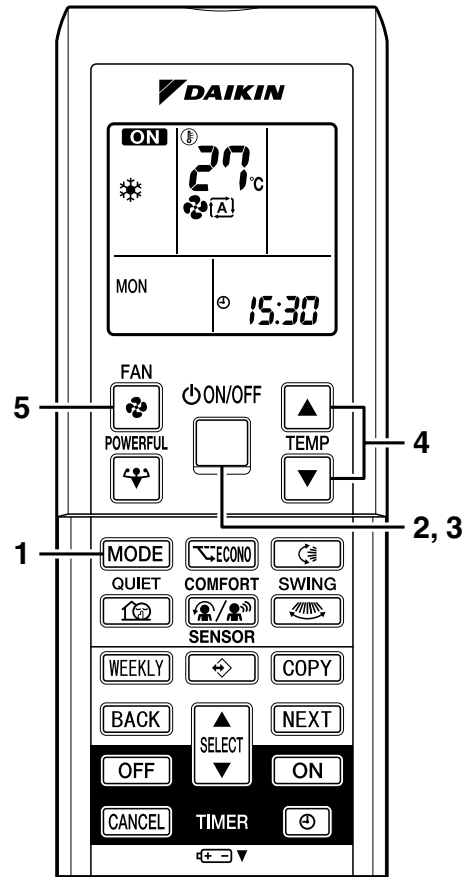
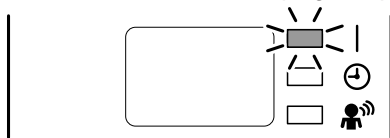

### ■ To stop operation

#### 3. Press “ON/OFF button” again.

- Then OPERATION lamp goes off.





### ■ To change the temperature setting

#### 4. Press “TEMPERATURE adjustment button”.

DRY or FAN mode	AUTO or COOL or HEAT mode
The temperature setting is not variable.	Press “▲” to raise the temperature and press “▼” to lower the temperature.
	Set to the temperature you like. 

## ■ To change the airflow rate setting

### 5. Press “FAN setting button”.

DRY mode	AUTO or COOL or HEAT or FAN mode
The airflow rate setting is not variable.	Five levels of airflow rate setting from “  ” to “  ” plus “  ” “  ” are available. 

- Indoor unit quiet operation

When the airflow is set to “”, the noise from the indoor unit will become quieter. Use this when making the noise quieter.

## NOTE

### ■ Note on HEAT operation

- Since this air conditioner heats the room by taking heat from outdoor air to indoors, the heating capacity becomes smaller in lower outdoor temperatures. If the heating effect is insufficient, it is recommended to use another heating appliance in combination with the air conditioner.
- The heat pump system heats the room by circulating hot air around all parts of the room. After the start of heating operation, it takes some time before the room gets warmer.
- In heating operation, frost may occur on the outdoor unit and lower the heating capacity. In that case, the system switches into defrosting operation to take away the frost.
- During defrosting operation, hot air does not flow out of indoor unit.
- A pinging sound may be heard during defrosting operation, which, however does not mean that the air conditioner has failures.

### ■ Note on COOL operation

- This air conditioner cools the room by blowing the hot air in the room outside, so if the outside temperature is high, the performance of the air conditioner drops.

### ■ Note on DRY operation

- The computer chip works to rid the room of humidity while maintaining the temperature as much as possible. It automatically controls temperature and airflow rate, so manual adjustment of these functions is unavailable.

### ■ Note on AUTO operation

- In AUTO operation, the system selects a temperature setting and an appropriate operation mode (COOL or HEAT) based on the room temperature at the start of the operation.
- The system automatically reselects setting at a regular interval to bring the room temperature to user-setting level.
- If you do not like AUTO operation, manually change the set temperature.

### ■ Note on airflow rate setting

- At smaller airflow rates, the cooling (heating) effect is also smaller.





## 2.2.6 Adjusting the Airflow Direction

FTXS 20/25/35/42/50 G





# Adjusting the Airflow Direction

You can adjust the airflow direction to increase your comfort.

### ■ To adjust the horizontal blades (flaps)



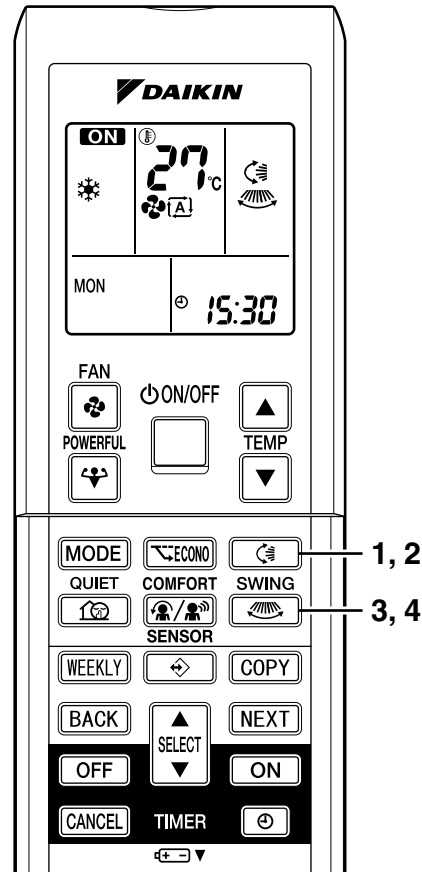

1. Press “SWING button ”.
  - “” is displayed on the LCD and the flaps will begin to swing.
2. When the flaps have reached the desired position, press “SWING button ” once more.
  - The flaps will stop moving.
  - “” disappears from the LCD.

### ■ To adjust the vertical blades (louvers)

3. Press “SWING button ”.
  - “” is displayed on the LCD.
4. When the louvers have reached the desired position, press the “SWING button ” once more.
  - The louvers will stop moving.
  - “” disappears from the LCD.



## ■ To start 3-D Airflow

3. Press the “SWING button ” and the “SWING button ”: the “” and “” display will light up and the flap and louvers will move in turn.

## ■ To cancel 3-D Airflow

4. Press either the “SWING button ” or the “SWING button ”.

## ■ COMFORT AIRFLOW operation

- Check COMFORT AIRFLOW operation in the section of “COMFORT AIRFLOW Operation” and “INTELLIGENT EYE Operation”.

## Notes on flaps and louvers angles

- When “SWING button” is selected, the flaps swinging range depends on the operation mode. (See the figure.)

### Three-Dimensional (3-D) Airflow

- Using three-dimensional airflow circulates cold air, which tends to be collected at the bottom of the room, and hot air, which tends to collect near the ceiling, throughout the room, preventing areas of cold and hot developing.

### ■ ATTENTION

- Always use a remote controller to adjust the angles of the flaps and louvers. If you attempt to move it forcibly with hand when it is swinging, the mechanism may be broken.
- Always use a remote controller to adjust the louvers angles. In side the air outlet, a fan is rotating at a high speed.

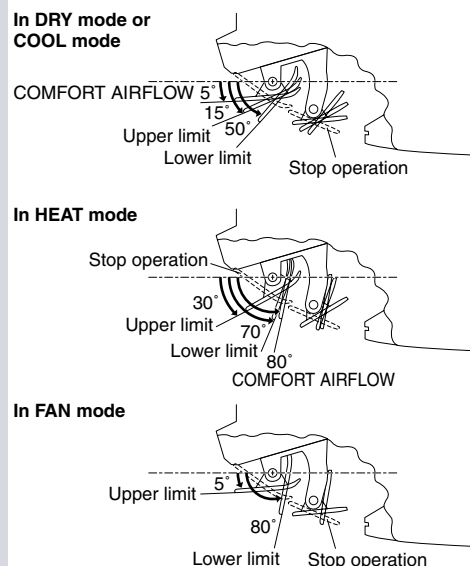

FVXS 25/35/50 F

# Adjusting the Airflow Direction

You can adjust the airflow direction to increase your comfort.

## ■ To adjust the horizontal blade (flap)

1. Press “SWING button 

## ■ To adjust the vertical blades (louvers)

Hold the knob and move the louver.  
(You will find a knob on the left-side and the right-side blades.)

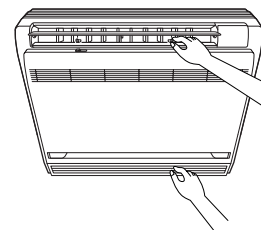

## Notes on flap and louvers angle

- Unless “SWING” is selected, you should set the flap at a near-horizontal angle in HEAT mode and at a upward position in COOL or DRY mode to obtain the best performance.

### ■ ATTENTION

- When adjusting the flap by hand, turn off the unit, and use the remote controller to restart the unit.
- Be careful when adjusting the louvers. Inside the air outlet, a fan is rotating at a high speed.

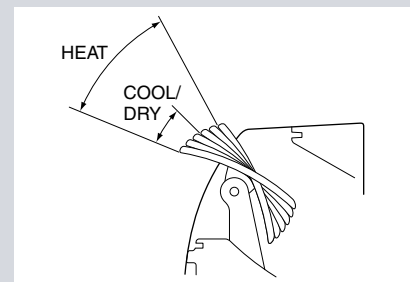



## ■ Airflow selection

- Make airflow selection according to what suits you.

### When setting the airflow selection switch to .

- Air conditioner automatically decides the appropriate blowing pattern depending on the operating mode/situation.

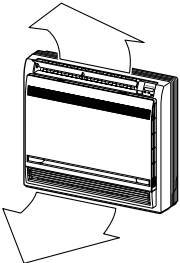
Operating mode	Situation	Blowing pattern
COOL mode	<ul style="list-style-type: none"> <li>• When the room has become fully cool, or when one hour has passed since turning on the air conditioner.</li> </ul>	<ul style="list-style-type: none"> <li>• So that air does not come into direct contact with people, air is blown upper air outlet, room temperature is equalized.</li> </ul>
	<ul style="list-style-type: none"> <li>• At start of operation or other times when the room is not fully cooled.</li> </ul>	<div style="text-align: center;">  </div> <ul style="list-style-type: none"> <li>• Air is blown from the upper and lower air outlets for high speed cooling during COOL mode, and for filling the room with warm air during HEAT mode.</li> </ul>
HEAT mode	<ul style="list-style-type: none"> <li>• At times other than below. (Normal time.)</li> </ul>	
	<ul style="list-style-type: none"> <li>• At start or when air temperature is low.</li> </ul>	

- During Dry mode, so that cold air does not come into direct contact with people, air is blown upper air outlet.

### When setting the air outlet selection switch to .

- Regardless of the operating mode or situation, air blows from the upper air outlet.
- Use this switch when you do not want air coming out of the lower air outlet. (While sleeping etc.)

## CAUTION

- Do not try to adjust the flap by hand.
- When adjusting by hand, the mechanism may not operate properly or condensation may drip from air outlets.

## 2.2.7 COMFORT AIRFLOW and INTELLIGENT EYE Operation

# COMFORT AIRFLOW and INTELLIGENT EYE Operation

The INTELLIGENT EYE incorporates infrared sensors to detect the presence of people in the conditioned room.

When these sensors detect people, the louvers will adjust the airflow direction to an area where people are not present. When there are no people in the sensing areas, the air conditioner will go into energy-saving mode.

### ■ To start operation

#### 1. Press “COMFORT/SENSOR button” and select an operation mode.

- Choose the desired operation mode out of the following sequence.
- Each time the “COMFORT/SENSOR button” is pressed a different setting option is displayed on the LCD.



### ■ To cancel operation

#### 2. Press “COMFORT/SENSOR button”.

- Press the button to select “Blank”.

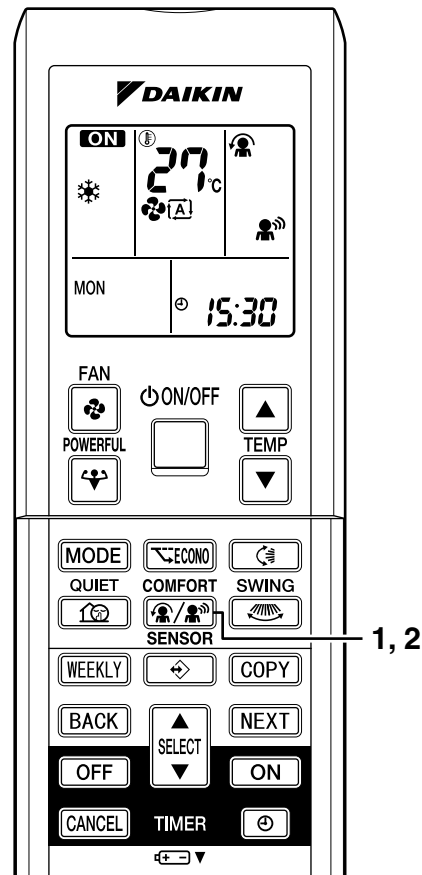

Display	Operation mode	Explanation
	COMFORT AIRFLOW	The flaps will adjust the airflow direction upward while cooling, and adjust the airflow direction downward while heating.
	INTELLIGENT EYE	The sensors will detect the movement of people in the sensing areas and the louvers will adjust the airflow direction to an area where people are not present. When there are no people in the sensing areas, the air conditioner will go into energy-saving mode.
	COMFORT AIRFLOW and INTELLIGENT EYE	The air conditioner will be in COMFORT AIRFLOW operation combined with INTELLIGENT EYE operation.
Blank	No function	—

### Notes on “COMFORT AIRFLOW Operation”

- The flap position will change, preventing air from blowing directly on the occupants of the room.
- POWERFUL operation and COMFORT AIRFLOW operation cannot be used at the same time.
- The volume of air will be set to AUTO. If the upward and downward airflow direction is selected, the COMFORT AIRFLOW function will be canceled.
- Priority is given to the function of whichever button is pressed last.
- The COMFORT AIRFLOW function makes the following airflow direction adjustments.  
The flaps will move upward while cooling so that the airflow will be directed upward.  
The flaps will move downward while heating so that the airflow will be directed downward.

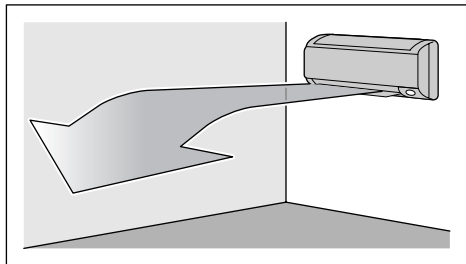

Cooling operation

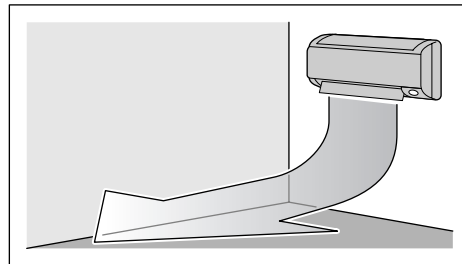

Heating operation

### Notes on “INTELLIGENT EYE Operation”

- The INTELLIGENT EYE sensor according to the following situations.

Vertical angle 90°  
(Side View)

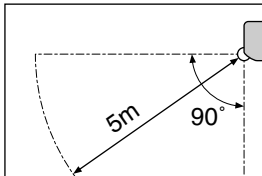

Horizontal angle 110°  
(Top View)

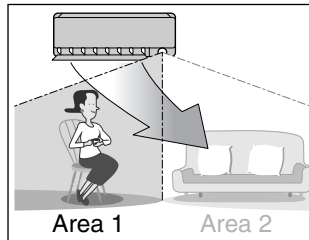
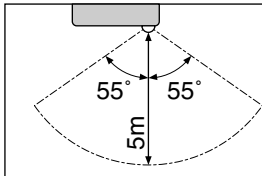

A person is detected in area 1.

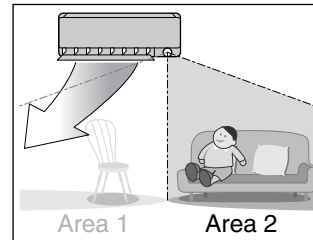

A person is detected in area 2.

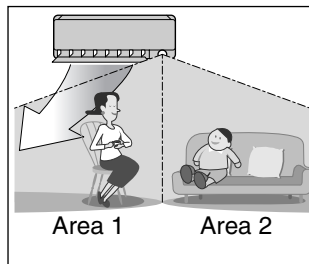

People are detected in both areas.

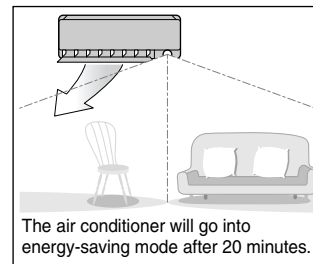

The air conditioner will go into energy-saving mode after 20 minutes.

(Use the INTELLIGENT EYE Operation in combination with the COMFORT AIRFLOW Operation.)

\* The wind direction may differ from the illustrated direction depending on the actions and movements of the people in the areas.

# COMFORT AIRFLOW and INTELLIGENT EYE Operation

## Notes on “INTELLIGENT EYE Operation”

- While the air conditioner is in INTELLIGENT EYE operation, the louvers will adjust the airflow direction if there are people in the sensing areas of the INTELLIGENT EYE so that the leftward or rightward airflow will not be directed to the people.  
If no people are detected in either area 1 or 2 in 20 minutes, the air conditioner will go into energy-saving mode with the set temperature shifted by 2°C.  
The air conditioner may go into energy-saving operation even if there are people in the areas. This may occur depending on the clothes the people are wearing if there are no movements of the people in the areas.
- The airflow direction from the louvers will be leftward if there are people in both areas 1 and 2 or if there is a person right in front of the sensors because the sensors on the both sides will detect the person.
- Due to the position of the sensor, people might be exposed to the airflow of the indoor unit if they are close to the front side of the indoor unit.  
If there are people close to the front side of the indoor unit or in both areas, it is recommended to use the COMFORT AIRFLOW and INTELLIGENT EYE functions simultaneously. When both of them are in use, the air conditioner will not direct the airflow towards the people.
- Sensor may not detect moving objects further than 5m away. (Check the application range)
- Sensor detection sensitivity changes according to indoor unit location, the speed of passersby, temperature range, etc.
- The sensor also mistakenly detects pets, sunlight, fluttering curtains and light reflected off of mirrors as passersby.
- NIGHT SET MODE will not go on during use of INTELLIGENT EYE operation.

## “INTELLIGENT EYE” is useful for Energy Saving

### ■ Energy saving operation

- Change the temperature -2°C in heating / +2°C in cooling / +2°C in dry mode from set temperature.
- Decrease the airflow rate slightly in FAN mode only. If no presence detected in the room during 20 minutes.

## ■ To combine “COMFORT AIRFLOW Operation” and “INTELLIGENT EYE Operation”

- The air conditioner can go into operation with the COMFORT AIRFLOW and INTELLIGENT EYE functions combined.  
The flaps adjust the airflow direction upward (while in cooling operation) and downward (while in heating operation), during which the sensors of the INTELLIGENT EYE are working to detect the movement of people. When the sensors detect people, the louvers will direct the airflow in such way that it will not be blown directly on them. If there are no people, the air conditioner will go into energy-saving operation after 20 minutes.

## CAUTION

- Do not place large objects near the sensor.  
Also keep heating units or humidifiers outside the sensor's detection area. This sensor can detect undesirable objects.
- Do not hit or violently push the INTELLIGENT EYE sensor. This can lead to damage and malfunction.

## 2.2.8 POWERFUL Operation

# POWERFUL Operation

POWERFUL operation quickly maximizes the cooling (heating) effect in any operation mode. You can get the maximum capacity.

### ■ To start POWERFUL operation

1. Press “POWERFUL button”.
  - POWERFUL operation ends in 20minutes. Then the system automatically operates again with the previous settings which were used before POWERFUL operation.
  - “” is displayed on the LCD.
  - When using POWERFUL operation, there are some functions which are not available.

### ■ To cancel POWERFUL operation

2. Press “POWERFUL button” again.
  - “” disappears from the LCD.

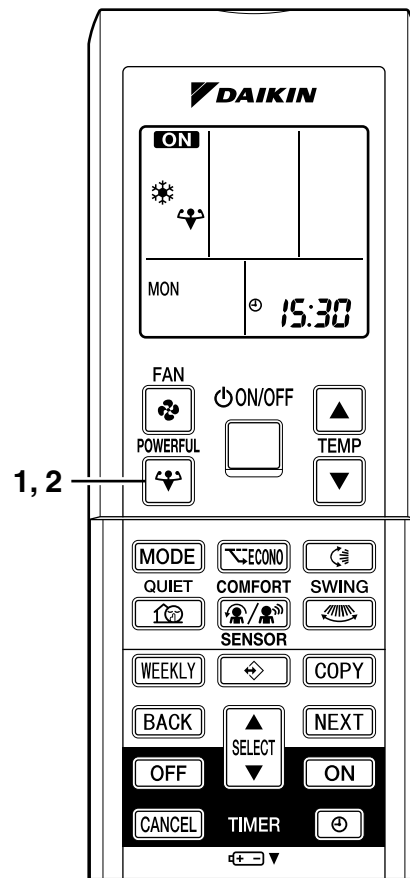

## NOTE

### ■ Notes on POWERFUL operation

- POWERFUL Operation cannot be used together with ECONO, QUIET, or COMFORT Operation. Priority is given to the function of whichever button is pressed last.
- POWERFUL Operation can only be set when the unit is running. Pressing the operation stop button causes the settings to be canceled, and the “” disappears from the LCD.
- **In COOL and HEAT mode**  
To maximize the cooling (heating) effect, the capacity of outdoor unit must be increased and the airflow rate be fixed to the maximum setting. The temperature and airflow settings are not variable.
- **In DRY mode**  
The temperature setting is lowered by 2.5°C and the airflow rate is slightly increased.
- **In FAN mode**  
The airflow rate is fixed to the maximum setting.
- **When using priority-room setting**  
See “Note for Multi System”.

## 2.2.9 OUTDOOR UNIT QUIET Operation

# OUTDOOR UNIT QUIET Operation

OUTDOOR UNIT QUIET operation lowers the noise level of the outdoor unit by changing the frequency and fan speed on the outdoor unit. This function is convenient during night.

### ■ To start OUTDOOR UNIT QUIET operation

1. Press “QUIET button”.
  - “” is displayed on the LCD.

### ■ To cancel OUTDOOR UNIT QUIET operation

2. Press “QUIET button” again.
  - “” disappears from the LCD.

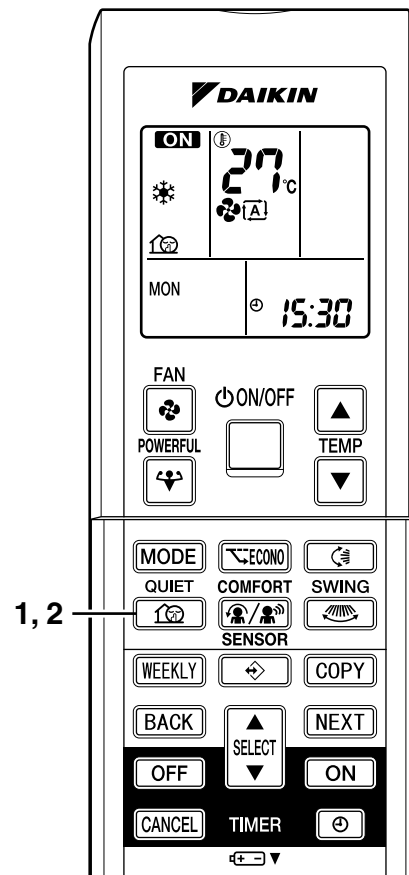

## NOTE

### ■ Note on OUTDOOR UNIT QUIET operation

- If using a multi system, this function will work only when the OUTDOOR UNIT QUIET operation is set on all operated indoor units. However, if using priority-room setting, see “Note for Multi System”.
- This function is available in COOL, HEAT, and AUTO modes. (This is not available in FAN and DRY mode.)
- POWERFUL operation and OUTDOOR UNIT QUIET operation cannot be used at the same time. Priority is given to the function of whichever button is pressed last.

## 2.2.10 ECONO Operation

# ECONO Operation

ECONO operation is a function which enables efficient operation by limiting the maximum power consumption value.

This function is useful for cases in which attention should be paid to ensure a circuit breaker will not trip when the product runs alongside other appliances.

### ■ To start ECONO operation

1. Press “ECONO button”.
  - “” is displayed on the LCD.

### ■ To cancel ECONO operation

2. Press “ECONO button” again.
  - “” disappears from the LCD.

Running current and power consumption

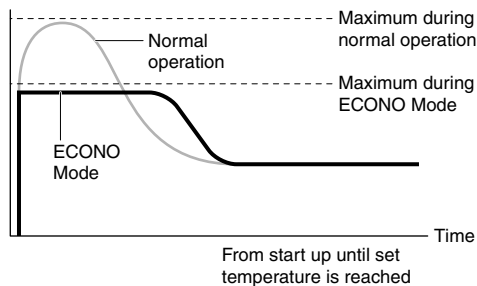

- This diagram is a representation for illustrative purposes only.
- \* The maximum running current and power consumption of the air conditioner in ECONO mode vary with the connecting outdoor unit.

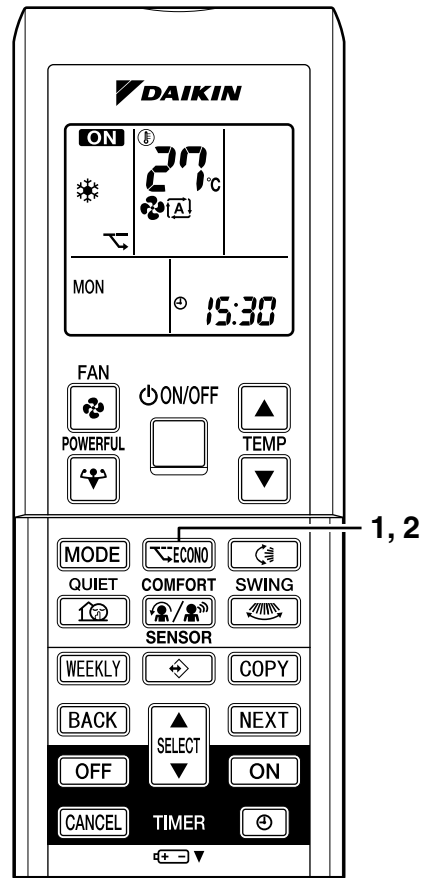

### NOTE

- ECONO Operation can only be set when the unit is running. Pressing the OFF button causes the setting to be canceled, and the “” disappears from the LCD.
- ECONO operation is a function which enables efficient operation by limiting the power consumption of the outdoor unit (operating frequency).
- ECONO operation functions in AUTO, COOL, DRY and HEAT modes.
- POWERFUL and ECONO operation cannot be used at the same time. Priority is given to the function of whichever button is pressed last.
- Power consumption may not drop even if ECONO operation is used if the level of power consumption is already low.

## 2.2.11 TIMER Operation

# TIMER Operation

Timer functions are useful for automatically switching the air conditioner on or off at night or in the morning. You can also use OFF TIMER and ON TIMER in combination.

### ■ To use OFF TIMER operation

- Check that the clock is correct.  
If not, set the clock to the present time.

#### 1. Press “OFF TIMER button”.

0:00 is displayed.

OFF blinks.

#### 2. Press “SELECT button” until the time setting reaches the point you like.

- Every pressing of either button increases or decreases the time setting by 10 minutes. Holding down either button changes the setting rapidly.

#### 3. Press “OFF TIMER button” again.

- The TIMER lamp lights up.

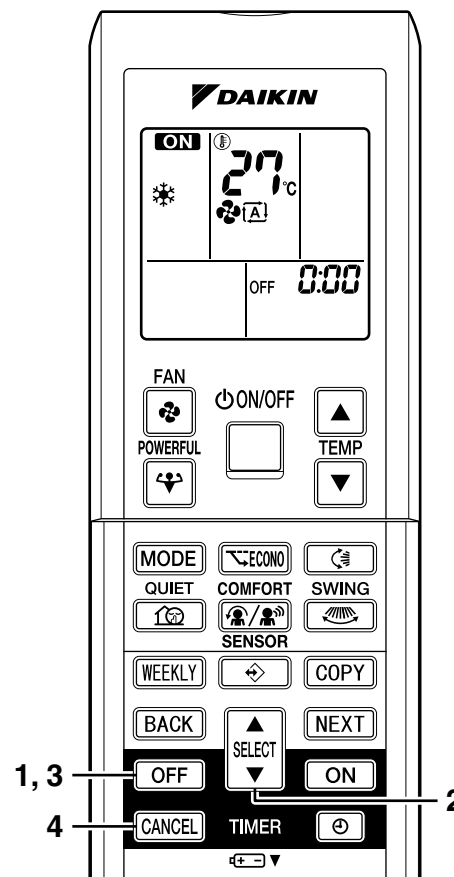

### ■ To cancel the OFF TIMER Operation

#### 4. Press “CANCEL button”.

- The TIMER lamp goes off.

## NOTE

- When TIMER is set, the present time is not displayed.
- Once you set ON, OFF TIMER, the time setting is kept in the memory. (The memory is canceled when remote controller batteries are replaced.)
- When operating the unit via the ON/OFF Timer, the actual length of operation may vary from the time entered by the user. (Maximum approx. 10 minutes)

#### ■ NIGHT SET MODE

When the OFF TIMER is set, the air conditioner automatically adjusts the temperature setting (0.5°C up in COOL, 2.0°C down in HEAT) to prevent excessive cooling (heating) for your pleasant sleep.



### ■ To use ON TIMER operation

- Check that the clock is correct. If not, set the clock to the present time.

**1. Press “ON TIMER button”.**

6:00 is displayed.

ON blinks.

**2. Press “SELECT button” until the time setting reaches the point you like.**

- Every pressing of either button increases or decreases the time setting by 10 minutes. Holding down either button changes the setting rapidly.

**3. Press “ON TIMER button” again.**

- The TIMER lamp lights up.

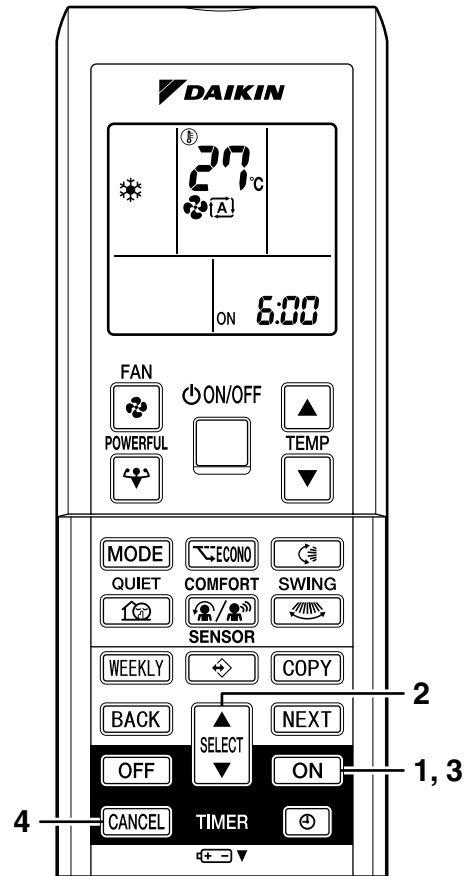

### ■ To cancel ON TIMER operation

**4. Press “CANCEL button”.**

- The TIMER lamp goes off.

### ■ To combine ON TIMER and OFF TIMER

- A sample setting for combining the two timers is shown below.

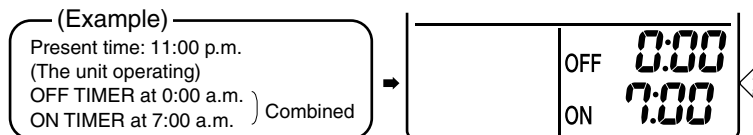

### ATTENTION

- In the following cases, set the timer again.
  - After a breaker has turned OFF.
  - After a power failure.
  - After replacing batteries in the remote controller.

## 2.2.12 WEEKLY TIMER Operation

# WEEKLY TIMER Operation

Up to 4 timer settings can be saved for each day of the week. It is convenient if the WEEKLY TIMER is set according to the family's life style.

### ■ Using in these cases of WEEKLY TIMER

An example of WEEKLY TIMER settings is shown below.

**Example:** The same timer settings are made for the week from Monday through Friday while different timer settings are made for the weekend.

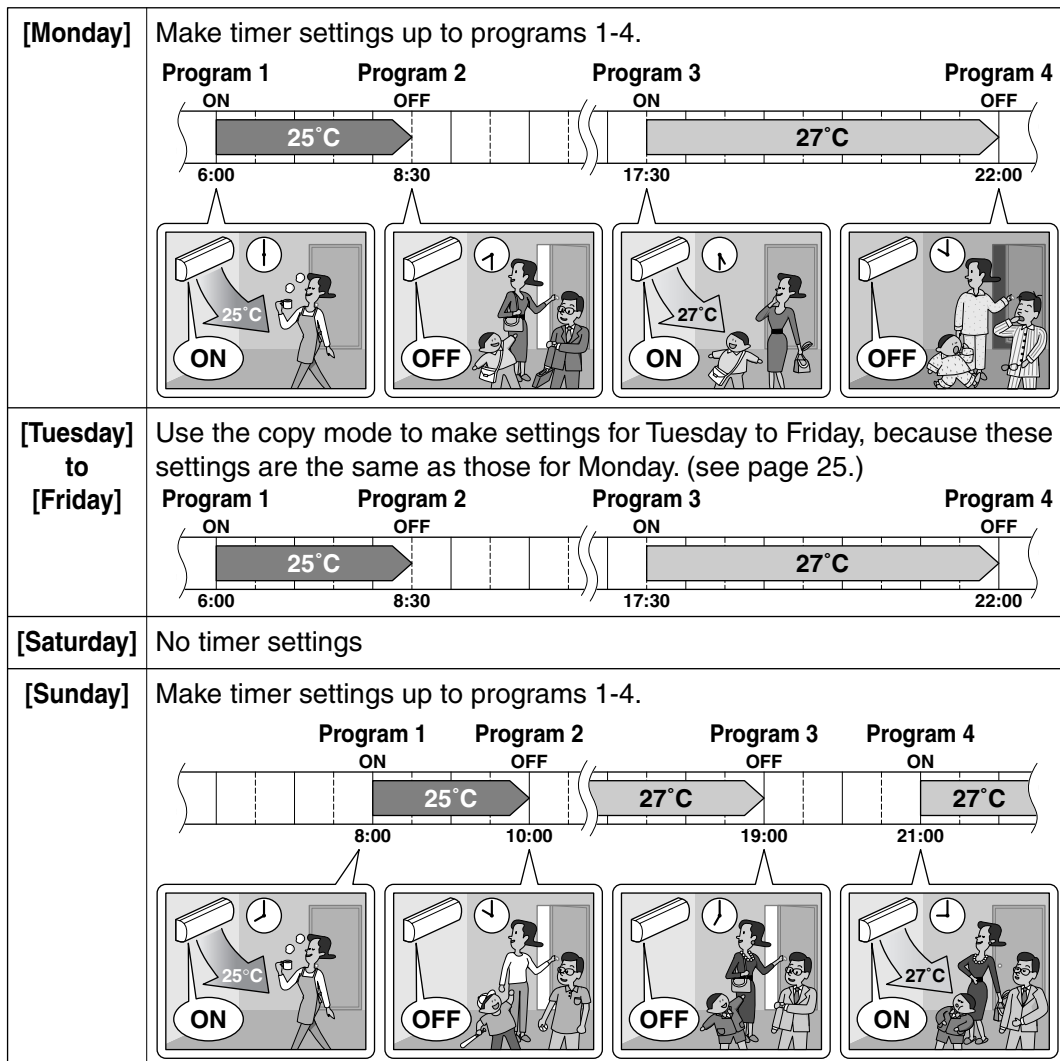

- Up to 4 reservations per day and 28 reservations per week can be set in the WEEKLY TIMER. The effective use of the copy mode ensures ease of making reservations.
- The use of ON-ON-ON-ON settings, for example, makes it possible to schedule operating mode and set temperature changes. Furthermore, by using OFF-OFF-OFF-OFF settings, only the turn-OFF time of each day can be set. This will turn OFF the air conditioner automatically if the user forgets to turn it OFF.

## ■ To use WEEKLY TIMER operation

- Make sure the day of the week and time are set. If not, set the day of the week and time.

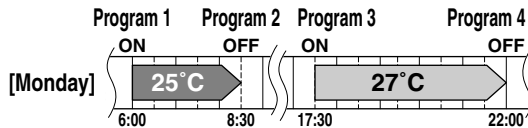

### 1. Press “” button”.

- The day of the week and the reservation number will be displayed.
- 1 to 4 settings can be made per day.

### 2. Press the “SELECT button” to select the desired day of the week and reservation number.

- Pressing the “SELECT button” changes the reservation number and the day of the week.

### 3. Press “NEXT button”.

- The day of the week will be set.
- “ WEEKLY” and “ON” blink.

### 4. Press “SELECT button” to select the desired mode.

- “ WEEKLY” and “ON” or “OFF” will flash.

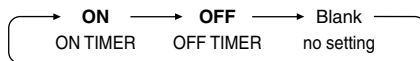

- Go to STEP 9 if “no setting” is selected.

### 5. Press “NEXT button”.

- The weekly mode will be set.
- “ WEEKLY” and “6:00” blink.

### 6. Press “SELECT button” to select the desired time.

- The time can be set between 0:00 and 23:50 in 10 minute intervals.
- Press “BACK button” to return to the mode setting.
- Go to STEP 9 if “OFF” is selected at STEP 4.

### 7. Press “NEXT button”.

- The time will be set.
- “ WEEKLY” and the temperature blink.

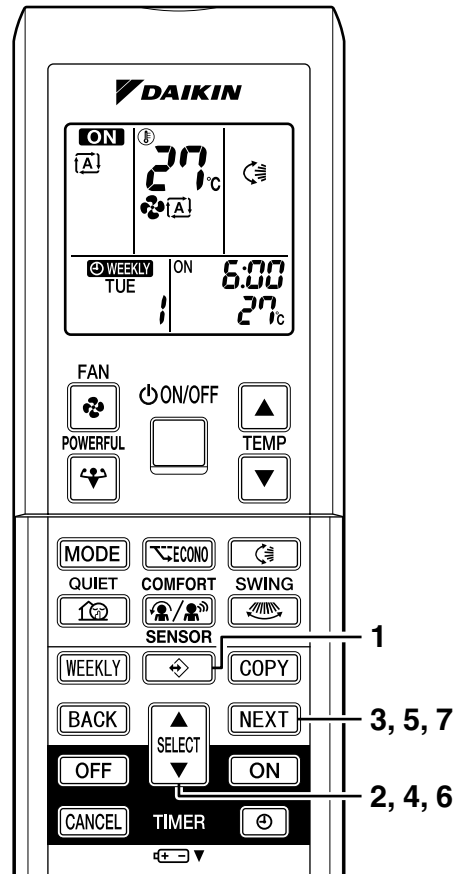

### Respective Setting Screens

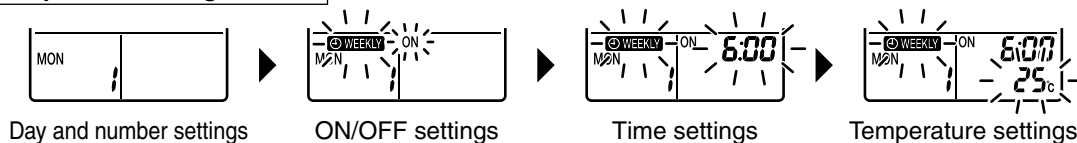

## WEEKLY TIMER Operation

### 8. Press “SELECT button” to select the desired temperature.

- The temperature can be set between 10°C and 32°C.  
Cooling: The unit operates at 18°C even if it is set at 10 to 17°C.  
Heating: The unit operates at 30°C even if it is set at 31 to 32°C.
- To return to the time setting, press “BACK button”.
- The set temperature is only displayed when the mode setting is on.

### 9. Press “NEXT button”.

- The temperature will be set and go to the next reservation setting.
- To continue further settings, repeat the procedure from STEP 2.

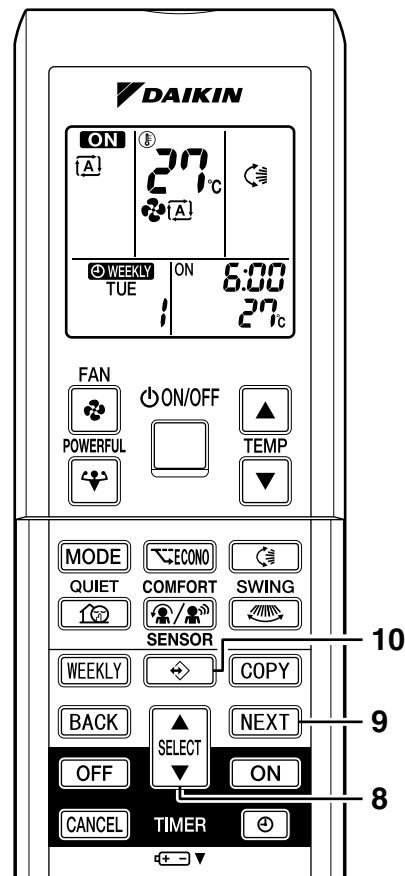

### 10. Press “ button” to complete the setting.

- Point the remote controller toward the air conditioner and press the buttons to operate. The air conditioner will beep and the operation lamp will flash.



## NOTE



### ■ WEEKLY TIMER

- Do not forget to set the time on the remote control first.
- The day of the week, ON/OFF time can be set with WEEKLY TIMER. For ON-TIMER, settings other than the above are based on the remote controller settings just before the operation.
- Both WEEKLY TIMER and ON/OFF timer cannot be used at the same time. The ON/OFF timer has priority if it is set while WEEKLY TIMER is still active. WEEKLY TIMER is activated after the reserved ON/OFF timer is completed.
- The “WEEKLY button” activates or deactivates the reservation.
- To set WEEKLY TIMER, press “ button” and make a reservation according to the procedures.
- Only the time and set temperature set with the weekly timer are sent with the “ button”. Set the weekly timer only after setting the operation mode, the fan strength, and the fan direction ahead of time.
- Up to 4 settings per day and up to 28 settings per week can be reserved with WEEKLY TIMER. If a reservation deactivated with “WEEKLY button” is activated once again, the last reservation mode will be used.
- Shutting the breaker off, power failure, and other similar events will render operation of the indoor unit’s internal clock inaccurate. Reset the clock.
- The “BACK button” can be used only for the mode, time and temperature settings. It cannot be used to go back to the reservation number.

## ■ Using copy mode

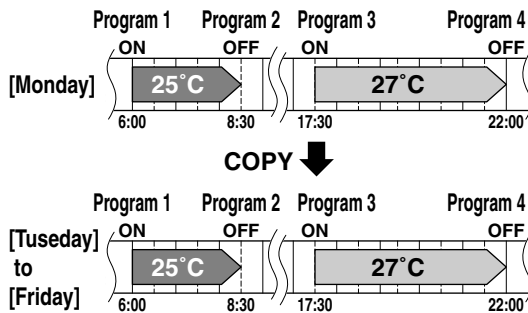
- A reservation made once can be easily copied and the same settings used for another day of the week.



1. Press “ button”.
2. Press “SELECT button” to confirm the day of the week to be copied.
3. Press “COPY button”.
  - This activates copy mode.
  - Copy whole reservation of the selected day of the week.
4. Press “SELECT button” to select the destination day of the week.
5. Press “COPY button”.
  - The reservation will be copied to the selected day of the week. The whole reservation of the selected day of the week will be copied.
  - To continue copying the settings to other days of the week, repeat STEP 4 and STEP 5.
6. Press “ button”.
  - Exit copy mode.

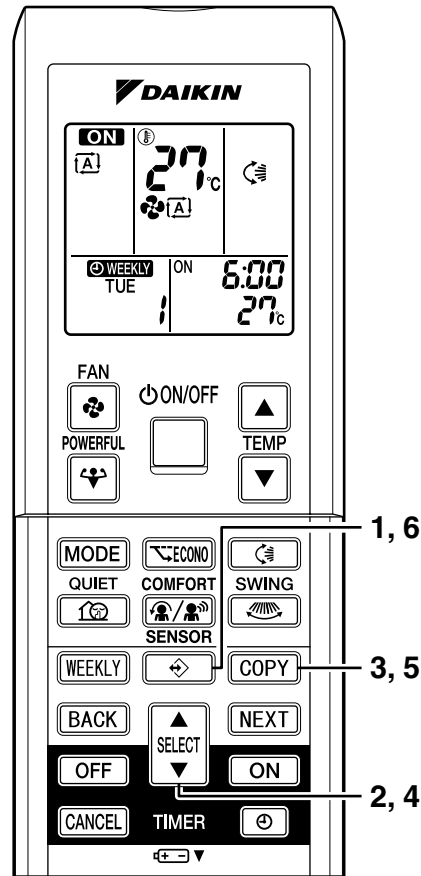

### Setting Screens

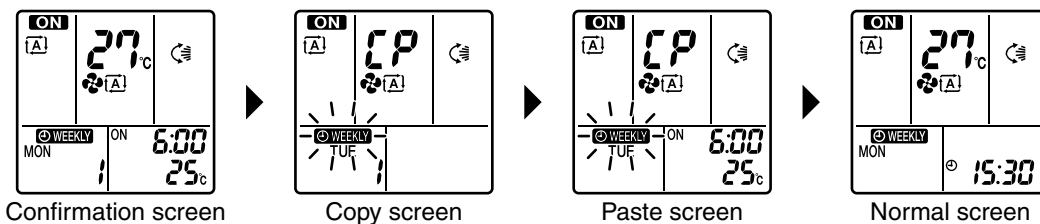



## NOTE

### ■ COPY MODE

- The entire reservation of the source day of the week is copied in the copy mode. Detailed settings can be made after the copy is completed.

# WEEKLY TIMER Operation

## ■ Confirming a reservation

- The reservation can be confirmed.
- Press “” button”.
    - The day of the week and the reservation number of the current day will be displayed.
  - Press “SELECT button” to select the day of the week and the reservation number to be confirmed.
    - Pressing the “SELECT button” displays the reservation details.
  - Press “” button”.
    - Reservation confirmation complete.

### Setting Screens



## ■ Canceling all reservations

- Hold the “WEEKLY button” for 5 seconds.
  - Be sure to direct the remote control toward the main unit and check for a receiving tone.
  - This operation is not effective while WEEKLY TIMER is being set.
  - All reservations will be canceled.

## ■ Canceling individual reservations

- This function can be used for canceling reservations for each day of the week.
  - It can be used while confirming or setting reservations.
- Select the day of the week to be canceled with the “SELECT button”.
  - Hold the “WEEKLY button” for 5 seconds.
    - The selected reservation will be canceled.

## ■ To cancel WEEKLY TIMER operation

- Press “WEEKLY button” to deactivate the WEEKLY operation.
  - The “” will disappear from the display.
  - The TIMER lamp goes off.
  - To reactivate the WEEKLY TIMER operation, press the “WEEKLY button” again.

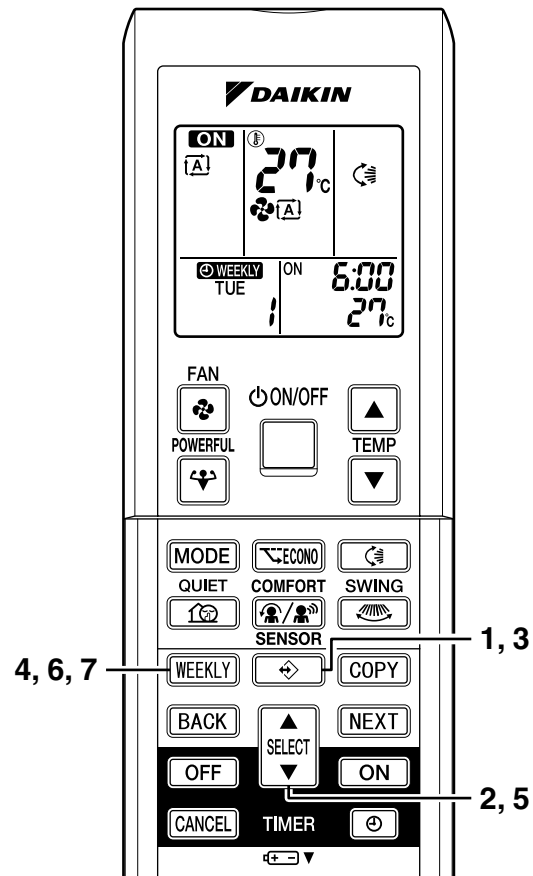

## 2.2.13 Note for Multi System

# Note for Multi System

<<What is a “Multi System”? >>

This system has one outdoor unit connected to multiple indoor units.

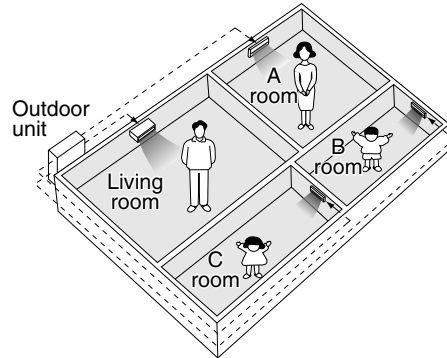

## ■ Selecting the operation mode

### 1. With the Priority Room Setting present but inactive or not present.

When more than one indoor unit is operating, priority is given to the first unit that was turned on. In this case, set the units that are turned on later to the same operation mode (\*1) as the first unit.

Otherwise, they will enter the Standby Mode, and the operation lamp will flash; this does not indicate malfunction.

(\*1)

- COOL, DRY and FAN mode may be used at the same time.
- AUTO mode automatically selects COOL mode or HEAT mode based on the room temperature. Therefore, AUTO mode is available when selecting the same operation mode as that of the room with the first unit to be turned on.

#### <CAUTION>

Normally, the operation mode in the room where the unit is first run is given priority, but the following situations are exceptions, so please keep this in mind.

If the operation mode of the first room is **FAN Mode**, then using **Heating Mode** in any room after this will give priority to **heating**. In this situation, the air conditioner running in FAN Mode will go on standby, and the operation lamp will flash.

### 2. With the Priority Room Setting active.

See “Priority Room Setting” on the next page.

## ■ NIGHT QUIET Mode (Available only for cooling operation)

NIGHT QUIET Mode requires initial programming during installation. Please consult your retailer or dealer for assistance. NIGHT QUIET Mode reduces the operation noise of the outdoor unit during the night time hours to prevent annoyance to neighbors.

- The NIGHT QUIET Mode is activated when the temperature drops 5°C or more below the highest temperature recorded that day. Therefore, when the temperature difference is less than 5°C, this function will not be activated.
- NIGHT QUIET Mode reduces slightly the cooling (heating) efficiency of the unit.

## ■ OUTDOOR UNIT QUIET operation

### 1. With the Priority Room Setting present but inactive or not present.

When using the OUTDOOR UNIT QUIET operation feature with the Multi system, set all indoor units to OUTDOOR UNIT QUIET operation using their remote controllers.

When clearing OUTDOOR UNIT QUIET operation, clear one of the operating indoor units using their remote controller. However OUTDOOR UNIT QUIET operation display remains on the remote controller for other rooms.

We recommend you release all rooms using their remote controllers.

### 2. With the Priority Room Setting active.

See “Priority Room Setting” on the next page.

## ■ Cooling / Heating mode lock (Available only for heat pump models)

The Cooling / Heating Mode Lock requires initial programming during installation. Please consult your retailer or dealer for assistance. The Cooling / Heating Mode Lock sets the unit forcibly to either Cooling or Heating Mode. This function is convenient when you wish to set all indoor units connected to the Multi system to the same operation mode.

# Note for Multi System

## ■ Priority Room Setting

The Priority Room Setting requires initial programming during installation. Please consult your retailer or dealer for assistance.

The room designated as the Priority Room takes priority in the following situations;

### 1. Operation mode Priority.

As the operation mode of the Priority Room takes precedence, the user can select a different operation mode from other rooms.

<Example>

\* Room A is the Priority Room in the examples.

When COOL mode is selected in Room A while operating the following modes in Room B,C and D:

Operation mode in Room B, C and D	Status of Room B, C and D when the unit in Room A is in COOL mode
COOL or DRY or FAN	Current operation mode maintained
HEAT	The unit enters Standby Mode. Operation resumes when the Room A unit stops operating.
AUTO	If the unit is set to COOL mode, operation continues. If set to HEAT mode, it enters Standby Mode. Operation resumes when the Room A unit stops operating.

### 2. Priority when POWERFUL operation is used.

<Example>

\* Room A is the Priority Room in the examples.

The indoor units in Rooms A,B,C and D are all operating. If the unit in Room A enters POWERFUL operation, operation capacity will be concentrated in Room A. In such a case, the cooling (heating) efficiency of the units in Rooms B,C and D may be slightly reduced.

### 3. Priority when using OUTDOOR UNIT QUIET operation.

<Example>

\* Room A is the Priority Room in the examples.

Just by setting the unit in Room A to QUIET operation, the air conditioner starts OUTDOOR UNIT QUIET operation.

You don't have to set all the operated indoor units to QUIET operation.



## 2.2.14 Care and Cleaning

FTXS 20/25/35/42/50 G

# Care and Cleaning

**⚠ CAUTION** Before cleaning, be sure to stop the operation and turn the breaker OFF.

### Units

#### ■ Indoor unit, Outdoor unit and Remote controller

1. Wipe them with dry soft cloth.

#### ■ Front panel

##### 1. Open the front panel.

- Hold the panel by the tabs on the two sides and lift it until it stops with a click.

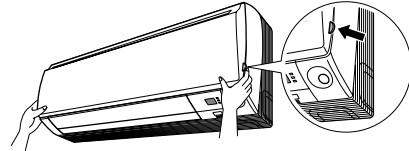

##### 2. Remove the front panel.

- Lift the front panel up, slide it slightly to the right, and remove it from the horizontal axle.

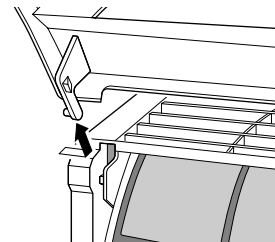

##### 3. Clean the front panel.

- Wipe it with a soft cloth soaked in water.
- Only neutral detergent may be used.
- In case of washing the panel with water, dry it with cloth, dry it up in the shade after washing.

##### 4. Attach the front panel.

- Set the 2 keys of the front panel into the slots and push them in all the way.
- Close the front panel slowly and push the panel at the 3 points. (1 on each side and 1 in the middle.)

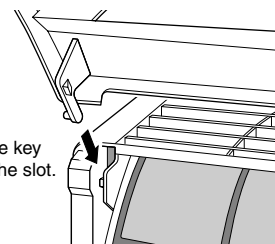

### ⚠ CAUTION

- Don't touch the metal parts of the indoor unit. If you touch those parts, this may cause an injury.
- When removing or attaching the front panel, use a robust and stable stool and watch your steps carefully.
- When removing or attaching the front panel, support the panel securely with hand to prevent it from falling.
- For cleaning, do not use hot water above 40°C, benzene, gasoline, thinner, nor other volatile oils, polishing compound, scrubbing brushes, nor other hand stuff.
- After cleaning, make sure that the front panel is securely fixed.

## Filters

1. Open the front panel.
2. Pull out the air filters.
  - Push a little upwards the tab at the center of each air filter, then pull it down.
3. Take off the Titanium Apatite Photocatalytic Air-Purifying Filter.
  - Hold the recessed parts of the frame and unhook the four claws.
4. Clean or replace each filter.
  - See figure.

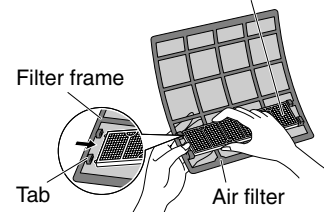
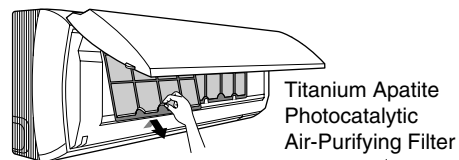
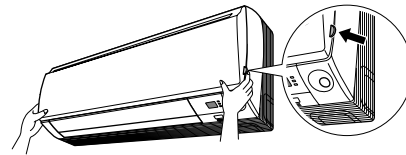

5. Set the air filter and Titanium Apatite Photocatalytic Air-Purifying Filter as they were and close the front panel.
  - Insert claws of the filters into slots of the front panel. Close the front panel slowly and push the panel at the 3 points. (1 on each side and 1 in the middle.)

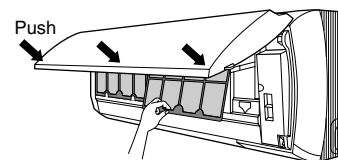

### ■ Air Filter

1. Wash the air filters with water or clean them with vacuum cleaner.
  - If the dust does not come off easily, wash them with neutral detergent thinned with lukewarm water, then dry them up in the shade.
  - It is recommended to clean the air filters every 2 weeks.

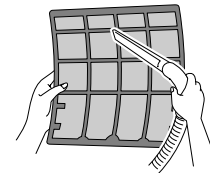

### ■ Titanium Apatite Photocatalytic Air-Purifying Filter

The Titanium Apatite Photocatalytic Air-Purifying Filter can be renewed by washing it with water once every 6 months. We recommend replacing it once every 3 years.

#### [ Maintenance ]

1. Vacuum dusts, and soak in warm water or water for about 10 to 15 minutes if dirt is heavy.
2. Do not remove filter from frame when washing with water.
3. After washing, shake off remaining water and dry in the shade.
4. Since the material is made out of polyester, do not wring out the filter when removing water from it.

#### [ Replacement ]

1. Remove the tabs on the filter frame and replace with a new filter.
  - Dispose of the old filter as non-flammable waste.

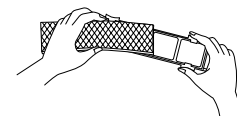

## NOTE

- Operation with dirty filters:
  - (1) cannot deodorize the air. (2) cannot clean the air.
  - (3) results in poor heating or cooling. (4) may cause odour.
- To order Titanium Apatite Photocatalytic Air-Purifying Filter contact to the service shop there you bought the air conditioner.
- Dispose of the old filter as non-flammable waste.

Item	Part No.
Titanium Apatite Photocatalytic Air-Purifying Filter (without frame) 1 set	KAF970A46

## Check

Check that the base, stand and other fittings of the outdoor unit are not decayed or corroded.

Check that nothing blocks the air inlets and the outlets of the indoor unit and the outdoor unit.

Check that the drain comes smoothly out of the drain hose during COOL or DRY operation.

- If no drain water is seen, water may be leaking from the indoor unit. Stop operation and consult the service shop if this is the case.

## ■ Before a long idle period

1. **Operate the “FAN only” for several hours on a fine day to dry out the inside.**
  - Press “MODE” button and select “FAN” operation.
  - Press “ON/OFF” button and start operation.
2. **After operation stops, turn off the breaker for the room air conditioner.**
3. **Clean the air filters and set them again.**
4. **Take out batteries from the remote controller.**

## NOTE

- When a multi outdoor unit is connected, make sure the heating operation is not used at the other room before you use the fan operation.

FVXS 25/35/50 F

# Care and Cleaning

**⚠ CAUTION** Before cleaning, be sure to stop the operation and turn the breaker OFF.

## Units

### ■ Indoor unit, Outdoor unit and Remote controller

1. Wipe them with dry soft cloth.

### ■ Front panel

#### 1. Open the front panel.

- Slide the two stoppers on the left and right sides inward until they click.

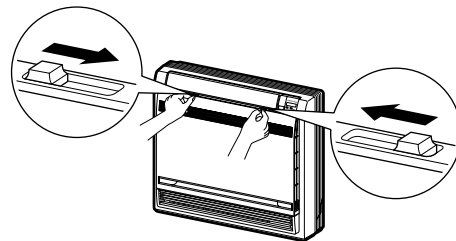

#### 2. Remove the front panel.

- Remove the string.
- Allowing the front panel to fall forward will enable you to remove it.

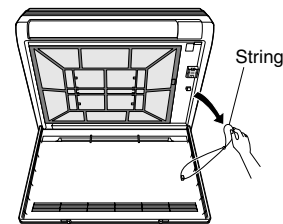

#### 3. Clean the front panel.

- Wipe it with a soft cloth soaked in water.
- Only neutral detergent may be used.
- In case of washing the front panel with water, dry it with cloth, dry it up in the shade after washing.

#### 4. Attach the front panel.

- Insert the front panel into the grooves of the unit (3 places).
- Attach the string to the right, inner-side of the front grille.
- Close the panel slowly.

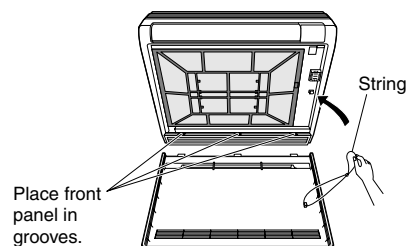

### ⚠ CAUTION

- Don't touch the metal parts of the indoor unit. If you touch those parts, this may cause an injury.
- When removing or attaching the front panel, use a robust and stable stool and watch your steps carefully.
- When removing or attaching the front panel, support the panel securely with hand to prevent it from falling.
- For cleaning, do not use hot water above 40°C, benzene, gasoline, thinner, nor other volatile oils, polishing compound, scrubbing brushes, nor other hand stuff.
- After cleaning, make sure that the front panel is securely fixed.

**Filters**

1. **Open the front panel.**
2. **Remove the air filter.**
  - Press the claws on the right and left of the air filter down slightly, then pull upward.
3. **Take off the Titanium Apatite Photocatalytic Air-Purifying Filter.**
  - Hold the tabs of the frame, and remove the claws in 4 places.
4. **Clean or replace each filter.**  
See figure.
5. **Set the air filter and Titanium Apatite Photocatalytic Air-Purifying Filter as they were and close the front panel.**
  - Operation without air filters may result in troubles as dust will accumulate inside the indoor unit.

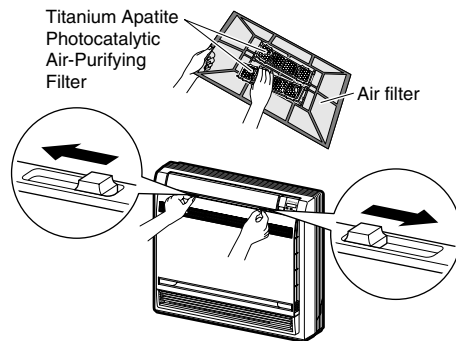
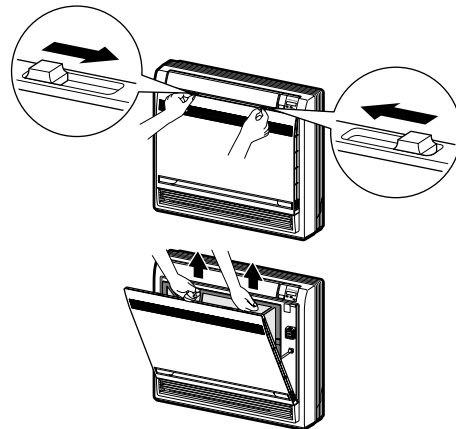

■ **Air Filter**

1. **Wash the air filters with water or clean them with vacuum cleaner.**
  - If the dust does not come off easily, wash them with neutral detergent thinned with lukewarm water, then dry them up in the shade.
  - It is recommended to clean the air filters every 2 weeks.

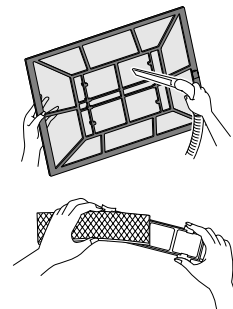

■ **Titanium Apatite Photocatalytic Air-Purifying Filter**

The Titanium Apatite Photocatalytic Air-Purifying Filter can be renewed by washing it with water once every 6 months. We recommend replacing it once every 3 years.

[ **Maintenance** ]

1. **Vacuum dusts, and soak in warm water or water for about 10 to 15 minutes if dirt is heavy.**
2. **Do not remove filter from frame when washing with water.**
3. **After washing, shake off remaining water and dry in the shade.**
4. **Since the material is made out of paper, do not wring out the filter when removing water from it.**

[ **Replacement** ]

1. **Remove the tabs on the filter frame and replace with a new filter.**
  - Dispose of the old filter as flammable waste.

## NOTE

- Operation with dirty filters:
  - (1) cannot deodorize the air. (2) cannot clean the air.
  - (3) results in poor heating or cooling. (4) may cause odour.
- To order Titanium Apatite Photocatalytic Air-Purifying Filter contact to the service shop there you bought the air conditioner.
- Dispose of the old filter as flammable waste.

Item	Part No.
Titanium Apatite Photocatalytic Air-Purifying Filter (without frame) 1 set	KAF968A42

## Check

Check that the base, stand and other fittings of the outdoor unit are not decayed or corroded.

Check that nothing blocks the air inlets and the outlets of the indoor unit and the outdoor unit.

Check that the drain comes smoothly out of the drain hose during COOL or DRY operation.

- If no drain water is seen, water may be leaking from the indoor unit. Stop operation and consult the service shop if this is the case.

## ■ Before a long idle period

1. **Operate the “FAN only” for several hours on a fine day to dry out the inside.**
  - Press “MODE” button and select “FAN” operation.
  - Press “ON/OFF” button and start operation.
2. **After operation stops, turn off the breaker for the room air conditioner.**
3. **Clean the air filters and set them again.**
4. **Take out batteries from the remote controller.**

## NOTE

- When a multi outdoor unit is connected, make sure the heating operation is not used at the other room before you use the fan operation.

## 2.2.15 Troubleshooting

# Trouble Shooting

### These cases are not troubles.

The following cases are not air conditioner troubles but have some reasons. You may just continue using it.

Case	Explanation
<b>Operation does not start soon.</b> <ul style="list-style-type: none"> <li>When ON/OFF button was pressed soon after operation was stopped.</li> <li>When the mode was reselected.</li> </ul>	<ul style="list-style-type: none"> <li>This is to protect the air conditioner. You should wait for about 3 minutes.</li> </ul>
<b>Hot air does not flow out soon after the start of heating operation.</b>	<ul style="list-style-type: none"> <li>The air conditioner is warming up. You should wait for 1 to 4 minutes. (The system is designed to start discharging air only after it has reached a certain temperature.)</li> </ul>
<b>The heating operation stops suddenly and a flowing sound is heard.</b>	<ul style="list-style-type: none"> <li>The system is taking away the frost on the outdoor unit. You should wait for about 4 to 12 minutes.</li> </ul>
<b>The outdoor unit emits water or steam.</b>	<ul style="list-style-type: none"> <li>In HEAT mode <ul style="list-style-type: none"> <li>The frost on the outdoor unit melts into water or steam when the air conditioner is in defrost operation.</li> </ul> </li> <li>In COOL or DRY mode <ul style="list-style-type: none"> <li>Moisture in the air condenses into water on the cool surface of outdoor unit piping and drips.</li> </ul> </li> </ul>
<b>Mist comes out of the indoor unit.</b>	<ul style="list-style-type: none"> <li>This happens when the air in the room is cooled into mist by the cold airflow during cooling operation.</li> <li>This is because the air in the room is cooled by the heat exchanger and becomes mist during defrost operation.</li> </ul>
<b>The indoor unit gives out odour.</b>	<ul style="list-style-type: none"> <li>This happens when smells of the room, furniture, or cigarettes are absorbed into the unit and discharged with the airflow. (If this happens, we recommend you to have the indoor unit washed by a technician. Consult the service shop where you bought the air conditioner.)</li> </ul>
<b>The outdoor fan rotates while the air conditioner is not in operation.</b>	<ul style="list-style-type: none"> <li>After operation is stopped: <ul style="list-style-type: none"> <li>The outdoor fan continues rotating for another 60 seconds for system protection.</li> </ul> </li> <li>While the air conditioner is not in operation: <ul style="list-style-type: none"> <li>When the outdoor temperature is very high, the outdoor fan starts rotating for system protection.</li> </ul> </li> </ul>
<b>The operation stopped suddenly. (OPERATION lamp is on.)</b>	<ul style="list-style-type: none"> <li>For system protection, the air conditioner may stop operating on a sudden large voltage fluctuation. It automatically resumes operation in about 3 minutes.</li> </ul>
<b>No remote controller signals are displayed.</b> <b>The remote controller sensitivity is low.</b> <b>The display is low in contrast or blacked out.</b> <b>The display runs out of control.</b>	<ul style="list-style-type: none"> <li>The batteries are dying and the remote controller is malfunctioning. Replace all the batteries with new size AAA alkaline batteries. For details, refer to "To set the batteries" of this manual.</li> <li>* If the reset button is provided, press the reset button after the batteries are replaced.</li> </ul>
<b>The ON/OFF TIMER does not operate according to the settings.</b>	<ul style="list-style-type: none"> <li>Check if the ON/OFF TIMER and the WEEKLY TIMER are set to the same time. Change or disable the settings in the WEEKLY TIMER.</li> </ul>

**Check again.**

Please check again before calling a repair person.

<b>Case</b>	<b>Check</b>
<b>The air conditioner does not operate.</b> (OPERATION lamp is off.)	<ul style="list-style-type: none"> <li>• Hasn't a breaker turned OFF or a fuse blown?</li> <li>• Isn't it a power failure?</li> <li>• Are batteries set in the remote controller?</li> <li>• Is the timer setting correct?</li> </ul>
<b>Cooling (Heating) effect is poor.</b>	<ul style="list-style-type: none"> <li>• Are the air filters clean?</li> <li>• Is there anything to block the air inlet or the outlet of the indoor and the outdoor units?</li> <li>• Is the temperature setting appropriate?</li> <li>• Are the windows and doors closed?</li> <li>• Are the airflow rate and the air direction set appropriately?</li> </ul>
<b>Operation stops suddenly.</b> (OPERATION lamp flashes.)	<ul style="list-style-type: none"> <li>• Are the air filters clean?</li> <li>• Is there anything to block the air inlet or the outlet of the indoor and the outdoor units? Clean the air filters or take all obstacles away and turn the breaker OFF. Then turn it ON again and try operating the air conditioner with the remote controller. If the lamp still flashes, call the service shop where you bought the air conditioner.</li> <li>• Are operation modes all the same for indoor units connected to outdoor units in the <b>multi system</b>? If not, set all indoor units to the same operation mode and confirm that the lamps flash. Moreover, when the operation mode is in "AUTO", set all indoor unit operation modes to "COOL" or "HEAT" for a moment and check again that the lamps are normal. If the lamps stop flashing after the above steps, there is no malfunction.</li> </ul>
<b>An abnormal functioning happens during operation.</b>	<ul style="list-style-type: none"> <li>• The air conditioner may malfunction with lightning or radio waves. Turn the breaker OFF, turn it ON again and try operating the air conditioner with the remote controller.</li> </ul>
<b>The indoor unit comes to a stop or does not operate when the heat pump model is selected.</b>	<ul style="list-style-type: none"> <li>• Unless the air conditioner has a heating function, the unit in cooling, dry, or fan operation comes to a stop if the heating mode is selected. If the heating mode is selected and the Run button is pressed while the unit is not in operation, the unit does not start operating. Check the specifications of the outdoor unit. If the outdoor unit is cooling only model, set the remote controller for a cooling only model using the cooling only/heat pump switch on the remote controller. If you are not sure about how to switch the setting, contact the service shop where you bought the air conditioner.</li> </ul>
<b>The remote controller allows selection of "heating" even though the unit is cooling only model.</b>	
<b>Heating cannot be selected, even though the unit is heat pump model.</b>	<ul style="list-style-type: none"> <li>• Set the remote controller so that it is for a heat pump model by using the cooling only/heat pump switch on the remote controller. If you are not sure about how to switch the setting, contact the service shop where you bought the air conditioner.</li> </ul>



**Call the service shop immediately.**

 **WARNING**

- When an abnormality (such as a burning smell) occurs, stop operation and turn the breaker OFF.  
Continued operation in an abnormal condition may result in troubles, electric shocks or fire.  
Consult the service shop where you bought the air conditioner.
- Do not attempt to repair or modify the air conditioner by yourself.  
Incorrect work may result in electric shocks or fire.  
Consult the service shop where you bought the air conditioner.

If one of the following symptoms takes place, call the service shop immediately.

<ul style="list-style-type: none"> <li>■ <b>The power cord is abnormally hot or damaged.</b></li> <li>■ <b>An abnormal sound is heard during operation.</b></li> <li>■ <b>The safety breaker, a fuse, or the earth leakage breaker cuts off the operation frequently.</b></li> <li>■ <b>A switch or a button often fails to work properly.</b></li> <li>■ <b>There is a burning smell.</b></li> <li>■ <b>Water leaks from the indoor unit.</b></li> </ul>		<p>Turn the breaker OFF and call the service shop.</p>
---	---	--

<ul style="list-style-type: none"> <li>■ <b>After a power failure</b> The air conditioner automatically resumes operation in about 3 minutes. You should just wait for a while.</li> </ul>	<ul style="list-style-type: none"> <li>■ <b>Lightning</b> If lightning may strike the neighbouring area, stop operation and turn the breaker OFF for system protection.</li> </ul>
--	--

**Disposal requirements**



Your air conditioning product is marked with this symbol. This means that electrical and electronic products shall not be mixed with unsorted household waste.  
Do not try to dismantle the system yourself: the dismantling of the air conditioning system, treatment of the refrigerant, of oil and of other parts must be done by a qualified installer in accordance with relevant local and national legislation.

Air conditioners must be treated at a specialized treatment facility for re-use, recycling and recovery. By ensuring this product is disposed of correctly, you will help to prevent potential negative consequences for the environment and human health. Please contact the installer or local authority for more information.

Batteries must be removed from the remote controller and disposed of separately in accordance with relevant local and national legislation.

**We recommend periodical maintenance.**

In certain operating conditions, the inside of the air conditioner may get foul after several seasons of use, resulting in poor performance. It is recommended to have periodical maintenance by a specialist aside from regular cleaning by the user. For specialist maintenance, contact the service shop where you bought the air conditioner. The maintenance cost must be born by the user.

**Important information regarding the refrigerant used.**

This product contains fluorinated greenhouse gases covered by the Kyoto Protocol.

Refrigerant type: **R410A**

GWP<sup>(1)</sup> value: **1975**

<sup>(1)</sup> GWP = global warming potential

Periodical inspections for refrigerant leaks may be required depending on European or local legislation. Please contact your local dealer for more information.

## 2.3 FHQ-B Series

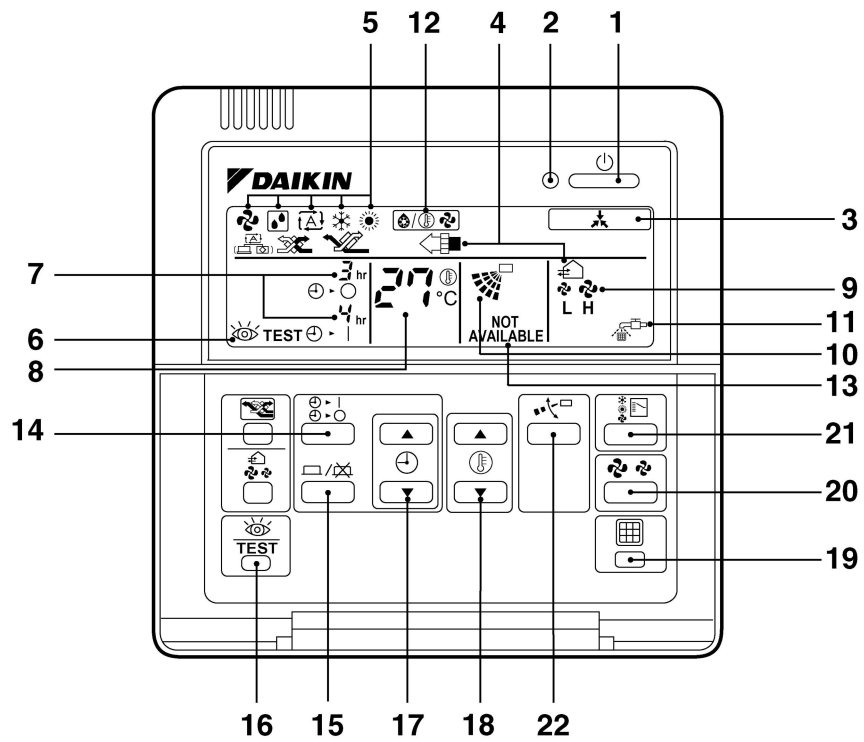

1

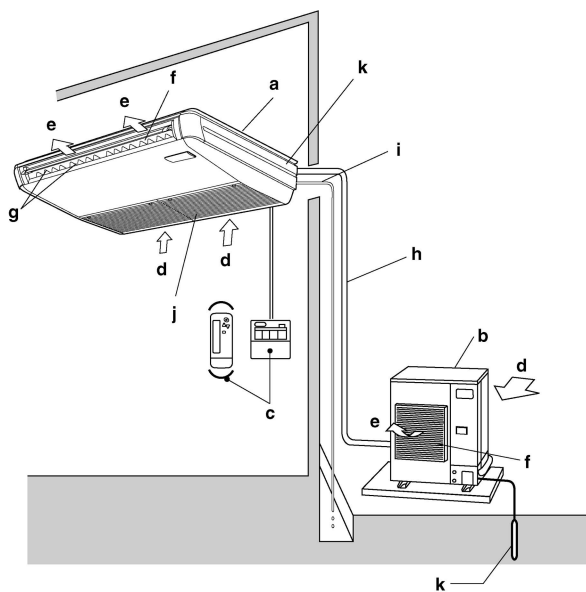

2

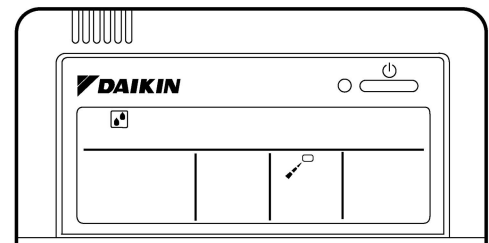

3

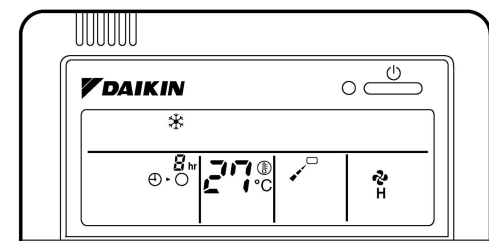

4

[1]

**Important information regarding the refrigerant used**

This product contains fluorinated greenhouse gases covered by the Kyoto Protocol.

Refrigerant type	R410A	R407C
GWP <sup>(1)</sup> value	1975	1652.5

<sup>(1)</sup> GWP = global warming potential

Periodical inspections for refrigerant leaks may be required depending on European or local legislation. Please contact your local dealer for more information.

**1. WHAT TO DO BEFORE OPERATION**

This operation manual is for the following systems with standard control. Before initiating operation, contact your Daikin dealer for the operation that corresponds to your system.

**• Pair system or Simultaneous operation system**

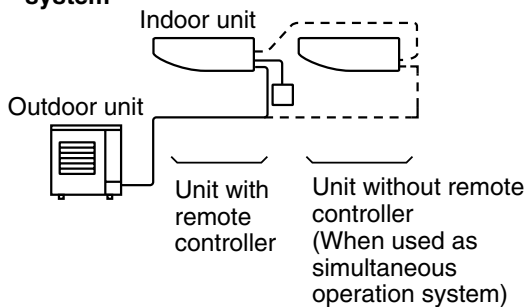

**• Multi system**

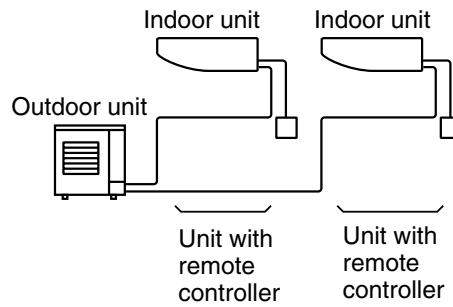

**NOTE**

- If the unit you purchased is controlled by a wireless remote controller, also refer to the wireless remote controller's operation manual.

If your installation has a customized control system, ask your Daikin dealer for the operation that corresponds to your system.

- Heat pump type  
This system provides cooling, heating, automatic, program dry, and fan operation modes.
- Cooling only type  
This system provides cooling, program dry, and fan operation modes.

**PRECAUTIONS FOR GROUP CONTROL SYSTEM OR TWO REMOTE CONTROLLER CONTROL SYSTEM**

This system provides two other control systems beside individual control (one remote controller controls one indoor unit) system. Confirm the following if your unit is of the following control system type.

- **Group control system**  
One remote controller controls up to 16 indoor units.  
All indoor units are equally set.
- **Two remote controllers control system**  
Two remote controllers control one indoor unit (In case of group control system, one group of indoor units)  
The unit is individually operated.

**NOTE**

- Contact your Daikin dealer in case of changing the combination or setting of group control and two remote controllers control system.

## Names and functions of parts

Refer to figure 2 on page [1]

<b>a</b>	Indoor unit
<b>b</b>	Outdoor unit <ul style="list-style-type: none"> <li>The external appearance of the outdoor unit varies depending on its capacity class. The outdoor unit shown in the figure is for reference to indicate features. Contact your Daikin Dealer and verify which outdoor unit you have.</li> </ul>
<b>c</b>	Remote controller
<b>d</b>	Inlet air
<b>e</b>	Discharged air
<b>f</b>	Air outlet
<b>g</b>	Air flow flap (at air outlet)
<b>h</b>	Refrigerant piping, connection electric wire
<b>i</b>	Drain pipe
<b>j</b>	Suction grille The built-in air filter removes dust and dirt.
<b>k</b>	Ground wire Wire to ground from the outdoor unit to prevent electrical shocks.

## 2. SAFETY CONSIDERATIONS

We recommend that you read this instruction manual carefully before use to gain full advantage of the function of the air conditioner, and to avoid malfunction due to erroneous handling.

This air conditioner comes under the term “appliances not accessible to the general public.”

- **The precautions described below are WARNING and CAUTION. These are very important precautions concerning safety. Be sure to observe all of them without fail.**

**⚠ WARNING**...These are the matters with possibilities leading to serious consequences such as death or serious injury due to erroneous handling.

**⚠ CAUTION**....These are the matters with possibilities leading to injury or material damage due to erroneous handling including probabilities leading to serious consequences in some cases.

- **After reading, keep this manual at a place where any user can read at any time. Furthermore, make certain that this operation manual is handed to a new user when he takes over the operation.**

### ⚠ WARNING

**Avoid exposure of your body directly to the cold air for a long time, or avoid excessive exposure of your body to the cold air.**

Otherwise, your physical condition may be deteriorated and/or your health may be ruined.

**When the air conditioner is in abnormal conditions (smell of something burning, etc), unplug the power cord from the outlet, and contact the dealer where you purchased the air conditioner.**

Continued operation under such circumstances may result in a failure, electric shock, and fire.

**Ask your dealer for installation of the air conditioner.**

Incomplete installation performed by yourself may result in a failure, a water leakage, electric shock, and fire.

**Ask your dealer for improvement, repair, and maintenance.**

Incomplete improvement, repair, and maintenance may result in a failure, a water leakage, electric shock, and fire.

**Do not insert your finger, a stick, etc., into the air inlet, outlet, and fan blades.**

A fan in high-speed running may result in injury.

**For refrigerant leakage, consult your dealer.**

When the air conditioner is to be installed in a small room, it is necessary to take proper measures so that the amount of any leaked refrigerant does not exceed the limiting concentration even when it leaks. If the refrigerant leaks exceeding the level of limiting concentration, an oxygen deficiency accident may happen.

**For installation of separately sold component parts, ask a specialist.**

Be sure to use the separately sold component parts designated by our company.

Incomplete installation performed by yourself may result in a failure, a water leakage, electric shock, and fire.

**Ask your dealer to move and reinstall the air conditioner.**

Incomplete installation may result in a failure, a water leakage, electric shock, and fire.

**Do not use any fuse with improper capacity.**

The use of a piece of wire and whatnot may result in a failure and fire.

**The refrigerant in the air conditioner is safe and normally does not leak. If the refrigerant leaks inside the room, the contact with a fire of a burner, a heater or a cooker may result in a harmful gas.**

Do not use the air conditioner until when a service person confirms to finish repairing the portion where the refrigerant leaks.

**Be sure to establish an earth.**

Do not earth the unit to a utility pipe, arrester, or telephone earth.

Incomplete earth may cause electrical shock, or fire.

A high surge current from lightning or other sources may cause damage to the air conditioner.

**Be sure to install an earth leakage breaker.**  
Failure to install an earth leakage breaker may result in electric shocks, or fire.

**Consult the dealer if the air conditioner submerges owing to a natural disaster, such as a flood or typhoon.**

Do not operate the air conditioner in that case, or otherwise a malfunction, electric shock, or fire may result.

---

**⚠ CAUTION**

**Do not use the air conditioner for other purposes.**

Do not use the air conditioner for a special application such as the storage of foods, animals and plants, precision machines, and art objects as otherwise the deterioration of quality may result.

**Do not remove the air outlet of the outdoor unit.**

The fan may get exposed and result in injury.

**When the air conditioner is used in combination with burners or heaters, perform sufficient ventilation.**

Insufficient ventilation may result in an oxygen deficiency accident.

**Check and make sure that foundation blocks are not damaged after a long use.**

If they are left in a damaged condition, the unit may fall and result in injury.

**Neither place a flammable spray bottle near the air conditioner nor perform spraying.**

Doing so may result in a fire.

**To clean the air conditioner, stop operation, and unplug the power cord from the outlet.**

Otherwise, an electric shock and injury may result.

**Do not operate the air conditioner with a wet hand.**

An electric shock may result.

**Do not place items that might be damaged by water under the indoor unit.**

Water may condensate and drip if the humidity reaches 80% or if the drain exit gets clogged.

**Do not place a burner or heater at a place directly exposed to the wind from the air conditioner.**

Incomplete combustion of the burner or heater may result.

**Do not allow a child to mount on the outdoor unit or avoid placing any object on it.**

Falling or tumbling may result in injury.

**Do not expose animals and plants directly to the wind from the air conditioner.**

Adverse influence to animals and plants may result.

**Do not wash the air conditioner with water.**

Electric shock or fire may result.

**Do not install the air conditioner at any place where flammable gas may leak out.**

If the gas leaks out and stays around the air conditioner, a fire may break out.

**Execute complete drain piping for perfect drainage.**

Incomplete piping may result in a water leakage.

**The appliance is not intended for use by young children or infirm persons without supervision.**

**Young children should be supervised to ensure that they do not play with the appliance.**

**Consult with installation contractor for cleaning the inside of the air conditioner.**

Wrong cleaning may make the plastics parts broken or cause failure of water leakage or electric shock.

**Do not touch the air inlet or aluminium fin of the air conditioner.**

Otherwise, injury may be caused.

**Do not start or stop operating the air conditioner with the power supply breaker turned ON or OFF.**

Otherwise, fire or water leakage may result.

Furthermore, the fan will rotate abruptly if power failure compensation is enabled, which may result in injury.

**Do not place objects in direct proximity of the outdoor unit and do not let leaves and other debris accumulate around the unit.**

Leaves are a hotbed for small animals which can enter the unit. Once in the unit, such animals can cause malfunctions, smoke or fire when making contact with electrical parts.

**Never touch the internal parts of the remote controller.**

Do not remove the front panel. Some parts inside are dangerous to touch, and a machine trouble may happen.

For checking and adjusting the internal parts, contact your dealer.

**Avoid placing the remote controller in a spot splashed with water.**

Water coming inside the machine may cause an electric leak or may damage the internal electronic parts.

**Watch your steps at the time of air filter cleaning or inspection.**

High-place work is required, to which utmost attention must be paid.

If the scaffold is unstable, you may fall or topple down, thus causing injury.

---

### 3. OPERATION RANGE

If the temperature or the humidity is beyond the following conditions, safety devices may work and the air conditioner may not operate, or sometimes, water may drop from the indoor unit.

#### COOLING

OUTDOOR UNIT	INDOOR		OUTDOOR TEMPERATURE		
	TEMPERATURE	HUMIDITY			
R35 · 45 · 60	DB	18 to 33	80% or below	DB	- 15 to 46
	WB	12 to 24			
RY35 · 45 · 60	DB	18 to 33	80% or below	DB	- 5 to 46
	WB	12 to 24			
R71 · 100 · 125 RP71 · 100 · 125 REP71 · 100 · 125	DB	21 to 35	80% or below	DB	- 15 to 46
	WB	14 to 25			
RY71 · 100 · 125 RYP71 · 100 · 125 RYEP71 · 100 · 125	DB	18 to 35	80% or below	DB	- 5 to 46
	WB	12 to 25			
RZP71 · 100 · 125	DB	21 to 35	80% or below	DB	- 5 to 50
	WB	14 to 25			
RQ71 · 100 · 125	DB	18 to 37	80% or below	DB	- 5 to 46
	WB	12 to 28			
RR71 · 100 · 125	DB	18 to 37	80% or below	DB	- 15 to 46
	WB	12 to 28			
RZQ71 · 100 · 125 · 140	DB	18 to 37	80% or below	DB	- 15 to 50
	WB	12 to 28			
RS50 · 60 RKS35 · 50 · 60 RXS35 · 50 · 60	DB	21 to 32	80% or below	DB	- 10 to 46
	WB	14 to 23			
3MKS50 4MKS58 · 75 · 90 3MXS52 · 2MXS52 4MXS68 · 80	DB	21 to 32	80% or below	DB	- 10 to 46
	WB	14 to 23			
RMKS112 · 140 · 160 RMS112 · 140 · 160	DB	21 to 32	80% or below	DB	- 5 to 46
	WB	14 to 23			

#### HEATING

OUTDOOR UNIT	INDOOR TEMPERATURE	OUTDOOR TEMPERATURE		
		DB	WB	
RY35 · 45 · 60	DB	15 to 27	DB	- 9 to 21
			WB	- 10 to 15.5
RY71 · 100 · 125 RYP71 · 100 · 125 RYEP71 · 100 · 125	DB	15 to 27	DB	- 9 to 21
			WB	- 10 to 15.5
RZP71 · 100 · 125	DB	15 to 27	DB	- 14 to 21
			WB	- 15 to 15.5
RQ71 · 100 · 125	DB	10 to 27	DB	- 9 to 21
			WB	- 10 to 15
RZQ71 · 100 · 125 · 140	DB	10 to 27	DB	- 19.5 to 21
			WB	- 20 to 15.5
RXS35 · 50 · 60	DB	10 to 30	DB	- 14 to 24
			WB	- 15 to 18
3MXS52 · 2MXS52 4MXS68 · 80	DB	10 to 30	DB	- 14 to 21
			WB	- 15 to 15.5
RMS112 · 140 · 160	DB	10 to 30	DB	- 14 to 21
			WB	- 15 to 15.5

DB: Dry bulb temperature (°C)

WB: Wet bulb temperature (°C)

The setting temperature range of the remote controller is 16°C to 32°C.

### 4. INSTALLATION SITE

#### Regarding places for installation

- **Is the air conditioner installed at a well-ventilated place where there are no obstacles around?**
- **Do not use the air conditioner in the following places.**
  - a. Filled with much mineral oil such as cutting oil
  - b. Where there is much salt such as a beach area
  - c. Where sulfured gas exists such as a hot-spring resort
  - d. Where there are considerable voltage fluctuations such as a factory or plant
  - e. Vehicles and vessels
  - f. Where there is much spray of oil and vapor such as a cookery, etc.
  - g. Where there are machines generating electromagnetic waves
  - h. Filled with acid and/or alkaline steam or vapor
- **Is a snow protection measure taken?**  
For details, consult your dealer.

**Regarding wiring**

- **All wiring must be performed by an authorized electrician.**  
To do wiring, ask your dealer. Never do it by yourself.
- **Make sure that a separate power supply circuit is provided for this air conditioner and that all electrical work is carried out by qualified personnel according to local laws and regulations.**

**Pay attention to running noises, too**

- **Are the following places selected?**
  - a. A place that can sufficiently withstand the weight of the air conditioner with less running noises and vibrations.
  - b. A place where the hot wind discharged from the air outlet of the outdoor unit and the running noises.
- **Are you sure that there are no obstacles near the air outlet of the outdoor unit?**  
Such obstacles may result in declined performance and increased running noises.
- **If abnormal noises occur in use, stop the operation of the air conditioner, and then consult your dealer or our service station.**











**Regarding drainage of drain piping**

- **Is the drain piping executed to perform complete drainage?**  
If proper drainage is not carried out from the outdoor drain pipes during air-conditioning operation, chances are that dust and dirt are clogged in the pipe. This may result in a water leakage from the indoor unit. Under such circumstances, stop the operation of the air conditioner, and then consult your dealer or our service station.

**5. NAME AND FUNCTION OF EACH SWITCH AND DISPLAY ON THE REMOTE CONTROLLER**

Refer to figure 1 on page [1]

1	<b>ON/OFF BUTTON</b>
	Press the button and the system will start. Press the button again and the system will stop.
2	<b>OPERATION LAMP (RED)</b>
	The lamp lights up during operation.
3	<b>DISPLAY “  ” (UNDER CENTRALIZED CONTROL)</b>
	When this display shows, the system is UNDER CENTRALIZED CONTROL.

4	<b>DISPLAY “  ” (VENTILATION/AIR CLEANING)</b>
	This display shows that the total heat exchange and the air cleaning unit are in operation (These are optional accessories).
5	<b>DISPLAY “  ” (OPERATION MODE)</b>
	This display shows the current OPERATION MODE. For cooling only type, “  ” (Auto) and “  ” (Heating) are not installed.
6	<b>DISPLAY “  TEST” (INSPECTION/TEST OPERATION)</b>
	When the INSPECTION/TEST OPERATION BUTTON is pressed, the display shows the system mode is in.
7	<b>DISPLAY “  ” (PROGRAMMED TIME)</b>
	This display shows the PROGRAMMED TIME of the system start or stop.
8	<b> °C</b>
	This display shows the set temperature.
9	<b></b>
	This display shows the set fan speed.
10	<b></b>
	Refer to “AIR FLOW DIRECTION ADJUST”.
11	<b>DISPLAY “  ” (TIME TO CLEAN AIR FILTER)</b>
	Refer to “HOW TO CLEAN THE AIR FILTER”.
12	<b>DISPLAY “  ” (DEFROST)</b>
	Refer to “DEFROST OPERATION”.
13	<b>NON-FUNCTIONING DISPLAY</b>
	If that particular function is not available, pressing the button may display the words “NOT AVAILABLE” for a few seconds.
14	<b>TIMER MODE START/STOP BUTTON</b>
	Refer to “PROGRAM TIMER OPERATION”.
15	<b>TIMER ON/OFF BUTTON</b>
	Refer to “PROGRAM TIMER OPERATION”.
16	<b>INSPECTION/TEST OPERATION BUTTON</b>
	This button is used only by qualified service persons for maintenance purposes.
17	<b>PROGRAMMING TIME BUTTON</b>
	Use this button for programming “START and/or STOP” time.

18	<b>TEMPERATURE SETTING BUTTON</b> Use this button for SETTING TEMPERATURE.
19	<b>FILTER SIGN RESET BUTTON</b> Refer to "HOW TO CLEAN THE AIR FILTER".
20	<b>FAN SPEED CONTROL BUTTON</b> Press this button to select the fan speed, HIGH or LOW, of your choice.
21	<b>OPERATION MODE SELECTOR BUTTON</b> Press this button to select OPERATION MODE.
22	<b>AIR FLOW DIRECTION ADJUST BUTTON</b> Refer to "AIR FLOW DIRECTION ADJUST".
<b>NOTE</b>	
<ul style="list-style-type: none"> <li>For the sake of explanation, all indications are shown on the display in Figure 1 contrary to actual running situations.</li> </ul>	

## 6. OPERATION PROCEDURE

Refer to figure 1 on page [1]

- Operating procedure varies with heat pump type and cooling only type. Contact your Daikin dealer to confirm your system type.
- To protect the unit, turn on the main power switch 6 hours before operation.
- If the main power supply is turned off during operation, operation will restart automatically after the power turns back on again.

### COOLING, HEATING, AUTOMATIC, FAN, AND PROGRAM DRY OPERATION

Operate in the following order.

#### 1 OPERATION MODE SELECTOR

Press OPERATION MODE SELECTOR button several times and select the OPERATION MODE of your choice as follows.

- COOLING OPERATION.....“❄️”
- HEATING OPERATION.....“☀️”
- AUTOMATIC OPERATION.....“🔄”
  - In this operation mode, COOL/HEAT changeover is automatically conducted.
- FAN OPERATION.....“🌀”
- DRY OPERATION.....“💧”
  - The function of this program is to decrease the humidity in your room with the minimum temperature decrease.
  - Micro computer automatically determines TEMPERATURE and FAN SPEED.

- This system does not go into operation if the room temperature is below 16°C.

Refer to figure 3 on page [1]

- For cooling only type, “COOLING”, “FAN” and “DRY” operation are able to select.

#### 2 ON/OFF

##### Press ON/OFF BUTTON

OPERATION lamp lights up or goes off and the system starts or stops OPERATION.

#### [EXPLANATION OF HEATING OPERATION]

##### DEFROST OPERATION

- As the frost on the coil of an outdoor unit increase, heating effect decreases and the system goes into DEFROST OPERATION.
- The indoor unit fan stops and the remote controller display shows “❄️🔄”.
- After 6 to 8 minutes (maximum 10 minutes) of DEFROST OPERATION, the system returns to HEATING OPERATION.

#### Regarding outside air temperature and heating capacity

- The heating capacity of the air conditioner declines as the outside air temperature falls. In such a case, use the air conditioner in combination with other heating systems.
- A warm air circulating system is employed, and therefore it takes some time until the entire room is warmed up after the start of operation.
- An indoor fan runs to discharge a gentle wind automatically until the temperature inside the air conditioner reaches a certain level. At this time, the remote controller displays “🌀🔄”. Leave it as it stands and wait for a while.
- When the warm air stays under the ceiling and your feet are cold, we recommend that you use a circulator (a fan to circulate the air inside the room). For details, consult your dealer.

#### ADJUSTMENT

For programming TEMPERATURE, FAN SPEED and AIR FLOW DIRECTION, follow the procedure shown below.

#### TEMPERATURE SETTING

Press TEMPERATURE SETTING button and program the setting temperature.

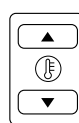

Each time this button is pressed, setting temperature rises 1°C.

Each time this button is pressed, setting temperature lowers 1°C.



- The setting is impossible for fan operation.

**NOTE** 

- The setting temperature range of the remote controller is 16°C to 32°C.



**FAN SPEED CONTROL**

**Press FAN SPEED CONTROL button.**  
High or Low fan speed can be selected.  
The micro computer may sometimes control the fan speed in order to protect the unit.



**AIR FLOW DIRECTION ADJUST**

- There are 2 ways of adjusting the air discharge angle.
  1. A. Up and down adjustment
  2. B. Left and right direction

Fig. 1

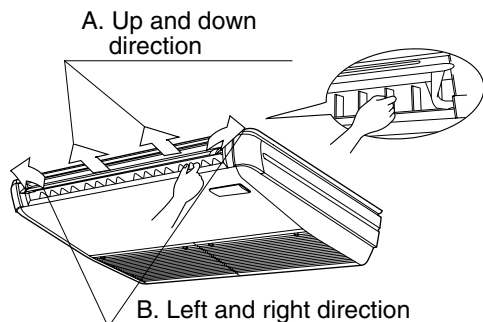

**A. UP AND DOWN DIRECTION**

- The movable limit of the flap is changeable. Contact your Daikin dealer for details.

**Press the AIR FLOW DIRECTION ADJUST button to select the air direction as following.**

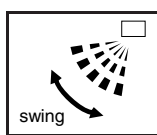

The AIR FLOW FLAP display swings as shown the left and the air flow direction continuously varies. (Automatic swing setting)



Press AIR FLOW DIRECTION ADJUST button to select the air direction of your choice.

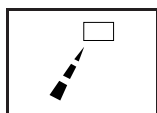

The AIR FLOW FLAP display stops swinging and the air flow direction is fixed (Fixed air flow direction setting).

**MOVEMENT OF THE AIR FLOW FLAP**

For the following conditions, micro computer controls the air flow direction so it may be different from the display.

Operation mode	Cooling	Heating
Operation condition	<ul style="list-style-type: none"> <li>• When room temperature is lower than the set temperature</li> </ul>	<ul style="list-style-type: none"> <li>• When room temperature is higher than the set temperature</li> <li>• At defrost operation</li> </ul>
	<ul style="list-style-type: none"> <li>• When operating continuously at downward air flow direction</li> </ul>	

Operation mode includes automatic operation.

**B. LEFT AND RIGHT DIRECTION**

- Adjusting air flow direction in the left and right direction. (Refer to Fig. 1)

**NOTE** 

- Only make adjustments after you have stopped the air flow direction swing in a position where adjustments are possible. Your hand may get caught if you attempt to make adjustments while the unit is swinging.

**PROGRAM TIMER OPERATION**

Operate in the following order.

- The timer is operated in the following two ways.
- Programming the stop time (⊕ · ○)  
.... The system stops operating after the set time has elapsed.
- Programming the start time (⊕ · |)  
.... The system starts operating after the set time has elapsed.
- The timer can be programmed a maximum of 72 hours.
- The start and the stop time can be simultaneously programmed.



**TIMER MODE START/STOP**

**Press the TIMER MODE START/STOP button several times and select the mode on the display.**

The display flashes.

For setting the timer stop .... “⊕ · ○”

For setting the timer start .... “⊕ · |”

## 2 PROGRAMMING TIME

Press the **PROGRAMMING TIME** button and set the time for stopping or starting the system.

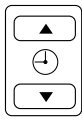

When this button is pressed, the time advances by 1 hour.



When this button is pressed, the time goes backward by 1 hour.

## 3 TIMER ON/OFF

Press the **TIMER ON/OFF** BUTTON.

The timer setting procedure ends.

The display “ $\oplus$  -  $\circ$  or  $\oplus$  - |” changes from flashing light to a constant light.

Refer to figure 4 on page [1]

### NOTE

- When setting the timer Off and On at the same time, repeat the above procedure from 1 to 3 once again.

When the timer is programmed to stop the system after 3 hours and start the system after 4 hours, the system will stop after 3 hours and then 1 hour later the system will start.

- After the timer is programmed, the display shows the remaining time.
- Press the **TIMER ON/OFF** BUTTON once again to cancel programming. The display vanishes.

## 7. OPTIMUM OPERATION

Observe the following precautions to ensure the system operates.

- Adjust the room temperature properly for a comfortable environment. Avoid excessive heating or cooling.
- Prevent direct sunlight from entering a room during cooling operation by using curtains or blinds.
- Ventilate the room regularly.  
Using the unit for long periods of time requires attentive ventilation of the room.
- Keep doors and windows closed. If the doors and windows remain open, room air will flow out and cause to decrease the effect of cooling and heating.
- Do not place other heaters directly below the indoor unit.  
They may deform due to the heat.
- Never place objects near the air inlet and the air outlet of the unit. It may cause deterioration in the effect or stop in the operation.

- Turn off the main power supply switch when it is not used for long periods of time. When the main power switch is turned on, some watts of electricity is being used even if the system is not operating. Turn off the main power supply switch for saving energy. When reoperating, turn on the main power supply switch 6hours before operation for smooth running (Refer to MAINTENANCE).
- When the display shows “ $\text{⏰}$ ” (TIME TO CLEAN AIR FILTER), ask a qualified service person to clean the filters (Refer to MAINTENANCE).
- Fully use the function of air flow direction adjust. Cold air gathers on the floor, and warm air gathers in the ceiling.  
Set the air flow direction parallel during cooling or dry operation, and set it downwards during heating operation.  
Do not let the air blow directly to a person.
- It takes time for the room temperature to reach the set temperature.  
We recommend starting the operation in advance using timer operation.

## 8. MAINTENANCE (FOR SERVICE PERSONNEL)

**ONLY A QUALIFIED SERVICE PERSON IS ALLOWED TO PERFORM MAINTENANCE**

### IMPORTANT!

- BEFORE OBTAINING ACCESS TO TERMINAL DEVICES, ALL POWER SUPPLY CIRCUITS MUST BE INTERRUPTED**
- To clean the air conditioner, be sure to stop operation, and turn the power switch off. Otherwise, an electric shock and injury may result.
- Do not wash the air conditioner with water  
Doing so may result in an electric shock.
- Be careful with a scaffold or staging  
Caution must be exercised because of work at a high place.

Fig. 2

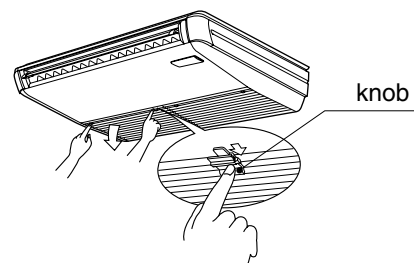

Fig. 3

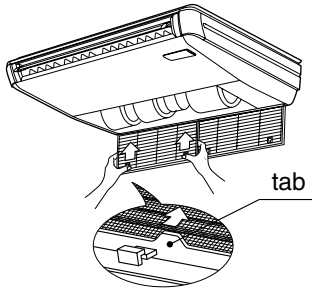

Fig. 4

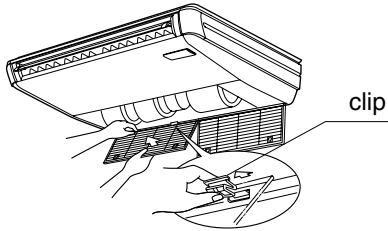
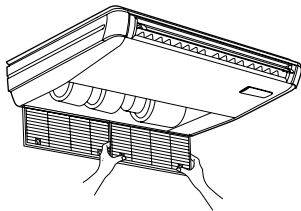

Fig. 5



**HOW TO CLEAN THE AIR FILTER**

Clean the air filter when the display shows “” (TIME TO CLEAN AIR FILTER). It will display that it will operate for a set amount of time. Increase the frequency of cleaning if the unit is installed in a room where the air is extremely contaminated. If the dirt becomes impossible to clean, change the air filter (Air filter for exchange is optional).

1. **Open the suction grille.**  
Slide both knobs simultaneously as shown and then pull them downward.  
(Do the same procedure for closing.)  
**(Refer to Fig. 2)**
2. **Remove the air filters.**  
Push the 2 tabs up, and slowly lower the grille.  
**(Refer to Fig. 3)**
3. **Clean the air filter.**  
Use vacuum cleaner **A)** or wash the air filter with water **B).**  
**A)Using a vacuum cleaner**



- B)Washing with water**  
When the air filter is very dirty, use soft brush and neutral detergent.



Remove water and dry in the shade.

**NOTE**

- Do not wash the air conditioner with hot water of more than 50°C, as doing so may result in discoloration and/or deformation.
- Do not expose it to fire, as doing so may result in burning.

4. **Fix the air filter.**  
Set the hatch of the air filter to the fook of the suction grille, and fix the air filter.  
**(Refer to Fig. 5)**

5. **Close the suction grille.**  
Refer to item No. 1.

6. **After turning on the power, press FILTER SIGN RESET BUTTON.**  
The “TIME TO CLEAN AIR FILTER” display vanishes.

**HOW TO CLEAN AIR OUTLET AND OUTSIDE PANELS**

- Clean with soft cloth.
- When it is difficult to remove stains, use water or neutral detergent.

**NOTE**

- Do not use gasoline, benzene, thinner, polishing powder, liquid insecticide. It may cause discoloring or warping.
- Do not let the indoor unit get wet. It may cause an electric shock or a fire.
- Do not use water or air of 50°C or higher for cleaning air filters and outside panels.

**HOW TO CLEAN THE SUCTION GRILLE**

1. **Open the suction grille.**  
Slide both knobs and then pull them downward.  
(Do the same procedure for closing.)
2. **Remove the air filter.**  
Refer to “HOW TO CLEAN THE AIR FILTER”.  
**(Refer to Fig. 3)**
3. **Remove the suction grille.**  
Open the suction grille and pull the clips on the back of the suction grille forward.  
**(Refer to Fig. 4)**
4. **Clean the suction grille.**  
Wash with a soft bristle brush and neutral detergent or water, and dry thoroughly.



- **When very grimy**

Directly apply the type of detergent used for cleaning ventilation fans or ovens, wait 10 minutes, and then rinse with water.

**NOTE** 

- Do not wash the air conditioner with hot water of more than 50°C, as doing so may result in discoloration and/or deformation.
- 5. Fix the air filter.**  
Refer to “HOW TO CLEAN THE AIR FILTER”.
- 6. Fix the suction grille.**  
Refer to item No. 3.
- 7. Close the suction grille.**  
Refer to item No. 1.

**START UP AFTER A LONG STOP**

**Confirm the following**

- Check that the air inlet and outlet are not blocked. Remove any obstacle.
- Check if the earth is connected.  
Might there be a broken wire somewhere?  
Contact your dealer if there are any problems

**Clean the air filter and outside panels**

- After cleaning the air filter, make sure to attach it.

**Turn on the main power supply switch**

- The display on the remote controller will be shown when the power is turned on.
- To protect the unit, turn on the main power switch at least 6 hours before operation.

**WHAT TO DO WHEN STOPPING THE SYSTEM FOR A LONG PERIOD**

**Turn on FAN OPERATION for a half day and dry the unit.**

- Refer to “6. OPERATION PROCEDURE”.

**Cut off the power supply.**

- When the main power switch is turned on, some watts of electricity is being used even if the system is not operating.  
Turn off the main power supply switch for saving energy.
- The display on the remote controller will vanish when the main power switch is turned off.

**Clean the air filter and the exterior.**

- Be sure to replace the air filter to its original place after cleaning. Refer to “MAINTENANCE”.

## 9. NOT MALFUNCTION OF THE AIR CONDITIONER

The following symptoms do not indicate air conditioner malfunction

**I. THE SYSTEM DOES NOT OPERATE**

- **The system does not restart immediately after the ON/OFF BUTTON is pressed.**

If the OPERATION lamp lights, the system is in normal condition.

It does not restart immediately because a safety device operates to prevent overload of the system. After 3 minutes, the system will turn on again automatically.

- **The system does not restart immediately when TEMPERATURE SETTING button is returned to the former position after pushing the button.**

If the OPERATION lamp lights, the system is in normal condition.

It does not restart immediately because a safety device operates to prevent overload of the system. After 3 minutes, the system will turn on again automatically.

- **The system does not start when the display shows “  ” (UNDER CENTRALIZED CONTROL) and it flashes for few seconds after pressing an operation button.**

This is because the system is under centralized control. Flashes on the display indicates that the system cannot be controlled by the remote controller.

- **The system does not start immediately after the power supply is turned on.**

Wait one minute until the micro computer is prepared for operation.

- **The outdoor unit is stopped**

This is because the room temperature has reached the set temperature. The indoor unit switches to fan operation.

**II. WHEN “  ” (UNDER CENTRALIZED CONTROL) IS DISPLAYED AND OPERATION IS DIFFERENT FROM THE REMOTE CONTROL DISPLAY.**

This is because operating mode is controlled by a micro computer, as shown below, depending on the operating mode of the other connected indoor units when using in a multi system.

- **If the operating mode does not match that of the other indoor units which are already running, the indoor unit goes into standby mode (the fan stops and the air flow flaps become horizontal).**

The unit will go into the above mode if either cooling, dry, or fan operation mode are set together with heating mode.

#### NOTE

- Normally, the operation mode in the room where the unit is first run is given priority, but the following situations are exceptions, so please keep this in mind.
  - a If the operation mode of the first room is FAN Mode, then using Heating Mode in any room after this will give priority to heating. In this situation, the air conditioner running in FAN Mode will go on standby.
  - b With the Priority Room Setting active Contact your Daikin dealer for the operation that corresponds to your system.
- **If the total capacity of all the indoor units running exceeds the limit, the indoor unit will go into standby mode (fan and air flow direction remain as set). (Only for cooling-only type.)**
- **If another indoor unit goes into heating mode after cooling, the unit may go into dry mode (fan operates whisper and the air flow flaps become horizontal).**

#### III. THE FAN SPEED IS DIFFERENT FROM THE SETTING.

- **Pressing the fan speed control button does not change the fan speed.**  
When the room temperature reaches the set temperature in heating mode, the power supply from the outdoor unit stops and the indoor unit goes into whisper mode (in a multi system, the fan goes back and forth between stop and whisper). This is to prevent the cool air from being blown directly onto anyone in the room.

#### IV. AIR BLOW DIRECTION IS NOT AS SPECIFIED.

- **Actual air blow direction is not as shown on the remote controller.**
- **Automatic swing setting does not work.**  
Refer to "AIR FLOW DIRECTION ADJUST".

#### V. WHITE MIST COMES OUT OF A UNIT

- **When humidity is high during cooling operation (In oily or dusty places)**  
If the inside of an indoor unit is extremely contaminated, the temperature distribution inside a room becomes uneven. It is necessary to clean the inside of the indoor unit. Ask your Daikin dealer for details on cleaning the unit. This operation requires a qualified service person.

- **When the system is changed over to HEATING OPERATION after DEFROST OPERATION.**

Moisture generated by DEFROST becomes steam and exists.

#### VI. NOISE OF AIR CONDITIONERS

- **A ringing sound after the unit is started.**  
This sound is generated by the temperature regulator working.  
It will quiet down after about a minute.
- **A continuous flow "Shuh" sound is heard when the systems is in COOLING or DEFROST OPERATION.**  
This is the sound of refrigerant gas flowing through both indoor and outdoor units.
- **A "Shuh" sound which is heard at the start or immediately after the stop of operation or which is heard at the start or immediately after the stop of DEFROST OPERATION.**  
This is the noise of refrigerant caused by flow stop and flow change.
- **A continuous flow "Shah" sound is heard when the system is in COOLING OPERATION or at a stop.**  
The noise is heard when the drain pump is in operation.
- **A "Pishi-pishi" squeaking sound is heard when the system is in operation or after the stop of operation.**  
Expansion and contraction of plastic parts caused by temperature change makes this noise.

#### VII. DUST FROM THE UNITS

- **Dust may blow out from the unit after starting operation from long resting time.**  
Dust absorbed by the unit blows out.

#### VIII. THE UNITS GIVE OFF ODORS

The unit absorbs the smell of rooms, furniture, cigarettes, etc., and then emits them.

#### IX. THE LIQUID CRYSTAL OF THE REMOTE CONTROLLER SHOW "88"

- **It happens immediately after the main power supply switch is turned on.**  
This shows that the remote controller is in normal condition.  
This continues temporary.

#### X. DOES NOT COOL VERY WELL.

- **Program dry operation.**  
Program dry operation is designed to lower the room temperature as little as possible.  
Refer to page 6.

## 10. TROUBLE SHOOTING

### I. If one of the following malfunctions occurs, take the measures shown below and contact your Daikin dealer.

The system must be repaired by a qualified service person.

#### ⚠ WARNING

When the air conditioner is in abnormal conditions (smell of something burning, etc), unplug the power cord from the outlet, and contact your dealer

Continued operation under such circumstances may result in a failure, electric shock, and fire.

- If a safety device such as a fuse, a breaker or an earth leakage breaker frequently actuates;  
**Measure:** Do not turn on the main power switch.
- If the ON/OFF switch does not properly work;  
**Measure:** Turn off the main power switch.
- If water leaks from unit;  
**Measure:** Stop the operation.
- If the display “” (INSPECTION), “UNIT No.”, and the OPERATION lamp flash and the “MALFUNCTION CODE” appears;

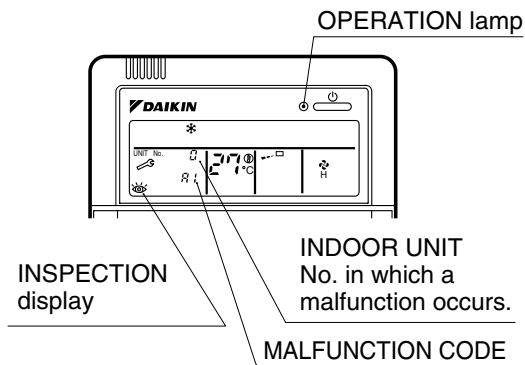

**Measure:** Notify your Daikin dealer and inform him/her of the display.

### II. If the system does not properly operate except for the above mentioned case, and none of the above mentioned malfunctions is evident, investigate the system according to the following procedures.

1. If the system does not operate at all.
  - Check if there is a power failure.  
Wait until power is restored. If power failure occurs during operation, the system automatically restarts immediately after the power supply recovers.
  - Check if no fuse has blown.  
Turn off the power supply.

- Check if the breaker is blown.  
Turn the power on with the breaker switch in the off position.  
Do not turn the power on with the breaker switch in the trip position.  
(Contact your dealer.)

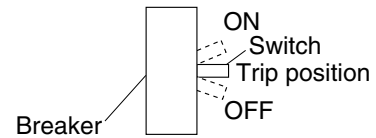

### 2. If the system stops operating after operating the system.

- Check if the air inlet or outlet of outdoor or indoor unit is blocked by obstacles.  
Remove the obstacle and make it well-ventilated.
- Check if the air filter is clogged.  
Ask a qualified service person to clean the air filters (Refer to MAINTENANCE).

### 3. The system operates but it does not sufficiently cool or heat.

- If the air inlet or outlet of the indoor or the outdoor unit is blocked with obstacles.  
Remove the obstacle and make it well-ventilated.
- If the air filter is clogged.  
Ask a qualified service person to clean the air filters (Refer to MAINTENANCE).
- If the set temperature is not proper (Refer to ADJUSTMENT).
- If the FAN SPEED button is set to LOW SPEED (Refer to ADJUSTMENT).
- If the air flow angle is not proper (Refer to AIR FLOW DIRECTION ADJUST).
- If the doors or the windows are open.  
Shut doors or windows to prevent wind from coming in.
- If direct sunlight enters the room (when cooling).  
Use curtains or blinds.
- When there are too many inhabitants in the room (when cooling).  
Cooling effect decreases if heat gain of the room is too large.
- If the heat source of the room is excessive (when cooling).  
Cooling effect decreases if heat gain of the room is too large.



# Part 6

## Service Diagnosis

1. Caution for Diagnosis.....	206
1.1 Troubleshooting with Operation Lamp .....	206
2. Problem Symptoms and Measures .....	208
3. Service Check Function .....	209
3.1 Check Method 1 .....	209
3.2 Check Method 2 .....	211
4. Code Indication on the Remote Controller .....	213
4.1 Error Codes and Description of Fault .....	213
5. Troubleshooting .....	214
5.1 Indoor Units .....	214
5.2 Outdoor Units .....	215
5.3 Indoor Unit PCB Abnormality .....	216
5.4 Freeze-up Protection Control or High Pressure Control.....	217
5.5 Fan Motor or Related Abnormality .....	219
5.6 Thermistor or Related Abnormality (Indoor Unit).....	222
5.7 Front Panel Open / Close Fault.....	223
5.8 Signal Transmission Error (between Indoor and Outdoor Unit) .....	224
5.9 Unspecified Voltage (between Indoor and Outdoor Units) .....	226
5.10 Freeze-up Protection Control .....	227
5.11 Outdoor Unit PCB Abnormality.....	229
5.12 OL Activation (Compressor Overload) .....	230
5.13 Compressor Lock .....	231
5.14 DC Fan Lock .....	232
5.15 Input Over Current Detection .....	233
5.16 Discharge Pipe Temperature Control.....	235
5.17 High Pressure Control in Cooling .....	236
5.18 Compressor Sensor System Abnormality .....	238
5.19 Position Sensor Abnormality .....	240
5.20 CT or Related Abnormality .....	241
5.21 Thermistor or Related Abnormality (Outdoor Unit).....	243
5.22 Electrical Box Temperature Rise .....	245
5.23 Radiation Fin Temperature Rise .....	247
5.24 Output Over Current Detection.....	249
5.25 Insufficient Gas.....	251
5.26 Low-voltage Detection or Over-voltage Detection.....	253
5.27 Signal Transmission Error (on Outdoor Unit PCB).....	254
5.28 Anti-icing Function in Other Rooms / Unspecified Voltage (between Indoor and Outdoor Units) .....	255
6. Check .....	256
6.1 How to Check.....	256



# 1. Caution for Diagnosis

## 1.1 Troubleshooting with Operation Lamp

The operation lamp flashes when any of the following errors is detected.

1. When a protection device of the indoor or outdoor unit is activated or when the thermistor malfunctions, disabling equipment operation.
2. When a signal transmission error occurs between the indoor and outdoor units.

In either case, conduct the diagnostic procedure described in the following pages.

### Location of Operation Lamp

In case of  
FTXS 20/25/35/42/50 G Series

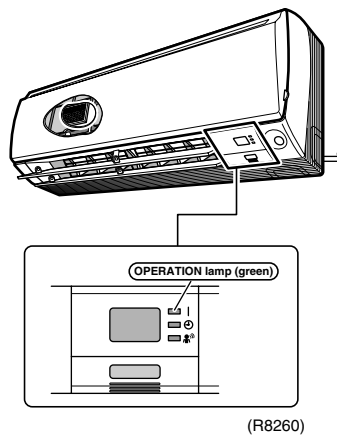

In case of  
FTK(X)S 60/71 F Series

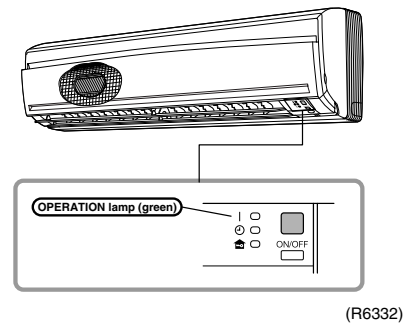

In case of  
FTXG 25/35 E, CTXG 50 E Series

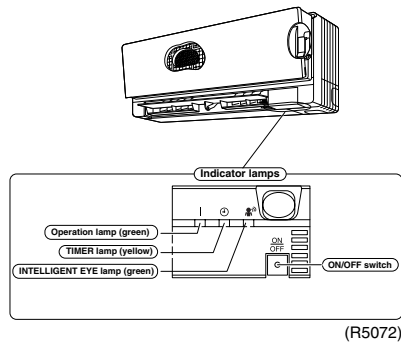

In case of  
FDK(X)S 50/60 C Series  
FDK(X)S 25/35 E Series

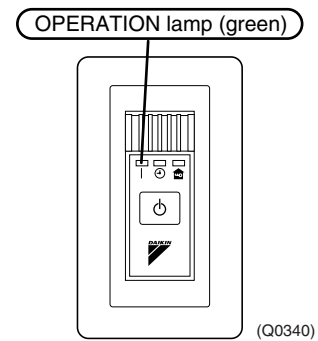

In case of  
FVXS 25/35/50 F Series

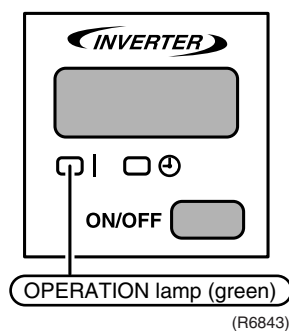

In case of  
FLK(X)S 25/35/50/60 B Series

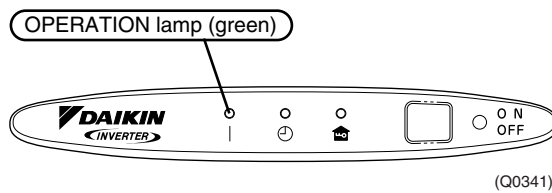

**Caution:**

Operation stops suddenly. (Operation lamp blinks.)

Cause of above trouble could be "Operation mode conflict".

Check followings;

Are the operation modes all the same for indoor units connected to Multi system outdoor unit?  
If not set all indoor units to the same operation mode and confirm that the operation lamp is not blinking.

Moreover, when the operation mode is in "Auto", set all indoor unit operation mode to "Cool" or "Heat" and check again if the operation lamp is normal.

If the lamp stops blinking after the above steps, there is no malfunction.

★Operation stops and operation lamp blinks only for indoor unit which the different operation mode is set later. (The first set operation mode has priority.)

**Troubleshooting  
with the LED  
Indication**

Outdoor Unit

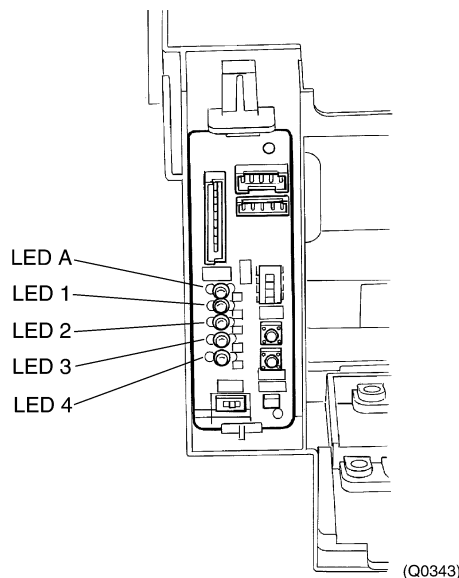

There are green and red LEDs on the PCB. The flashing green LED indicates normal equipment condition, and the OFF condition of the red LED indicates normal equipment condition.

(Troubleshooting with the green LED)

The LED A (green) of the outdoor unit indicate microcomputer operation condition.

Even after the error is cancelled and the equipment operates in normal condition, the LED indication remains.

## 2. Problem Symptoms and Measures

Problem Symptom	Check Item	Details of Measure	Page No. to be referred
None of the units operates.	Check the power supply.	Check to make sure that the rated voltage is supplied.	—
	Check the type of the indoor units.	Check to make sure that the indoor unit type is compatible with the outdoor unit.	—
	Check the outdoor air temperature.	Heating operation cannot be used when the outdoor air temperature is 15.5°C or higher (only for heat pump model), and cooling operation cannot be used when the outdoor air temperature is below -10 °C	—
	Diagnosis with indoor unit LED indication	—	214
	Diagnosis with outdoor unit LED indication	—	215
	Check the remote controller addresses.	Check to make sure that address settings for the remote controller and indoor unit are correct.	—
Operation sometimes stops.	Check the power supply.	A power failure of 2 to 10 cycles can stop air conditioner operation. (Operation lamp OFF)	—
	Check the outdoor air temperature.	Heating operation cannot be used when the outdoor air temperature is 15.5°C or higher (only for heat pump model), and cooling operation cannot be used when the outdoor air temperature is below -10°C	—
	Diagnosis with indoor unit LED indication	—	214
	Diagnosis with outdoor unit LED indication	—	215
Some indoor units do not operate.	Check the type of the indoor units.	Check to make sure that the indoor unit type is compatible with the outdoor unit.	—
	Diagnosis with indoor unit LED indication	—	214
	Diagnosis with outdoor unit LED indication	—	215
Equipment operates but does not cool, or does not heat (only for heat pump model).	Check for wiring and piping errors in the indoor and outdoor units connection wires and pipes.	Conduct the wiring/piping error check described on the product diagnosis nameplate.	—
	Check for thermistor detection errors.	Check to make sure that the main unit's thermistor has not dismounted from the pipe holder.	—
	Check for faulty operation of the electronic expansion valve.	Set the units to cooling operation, and compare the temperatures of the liquid side connection pipes of the connection section among rooms to check the opening and closing operation of the electronic expansion valves of the individual units.	—
	Diagnosis with indoor unit LED indication	—	214
	Diagnosis with outdoor unit LED indication	—	215
	Diagnosis by service port pressure and operating current	Check for insufficient gas.	262
Large operating noise and vibrations	Check the output voltage of the power transistor.	—	263
	Check the power transistor.	—	—
	Check the installation condition.	Check to make sure that the required spaces for installation (specified in the Engineering Data Book, etc.) are provided.	—

## 3. Service Check Function

### 3.1 Check Method 1

The temperature display sections on the main unit indicate corresponding codes.

#### ARC433 Series

1. When the timer cancel button is held down for 5 seconds, a "00" indication flashes on the temperature display section.

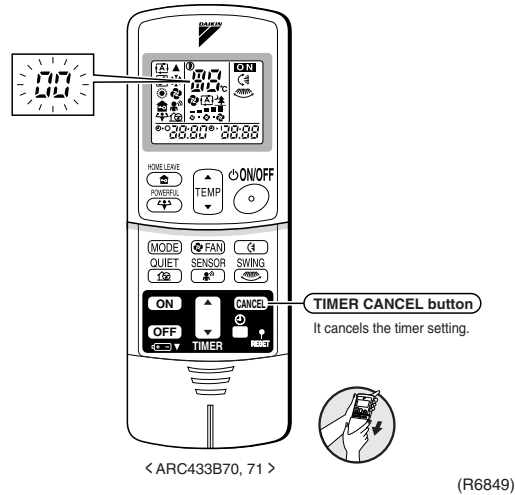

2. Press the timer cancel button repeatedly until a continuous beep is produced.
  - The code indication changes in the sequence shown below, and notifies with a long beep.

No.	Code	No.	Code	No.	Code
1	00	12	C7	23	H0
2	U4	13	H8	24	E1
3	F3	14	J3	25	P4
4	E6	15	R3	26	L3
5	L5	16	R1	27	L4
6	R6	17	C4	28	H6
7	E5	18	C5	29	H7
8	F6	19	H9	30	U2
9	C9	20	J6	31	U4
10	U0	21	UR	32	ER
11	E7	22	R5	33	R4

#### <In case of ARC433B41>

No.	Code	No.	Code	No.	Code
1	00	12	F6	23	R1
2	U4	13	C7	24	E1
3	L5	14	R3	25	UR
4	E6	15	H8	26	U4
5	H6	16	H9	27	P4
6	H0	17	C9	28	L3
7	R6	18	C4	29	L4
8	E7	19	C5	30	H7
9	U0	20	J3	31	U2
10	F3	21	J6	32	ER
11	R5	22	E5	33	R4



#### Note:

1. A short beep and two consecutive beeps indicate non-corresponding codes.
2. To cancel the code display, hold the timer cancel button down for 5 seconds. The code display also cancels itself if the button is not pressed for 1 minute.

ARC452A Series

1. When the timer cancel button is held down for 5 seconds, a "00" indication flashes on the temperature display section.

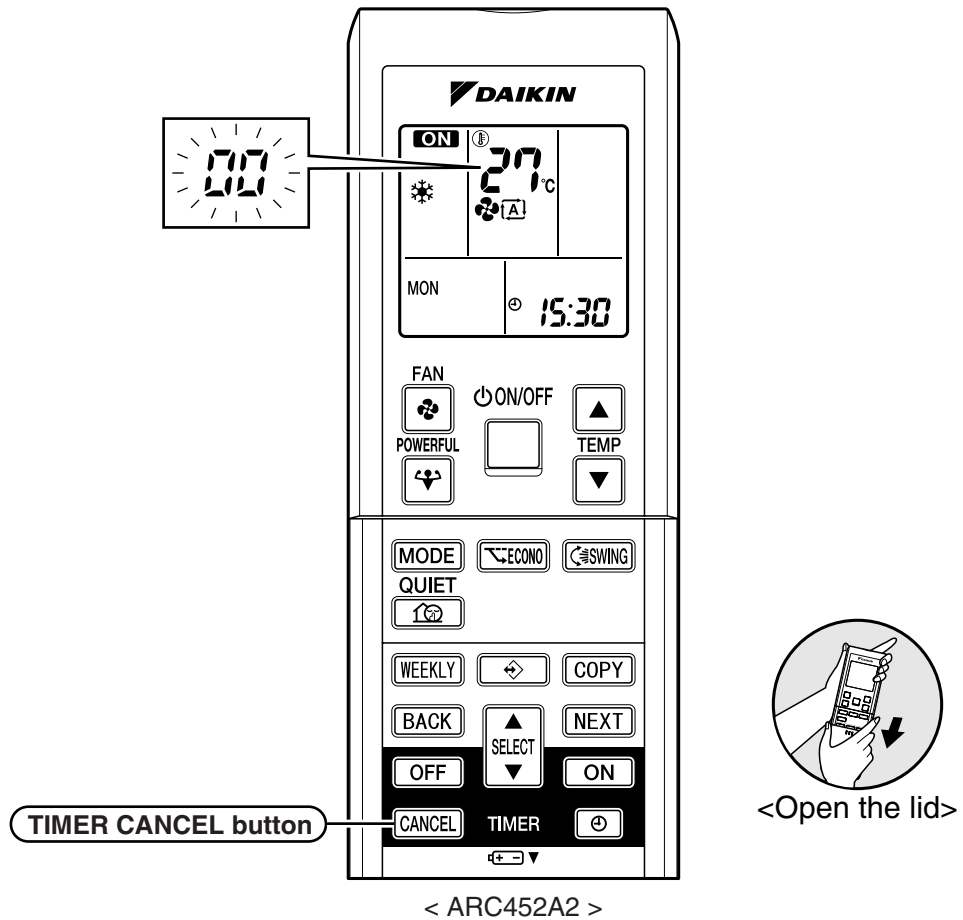

(R6757)

2. Press the timer cancel button repeatedly until a continuous beep is produced.
  - The code indication changes in the sequence shown below, and notifies with a long beep.

No.	Code	No.	Code	No.	Code
1	00	13	C7	25	UR
2	U4	14	R3	26	UM
3	L5	15	H8	27	P4
4	E6	16	H9	28	L3
5	H6	17	C9	29	L4
6	H0	18	C4	30	H7
7	R6	19	C5	31	U2
8	E7	20	J3	32	ER
9	U0	21	J6	33	RM
10	F3	22	E5	34	FR
11	R5	23	R1		
12	F6	24	E1		



**Note:**

1. A short beep and two consecutive beeps indicate non-corresponding codes.
2. To cancel the code display, hold the timer cancel button down for 5 seconds. The code display also cancels itself if the button is not pressed for 1 minute.

## 3.2 Check Method 2

1. Enter the diagnosis mode.  
Press the 3 buttons (TEMP▲,TEMP▼, MODE) simultaneously.

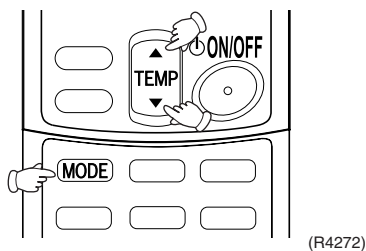

- The digit of the number of tens blinks.
- ★Try again from the start when the digit does not blink.

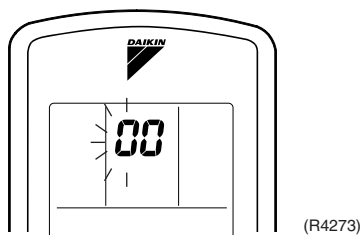

2. Press the TEMP button.  
Press TEMP▲ or TEMP▼ and change the digit until you hear the sound of “beep” or “pi pi”.

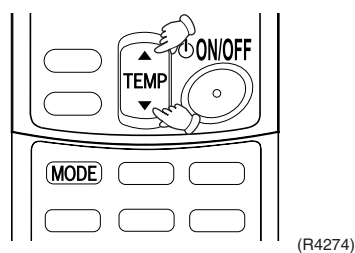

3. Diagnose by the sound.
  - ★“pi” : The number of tens does not accord with the error code.
  - ★“pi pi” : The number of tens accords with the error code.
  - ★“beep” : The both numbers of tens and units accord with the error code. (→ See 7.)
4. Enter the diagnosis mode again.  
Press the MODE button.

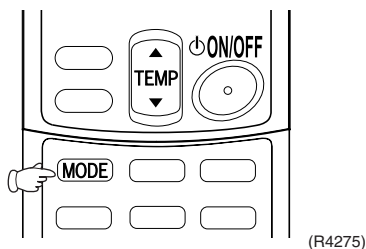

- The digit of the number of units blinks.

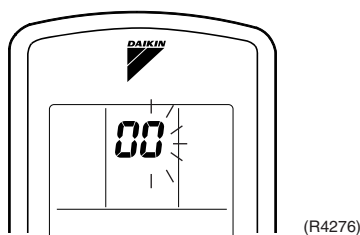

5. Press the TEMP button.  
Press TEMP▲ or TEMP▼ and change the digit until you hear the sound of “beep”.

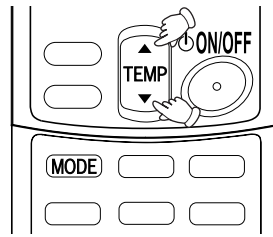

(R4277)

6. Diagnose by the sound.
  - ★“pi” : The both numbers of tens and units do not accord with the error code.
  - ★“pi pi” : The number of tens accords with the error code.
  - ★“beep” : The both numbers of tens and units accord with the error code.
7. Determine the error code.  
The digits indicated when you hear the “beep” sound are error code.  
(Error codes and description → Refer to page 213.)
8. Exit from the diagnosis mode.  
Press the MODE button.

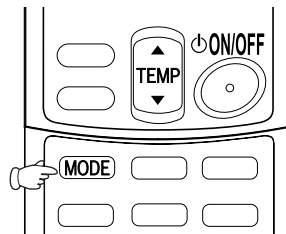

(R4278)

## 4. Code Indication on the Remote Controller

### 4.1 Error Codes and Description of Fault

	Code Indication	Description of Problem
System	00	Normal
	U0	Insufficient gas
	U2	Low-voltage detection or over-voltage detection
	U4	Signal transmission error (between indoor and outdoor units)
	U7	Signal transmission error (on outdoor unit PCB)
	UR	Unspecified voltage (between indoor and outdoor units)
	UH	Anti-icing function in other rooms
Indoor Unit	R1	Indoor unit PCB abnormality
	R5	Freeze-up protection function or high pressure control
	R6	Fan motor or related abnormality
	C4	Heat exchanger temperature thermistor abnormality
	C7	Front panel open / close fault
	C9	Room temperature thermistor abnormality
Outdoor Unit	R5	Freeze-up protection control
	E1	Outdoor unit PCB abnormality
	E5	OL activation (compressor overloaded)
	E6	Compressor lock
	E7	DC fan lock
	E8	Input over current detection
	F3	Discharge pipe temperature control
	F6	High pressure control in cooling
	H0	Compressor sensor system abnormality
	H6	Position sensor abnormality
	H8	CT or related abnormality
	H9	Outdoor air thermistor or related abnormality
	J3	Discharge pipe thermistor or related abnormality
	J6	Heat exchanger thermistor or related abnormality
	J8	Liquid pipe thermistor or related abnormality
	J9	Gas pipe thermistor or related abnormality
	L3	Electrical box temperature rise
	L4	Radiation fin temperature rise
	L5	Output over current detection
	P4	Radiation fin thermistor or related abnormality



# 5. Troubleshooting

## 5.1 Indoor Units

- : Not used for troubleshooting

\* : Varies depending on the cases.

Indication on the remote controller	Description of the Fault		Details of fault (Refer to the indicated page.)
<i>00</i>	Indoor unit in normal condition (Conduct a diagnosis of the outdoor unit.)		—
<i>R1</i>	Indoor unit PCB abnormality		216
<i>R5</i>	Freeze-up protection control or high pressure control (heat pump model only)		217
<i>R6</i>	Fan motor or related abnormality	AC motor (Duct, Floor / Ceiling)	219
		DC motor (Wall, Floor)	220
<i>E4</i>	Heat exchanger thermistor or related abnormality		222
<i>E7</i>	Front panel open / close fault (FTXG-E series, CTXG-E series)		223
<i>E9</i>	Room temperature thermistor abnormality		222
<i>U4</i>	Signal transmission error (between indoor and outdoor units)		224
<i>UR</i>	Unspecified voltage (between indoor and outdoor units)		226

## 5.2 Outdoor Units

☉: ON, ●: OFF, ◐: Blinks

Green : Flashes when in normal condition

Red : OFF in normal condition

- : Not used for troubleshooting

\* : Varies depending on the cases.

Outdoor Unit LED Indication					Indication on the remote controller	Description of The Fault	Reference Page
Green	Red						
A	1	2	3	4			
◐	●	●	●	●	00	Outdoor unit in normal condition (Conduct a diagnosis of the indoor unit.)	—
					UR	Unspecified voltage (between indoor and outdoor units)	255
					UH	Anti-icing function in other rooms	255
◐	●	●	☉	☉	(U0)	Insufficient gas	251
◐	☉	●	●	☉	U2	Low-voltage detection or over-voltage detection	253
◐	●	☉	☉	☉	U7	Signal transmission error (on outdoor unit PCB)	254
◐	☉	●	☉	☉	R5	Freeze-up protection control	227
◐	☉	☉	☉	●	E1	Outdoor unit PCB abnormality	229
◐	☉	●	☉	●	(E5)	OL activation (compressor overload)	230
◐	●	☉	☉	●	(E6)	Compressor lock	231
◐	☉	☉	☉	☉	E7	DC fan lock	232
◐	●	☉	●	☉	E8	Input over current detection	233
◐	☉	●	☉	●	F3	Discharge pipe temperature control	235
◐	☉	●	☉	☉	F6	High pressure control in cooling	236
◐	☉	☉	●	●	H0	Compressor sensor system abnormality	238
					H8	CT or related abnormality	241
◐	☉	☉	●	●	H5	Position sensor abnormality	240
					H9	Outdoor air thermistor or related abnormality	243
					J3	Discharge pipe thermistor or related abnormality	243
					J6	Heat exchanger thermistor or related abnormality	243
					J8	Liquid pipe thermistor or related abnormality	243
					J9	Gas pipe thermistor or related abnormality	243
◐	☉	☉	●	☉	P4	Radiation fin thermistor or related abnormality	243
					L3	Electrical box temperature rise	245
◐	●	●	●	☉	L4	Radiation fin temperature rise (Protection of driver overheating)	247
◐	●	●	☉	●	L5	Output over current detection	249



**Note:**

- The indications in the parenthesis ( ) in the remote controller display column are displayed only when system-down occurs.
- When a sensor error occurs, check the remote controller display to determine which sensor is malfunctioning.  
If the remote controller does not indicate the error type, conduct the following operation.  
\*Turn the power switch off and back on again. If the same LED indication appears again immediately after the power is turned on, the fault is in the thermistor.  
\*If the above condition does not result, the fault is in the CT.
- The indoor unit error indication may take the precedence in the remote controller display.

## 5.3 Indoor Unit PCB Abnormality

Remote Controller Display	81
Method of Malfunction Detection	Evaluation of zero-cross detection of power supply by indoor unit.
Malfunction Decision Conditions	When there is no zero-cross detection in approximately 10 continuous seconds.
Supposed Causes	<ul style="list-style-type: none"> <li>■ Faulty indoor unit PCB</li> <li>■ Faulty connector connection</li> </ul>

### Troubleshooting

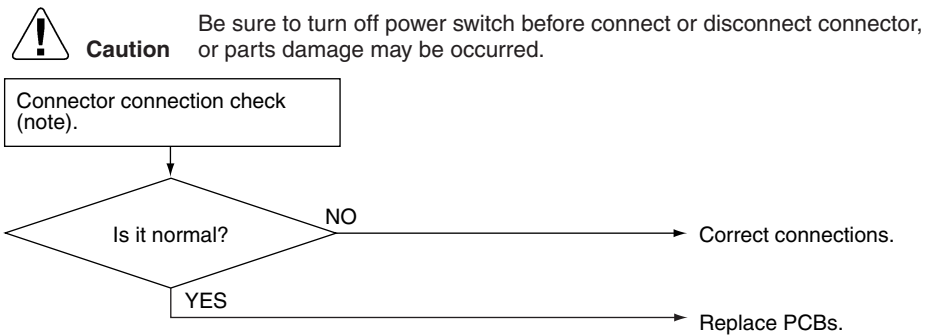

(R7130)

 **Note:** Connector Nos. vary depending on models.  
Control connector

Model Type	Connector No.
Wall Mounted Type	Terminal strip~Control PCB
Duct Connected Type	Terminal strip~Control PCB
Floor / Ceiling Suspended Dual Type	S37
Floor Standing Type	Terminal strip~Control PCB

## 5.4 Freeze-up Protection Control or High Pressure Control

### Remote Controller Display

85

### Method of Malfunction Detection

- High pressure control (heat pump model only)  
During heating operations, the temperature detected by the indoor heat exchanger thermistor is used for the high pressure control (stop, outdoor fan stop, etc.)
- The freeze-up protection control (operation halt) is activated during cooling operation according to the temperature detected by the indoor unit heat exchanger thermistor.

### Malfunction Decision Conditions

- High pressure control  
During heating operations, the temperature detected by the indoor heat exchanger thermistor is above 65°C
- Freeze-up protection  
When the indoor unit heat exchanger temperature is below 0°C during cooling operation.

### Supposed Causes

- Operation halt due to clogged air filter of the indoor unit.
- Operation halt due to dust accumulation on the indoor unit heat exchanger.
- Operation halt due to short-circuit.
- Detection error due to faulty indoor unit heat exchanger thermistor.
- Detection error due to faulty indoor unit PCB.

Troubleshooting

  
**Check No.06**  
 Refer to P.259



**Caution**

Be sure to turn off power switch before connect or disconnect connector, or parts damage may be occurred.

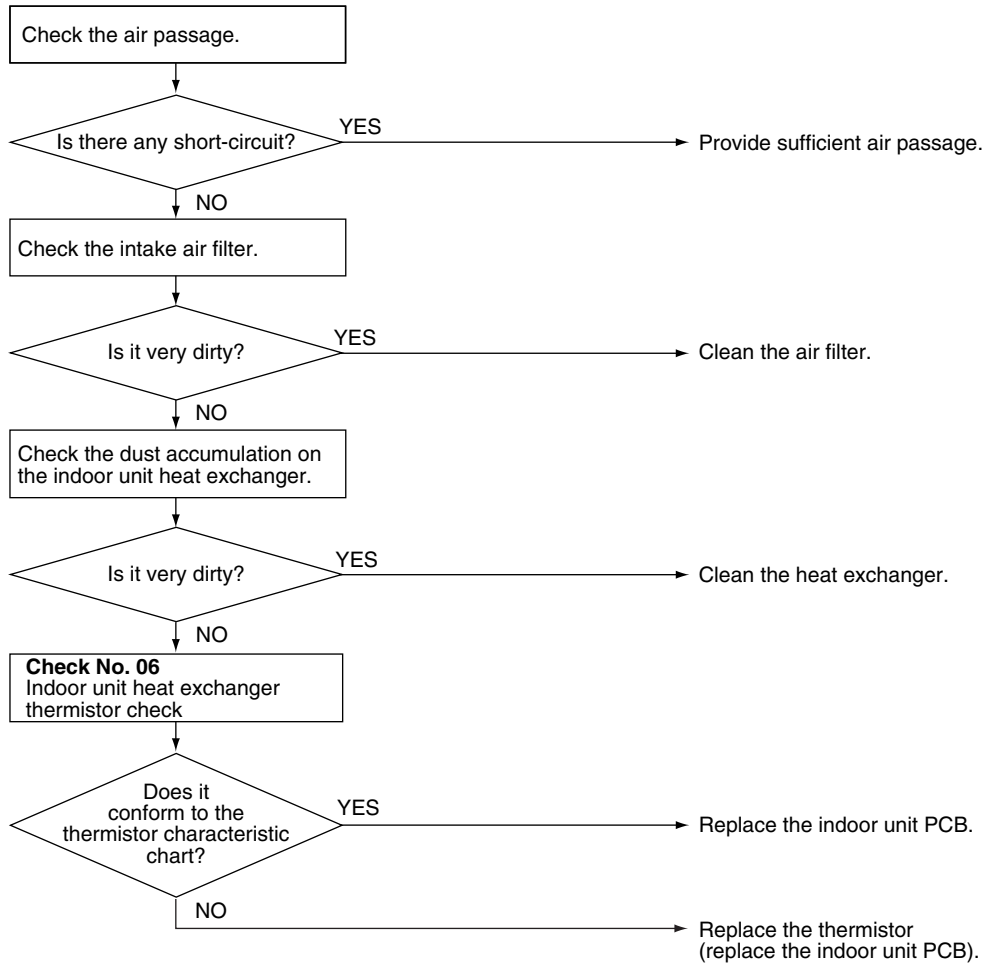

(R7131)



**Note:**

If the outside temperature is below  $-10^{\circ}\text{C}$  in the cooling mode, the system may get interrupted with error *R5* displayed. The system will be reset itself, but this stop will be put in the error history memory.

## 5.5 Fan Motor or Related Abnormality

### 5.5.1 AC Motor

Remote Controller Display



Method of Malfunction Detection

The rotation speed detected by the Hall IC during fan motor operation is used to determine abnormal fan motor operation.

Malfunction Decision Conditions

When the detected rotation speed does not reach the demanded rotation speed of the target tap, and is less than 50% of the maximum fan motor rotation speed.

Supposed Causes

- Operation halt due to short circuit inside the fan motor winding.
- Operation halt due to breaking of wire inside the fan motor.
- Operation halt due to breaking of the fan motor lead wires.
- Operation halt due to faulty capacitor of the fan motor.
- Detection error due to faulty control PCB.

#### Troubleshooting



Check No.16  
Refer to P.265



**Caution**

Be sure to turn off power switch before connect or disconnect connector, or parts damage may be occurred.

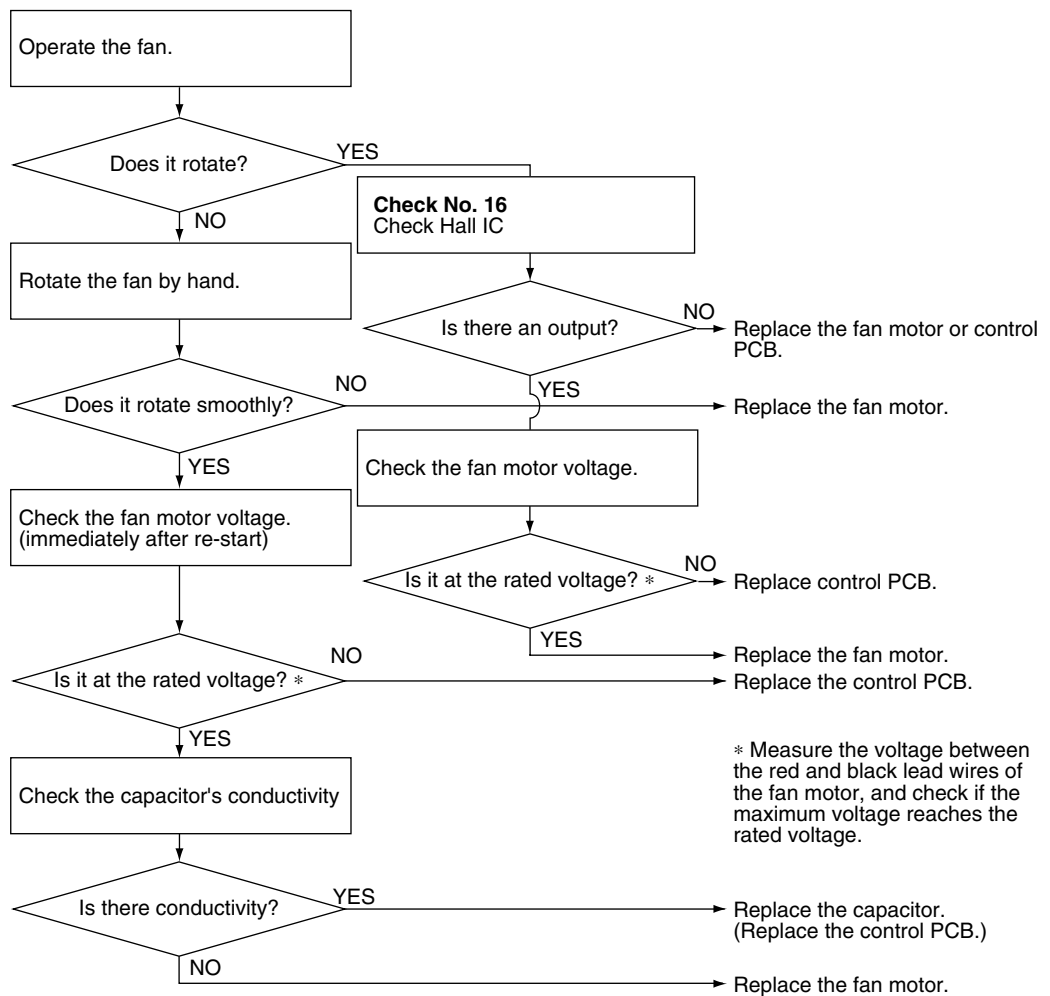

\* Measure the voltage between the red and black lead wires of the fan motor, and check if the maximum voltage reaches the rated voltage.

(R7132)

## 5.5.2 DC Motor

**Remote  
Controller  
Display**



**Method of  
Malfunction  
Detection**

The rotation speed detected by the [Hall IC](#) during fan motor operation is used to determine abnormal fan motor operation.

**Malfunction  
Decision  
Conditions**

When the detected rotation speed does not reach the demanded rotation speed of the target tap, and is less than 50% of the maximum fan motor rotation speed.

**Supposed  
Causes**

- Operation halt due to short circuit inside the fan motor winding.
- Operation halt due to breaking of wire inside the fan motor.
- Operation halt due to breaking of the fan motor lead wires.
- Operation halt due to faulty capacitor of the fan motor.
- Detection error due to faulty indoor unit PCB.

Troubleshooting



**Check No.01**  
Refer to P.256



**Check No.02**  
Refer to P.256



**Caution**

Be sure to turn off power switch before connect or disconnect connector, or parts damage may be occurred.

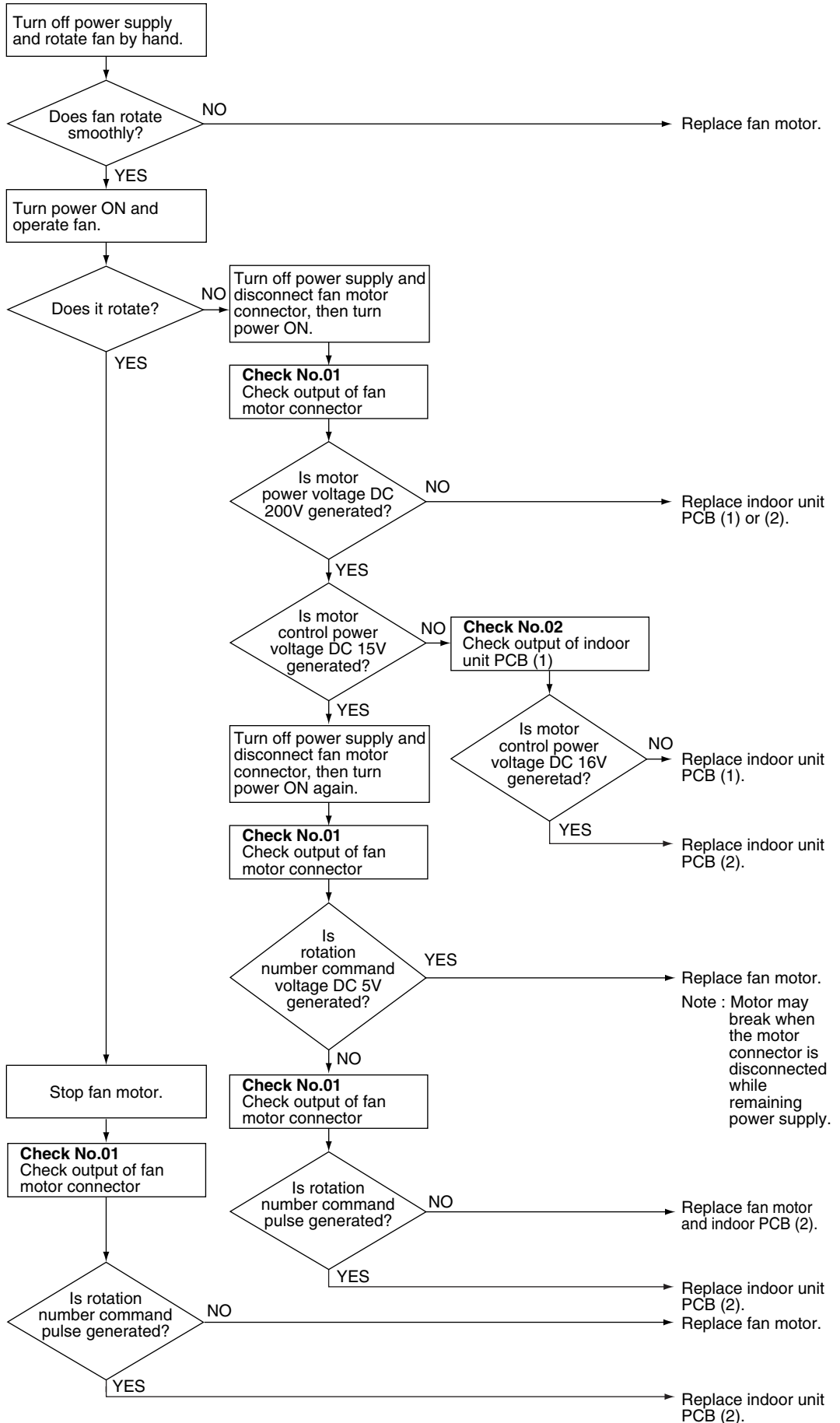

(R7171)



## 5.6 Thermistor or Related Abnormality (Indoor Unit)

Remote Controller Display	
Method of Malfunction Detection	The temperatures detected by the thermistors are used to determine thermistor errors.
Malfunction Decision Conditions	When the thermistor input is more than 4.96 V or less than 0.04 V during compressor operation*. * (reference) When above about 212°C (less than 120 ohms) or below about -50°C (more than 1,860 kohms).
Supposed Causes	<ul style="list-style-type: none"> <li>■ Faulty connector connection</li> <li>■ Faulty thermistor</li> <li>■ Faulty PCB</li> </ul>

 **Note:** The values vary slightly in some models.

### Troubleshooting

  
**Check No.06**  
 Refer to P.259

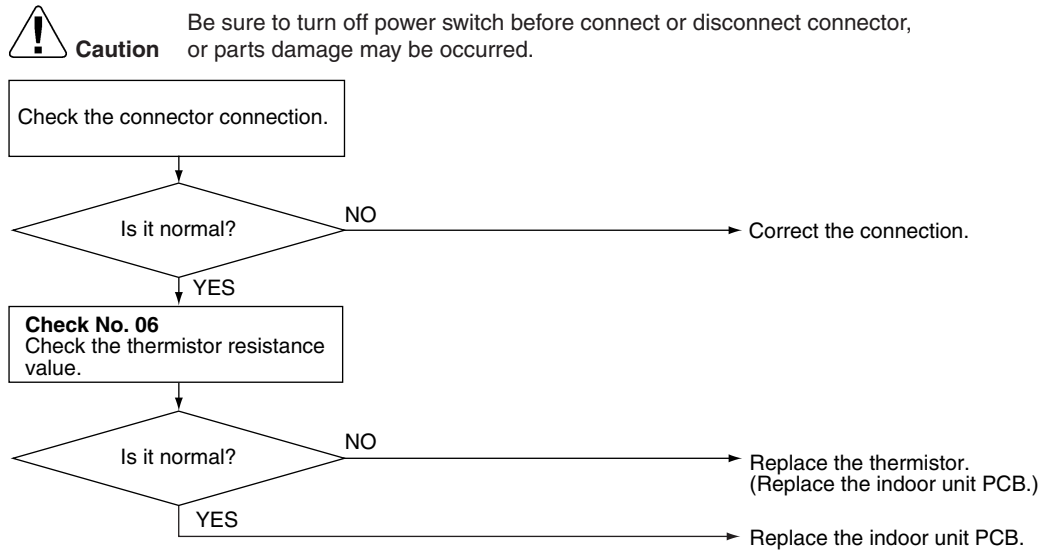

(R7134)

24 : Heat exchanger temperature thermistor  
 29 : Room temperature thermistor

## 5.7 Front Panel Open / Close Fault

Remote  
Controller  
Display

E7

Method of  
Malfunction  
Detection

Malfunction  
Decision  
Conditions

- The system will be shut down when the error occurs twice.

Supposed  
Causes

- Malfunction of the reduction motor
- Malfunction or deterioration of the front panel mechanism
- Malfunction of the limit switch

### Troubleshooting

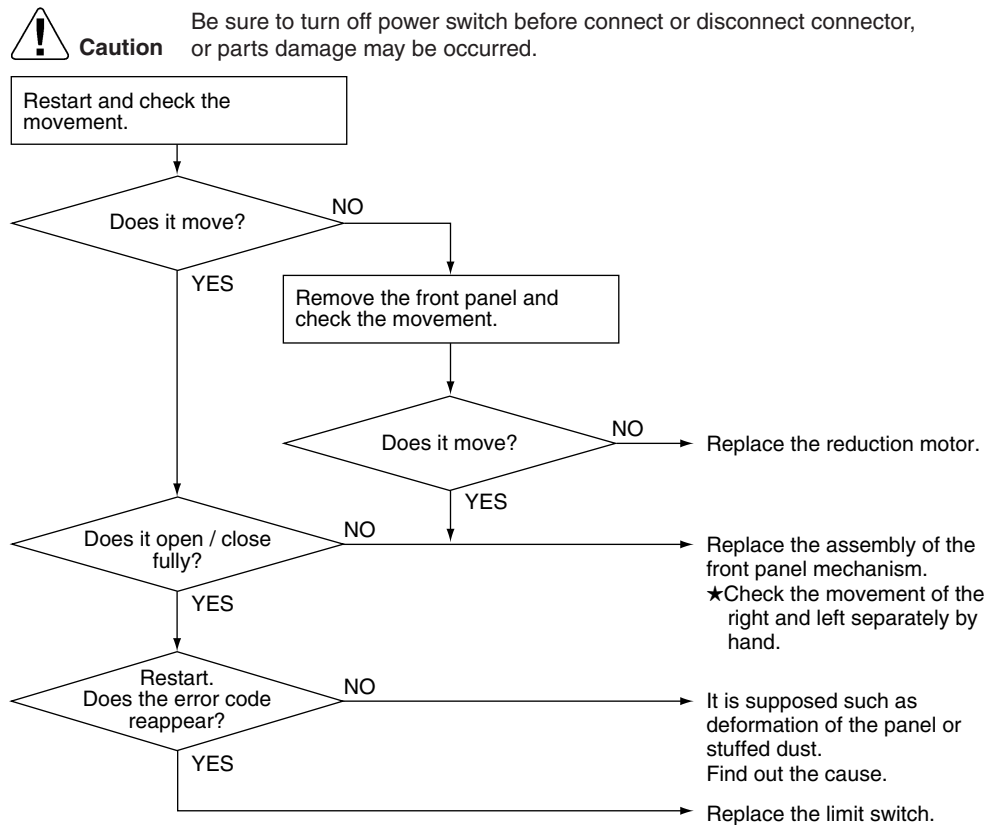

(R7135)



**Note:** You cannot operate the unit by the remote controller when the front panel mechanism breaks down.

<To the dealers: temporary measure before repair>

1. Pull the plug out or turn the breaker off.
2. Remove the decorative plate.
3. Remove the slot-in panel.
4. Put the plug in or turn the breaker on.  
(Wait until the initialization finishes.)
5. Operate the unit by the indoor unit ON/OFF switch.

## 5.8 Signal Transmission Error (between Indoor and Outdoor Unit)

Remote  
Controller  
Display

U4

Method of  
Malfunction  
Detection

The data received from the outdoor unit in indoor unit-outdoor unit signal transmission is checked whether it is normal.

Malfunction  
Decision  
Conditions

When the data sent from the outdoor unit cannot be received normally, or when the content of the data is abnormal.

Supposed  
Causes

- Faulty outdoor unit PCB.
- Faulty indoor unit PCB.
- Indoor unit-outdoor unit signal transmission error due to wiring error.
- Indoor unit-outdoor unit signal transmission error due to disturbed power supply waveform.
- Indoor unit-outdoor unit signal transmission error due to breaking of wire in the connection wires between the indoor and outdoor units (wire No. 3).
- Short circuit inside the fan motor winding.

## Troubleshooting

**Check No.10**  
**Refer to P.262**

**Caution** Be sure to turn off power switch before connect or disconnect connector, or parts damage may be occurred.

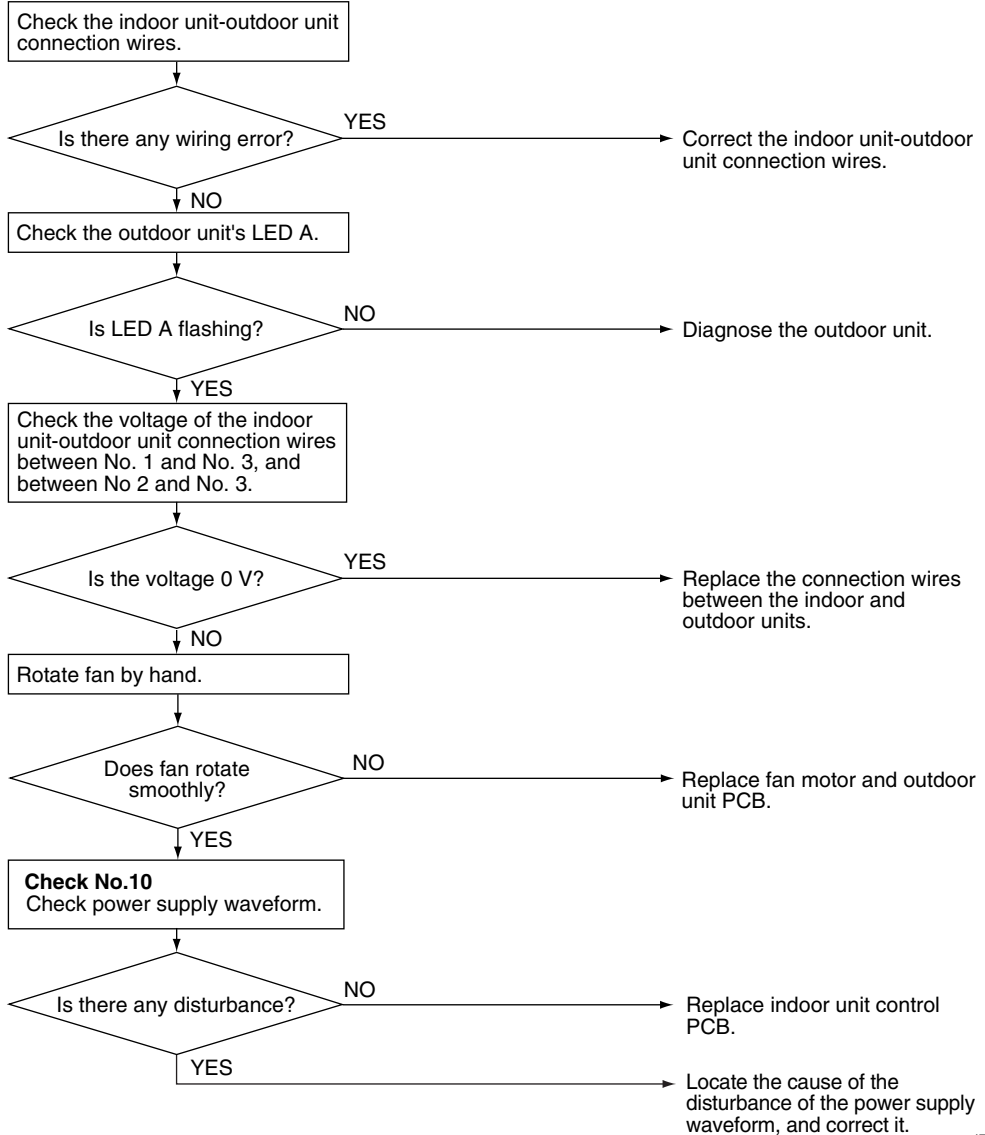

(R7236)

## 5.9 Unspecified Voltage (between Indoor and Outdoor Units)

Remote  
Controller  
Display

UR

Method of  
Malfunction  
Detection

The supply power is detected for its requirements (different from pair type and multi type) by the indoor / outdoor transmission signal.

Malfunction  
Decision  
Conditions

The pair type and multi type are interconnected.

Supposed  
Causes





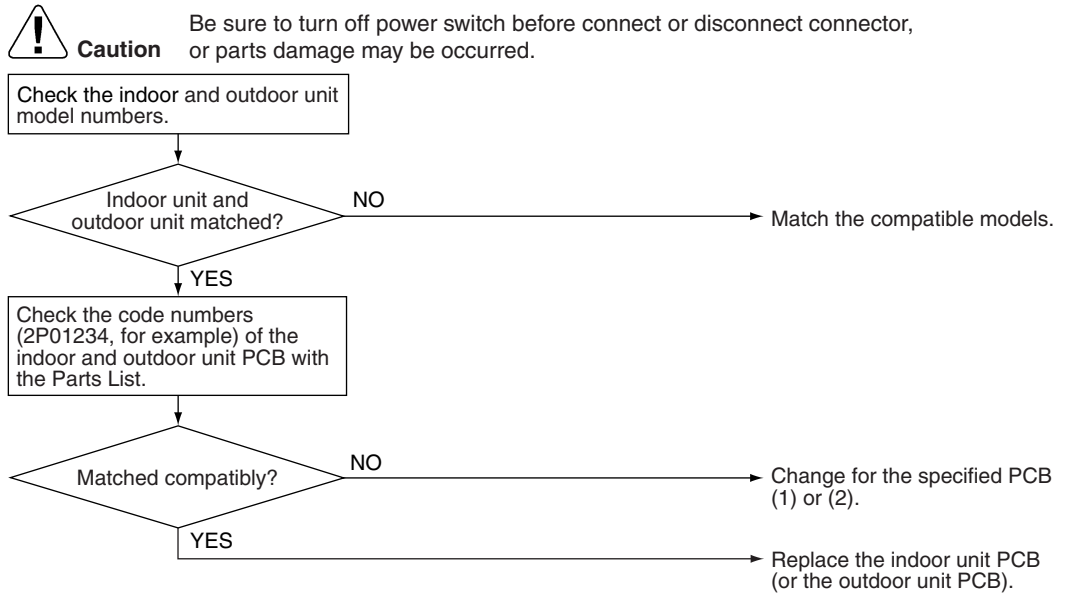

- Wrong models interconnected
- Wrong indoor unit PCB mounted
- Indoor unit PCB defective
- Wrong outdoor unit PCB mounted or defective

### Troubleshooting



(R7181)

## 5.10 Freeze-up Protection Control

<b>Remote Controller Display</b>	
<b>Outdoor Unit LED Display</b>	A  1  2  3  4 
<b>Method of Malfunction Detection</b>	Indoor unit icing, during cooling operation, is detected by checking the temperatures sensed by the indoor unit heat exchanger thermistor and room temperature thermistor that are located in a shut-down room.
<b>Malfunction Decision Conditions</b>	<p>In the cooling mode, the following conditions (A) and (B) are kept together for 5 minutes.</p> <p>(A) Indoor unit heat exchanger temperature <math>\leq -1^{\circ}\text{C}</math></p> <p>(B) Indoor unit heat exchanger temperature <math>\leq</math> Room temperature <math>-10^{\circ}\text{C}</math></p> <p>If the freeze-up protection control is activated 4 times continuously, the system will be shut down.  (The 4-time counter will reset itself if any of the following errors does not occur for 60 minutes: OL, radiation fin temperature rise, gas shortage, and compressor startup.)</p>
<b>Supposed Causes</b>	<ul style="list-style-type: none"> <li>■ Wrong wiring or piping</li> <li>■ EV malfunctioning in each room</li> <li>■ Short-circuit</li> <li>■ Indoor unit heat exchanger thermistor defective</li> <li>■ Room temperature thermistor defective</li> </ul>

Troubleshooting



**Check No.04**  
Refer to P.257



**Check No.06**  
Refer to P.259



**Caution**

Be sure to turn off power switch before connect or disconnect connector, or parts damage may be occurred.

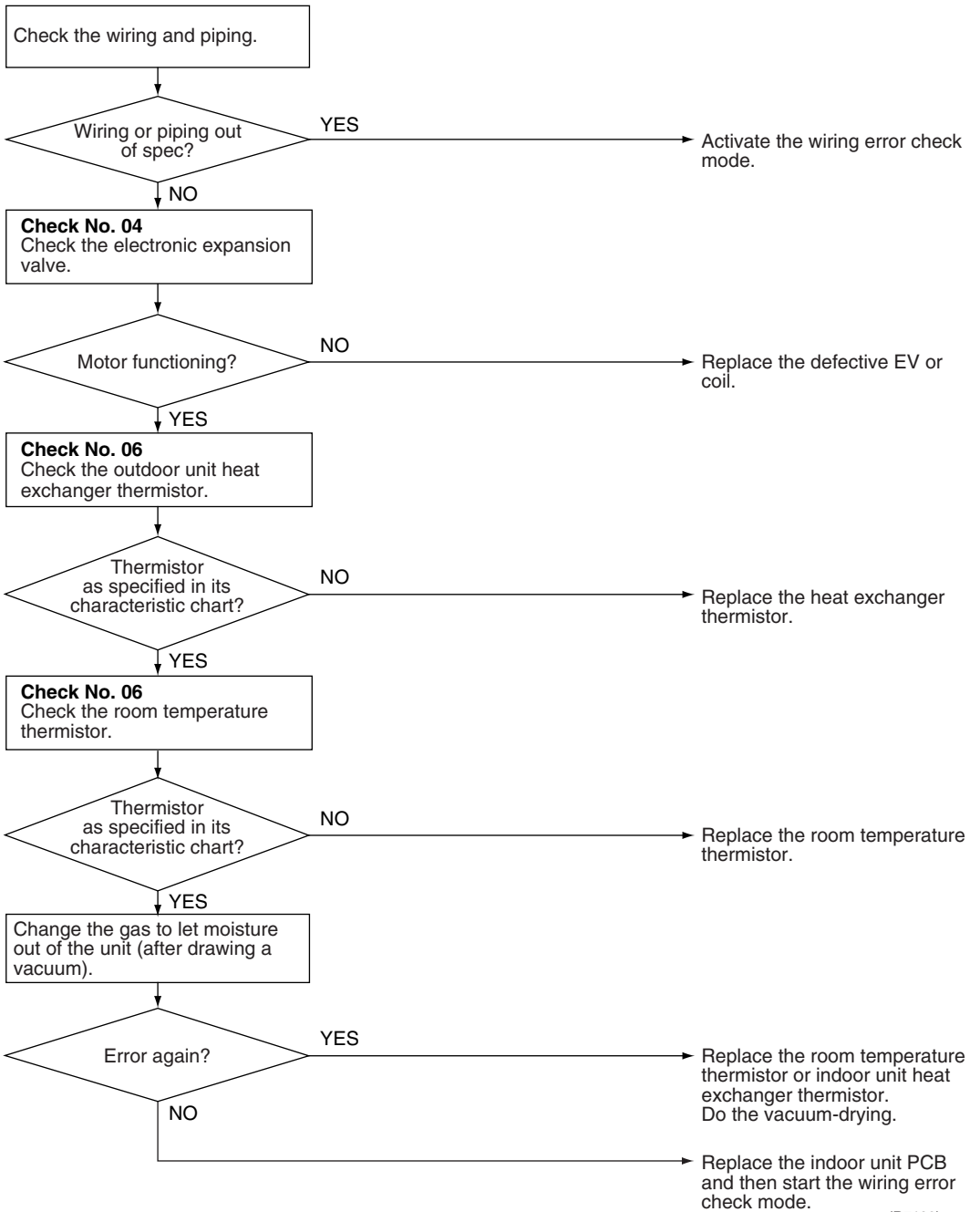





(R7182)

## 5.11 Outdoor Unit PCB Abnormality

Remote  
Controller  
Display

E1

Outdoor Unit LED  
Display

A  1  2  3  4 

Method of  
Malfunction  
Detection

- Detect within the programme of the microcomputer that the programme is in normal running order.

Malfunction  
Decision  
Conditions

- When the programme of the microcomputer is in abnormal running order.

Supposed  
Causes

- Out of control of microcomputer caused by external factors
  - Noise
  - Momentary fall of voltage
  - Momentary power loss
- Defective outdoor unit PCB

### Troubleshooting



**Caution**

Be sure to turn off power switch before connect or disconnect connector, or parts damage may be occurred.

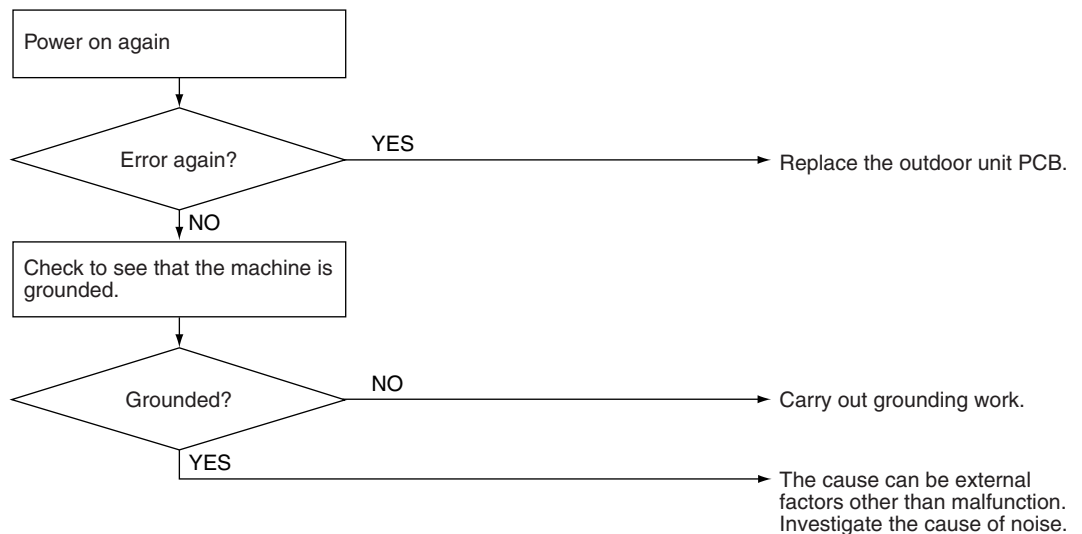





(R7183)



## 5.12 OL Activation (Compressor Overload)

Remote Controller Display	ES
Outdoor Unit LED Display	A ● 1 ☉ 2 ● 3 ☉ 4 ●
Method of Malfunction Detection	A compressor overload is detected through compressor OL.
Malfunction Decision Conditions	<ul style="list-style-type: none"> <li>■ If the compressor OL is activated twice, the system will be shut down.</li> <li>■ The error counter will reset itself if this or any other error does not occur during the following 60-minute compressor running time (total time).</li> </ul> <p>* The operating temperature condition is not specified.</p>
Supposed Causes	<ul style="list-style-type: none"> <li>■ Refrigerant shortage</li> <li>■ Four way valve malfunctioning</li> <li>■ Outdoor unit PCB defective</li> <li>■ Water mixed in the local piping</li> <li>■ Electronic expansion valve defective</li> <li>■ Stop valve defective</li> </ul>

### Troubleshooting

-  **Check No.04**  
Refer to P.257
-  **Check No.05**  
Refer to P.258
-  **Check No.06**  
Refer to P.259
-  **Check No.11**  
Refer to P.262

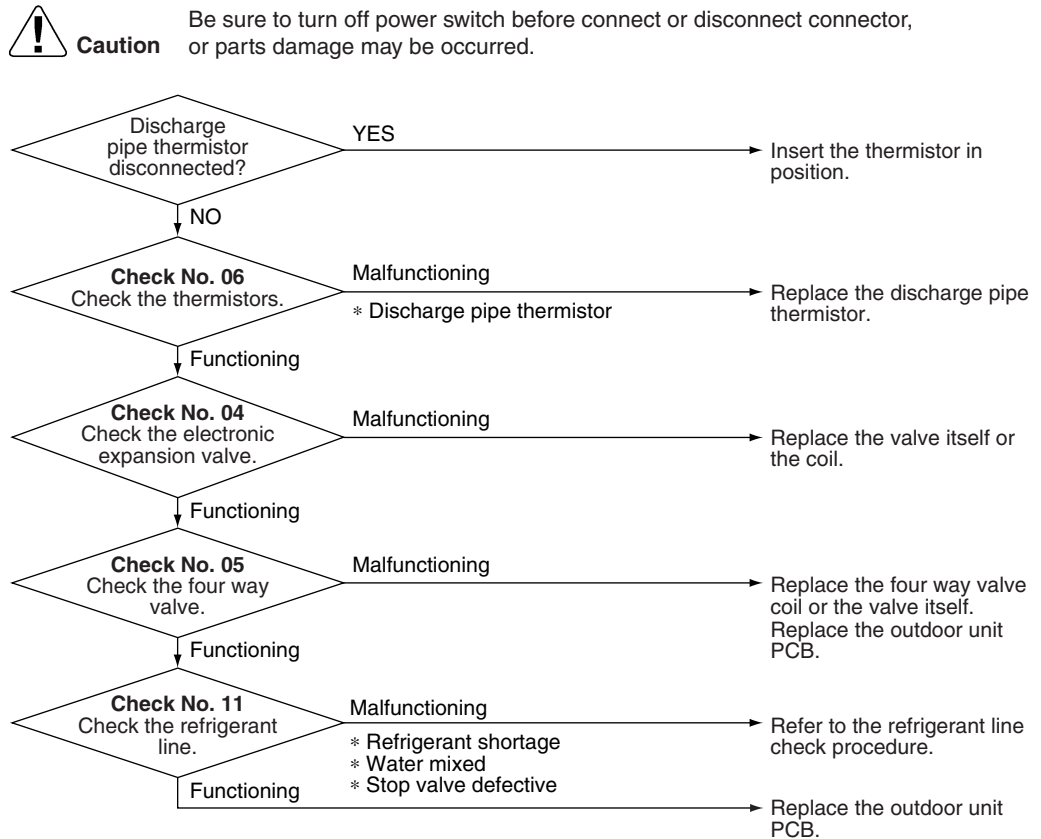

(R7137)

## 5.13 Compressor Lock

Remote  
Controller  
Display



Outdoor Unit LED  
Display

A 1 2 3 4

Method of  
Malfunction  
Detection

A compressor lock is detected by checking the compressor running condition through the position detection circuit.

Malfunction  
Decision  
Conditions

- Judging from current waveform generated when high-frequency voltage is applied to the compressor.
- The system will be shut down if the error occurs 16 times.
- Clearing condition: Continuous run for about 5 minutes (normal)



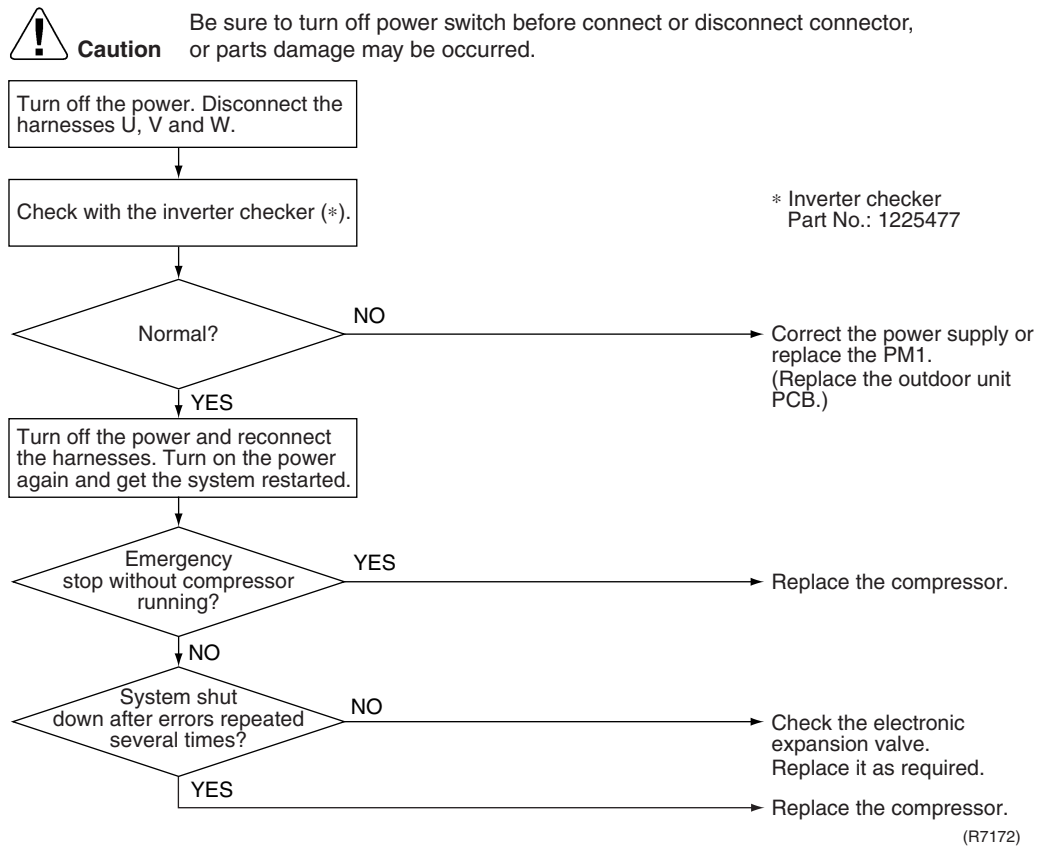

Supposed  
Causes

- Compressor locked

Troubleshooting



## 5.14 DC Fan Lock

Remote Controller Display	E7
Outdoor Unit LED Display	A  1  2  3  4
Method of Malfunction Detection	A fan motor line error is detected by checking the high-voltage fan motor rpm being detected by the Hall IC.
Malfunction Decision Conditions	<ul style="list-style-type: none"> <li>■ The fan does not start in 30 seconds even when the fan motor is running.</li> <li>■ The system will be shut down if the error occurs 16 times.</li> <li>■ Clearing condition: Continuous run for about 5 minutes (normal)</li> </ul>
Supposed Causes	<ul style="list-style-type: none"> <li>■ Fan motor breakdown</li> <li>■ Harness or connector disconnected between fan motor and PCB or in poor contact</li> <li>■ Foreign matters stuck in the fan</li> </ul>

### Troubleshooting

  
**Check No.15**  
 Refer to P.264

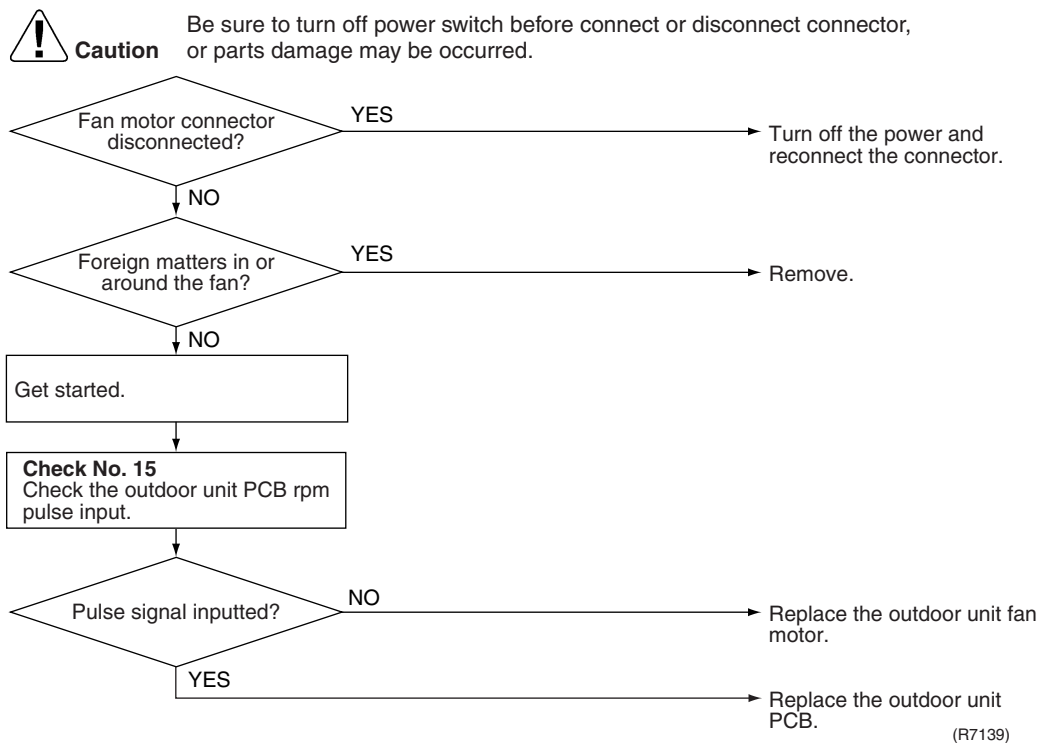

## 5.15 Input Over Current Detection

Remote  
Controller  
Display



Outdoor Unit LED  
Display

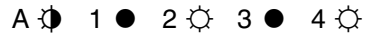

Method of  
Malfunction  
Detection

Malfunction is detected by checking the input current value.

Malfunction  
Decision  
Conditions

- The following condition continues for 2.5 seconds.  
Input current  $\geq 20\text{A}$  (typical value)
- The compressor halts if the error occurs, and restarts automatically after 3 minutes stand-by.

Supposed  
Causes

- Over-current due to compressor failure
- Over-current due to defective power transistor
- Over-current due to defective inverter main circuit electrolytic capacitor
- Over-current due to defective outdoor unit PCB
- Error detection due to outdoor unit PCB
- Over-current due to short-circuit

Troubleshooting



**Check No.07**  
Refer to P.260



**Check No.08**  
Refer to P.261



**Check No.14**  
Refer to P.264



**Caution**

Be sure to turn off power switch before connect or disconnect connector, or parts damage may be occurred.

\* An input over-current may result from wrong internal wiring. If the wires have been disconnected and reconnected for part replacement, for example, and the system is interrupted by an input over-current, check the wires again.

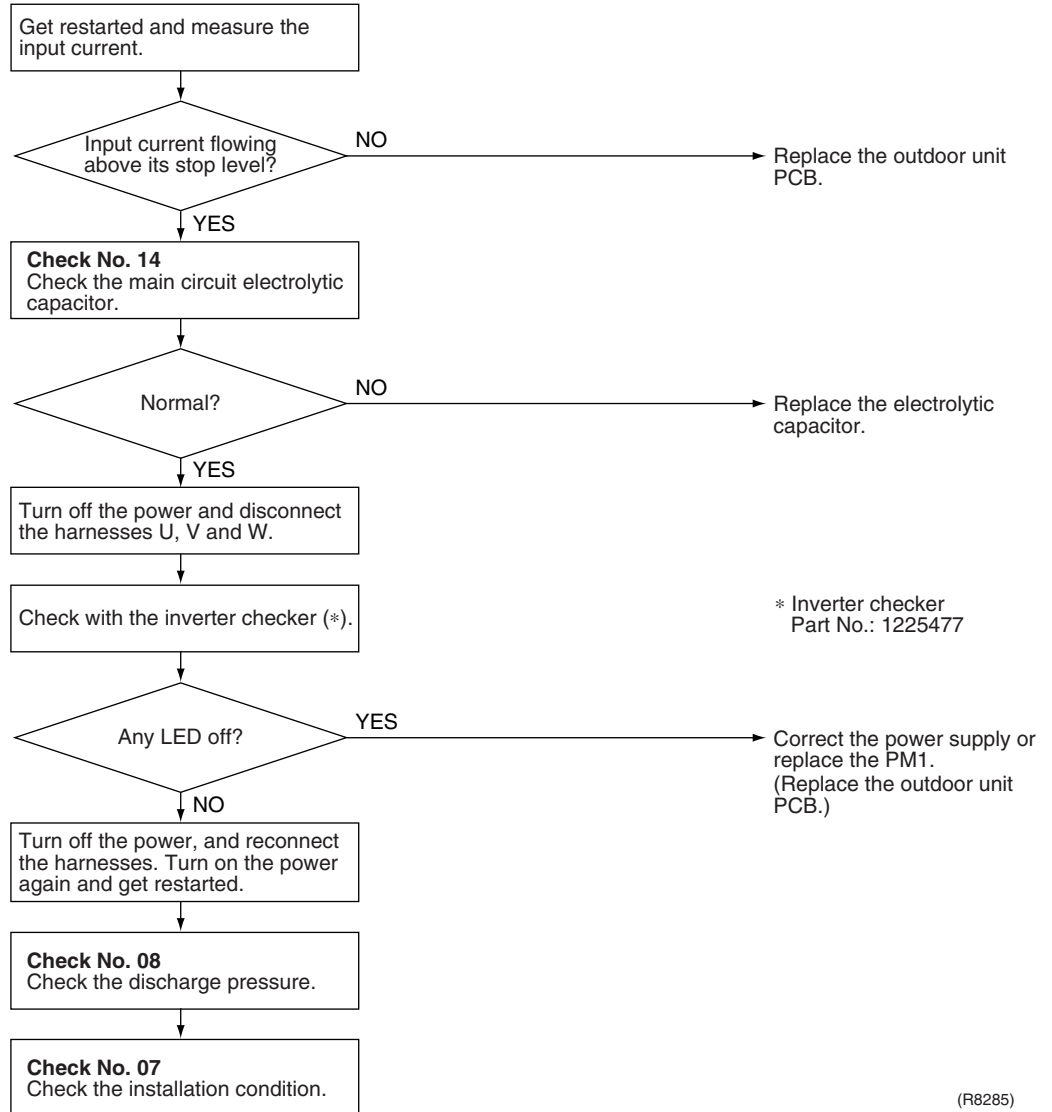

(R8285)

## 5.16 Discharge Pipe Temperature Control

Remote Controller Display



Outdoor Unit LED Display

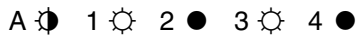

Method of Malfunction Detection

The discharge pipe temperature control (stop, frequency drooping, etc.) is checked with the temperature being detected by the discharge pipe thermistor.

Malfunction Decision Conditions

**2YC45**

If the temperature being detected by the discharge pipe thermistor rises above 120°C, the compressor will stop. (The error is cleared when the temperature has dropped below 107°C.)

- If the compressor stops 6 times straight due to abnormal discharge pipe temperature, the system will be shut down.
- The error counter will reset itself if this or any other error does not occur during the following 60-minute compressor running time (total time).

Supposed Causes





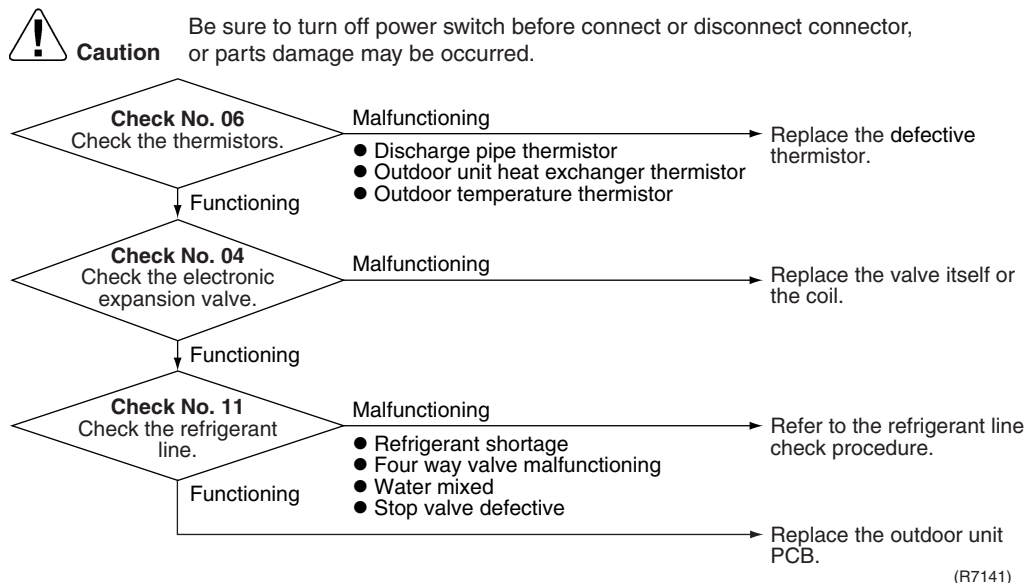

- Refrigerant shortage
- Four way valve malfunctioning
- Discharge pipe thermistor defective (heat exchanger or outdoor temperature thermistor defective)
- Outdoor unit PCB defective
- Water mixed in the local piping
- Electronic expansion valve defective
- Stop valve defective

Troubleshooting

- Check No.04**  
Refer to P.257
- Check No.06**  
Refer to P.259
- Check No.11**  
Refer to P.262



## 5.17 High Pressure Control in Cooling

<p><b>Remote Controller Display</b></p>	
<p><b>Outdoor Unit LED Display</b></p>	<p>A  1  2  3  4 </p>
<p><b>Method of Malfunction Detection</b></p>	<p>High-pressure control (stop, frequency drop, etc.) is activated in the cooling mode if the temperature being sensed by the heat exchanger thermistor exceeds the limit.</p>
<p><b>Malfunction Decision Conditions</b></p>	<ul style="list-style-type: none"> <li>■ Activated when the temperature being sensed by the heat exchanger thermistor rises above 65°C.</li> <li>■ The error is cleared when the temperature drops below 50°C.</li> </ul>
<p><b>Supposed Causes</b></p>	<ul style="list-style-type: none"> <li>■ The installation space is not large enough.</li> <li>■ Faulty outdoor unit fan</li> <li>■ Faulty electronic expansion valve</li> <li>■ Faulty outdoor unit heat exchanger thermistor</li> <li>■ Faulty outdoor unit PCB</li> <li>■ Faulty stop valve</li> <li>■ Dirty heat exchanger</li> </ul>

Troubleshooting

  
**Check No.04**  
 Refer to P.257

  
**Check No.06**  
 Refer to P.259

  
**Check No.07**  
 Refer to P.260

  
**Check No.09**  
 Refer to P.261

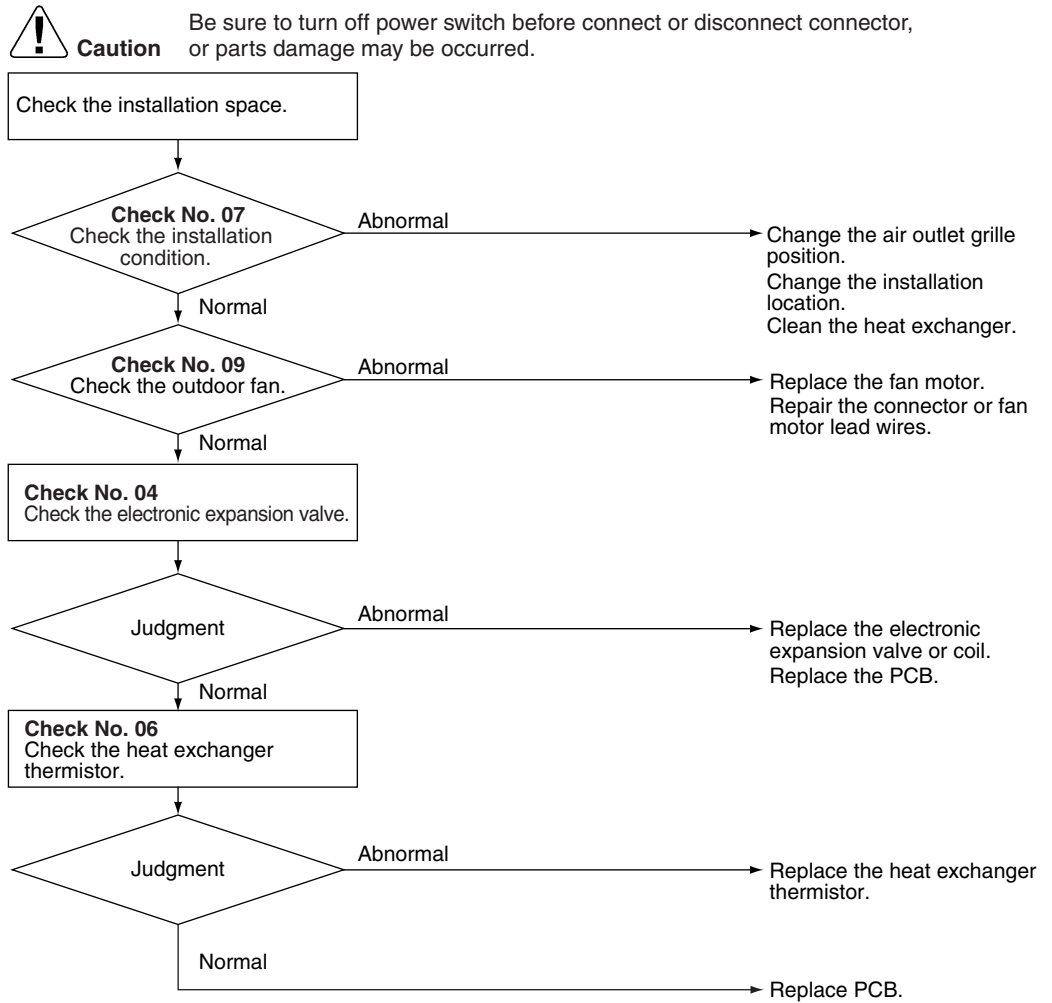

(R7142)







## 5.18 Compressor Sensor System Abnormality

Remote  
Controller  
Display

HO

Outdoor Unit LED  
Display

A  1  2  3  4

Method of  
Malfunction  
Detection

- Fault condition is identified by the supply voltage and the DC voltage which is detected before the compressor startup.
- Fault condition is identified by compressor current which is detected right after the compressor startup.

Malfunction  
Decision  
Conditions

- The detected value of the supply voltage and the DC voltage is obviously low or high.
- The compressor current doesn't run when the compressor is started.

Supposed  
Causes



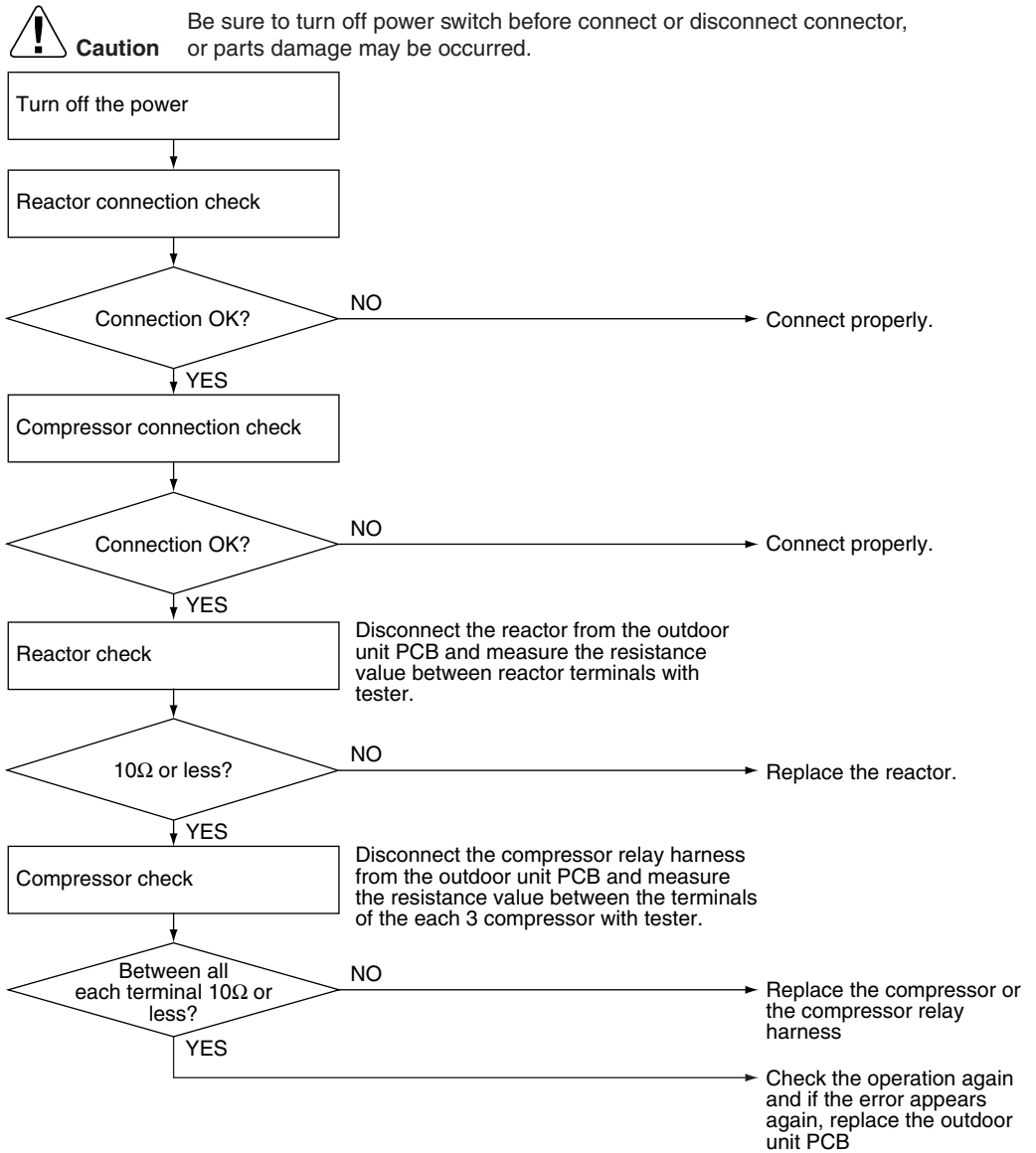

- Reactor disconnection
- Compressor disconnection
- Outdoor unit PCB defective
- Compressor defective

## Troubleshooting



(R7174)

## 5.19 Position Sensor Abnormality

<p>Remote Controller Display</p>	
<p>Outdoor Unit LED Display</p>	<p>A  1  2  3  4</p>
<p>Method of Malfunction Detection</p>	<p>A compressor startup failure is detected by checking the compressor running condition through the position detection circuit.</p>
<p>Malfunction Decision Conditions</p>	<ul style="list-style-type: none"> <li>■ The compressor fails to start in about 15 seconds after the compressor run command signal is sent.</li> <li>■ Clearing condition: Continuous run for about 5 minutes (normal)</li> <li>■ The system will be shut down if the error occurs 8 times.</li> </ul>
<p>Supposed Causes</p>	<ul style="list-style-type: none"> <li>■ Compressor relay cable disconnected</li> <li>■ Compressor itself defective</li> <li>■ Outdoor unit PCB defective</li> <li>■ Stop valve closed</li> <li>■ Input voltage out of specification</li> </ul>

### Troubleshooting

  
**Check No.13**  
 Refer to P.263

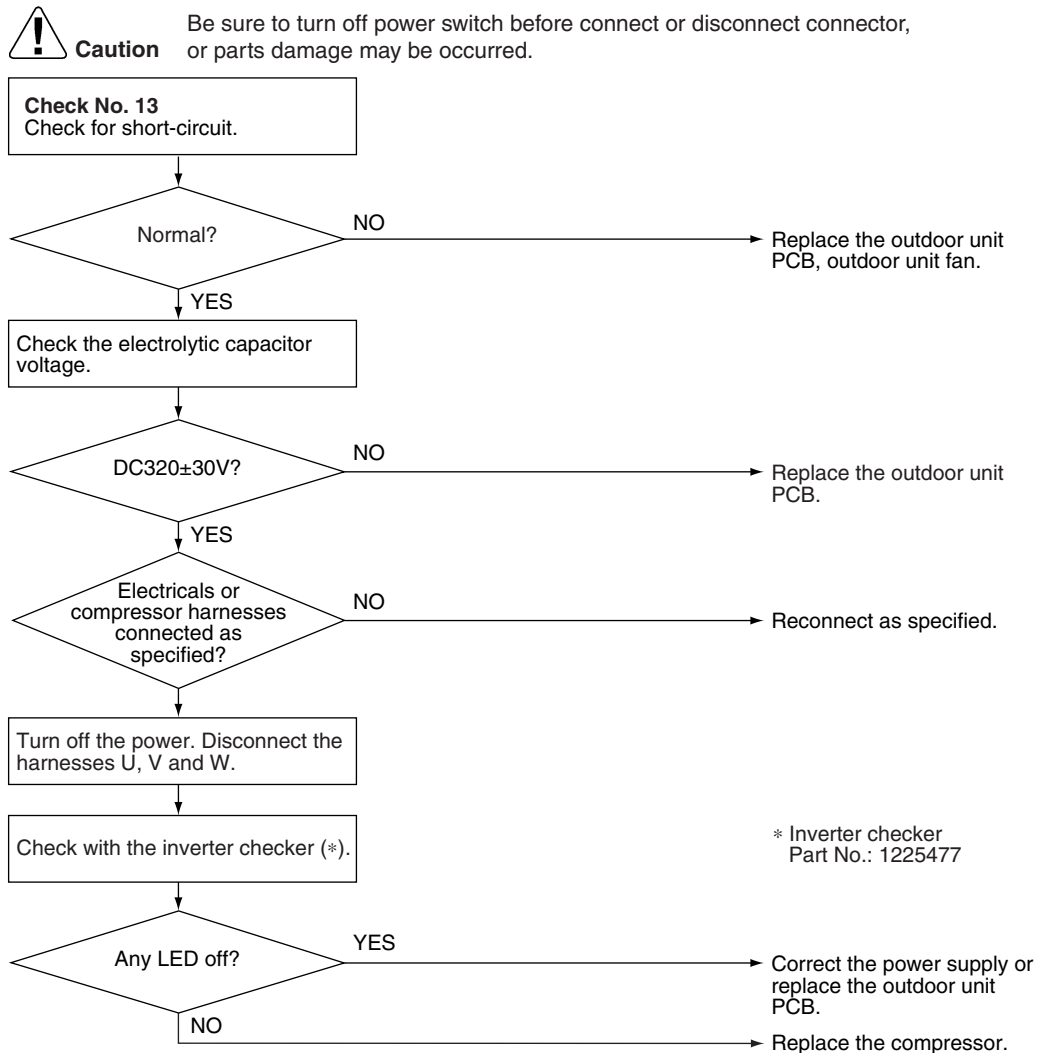

(R7175)

## 5.20 CT or Related Abnormality

Remote  
Controller  
Display



Outdoor Unit LED  
Display

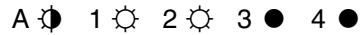

Method of  
Malfunction  
Detection

A CT or related error is detected by checking the compressor running frequency and CT-detected input current.

Malfunction  
Decision  
Conditions

- The compressor running frequency is below 55 Hz and the CT input is below 0.1 V. (The input current is also below 0.5 A.)
- If this error repeats 4 times, the system will be shut down.
- The error counter will reset itself if this or any other error does not occur during the following 60-minute compressor running time (total time).

Supposed  
Causes

- Power transistor defective
- Internal wiring broken or in poor contact
- Reactor defective
- Outdoor unit PCB defective

Troubleshooting



**Check No.12**  
Refer to P.263



**Caution**

Be sure to turn off power switch before connect or disconnect connector, or parts damage may be occurred.

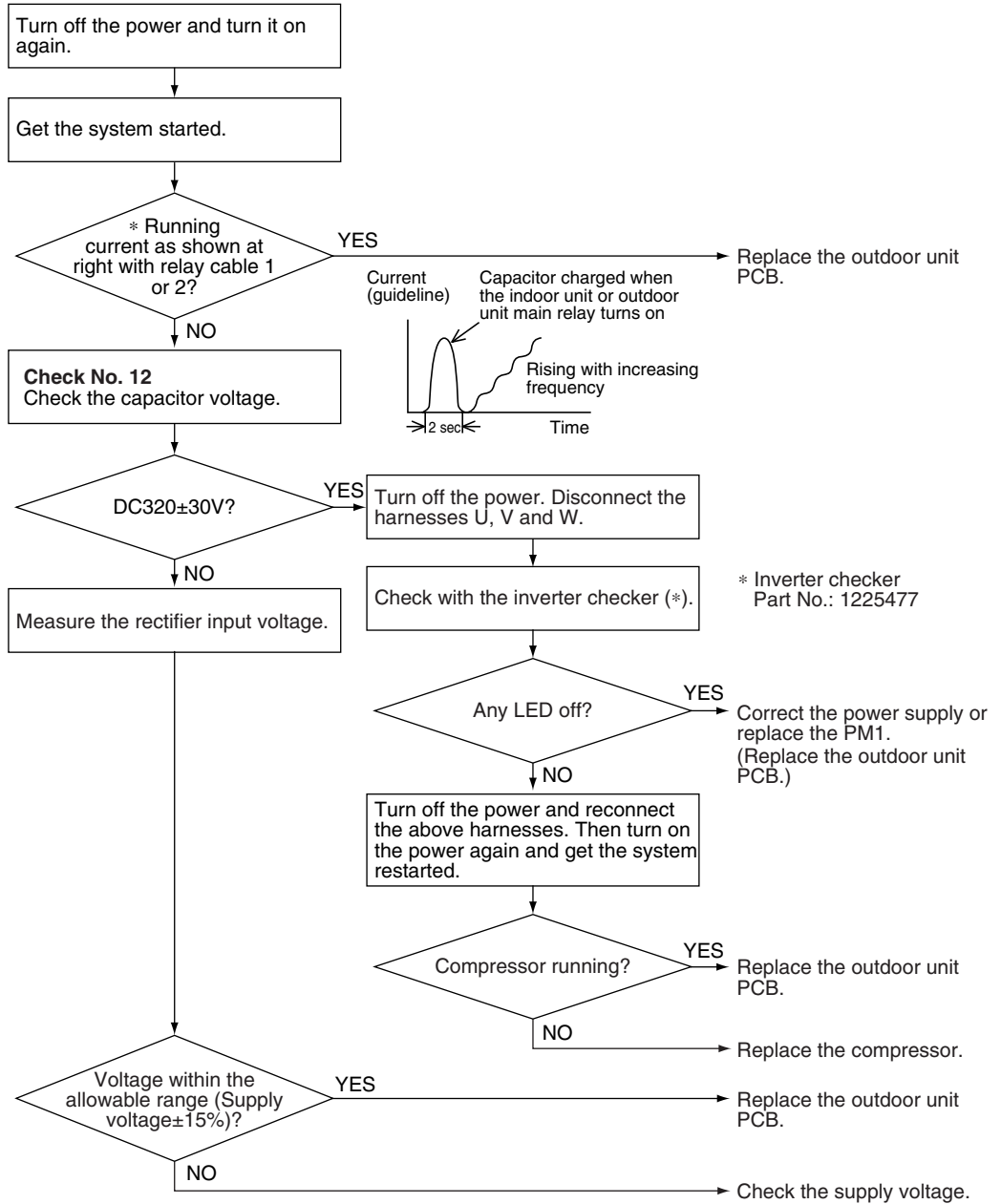





(R8415)

## 5.21 Thermistor or Related Abnormality (Outdoor Unit)

Remote  
Controller  
Display

P4, U3, U6, U8, U9, H9

Outdoor Unit LED  
Display

A  1  2  3  4 

Method of  
Malfunction  
Detection

This type of error is detected by checking the thermistor input voltage to the microcomputer.  
[A thermistor error is detected by checking the temperature being detected by each thermistor.]

Malfunction  
Decision  
Conditions

When the thermistor input is above 4.96 V or below 0.04 V with the power on, the U3 error is judged if the discharge pipe thermistor temperature is smaller than the condenser thermistor temperature, or the system will be shut down if all the units are judged with the U3 error.

Supposed  
Causes

- Connector in poor contact
- Thermistor defective
- Outdoor unit PCB defective
- Indoor unit PCB defective
- Condenser thermistor defective in the case of U3 error (outdoor unit heat exchanger thermistor in the cooling mode, or indoor unit heat exchanger thermistor in the heating mode)

Troubleshooting



**Check No.06**  
Refer to P.259



**Caution**

Be sure to turn off power switch before connect or disconnect connector, or parts damage may be occurred.

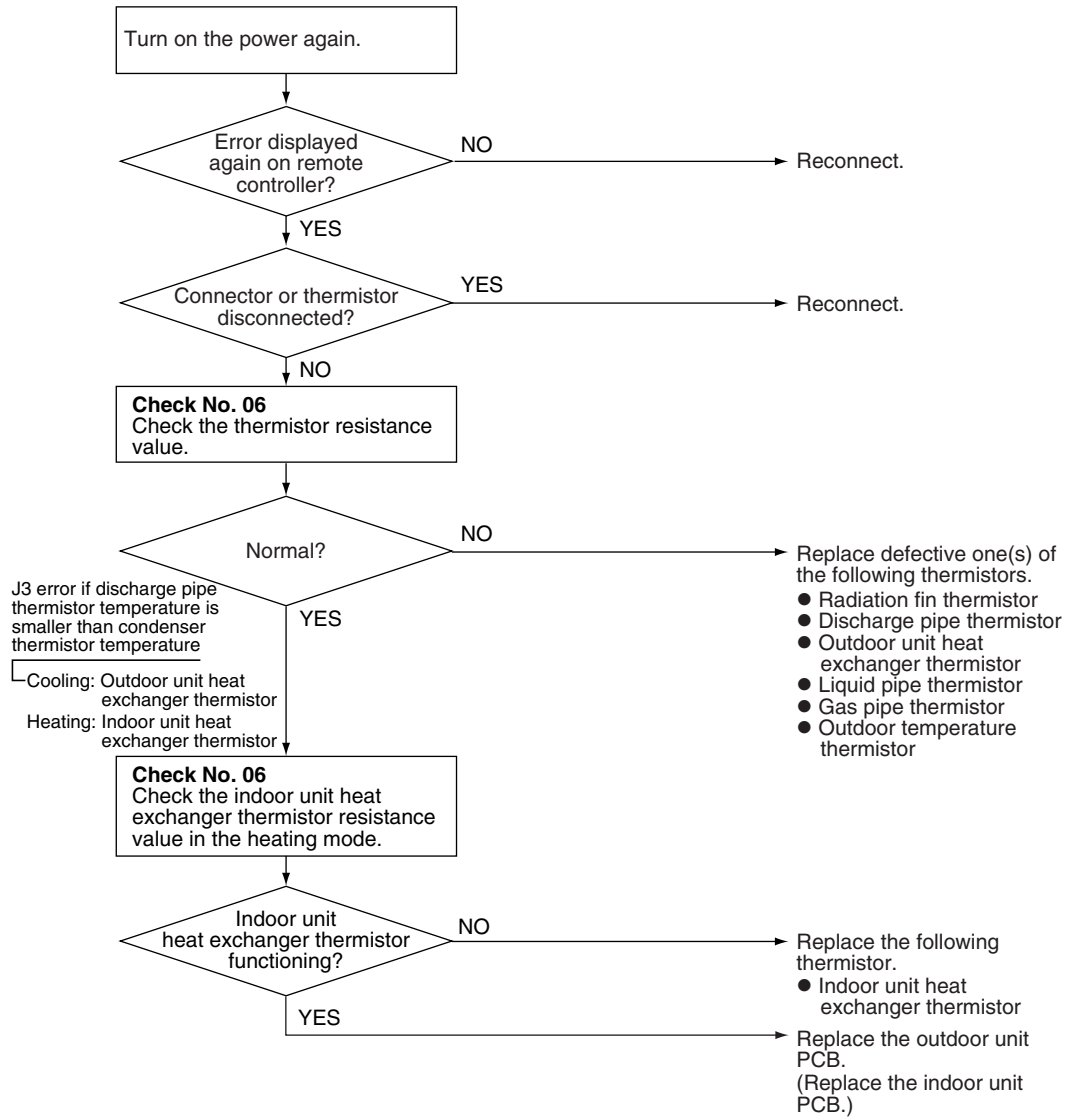

(R7176)

- P4 : Radiation fin thermistor
- J3 : Discharge pipe thermistor
- J5 : Outdoor unit heat exchanger thermistor
- J8 : Liquid pipe thermistor
- J9 : Gas pipe thermistor
- J9 : Outdoor temperature thermistor

## 5.22 Electrical Box Temperature Rise

Remote  
Controller  
Display



Outdoor Unit LED  
Display



Method of  
Malfunction  
Detection

An electrical box temperature rise is detected by checking the radiation fin thermistor with the compressor off.

Malfunction  
Decision  
Conditions

- With the compressor off, the radiation fin temperature is above 100°C.
- The error is cleared when the temperature drops below 70°C.

Supposed  
Causes

- Fin temperature rise due to defective outdoor unit fan
- Fin temperature rise due to short-circuit
- Fin thermistor defective
- Connector in poor contact
- Outdoor unit PCB defective



Troubleshooting

  
**Check No.07**  
 Refer to P.260

  
**Check No.09**  
 Refer to P.261

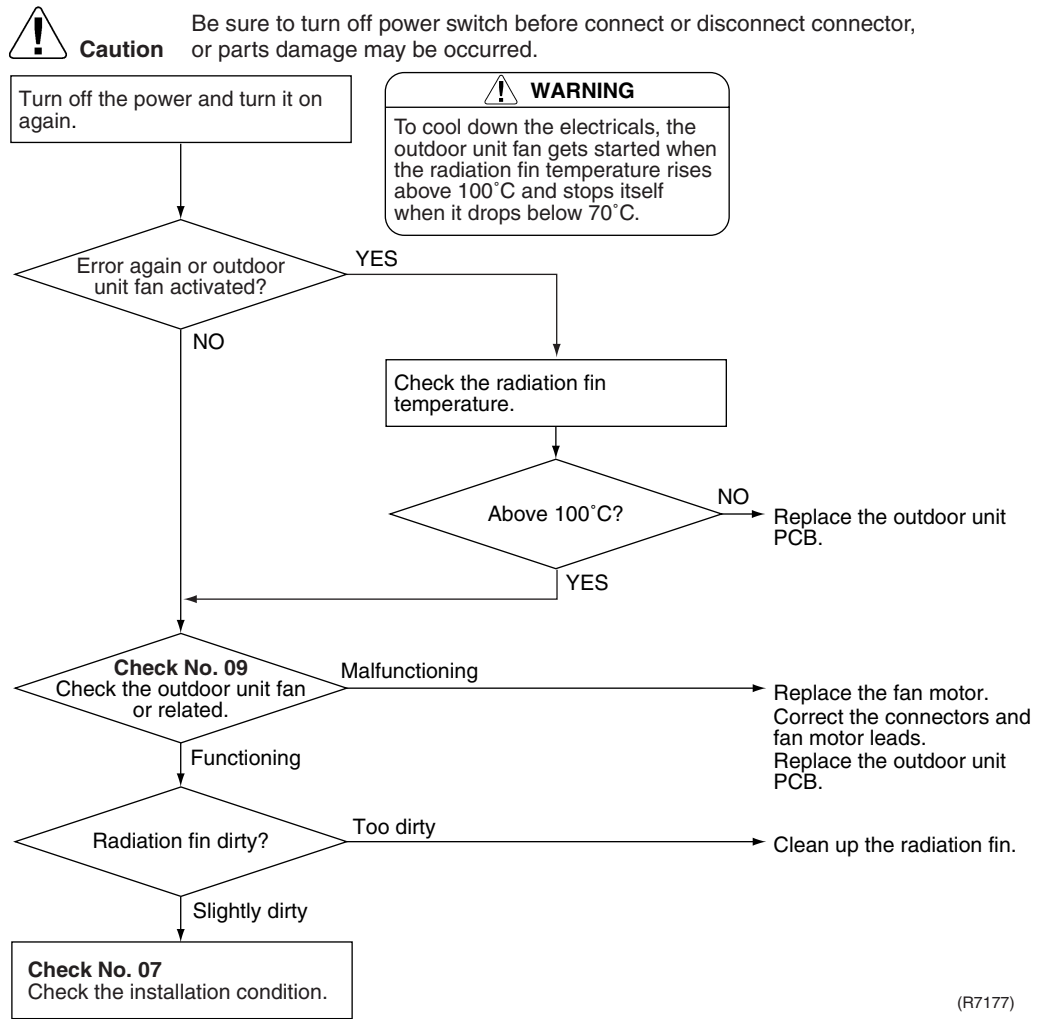



## 5.23 Radiation Fin Temperature Rise

Remote  
Controller  
Display

L4

Outdoor Unit LED  
Display

A  1 ● 2 ● 3 ● 4 

Method of  
Malfunction  
Detection

A radiation fin temperature rise is detected by checking the radiation fin temperature being detected by the fin thermistor with the compressor on.

Malfunction  
Decision  
Conditions

- The radiation fin temperature with the compressor on is above 103°C.
- The error is cleared when the temperature drops below 95°C.
- If a radiation fin temperature rise takes place 255 times successively, the system will be shut down.
- The error counter will reset itself if this or any other error does not occur during the following 60-minute compressor running time (total time).

Supposed  
Causes

- Fin temperature rise due to defective outdoor unit fan
- Fin temperature rise due to short-circuit
- Fin thermistor defective
- Connector in poor contact
- Outdoor unit PCB defective
- Silicon grease is not applied properly on the heat radiation fin after replacing outdoor unit PCB.

Troubleshooting



**Check No.07**  
Refer to P.260



**Check No.09**  
Refer to P.261



**Caution**

Be sure to turn off power switch before connect or disconnect connector, or parts damage may be occurred.

Turn off the power and turn it on again to get the system started.

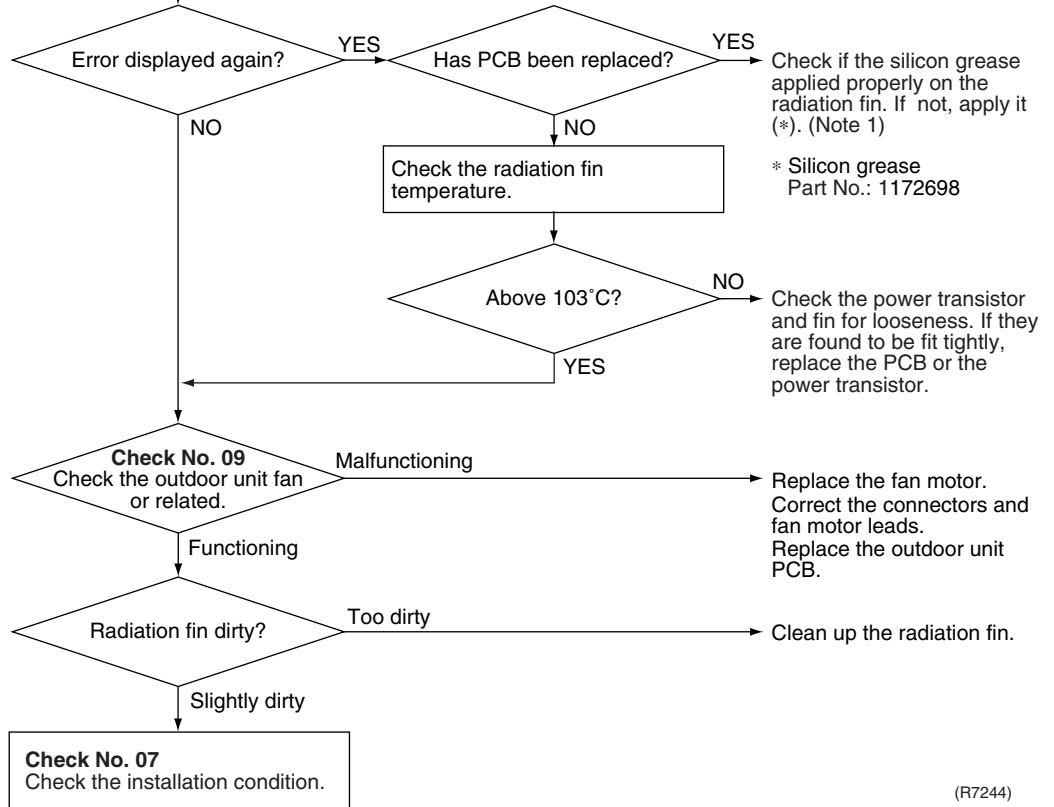

(R7244)







**Note1:** Refer to “1.3 Application of Silicon grease to a power transistor and a diode bridge” on P302.

## 5.24 Output Over Current Detection

Remote  
Controller  
Display

LS

Outdoor Unit LED  
Display

A  1  2  3  4 

Method of  
Malfunction  
Detection

An output over-current is detected by checking the current that flows in the inverter DC section.

Malfunction  
Decision  
Conditions

- A position signal error occurs while the compressor is running.
- A speed error occurs while the compressor is running.
- An output over-current input is fed from the output over-current detection circuit to the microcomputer.
- The system will be shut down if the error occurs 16 times.
- Clearing condition: Continuous run for about 5 minutes (normal)

Supposed  
Causes

- Over-current due to defective power transistor
- Over-current due to wrong internal wiring
- Over-current due to abnormal supply voltage
- Over-current due to defective PCB
- Error detection due to defective PCB
- Over-current due to closed stop valve
- Over-current due to compressor failure
- Over-current due to poor installation condition

Troubleshooting



**Check No.07**  
Refer to P.260



**Check No.08**  
Refer to P.261



**Check No.13**  
Refer to P.263



**Caution** Be sure to turn off power switch before connect or disconnect connector, or parts damage may be occurred.

\* An input over-current may result from wrong internal wiring. If the wires have been disconnected and reconnected for part replacement, for example, and the system is interrupted by an input over-current, check the wires again.

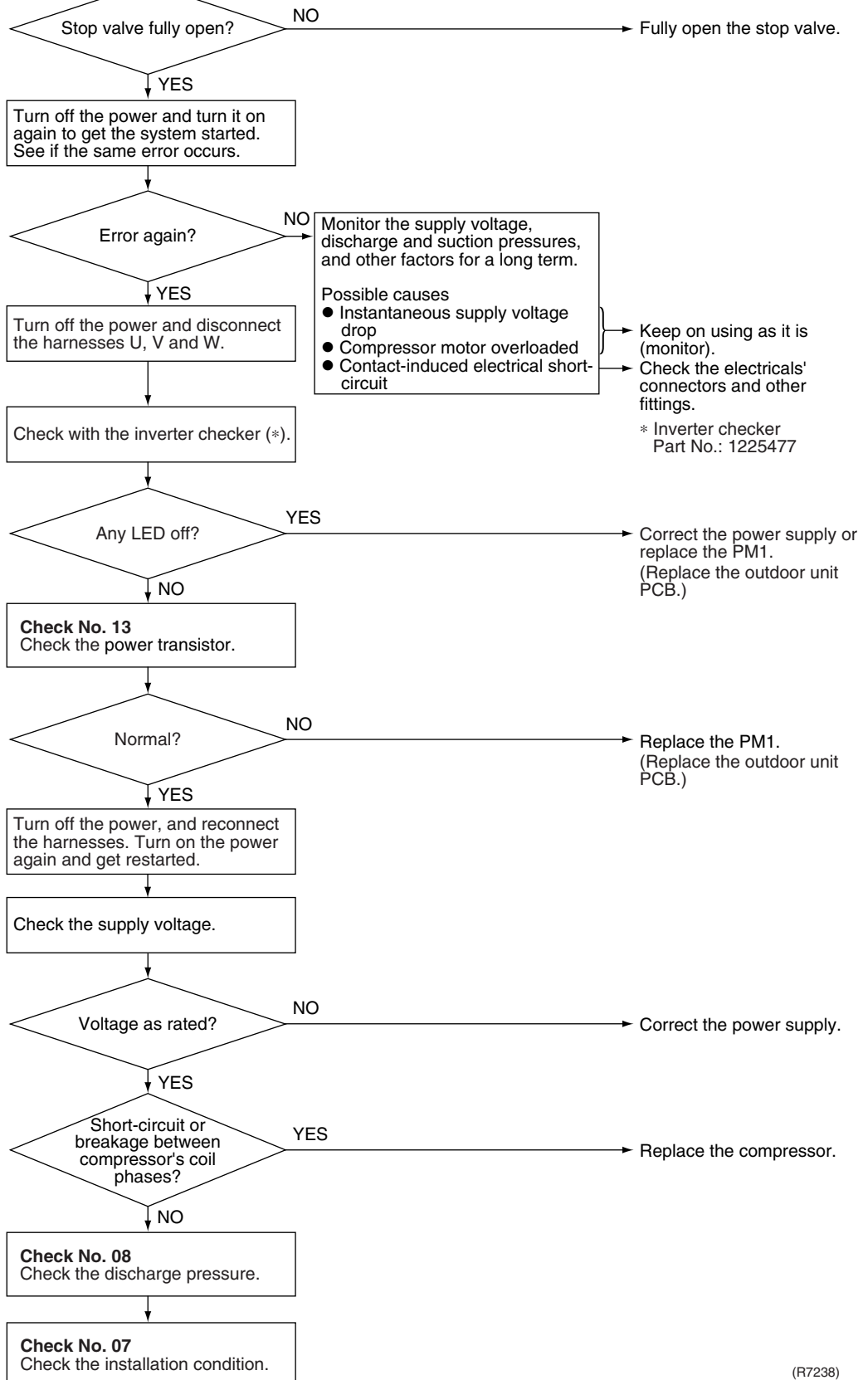

(R7238)

## 5.25 Insufficient Gas

Remote  
Controller  
Display



Outdoor Unit LED  
Display

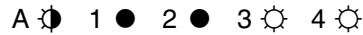

Method of  
Malfunction  
Detection

### Gas shortage detection I:

Gas shortage is detected by checking the input current value and the compressor running frequency. If the gas is short, the input current is smaller than the normal value.

### Gas shortage detection II:

Gas shortage is detected by checking the discharge temperature and the opening of the electronic expansion valve. If the gas is short, the discharge temperature tends to rise.

Malfunction  
Decision  
Conditions

### Gas shortage detection I (typical value):

The following conditions continue for 7 minutes.

- ◆ DC current  $\leq 0.035 \times \text{output frequency} + 0.5$
- ◆ Output frequency  $> 55$  (Hz)

### Gas shortage detection II:

The following conditions continue for 80 seconds.

- ◆ Target opening of the electronic expansion valve  $\geq 450$  (pulse)
- ◆ Cooling: discharge temperature  $> 255 / 256 \times \text{target discharge temperature} + 20$  (°C)  
Heating: discharge temperature  $> 255 / 256 \times \text{target discharge temperature} + 40$  (°C)

If a gas shortage error takes place 4 times straight, the system will be shut down. The error counter will reset itself if this or any other error does not occur during the following 60-minute compressor running time (total time).

Supposed  
Causes

- Refrigerant shortage (refrigerant leakage)
- Poor compression performance of compressor
- Discharge pipe thermistor disconnected, or indoor unit or outdoor unit heat exchanger thermistor disconnected, room or outside air temperature thermistor disconnected
- Stop valve closed
- Electronic expansion valve defective

Troubleshooting



**Check No.04**  
Refer to P.257



**Check No.06**  
Refer to P.259



**Caution**

Be sure to turn off power switch before connect or disconnect connector, or parts damage may be occurred.

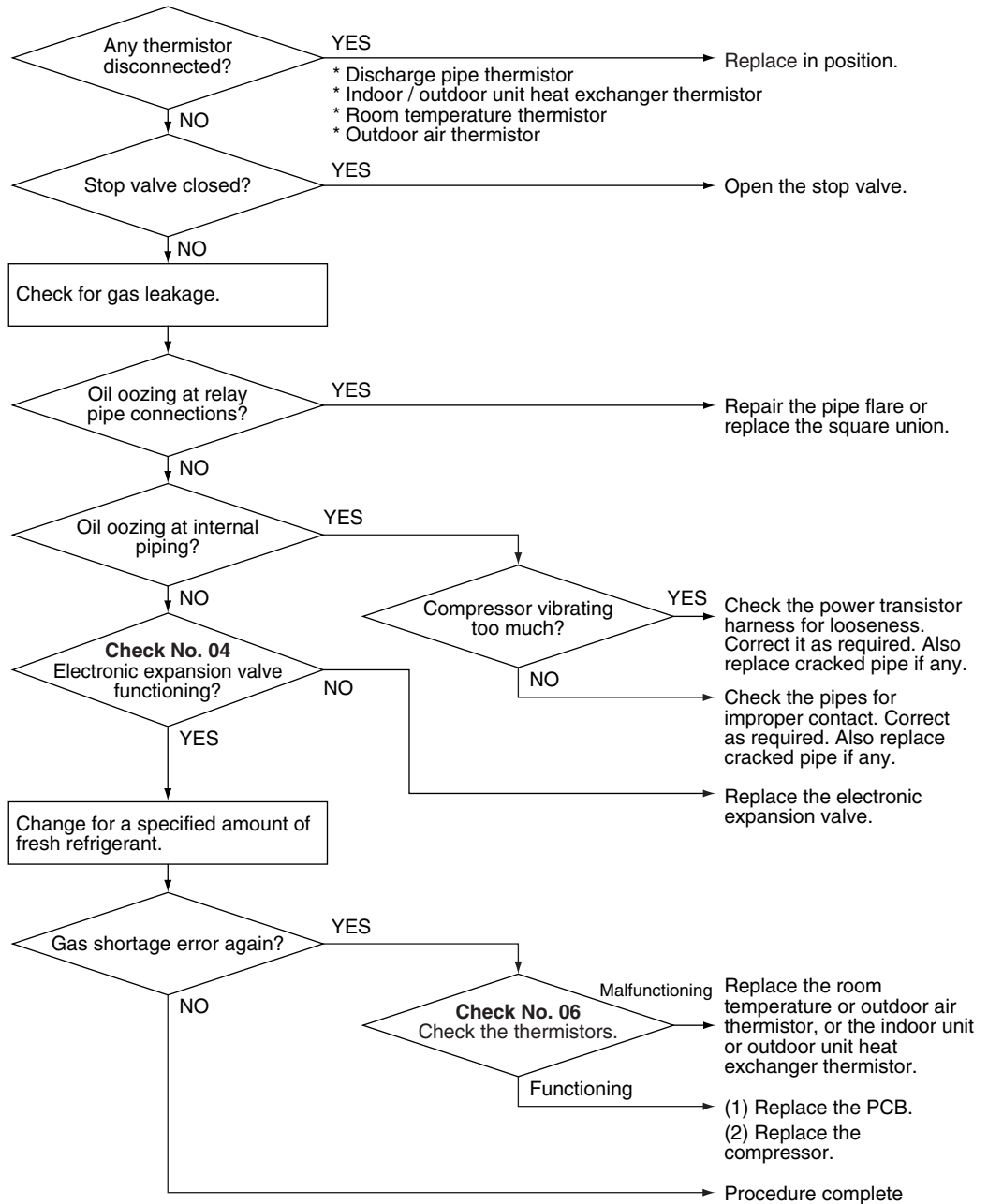





(R7149)

## 5.26 Low-voltage Detection or Over-voltage Detection

Remote  
Controller  
Display

U2

Outdoor Unit LED  
Display

A  1  2  3  4 

Method of  
Malfunction  
Detection

An abnormal voltage rise or drop is detected by checking the detection circuit or DC voltage detection circuit.

Malfunction  
Decision  
Conditions

- An over-voltage signal is fed from the over-voltage detection circuit to the microcomputer, or the voltage being detected by the DC voltage detection circuit is judged to be below 150 V for 0.1 second.
- The system will be shut down if the error occurs 16 times.
- Clearing condition: Continuous run for about 60 minutes (normal)

Supposed  
Causes

- Supply voltage not as specified
- Over-voltage detector or DC voltage detection circuit defective
- PAM control part(s) defective
- Short circuit inside the fan motor winding.

Troubleshooting

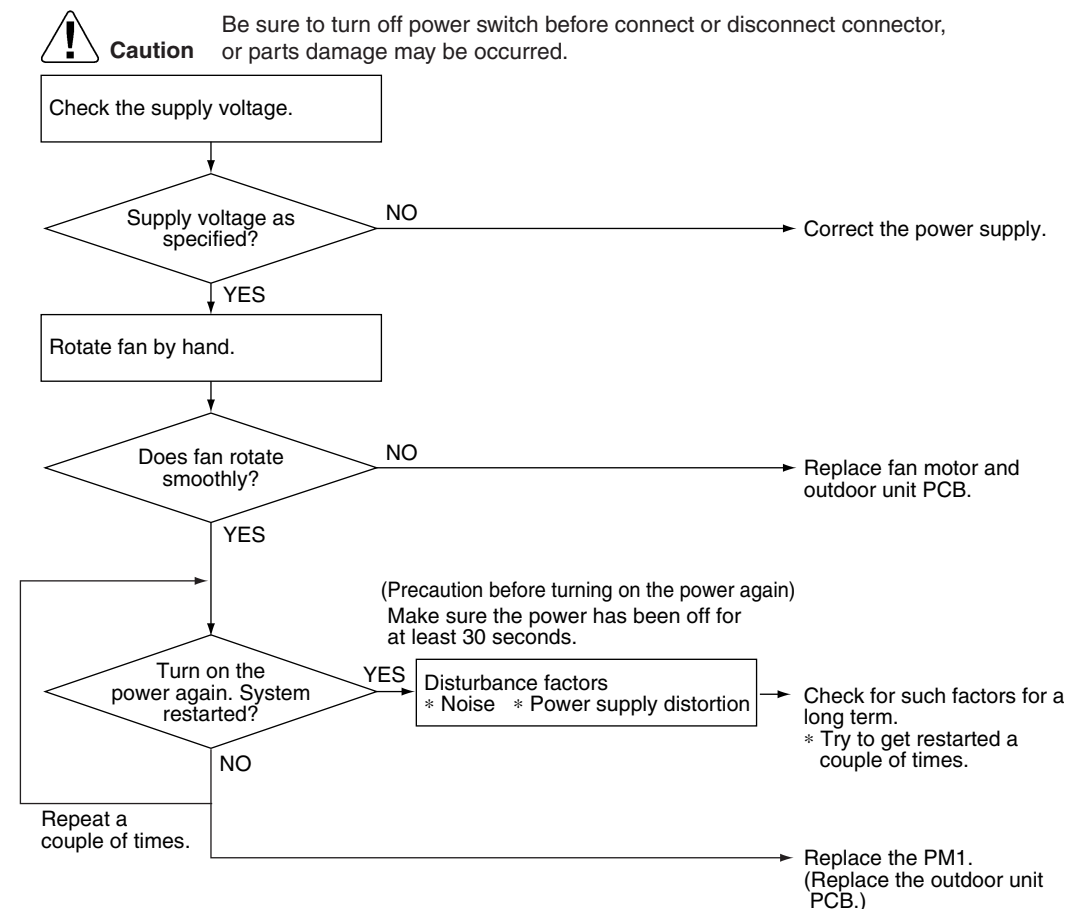

(R7179)



## 5.27 Signal Transmission Error (on Outdoor Unit PCB)

Remote Controller Display



Outdoor Unit LED Display



Method of Malfunction Detection

Communication error between microcomputer mounted on the main PCB and PM1.

Malfunction Decision Conditions

- When the data sent from the PM1 can not be received successively for 9 sec.
- The abnormality is determined if the above fault conditions occurs once
- Fault counter is reset when the data from the PM1 can be successfully received.

Supposed Causes

- Defective outdoor unit PCB

Troubleshooting



**Caution**

Be sure to turn off power switch before connect or disconnect connector, or parts damage may be occurred.

Turn off the power and turn it on again.

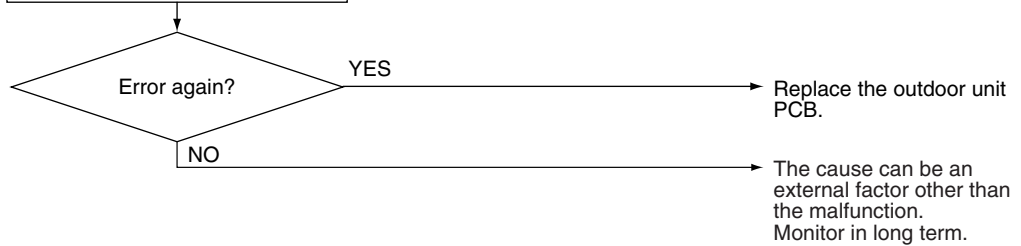

(R7185)

## 5.28 Anti-icing Function in Other Rooms / Unspecified Voltage (between Indoor and Outdoor Units)

Remote Controller Display

UR, UH

Outdoor Unit LED Display

A  1 ● 2 ● 3 ● 4 ●

Method of Malfunction Detection

A wrong connection is detected by checking the combination of indoor and outdoor units on the microcomputer.

Malfunction Decision Conditions

- Operation halt due to the anti-icing function in other rooms
- Operation halt due to unspecified internal and/or external voltages
- Operation halt due to mismatching of indoor and outdoor units

Supposed Causes

- Operation halt due to the anti-icing function in other rooms
- Wrong connections at the indoor unit
- PCB wrongly connected

### Troubleshooting

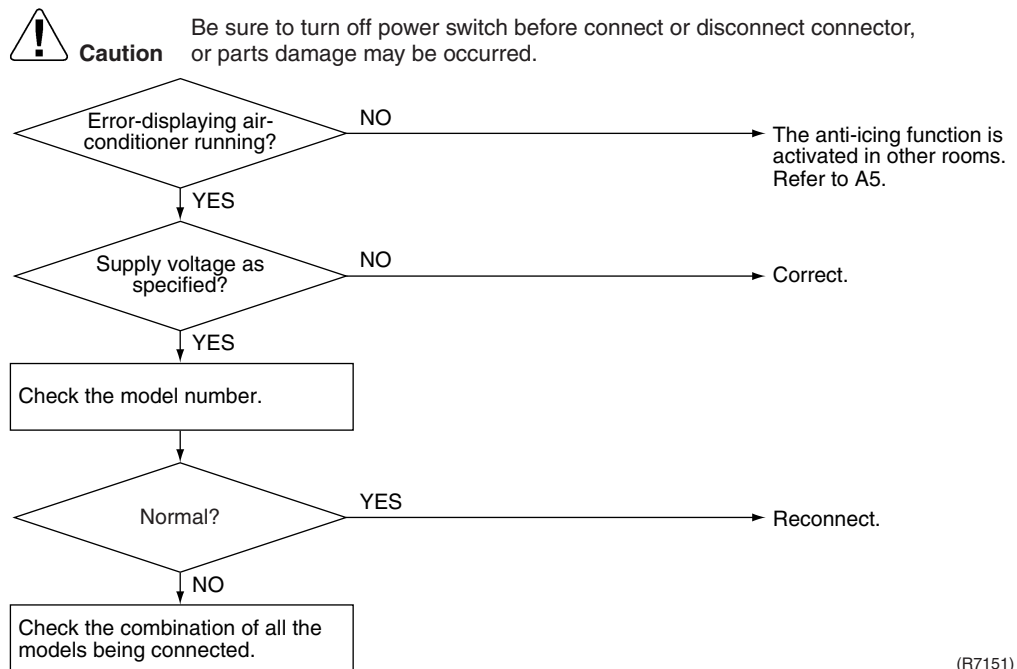

## 6. Check

### 6.1 How to Check

#### 6.1.1 Fan Motor Connector Output Check

##### Check No.01

1. Check connector connection.
2. Check motor power supply voltage output (pins 4-7 and 4-8).
3. Check motor control voltage (pins 4-3).
4. Check rotation command voltage output (pins 4-2).
5. Check rotation pulse input (pins 4-1).

S1 or S301

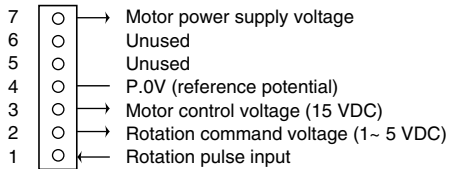

S302

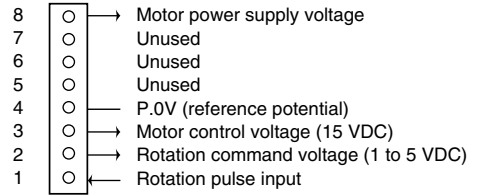

(R4684)

##### Check No.02

1. Check connector connection.
2. Check motor control voltage output (pins 2-1).

S202

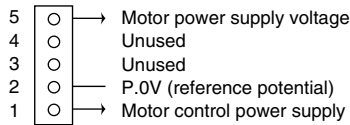

(R1073)

#### 6.1.2 Limit Switch Continuity Check

##### Check No.03

Remove the front grille. The limit switch is located at the left side of the drain pan assembly. Check the continuity of the switch connection.

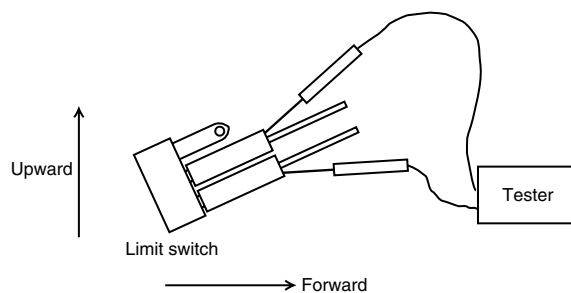

Shutter status	Open	Closed
Continuity	Continuity	No continuity

(Q0363)

- \* The shutter can be opened and closed with hand. Keep the shutter open and closed all the way for each continuity check steps.

### 6.1.3 Electronic Expansion Valve Check

**Check No.04**

Conduct the followings to check the electronic expansion valve (EV).

1. Check to see if the EV connector is correctly inserted in the PCB. Compare the EV unit and the connector number.
2. Turn the power off and back on again, and check to see if all the EVs generate latching sound.
3. If any of the EVs does not generate latching noise in the above step 2, disconnect that connector and check the conductivity using a tester.  
Check the conductivity between pins 1, 3 and 6, and between pins 2, 4 and 5. If there is no conductivity between the pins, the EV coil is faulty.
4. If no EV generates latching sound in the above step 2, the outdoor unit PCB is faulty.
5. If the conductivity is confirmed in the above step 2, mount a good coil (which generated latching sound) in the EV unit that did not generate latching sound, and check to see if that EV generates latching sound.  
\*If latching sound is generated, the outdoor unit PCB is faulty.  
\*If latching sound is not generated, the EV unit is faulty.



**Note:** Please note that the latching sound varies depending on the valve type.

Valve Body Condition (Symptom)	Check Method / Measure
<p>(1) Valve body catches at fully opened or half opened position. (Symptom)</p> <p>Cooling:                      ■Water leakage at the no-operation unit                      ■Flow noise of refrigerant in the no-operation unit                      ■Operation halt due to icing protection</p> <p>Heating:                      ■The unit does not heat                      ■Refrigerant flow rate vary by unit                      (Discharge air temperatures are different by room)                      ■Peak cut</p>	<p>Reset power supply and conduct cooling operation unit by unit.</p> <div style="border: 1px solid black; padding: 5px; margin-bottom: 5px;">Check the liquid pipe temperature of no-operation unit.</div> <div style="text-align: center;"> <pre>                     graph TD                     A[Check the liquid pipe temperature of no-operation unit.] --&gt; B{Is it almost same as the outside air temperature?}                     B -- YES --&gt; C[Replace the EVn of the room. (R7154)]                     B -- NO --&gt; D[ ]                     style D width:0px,height:0px                     </pre> </div>
<p>(2) Valve body catches at complete close position. (Symptom)</p> <p>Cooling:                      ■The only unit having problem does not cool the room .                      ■When the only faulty unit is in operation, the unit makes pump down.                      (The low pressure of the unit becomes vacuum)                      ■IT is activated.                      ■Abnormal discharge pipe temperature</p> <p>Heating:                      Insufficient gas due to liquid refrigerant stagnation inside the faulty indoor unit</p> <p>(Only for heat pump model)                      ■The unit does not heat the room.                      ■IT is activated.                      ■Abnormal discharge pipe temperature</p>	<p>Reset power supply and conduct cooling operation unit by unit.</p> <div style="border: 1px solid black; padding: 5px; margin-bottom: 5px;">Check the low pressure</div> <div style="text-align: center;"> <pre>                     graph TD                     A[Check the low pressure] --&gt; B{Does the pressure become into vacuum zone?}                     B -- YES --&gt; C[Replace the EVn of the room (R7155)]                     B -- NO --&gt; D[ ]                     style D width:0px,height:0px                     </pre> </div>
<p>(3) Valve does not open fully. (Symptom)</p> <p>■The unit does not cool nor heat (only for heat pump model.)                      ■IT is actuated.                      ■Abnormal discharge pipe temperature</p>	<p>Check the number of rotation of shaft if it is 5 and half from full open to complete close using manual coil for electronic expansion valve. When the number of rotation of shaft is less than the above value, the valve may catch anywhere of the body.</p>

## 6.1.4 Four Way Valve Performance Check

### Check No.05

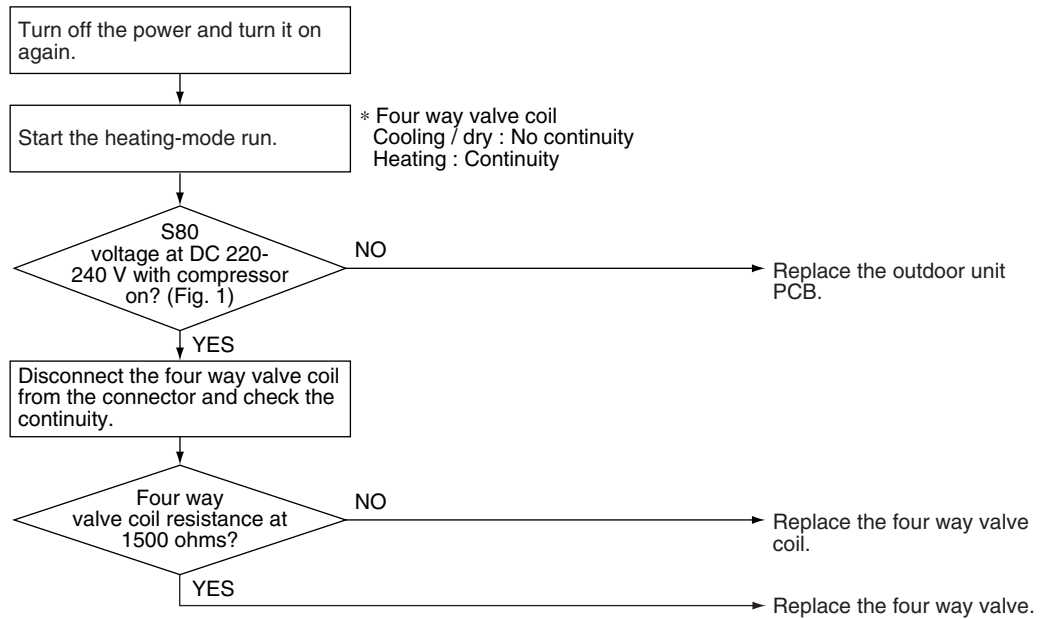

(Fig. 1)

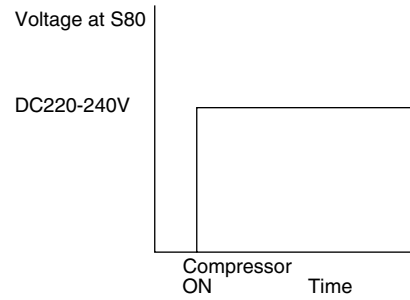

(R7156)

## 6.1.5 Thermistor Resistance Check

### Check No.06

Remove the connectors of the thermistors on the PCB, and measure the resistance of each thermistor using tester.

The relationship between normal temperature and resistance is shown in the graph and the table below.

Temperature (°C)	Thermistor R25°C=20kΩ B=3950
-20	211.0 (kΩ)
-15	150
-10	116.5
-5	88
0	67.2
5	51.9
10	40
15	31.8
20	25
25	20
30	16
35	13
40	10.6
45	8.7
50	7.2

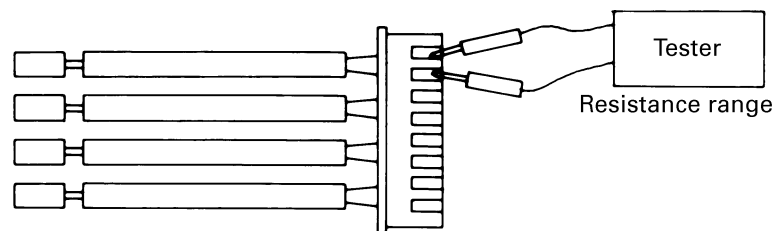

( R25 = 20k Ω 、 B = 3950 )

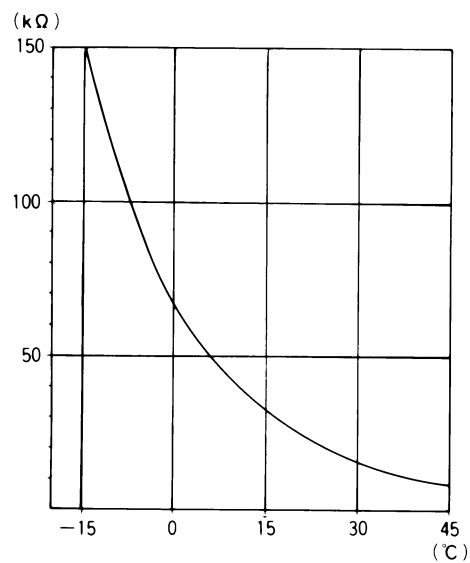

(R1437)

## 6.1.6 Installation Condition Check

### Check No.07

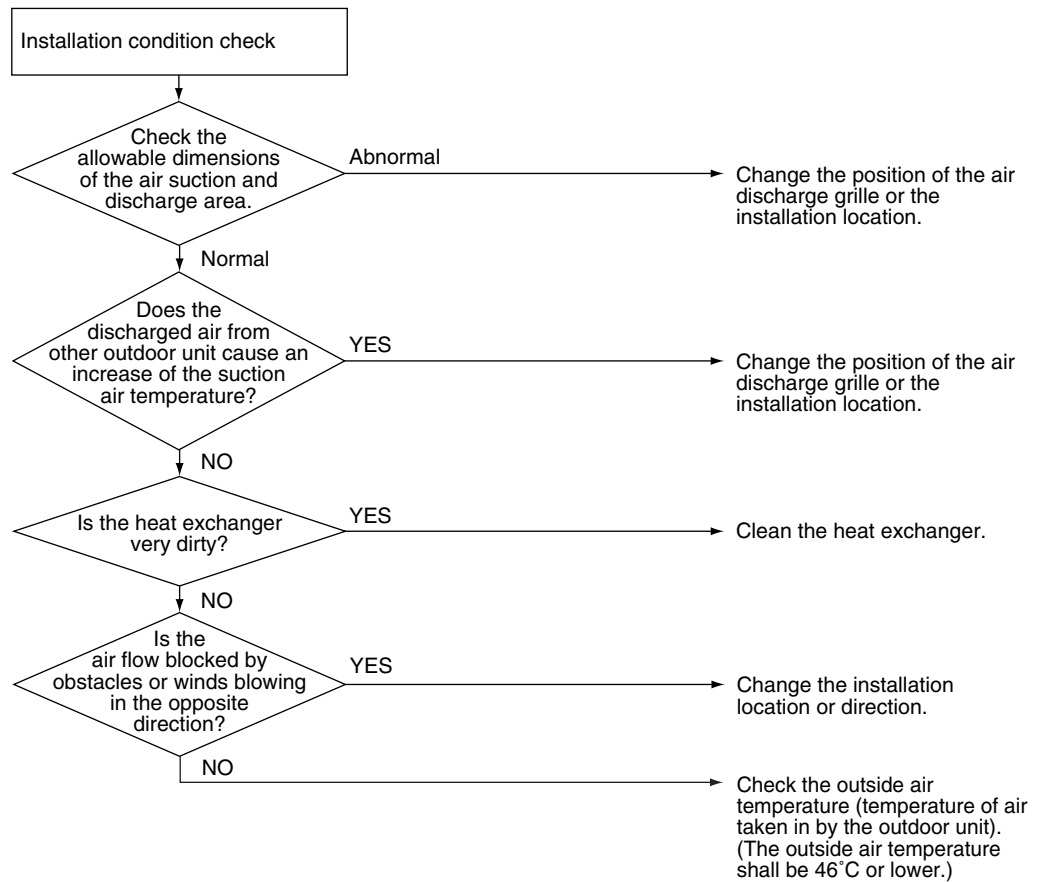

(R7157)

## 6.1.7 Discharge Pressure Check

### Check No.08

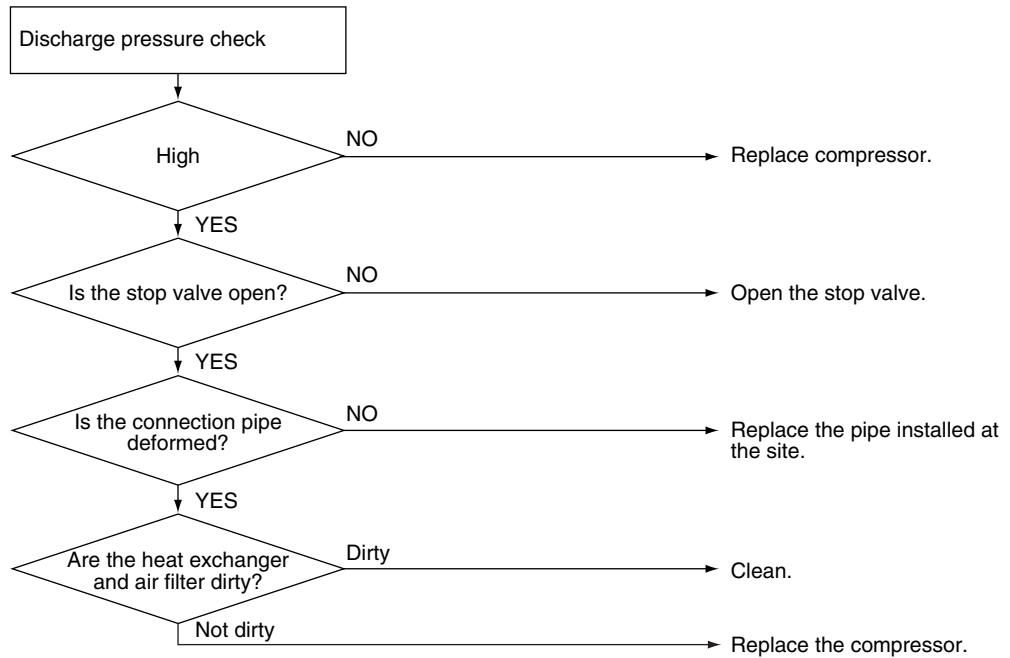

(R7158)

## 6.1.8 Outdoor Unit Fan System Check (With DC Motor)

### Check No.09

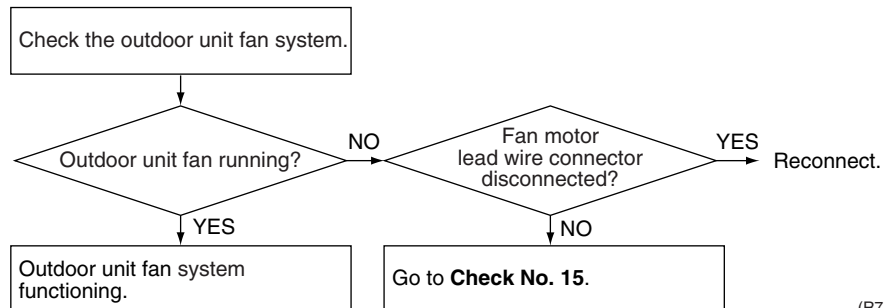

(R7159)



## 6.1.9 Power Supply Waveforms Check

### Check No.10

Measure the power supply waveform between pins 1 and 3 on the terminal board, and check the waveform disturbance.

- Check to see if the power supply waveform is a sine wave (Fig.1).
- Check to see if there is waveform disturbance near the zero cross (sections circled in Fig.2)

[Fig.1]

[Fig.2]

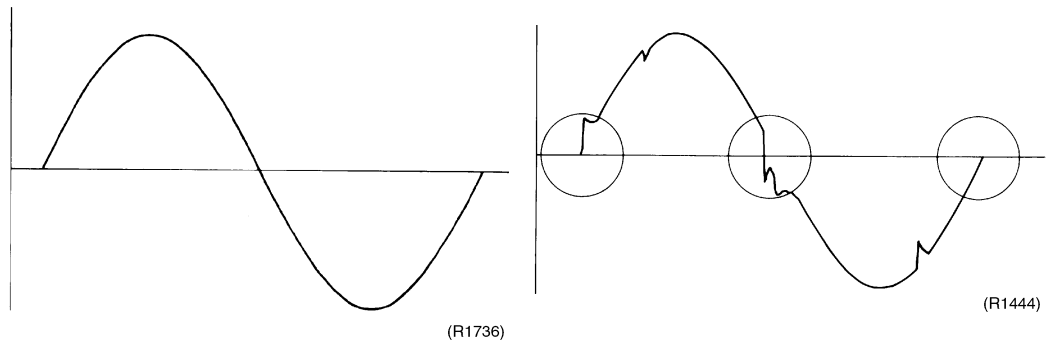

## 6.1.10 Inverter Units Refrigerant System Check

### Check No.11

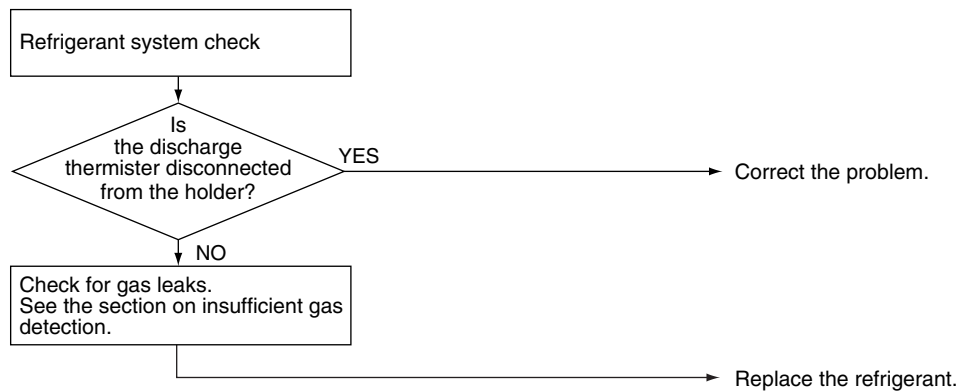

(R8259)

## 6.1.11 Capacitor Voltage Check

### Check No.12

Before this checking, be sure to check the main circuit for short-circuit.

- Checking the capacitor voltage
- With the circuit breaker still on, measure the voltage according to the drawing of the model in question. Be careful never to touch any live parts.

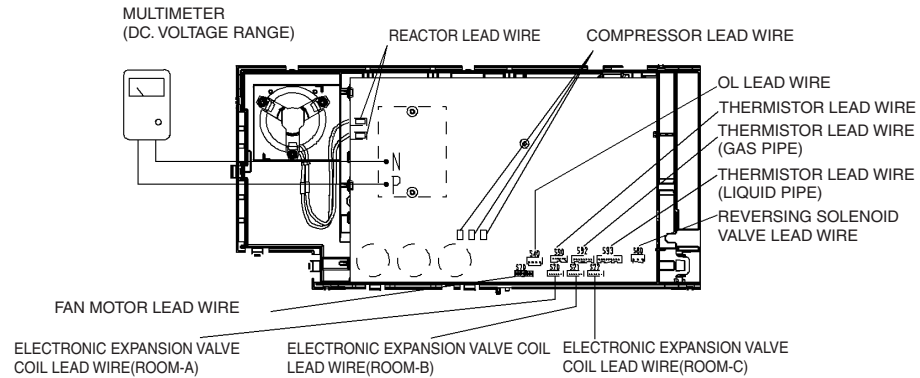

(R5154)

## 6.1.12 Power Transistor Check

### Check No.13

- Checking the power transistor
- Never touch any live parts for at least 10 minutes after turning off the circuit breaker.
- If unavoidably necessary to touch a live part, make sure the power transistor's supply voltage is below 50 V using the tester.
- For the UVW, make measurements at the Faston terminal on the board or the relay connector.

Tester's negative terminal	Power transistor (+)	UVW	Power transistor (-)	UVW
Tester's positive terminal	UVW	Power transistor (+)	UVW	Power transistor (-)
Normal resistance	Several kohms to several Mohms			
Abnormal resistance	0 or ∞			

## 6.1.13 Main Circuit Electrolytic Capacitor Check

### Check No.14

- Checking the main circuit electrolytic capacitor
- Never touch any live parts for at least 10 minutes after turning off the circuit breaker.
- If unavoidably necessary to touch a live part, make sure there is no DC voltage using the tester.
- Check the continuity with the tester. Reverse the pins and make sure there is continuity.

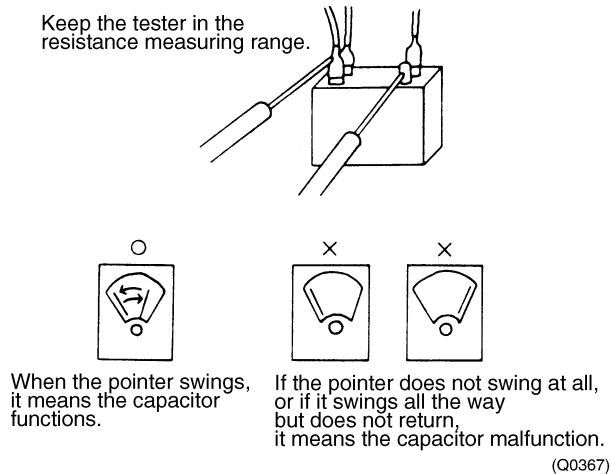

## 6.1.14 Turning Speed Pulse Input on the Outdoor Unit PCB Check

### Check No.15

<Propeller fan motor>

Make sure the voltage of  $320\pm 30V$  is being applied.

- (1) Stop the operation first and then the power, and disconnect the connector S70.
- (2) Make sure there is about DC 320 V between pins 4 and 7.
- (3) With the system and the power still off, reconnect the connector S70.
- (4) Make a turn of the fan motor with a hand, and make sure the pulse (0-15 V) appears twice at pins 1 and 4.

If the fan motor protection fuse is blown out, the outdoor-unit fan may also be in trouble. Check the fan too.

If the voltage in Step (2) is not applied, it means the PCB is defective. Replace the PCB.

If the pulse in Step (4) is not available, it means the Hall IC is defective. Replace the DC fan motor. If there are both the voltage (2) and the pulse (4), replace the PCB.

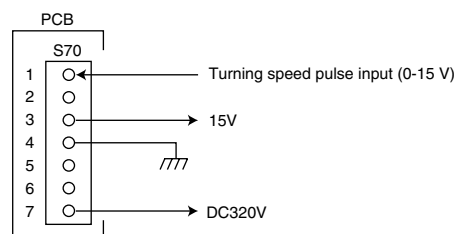

(R5223)

\* Propeller fan motor : S70

## 6.1.15 Hall IC Check

### Check No.16

1. Check the connector connection.
2. With the power ON, operation OFF, and the connector connected, check the following.
  - \*Output voltage of about 5 V between pins 1 and 3.
  - \*Generation of 3 pulses between pins 2 and 3 when the fan motor is operating.

Failure of (1) → faulty PCB → Replace the PCB.

Failure of (2) → faulty Hall IC → Replace the fan motor.

Both (1) and (2) result → Replace the PCB.

The connector has 3 pins, and there are two patterns of lead wire colors.

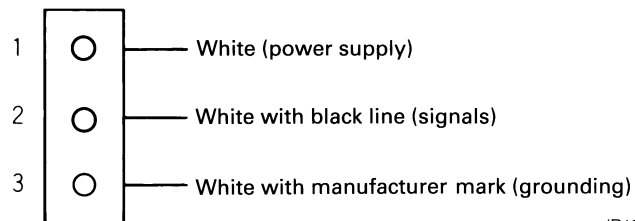
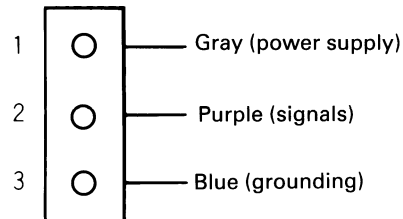

(R1990)



# Part 7

## Removal Procedure

1. Outdoor Unit.....	268
1.1 Removal of the Panels and Plates .....	268
1.2 Removal of the Electrical Box .....	272
1.3 Removal of the PCB.....	280
1.4 Removal of the Propeller Fan / Fan Motor .....	286
1.5 Removal of the Sound Blanket.....	288
1.6 Removal of Electronic Expansion Valve Coil, Four Way Valve Coil and Thermistor .....	292
1.7 Removal of the Distributor .....	295
1.8 Removal of the Four Way Valve.....	296
1.9 Removal of the Compressor.....	297

# 1. Outdoor Unit

## 1.1 Removal of the Panels and Plates

**Procedure**



**Warning**

Be sure to wait 10 minutes or more after turning off all power supplies before disassembling work.

Step	Procedure	Procedure	Points
1	External appearance.	<p>Top panel</p> <p>handle</p> <p>Discharge grille</p> <p>Stop valve cover</p> <p>Front panel (R5494)</p> <p>Outdoor air thermistor</p> <p>(R5495)</p>	<ul style="list-style-type: none"> <li>Take care not to cut your finger by the fins of the heat exchanger.</li> </ul>
2	Loosen the 4 screws (2 on both sides) of the top panel.	<p>Top panel</p> <p>Discharge grille</p> <p>Front panel (R5496)</p>	

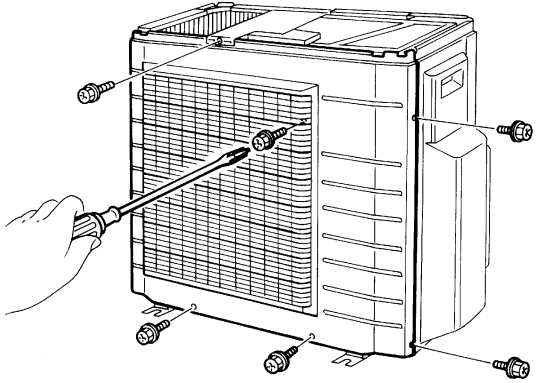
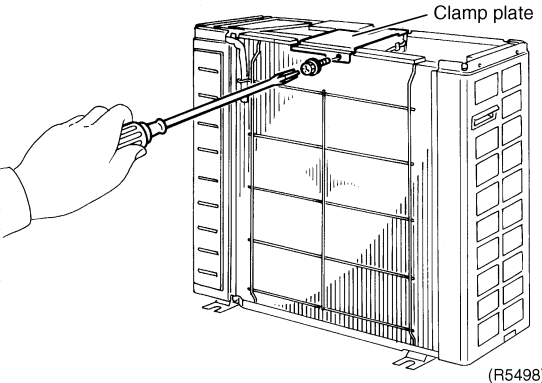
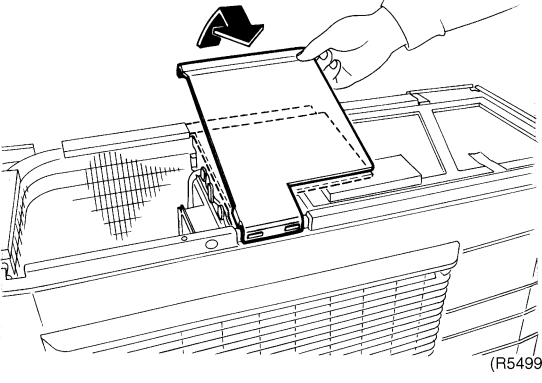
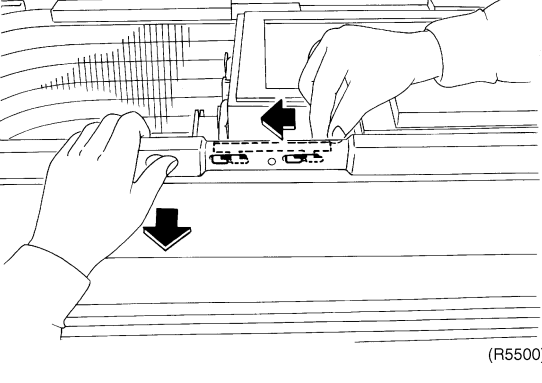
Step	Procedure	Procedure	Points
3	Loosen the 6 screws of the front panel.	 <p>(R5497)</p>	
4	Loosen the 2 screws (each 1 in front and back) of the clamp plate.	 <p>(R5498)</p>	
5	Slide the clamp plate to the left to undo the hooks and remove the plate.	 <p>(R5499)</p>	
6	Undo the upper 2 hooks to remove the front panel.	 <p>(R5500)</p>	<ul style="list-style-type: none"> <li>Align the position of hole of the upper hook to pull the front panel out.</li> </ul>

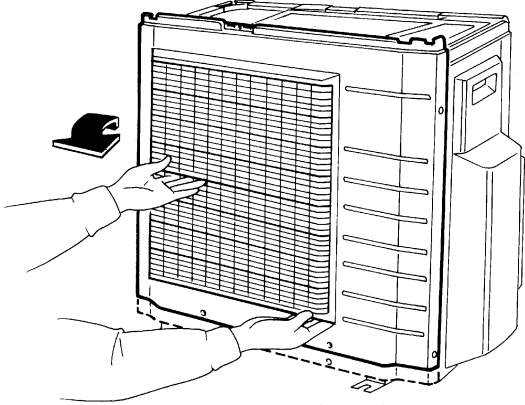
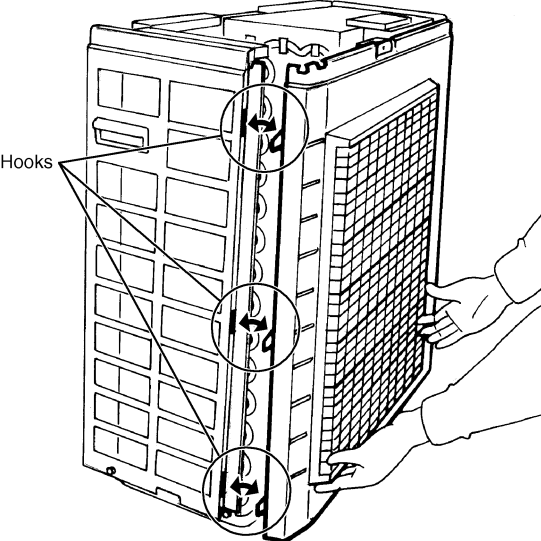
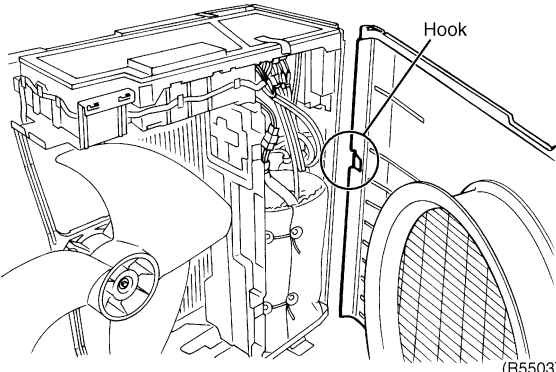

Step	Procedure	Points
7	<p>Lift the front panel up to remove the left side hooks and open the panel.</p>  <p>(R5501)</p>	
8	<p>The front panel has the 3 hooks on the left.</p>  <p>Hooks</p> <p>(R5502)</p>	
9	<p>The front panel has the 1 hook on the right.</p>  <p>Hook</p> <p>(R5503)</p>	

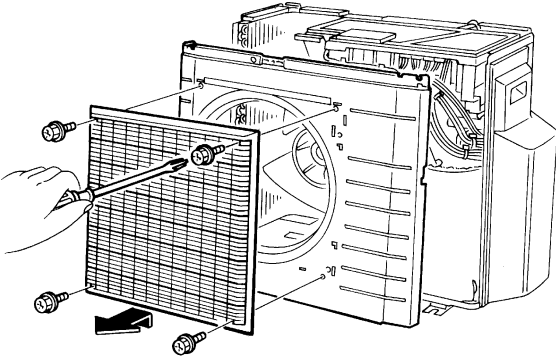
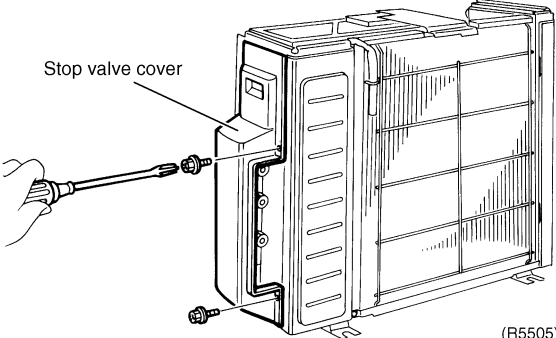
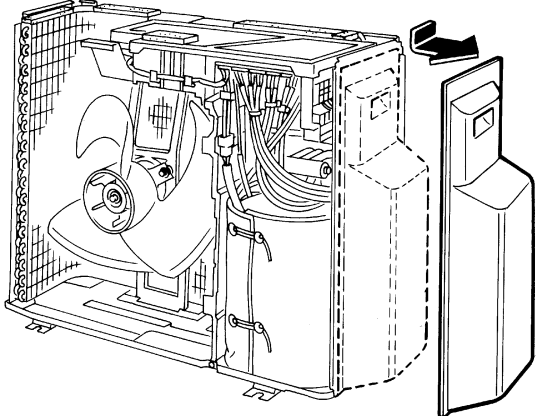
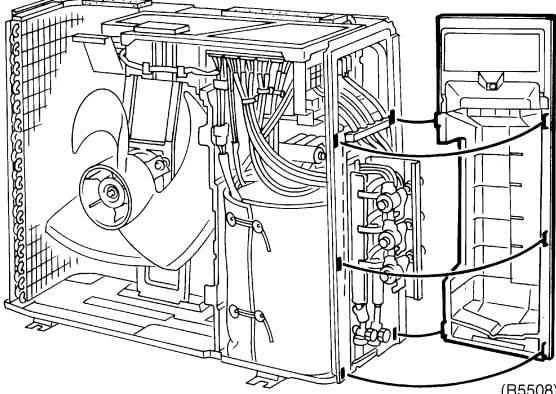
Step		Procedure	Points
10	Loosen the 4 screws of the <b>discharge grille</b> .	 <p>(R5504)</p>	
11	Loosen the 2 screws of the <b>stop valve cover</b> . And then slide the cover downward to remove.	 <p>(R5505)</p>  <p>(R5506)</p>  <p>(R5508)</p>	<p>■ When assembling, make sure to catch the 5 hooks.</p>

# 1.2 Removal of the Electrical Box

**Procedure**



**Warning**

Be sure to wait 10 minutes or more after turning off all power supplies before disassembling work.

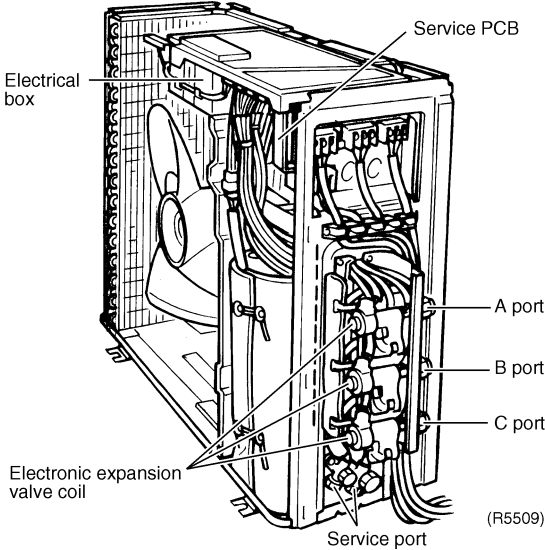
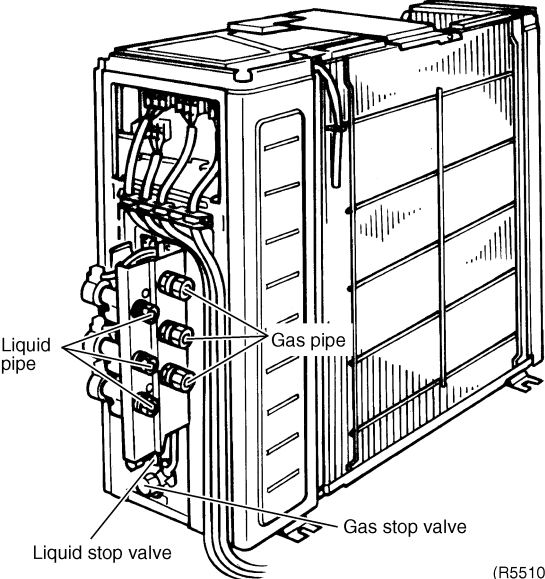
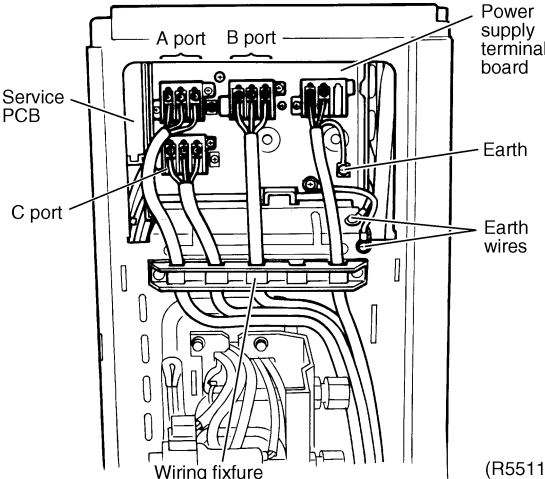
Step	Procedure	Points
1. Disconnect the connecting wires		
1	<p>Inside structure.</p>  	<p>★ Illustrations are for 3 room model. (4MK(X)S-F models have 4 ports)</p>
2	<p>Disconnect the connecting wires.</p> 	<ul style="list-style-type: none"> <li>■ Connecting wires of the A, B, C, D port                     <ul style="list-style-type: none"> <li>(1) - Black Power supply</li> <li>(2) - White Power supply</li> <li>(3) - Red Transmission</li> </ul> </li> <li>■ Power Supply wires                     <ul style="list-style-type: none"> <li>(L) - Black</li> <li>(N) - White</li> </ul> </li> <li>■ Fasten the wires on the terminal board with screws.</li> </ul>

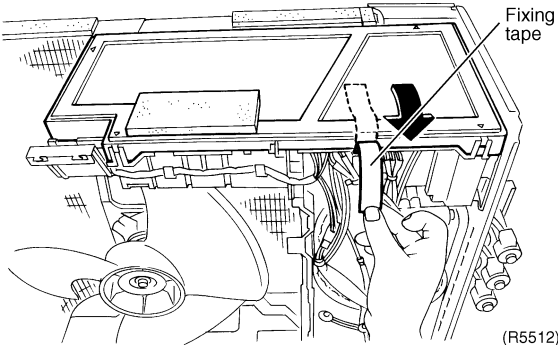
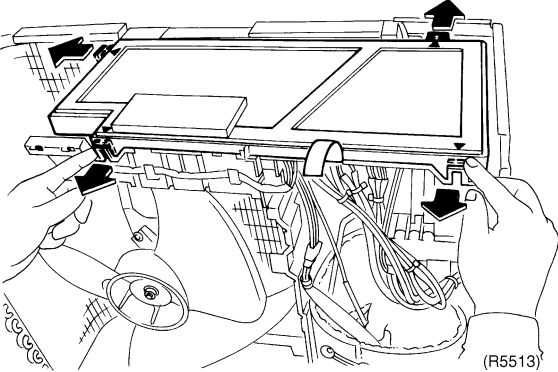
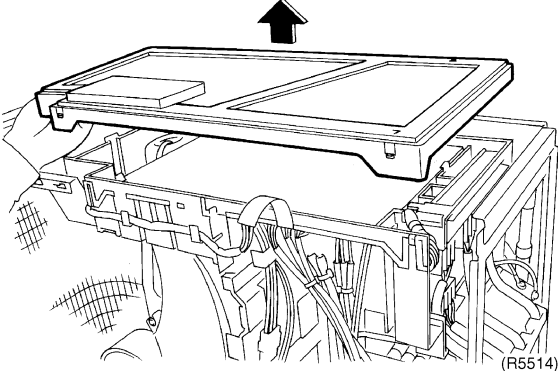
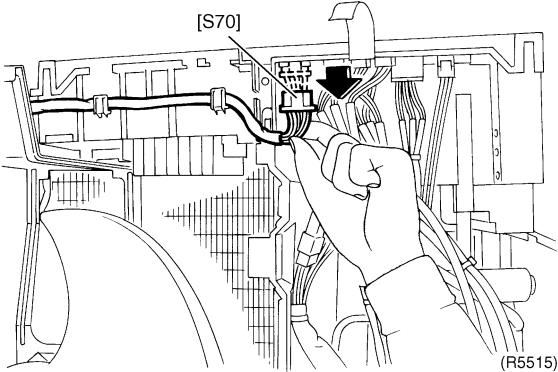
Step	Procedure	Points
2. Disconnect the each harnesses		
1	Detach the fixing tape for the electrical box (cover). 	
2	Undo the 4 hooks at the ▲ mark of the drip proof cover. 	
3	Lift the cover up to remove. 	
4	Disconnect the connector for fan motor [S70] from the PCB. 	<ul style="list-style-type: none"> <li>■ The shape of [S70] wire is different depending on the models.</li> </ul>

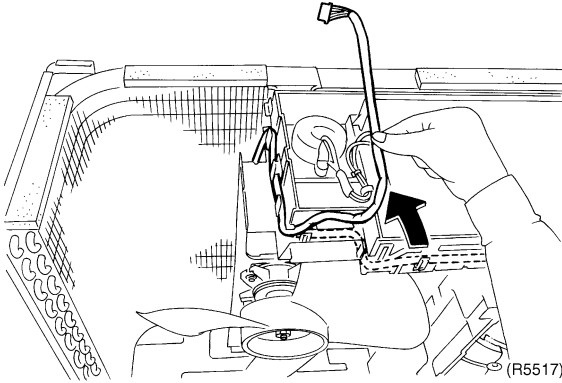
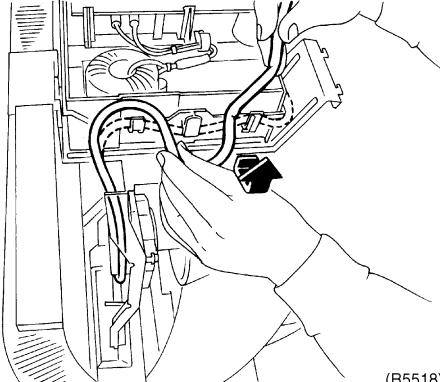
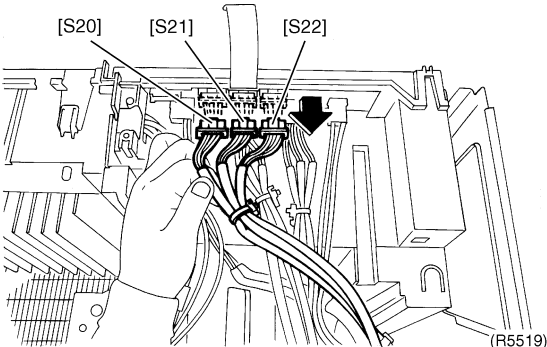
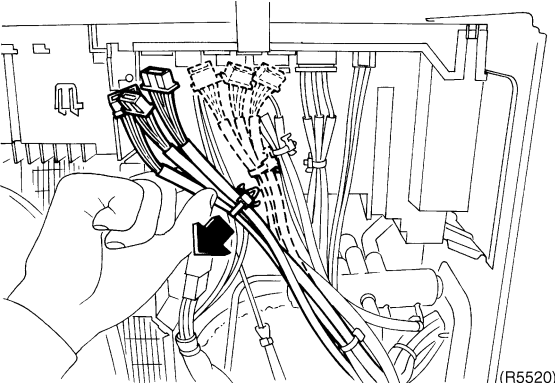
Step	Procedure	Points
5	<p>The figure shows the arrangement of the wire harness for fan motor.</p>  	
6	<p>Disconnect the connectors for electronic expansion valve coil.</p> <p>[S20] - White                      [S21] - Red                      [S22] - Blue                      [S23] - Yellow</p> 	<p>■ The number of the connectors are different according to the number of the connected indoor units.</p>
7	<p>Undo the wire clip.</p> 	

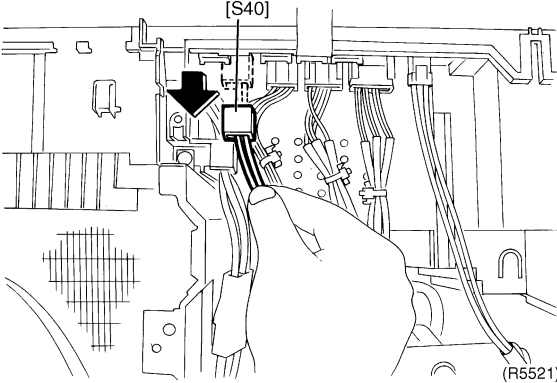
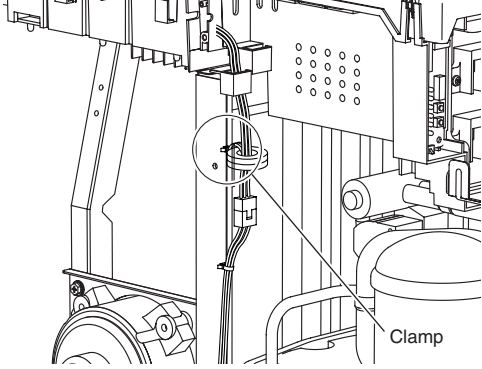
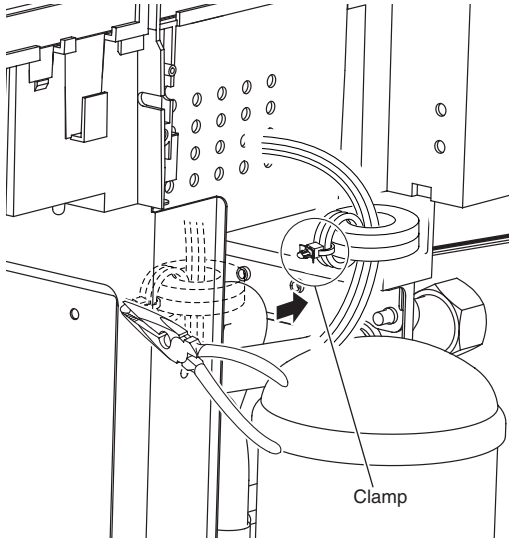
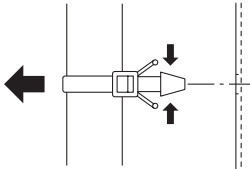
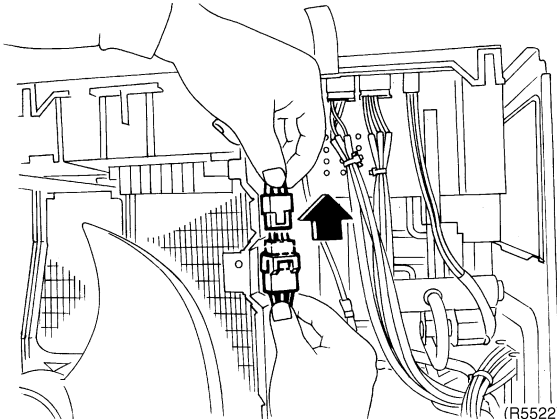
Step	Procedure	Procedure	Points
8	Disconnect the connector for overload protector [S40].	 <p>(R5521)</p>	
9	Remove the OL wire harness and the compressor wire harness together from the partition plate.	 <p>Clamp</p> <p>(R6422)</p>	
10	Use long-nose pliers or the like to pull out the clamp.	 <p>Clamp</p> <p>(R6423)</p>	<ul style="list-style-type: none"> <li>■ Detach the clamp.</li> <li>■ Just pull the push-mount type out of position.</li> </ul> 
11	Disconnect the connector for relay harness of compressor.	 <p>(R5522)</p>	

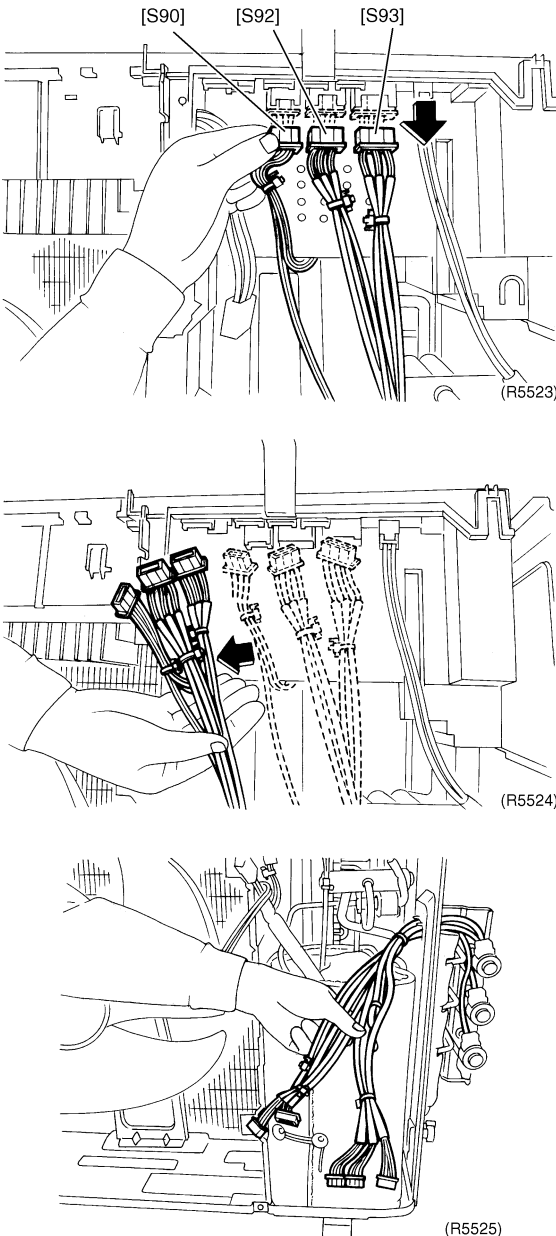
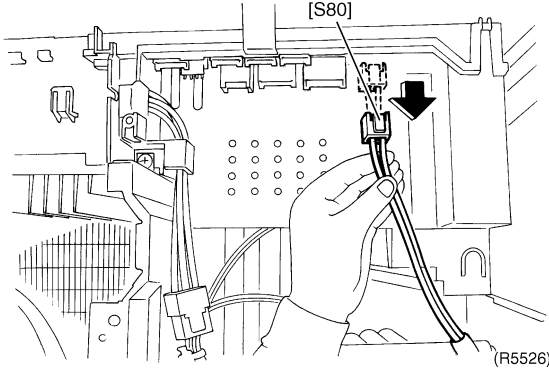
Step		Procedure	Points
12	<p>Disconnect the each connector.</p> <p>[S90] : Outdoor air, heat exchanger, discharge pipe thermistor</p> <p>[S92] : Gas pipe thermistor</p> <p>[S93] : Liquid pipe thermistor</p>	 <p>The first diagram (R5523) shows a hand pulling connector [S90] away from the terminal block. The second diagram (R5524) shows a hand pulling connector [S92] away. The third diagram (R5525) shows a hand pulling connector [S93] away. Arrows in each diagram indicate the direction of removal.</p>	
13	<p>Disconnect the connector for four way valve [S80].</p>	 <p>The diagram (R5526) shows a hand pulling connector [S80] away from the terminal block. An arrow indicates the direction of removal.</p>	

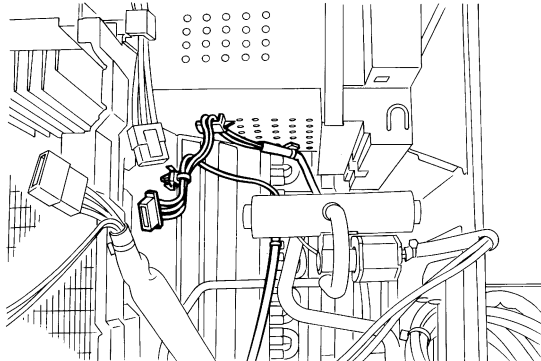
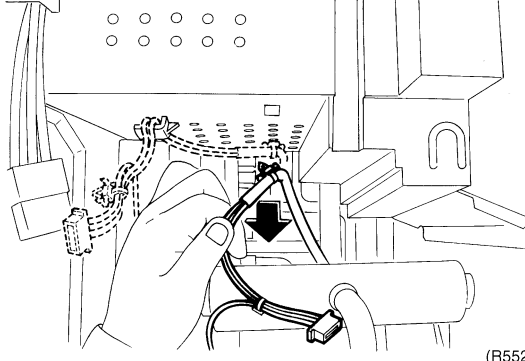
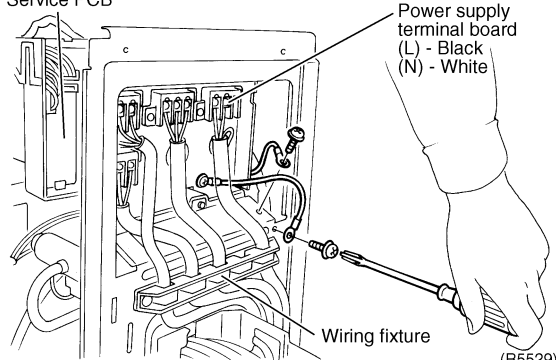
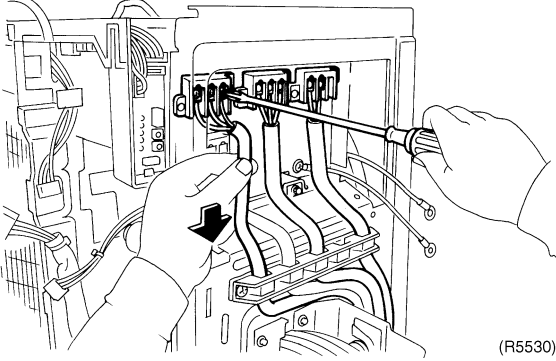
Step	Procedure	Points	
14	The figure shows the arrangement of the wire harness under the electrical box.	 <p>(R5527)</p>	
15	Undo the wire clip for the thermistor lead wire.	 <p>(R5528)</p>	
<b>3. Remove the electrical box</b>			
1	Loosen the 2 screws of the earth terminal.	 <p>(R5529)</p>	
<b>4. Disconnect the power supply connecting wires</b>			
1	Loosen the screws on the terminal board and disconnect the wires of A, B, C, and D port.	 <p>(R5530)</p>	<p>★ Illustrations are for 3 room model.</p>

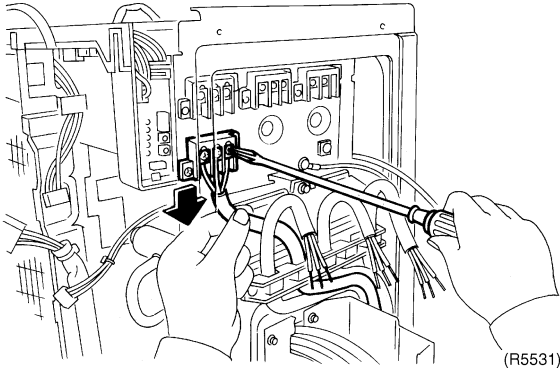
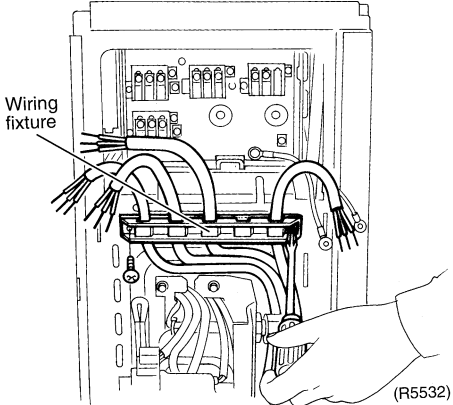
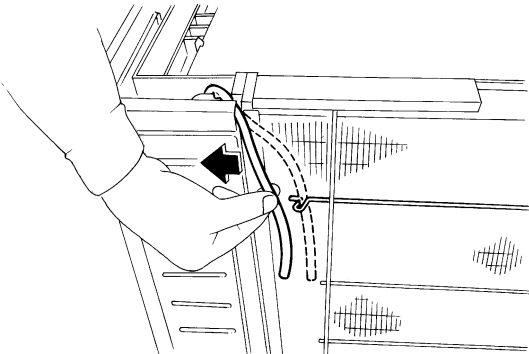
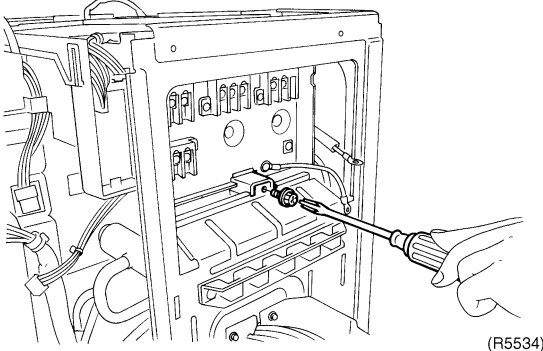

Step	Procedure	Points
2	<p data-bbox="199 1093 454 1160">Detach the outdoor air thermistor.</p>   	
3	<p data-bbox="199 1525 438 1615">Loosen the screw on the right side of the electrical box.</p> 	

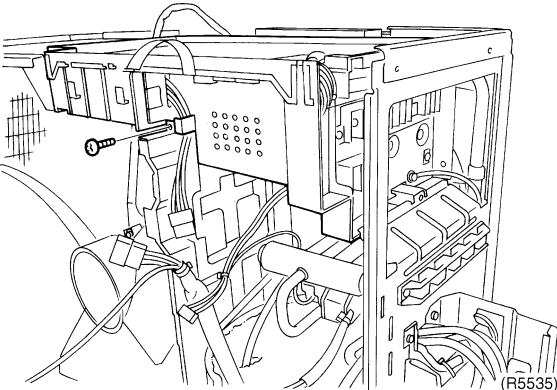
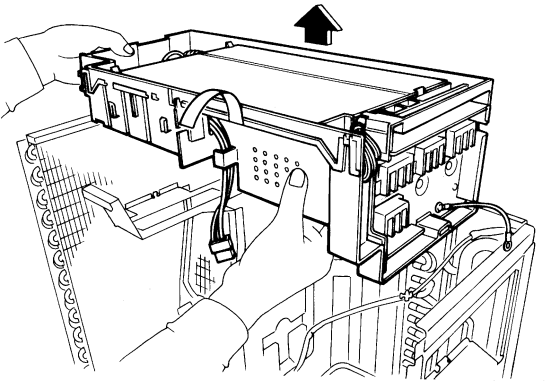
Step	Procedure	Points	Points
4	Loosen the 1 screw in front of the electrical box.	 <p>(R5535)</p>	
5	Lift up the electrical box to remove.	 <p>(R5536)</p>	

# 1.3 Removal of the PCB

**Procedure**

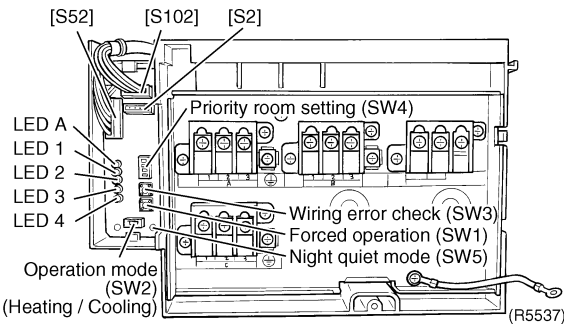
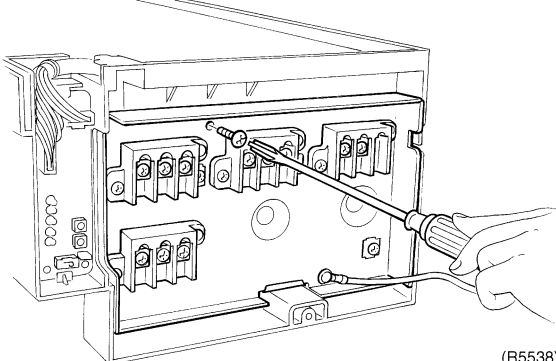
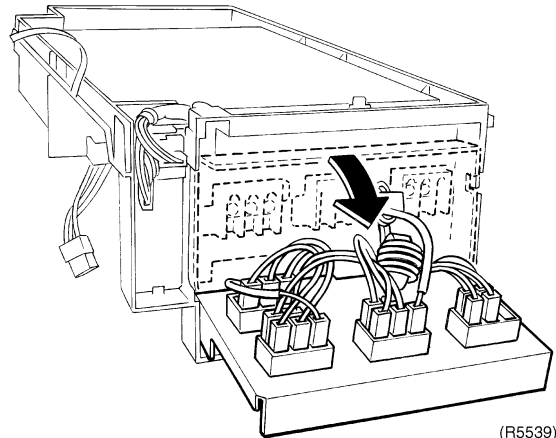
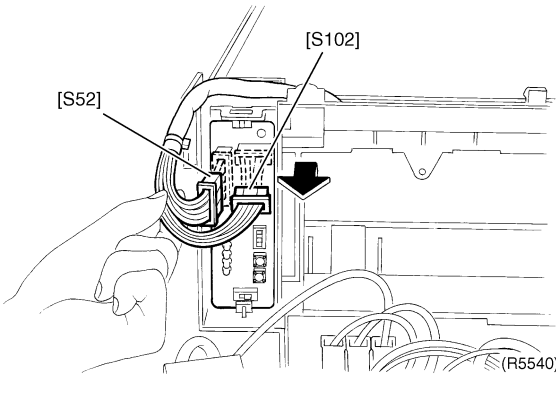

**Warning** Be sure to wait 10 minutes or more after turning off all power supplies before disassembling work.

Step	Procedure	Points
1.	Remove the <b>service PCB</b>	★ Illustrations are for 3 room model.
1	<p>External appearance of the service PCB and the terminal board.</p> 	
2	<p>Loosen the 1 screw of the terminal board and open it.</p>  	
3	<p>Disconnect the connector [S52] and [S102] from the service PCB.</p> 	

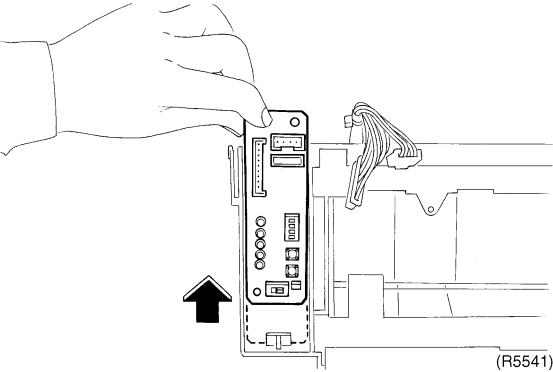
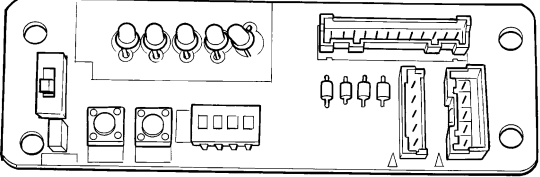
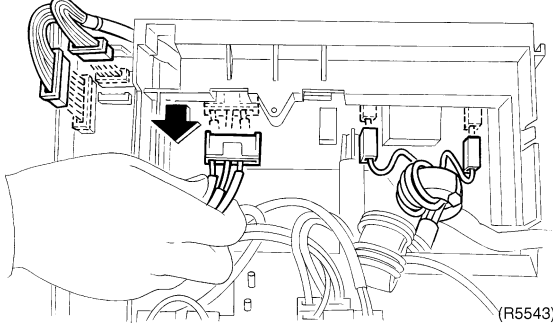
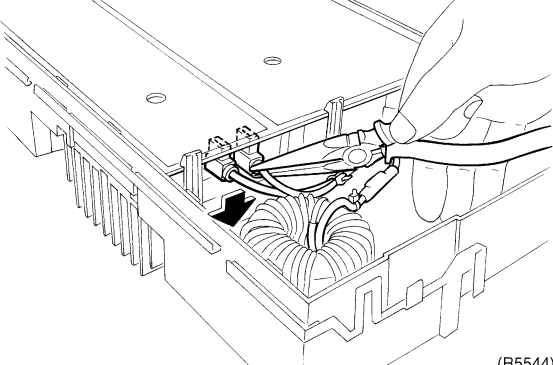
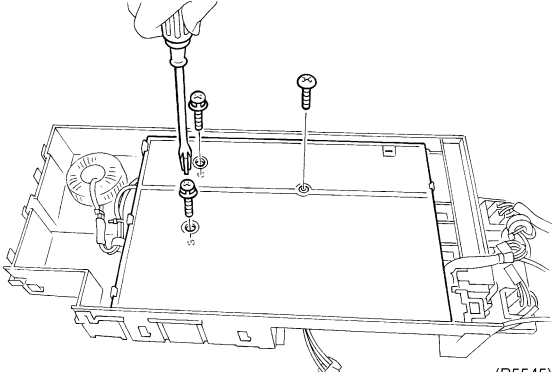
Step	Procedure	Points
4	<p>Widen the upper hook and pull the service PCB upward to remove.</p>  <p>(R5541)</p>  <p>(R5542)</p>	
2. Remove the <b>control PCB</b>		
1	<p>Disconnect the each connectors on the terminal board.</p>  <p>(R5543)</p>	
2	<p>Disconnect the 2 connectors for reactor.</p>  <p>(R5544)</p>	
3	<p>Loosen the 3 screws of the PCB.</p>  <p>(R5545)</p>	

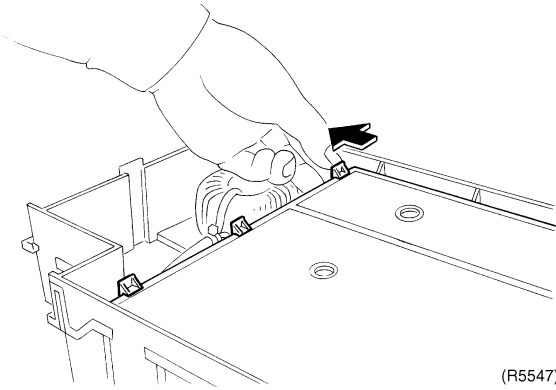
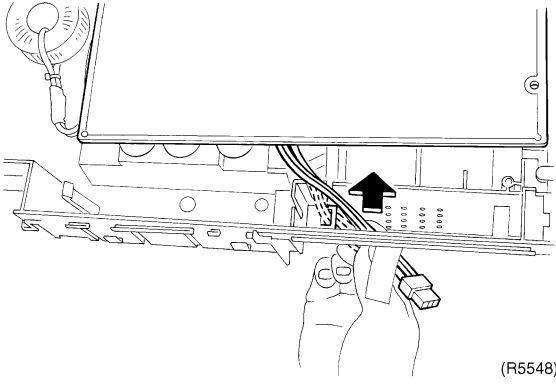
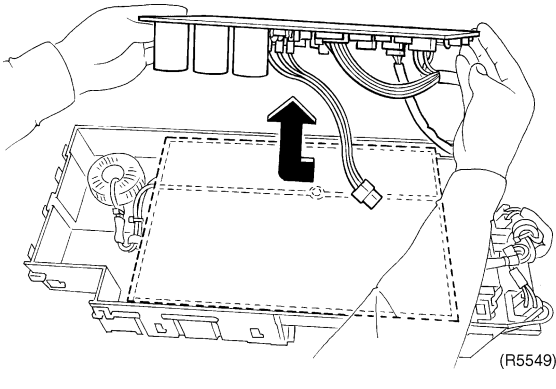
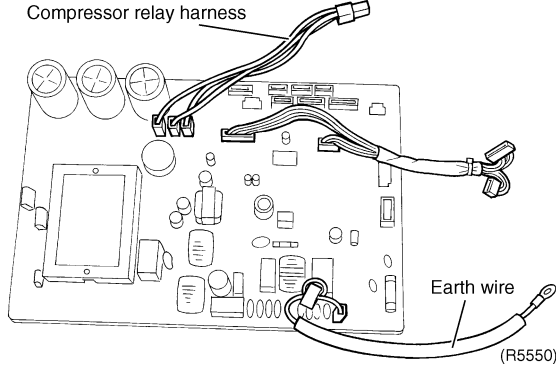
Step	Procedure	Points
4	Undo the 3 hooks on the reactor side and slide the control PCB.	
	 <p>(R5547)</p>	
5	Undo the relay harness for compressor from the hook.	
	 <p>(R5548)</p>	
6	Lift up the control PCB to remove.	
	 <p>(R5549)</p>	<ul style="list-style-type: none"> <li>■ In working, be careful not to break the control PCB with the excessive force because the PCB and the radiation fin are adhered to one another.</li> <li>■ When assembling, make sure to use the silicon material.</li> <li>■ Silicon material Part No.: 1172698</li> </ul>
7	Each wire harness.	
	 <p>Compressor relay harness</p> <p>Earth wire</p> <p>(R5550)</p>	

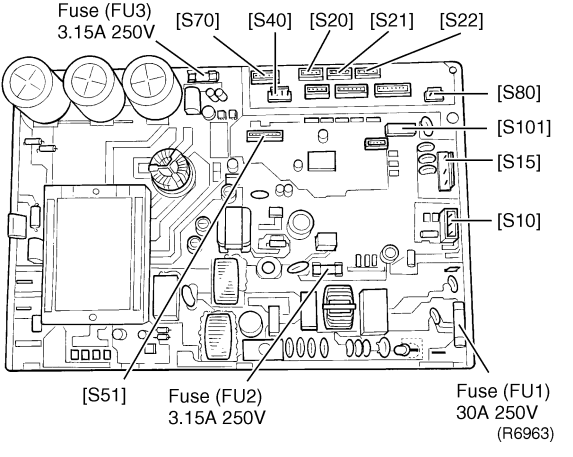
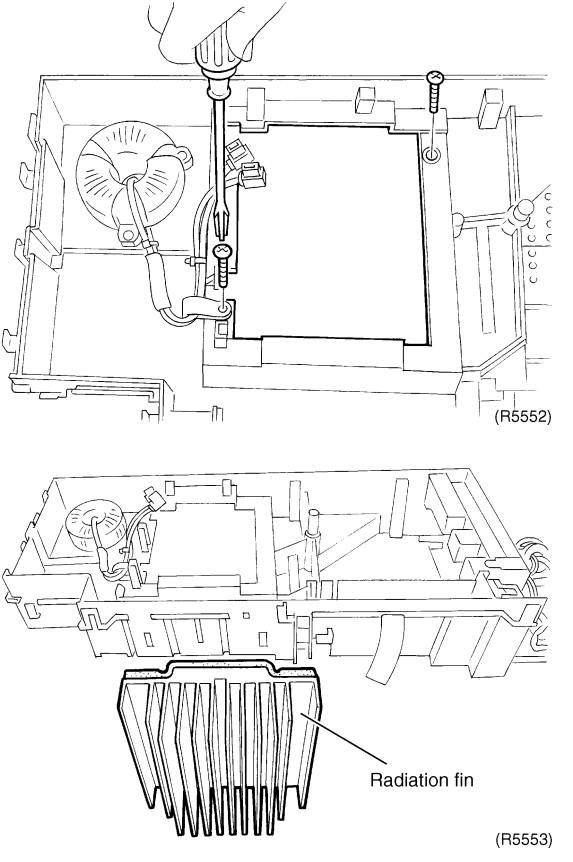
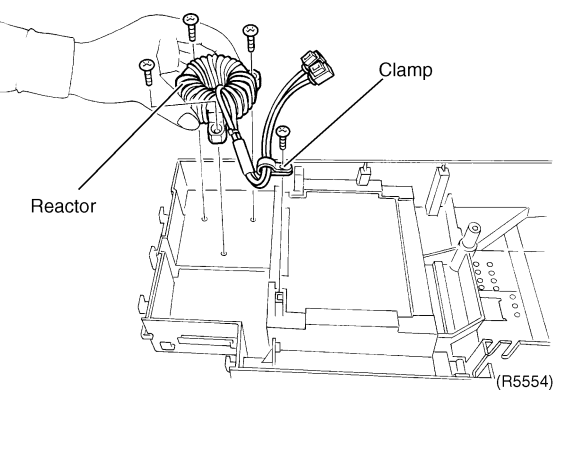
Step	Procedure	Points
8	<p>Names of parts on the control PCB.</p> 	<p>■ See page 47 for detail.</p>
9	<p>Loosen the 2 screws of the radiation fin.</p> 	
10	<p>Loosen the 3 screws of the reactor and the 1 screw of the clamp.</p> 	

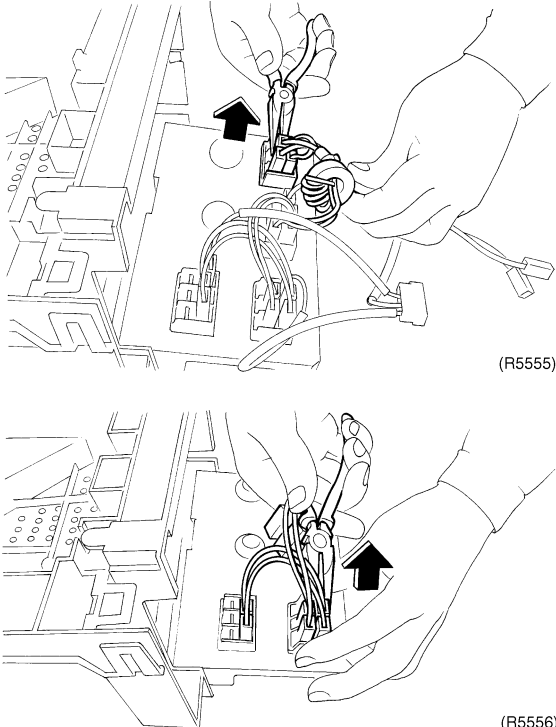
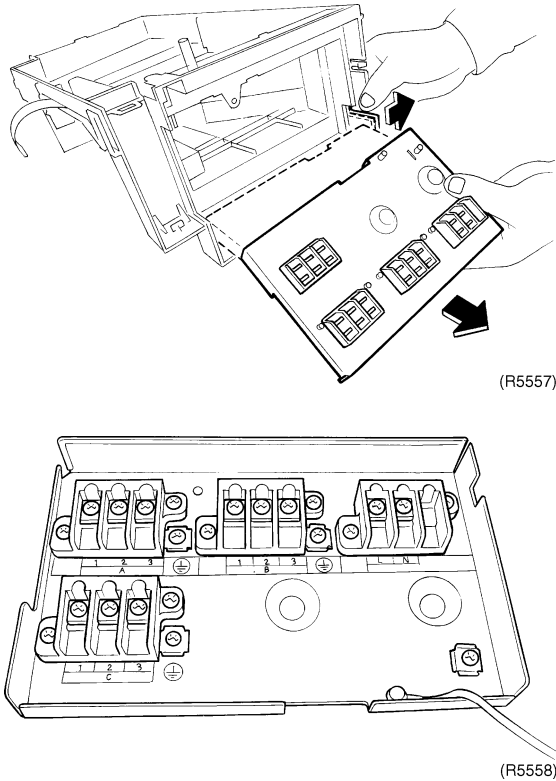
Step	Procedure	Points
<p>3. Disconnect the wire harnesses</p>	 <p>(R5555)</p> <p>(R5556)</p>	
<p>4. Remove the terminal board</p> <p>1 Open the electrical box and remove the terminal board.</p>	 <p>(R5557)</p> <p>(R5558)</p>	<p>★ Illustrations are for 3 room model.</p>

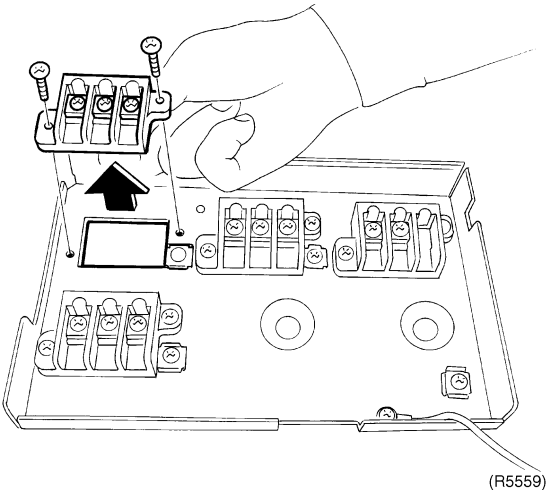
Step	Procedure	Points
	 <p>(R5559)</p>	



# 1.4 Removal of the Propeller Fan / Fan Motor

**Procedure**



**Warning**

Be sure to wait 10 minutes or more after turning off all power supplies before disassembling work.

Step	Procedure	Procedure	Points
1	Remove the fan motor fixing plate.	<p>(R5560)</p>	<ul style="list-style-type: none"> <li>■ Remove the outer panels and plates.</li> <li>■ Remove the electrical box.</li> </ul>
2	Take out the fan motor fixing plate toward yourself.	<p>(R5561)</p>	<p>(R5564)</p> <ul style="list-style-type: none"> <li>■ When assembling, fit the lower hooks.</li> </ul>
3	Loosen the washer fitted nut to remove the propeller fan.	<p>(R5562)</p> <p>(R5563)</p>	<p>(R5565)</p> <ul style="list-style-type: none"> <li>■ When assembling, align ▼ mark of the propeller fan with D-cut section of the motor shaft.</li> <li>■ When assembling, make sure ● mark of the fan motor goes up.</li> </ul>

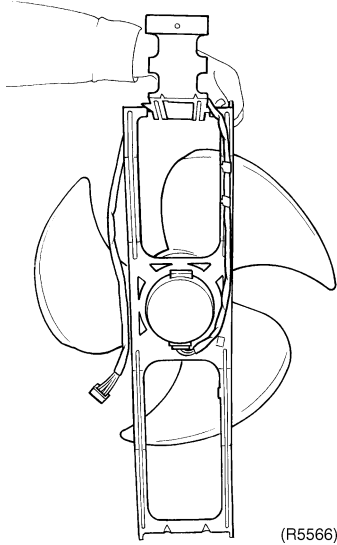
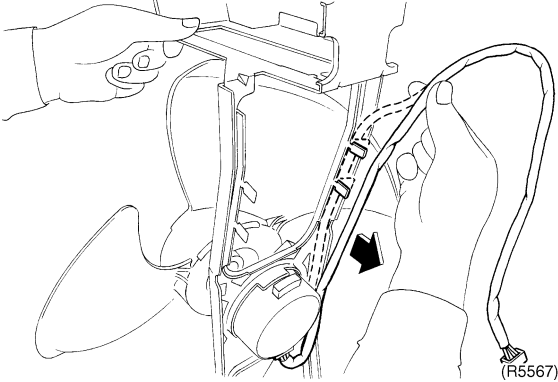
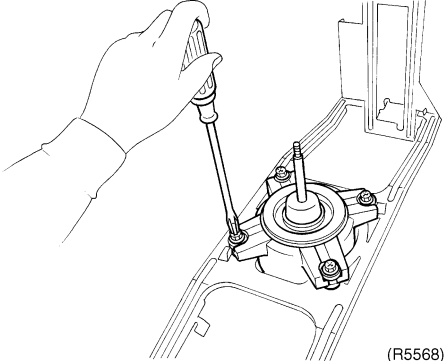
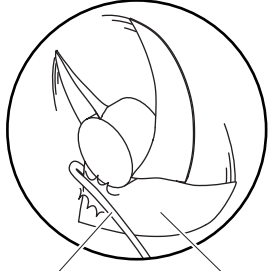
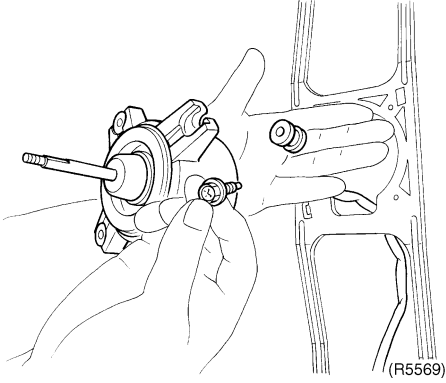
Step	Procedure	Points
<p>4</p>	<p>Undo the 2 fixing hooks of the lead wire. Loosen the 4 screws of the fan motor.</p>  <p>(R5566)</p>  <p>(R5567)</p>  <p>(R5568)</p>	 <p>Lead wire      Propeller fan (R3249)</p> <ul style="list-style-type: none"> <li>■ When assembling, put the lead wire through the back of the motor. (so as not to be entangled with the propeller fan)</li> </ul>
<p>5</p>	<p>Detach the 4 screws and 4 rubber vibration isolators.</p>  <p>(R5569)</p>	

# 1.5 Removal of the Sound Blanket

**Procedure**



**Warning**

Be sure to wait 10 minutes or more after turning off all power supplies before disassembling work.

Step	Procedure	Points
1. Remove the right side panel	<p>(R5570)</p>	<ul style="list-style-type: none"> <li>■ Remove the outer panels and plates.</li> <li>■ Remove the electrical box.</li> </ul>
1 Loosen the 3 screws on the right of the right side panel.	<p>(R5571)</p>	
2 Loosen the 2 screws on the back.	<p>Packing</p> <p>(R5572)</p>	
3 Remove the packing. There is a hook on the back.		

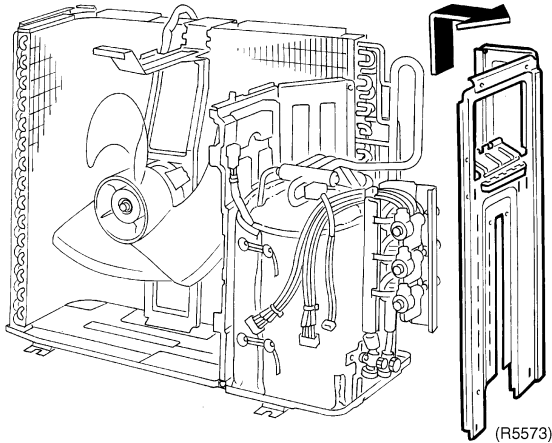
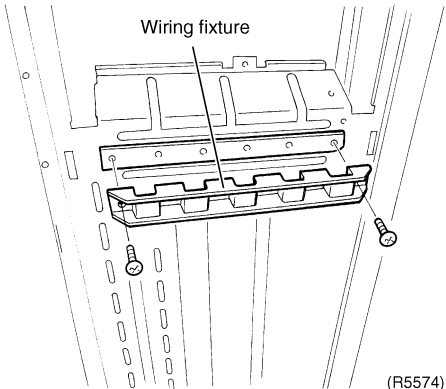
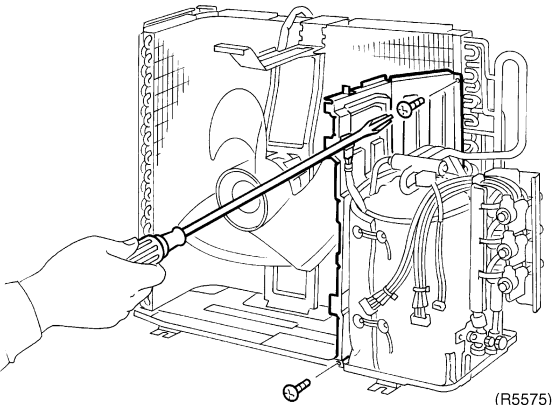
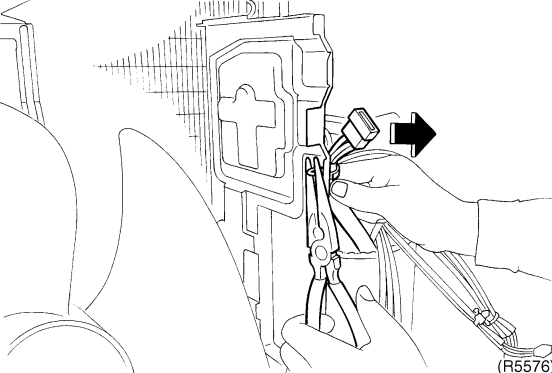
Step	Procedure	Points
4	<p>Pull up the right side panel.</p>  <p>(R5573)</p>	
	<p>5 Loosen the 2 screws of the wiring fixture.</p>  <p>(R5574)</p>	
<p>2. Remove the partition plate</p>		
1	<p>Loosen the 2 screws to remove the partition plate.</p>  <p>(R5575)</p>	
2	<p>Detach the clamp of the relay harness for the compressor.</p>  <p>(R5576)</p>	

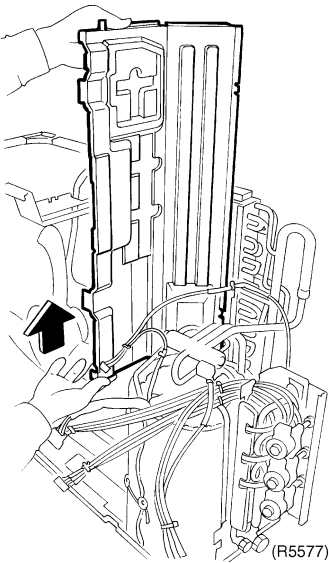
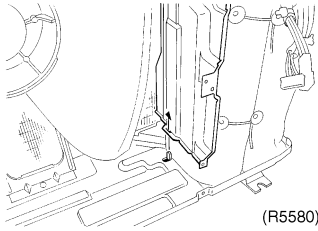
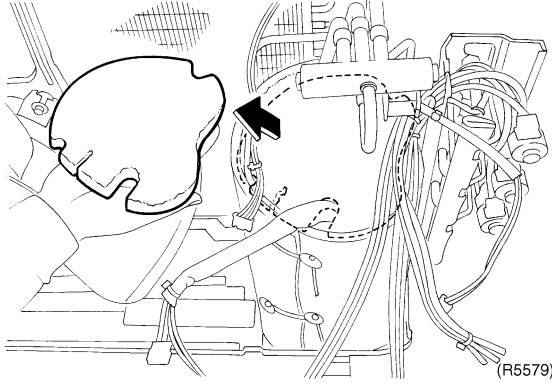
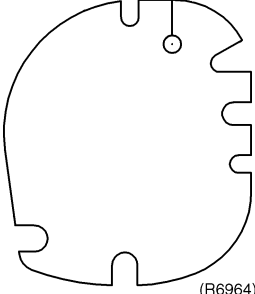
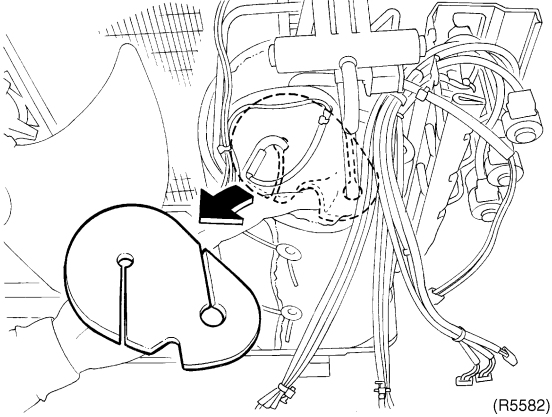
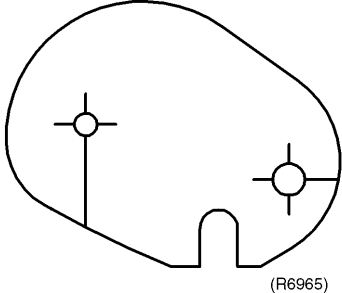
Step	Procedure	Procedure	Points
3	Pull up the partition plate.	 <p>(R5577)</p>	 <p>(R5580)</p> <ul style="list-style-type: none"> <li>When assembling, make sure to catch the lower hook of the partition plate.</li> </ul>
3.	Remove the sound blanket		<ul style="list-style-type: none"> <li>Illustrations are different depending on the models.</li> </ul>
1	Lift up the sound blanket (top-upper) to remove.	 <p>(R5579)</p>	 <p>(R6964)</p> <ul style="list-style-type: none"> <li>Since the piping ports on the sound blanket are torn easily, remove the blanket carefully.</li> </ul>
2	Remove the sound blanket (top-lower).	 <p>(R5582)</p>	 <p>(R6965)</p>

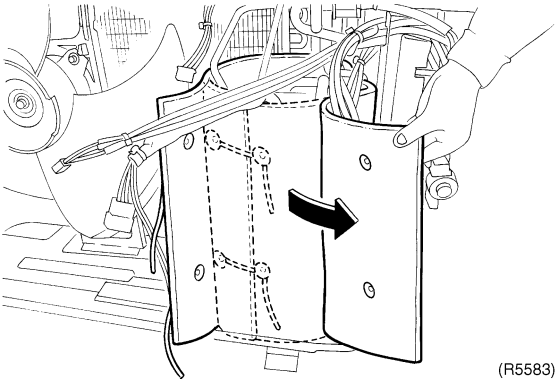
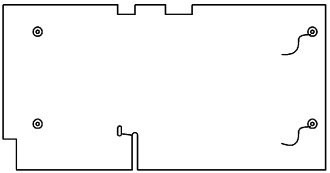
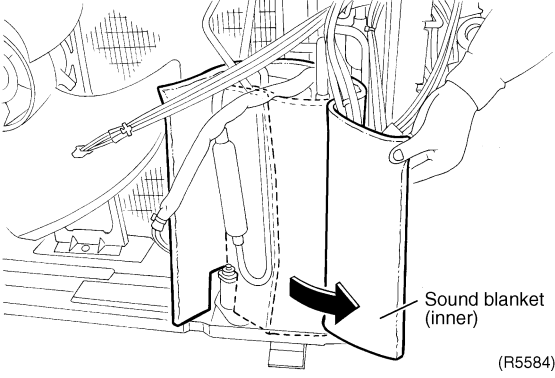
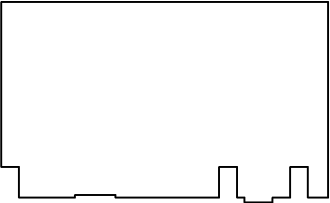
Step	Procedure	Points
3	<p>Undo the fixing strings, open the sound blanket (body) and pull it out.</p>  <p>(R5583)</p>	 <p>(R6966)</p>
4	<p>Open the sound blanket (inner) and pull it out.</p>  <p>Sound blanket (inner)</p> <p>(R5584)</p>	 <p>(R6967)</p>

# 1.6 Removal of Electronic Expansion Valve Coil, Four Way Valve Coil and Thermistor

**Procedure**

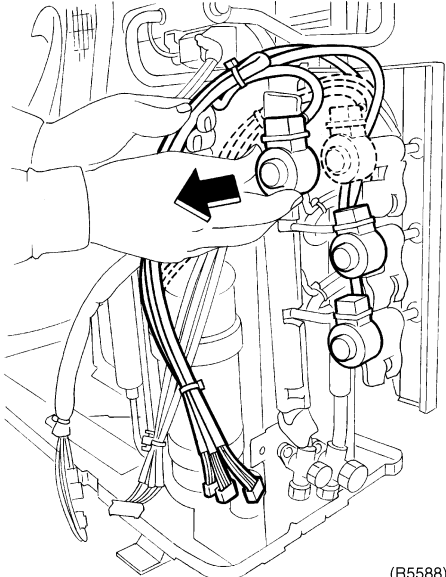
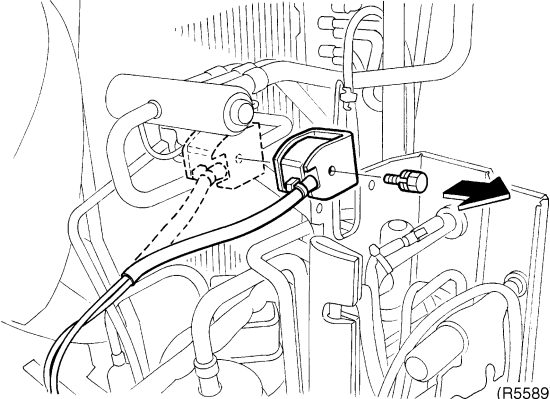

**Warning** Be sure to wait 10 minutes or more after turning off all power supplies before disassembling work.

Step	Procedure	Points
1. Remove the electronic expansion valve coil	 <p>(R5588)</p>	<p>★ Illustrations are for 3 room model.</p>
2. Remove the four way valve coil	 <p>(R5589)</p>	

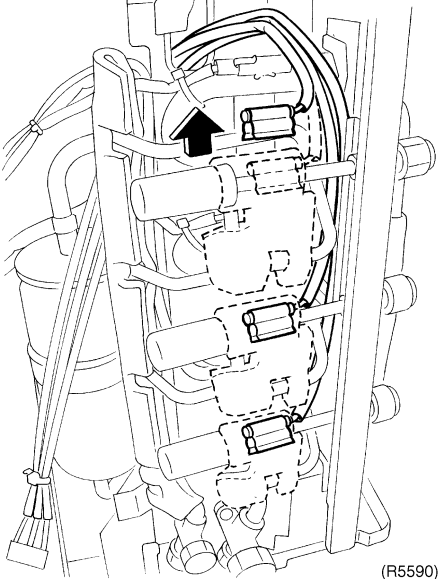
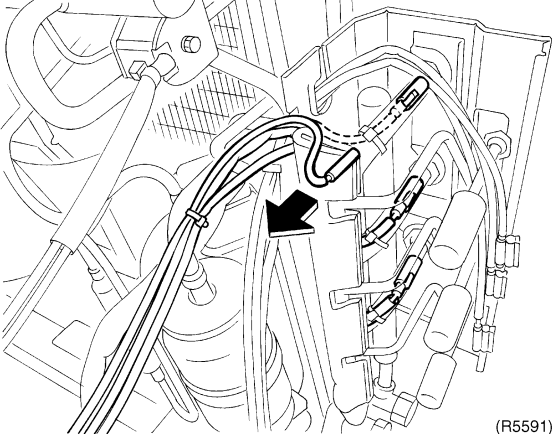
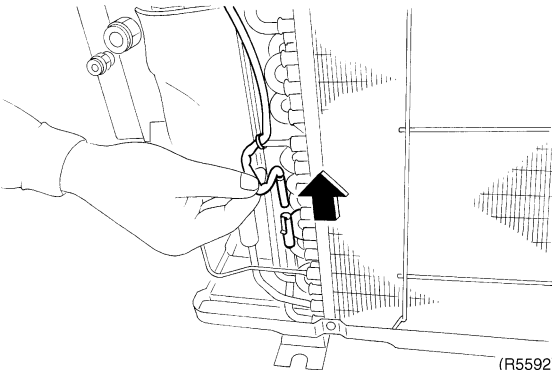
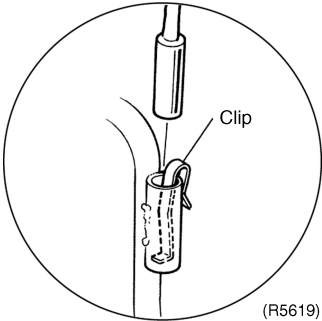
Step	Procedure	Points
<p>3. Remove the liquid/gas pipe thermistor</p> <p>1 Open the putty and remove the liquid pipe thermistor.                      [S90] : Outdoor air thermistor                      Heat exchanger thermistor                      Discharge pipe thermistor                      [S92] : Gas pipe thermistor                      Room A (Black)                      Room B (Gray)                      Room C (Brown)                      Room D (Red)                      [S93] : Liquid pipe thermistor                      Room A (Black)                      Room B (Gray)                      Room C (Yellow)                      Room D (Blue)</p> <p>2 Open the putty and remove the gas pipe thermistor.</p>	 <p>(R5590)</p>  <p>(R5591)</p>	<ul style="list-style-type: none"> <li>■ Meet the edge of the thermistor and clip.</li> <li>■ The number of ports is different according to the models.</li> </ul>
<p>4. Remove the heat exchanger thermistor</p> <p>1 Remove the heat exchanger thermistor.</p>	 <p>(R5592)</p>	 <p>(R5619)</p>



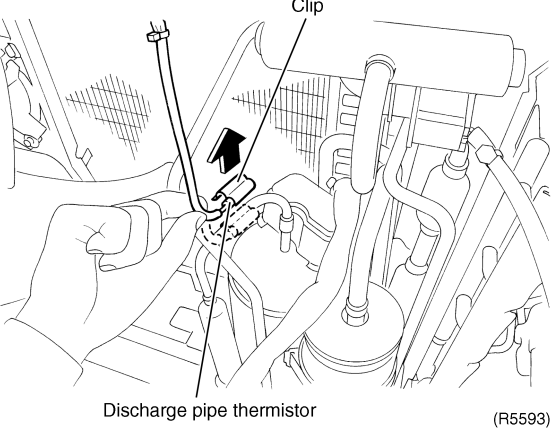
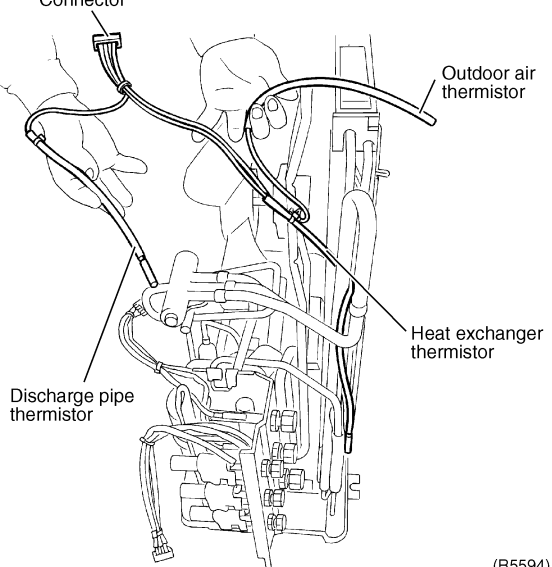



Step	Procedure	Points
<p>5. Remove the <b>discharge pipe thermistor</b></p>	<p>1 Undo the clip and remove the discharge pipe thermistor.</p> 	<ul style="list-style-type: none"> <li>■ Meet the edge of the thermistor and clip.</li> <li>■ Be careful not to loose the clip for the discharge pipe thermistor.</li> </ul>
<p>6. Remove the assembly of thermistor.</p>	<p>1 The figure shows the arrangement of the assembly of thermistor.</p> 	

## 1.7 Removal of the Distributor

**Procedure**

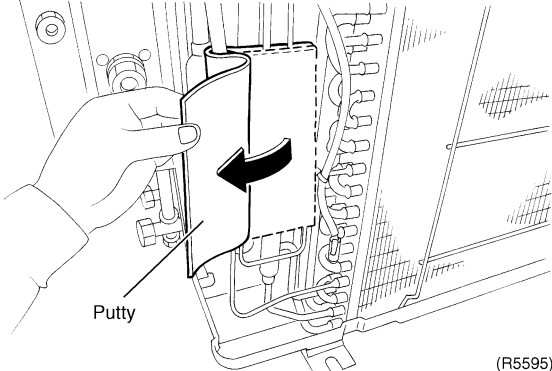
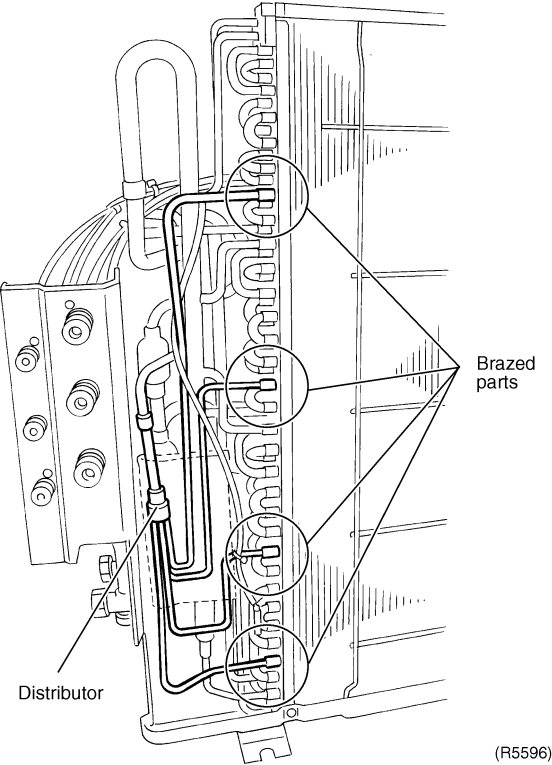

**Warning** Be sure to wait 10 minutes or more after turning off all power supplies before disassembling work.

Step	Procedure	Procedure	Points
1	Remove the putty.	 <p>(R5595)</p>  <p>(R5596)</p>	<p> <b>Warning</b> Ventilate when refrigerant leaks during the work. (If refrigerant contacts fire, it will cause to arise toxic gas.)</p> <p> <b>Caution</b> Be careful not to get yourself burnt with the pipes and other parts that are heated by the gas welding rod.</p> <p> <b>Caution</b> From the viewpoint of global environment protection, do not discharge the refrigerant gas in the atmosphere. Make sure to recover the refrigerant gas with the recovery system.</p>

# 1.8 Removal of the Four Way Valve

**Procedure**

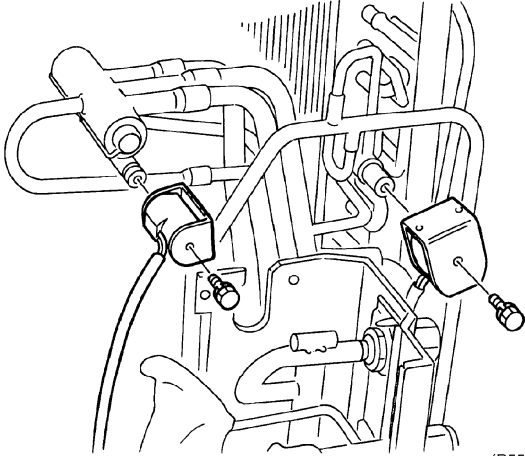
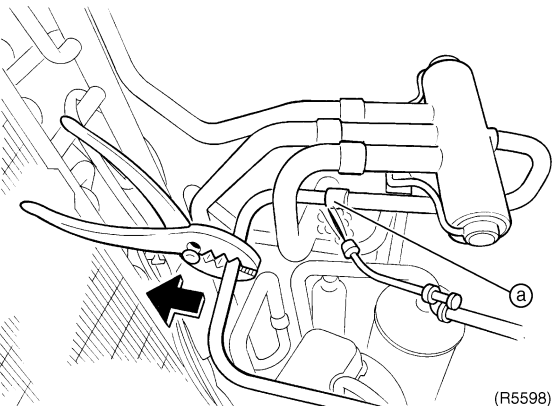
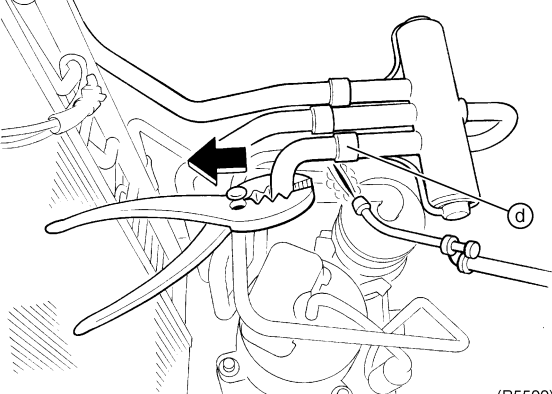
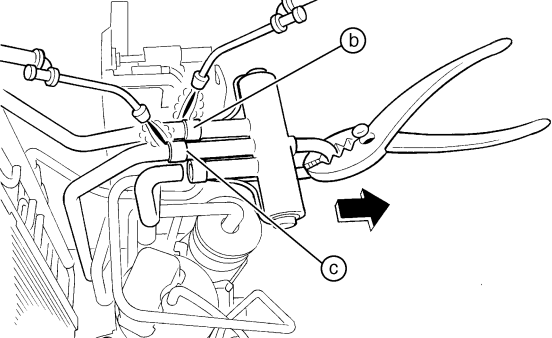

**Warning** Be sure to wait 10 minutes or more after turning off all power supplies before disassembling work.

Step	Procedure	Points
<p>■ Be sure to apply nitrogen replacement when heating up the brazed part.</p>	 <p style="text-align: right;">(R5597)</p>	<p><b>Cautions for restoration</b></p> <ol style="list-style-type: none"> <li>1. Restore the piping by non-oxidation brazing. In case of you cannot use the nitrogen gas, restore as quickly as possible.</li> <li>2. It is required to prevent the carbonization of the oil inside the four way valve and the deterioration of the gaskets affected by heat. For the sake of this, wrap the four way valve with wet cloth and provide water so that the cloth will not be dried and avoid excessive heating. (Keep below 120°C)</li> </ol>
<p>1 Loosen the 1 screw to remove the four way valve coil.</p> <p>2 Heat up the 4 brazed part of the four way valve. First, disconnect the part "a".</p> <p>■ Provide a protective sheet or a steel plate so that the brazing flame cannot influence peripheries.</p>	 <p style="text-align: right;">(R5598)</p>	<p>■ Be careful so as not to break the pipes by pressing it excessively by pliers when withdrawing it.</p> <p><b>In case of the difficulty with gas brazing machine</b></p> <ol style="list-style-type: none"> <li>1. Disconnect the brazed part where is easy to disconnect and restore.</li> <li>2. Cut pipes on the main unit by a miniature copper tube cutter in order to make it easy to disconnect.</li> </ol>
<p>3 Disconnect the part "d".</p>	 <p style="text-align: right;">(R5599)</p>	<p><b>i</b> Note: Do not use a metal saw for cutting pipes by all means because the sawdust come into the circuit.</p>
<p>4 Disconnect the part "b" and "c".</p>	 <p style="text-align: right;">(R5600)</p>	



# 1.9 Removal of the Compressor

**Procedure**

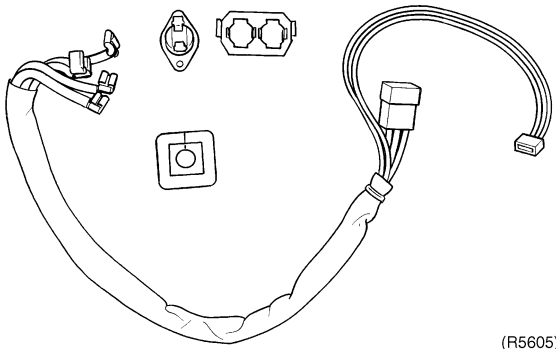

**Warning** Be sure to wait 10 minutes or more after turning off all power supplies before disassembling work.

Step	Procedure	Points
1. Remove the terminal cover	<p style="text-align: right;">(R5601)</p>	<p>Make a note.</p> <ul style="list-style-type: none"> <li>■ Be careful so as not to burn the compressor terminals or the name plate.</li> </ul>
1 Remove the terminal cover.		
2 Disconnect the flag-shaped terminals.	<p style="text-align: right;">(R5602)</p>	<p><b>Warning</b> Since it may happen that refrigeration oil in the compressor will catch fire, prepare wet cloth so as to extinguish fire immediately.</p>
3 Detach the compressor lead wire.		<p><b>Warning</b> Ventilate when refrigerant leaks during the work. (If refrigerant contacts fire, it will cause to arise toxic gas.)</p>
3 Detach the compressor lead wire.		
4 Detach the overload protector.	<p style="text-align: right;">(R5603)</p>	<p><b>Caution</b> Be careful not to get yourself burnt with the pipes and other parts that are heated by the gas welding rod.</p>
4 Detach the overload protector.		
4 Detach the overload protector.	<p style="text-align: right;">(R5604)</p>	
4 Detach the overload protector.		

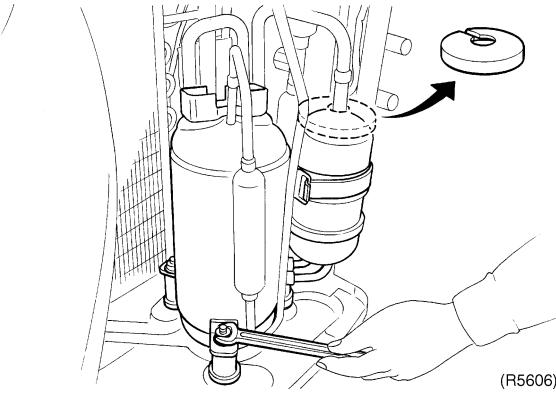
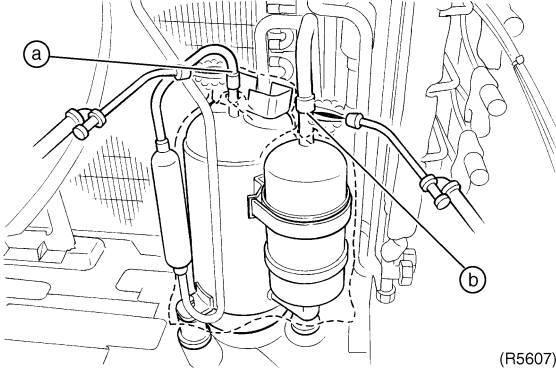
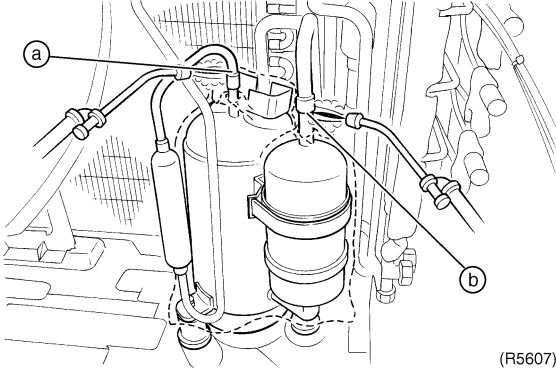
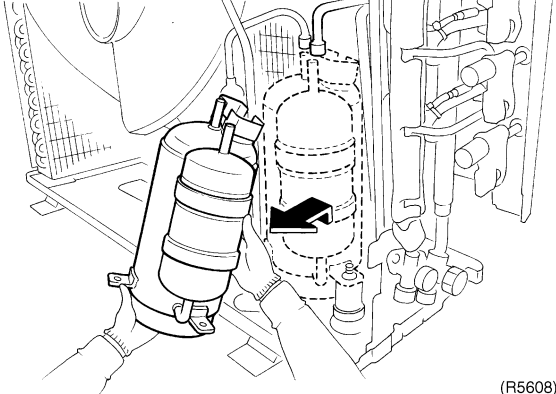
Step		Procedure	Points
5	Remove the 2 sheets of putty.	 <p>(R5605)</p>	<p><b>Warning</b>   Ventilate when refrigerant leaks during the work.                      (If refrigerant contacts fire, it will cause to arise toxic gas.)</p>
6	There is one nut fixing the compressor. Remove the nut with an open-end spanner.	 <p>(R5606)</p>	
■	Before working, make sure that the refrigerant is empty in the circuit.		
■	Be sure to apply nitrogen replacement when heating up the brazed part.		
7	Heat up the brazed part of the discharge side and disconnect (part "a").	 <p>(R5607)</p>	
8	Heat up the brazed part of the suction side and disconnect (part "b").	 <p>(R5607)</p>	
9	Lift the compressor up to remove.	 <p>(R5608)</p>	

# Part 8 Others

1. Others .....	300
1.1 Test Run from the Remote Controller .....	300
1.2 Jumper Settings .....	301
1.3 Application of Silicon Grease to a Power Transistor and a Diode Bridge.....	302

# 1. Others

## 1.1 Test Run from the Remote Controller

### For Heat pump

In cooling mode, select the lowest programmable temperature; in heating mode, select the highest programmable temperature.

- Trial operation may be disabled in either mode depending on the room temperature.
- After trial operation is complete, set the temperature to a normal level.  
(26°C to 28°C in cooling mode, 20°C to 24°C in heating mode)
- For protection, the system disables restart operation for 3 minutes after it is turned off.

### For Cooling Only

Select the lowest programmable temperature.

- Trial operation in cooling mode may be disabled depending on the room temperature.  
Use the remote control for trial operation as described below.
- After trial operation is complete, set the temperature to a normal level (26°C to 28°C).
- For protection, the machine disables restart operation for 3 minutes after it is turned off.

### Trial Operation and Testing

1. Measure the supply voltage and make sure that it falls in the specified range.
  2. Trial operation should be carried out in either cooling or heating mode.
  3. Carry out the test operation in accordance with the Operation Manual to ensure that all functions and parts, such as louver movement, are working properly.
- The air conditioner requires a small amount of power in its standby mode. If the system is not to be used for some time after installation, shut off the circuit breaker to eliminate unnecessary power consumption.
  - If the circuit breaker trips to shut off the power to the air conditioner, the system will restore the original operation mode when the circuit breaker is opened again.

### Trial operation from Remote Controller

- (1) Press ON/OFF button to turn on the system.
- (2) Simultaneously press center of TEMP button and MODE buttons.
- (3) Press MODE button twice.  
("T" will appear on the display to indicate that Trial Operation mode is selected.)
- (4) Trial run mode terminates in approx. 30 minutes and switches into normal mode. To quit a trial operation, press ON/OFF button.

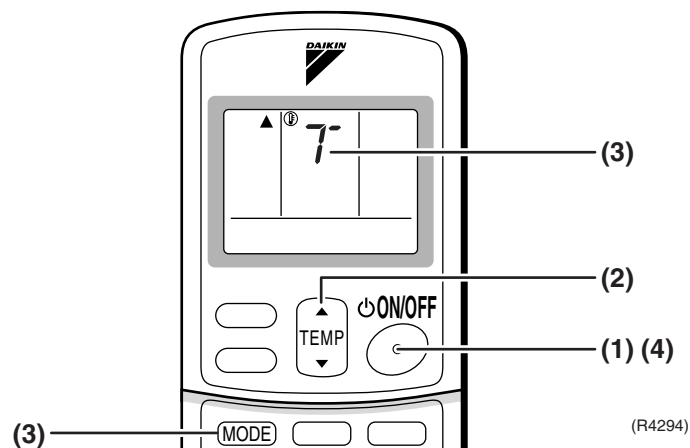

## 1.2 Jumper Settings

### 1.2.1 When Two Units are Installed in One Room

When two indoor units are installed in one room, the two wireless remote controllers can be set for different addresses.

#### How to set the different addresses

- Control PCB of the indoor unit
  - (1) Remove the front grille. (2 screws)
  - (2) Remove the electrical box (1 screw).
  - (3) Remove the electrical box cover. (4 tabs)
  - (4) Cut the address jumper **JA** on the control PCB.
  
- Wireless remote controller
  - (1) Slide the front cover and take it off.
  - (2) Cut the address jumper **J4**.

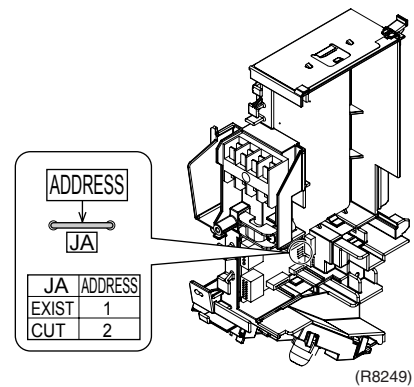
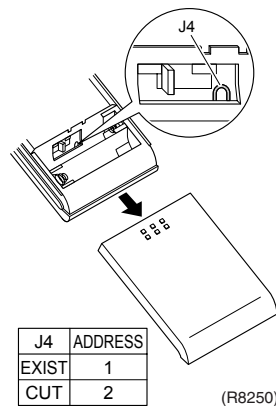

### 1.2.2 Jumper Setting

Jumper (On indoor PCB)	Function	When connected (factory set)	When cut
<b>JC</b>	<b>Power failure recovery function</b>	<b>Auto-restart</b>	Unit does not resume operation after recovering from a power failure. Timer ON-OFF settings are cleared.
<b>JB</b>	Fan speed setting when compressor is OFF on thermostat. (effective only at cooling operation)	<b>Fan speed setting</b> ; Remote controller setting	Fan rpm is set to "0" <Fan stop>



# 1.3 Application of Silicon Grease to a Power Transistor and a Diode Bridge

**Applicable Models**

All outdoor units using inverter type compressor for room air conditioner.

When the printed circuit board of an outdoor unit is replaced, it is required that silicon grease (\*1) is certainly applied to the heat radiation part (the contact point to the heat radiation fin) of the power transistor and diode bridge.

\*1: Parts number of the silicon grease – 1172698 (Drawing number 3FB03758-1)

**Details**

The silicon grease is an essential article for encouraging the heat radiation of the power transistor and the diode bridge. Applying the paste should be implemented in accordance with the following instruction.

Remark: There is the possibility of failure with smoke in case of bad heat radiation.

- To completely wipe off the old silicon grease on a heat radiation fin.
- To evenly apply the silicon grease to the whole.
- Do not have any foreign object such as solder or paper waste between the power transistor, the diode bridge and the heat radiation fin.
- To firmly tighten the screws of the power transistor and the diode bridge, and to surely contact to the heat radiation fin without any gap.

**<Example>**

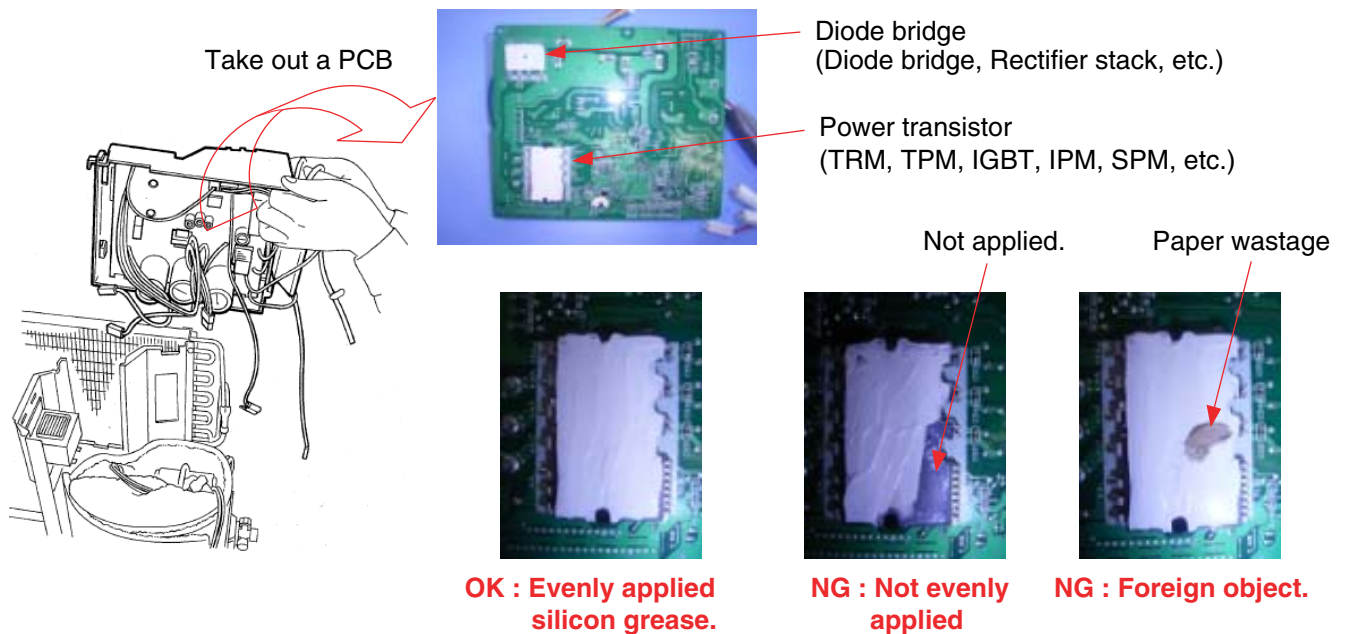

Take out a PCB

Diode bridge (Diode bridge, Rectifier stack, etc.)

Power transistor (TRM, TPM, IGBT, IPM, SPM, etc.)

Not applied.

Paper wastage

**OK : Evenly applied silicon grease.**

**NG : Not evenly applied**

**NG : Foreign object.**

(R7100)

# Part 9 Appendix

1. Piping Diagrams.....	304
1.1 Indoor Units.....	304
1.2 Outdoor Units.....	309
2. Wiring Diagrams.....	311
2.1 Indoor Units.....	311
2.2 Outdoor Units.....	315

# 1. Piping Diagrams

## 1.1 Indoor Units

### 1.1.1 Wall Mounted Type

FTXS20G2V1B, FTXS25G2V1B  
FTXS35G2V1B, FTXS42G2V1B

FTXS50G2V1B

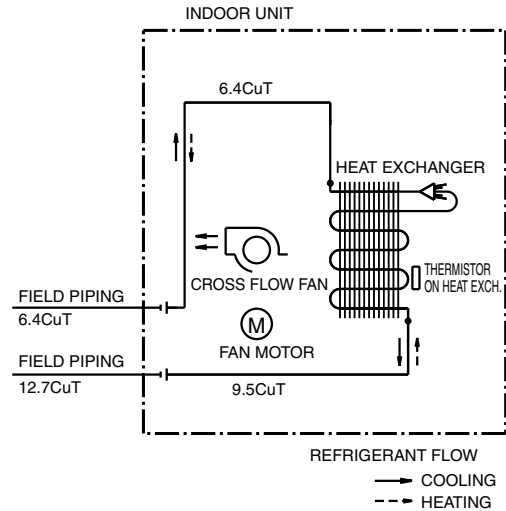
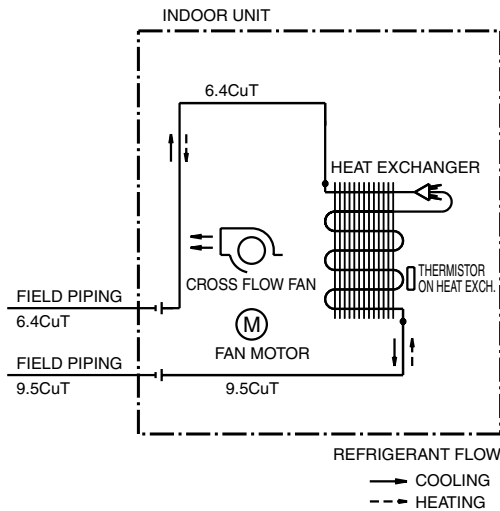

4D058897

4D058898

FTKS60FV1B

FTKS71FV1B

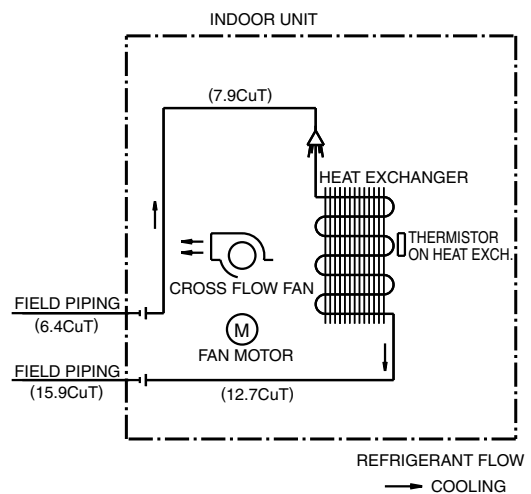
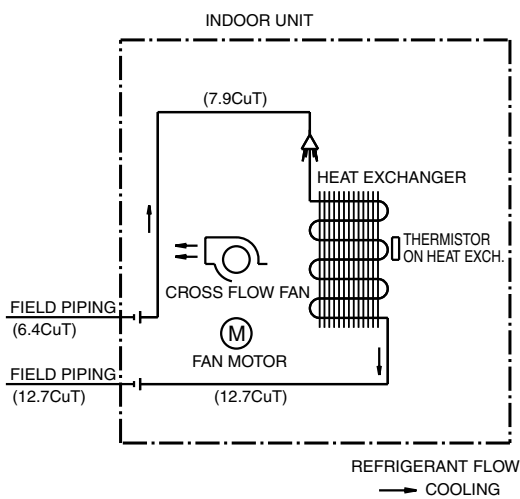

4D054932B

4D050919F

FTXG25EV1BW(S), FTXG35EV1BW(S)

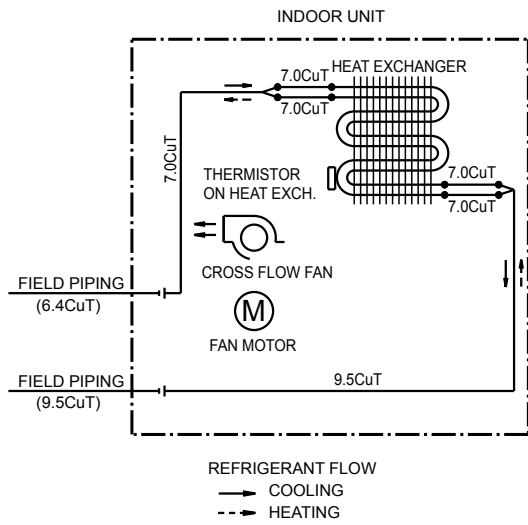

4D045301B

CTXG50EV1BW(S)

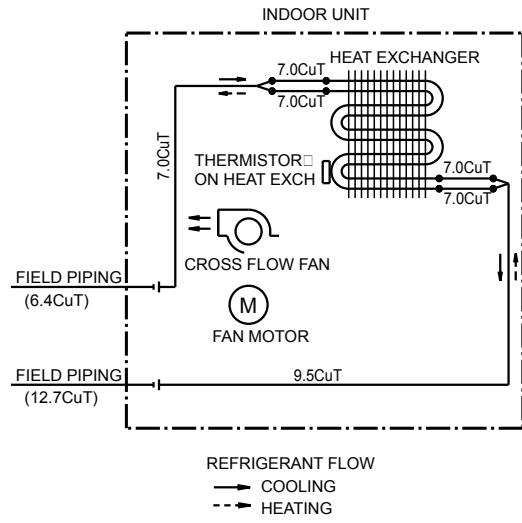

4D050924

FTXS60FV1B

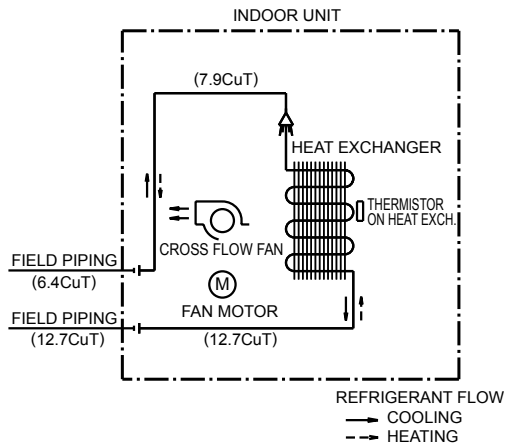

4D040081Q

FTXS71FV1B

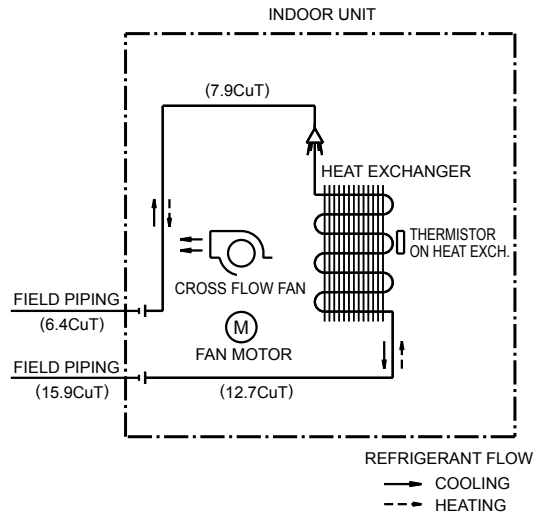

4D040082P

### 1.1.2 Duct Connected Type

**FDKS50CVMB, FDKS60CVMB, FDKS25EAVMB, FDKS35EAVMB  
FDXS50CVMB, FDXS60CVMB, FDXS25EAVMB, FDXS35EAVMB**

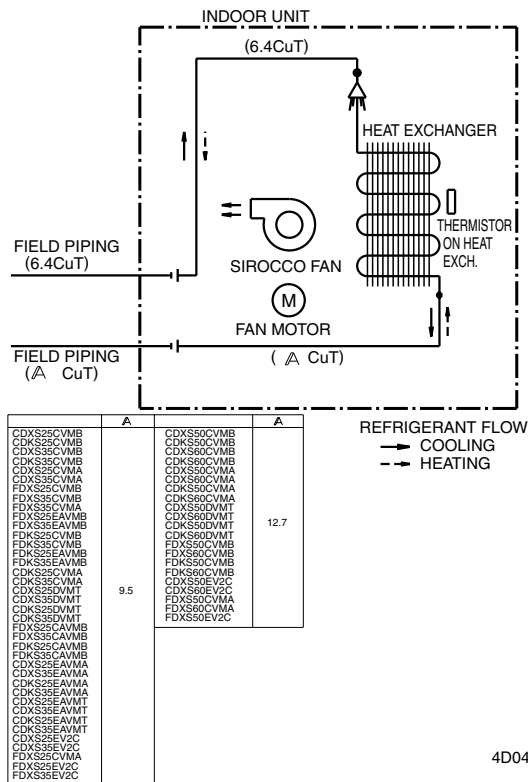

### 1.1.3 Floor / Ceiling Suspended Dual Type

**FLKS25BAVMB, FLKS35BAVMB**

**FLKS50BAVMB, FLKS60BAVMB**

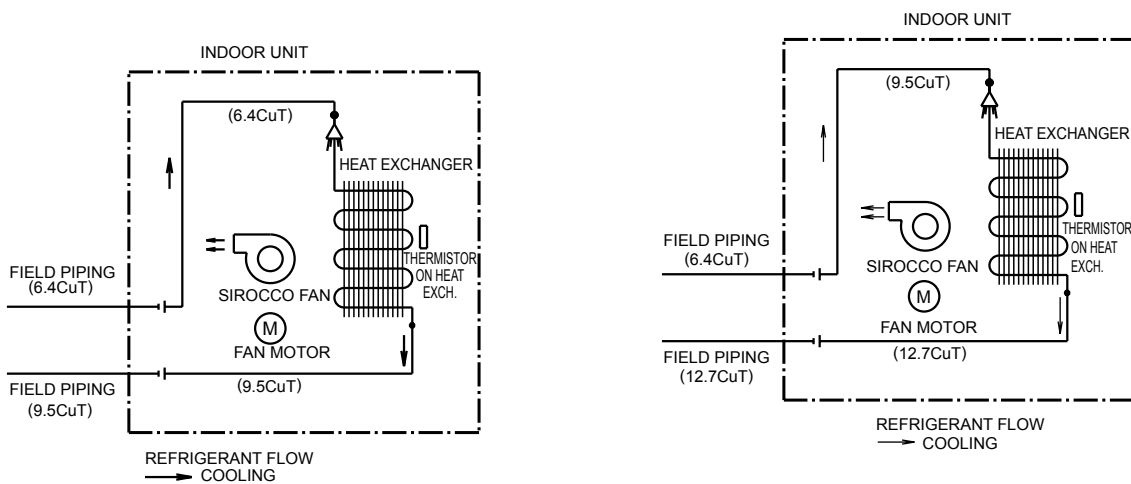

FLXS25BAVMB, FLXS35BAVMB

FLXS50BAVMB, FLXS60BAVMB

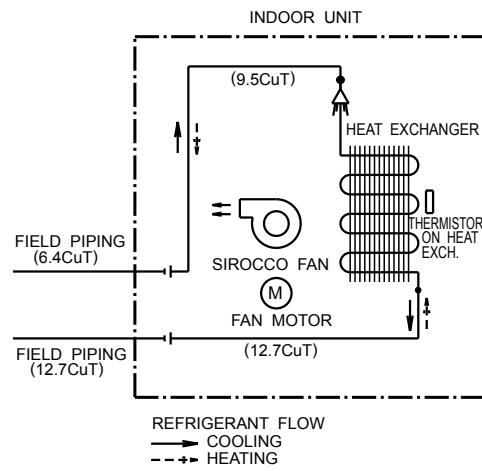
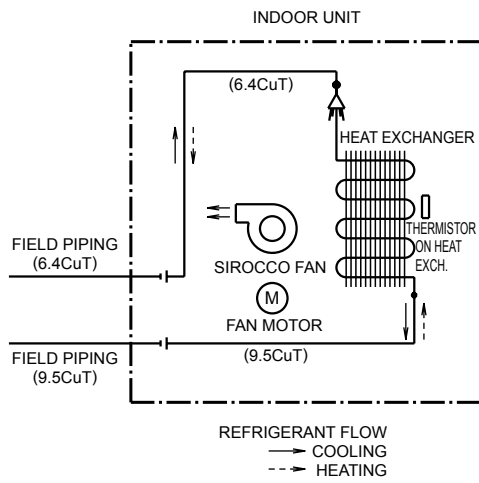

4D048722A

4D048724A

1.1.4 Floor Standing Type

FVXS25FV1B, FVXS35FV1B

FVXS50FV1B

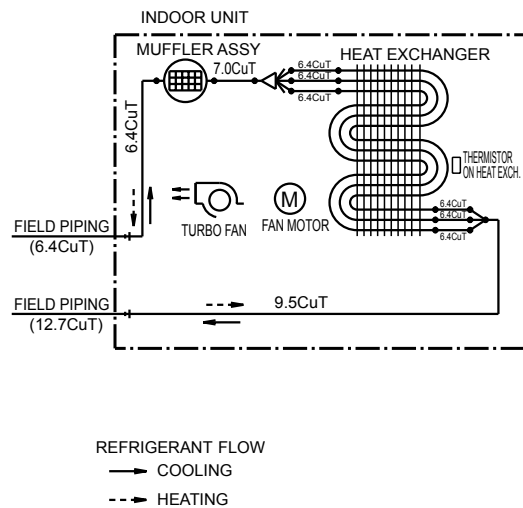
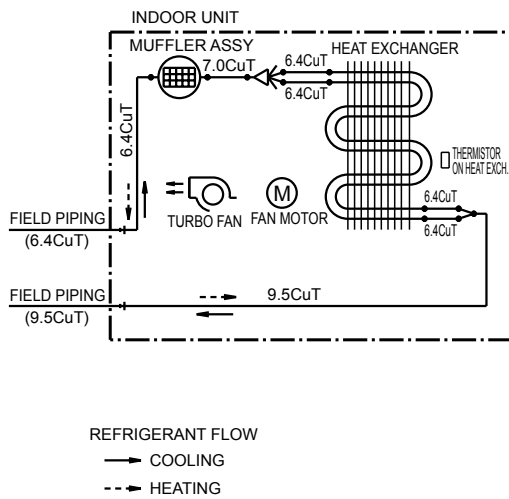

4D056137

4D056138

### 1.1.5 Ceiling Suspended Type

#### FHQ35/50/60BVV1B

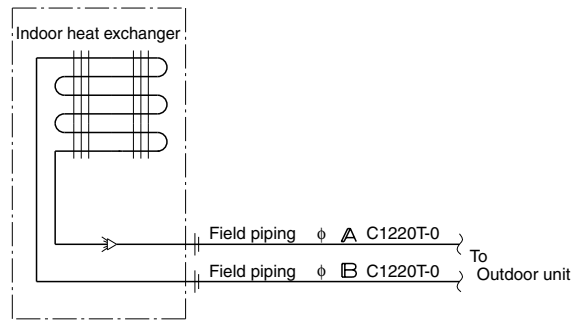

Indoor unit

MODEL	A	B
FHQ35BUV1B FHQ35BVV1B FCQ35BVE FCQ35C7VEB	6.4	9.5
FHQ50, 60BUV1B FHQ50, 60BVV1B FCQ50, 60BVE FBQ60BV1 FBQ60BVL FCQ50, 60C7VEB	6.4	12.7
FUQ71, 100, 125BUV1B FUQ71, 100, 125BVV1B FHQ71, 100, 125BUV1B FHQ71, 100, 125BVV1B FAQ71, 100BUV1B FAQ71, 100BVV1B FXUQ70, 100, 125MV1 FHQ71, 100, 125BAV3B FCQ71, 100, 125, 140DV3B FCQ71, 100, 125, 140DAV3B FCQ71BVE FBQ71BV1 FBQ71BVL FCQ71, 100, 125, 140C7VEB FCQH71, 100, 125, 140C7VEB FVQ71, 100, 125BV1B	9.5	15.9

4D037995H

# 1.2 Outdoor Units

## 1.2.1 Cooling Only

### 4MKS75F2V1B

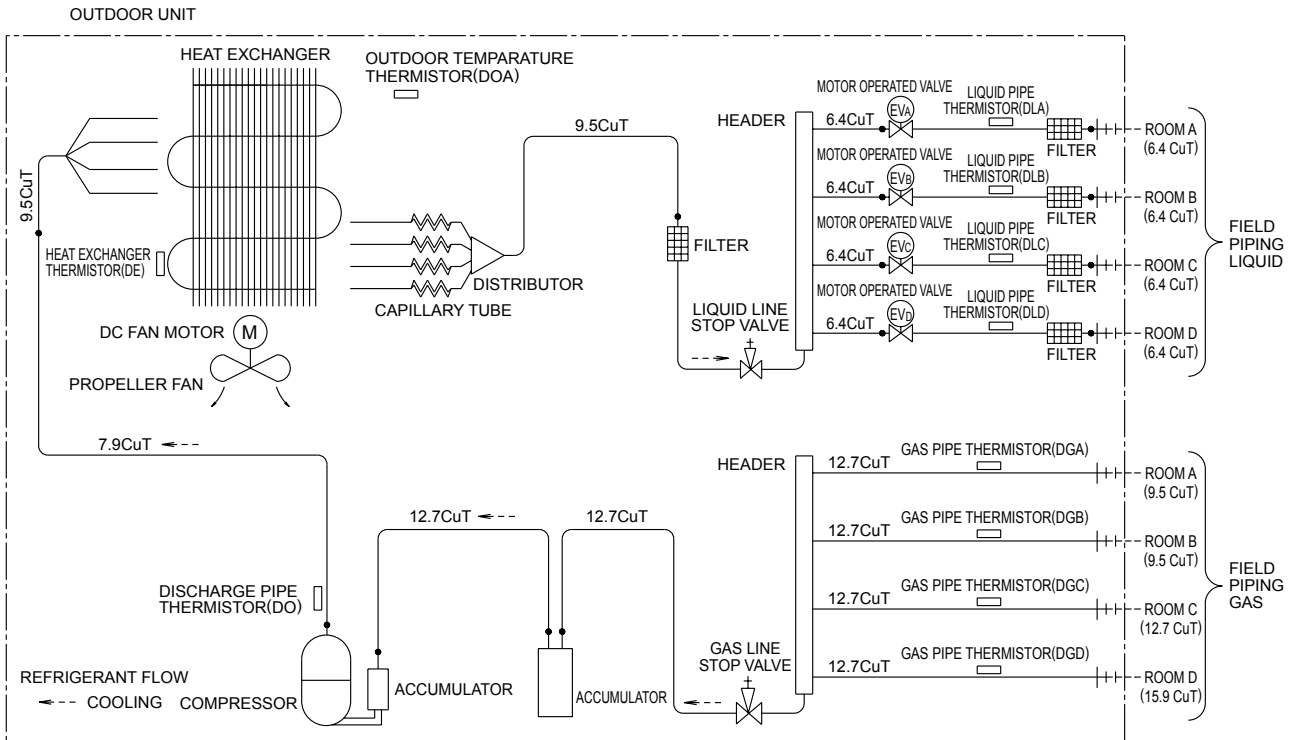

## 1.2.2 Heat Pump

### 3MXS68G2V1B

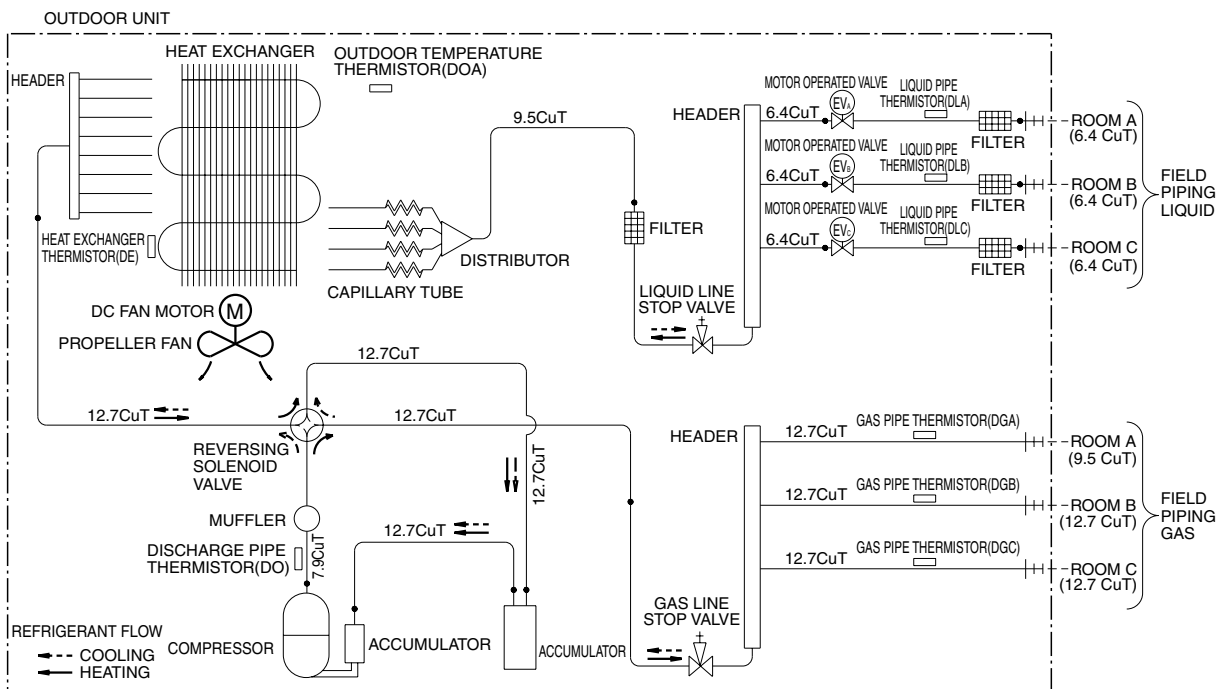



4MXS68F2V1B

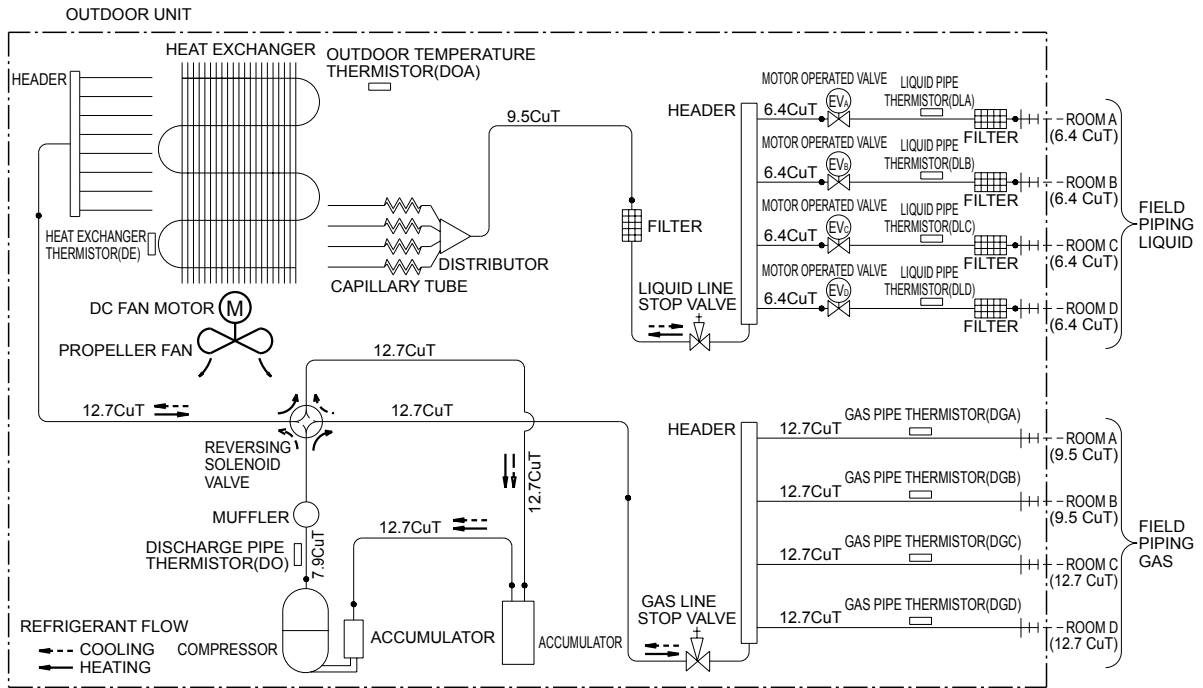

3D055041

## 2. Wiring Diagrams

### 2.1 Indoor Units

#### 2.1.1 Wall Mounted Type

FTXS20G2V1B, FTXS25G2V1B, FTXS35G2V1B, FTXS42G2V1B, FTXS50G2V1B

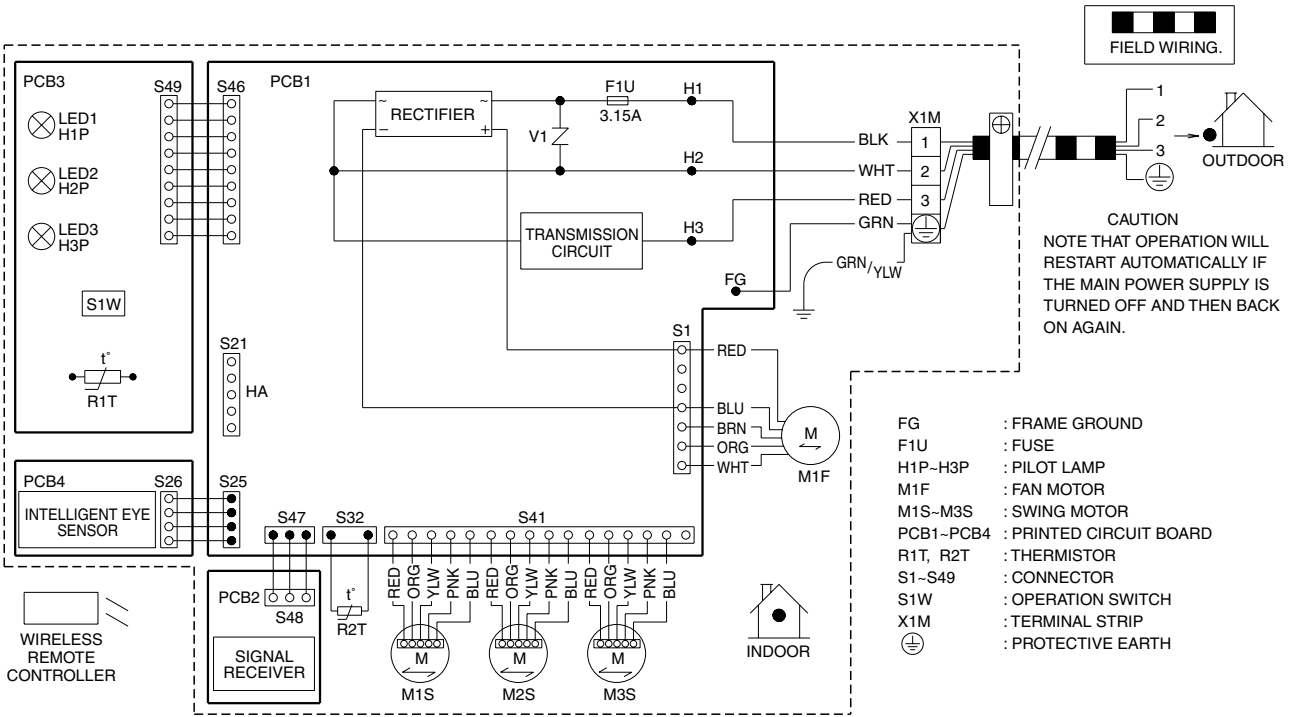

3D058246

FTKS60FV1B, FTKS71FV1B

FTXS60FV1B, FTXS71FV1B

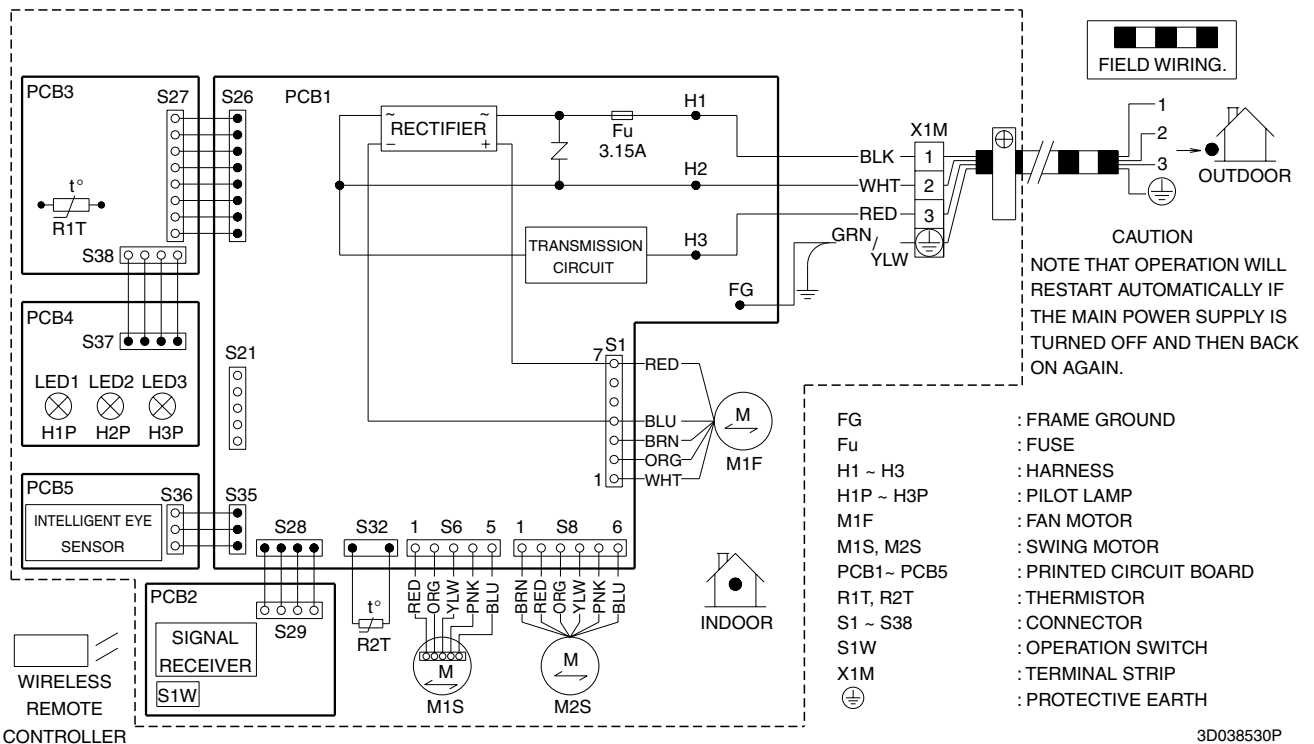

3D038530P

FTXG25EV1BW(S), FTXG35EV1BW(S), CTXG50EV1BW(S)

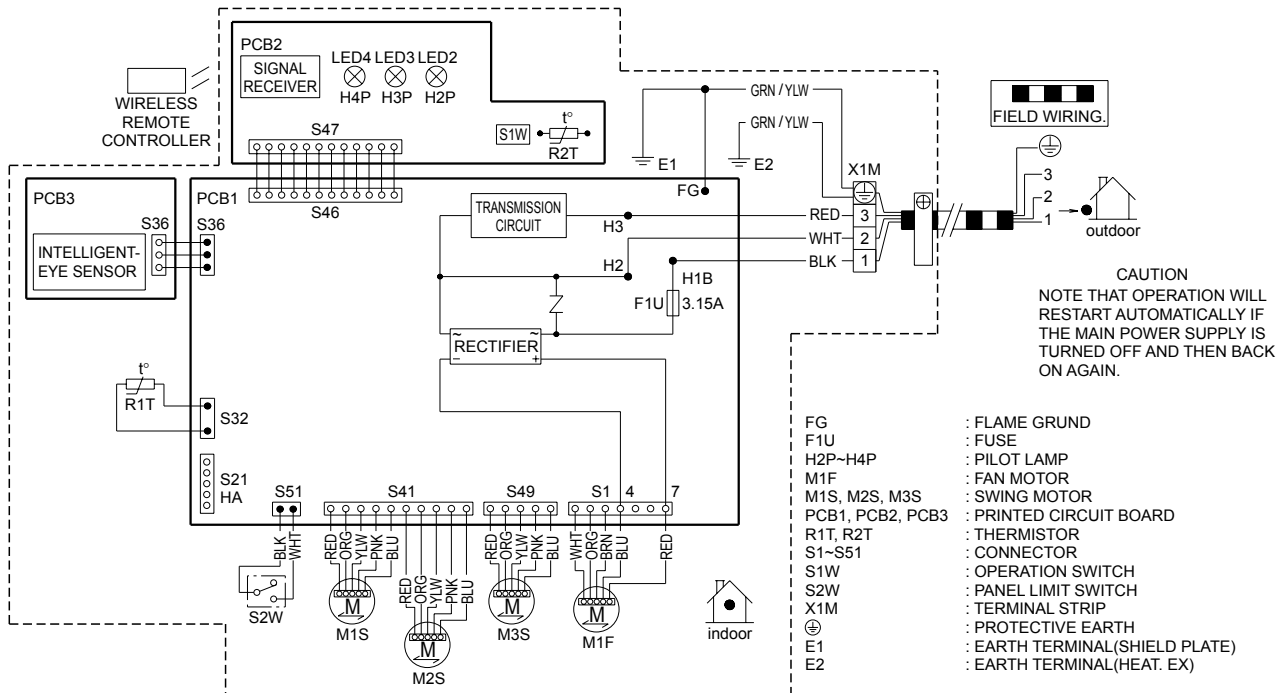

3D050493

2.1.2 Duct Connected Type

FDKS50CVMB, FDKS60CVMB, FDKS25EAVMB, FDKS35EAVMB  
FDXS50CVMB, FDXS60CVMB, FDXS25EAVMB, FDXS35EAVMB

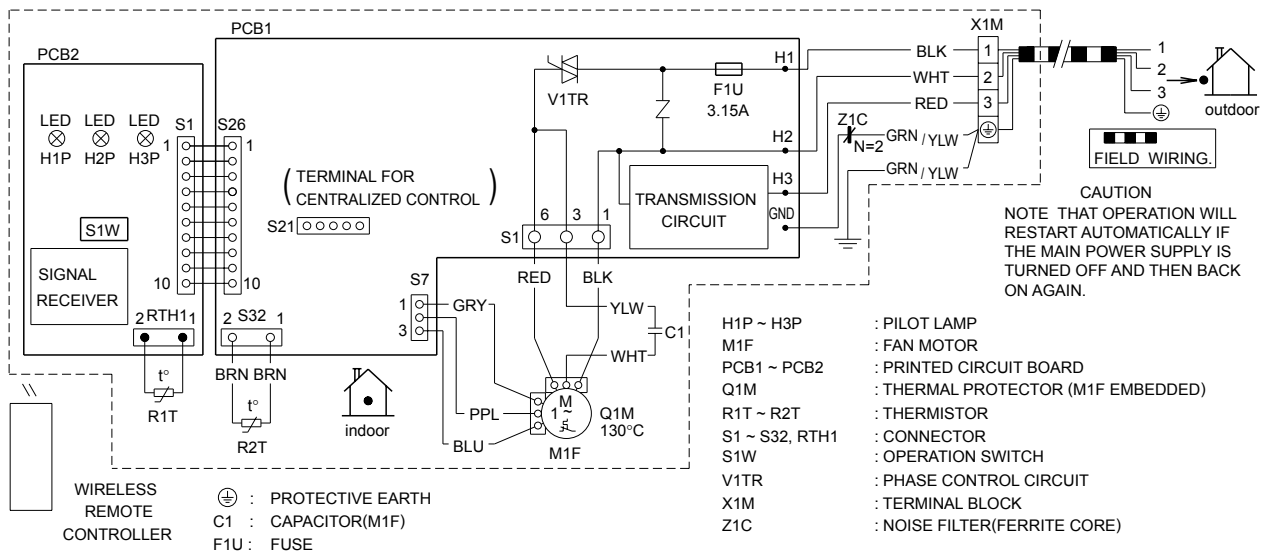

3D045012K

### 2.1.3 Floor / Ceiling Suspended Dual Type

FLKS25BAVMB, FLKS35BAVMB, FLKS50BAVMB, FLKS60BAVMB  
 FLXS25BAVMB, FLXS35BAVMB, FLXS50BAVMB, FLXS60BAVMB

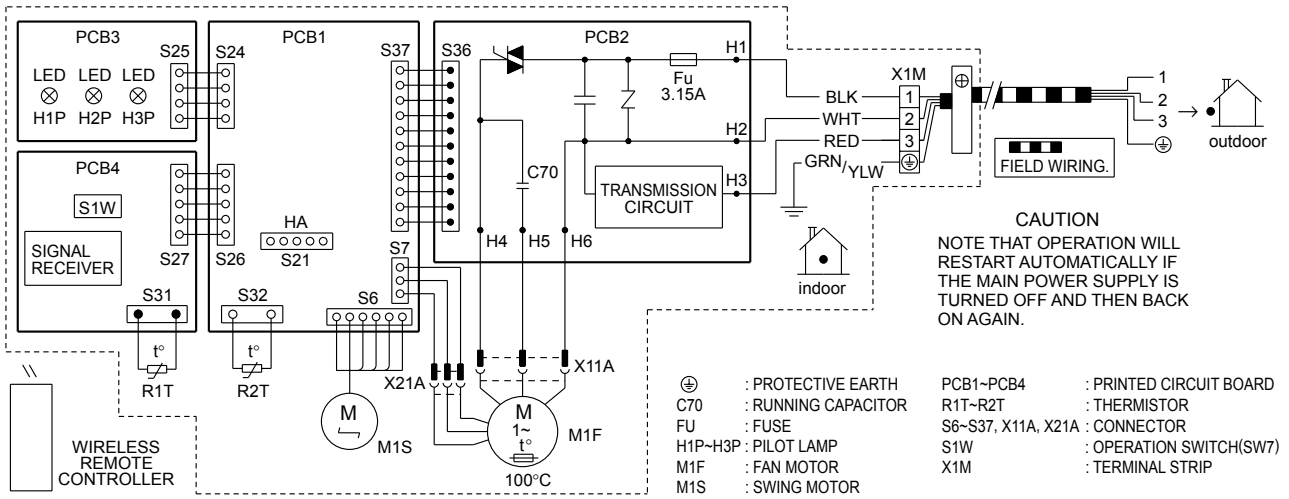

3D033909E

### 2.1.4 Floor Standing Type

FVXS25FV1B, FVXS35FV1B, FVXS50FV1B

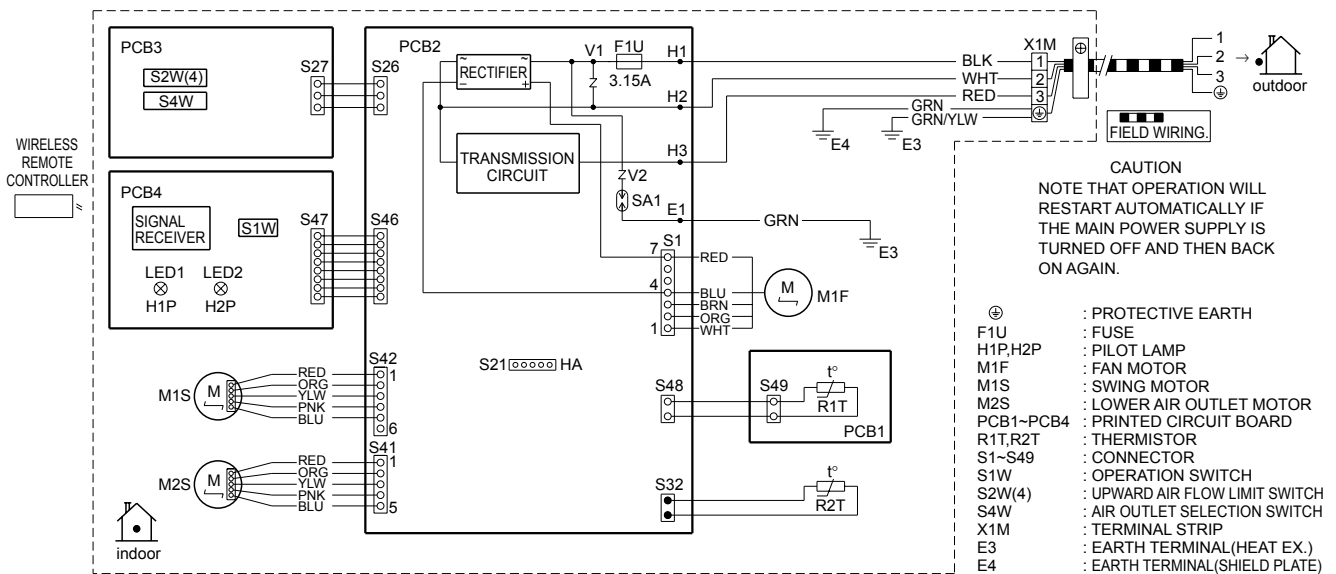

3D055953

## 2.1.5 Ceiling Suspended Type

### FHQ35/50/60BVV1B

A1P	PRINTED CIRCUIT BOARD	BS1	PUSH BUTTON(ON/OFF)
C1	CAPACITOR(MF)	H1P	LIGHT EMITTING DIODE (ON,RED)
F1U	FUSE(F5A 250V)	H2P	LIGHT EMITTING DIODE (TIMER-GREEN)
HAP	LIGHT EMITTING DIODE (SERVICE MONITOR GREEN)	H3P	LIGHT EMITTING DIODE (FILTER SIGN-RED)
KAR	MAGNETIC RELAY(M1S)	H4P	LIGHT EMITTING DIODE (DEFROST-ORANGE)
KPR	MAGNETIC RELAY(M1P)	SS1	SELECTOR SWITCH (MAIN/SUB)
M1F	MOTOR(INDOOR FAN)	SS2	SELECTOR SWITCH (WIRELESS ADDRESS SET)
M1S	MOTOR(SWING FLAP)	CON	CONNECTOR FOR OPTIONAL PARTS
Q1M	THERMO SWITCH(M1F EMBEDDED)	X15A	CONNECTOR(FLOAT SWITCH)
R1T	THERMISTOR(AIR)	X25A	CONNECTOR(DRAIN PUMP)
R2T	THERMISTOR(COIL-1)	X33A	CONNECTOR (ADAPTOR FOR WIRING)
R3T	THERMISTOR(COIL-2)	X35A	CONNECTOR (GROUP CONTROL ADAPTOR)
S1Q	LIMIT SWITCH(SWING FLAP)	X40A	CONNECTOR (ON/OFF INPUT FROM OUTSIDE)
T1R	TRANSFORMER(220-240V/22V)	X60A	CONNECTOR (INTERFACE ADAPTOR FOR SKY AIR SERIES)
V1TR	PHASE CONTROL CIRCUIT	X61A	CONNECTOR (INTERFACE ADAPTOR FOR SKY AIR SERIES)
X1M	TERMINAL BLOCK		
X2M	TERMINAL BLOCK		
(RC)	SIGNAL RECEIVER CIRCUIT		
(TC)	SIGNAL TRANSMISSION CIRCUIT		
WRC	WIRED REMOTE CONTROLLER		
R1T	THERMISTOR(AIR)		
SS1	SELECTOR SWITCH(MAIN/SUB)		
WRRC	WIRELESS REMOTE CONTROLLER (RECEIVER/DISPLAY UNIT)		
A3P	PRINTED CIRCUIT BOARD		
A4P	PRINTED CIRCUIT BOARD		

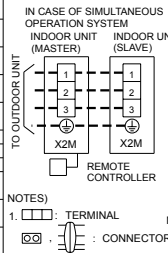
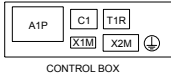

NOTES)  
 1. [Symbol]: TERMINAL  
 [Symbol]: CONNECTOR  
 2. - - : FIELD WIRING

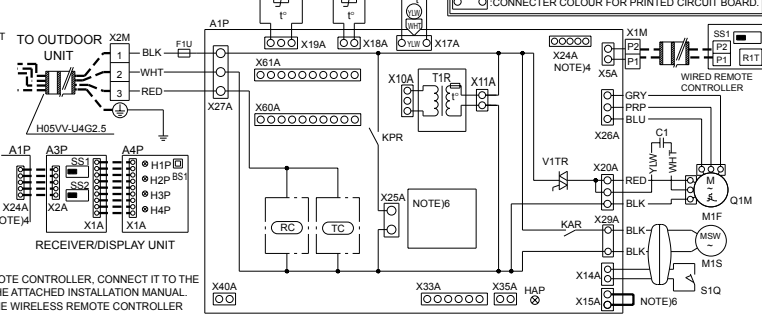

- IN CASE USING CENTRAL REMOTE CONTROLLER, CONNECT IT TO THE UNIT IN ACCORDANCE WITH THE ATTACHED INSTALLATION MANUAL.
- X24A IS CONNECTED WHEN THE WIRELESS REMOTE CONTROLLER KIT IS BEING USED.
- REMOTE CONTROLLER MODEL VARIES ACCORDING TO THE COMBINATION SYSTEM, CONFIRM ENGINEERING MATERIALS AND CATALOGS, ETC. BEFORE CONNECTING.
- IN CASE INSTALLING THE DRAIN PUMP(M1P), REMOVE THE JUMPER CONNECTOR OF X15A AND EXECUTE THE ADDITIONAL WIRING FOR FLOAT SWITCH AND DRAIN PUMP.
- SYMBOLS SHOW AS FOLLOWS: RED:RED BLK:BLACK WHT:WHITE YLW:YELLOW PRP:PURPLE GRY:GRAY BLU:BLUE

3D037842D

## 2.2 Outdoor Units

### 2.2.1 Cooling Only

#### 4MKS75F2V1B

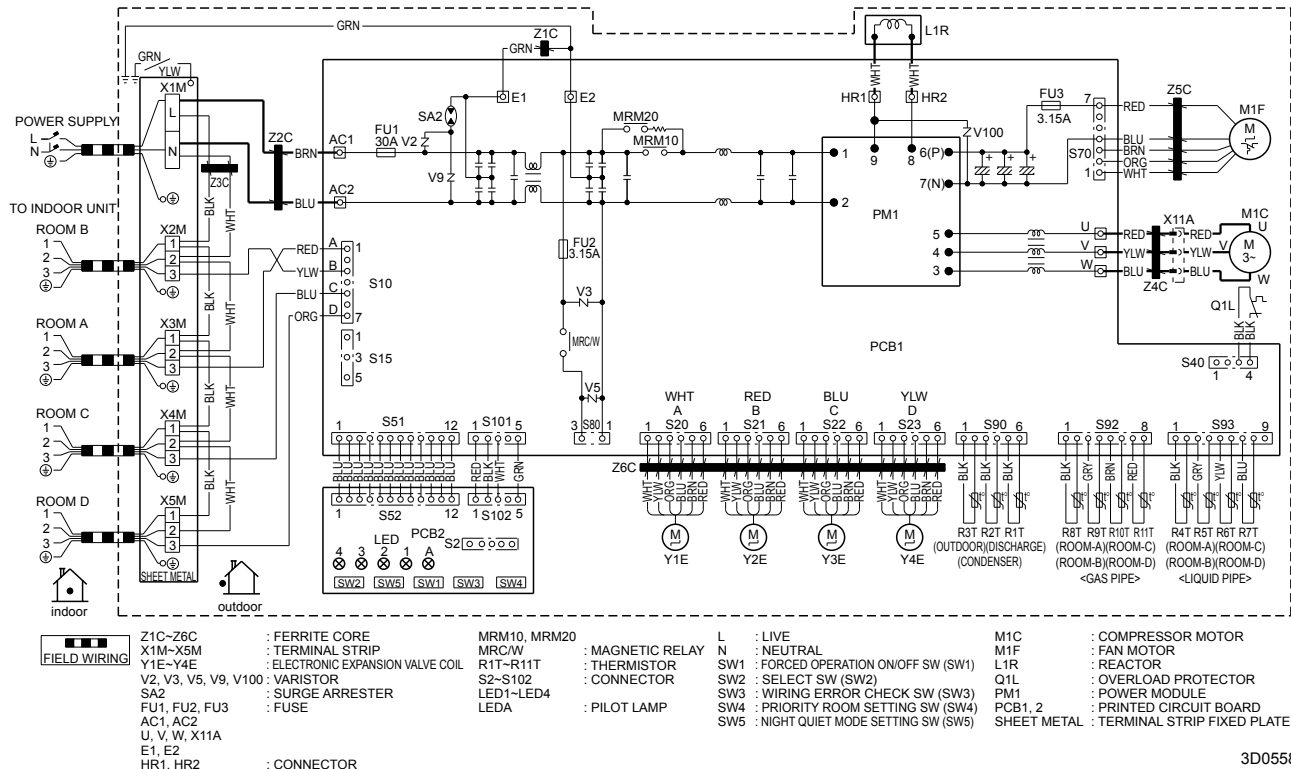

### 2.2.2 Heat Pump

#### 3MXS68G2V1B

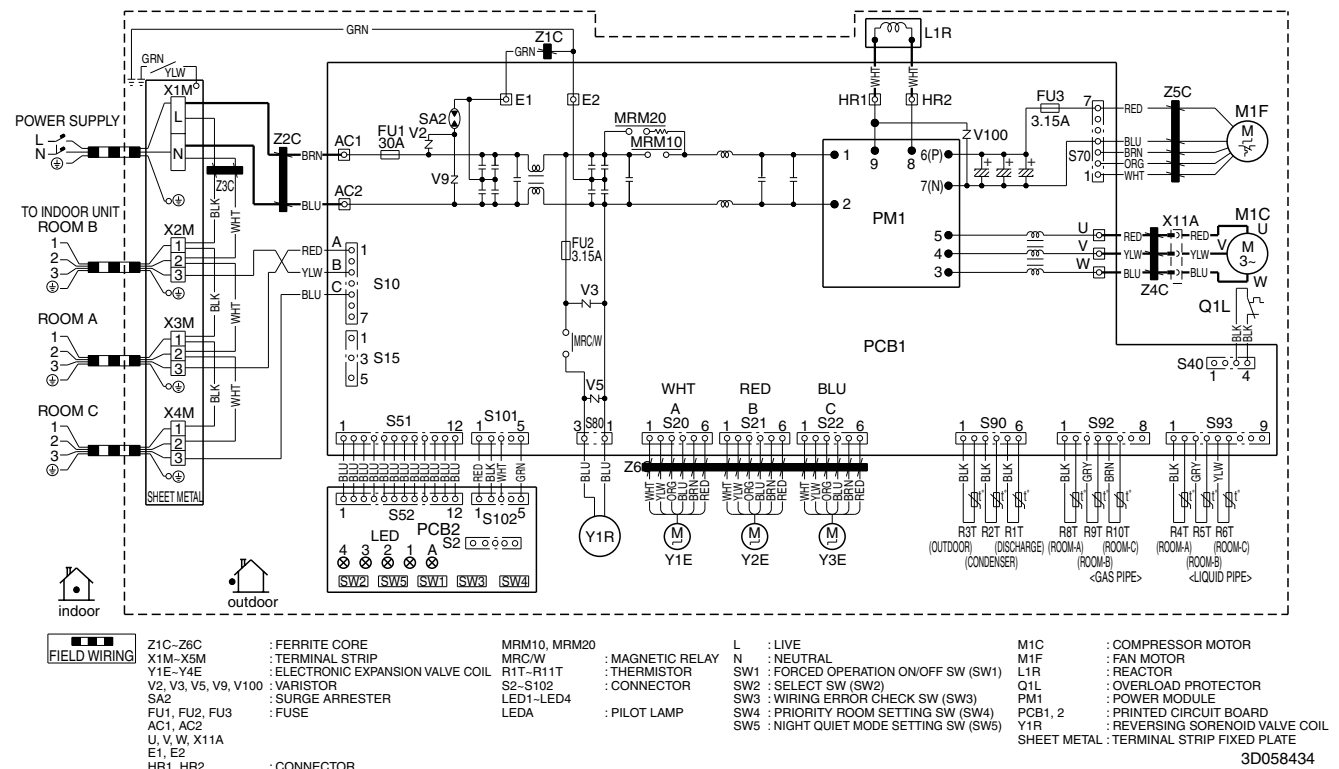

4MXS68F2V1B

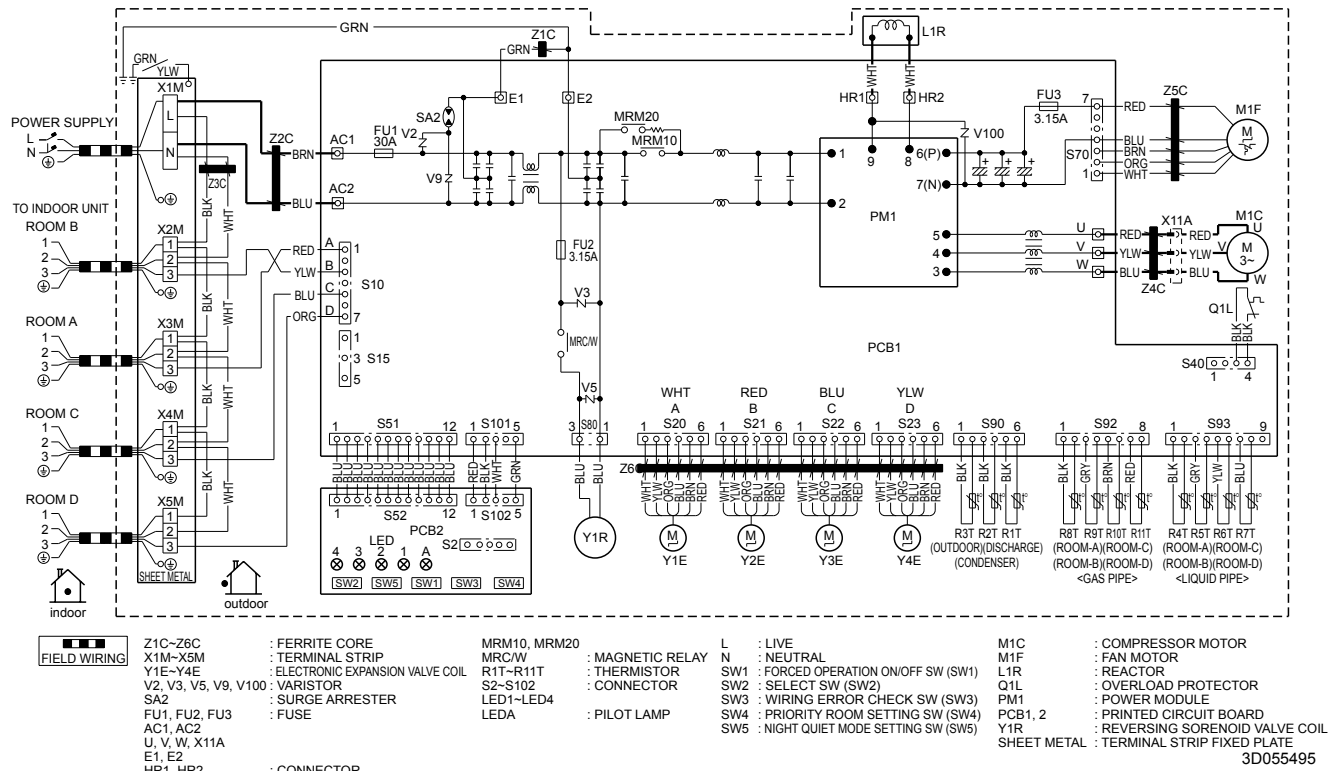

# Index

## Numerics

3-D airflow .....	54
3-minute standby.....	80

## A

A1 .....	216
A5.....	217, 227
A6.....	219, 220
AC1 .....	47
AC2 .....	47
address setting jumper.....	32, 34, 36, 38, 40, 43
adjusting the airflow direction.....	119, 163
air-purifying filter.....	70
anti-icing function in other rooms .....	255
ARC433.....	209
ARC452.....	210
AUTO · DRY · COOL · HEAT · FAN operation .....	117, 161
automatic airflow control .....	57
automatic operation.....	59
auto-restart.....	32, 36, 70, 301

## B

buzzer PCB .....	35
------------------	----

## C

C4.....	222
C7.....	223
C9.....	222
capacitor voltage check.....	263
care and cleaning.....	135, 182
centralized control .....	32, 34, 36, 38, 40
check	
capacitor voltage check .....	263
discharge pressure check.....	261
electronic expansion valve check .....	257
fan motor connector output check .....	256
four way valve performance check .....	258
hall ic check .....	265
installation condition check.....	260
inverter units refrigerant system check.....	262
limit switch continuity check.....	256
main circuit electrolytic capacitor check.....	264
outdoor unit fan system check (with DC motor) .....	261
power supply waveforms check.....	262
power transistor check.....	263
thermistor resistance check.....	259
turning speed pulse input on the outdoor unit PCB check .....	264
check No.01 .....	256
check No.02 .....	256
check No.03 .....	256
check No.04 .....	257
check No.05 .....	258

check No.06 .....	259
check No.07 .....	260
check No.08 .....	261
check No.09 .....	261
check No.10 .....	262
check No.11 .....	262
check No.12 .....	263
check No.13 .....	263
check No.14 .....	264
check No.15 .....	264
check No.16 .....	265
comfort airflow and INTELLIGENT EYE operation .....	167
comfort airflow mode.....	54
compressor .....	297
compressor lock.....	231
compressor overload.....	230
compressor protection function .....	81
compressor sensor system abnormality.....	238
connectors.....	32, 34, 36, 38, 40, 43, 47
control PCB.....	38, 281
control PCB (indoor unit).....	33, 35, 37, 41, 44
cooling / heating mode lock.....	95
CT or related abnormality.....	241

## D

DC fan lock.....	232
defrost control .....	85
diagnosis mode .....	211
diode bridge .....	302
discharge grille .....	271
discharge pipe control.....	82
discharge pipe temperature control.....	235
discharge pipe thermistor.....	72, 74, 89, 294
discharge pressure check .....	261
display PCB.....	33, 35, 39, 42, 44
distributor .....	295

## E

E1 .....	229
E5.....	230
E6.....	231
E7.....	232
E8.....	233
ECONO mode .....	62
ECONO operation .....	172
ECONO-mode-proof setting.....	95
electrical box .....	272
electrical box temperature rise .....	245
electronic expansion valve check.....	257
electronic expansion valve coil.....	292
electronic expansion valve control .....	86
error codes	
A1 .....	216
A5 .....	217, 227



A6 .....	219, 220
C4 .....	222
C7 .....	223
C9 .....	222
E1 .....	229
E5 .....	230
E6 .....	231
E7 .....	232
E8 .....	233
F3 .....	235
F6 .....	236
H0 .....	238
H6 .....	240
H8 .....	241
H9 .....	243
J3 .....	243
J6 .....	243
J8 .....	243
J9 .....	243
L3 .....	245
L4 .....	247
L5 .....	249
P4 .....	243
U0 .....	251
U2 .....	253
U4 .....	224
U7 .....	254
UA .....	226, 255
UH .....	255
error codes and description of fault.....	213
<b>F</b>	
F3 .....	235
F6 .....	236
fan control .....	84
fan motor .....	286
fan motor connector output check.....	256
fan motor or related abnormality	
AC motor .....	219
DC motor .....	220
fan speed control.....	57
fan speed setting.....	32, 34, 36, 38, 40, 43, 301
filter	
air-purifying filter .....	70
mold proof air filter (prefilter).....	70
photocatalytic deodorizing filter .....	70
titanium apatite photocatalytic air-purifying filter	
.....	70
forced operation mode .....	91
forced operation ON/OFF switch	
.....	32, 34, 36, 38, 40, 43, 47
four way valve .....	296
four way valve coil.....	292
four way valve operation compensation.....	80
four way valve performance check.....	258
four way valve switching .....	80
freeze-up protection control .....	83, 217, 227
frequency control.....	77
frequency principle .....	52
front panel .....	269
front panel mechanism.....	36, 223
front panel open/close fault .....	223
FU1 .....	32, 34, 36, 38, 40, 43, 47
FU2 .....	47
FU3 .....	47
function of thermistor.....	72
functions .....	2
fuse .....	32, 34, 36, 38, 40, 43, 47
<b>G</b>	
gas pipe isothermal control during cooling.....	88
gas pipe thermistor.....	72, 74, 293
<b>H</b>	
H0.....	238
H6.....	240
H8.....	241
H9.....	243
HA .....	32, 34, 36
Hall IC .....	57, 219, 220
Hall IC check .....	265
hap .....	45
heat exchanger thermistor .....	293
heating peak-cut control.....	83
high pressure control.....	217
high pressure control in cooling .....	236
high temperature of the discharge pipe.....	89
HOME LEAVE operation.....	67, 127
hot-start function .....	69
HR1 .....	47
HR2.....	47
<b>I</b>	
indoor heat exchanger thermistor .....	73, 75
indoor unit PCB abnormality .....	216
input current control .....	82
input over current detection.....	233
installation condition check .....	260
instruction .....	99
instruction FHQ series.....	191
insufficient gas .....	251
insufficient gas control.....	90
INTELLIGENT EYE .....	63, 65
INTELLIGENT EYE operation.....	129
INTELLIGENT EYE PCB .....	33, 35, 37
inverter POWERFUL operation.....	68
inverter principle.....	52
inverter units refrigerant system check.....	262
<b>J</b>	
J3 .....	243
J4 .....	301
J6 .....	243
J8 .....	243
J9 .....	243
JA .....	32, 34, 36, 38, 40, 43, 301
JB .....	32, 34, 36, 38, 40, 43, 301
JC.....	32, 34, 36, 38, 40, 43, 301
jumper setting.....	301
<b>L</b>	
L3 .....	245

L4 .....	247
L5 .....	249
LED A.....	32, 34, 36, 38, 40, 43, 47
LED1 .....	32, 34, 38, 40, 43, 47
LED2 .....	32, 34, 36, 38, 40, 43, 47
LED3 .....	32, 34, 36, 38, 40, 47
LED4 .....	36, 47
limit switch.....	36, 223
limit switch continuity check .....	256
liquid compression protection function 2 .....	84
liquid pipe thermistor .....	73, 293
low-voltage detection .....	253
<b>M</b>	
main circuit electrolytic capacitor check .....	264
main PCB (outdoor unit).....	48
main structural parts.....	71
mode hierarchy .....	76
mold proof air filter (prefilter) .....	70
motor	
reduction motor.....	36
<b>N</b>	
names of parts .....	102, 152
NIGHT SET mode.....	61
note for multi system .....	133, 180
<b>O</b>	
oil recovery function .....	89
OL activation .....	230
ON/OFF button on indoor unit.....	69
opening limit.....	88
operation lamp .....	206
operation starting control.....	56
outdoor air thermistor .....	278, 293
outdoor heat exchanger thermistor .....	72, 74
outdoor unit fan system check (with DC motor) ....	261
outdoor unit PCB abnormality .....	229
OUTDOOR UNIT QUIET operation .....	126, 171
output over current detection .....	249
over current.....	90
overload .....	90
over-voltage detection.....	253
<b>P</b>	
P4.....	243
PCB (ceiling suspended type).....	46
photocatalytic deodorizing filter.....	70
PI control .....	78
piping diagrams.....	304
position sensor abnormality .....	240
power failure recovery function	
.....	32, 34, 36, 38, 40, 43, 301
power supply PCB.....	41
power supply waveforms check .....	262
power transistor.....	302
power transistor check .....	263
power-airflow dual flaps .....	54
POWERFUL operation.....	125, 170
POWERFUL operation mode.....	94
preheating operation .....	80
preparation before operation.....	114, 158
pressure equalization control .....	88
preventing indoor freezing.....	91
printed circuit board (PCB)	
buzzer PCB.....	35
ceiling suspended type .....	46
control PCB.....	38, 281
control PCB (indoor unit) .....	33, 35, 37, 41, 44
display PCB .....	33, 35, 39, 42, 44
INTELLIGENT EYE PCB .....	33, 35, 37
main PCB (outdoor unit) .....	48
power supply PCB .....	41
removal procedure.....	280
sensor PCB.....	44
service monitor PCB.....	49
service PCB .....	44, 280
signal receiver PCB .....	33, 35, 37, 42
priority room setting.....	94
problem symptoms and measures .....	208
programme dry function .....	58
propeller fan .....	286
<b>R</b>	
radiation fin temperature rise .....	247
reduction motor .....	36, 223
removal procedure	
compressor .....	297
distributor .....	295
electrical box.....	272
electronic expansion valve coil .....	292
fan motor.....	286
four way valve .....	296
four way valve coil .....	292
panels and plates.....	268
PCB .....	280
propeller fan.....	286
sound blanket .....	288
thermistor.....	292
right side panel.....	288
RTH1 .....	32, 34, 36, 38
<b>S</b>	
S1.....	32, 34, 36, 38, 43
S10.....	47
S101.....	47
S102.....	47, 280
S15.....	47
S20.....	47, 274
S21.....	32, 34, 36, 38, 40, 43, 47, 274
S22.....	47, 274
S23.....	47, 274
S24.....	40
S25.....	32, 40
S26.....	32, 34, 38, 40, 43
S27.....	34, 40, 43
S28.....	34
S29.....	34
S31.....	40
S32.....	32, 34, 36, 38, 40
S35.....	34
S36.....	34, 36, 40

S37.....	34, 40
S38.....	34
S40.....	47, 275
S41.....	32, 36, 43
S42.....	43
S46.....	32, 36, 43
S47.....	32, 36, 43
S48.....	32, 43
S49.....	32, 36, 43
S51.....	36, 47
S52.....	47, 280
S6.....	34, 40
S7.....	38, 40
S70.....	47, 273
S8.....	34
S80.....	47, 276
S90.....	47, 276, 293
S92.....	47, 276, 293
S93.....	47, 276, 293
safety precautions.....	100, 150
SC control.....	88
self-diagnosis digital display.....	70
sensor malfunction detection.....	90
sensor PCB.....	44
service check function.....	209
service monitor PCB.....	49
service PCB.....	44, 280
signal receiver PCB.....	33, 35, 37, 42
signal receiving sign.....	69
signal transmission error.....	224
signal transmission error (on outdoor unit PCB).....	254
silicon grease.....	302
sound blanket.....	288
specifications.....	14
starting operation control.....	88
stop valve cover.....	271
SW1.....	32, 34, 36, 38, 40, 43, 47
SW2.....	40, 43, 47
SW3.....	47
SW4.....	43, 47
SW5.....	47
<b>T</b>	
target discharge pipe temperature control.....	89
terminal board.....	284
test run from the remote controller.....	300
thermistor	
discharge pipe thermistor.....	72, 74, 89, 294
gas pipe thermistor.....	72, 74, 293
heat exchanger thermistor.....	293
indoor heat exchanger thermistor.....	73, 75
liquid pipe thermistor.....	73, 293
outdoor air thermistor.....	278, 293
outdoor heat exchanger thermistor.....	72, 74
thermistor or related abnormality (indoor unit).....	222
thermistor or related abnormality (outdoor unit).....	243
thermistor resistance check.....	259
thermostat control.....	60
TIMER operation.....	131, 173
titanium apatite photocatalytic air-purifying filter.....	70
top panel.....	268
troubleshooting.....	146, 188
indoor units.....	214
outdoor units.....	215
troubleshooting with the LED indication.....	207
troubleshooting with the operation lamp.....	206
turning speed pulse input on the outdoor unit PCB	
check.....	264
<b>U</b>	
U0.....	251
U2.....	253
U4.....	224
U7.....	254
UA.....	226, 255
UH.....	255
unspecified voltage	
(between indoor and outdoor units).....	226, 255
<b>V</b>	
V1.....	32, 34, 36, 38, 40, 43
V100.....	47
V2.....	47
V3.....	47
V5.....	47
V9.....	47
varistor.....	32, 34, 36, 38, 40, 43, 47
<b>W</b>	
WEEKLY TIMER operation.....	70, 175
wide-angle louvers.....	54
wiring diagrams.....	311
wiring-error check.....	92
<b>X</b>	
X14A.....	45
X15A.....	45
X17A.....	45
X18A.....	45
X19A.....	45
X20A.....	45
X24A.....	45
X25A.....	45
X26A.....	45
X27A.....	45
X29A.....	45
X33A.....	45
X35A.....	45
X40A.....	45
X5A.....	45
X60A.....	45
X61A.....	45

# Drawings & Flow Charts

## Numerics

3-D airflow .....54

## A

anti-icing function in other rooms .....255  
 automatic airflow control .....57  
 automatic operation .....59  
 auto-swing .....54

## B

buzzer PCB .....35

## C

capacitor voltage check .....263  
 check No.01 .....256  
 check No.02 .....256  
 check No.03 .....256  
 check No.04 .....257  
 check No.05 .....258  
 check No.06 .....259  
 check No.07 .....260  
 check No.08 .....261  
 check No.09 .....261  
 check No.10 .....262  
 check No.11 .....262  
 check No.12 .....263  
 check No.13 .....263  
 check No.14 .....264  
 check No.15 .....264  
 check No.16 .....265  
 comfort airflow mode .....54  
 compressor lock .....231  
 compressor overload .....230  
 compressor protection function .....81  
 compressor sensor system abnormality .....238  
 control PCB (indoor unit) .....33, 35, 37, 38, 41, 44  
 cooling / heating mode lock .....95  
 CT or related abnormality .....241

## D

DC fan lock .....232  
 defrost control .....85  
 diagnosis mode .....211  
 diode bridge .....302  
 discharge pipe control .....82  
 discharge pipe temperature control .....235  
 discharge pressure check .....261  
 display PCB .....33, 35, 39, 42, 44

## E

ECONO mode .....62  
 electrical box temperature rise .....245  
 electronic expansion valve check .....257  
 electronic expansion valve control .....86

## F

fan motor connector output check .....256  
 fan motor or related abnormality  
     AC motor .....219  
     DC motor .....220  
 four way valve performance check .....258  
 freeze-up protection control .....83, 217, 227  
 frequency control .....77  
 frequency principle .....52  
 front panel open/close fault .....223  
 function of thermistor  
     cooling only model .....74  
     heat pump model .....72

## H

Hall IC check .....265  
 heating peak-cut control .....83  
 high pressure control .....217  
 high pressure control in cooling .....236  
 Home Leave operation .....67

## I

indoor unit PCB abnormality .....216  
 input current control .....82  
 input over current detection .....233  
 installation condition check .....260  
 insufficient gas .....251  
 insufficient gas control .....90  
 INTELLIGENT EYE .....63, 65  
 INTELLIGENT EYE PCB .....33, 35, 37  
 inverter features .....53  
 inverter POWERFUL operation .....68  
 inverter units refrigerant system check .....262

## J

jumper settings .....301

## L

limit switch continuity check .....256  
 location of operation lamp .....206  
 low-voltage detection .....253

## M

main circuit electrolytic capacitor check .....264  
 main PCB (outdoor unit) .....48  
 main structural parts .....71  
 mode hierarchy .....76

## N

NIGHT SET mode .....61

## O

OL activation .....230  
 ON/OFF button on indoor unit .....69  
 outdoor unit fan system check (with DC motor) ..261

outdoor unit PCB abnormality .....	229
output over current detection .....	249
over-voltage detection .....	253

**P**

PCB (ceiling suspended type) .....	46
piping diagrams	
3MXS68G2V1B .....	309
4MKS75F2V1B .....	309
4MXS68F2V1B .....	310
CTXG50EV1BW(S) .....	305
FDKS25EAVMB .....	306
FDKS35EAVMB .....	306
FDKS50CVMB .....	306
FDKS60CVMB .....	306
FDXS25EAVMB .....	306
FDXS35EAVMB .....	306
FDXS50CVMB .....	306
FDXS60CVMB .....	306
FHQ35/50/60BVV1B .....	308
FLKS25BAVMB .....	306
FLKS35BAVMB .....	306
FLKS50BAVMB .....	306
FLKS60BAVMB .....	306
FLXS25BAVMB .....	307
FLXS35BAVMB .....	307
FLXS50BAVMB .....	307
FLXS60BAVMB .....	307
FTKS60FV1B .....	304
FTKS71FV1B .....	304
FTXG25EV1BW(S) .....	305
FTXG35EV1BW(S) .....	305
FTXS20G2V1B .....	304
FTXS25G2V1B .....	304
FTXS35G2V1B .....	304
FTXS42G2V1B .....	304
FTXS50G2V1B .....	304
FTXS60FV1B .....	305
FTXS71FV1B .....	305
FVXS25FV1B .....	307
FVXS35FV1B .....	307
FVXS50FV1B .....	307
position sensor abnormality .....	240
power supply PCB .....	41
power supply waveforms check .....	262
power transistor .....	302
power transistor check .....	263
priority room setting .....	94
programme dry function .....	58

**R**

radiation fin temperature rise .....	247
remote controller .....	209, 210

**S**

sensor PCB .....	44
service monitor PCB .....	49
service PCB .....	44
signal receiver PCB .....	33, 35, 37, 42
signal transmission error .....	224
signal transmission error (on outdoor unit PCB) ..	254

silicon grease .....	302
starting control flow .....	56
starting timing chart .....	56

**T**

target discharge pipe temperature control .....	89
test operation from remote controller .....	300
thermistor or related abnormality (indoor unit) ....	222
thermistor or related abnormality (outdoor unit) ..	243
thermistor resistance check .....	259
thermostat control .....	60
troubleshooting with the LED indication .....	207
turning speed pulse input on the outdoor unit PCB check .....	264

**U**

unspecified voltage (between indoor and outdoor units) .....	226, 255
---	----------

**W**

wiring diagrams	
3MXS68G2V1B .....	315
4MKS75F2V1B .....	315
4MXS68F2V1B .....	316
CTXG50EV1BW(S) .....	312
FDKS25EAVMB .....	312
FDKS35EAVMB .....	312
FDKS50CVMB .....	312
FDKS60CVMB .....	312
FDXS25EAVMB .....	312
FDXS35EAVMB .....	312
FDXS50CVMB .....	312
FDXS60CVMB .....	312
FHQ35/50/60BVV1B .....	314
FLKS25BAVMB .....	313
FLKS35BAVMB .....	313
FLKS50BAVMB .....	313
FLKS60BAVMB .....	313
FLXS25BAVMB .....	313
FLXS35BAVMB .....	313
FLXS50BAVMB .....	313
FLXS60BAVMB .....	313
FTKS60FV1B .....	311
FTKS71FV1B .....	311
FTXG25EV1BW(S) .....	312
FTXG35EV1BW(S) .....	312
FTXS20G2V1B .....	311
FTXS25G2V1B .....	311
FTXS35G2V1B .....	311
FTXS42G2V1B .....	311
FTXS50G2V1B .....	311
FTXS60FV1B .....	311
FTXS71FV1B .....	311
FVXS25FV1B .....	313
FVXS35FV1B .....	313
FVXS50FV1B .....	313
wiring-error check .....	92

**Warning**



- Daikin Industries, Ltd.'s products are manufactured for export to numerous countries throughout the world. Daikin Industries, Ltd. does not have control over which products are exported to and used in a particular country. Prior to purchase, please therefore confirm with your local authorised importer, distributor and/or retailer whether this product conforms to the applicable standards, and is suitable for use, in the region where the product will be used. This statement does not purport to exclude, restrict or modify the application of any local legislation.
- Ask a qualified installer or contractor to install this product. Do not try to install the product yourself. Improper installation can result in water or refrigerant leakage, electrical shock, fire or explosion.
- Use only those parts and accessories supplied or specified by Daikin. Ask a qualified installer or contractor to install those parts and accessories. Use of unauthorised parts and accessories or improper installation of parts and accessories can result in water or refrigerant leakage, electrical shock, fire or explosion.
- Read the User's Manual carefully before using this product. The User's Manual provides important safety instructions and warnings. Be sure to follow these instructions and warnings.

If you have any enquiries, please contact your local importer, distributor and/or retailer.

### Cautions on product corrosion

1. Air conditioners should not be installed in areas where corrosive gases, such as acid gas or alkaline gas, are produced.
2. If the outdoor unit is to be installed close to the sea shore, direct exposure to the sea breeze should be avoided. If you need to install the outdoor unit close to the sea shore, contact your local distributor.



JMI-0107



JQA-1452

#### About ISO 9001

ISO 9001 is a plant certification system defined by the International Organization for Standardization (ISO) relating to quality assurance. ISO 9001 certification covers quality assurance aspects related to the "design, development, manufacture, installation, and supplementary service" of products manufactured at the plant.



EC99J2044

#### About ISO 14001

ISO 14001 is the standard defined by the International Organization for Standardization (ISO) relating to environmental management systems. Our group has been acknowledged by an internationally accredited compliance organisation as having an appropriate programme of environmental protection procedures and activities to meet the requirements of ISO 14001.

#### Dealer

#### **DAIKIN INDUSTRIES, LTD.**

Head Office:  
Umeda Center Bldg., 2-4-12, Nakazaki-Nishi,  
Kita-ku, Osaka, 530-8323 Japan

Tokyo Office:  
JR Shinagawa East Bldg., 2-18-1, Konan,  
Minato-ku, Tokyo, 108-0075 Japan

[http://www.daikin.com/global\\_ac/](http://www.daikin.com/global_ac/)

©All rights reserved